

TPS382x Voltage Monitor With Watchdog Timer

1 Features

- Power-on reset generator with a fixed delay time of 200ms (TPS3823, TPS3824, TPS3825, and TPS3828) or 25ms (TPS3820)
- Manual reset input (TPS3820, TPS3823, TPS3825, and TPS3828)
- Reset output available in active-low (TPS3820, TPS3823, TPS3824, and TPS3825), active-high (TPS3824 and TPS3825), and open drain (TPS3828)
- Supply voltage supervision range: 2.5V, 3V, 3.3V, 5V
- Watchdog timer (TPS3820, TPS3823, TPS3824, and TPS3828)
- Supply current of 15µA (typical)
- 5-pin SOT-23 package
- Temperature range: -40°C to 85°C (-40°C to 125°C for TPS3823A-33)

2 Applications

- [DSPs, microcontrollers, or microprocessors](#)
- [Industrial equipment](#)
- [Programmable controls](#)
- [Portable and battery-powered equipment](#)
- [Wireless communications systems](#)
- [Notebook and desktop computers](#)

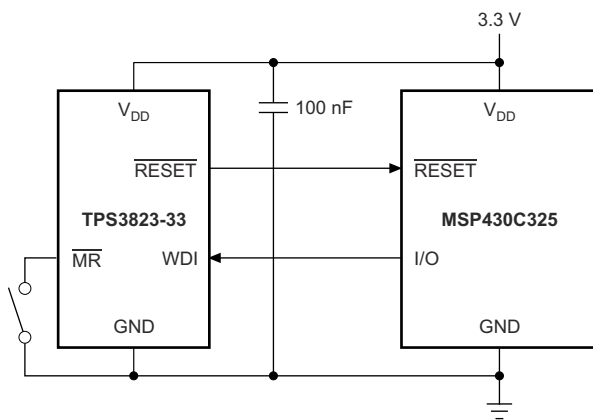

Typical Application Schematic

3 Description

The TPS382x family of supervisors provide circuit initialization and timing supervision, primarily for DSP and processor-based systems. During power on, $\overline{\text{RESET}}$ asserts when the supply voltage V_{DD} becomes greater than 1.1V. Thereafter, the supply voltage supervisor monitors V_{DD} and keeps $\overline{\text{RESET}}$ active low as long as V_{DD} remains less than the threshold voltage, $V_{\text{IT-}}$. An internal timer delays the return of the output to the inactive state (high) to make sure proper system reset. The delay time, t_{d} , starts after V_{DD} has risen above the threshold voltage ($V_{\text{IT-}} + V_{\text{HYS}}$). When the supply voltage drops below the threshold voltage $V_{\text{IT-}}$, the output becomes active (low) again. No external components are required. All the devices of this family have a fixed-sense threshold voltage, $V_{\text{IT-}}$, set by an internal voltage divider. The TPS382x family also offers watchdog time out options of 200ms (TPS3820) and 1.6s (TPS3823, TPS3824, and TPS3828).

PART NUMBER	PACKAGE ⁽¹⁾	BODY SIZE (NOM) ⁽²⁾
TPS382x	SOT-23 (5)	2.90mm × 1.60mm

- (1) For all available packages, see the orderable addendum at the end of the data sheet.
- (2) The package size (length × width) is a nominal value and includes pins, where applicable.

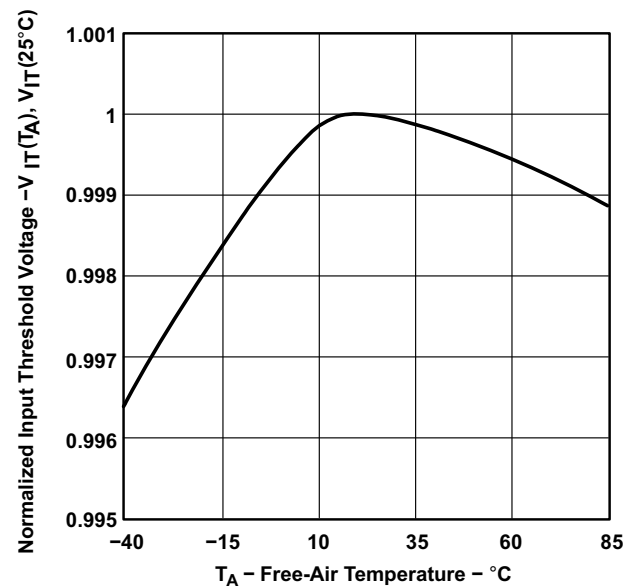

Normalized Input Threshold Voltage vs Free-Air Temperature



Table of Contents

1 Features	1	7.3 Feature Description.....	14
2 Applications	1	7.4 Device Functional Modes.....	15
3 Description	1	8 Application and Implementation	16
4 Device Comparison Table	3	8.1 Application Information.....	16
5 Pin Configuration and Functions	4	8.2 Typical Applications.....	16
6 Specifications	5	8.3 Power Supply Recommendations.....	18
6.1 Absolute Maximum Ratings.....	5	8.4 Layout.....	18
6.2 ESD Ratings.....	5	9 Device and Documentation Support	20
6.3 Recommended Operating Conditions.....	5	9.1 Device Support.....	20
6.4 Thermal Information.....	5	9.2 Documentation Support.....	20
6.5 Electrical Characteristics.....	6	9.3 Receiving Notification of Documentation Updates....	20
6.6 Electrical Characteristics for TPS3823A-33 only.....	7	9.4 Support Resources.....	20
6.7 Timing Requirements.....	8	9.5 Trademarks.....	21
6.8 Switching Characteristics.....	8	9.6 Electrostatic Discharge Caution.....	21
6.9 Timing Diagram.....	8	9.7 Glossary.....	21
6.10 Typical Characteristics.....	9	10 Revision History	21
7 Detailed Description	14	11 Mechanical, Packaging, and Orderable Information	22
7.1 Overview.....	14		
7.2 Functional Block Diagram.....	14		

4 Device Comparison Table

DEVICE	RESET	RESET	WDI	MR
TPS3820		Push-pull	X	X
TPS3823		Push-pull	X	X
TPS3823A		Push-pull	X	X
TPS3824	Push-pull	Push-pull	X	
TPS3825	Push-pull	Push-pull		X
TPS3828		Open-drain	X	X

5 Pin Configuration and Functions

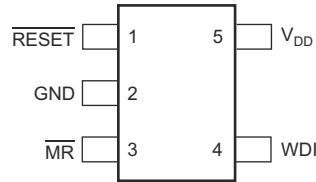

Figure 5-1. 5-Pin SOT-23 TPS3820, TPS3823, TPS3823A, TPS3828: DBV Package (Top View)

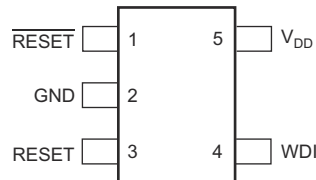

Figure 5-2. 5-Pin SOT-23 TPS3824: DBV Package (Top View)

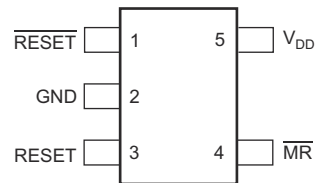

Figure 5-3. 5-Pin SOT-23 TPS3825: DBV Package (Top View)

Table 5-1. Pin Functions

NAME	PIN			I/O	DESCRIPTION
	TPS3820, TPS3823, TPS3823A, TPS3828	TPS3824	TPS3825		
GND	2	2	2	—	Ground connection
$\overline{\text{MR}}$	3	—	4	I	Manual-reset input. Pull low to force a reset. $\overline{\text{RESET}}$ remains low as long as $\overline{\text{MR}}$ is low and for the time-out period after $\overline{\text{MR}}$ goes high. Leave unconnected or connect to V_{DD} when unused.
RESET	—	3	3	O	Active-high reset output. Either push-pull or open-drain output stage.
$\overline{\text{RESET}}$	1	1	1	O	Active-low reset output. Either push-pull or open-drain output stage.
V_{DD}	5	5	5	I	Supply voltage. Powers the device and monitors the device voltage.
WDI	4	4	—	I	Watchdog timer input. If WDI remains high or low longer than the time-out period, then reset is triggered. The timer clears when reset is asserted or when WDI sees a falling edge. If left floating, the device generates pulses internally to prevent watchdog reset event. WDI must be driven low or high for watchdog error to assert output.

6 Specifications

6.1 Absolute Maximum Ratings

over operating free-air temperature range (unless otherwise noted)⁽¹⁾

		MIN	MAX	UNIT
Voltage	VDD	-0.3	6	V
	RESET, $\overline{\text{RESET}}$, $\overline{\text{MR}}$, WDI	-0.3	$V_{\text{DD}} + 0.3$	V
Current	Maximum low output, I_{OL}	-5	5	mA
	Maximum high output, I_{OH}	-5	5	mA
	Output range ($V_{\text{O}} < 0$ or $V_{\text{O}} > V_{\text{DD}}$), I_{OK}	-10	10	mA
Temperature	Operating free-air temperature, T_{A}	-40	85	°C
	Operating free-air temperature, T_{A} for TPS3823A-33 only	-40	125	°C
	Storage temperature range, T_{stg}	-65	150	°C

- (1) Stresses beyond those listed under Absolute Maximum Ratings may cause permanent damage to the device. These are stress ratings only, and functional operation of the device at these or any other conditions beyond those indicated under Recommended Operating Conditions is not implied. Exposure to absolute-maximum-rated conditions for extended periods can affect device reliability.

6.2 ESD Ratings

			VALUE	UNIT
$V_{\text{(ESD)}}$	Electrostatic discharge	Human-body model (HBM), per ANSI/ESDA/JEDEC JS-001 ⁽¹⁾	±2000	V
		Charged-device model (CDM), per JEDEC specification JESD22-C101 ⁽²⁾	±500	

- (1) JEDEC document JEP155 states that 500V HBM allows safe manufacturing with a standard ESD control process
(2) JEDEC document JEP157 states that 250V CDM allows safe manufacturing with a standard ESD control process.

6.3 Recommended Operating Conditions

over operating free-air temperature range (unless otherwise noted)

		MIN	NOM	MAX	UNIT
V_{DD}	Supply voltage	1.1		5.5	V
V_{IH}	High level input voltage at $\overline{\text{MR}}$ and WDI	$0.7 \times V_{\text{DD}}$			V
V_{IL}	Low level input voltage			$0.3 \times V_{\text{DD}}$	V
$\Delta t/\Delta V$	Input transition rise and fall rate at $\overline{\text{MR}}$ or WDI			100	ns/V
T_{A}	Operating free-air temperature range	-40		85	°C
T_{A}	Operating free-air temperature range for TPS3823A-33 only	-40		125	°C

6.4 Thermal Information

THERMAL METRIC ⁽¹⁾		TPS382x
		DBV (SOT-23)
		5 PINS
$R_{\theta\text{JA}}$	Junction-to-ambient thermal resistance	185
$R_{\theta\text{JC(top)}}$	Junction-to-case (top) thermal resistance	83.3
$R_{\theta\text{JB}}$	Junction-to-board thermal resistance	52.4
ψ_{JT}	Junction-to-top characterization parameter	20.4
ψ_{JB}	Junction-to-board characterization parameter	52.0
$R_{\theta\text{JC(bot)}}$	Junction-to-case (bottom) thermal resistance	n/a

- (1) For more information about traditional and new thermal metrics, see the [Semiconductor and IC Package Thermal Metrics](#) application report.

6.5 Electrical Characteristics

over operating temperature range –40°C to 85°C (unless otherwise noted).

PARAMETER		TEST CONDITIONS		MIN	NOM	MAX	UNIT
V _{OH}	High-level output voltage	RESET	TPS382x-25	V _{DD} = V _{ITL} + 0.2V, I _{OH} = –20μA	0.8 × V _{DD}	V _{DD} – 1.5V	V
			TPS382x-30				
			TPS382x-33				
			TPS382xA-33				
			TPS382x-50				
		RESET	TPS3824-25 TPS3825-25	V _{DD} ≥ 1.8V, I _{OH} = –100μA	0.8 × V _{DD}		
			TPS3824-30 TPS3825-30				
			TPS3824-33 TPS3825-33				
			TPS3824-50 TPS3825-50				
			TPS3824-50 TPS3825-50				
V _{OL}	Low-level output voltage	RESET	TPS3824-25 TPS3825-25	V _{DD} = V _{ITL} + 0.2V, I _{OL} = 1mA	0.4	V	
			TPS3824-30 TPS3825-30				
			TPS3824-33 TPS3825-33				
			TPS3824-50 TPS3825-50				
			TPS3824-50 TPS3825-50				
		RESET	TPS382x-25	V _{DD} = V _{ITL} – 0.2V, I _{OL} = 1mA	0.4		
			TPS382x-30				
			TPS382x-33 TPS382xA-33				
			TPS382x-50				
			TPS382x-50				
V _{POR}	Power-up reset voltage ⁽¹⁾		V _{OL(max)} = 0.4V, I _{OL(Sink)} = 20μA			0.9	V
V _{ITL}	Negative-going input threshold voltage ⁽²⁾	TPS382x-25 TPS382x-30 TPS382x-33 TPS382xA-33	T _A = 0°C to 85°C	2.21	2.25	2.30	V
				2.59	2.63	2.69	
				2.88	2.93	3.00	
				4.49	4.55	4.64	
		TPS382x-25 TPS382x-30 TPS382x-33 TPS382xA-33	T _A = –40°C to 85°C	2.20	2.25	2.30	
				2.57	2.63	2.69	
				2.86	2.93	3.00	
				4.46	4.55	4.64	
V _{HYS}	Hysteresis at V _{DD} input	TPS382x-25					mV
		TPS382x-30			30		
		TPS382x-33 TPS382xA-33					
		TPS382x-50			50		
I _{IH(AV)}	Average high-level input current	WDI	WDI = V _{DD} , time average (DC = 88%)		120		μA
I _{IL(AV)}	Average low-level input current			WDI = 0.3V, V _{DD} = 5.5V, time average (DC = 12%)		–15	
I _{IH}	High-level input current	WDI	WDI = V _{DD}		140	190	μA
		MR	MR = 0.7 × V _{DD} , V _{DD} = 5.5V		–40	–60	
I _{IL}	Low-level input current	WDI	WDI = 0.3V, V _{DD} = 5.5V		140	190	μA
		MR	MR = 0.3V, V _{DD} = 5.5V		–110	–160	

6.5 Electrical Characteristics (continued)

over operating temperature range -40°C to 85°C (unless otherwise noted).

PARAMETER			TEST CONDITIONS	MIN	NOM	MAX	UNIT
I_{OS}	Output short-circuit current ⁽³⁾	$\overline{\text{RESET}}$	TPS382x-25	$V_{DD} = V_{IT-,max} + 0.2\text{V}$, $V_O = 0\text{V}$		-400	μA
			TPS382x-30				
			TPS382x-33 TPS382xA-33				
			TPS382x-50				
I_{DD}	Supply current		WDI, $\overline{\text{MR}}$ and outputs unconnected		15	25	μA
R_{MR}	Internal pullup resistor at $\overline{\text{MR}}$				90		$\text{k}\Omega$
C_i	Input capacitance at $\overline{\text{MR}}$, WDI		$V_i = 0\text{V}$ to 5.5V		5		pF

- (1) The lowest supply voltage at which $\overline{\text{RESET}}$ becomes active. t_r , $V_{DD} \geq 15\mu\text{s/V}$.
- (2) To make sure best stability of the threshold voltage, place a bypass capacitor (ceramic, $0.1\mu\text{F}$) near the supply terminal.
- (3) The $\overline{\text{RESET}}$ short-circuit current is the maximum pullup current when $\overline{\text{RESET}}$ is driven low by a microprocessor bidirectional reset pin.

6.6 Electrical Characteristics for TPS3823A-33 only

over operating temperature range -40°C to 125°C (unless otherwise noted).

PARAMETER			TEST CONDITIONS	MIN	NOM	MAX	UNIT
V_{OH}	High-level output voltage	$\overline{\text{RESET}}$	$V_{DD} = V_{IT-} + 0.2\text{V}$, $I_{OH} = -30\mu\text{A}$	$0.8 \times V_{DD}$			V
V_{OL}	Low-level output voltage	$\overline{\text{RESET}}$	$V_{DD} = V_{IT-} - 0.2\text{V}$, $I_{OL} = 1.2\text{mA}$			0.45	V
V_{POR}	Power-up reset voltage ⁽¹⁾		$V_{OL(max)} = 0.4\text{V}$, $I_{OL(Sink)} = 20\mu\text{A}$			0.9	V
V_{IT-}	Negative-going input threshold voltage ⁽²⁾			2.83	2.93	3.00	V
V_{HYS}	Hysteresis at V_{DD} input				30		mV
$I_{IH(AV)}$	Average high-level input current	WDI	WDI = V_{DD} , time average (DC = 88%)		120		μA
$I_{IL(AV)}$	Average low-level input current		WDI = 0.3V , $V_{DD} = 5.5\text{V}$, time average (DC = 12%)		-15		
I_{IH}	High-level input current	WDI	WDI = V_{DD}		140	190	μA
		$\overline{\text{MR}}$	$\overline{\text{MR}} = 0.7 \times V_{DD}$, $V_{DD} = 5.5\text{V}$		-40	-60	
I_{IL}	Low-level input current	WDI	WDI = 0.3V , $V_{DD} = 5.5\text{V}$		140	190	μA
		$\overline{\text{MR}}$	$\overline{\text{MR}} = 0.3\text{V}$, $V_{DD} = 5.5\text{V}$		-110	-160	
I_{OS}	Output short-circuit current ⁽³⁾	$\overline{\text{RESET}}$	$V_{DD} = V_{IT-,max} + 0.2\text{V}$, $V_O = 0\text{V}$			-400	μA
I_{DD}	Supply current		WDI, $\overline{\text{MR}}$ and outputs unconnected		15	25	μA
R_{MR}	Internal pullup resistor at $\overline{\text{MR}}$				90		$\text{k}\Omega$
C_i	Input capacitance at $\overline{\text{MR}}$, WDI		$V_i = 0\text{V}$ to 5.5V		5		pF

- (1) The lowest supply voltage at which $\overline{\text{RESET}}$ becomes active. t_r , $V_{DD} \geq 15\mu\text{s/V}$.
- (2) To make sure best stability of the threshold voltage, place a bypass capacitor (ceramic, $0.1\mu\text{F}$) near the supply terminal.
- (3) The $\overline{\text{RESET}}$ short-circuit current is the maximum pullup current when $\overline{\text{RESET}}$ is driven low by a microprocessor bidirectional reset pin.

6.7 Timing Requirements

at $R_L = 1\text{M}\Omega$, $C_L = 50\text{pF}$ and $T_A = 25^\circ\text{C}$, unless otherwise noted.

PARAMETER		TEST CONDITIONS	MIN	NOM	MAX	UNIT	
t_W	Pulse width	At V_{DD}	$V_{DD} = V_{IT-} + 0.2\text{V}$, $V_{DD} = V_{IT-} - 0.2\text{V}$			6	μs
		At $\overline{\text{MR}}$	$V_{DD} \geq V_{IT-} + 0.2\text{V}$, $V_{IL} = 0.3 \times V_{DD}$, $V_{IH} = 0.7 \times V_{DD}$			1	μs
		At WDI				100	ns

6.8 Switching Characteristics

at $R_L = 1\text{M}\Omega$, $C_L = 50\text{pF}$ and $T_A = 25^\circ\text{C}$, unless otherwise noted.

PARAMETER		TEST CONDITIONS	MIN	NOM	MAX	UNIT	
t_{out}	Watchdog time out	TPS3820	$V_{DD} \geq V_{IT-} + 0.2\text{V}$, See timing diagram			112	ms
		TPS3823/4/8, TPS3823A	0.9	1.6	2.5	s	
t_d	Delay time	TPS3820	$V_{DD} \geq V_{IT-} + 0.2\text{V}$, See timing diagram			15	ms
		TPS3823/4/5/8, TPS3823A	120	200	300	ms	
t_{PHL}	Propagation delay time, high-to-low output	$\overline{\text{MR}}$ to RESET delay (TPS3820/3/5/8, TPS3823A)	$V_{DD} \geq V_{IT-} + 0.2\text{V}$, $V_{IL} = 0.3 \times V_{DD}$, $V_{IH} = 0.7 \times V_{DD}$			0.1	μs
		V_{DD} to RESET delay	$V_{IL} = V_{IT-} - 0.2\text{V}$, $V_{IH} = V_{IT-} + 0.2\text{V}$			25	μs
t_{PLH}	Propagation delay time, low-to-high output	$\overline{\text{MR}}$ to RESET delay (TPS3824/5)	$V_{DD} \geq V_{IT-} + 0.2\text{V}$, $V_{IL} = 0.3 \times V_{DD}$, $V_{IH} = 0.7 \times V_{DD}$			0.1	μs
		V_{DD} to RESET delay (TPS3824/5)	$V_{IL} = V_{IT-} - 0.2\text{V}$, $V_{IH} = V_{IT-} + 0.2\text{V}$			25	μs

6.9 Timing Diagram

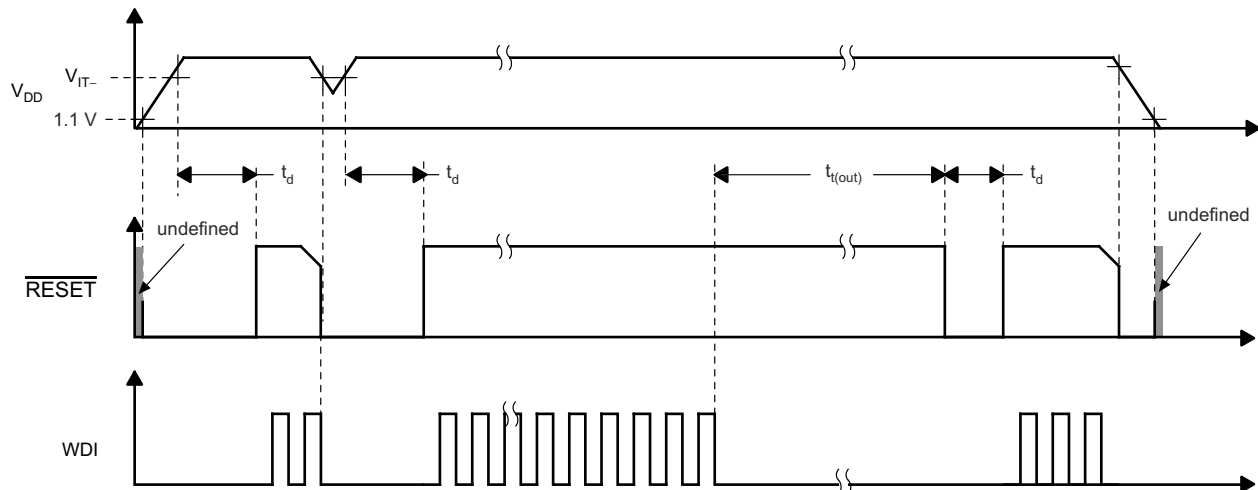

Figure 6-1. Timing Diagram

6.10 Typical Characteristics

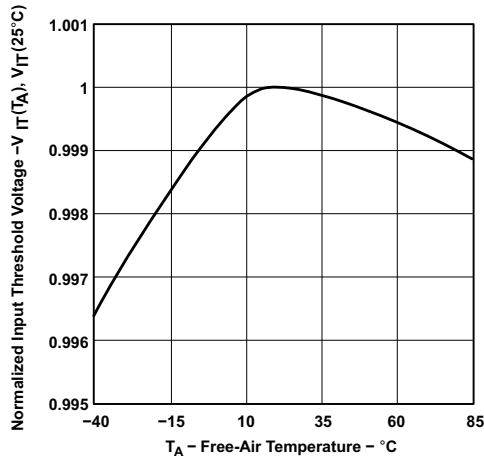

Figure 6-2. Normalized Input Threshold Voltage vs Free-Air Temperature at V_{DD}

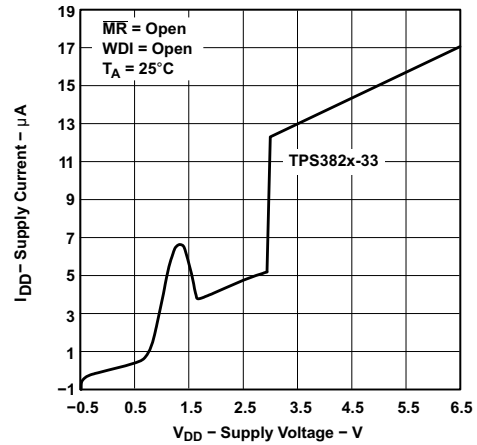

Figure 6-3. Supply Current vs Supply Voltage

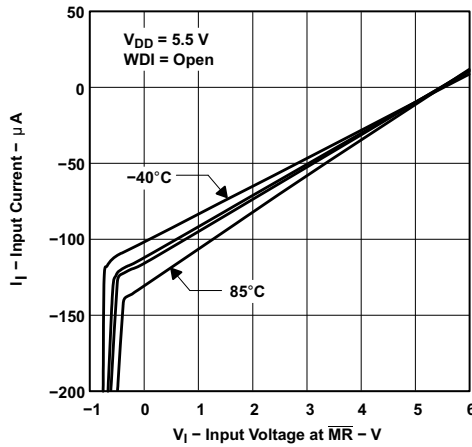

Figure 6-4. Input Current vs Input Voltage at \overline{MR}

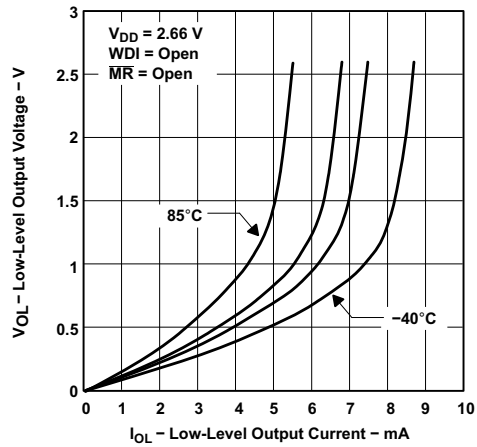

Figure 6-5. Low-Level Output Voltage vs Low-Level Output Current

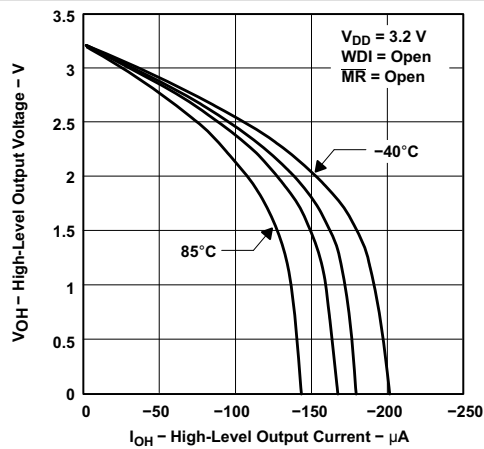

Figure 6-6. High-Level Output Voltage vs High-Level Output Current

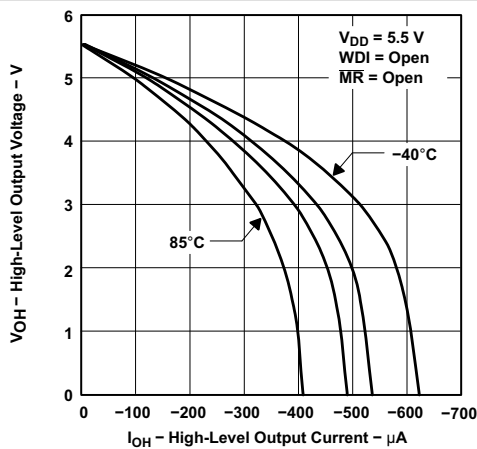

Figure 6-7. High-Level Output Voltage vs High-Level Output Current



Figure 6-8. Minimum Pulse Duration at V_{DD} vs V_{DD} Threshold Overdrive

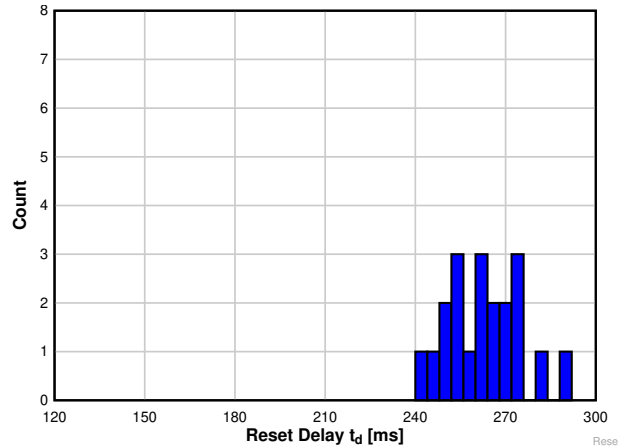

Figure 6-9. Reset Delay Histogram for TPS3823A-33 Devices at -40°C (Unit Count = 20)

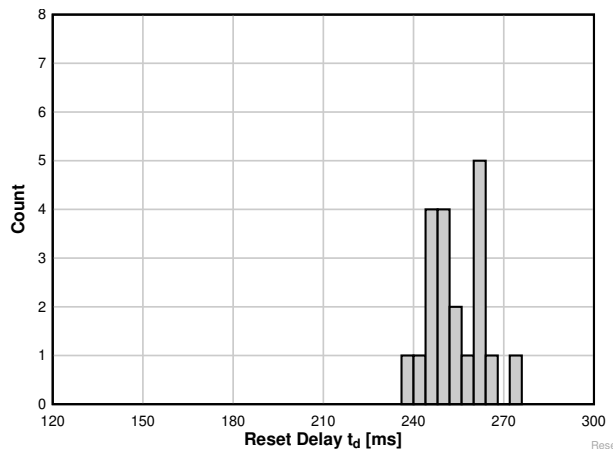

Figure 6-10. Reset Delay Histogram for TPS3823A-33 Devices at 25°C (Unit Count = 20)

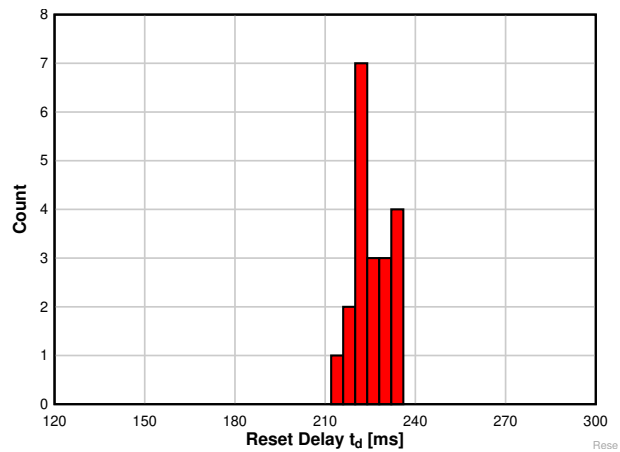

Figure 6-11. Reset Delay Histogram for TPS3823A-33 Devices at 125°C (Unit Count = 20)

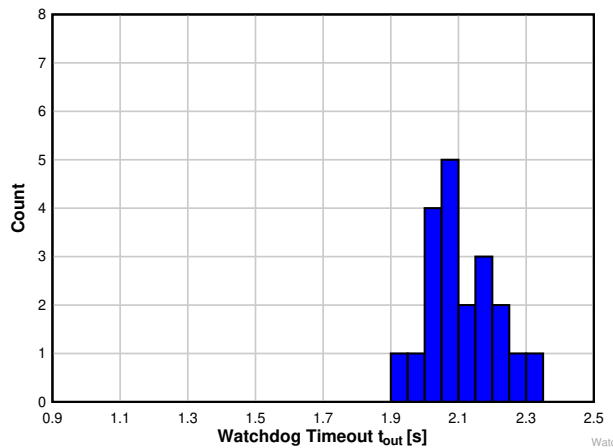

Figure 6-12. Watchdog Timeout Histogram for TPS3823A-33 Devices at -40°C (Unit Count = 20)

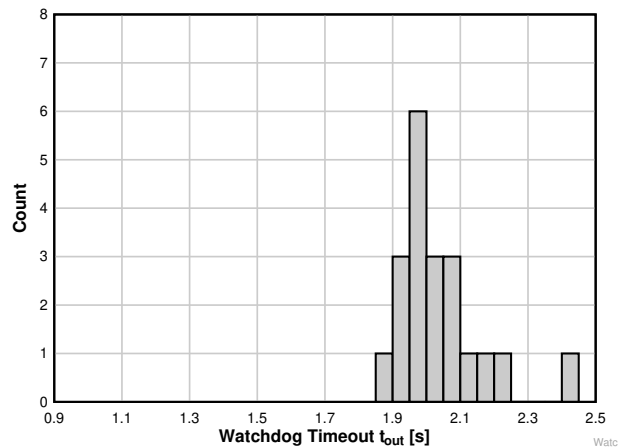

Figure 6-13. Watchdog Timeout Histogram for TPS3823A-33 Devices at 25°C (Unit Count = 20)

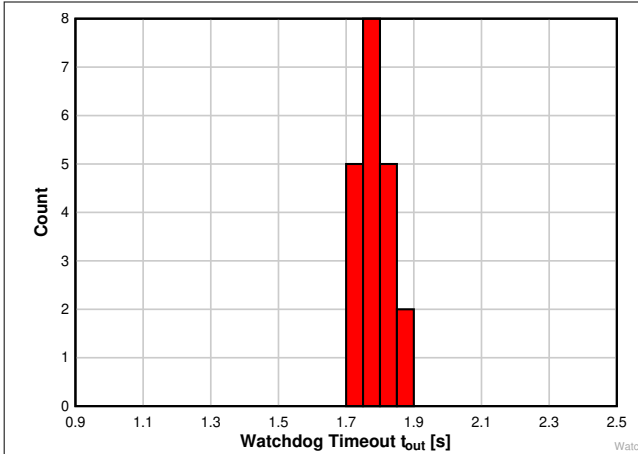

Figure 6-14. Watchdog Timeout Histogram for TPS3823A-33 Devices at 125°C (Unit Count = 20)

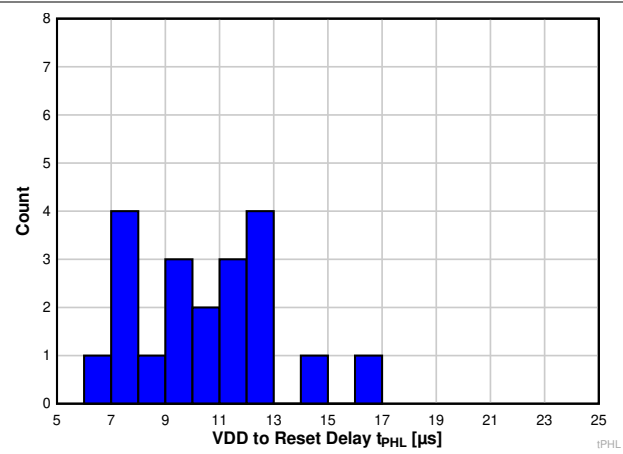

Figure 6-15. VDD to Reset Delay Histogram for TPS3823A-33 Devices at -40°C (Unit Count = 20)

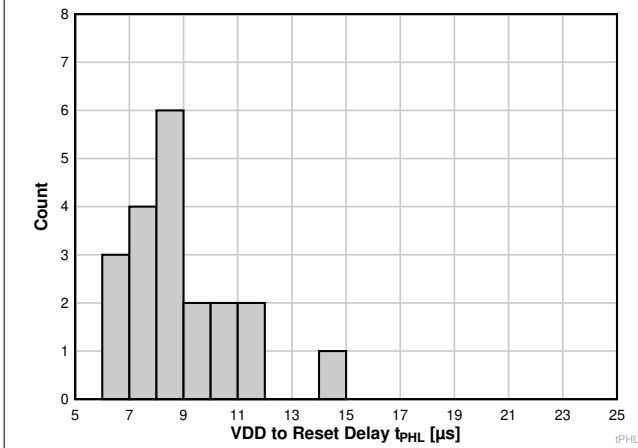

Figure 6-16. VDD to Reset Delay Histogram for TPS3823A-33 Devices at 25°C (Unit Count = 20)

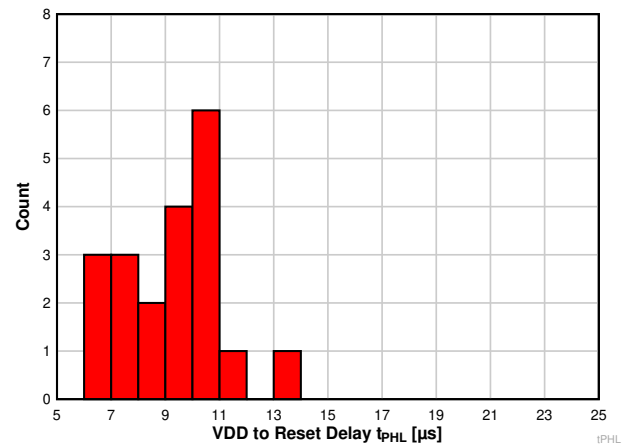

Figure 6-17. VDD to Reset Delay Histogram for TPS3823A-33 Devices at 125°C (Unit Count = 20)

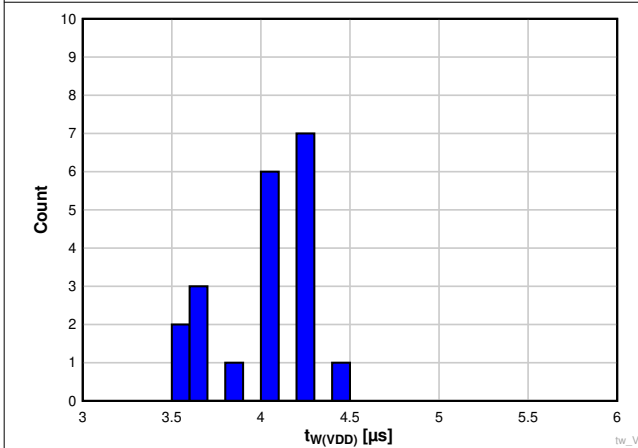

Figure 6-18. VDD Pulse Width Histogram for TPS3823A-33 Devices at -40°C (Unit Count = 20)

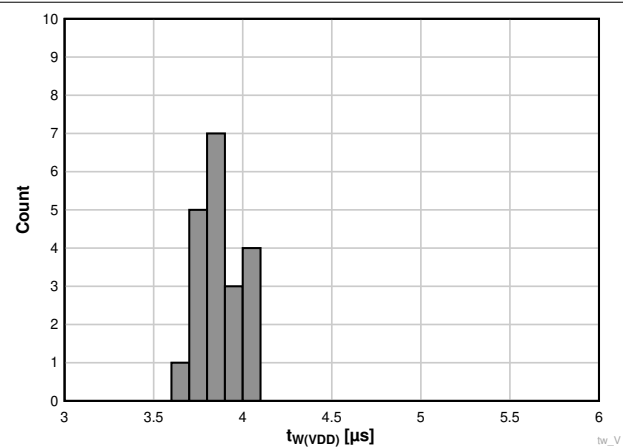

Figure 6-19. VDD Pulse Width Histogram for TPS3823A-33 Devices at 25°C (Unit Count = 20)

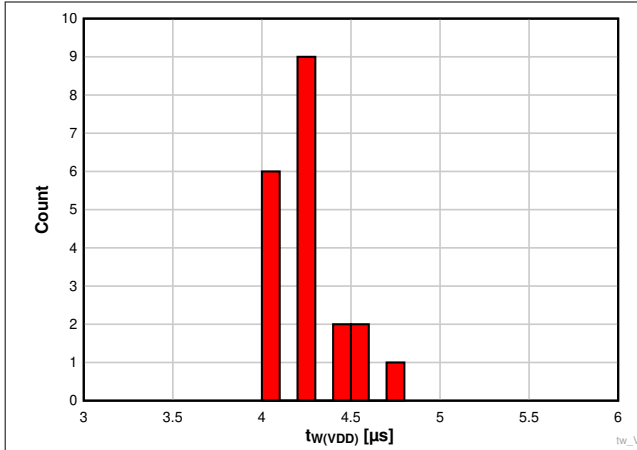

Figure 6-20. VDD Pulse Width Histogram for TPS3823A-33 Devices at 125°C (Unit Count = 20)

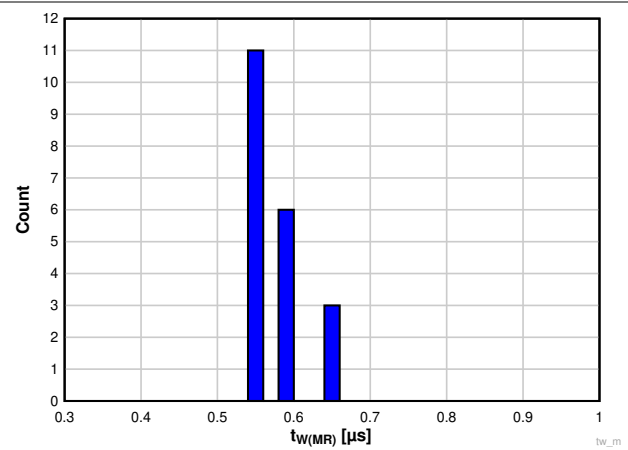

Figure 6-21. Manual Reset Pulse Width Histogram for TPS3823A-33 Devices at -40°C (Unit Count = 20)

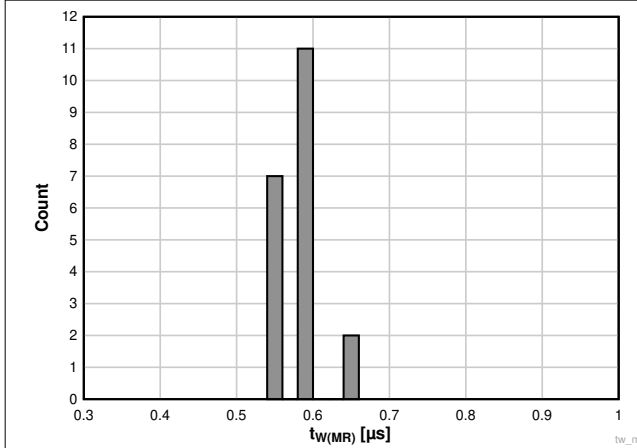

Figure 6-22. Manual Reset Pulse Width Histogram for TPS3823A-33 Devices at 25°C (Unit Count = 20)

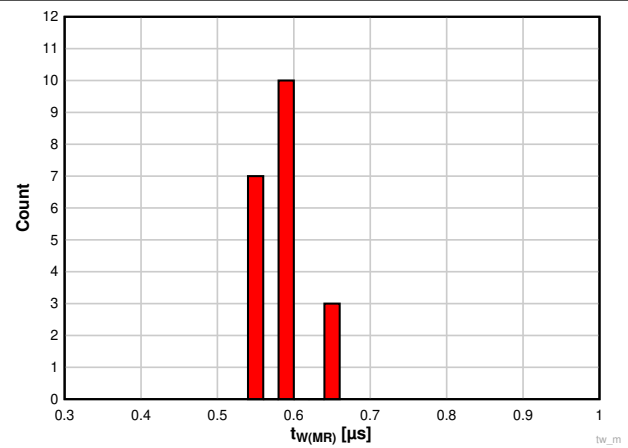

Figure 6-23. Manual Reset Pulse Width Histogram for TPS3823A-33 Devices at 125°C (Unit Count = 20)

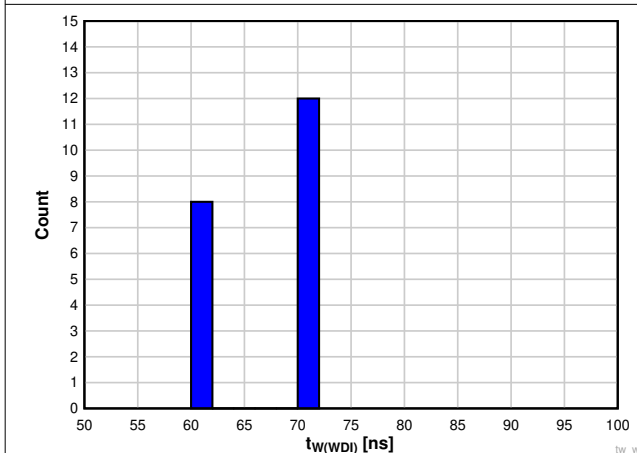

Figure 6-24. WDI Pulse Width Histogram for TPS3823A-33 Devices at -40°C (Unit Count = 20)

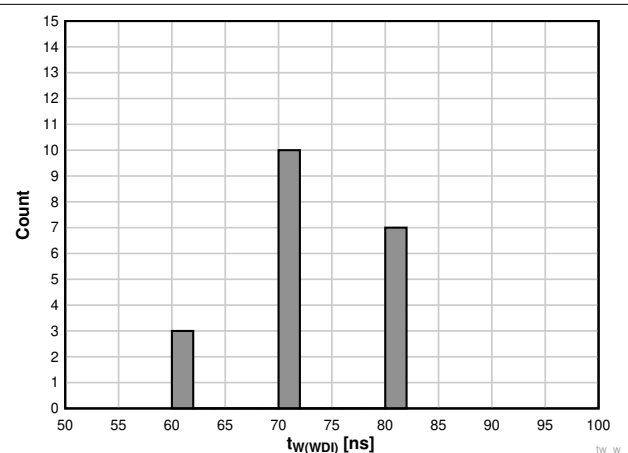

Figure 6-25. WDI Pulse Width Histogram for TPS3823A-33 Devices at 25°C (Unit Count = 20)

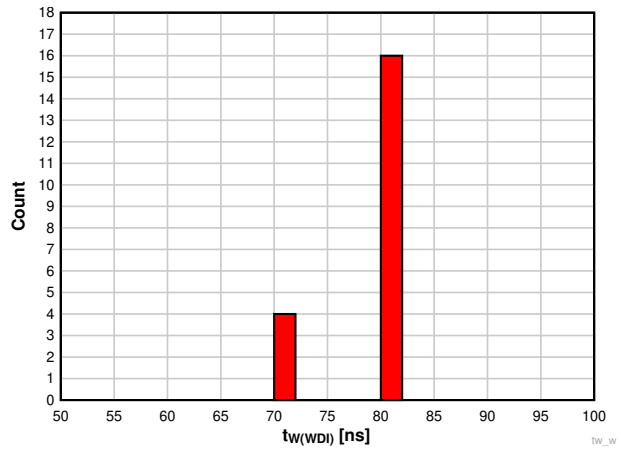

Figure 6-26. WDI Pulse Width Histogram for TPS3823A-33 Devices at 125°C (Unit Count = 20)

7 Detailed Description

7.1 Overview

The TPS382x family of supervisors provide circuit initialization and timing supervision. Optional configurations include devices with active-high and active-low output signals (TPS3824/5), devices with a watchdog timer (TPS3820/3/4/8), and devices with manual reset (\overline{MR}) pins (TPS3820/3/5/8). \overline{RESET} asserts when the supply voltage, V_{DD} , rises above 1.1V. For devices with active-low output logic, the device monitors V_{DD} and keeps \overline{RESET} low as long as V_{DD} remains below the negative threshold voltage, V_{IT-} . For devices with active-high output logic, $RESET$ remains high as long as V_{DD} remains below V_{IT-} . An internal timer delays the return of the output to the inactive state (high) to make sure proper system reset. The delay time, t_d , starts after V_{DD} rises above the positive threshold voltage ($V_{IT-} + V_{HYS}$). When the supply voltage drops below V_{IT-} , the output becomes active (low) again. All the devices of this family have a fixed-sense threshold voltage, V_{IT-} , set by an internal voltage divider, so no external components are required.

The TPS382x family is designed to monitor supply voltages of 2.5V, 3V, 3.3V, and 5V. The devices are available in a 5-pin SOT-23 package and are characterized for operation over a temperature range of -40°C to 85°C . Only TPS3823A-33 is characterized for operation over a temperature range -40°C to 125°C .

7.2 Functional Block Diagram

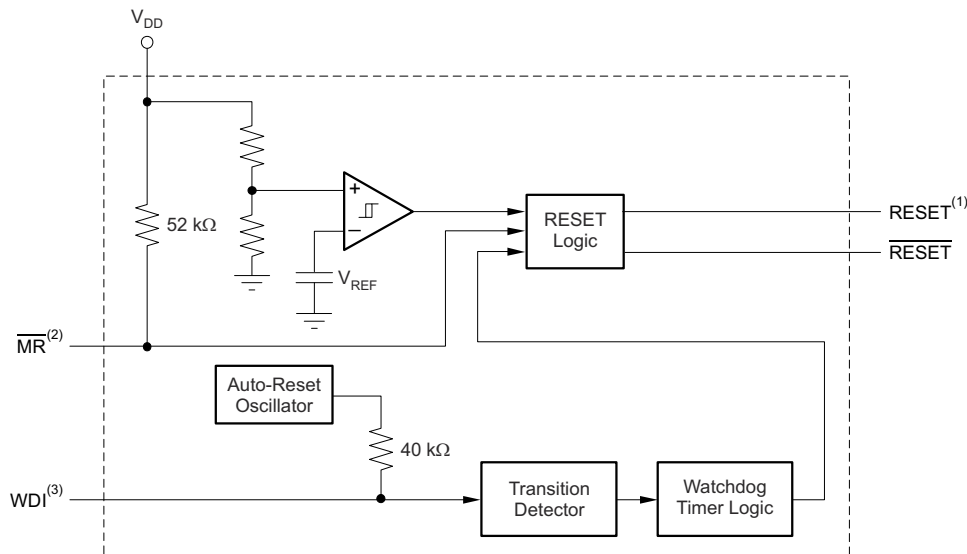

- A. TPS3824/5
- B. TPS3820/3/5/8
- C. TPS3820/3/4/8

7.3 Feature Description

7.3.1 Manual Reset (\overline{MR})

The \overline{MR} input allows an external logic signal from processors, logic circuits, and/or discrete sensors to force a reset signal regardless of V_{DD} with respect to V_{IT-} or the state of the watchdog timer. A low level at \overline{MR} causes the reset signals to become active.

7.3.2 Active-High or Active-Low Output

All TPS382x devices have an active-low logic output (\overline{RESETE}), while the TPS3824/5 devices also include an active-high logic output ($RESET$).

7.3.3 Push-Pull or Open-Drain Output

All TPS382x devices, except for TPS3828, have push-pull outputs. TPS3828 devices have an open-drain output.

7.3.4 Watchdog Timer (WDI)

The TPS3820, TPS3823, TPS3824, and TPS3828 devices have a watchdog timer that must be periodically triggered by negative transition at WDI to avoid a reset signal being issued. When the supervising system fails to retrigger the watchdog circuit within the time-out interval, t_{out} , $\overline{\text{RESET}}$ becomes active for the time period t_d . This event also reinitializes the watchdog timer.

The watchdog timer can be disabled by disconnecting the WDI pin from the system. If the WDI pin detects a high-impedance state, the TPS3820, TPS3823, TPS3824, or TPS3828 generates internal WDI pulse to make sure that $\overline{\text{RESET}}$ does not assert. If this behavior is not desired, place a 1k Ω resistor from WDI to ground. This resistor makes sure that the TPS3820, TPS3823, TPS3824, or TPS3828 detects that WDI is not in a high-impedance state.

In applications where the input to the WDI pin is active (transitioning high and low) and the TPS3820, TPS3823, TPS3824, or TPS3828 is asserting $\overline{\text{RESET}}$, $\overline{\text{RESET}}$ is stuck at a logic low after the input voltage returns above V_{IT-} . If the application requires that input to WDI be active when the reset signal is asserted, then either the **A** version of the device or a FET can be used to decouple the WDI signal. The **A** version does not latch the reset signal to the asserted state if a WDI pulse is received while $\overline{\text{RESET}}$ is asserted. An external FET decouples the WDI signal by disconnecting the WDI input when $\overline{\text{RESET}}$ is asserted. For more details on this, see [Decoupling WDI During Reset Event](#). The **A** version operates with or without the FET present in the system. Therefore, the **A** version is backwards-compatible with the non-**A** versions.

7.4 Device Functional Modes

Table 7-1 lists the functional modes of the TPS382x devices.

Table 7-1. Function Table

INPUTS		OUTPUTS	
$\overline{\text{MR}}$ ⁽¹⁾	$V_{DD} > V_{IT}$	$\overline{\text{RESET}}$	$\overline{\text{RESET}}$ ⁽²⁾
L	0	L	H
L	1	L	H
H	0	L	H
H	1	H	L

(1) TPS3820/3/5/8

(2) TPS3824/5

8 Application and Implementation

Note

Information in the following applications sections is not part of the TI component specification, and TI does not warrant its accuracy or completeness. TI's customers are responsible for determining suitability of components for their purposes, as well as validating and testing their design implementation to confirm system functionality.

8.1 Application Information

The TPS382x family of devices are very small supervisory circuits that monitor fixed supply voltages of 2.5V, 3V, 3.3V, and 5V. The TPS382x family operates from 1.1V to 5.5V. Orderable options include versions with either push-pull or open-drain outputs, versions that use active-high or active-low logic for output signals, versions with a manual reset pin, and versions with a watchdog timer. See the [Device Comparison Table](#) for an overview of device options.

8.2 Typical Applications

8.2.1 Supply Rail Monitoring With Watchdog Time-Out and 200ms Delay

The TPS3823A can be used to monitor the supply rail for devices such as microcontrollers. The downstream device is enabled by the TPS3823A once the voltage on the supply pin (V_{DD}) is above the internal threshold voltage ($V_{IT-} + V_{HYS}$). The downstream device is disabled by the TPS3823A when V_{DD} falls below the threshold voltage minus the hysteresis voltage (V_{IT-}). The TPS3823A also issues a reset signal if the WDI input is not periodically triggered by a positive or negative transition at WDI. When the supervising system fails to retrigger the watchdog circuit within the time-out interval, t_{out} , \overline{RESET} becomes active for the time period t_d .

Some applications require a shorter reset signal than the 200ms that most of the TPS382x family provide. In these cases, the TPS3820 is a good choice because the device has a delay time of only 25ms. If an open-drain output is required, replace the TPS3823A with the TPS3828 (if the WDI input must be active while \overline{RESET} is low, see [Decoupling WDI During Reset Event](#)). [Figure 8-1](#) shows the TPS3823A in a typical application.

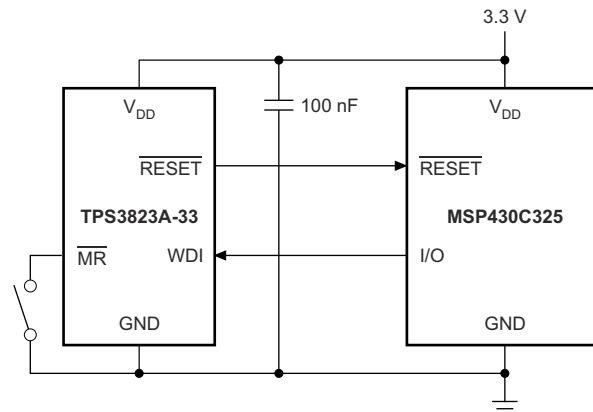

Figure 8-1. Supply Rail Monitoring With Watchdog Time-Out

8.2.1.1 Design Requirements

The TPS3823A must drive the enable pin of a MSP430C325 using a logic-high signal to signify that the supply voltage is above the minimum operating voltage of the device and monitor the I/O pin to determine if the microcontroller is operating correctly.

8.2.1.2 Detailed Design Procedure

Determine which version of the TPS382x family best fits the functional performance required.

If the input supply is noisy, include an input capacitor to help avoid unwanted changes to the reset signal.

8.2.1.3 Application Curve

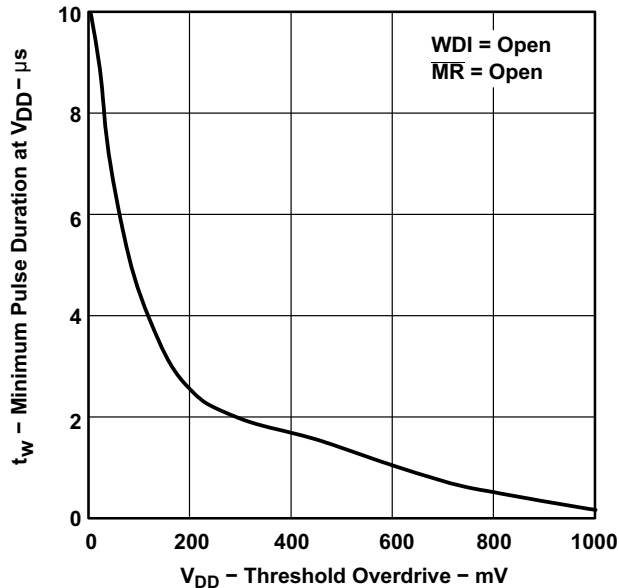

Figure 8-2. Minimum Pulse Duration at V_{DD} vs V_{DD} Threshold Overdrive

8.2.2 Decoupling WDI During Reset Event

If the application requires that the input to WDI is active when the reset signal is asserted and the **A** version of the device cannot be used, Figure 8-3 shows how to decouple WDI from the active signal using an N-channel FET. The N-channel FET is placed in series with the WDI pin, with the gate of the FET connected to the RESET output.

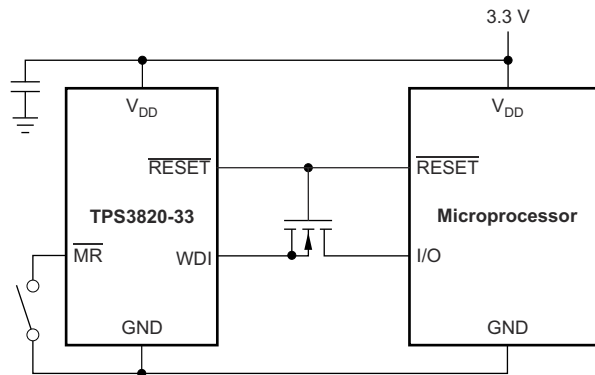

Figure 8-3. WDI Example

8.2.2.1 Design Requirements

The TPS3820 must drive the enable pin of a microprocessor using a logic-high signal to signify that the supply voltage is above the minimum operating voltage of the device and monitor the I/O pin to determine if the microcontroller is operating correctly. The reset signal delay time must be greater than 10ms but less than 50ms to achieve the desired behavior.

8.2.2.2 Detailed Design Procedure

Determine which version of the TPS3820 is best suited for monitoring the supply voltage.

If the input supply is noisy, include an input capacitor to help avoid unwanted changes to the reset signal.

8.2.2.3 Application Curve

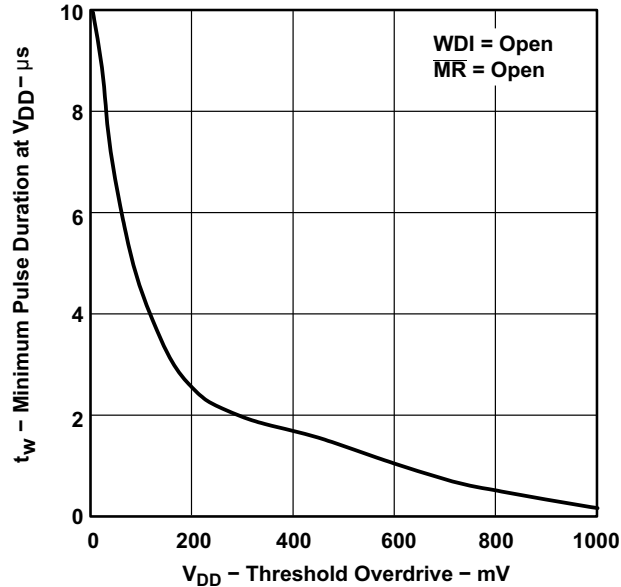

Figure 8-4. Minimum Pulse Duration at V_{DD} vs V_{DD} Threshold Overdrive

8.3 Power Supply Recommendations

These devices are designed to operate from an input supply with a voltage range from 1.1V to 5.5V. Though not required, good analog design practice is to place a 0.1μF ceramic capacitor close to the V_{DD} pin if the input supply is noisy.

8.4 Layout

8.4.1 Layout Guidelines

Follow these guidelines to lay out the printed-circuit board (PCB) that is used for the TPS382x family of devices.

- Place the V_{DD} decoupling capacitor (C_{VDD}) close to the device.
- Avoid using long traces for the V_{DD} supply node. The V_{DD} capacitor (C_{VDD}), along with parasitic inductance from the supply to the capacitor, can form an LC tank and create ringing with peak voltages above the maximum V_{DD} voltage.

8.4.2 Layout Example

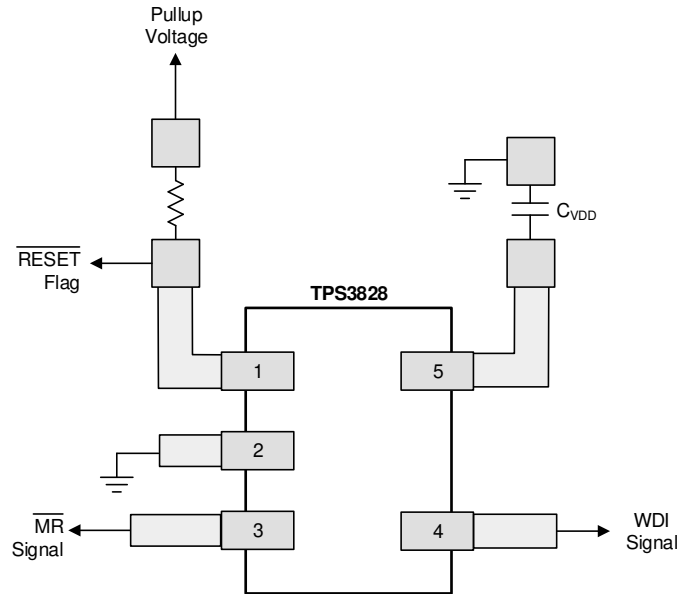

Figure 8-5. Example Layout (DBV Package)

9 Device and Documentation Support

9.1 Device Support

9.1.1 Development Support

9.1.1.1 Spice Models

Computer simulation of circuit performance using SPICE is often useful when analyzing the performance of analog circuits and systems. A SPICE model for the TPS382x is available through the product folders under *Tools & Software*.

9.1.2 Device Nomenclature

Table 9-1. Ordering Information

ORDERABLE DEVICE NAME ^{(1) (2) (3)}		THRESHOLD VOLTAGE ⁽⁴⁾	MARKING
TPS3820-33DBVT	TPS3820-33DBVR	2.93V	PDEI
TPS3820-50DBVT	TPS3820-50DBVR	4.55V	PDDI
TPS3823-25DBVT	TPS3823-25DBVR	2.25V	PAPI
TPS3823-30DBVT	TPS3823-30DBVR	2.63V	PAQI
TPS3823-33DBVT	TPS3823-33DBVR	2.93V	PARI
TPS3823-50DBVT	TPS3823-50DBVR	4.55V	PASI
TPS3824-25DBVT	TPS3824-25DBVR	2.25V	PATI
TPS3824-30DBVT	TPS3824-30DBVR	2.63V	PAUI
TPS3824-33DBVT	TPS3824-33DBVR	2.93V	PAVI
TPS3824-50DBVT	TPS3824-50DBVR	4.55V	PAWI
TPS3825-33DBVT	TPS3825-33DBVR	2.93V	PDGI
TPS3825-50DBVT	TPS3825-50DBVR	4.55V	PDFI
TPS3828-33DBVT	TPS3828-33DBVR	2.93V	PDII
TPS3828-50DBVT	TPS3828-50DBVR	4.55V	PDHI
TPS3823A-33DBVT	TPS3823A-33DBVR	2.93V	PYPI

- (1) For the most current package and ordering information see the Package Option Addendum at the end of this document, or see the TI website at www.ti.com.
- (2) The DBVT package indicates tape and reel of 250 parts.
- (3) The DBVR package indicates tape and reel of 3000 parts.
- (4) For other threshold voltage versions, contact the local TI sales office.

9.2 Documentation Support

9.2.1 Related Documentation

For related documentation, see the following: [Disabling the Watchdog Timer for TI's Family of Supervisors \(SLVA145\)](#)

9.3 Receiving Notification of Documentation Updates

To receive notification of documentation updates, navigate to the device product folder on ti.com. Click on *Notifications* to register and receive a weekly digest of any product information that has changed. For change details, review the revision history included in any revised document.

9.4 Support Resources

[TI E2E™ support forums](#) are an engineer's go-to source for fast, verified answers and design help — straight from the experts. Search existing answers or ask your own question to get the quick design help you need.

Linked content is provided "AS IS" by the respective contributors. They do not constitute TI specifications and do not necessarily reflect TI's views; see TI's [Terms of Use](#).

9.5 Trademarks

TI E2E™ is a trademark of Texas Instruments.

All trademarks are the property of their respective owners.

9.6 Electrostatic Discharge Caution



This integrated circuit can be damaged by ESD. Texas Instruments recommends that all integrated circuits be handled with appropriate precautions. Failure to observe proper handling and installation procedures can cause damage.

ESD damage can range from subtle performance degradation to complete device failure. Precision integrated circuits may be more susceptible to damage because very small parametric changes could cause the device not to meet its published specifications.

9.7 Glossary

[TI Glossary](#) This glossary lists and explains terms, acronyms, and definitions.

10 Revision History

NOTE: Page numbers for previous revisions may differ from page numbers in the current version.

Changes from Revision N (July 2022) to Revision O (March 2025) Page

• Updated thermal parameters.....	5
• Clarify VPOR test condition.....	6
• Updated MR resistance typical value.....	6
• Clarify VPOR test description.....	7
• Updated MR resistance typical value.....	7

Changes from Revision M (July 2020) to Revision N (July 2022) Page

• Updated the numbering format for tables, figures, and cross-references throughout the document.....	1
---	---

Changes from Revision L (January 2018) to Revision M (July 2020) Page

• Added new typical performance curves Figure 6-9 through Figure 6-26	9
---	---

11 Mechanical, Packaging, and Orderable Information

The following pages include mechanical, packaging, and orderable information. This information is the most current data available for the designated devices. This data is subject to change without notice and revision of this document. For browser-based versions of this data sheet, refer to the left-hand navigation.

PACKAGING INFORMATION

Orderable part number	Status (1)	Material type (2)	Package Pins	Package qty Carrier	RoHS (3)	Lead finish/ Ball material (4)	MSL rating/ Peak reflow (5)	Op temp (°C)	Part marking (6)
TPS3820-33DBVR	Active	Production	SOT-23 (DBV) 5	3000 LARGE T&R	Yes	NIPDAU	Level-1-260C-UNLIM	-40 to 85	PDEI
TPS3820-33DBVR.A	Active	Production	SOT-23 (DBV) 5	3000 LARGE T&R	Yes	NIPDAU	Level-1-260C-UNLIM	-40 to 85	PDEI
TPS3820-33DBVRG4	Active	Production	SOT-23 (DBV) 5	3000 LARGE T&R	Yes	NIPDAU	Level-1-260C-UNLIM	-40 to 85	PDEI
TPS3820-33DBVRG4.A	Active	Production	SOT-23 (DBV) 5	3000 LARGE T&R	Yes	NIPDAU	Level-1-260C-UNLIM	-40 to 85	PDEI
TPS3820-33DBVTG4	NRND	Production	SOT-23 (DBV) 5	250 SMALL T&R	-	Call TI	Call TI	-40 to 85	
TPS3820-50DBVR	Active	Production	SOT-23 (DBV) 5	3000 LARGE T&R	Yes	NIPDAU	Level-1-260C-UNLIM	-40 to 85	PDDI
TPS3820-50DBVR.A	Active	Production	SOT-23 (DBV) 5	3000 LARGE T&R	Yes	NIPDAU	Level-1-260C-UNLIM	-40 to 85	PDDI
TPS3820-50DBVRG4	Active	Production	SOT-23 (DBV) 5	3000 LARGE T&R	Yes	NIPDAU	Level-1-260C-UNLIM	-40 to 85	PDDI
TPS3820-50DBVRG4.A	Active	Production	SOT-23 (DBV) 5	3000 LARGE T&R	Yes	NIPDAU	Level-1-260C-UNLIM	-40 to 85	PDDI
TPS3820-50DBVT	Obsolete	Production	SOT-23 (DBV) 5	-	-	Call TI	Call TI	-40 to 85	PDDI
TPS3823-25DBVR	Active	Production	SOT-23 (DBV) 5	3000 LARGE T&R	Yes	NIPDAU	Level-1-260C-UNLIM	-40 to 85	PAPI
TPS3823-25DBVR.A	Active	Production	SOT-23 (DBV) 5	3000 LARGE T&R	Yes	NIPDAU	Level-1-260C-UNLIM	-40 to 85	PAPI
TPS3823-25DBVRG4	Active	Production	SOT-23 (DBV) 5	3000 LARGE T&R	Yes	NIPDAU	Level-1-260C-UNLIM	-40 to 85	PAPI
TPS3823-25DBVRG4.A	Active	Production	SOT-23 (DBV) 5	3000 LARGE T&R	Yes	NIPDAU	Level-1-260C-UNLIM	-40 to 85	PAPI
TPS3823-25DBVT	Obsolete	Production	SOT-23 (DBV) 5	-	-	Call TI	Call TI	-	PAPI
TPS3823-30DBVR	Active	Production	SOT-23 (DBV) 5	3000 LARGE T&R	Yes	NIPDAU	Level-1-260C-UNLIM	-40 to 85	PAQI
TPS3823-30DBVR.A	Active	Production	SOT-23 (DBV) 5	3000 LARGE T&R	Yes	NIPDAU	Level-1-260C-UNLIM	-40 to 85	PAQI
TPS3823-30DBVRG4	Active	Production	SOT-23 (DBV) 5	3000 LARGE T&R	Yes	NIPDAU	Level-1-260C-UNLIM	-40 to 85	PAQI
TPS3823-30DBVRG4.A	Active	Production	SOT-23 (DBV) 5	3000 LARGE T&R	Yes	NIPDAU	Level-1-260C-UNLIM	-40 to 85	PAQI
TPS3823-30DBVT	Obsolete	Production	SOT-23 (DBV) 5	-	-	Call TI	Call TI	-	PAQI
TPS3823-33DBVR	Active	Production	SOT-23 (DBV) 5	3000 LARGE T&R	Yes	NIPDAU	Level-1-260C-UNLIM	-40 to 85	PARI
TPS3823-33DBVR.A	Active	Production	SOT-23 (DBV) 5	3000 LARGE T&R	Yes	NIPDAU	Level-1-260C-UNLIM	-40 to 85	PARI
TPS3823-33DBVRG4	NRND	Production	SOT-23 (DBV) 5	3000 LARGE T&R	Yes	NIPDAU	Level-1-260C-UNLIM	-40 to 85	PARI
TPS3823-33DBVRG4.A	NRND	Production	SOT-23 (DBV) 5	3000 LARGE T&R	Yes	NIPDAU	Level-1-260C-UNLIM	-40 to 85	PARI
TPS3823-33DBVT	Obsolete	Production	SOT-23 (DBV) 5	-	-	Call TI	Call TI	-	PARI
TPS3823-33DBVTG4	NRND	Production	SOT-23 (DBV) 5	250 SMALL T&R	-	Call TI	Call TI	See TPS3823-33DBVT	
TPS3823-50DBVR	Active	Production	SOT-23 (DBV) 5	3000 LARGE T&R	Yes	NIPDAU SN	Level-1-260C-UNLIM	-40 to 85	PASI
TPS3823-50DBVR.A	Active	Production	SOT-23 (DBV) 5	3000 LARGE T&R	Yes	SN	Level-1-260C-UNLIM	-40 to 85	PASI
TPS3823-50DBVRG4	Active	Production	SOT-23 (DBV) 5	3000 LARGE T&R	Yes	NIPDAU	Level-1-260C-UNLIM	-40 to 125	PASI

Orderable part number	Status (1)	Material type (2)	Package Pins	Package qty Carrier	RoHS (3)	Lead finish/ Ball material (4)	MSL rating/ Peak reflow (5)	Op temp (°C)	Part marking (6)
TPS3823-50DBVRG4.A	Active	Production	SOT-23 (DBV) 5	3000 LARGE T&R	Yes	NIPDAU	Level-1-260C-UNLIM	-40 to 125	PASI
TPS3823-50DBVT	Obsolete	Production	SOT-23 (DBV) 5	-	-	Call TI	Call TI	-	PASI
TPS3823-50DBVTG4	NRND	Production	SOT-23 (DBV) 5	250 SMALL T&R	-	Call TI	Call TI	See TPS3823-50DBVT	
TPS3823A-33DBVR	Active	Production	SOT-23 (DBV) 5	3000 LARGE T&R	Yes	NIPDAU	Level-1-260C-UNLIM	-40 to 125	PYPI
TPS3823A-33DBVR.A	Active	Production	SOT-23 (DBV) 5	3000 LARGE T&R	Yes	NIPDAU	Level-1-260C-UNLIM	-40 to 125	PYPI
TPS3823A-33DBVRG4	Active	Production	SOT-23 (DBV) 5	3000 LARGE T&R	Yes	NIPDAU	Level-1-260C-UNLIM	-40 to 125	PYPI
TPS3823A-33DBVRG4.A	Active	Production	SOT-23 (DBV) 5	3000 LARGE T&R	Yes	NIPDAU	Level-1-260C-UNLIM	-40 to 125	PYPI
TPS3823A-33DBVT	Obsolete	Production	SOT-23 (DBV) 5	-	-	Call TI	Call TI	-40 to 125	PYPI
TPS3824-25DBVR	Active	Production	SOT-23 (DBV) 5	3000 LARGE T&R	Yes	SN	Level-1-260C-UNLIM	-40 to 85	PATI
TPS3824-25DBVR.A	Active	Production	SOT-23 (DBV) 5	3000 LARGE T&R	Yes	SN	Level-1-260C-UNLIM	-40 to 85	PATI
TPS3824-30DBVR	Active	Production	SOT-23 (DBV) 5	3000 LARGE T&R	Yes	NIPDAU SN	Level-1-260C-UNLIM	-40 to 85	PAUI
TPS3824-30DBVR.A	Active	Production	SOT-23 (DBV) 5	3000 LARGE T&R	Yes	SN	Level-1-260C-UNLIM	-40 to 85	PAUI
TPS3824-30DBVRG4	Active	Production	SOT-23 (DBV) 5	3000 LARGE T&R	-	Call TI	Call TI	-40 to 85	
TPS3824-30DBVT	Obsolete	Production	SOT-23 (DBV) 5	-	-	Call TI	Call TI	-	PAUI
TPS3824-33DBVR	Active	Production	SOT-23 (DBV) 5	3000 LARGE T&R	Yes	NIPDAU	Level-1-260C-UNLIM	-40 to 85	PAVI
TPS3824-33DBVR.A	Active	Production	SOT-23 (DBV) 5	3000 LARGE T&R	Yes	NIPDAU	Level-1-260C-UNLIM	-40 to 85	PAVI
TPS3824-33DBVRG4	Active	Production	SOT-23 (DBV) 5	3000 LARGE T&R	Yes	NIPDAU	Level-1-260C-UNLIM	-40 to 85	PAVI
TPS3824-33DBVRG4.A	Active	Production	SOT-23 (DBV) 5	3000 LARGE T&R	Yes	NIPDAU	Level-1-260C-UNLIM	-40 to 85	PAVI
TPS3824-33DBVT	Obsolete	Production	SOT-23 (DBV) 5	-	-	Call TI	Call TI	-	PAVI
TPS3824-50DBVR	Active	Production	SOT-23 (DBV) 5	3000 LARGE T&R	Yes	NIPDAU SN	Level-1-260C-UNLIM	-40 to 85	PAWI
TPS3824-50DBVR.A	Active	Production	SOT-23 (DBV) 5	3000 LARGE T&R	Yes	SN	Level-1-260C-UNLIM	-40 to 85	PAWI
TPS3824-50DBVRG4	Active	Production	SOT-23 (DBV) 5	3000 LARGE T&R	Yes	NIPDAU	Level-1-260C-UNLIM	-40 to 85	PAWI
TPS3824-50DBVRG4.A	Active	Production	SOT-23 (DBV) 5	3000 LARGE T&R	Yes	NIPDAU	Level-1-260C-UNLIM	-40 to 85	PAWI
TPS3824-50DBVT	Obsolete	Production	SOT-23 (DBV) 5	-	-	Call TI	Call TI	-	PAWI
TPS3825-33DBVR	Active	Production	SOT-23 (DBV) 5	3000 LARGE T&R	Yes	NIPDAU	Level-1-260C-UNLIM	-40 to 85	PDGI
TPS3825-33DBVR.A	Active	Production	SOT-23 (DBV) 5	3000 LARGE T&R	Yes	NIPDAU	Level-1-260C-UNLIM	-40 to 85	PDGI
TPS3825-33DBVRG4	Active	Production	SOT-23 (DBV) 5	3000 LARGE T&R	Yes	NIPDAU	Level-1-260C-UNLIM	-40 to 85	PDGI
TPS3825-33DBVRG4.A	Active	Production	SOT-23 (DBV) 5	3000 LARGE T&R	Yes	NIPDAU	Level-1-260C-UNLIM	-40 to 85	PDGI
TPS3825-33DBVTG4	NRND	Production	SOT-23 (DBV) 5	250 SMALL T&R	-	Call TI	Call TI	-40 to 85	
TPS3825-50DBVR	Active	Production	SOT-23 (DBV) 5	3000 LARGE T&R	Yes	NIPDAU	Level-1-260C-UNLIM	-40 to 85	PDFI
TPS3825-50DBVR.A	Active	Production	SOT-23 (DBV) 5	3000 LARGE T&R	Yes	NIPDAU	Level-1-260C-UNLIM	-40 to 85	PDFI

Orderable part number	Status (1)	Material type (2)	Package Pins	Package qty Carrier	RoHS (3)	Lead finish/ Ball material (4)	MSL rating/ Peak reflow (5)	Op temp (°C)	Part marking (6)
TPS3825-50DBVRG4	Active	Production	SOT-23 (DBV) 5	3000 LARGE T&R	Yes	NIPDAU	Level-1-260C-UNLIM	-40 to 85	PDFI
TPS3825-50DBVRG4.A	Active	Production	SOT-23 (DBV) 5	3000 LARGE T&R	Yes	NIPDAU	Level-1-260C-UNLIM	-40 to 85	PDFI
TPS3825-50DBVT	Obsolete	Production	SOT-23 (DBV) 5	-	-	Call TI	Call TI	-40 to 85	PDFI
TPS3825-50DBVTG4	NRND	Production	SOT-23 (DBV) 5	250 SMALL T&R	-	Call TI	Call TI	-40 to 85	
TPS3828-33DBVR	Active	Production	SOT-23 (DBV) 5	3000 LARGE T&R	Yes	NIPDAU	Level-1-260C-UNLIM	-40 to 85	PDII
TPS3828-33DBVR.A	Active	Production	SOT-23 (DBV) 5	3000 LARGE T&R	Yes	NIPDAU	Level-1-260C-UNLIM	-40 to 85	PDII
TPS3828-33DBVRG4	Active	Production	SOT-23 (DBV) 5	3000 LARGE T&R	Yes	NIPDAU	Level-1-260C-UNLIM	-40 to 85	PDII
TPS3828-33DBVRG4.A	Active	Production	SOT-23 (DBV) 5	3000 LARGE T&R	Yes	NIPDAU	Level-1-260C-UNLIM	-40 to 85	PDII
TPS3828-33DBVT	Obsolete	Production	SOT-23 (DBV) 5	-	-	Call TI	Call TI	-40 to 85	PDII
TPS3828-33DBVTG4	NRND	Production	SOT-23 (DBV) 5	250 SMALL T&R	-	Call TI	Call TI	-40 to 85	
TPS3828-50DBVR	Active	Production	SOT-23 (DBV) 5	3000 LARGE T&R	Yes	NIPDAU SN	Level-1-260C-UNLIM	-40 to 85	PDHI
TPS3828-50DBVR.A	Active	Production	SOT-23 (DBV) 5	3000 LARGE T&R	Yes	SN	Level-1-260C-UNLIM	-40 to 85	PDHI
TPS3828-50DBVRG4	NRND	Production	SOT-23 (DBV) 5	3000 LARGE T&R	Yes	NIPDAU	Level-1-260C-UNLIM	-40 to 85	PDHI
TPS3828-50DBVRG4.A	NRND	Production	SOT-23 (DBV) 5	3000 LARGE T&R	Yes	NIPDAU	Level-1-260C-UNLIM	-40 to 85	PDHI
TPS3828-50DBVT	Obsolete	Production	SOT-23 (DBV) 5	-	-	Call TI	Call TI	-40 to 85	PDHI
TPS3828-50DBVTG4	NRND	Production	SOT-23 (DBV) 5	250 SMALL T&R	-	Call TI	Call TI	-40 to 85	

(1) **Status:** For more details on status, see our [product life cycle](#).

(2) **Material type:** When designated, preproduction parts are prototypes/experimental devices, and are not yet approved or released for full production. Testing and final process, including without limitation quality assurance, reliability performance testing, and/or process qualification, may not yet be complete, and this item is subject to further changes or possible discontinuation. If available for ordering, purchases will be subject to an additional waiver at checkout, and are intended for early internal evaluation purposes only. These items are sold without warranties of any kind.

(3) **RoHS values:** Yes, No, RoHS Exempt. See the [TI RoHS Statement](#) for additional information and value definition.

(4) **Lead finish/Ball material:** Parts may have multiple material finish options. Finish options are separated by a vertical ruled line. Lead finish/Ball material values may wrap to two lines if the finish value exceeds the maximum column width.

(5) **MSL rating/Peak reflow:** The moisture sensitivity level ratings and peak solder (reflow) temperatures. In the event that a part has multiple moisture sensitivity ratings, only the lowest level per JEDEC standards is shown. Refer to the shipping label for the actual reflow temperature that will be used to mount the part to the printed circuit board.

(6) **Part marking:** There may be an additional marking, which relates to the logo, the lot trace code information, or the environmental category of the part.

Multiple part markings will be inside parentheses. Only one part marking contained in parentheses and separated by a "-" will appear on a part. If a line is indented then it is a continuation of the previous line and the two combined represent the entire part marking for that device.

Important Information and Disclaimer: The information provided on this page represents TI's knowledge and belief as of the date that it is provided. TI bases its knowledge and belief on information provided by third parties, and makes no representation or warranty as to the accuracy of such information. Efforts are underway to better integrate information from third parties. TI has taken and continues to take reasonable steps to provide representative and accurate information but may not have conducted destructive testing or chemical analysis on incoming materials and chemicals. TI and TI suppliers consider certain information to be proprietary, and thus CAS numbers and other limited information may not be available for release.

In no event shall TI's liability arising out of such information exceed the total purchase price of the TI part(s) at issue in this document sold by TI to Customer on an annual basis.

OTHER QUALIFIED VERSIONS OF TPS3820, TPS3823, TPS3824, TPS3825, TPS3828 :

- Automotive : [TPS3820-Q1](#), [TPS3823-Q1](#), [TPS3824-Q1](#), [TPS3825-Q1](#), [TPS3828-Q1](#)

NOTE: Qualified Version Definitions:

- Automotive - Q100 devices qualified for high-reliability automotive applications targeting zero defects

TAPE AND REEL INFORMATION

QUADRANT ASSIGNMENTS FOR PIN 1 ORIENTATION IN TAPE

*All dimensions are nominal

Device	Package Type	Package Drawing	Pins	SPQ	Reel Diameter (mm)	Reel Width W1 (mm)	A0 (mm)	B0 (mm)	K0 (mm)	P1 (mm)	W (mm)	Pin1 Quadrant
TPS3820-33DBVR	SOT-23	DBV	5	3000	178.0	9.0	3.3	3.2	1.4	4.0	8.0	Q3
TPS3820-33DBVRG4	SOT-23	DBV	5	3000	178.0	9.0	3.3	3.2	1.4	4.0	8.0	Q3
TPS3820-50DBVR	SOT-23	DBV	5	3000	178.0	9.0	3.23	3.17	1.37	4.0	8.0	Q3
TPS3820-50DBVRG4	SOT-23	DBV	5	3000	179.0	8.4	3.2	3.2	1.4	4.0	8.0	Q3
TPS3820-50DBVRG4	SOT-23	DBV	5	3000	178.0	9.0	3.23	3.17	1.37	4.0	8.0	Q3
TPS3823-25DBVR	SOT-23	DBV	5	3000	178.0	9.0	3.23	3.17	1.37	4.0	8.0	Q3
TPS3823-25DBVRG4	SOT-23	DBV	5	3000	178.0	9.0	3.23	3.17	1.37	4.0	8.0	Q3
TPS3823-25DBVRG4	SOT-23	DBV	5	3000	179.0	8.4	3.2	3.2	1.4	4.0	8.0	Q3
TPS3823-30DBVR	SOT-23	DBV	5	3000	178.0	9.0	3.23	3.17	1.37	4.0	8.0	Q3
TPS3823-30DBVRG4	SOT-23	DBV	5	3000	178.0	9.0	3.23	3.17	1.37	4.0	8.0	Q3
TPS3823-33DBVR	SOT-23	DBV	5	3000	178.0	9.0	3.23	3.17	1.37	4.0	8.0	Q3
TPS3823-33DBVRG4	SOT-23	DBV	5	3000	178.0	9.0	3.23	3.17	1.37	4.0	8.0	Q3
TPS3823-50DBVR	SOT-23	DBV	5	3000	178.0	9.0	3.23	3.17	1.37	4.0	8.0	Q3
TPS3823-50DBVRG4	SOT-23	DBV	5	3000	178.0	9.0	3.23	3.17	1.37	4.0	8.0	Q3
TPS3823A-33DBVR	SOT-23	DBV	5	3000	178.0	9.0	3.3	3.2	1.4	4.0	8.0	Q3
TPS3823A-33DBVRG4	SOT-23	DBV	5	3000	178.0	9.0	3.3	3.2	1.4	4.0	8.0	Q3

Device	Package Type	Package Drawing	Pins	SPQ	Reel Diameter (mm)	Reel Width W1 (mm)	A0 (mm)	B0 (mm)	K0 (mm)	P1 (mm)	W (mm)	Pin1 Quadrant
TPS3824-25DBVR	SOT-23	DBV	5	3000	180.0	8.4	3.2	3.2	1.4	4.0	8.0	Q3
TPS3824-30DBVR	SOT-23	DBV	5	3000	178.0	9.0	3.23	3.17	1.37	4.0	8.0	Q3
TPS3824-33DBVR	SOT-23	DBV	5	3000	178.0	9.0	3.23	3.17	1.37	4.0	8.0	Q3
TPS3824-33DBVRG4	SOT-23	DBV	5	3000	178.0	9.0	3.23	3.17	1.37	4.0	8.0	Q3
TPS3824-50DBVR	SOT-23	DBV	5	3000	178.0	9.0	3.23	3.17	1.37	4.0	8.0	Q3
TPS3824-50DBVRG4	SOT-23	DBV	5	3000	178.0	9.0	3.23	3.17	1.37	4.0	8.0	Q3
TPS3825-33DBVR	SOT-23	DBV	5	3000	178.0	9.0	3.3	3.2	1.4	4.0	8.0	Q3
TPS3825-33DBVRG4	SOT-23	DBV	5	3000	178.0	9.0	3.3	3.2	1.4	4.0	8.0	Q3
TPS3825-50DBVR	SOT-23	DBV	5	3000	178.0	9.0	3.23	3.17	1.37	4.0	8.0	Q3
TPS3825-50DBVR	SOT-23	DBV	5	3000	179.0	8.4	3.2	3.2	1.4	4.0	8.0	Q3
TPS3825-50DBVRG4	SOT-23	DBV	5	3000	179.0	8.4	3.2	3.2	1.4	4.0	8.0	Q3
TPS3825-50DBVRG4	SOT-23	DBV	5	3000	178.0	9.0	3.23	3.17	1.37	4.0	8.0	Q3
TPS3828-33DBVR	SOT-23	DBV	5	3000	178.0	9.0	3.23	3.17	1.37	4.0	8.0	Q3
TPS3828-33DBVRG4	SOT-23	DBV	5	3000	178.0	9.0	3.23	3.17	1.37	4.0	8.0	Q3
TPS3828-50DBVR	SOT-23	DBV	5	3000	178.0	9.0	3.23	3.17	1.37	4.0	8.0	Q3
TPS3828-50DBVRG4	SOT-23	DBV	5	3000	178.0	9.0	3.23	3.17	1.37	4.0	8.0	Q3

TAPE AND REEL BOX DIMENSIONS

*All dimensions are nominal

Device	Package Type	Package Drawing	Pins	SPQ	Length (mm)	Width (mm)	Height (mm)
TPS3820-33DBVR	SOT-23	DBV	5	3000	180.0	180.0	18.0
TPS3820-33DBVRG4	SOT-23	DBV	5	3000	180.0	180.0	18.0
TPS3820-50DBVR	SOT-23	DBV	5	3000	180.0	180.0	18.0
TPS3820-50DBVRG4	SOT-23	DBV	5	3000	200.0	183.0	25.0
TPS3820-50DBVRG4	SOT-23	DBV	5	3000	180.0	180.0	18.0
TPS3823-25DBVR	SOT-23	DBV	5	3000	180.0	180.0	18.0
TPS3823-25DBVRG4	SOT-23	DBV	5	3000	180.0	180.0	18.0
TPS3823-25DBVRG4	SOT-23	DBV	5	3000	203.0	203.0	35.0
TPS3823-30DBVR	SOT-23	DBV	5	3000	180.0	180.0	18.0
TPS3823-30DBVRG4	SOT-23	DBV	5	3000	180.0	180.0	18.0
TPS3823-33DBVR	SOT-23	DBV	5	3000	180.0	180.0	18.0
TPS3823-33DBVRG4	SOT-23	DBV	5	3000	180.0	180.0	18.0
TPS3823-50DBVR	SOT-23	DBV	5	3000	180.0	180.0	18.0
TPS3823-50DBVRG4	SOT-23	DBV	5	3000	180.0	180.0	18.0
TPS3823A-33DBVR	SOT-23	DBV	5	3000	180.0	180.0	18.0
TPS3823A-33DBVRG4	SOT-23	DBV	5	3000	180.0	180.0	18.0
TPS3824-25DBVR	SOT-23	DBV	5	3000	210.0	185.0	35.0
TPS3824-30DBVR	SOT-23	DBV	5	3000	180.0	180.0	18.0

Device	Package Type	Package Drawing	Pins	SPQ	Length (mm)	Width (mm)	Height (mm)
TPS3824-33DBVR	SOT-23	DBV	5	3000	180.0	180.0	18.0
TPS3824-33DBVRG4	SOT-23	DBV	5	3000	180.0	180.0	18.0
TPS3824-50DBVR	SOT-23	DBV	5	3000	180.0	180.0	18.0
TPS3824-50DBVRG4	SOT-23	DBV	5	3000	180.0	180.0	18.0
TPS3825-33DBVR	SOT-23	DBV	5	3000	180.0	180.0	18.0
TPS3825-33DBVRG4	SOT-23	DBV	5	3000	180.0	180.0	18.0
TPS3825-50DBVR	SOT-23	DBV	5	3000	180.0	180.0	18.0
TPS3825-50DBVR	SOT-23	DBV	5	3000	203.0	203.0	35.0
TPS3825-50DBVRG4	SOT-23	DBV	5	3000	203.0	203.0	35.0
TPS3825-50DBVRG4	SOT-23	DBV	5	3000	180.0	180.0	18.0
TPS3828-33DBVR	SOT-23	DBV	5	3000	180.0	180.0	18.0
TPS3828-33DBVRG4	SOT-23	DBV	5	3000	180.0	180.0	18.0
TPS3828-50DBVR	SOT-23	DBV	5	3000	180.0	180.0	18.0
TPS3828-50DBVRG4	SOT-23	DBV	5	3000	180.0	180.0	18.0

EXAMPLE BOARD LAYOUT

DBV0005A

SOT-23 - 1.45 mm max height

SMALL OUTLINE TRANSISTOR



LAND PATTERN EXAMPLE
EXPOSED METAL SHOWN
SCALE:15X



SOLDER MASK DETAILS

4214839/K 08/2024

NOTES: (continued)

- 6. Publication IPC-7351 may have alternate designs.
- 7. Solder mask tolerances between and around signal pads can vary based on board fabrication site.

EXAMPLE STENCIL DESIGN

DBV0005A

SOT-23 - 1.45 mm max height

SMALL OUTLINE TRANSISTOR



SOLDER PASTE EXAMPLE
BASED ON 0.125 mm THICK STENCIL
SCALE:15X

4214839/K 08/2024

NOTES: (continued)

8. Laser cutting apertures with trapezoidal walls and rounded corners may offer better paste release. IPC-7525 may have alternate design recommendations.
9. Board assembly site may have different recommendations for stencil design.

IMPORTANT NOTICE AND DISCLAIMER

TI PROVIDES TECHNICAL AND RELIABILITY DATA (INCLUDING DATASHEETS), DESIGN RESOURCES (INCLUDING REFERENCE DESIGNS), APPLICATION OR OTHER DESIGN ADVICE, WEB TOOLS, SAFETY INFORMATION, AND OTHER RESOURCES "AS IS" AND WITH ALL FAULTS, AND DISCLAIMS ALL WARRANTIES, EXPRESS AND IMPLIED, INCLUDING WITHOUT LIMITATION ANY IMPLIED WARRANTIES OF MERCHANTABILITY, FITNESS FOR A PARTICULAR PURPOSE OR NON-INFRINGEMENT OF THIRD PARTY INTELLECTUAL PROPERTY RIGHTS.

These resources are intended for skilled developers designing with TI products. You are solely responsible for (1) selecting the appropriate TI products for your application, (2) designing, validating and testing your application, and (3) ensuring your application meets applicable standards, and any other safety, security, regulatory or other requirements.

These resources are subject to change without notice. TI grants you permission to use these resources only for development of an application that uses the TI products described in the resource. Other reproduction and display of these resources is prohibited. No license is granted to any other TI intellectual property right or to any third party intellectual property right. TI disclaims responsibility for, and you fully indemnify TI and its representatives against any claims, damages, costs, losses, and liabilities arising out of your use of these resources.

TI's products are provided subject to [TI's Terms of Sale](#), [TI's General Quality Guidelines](#), or other applicable terms available either on ti.com or provided in conjunction with such TI products. TI's provision of these resources does not expand or otherwise alter TI's applicable warranties or warranty disclaimers for TI products. Unless TI explicitly designates a product as custom or customer-specified, TI products are standard, catalog, general purpose devices.

TI objects to and rejects any additional or different terms you may propose.

Copyright © 2026, Texas Instruments Incorporated

Last updated 10/2025