

TPS61253A, TPS61253E, TPS61253F 3.8MHz, 5V, 4A Boost Converter in 1.2mm x 1.3mm WCSP

1 Features

- Wide input voltage range from 2.3V to 5.5V (TPS61253A, TPS61253F)
- Wide input voltage range from 2.5V to 5.5V (Startup>2.6V, TPS61253E)
- Fixed output voltage: 4.5 / 4.7 / 5.0 / 5.2V / 5.25V
- Two FETs integrated: 35mΩ LS-FET, 60mΩ HS-FET
- IOUT ≥ 1500mA continuously at VOUT = 5V and VIN ≥ 3V (TPS61253A, TPS61253F)
- IOUT ≥ 1500mA continuously at VOUT = 5.25V and VIN ≥ 3V (TPS61253E)
- 42µA quiescent current from input
- 4A switching valley current limit (TPS61253A)
- 4.5A switching valley current limit (TPS61253E, TPS61253F)
- TPS61253E and TPS61253F support 1.2V I/O
- TPS612532A output discharge function available
- 3.8MHz switching frequency
- Selectable Auto PFM, Forced PWM, and Ultrasonic mode
- Support pass-through mode
- ±2% output voltage accuracy
- 600µs soft-start time
- Hiccup-mode short protection
- Load disconnection during shutdown
- Thermal shutdown
- Create a custom design using the TPS61253A with the [WEBENCH® Power Designer](#)

2 Applications

- [Smart phones](#)
- [Portable speaker](#)
- [USB charging ports](#)
- [NFC PA supply](#)
- [Li battery to 5V power conversion](#)

3 Description

The TPS61253x device provides a power supply solution for battery-powered portable applications. With the input voltage ranging from 2.3V to 5.5V (TPS61253A, TPS61253F) or 2.5V to 5.5V (TPS61253E), the device supports the applications powered by the Li-Ion batteries with the extended voltage range. Different fixed output voltage versions are available of 4.5V, 4.7V, 5V, 5.2V and 5.25V. The TPS61253x supports up to 1500mA load current from a battery discharged as low as 3V.

The TPS61253x operates at typical 3.8MHz switching frequency. The TPS61253x can be flexibly configured at the Auto PFM mode, forced PWM mode, or ultrasonic mode. The Auto PFM mode can benefit with the high efficiency at the light load. The forced PWM operation can make the switching frequency be constant crossing the whole load range. The ultrasonic mode keeps the switching frequency always larger than 25kHz at any load condition to avoid the acoustic noise.

TPS61253x has a built-in 600µs soft start to avoid the inrush current at start-up. When the output is shorted, the device enters into the hiccup mode and recovers automatically after the short releases. During the shutdown, the load is completely disconnected from the input end with maximum 1.3µA current being consumed.

Device Information

| PART NUMBER | PACKAGE ⁽¹⁾ | BODY SIZE (NOM) |
|-------------|------------------------|-----------------|
| TPS61253x | DSBGA (9) | 1.2mm × 1.3mm |

(1) For all available packages, see the orderable addendum at the end of the data sheet.

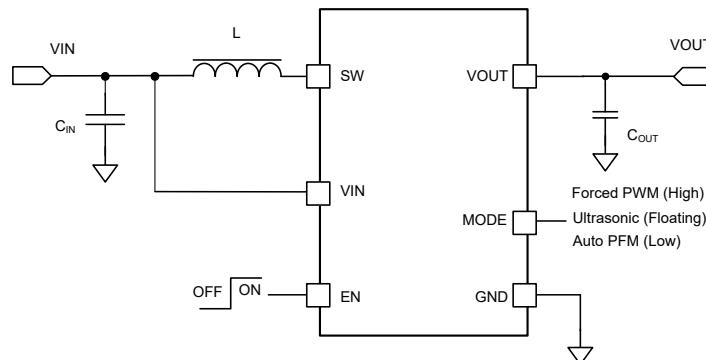

Typical Schematic



Table of Contents

| | | | |
|--|----|--|----|
| 1 Features | 1 | 7.4 Device Functional Modes..... | 15 |
| 2 Applications | 1 | 8 Application and Implementation | 17 |
| 3 Description | 1 | 8.1 Application Information..... | 17 |
| 4 Device Comparison | 3 | 8.2 Typical Application | 17 |
| 5 Pin Configuration and Functions | 4 | 8.3 Power Supply Recommendations..... | 22 |
| 6 Specifications | 5 | 8.4 Layout..... | 22 |
| 6.1 Absolute Maximum Ratings..... | 5 | 9 Device and Documentation Support | 24 |
| 6.2 ESD Ratings..... | 5 | 9.1 Device Support | 24 |
| 6.3 Recommended Operating Conditions..... | 5 | 9.2 Documentation Support | 24 |
| 6.4 Thermal Information..... | 5 | 9.3 Receiving Notification of Documentation Updates.... | 24 |
| 6.5 Electrical Characteristics..... | 6 | 9.4 Support Resources..... | 24 |
| 6.6 Timing Requirements..... | 7 | 9.5 Trademarks..... | 24 |
| 6.7 Switching Characteristics..... | 7 | 9.6 Electrostatic Discharge Caution..... | 24 |
| 6.8 Typical Characteristics..... | 8 | 9.7 Glossary..... | 25 |
| 7 Detailed Description | 11 | 10 Revision History | 25 |
| 7.1 Overview..... | 11 | 11 Mechanical, Packaging, and Orderable Information | 26 |
| 7.2 Functional Block Diagram..... | 12 | | |
| 7.3 Feature Description..... | 12 | | |

4 Device Comparison

| PART NUMBER | OUTPUT VOLTAGE | SW VALLEY CURRENT LIMIT (TYP.) | DC START-UP CURRENT LIMIT (TYP.) | INPUT START-UP VOLTAGE | EN I/O LOGIC | SPECIFIC FEATURES |
|---------------------------|----------------|--------------------------------|----------------------------------|------------------------|---------------------------------------|---|
| TPS61253A | 5V | 4A | 1.5A | 2.3V | Supports 1.8V logic I/O | Supports output 5V, up to 1500mA |
| TPS612532A | 5V | 4A | 1.5A | 2.3V | Supports 1.8V logic I/O | Supports output 5V, up to 1500mA with output discharge function |
| TPS61253E | 5.25V | 4.5A | 1.5A | 2.6V | Supports both 1.8V and 1.2V logic I/O | Supports output 5.25V, up to 1500mA |
| TPS61253F | 5V | 4.5A | 1.5A | 2.3V | Supports both 1.8V and 1.2V logic I/O | Supports output 5V, up to 1500mA |
| TPS61254A ⁽¹⁾ | 4.5V | 2.5A | 0.75A | 2.3V | Supports 1.8V logic I/O | Supports output 4.5V, up to 1000mA |
| TPS61255A ⁽¹⁾ | 4.7V | 4A | 1.5A | 2.3V | Supports 1.8V logic I/O | Supports output 4.5V, up to 1500mA |
| TPS612561A ⁽¹⁾ | 5V | 2.5A | 0.75A | 2.3V | Supports 1.8V logic I/O | Supports output 5V, up to 1000mA |
| TPS61258A ⁽¹⁾ | 4.5V | 4A | 1.5A | 2.3V | Supports 1.8V logic I/O | Supports output 4.5V, up to 1500mA |
| TPS612592A ⁽¹⁾ | 5.2V | 4A | 0.75A | 2.3V | Supports 1.8V logic I/O | Supports output 5.2V, up to 1500mA |
| TPS612531A ⁽¹⁾ | 5V | 4A | 1.5A | 2.3V | Supports 1.8V logic I/O | Supports output 5V, up to 1500mA with PFM/PWM mode only |

(1) Preview. Contact TI factory for more information.

5 Pin Configuration and Functions

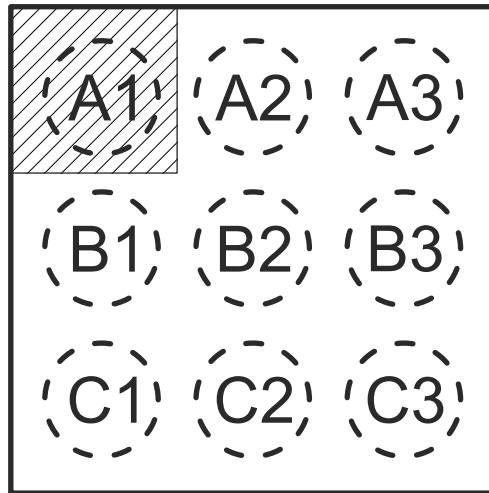

Figure 5-1. 9-Pin DSBGA YFF Package (Top View)

Table 5-1. Pin Functions

| PIN | | I/O | DESCRIPTION |
|------|--------|-----|--|
| NAME | NO. | | |
| EN | B3 | I | This is the enable pin of the device. Connecting this pin to ground forces the device into shutdown mode. Pulling this pin high enables the device. There is an internal resistor pulled to GND. |
| GND | C1, C2 | – | Ground pin |
| MODE | C3 | – | Operation mode selection pin Mode = Low, the device works in the Auto PFM mode with good light load efficiency. Mode = High, the device is in the forced PWM mode, keep the switching frequency be constant crossing the whole load range. Mode = Floating, the device works in the ultrasonic mode; it keeps the switching frequency larger than 25kHz to avoid the acoustic frequency toward no load condition. |
| SW | B1, B2 | I/O | The switch pin of the converter. It is connected to the drain of the internal low-side power FET and the source of the internal high-side power FET. |
| VIN | A3 | I | Power supply input |
| VOUT | A1, A2 | O | Boost converter output |

6 Specifications

6.1 Absolute Maximum Ratings

Over operating free-air temperature range (unless otherwise noted)⁽¹⁾

| | | MIN | MAX | UNIT |
|---------------------------------------|--------------------------------|------|-----|------|
| Voltage range at terminals | Voltage at VIN, EN, MODE, VOUT | -0.3 | 6 | V |
| | Voltage at SW | -0.3 | 7 | V |
| Storage temperature, T _{stg} | | -65 | 150 | °C |

- (1) Stresses beyond those listed under *Absolute Maximum Ratings* may cause permanent damage to the device. These are stress ratings only, which do not imply functional operation of the device at these or any other conditions beyond those indicated under *Recommended Operating Conditions*. Exposure to absolute-maximum-rated conditions for extended periods may affect device reliability.

6.2 ESD Ratings

| | | VALUE | UNIT |
|--|---|-------|------|
| V _(ESD) Electrostatic discharge | Human-body model (HBM), per ANSI/ESDA/JEDEC JS-001 ⁽¹⁾ | ±2000 | V |
| | Charged-device model (CDM), per JEDEC specification JESD22C101 ⁽²⁾ | ±500 | |

- (1) JEDEC document JEP155 states that 500V HBM allows safe manufacturing with a standard ESD control process. Manufacturing with less than 500V HBM is possible with the necessary precautions.
 (2) JEDEC document JEP157 states that 250V CDM allows safe manufacturing with a standard ESD control process. Manufacturing with less than 250V CDM is possible with the necessary precautions.

6.3 Recommended Operating Conditions

Over operating free-air temperature range unless otherwise noted.

| | | MIN | NOM | MAX | UNIT |
|------------------|--------------------------------------|------|-----|-----|------|
| V _{IN} | Input voltage (TPS61253A, TPS61253F) | 2.3 | | 5.5 | V |
| | Input voltage (TPS61253E) | 2.5 | | 5.5 | V |
| L | Effective inductance | 0.33 | | 1.3 | μH |
| C _{OUT} | Effective output capacitance | 3.5 | 5 | 30 | μF |
| T _J | Operating junction temperature | -40 | | 125 | °C |

6.4 Thermal Information

| THERMAL METRIC ⁽¹⁾ | | TPS61253x | UNIT |
|-------------------------------|--|-------------|------|
| | | YFF (DSBGA) | |
| | | 9 PINS | |
| R _{θJA} | Junction-to-ambient thermal resistance | 108.3 | °C/W |
| R _{θJC(top)} | Junction-to-case (top) thermal resistance | 1.2 | °C/W |
| R _{θJB} | Junction-to-board thermal resistance | 28.8 | °C/W |
| ψ _{JT} | Junction-to-top characterization parameter | 0.6 | °C/W |
| ψ _{JB} | Junction-to-board characterization parameter | 28.9 | °C/W |

- (1) For more information about traditional and new thermal metrics, see the *Semiconductor and IC Package Thermal Metrics* application report, [SPRA953](#).

6.5 Electrical Characteristics

For TPS61253A and TPS61253F, $V_{IN} = 2.3V$ to $4.85V$, $V_{OUT} = 5V$, $T_J = -40^{\circ}C$ to $125^{\circ}C$; Typical values are at $V_{IN} = 3.6V$, $T_J = 25^{\circ}C$, unless otherwise noted.

For TPS61253E, $V_{IN} = 2.6V$ to $4.85V$, $V_{OUT} = 5.25V$, $T_J = -40^{\circ}C$ to $125^{\circ}C$; Typical values are at $V_{IN} = 3.6V$, $T_J = 25^{\circ}C$, unless otherwise noted.

| PARAMETER | | TEST CONDITIONS | MIN | TYP | MAX | UNIT |
|--------------------------|--|--|-------|-------|-------|-------------|
| SUPPLY CURRENT | | | | | | |
| V_{IN_UVLO} | Input voltage under voltage lockout (UVLO) threshold | V_{IN} rising, TPS61253A, TPS61253F | | 2.2 | 2.3 | V |
| | | V_{IN} falling, TPS61253A, TPS61253F | | 2.1 | 2.2 | V |
| | Input voltage under voltage lockout (UVLO) threshold (E version) | V_{IN} rising, TPS61253E | 2.4 | 2.5 | 2.6 | V |
| | | V_{IN} falling, TPS61253E | 2.3 | 2.4 | 2.5 | V |
| I_Q | Quiescent current into VIN pin | $V_{IN} = 3.6V$, $V_{OUT} = 5V$, $EN = V_{IN}$ Device not switching | | 42 | 50 | μA |
| | Quiescent current into VOUT pin | $V_{IN} = 3.6V$, $V_{OUT} = 5V$, $EN = V_{IN}$ Device not switching | | 6.6 | 12 | μA |
| I_{SD} | Shutdown current | $EN = GND$, $V_{IN} = 2.3V$ to $5.5V$, $-40^{\circ}C \leq T_J \leq 85^{\circ}C$ | | 0.05 | 1.3 | μA |
| OUTPUT VOLTAGE | | | | | | |
| V_{OUT} | PWM Operation | $2.3V \leq V_{IN} \leq 4.85V$, $I_{OUT} = 0mA$, PWM operation. Open Loop. TPS61253A, TPS61253F | 4.9 | 5 | 5.1 | V |
| | PWM Operation | $2.6V \leq V_{IN} \leq 4.85V$, $I_{OUT} = 0mA$, PWM operation. Open Loop. TPS61253E | 5.145 | 5.25 | 5.355 | V |
| | PFM Operation | Auto PFM Mode | | 100.8 | | $\%V_{OUT}$ |
| | Ultrasonic Operation | Ultrasonic Mode | | 101.6 | | $\%V_{OUT}$ |
| R_{DIS} | output discharge resistor | $V_{OUT} = 5V$, TPS612532A | | 350 | | Ω |
| POWER SWITCHES | | | | | | |
| R_{DSON} | Low-side FET on resistance | | | 35 | 55 | $m\Omega$ |
| | High-side FET on resistance | | | 60 | 80 | $m\Omega$ |
| CURRENT LIMIT | | | | | | |
| I_{LIM_SW} | Switching valley current limit at Auto PFM / Ultrasonic Mode | TPS61253A | 3.4 | 4 | 4.6 | A |
| | Switching valley current limit at Forced PWM Mode | TPS61253A | 3.35 | 3.95 | 4.55 | A |
| | Switching valley current limit at Auto PFM / Ultrasonic Mode | TPS61253E, TPS61253F | 3.9 | 4.5 | 5.1 | A |
| | Switching valley current limit at Forced PWM Mode | TPS61253E, TPS61253F | 3.85 | 4.45 | 5.05 | A |
| I_{LIM_DC} | DC startup current limit | TPS61253A, TPS61253E, TPS61253F | 1 | 1.5 | | A |
| EN AND MODE LOGIC | | | | | | |
| V_{EN_H} | EN logic high threshold | TPS61253A | | | 1.2 | V |
| | | TPS61253E, TPS61253F | | | 0.9 | V |
| V_{EN_L} | EN logic low threshold | TPS61253A | 0.4 | | | V |
| | | TPS61253E, TPS61253F | 0.36 | | | V |
| R_{EN} | EN pull-down resistor | | | 930 | | $k\Omega$ |
| V_{MODE_H} | Mode logic high threshold | | | | 1.2 | V |
| V_{MODE_L} | Mode logic low threshold | | 0.4 | | | V |
| V_{MODE_F} | Mode pin floating voltage | | 0.75 | 0.8 | 0.85 | V |

6.5 Electrical Characteristics (continued)

For TPS61253A and TPS61253F, $V_{IN} = 2.3V$ to $4.85V$, $V_{OUT} = 5V$, $T_J = -40^{\circ}C$ to $125^{\circ}C$; Typical values are at $V_{IN} = 3.6V$, $T_J = 25^{\circ}C$, unless otherwise noted.

For TPS61253E, $V_{IN} = 2.6V$ to $4.85V$, $V_{OUT} = 5.25V$, $T_J = -40^{\circ}C$ to $125^{\circ}C$; Typical values are at $V_{IN} = 3.6V$, $T_J = 25^{\circ}C$, unless otherwise noted.

| PARAMETER | | TEST CONDITIONS | MIN | TYP | MAX | UNIT |
|--------------------|-----------------------------------|-----------------|-----|-----|-----|-------------|
| I_{MODE_UP} | Pull up current | | | 1 | | μA |
| $I_{MODE_DO_WN}$ | Pull down current | | | 1 | | μA |
| PROTECTION | | | | | | |
| T_{SD_R} | Thermal shutdown rising threshold | | | 150 | | $^{\circ}C$ |
| T_{SD_HYS} | Thermal protection hysteresis | | | 20 | | $^{\circ}C$ |

6.6 Timing Requirements

For TPS61253A and TPS61253F, $V_{IN} = 2.3V$ to $4.85V$, $V_{OUT} = 5V$, $T_J = -40^{\circ}C$ to $125^{\circ}C$; Typical values are at $V_{IN} = 3.6V$, $T_J = 25^{\circ}C$, unless otherwise noted.

For TPS61253E, $V_{IN} = 2.6V$ to $4.85V$, $V_{OUT} = 5.25V$, $T_J = -40^{\circ}C$ to $125^{\circ}C$; Typical values are at $V_{IN} = 3.6V$, $T_J = 25^{\circ}C$, unless otherwise noted.

| | | | MIN | NOM | MAX | UNIT |
|------------------------|------------------------------|---|-----|------|-----|---------|
| HICCUP OFF TIME | | | | | | |
| t_{HCP_ON} | Hiccup on time | $V_{IN} = 3.6V$ | | 1000 | | μs |
| t_{HCP_OFF} | Waiting time for the restart | $V_{IN} = 3.6V$ | | 20 | | ms |
| START UP TIME | | | | | | |
| t_{EN_DELAY} | Startup delay time | Time from EN high to start switching, No load | | 70 | | μs |
| t_{SS} | Soft start time | Time from EN high to V_{OUT} , No load | | 600 | | μs |

6.7 Switching Characteristics

For TPS61253A and TPS61253F, $V_{IN} = 2.3V$ to $4.85V$, $V_{OUT} = 5V$, $T_J = -40^{\circ}C$ to $125^{\circ}C$; Typical values are at $V_{IN} = 3.6V$, $T_J = 25^{\circ}C$, unless otherwise noted.

For TPS61253E, $V_{IN} = 2.6V$ to $4.85V$, $V_{OUT} = 5.25V$, $T_J = -40^{\circ}C$ to $125^{\circ}C$; Typical values are at $V_{IN} = 3.6V$, $T_J = 25^{\circ}C$, unless otherwise noted.

| PARAMETER | | TEST CONDITIONS | MIN | TYP | MAX | UNIT |
|-----------|--------------------------------------|-----------------|-----|------|-----|------|
| f_{sw} | Switching frequency, PWM mode | $V_{IN} = 3.6V$ | | 3800 | | kHz |
| | Switching frequency, Ultrasonic mode | $V_{IN} = 3.6V$ | 25 | | | kHz |

6.8 Typical Characteristics

This section is based on the test results of TPS61253A, unless otherwise noted.

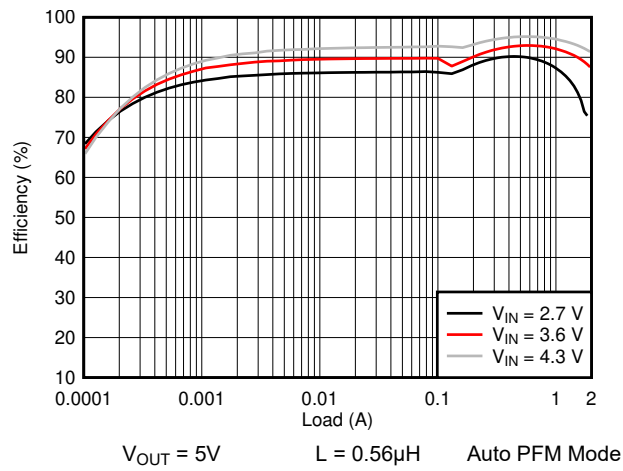

Figure 6-1. Efficiency vs Load

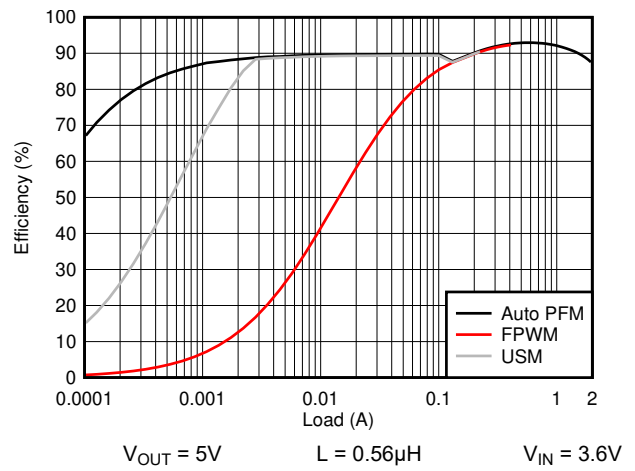

Figure 6-2. Efficiency vs Load

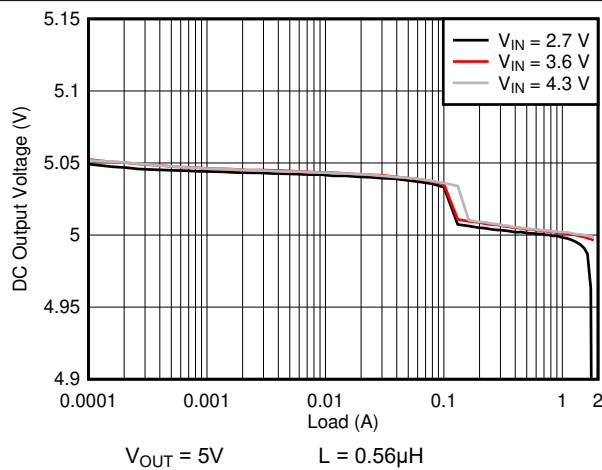

Figure 6-3. DC Output Voltage vs Load

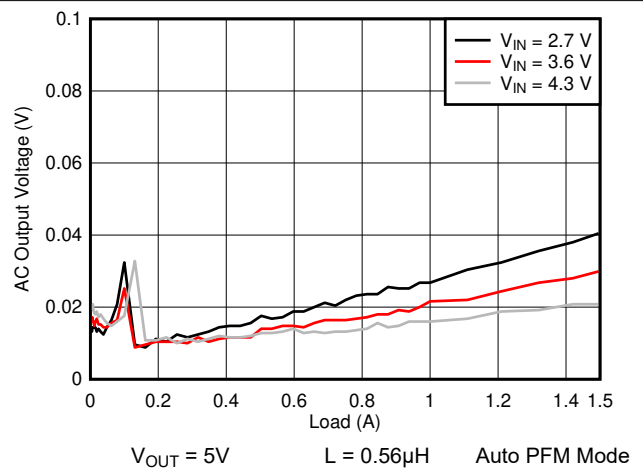

Figure 6-4. AC Output Voltage vs Load

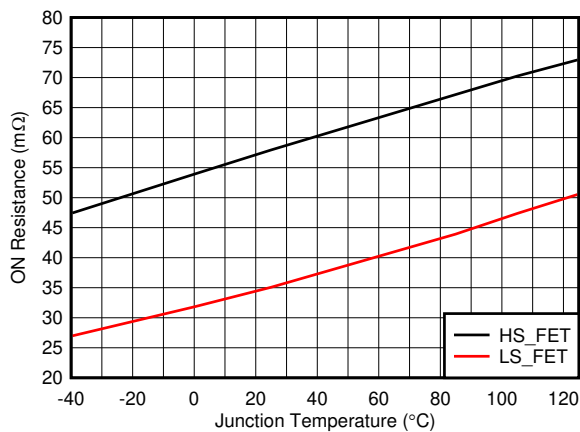

Figure 6-5. $R_{DS(ON)}$ vs Temperature

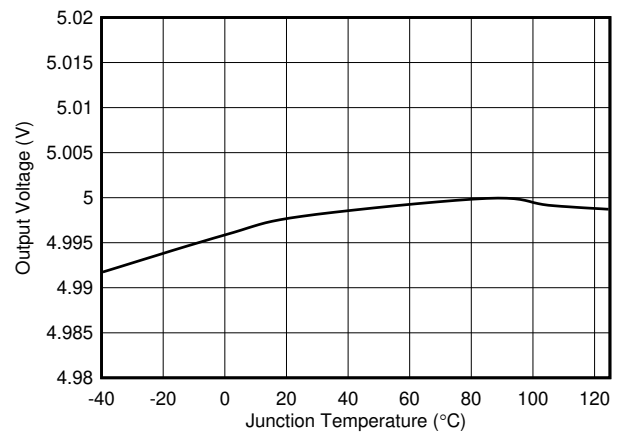

Figure 6-6. V_{OUT} vs Temperature

6.8 Typical Characteristics (continued)

This section is based on the test results of TPS61253A, unless otherwise noted.

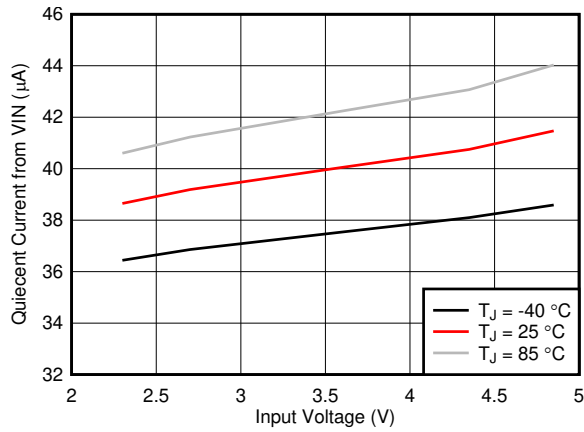

Figure 6-7. Quiescent Current (from VIN) vs Input Voltage

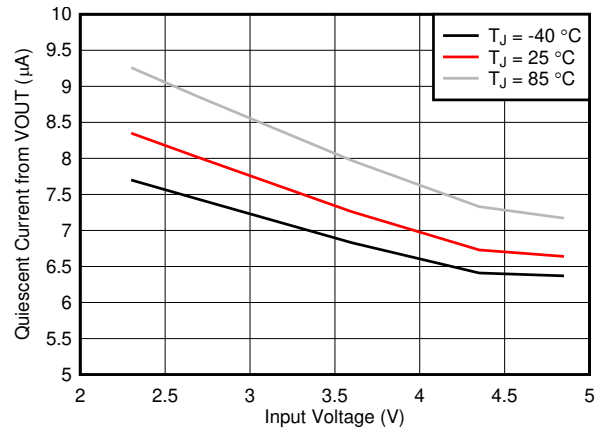

Figure 6-8. Quiescent Current (from VOUT) vs Input Voltage

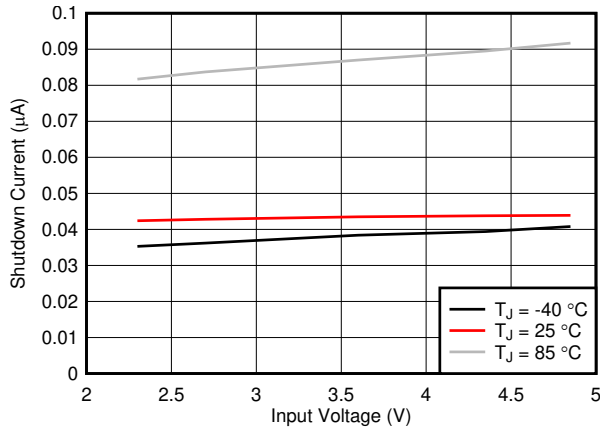

Figure 6-9. Shutdown Current vs Input Voltage

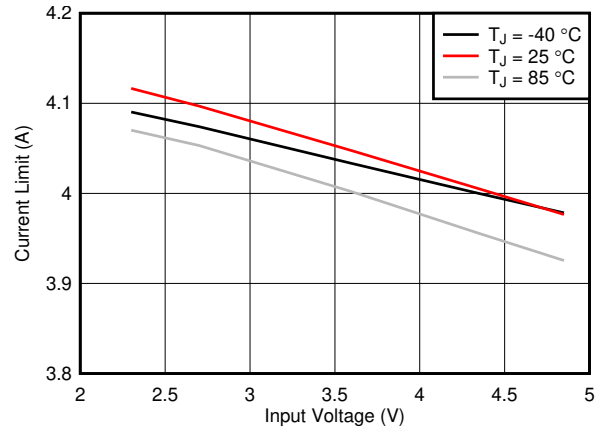

Figure 6-10. Current Limit (Auto PFM) vs Input Voltage

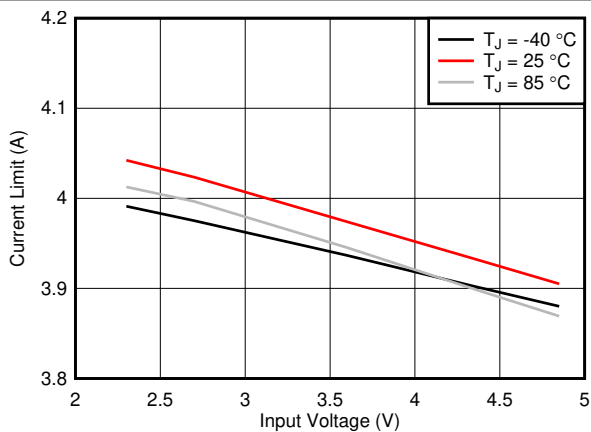

Figure 6-11. Current Limit (Forced PWM) vs Input Voltage

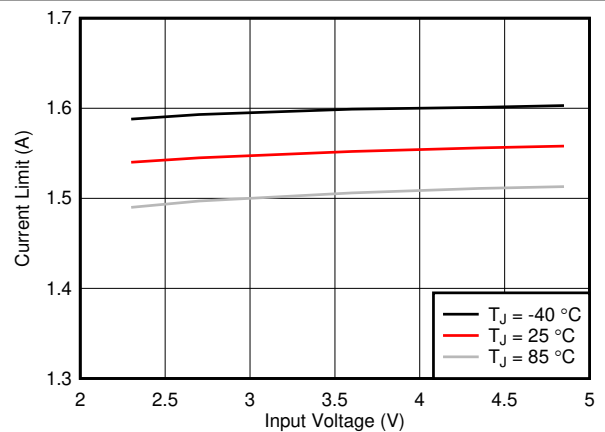

Figure 6-12. DC Startup Current Limit vs Input Voltage

6.8 Typical Characteristics (continued)

This section is based on the test results of TPS61253A, unless otherwise noted.

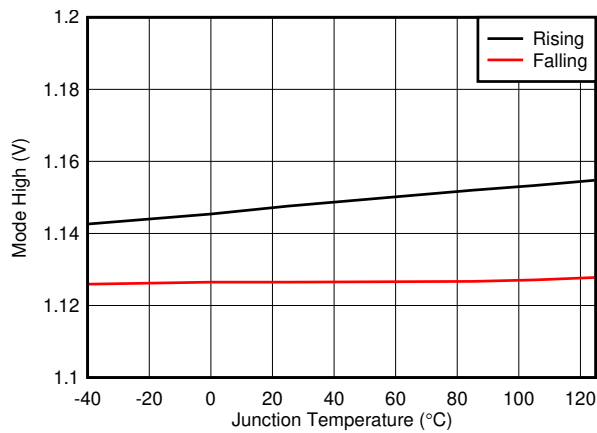

Figure 6-13. Mode High Rising / Falling vs Temperature

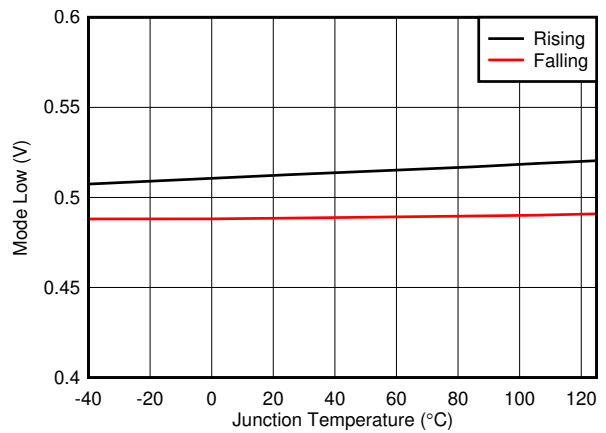

Figure 6-14. Mode Low Rising / Falling vs Temperature

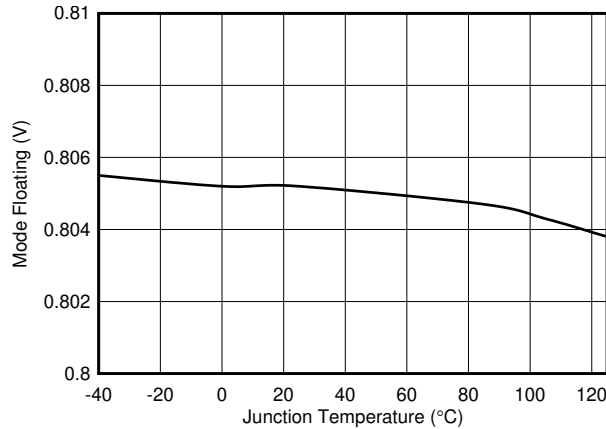

Figure 6-15. Mode Floating vs Temperature

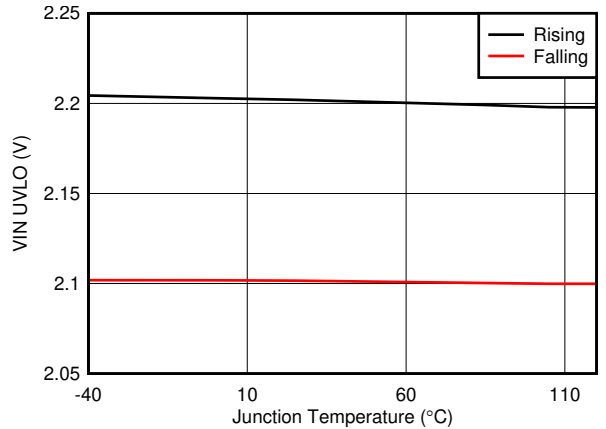

Figure 6-16. VIN UVLO vs Temperature

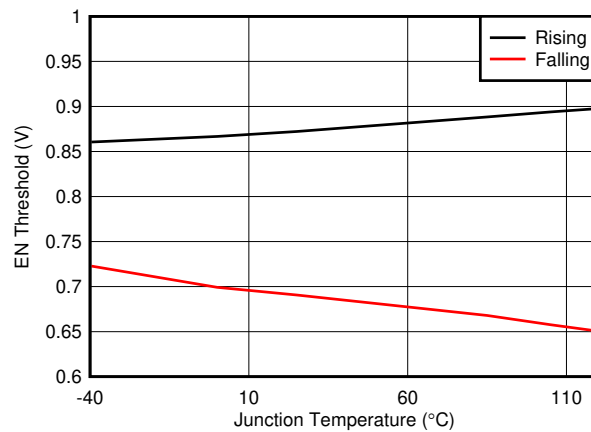

Figure 6-17. EN Threshold vs Temperature

7 Detailed Description

7.1 Overview

The TPS61253x synchronous step-up converter typically operates at a quasi-constant 3.8MHz frequency pulse width modulation (PWM) from the moderate-to-heavy load currents. During the PWM operation, the converter uses a quasi-constant on-time valley current mode control scheme to achieve the excellent line / load regulation and allows the use of a small inductor and ceramic capacitors. Based on the V_{IN} / V_{OUT} ratio, a simple circuit predicts the required on-time. At the beginning of the switching cycle, the low-side N-MOS switch is turned on and the inductor current ramps up to a peak current that is defined by the on-time and the inductance. In the second phase, once the on-timer has expired, the rectifier FET is turned on and the inductor current decays to a preset valley current threshold. Then, the switching cycle repeats by setting the on timer again and activating the low-side N-MOS switch.

At the light load current conditions, the TPS61253x can be flexibly configured at the Auto PFM mode, the forced PWM or the ultrasonic mode. At the Auto PFM mode, the TPS61253x converter operates in Power Save Mode with pulse frequency modulation (PFM) and improves the efficiency. For forced PWM mode, the switching frequency is the same at the light load as that of heavy load. The ultrasonic mode is a unique control feature that keeps the switching frequency above 25kHz to avoid the acoustic audible frequencies toward virtually no load condition.

In general, a dc/dc step-up converter can only operate in "true" boost mode, that is the output "boosted" by a certain amount above the input voltage. The TPS61253x device operates differently as it can smoothly transition in and out of pass-through operation (V_{IN} exceeds the preset out of Boost). Therefore the output can be kept as close as possible to its regulation limits even though the converter is subject to an input voltage that tends to be excessive.

Internal soft start and loop compensation simplify the design process while minimizing the number of external components.

7.2 Functional Block Diagram

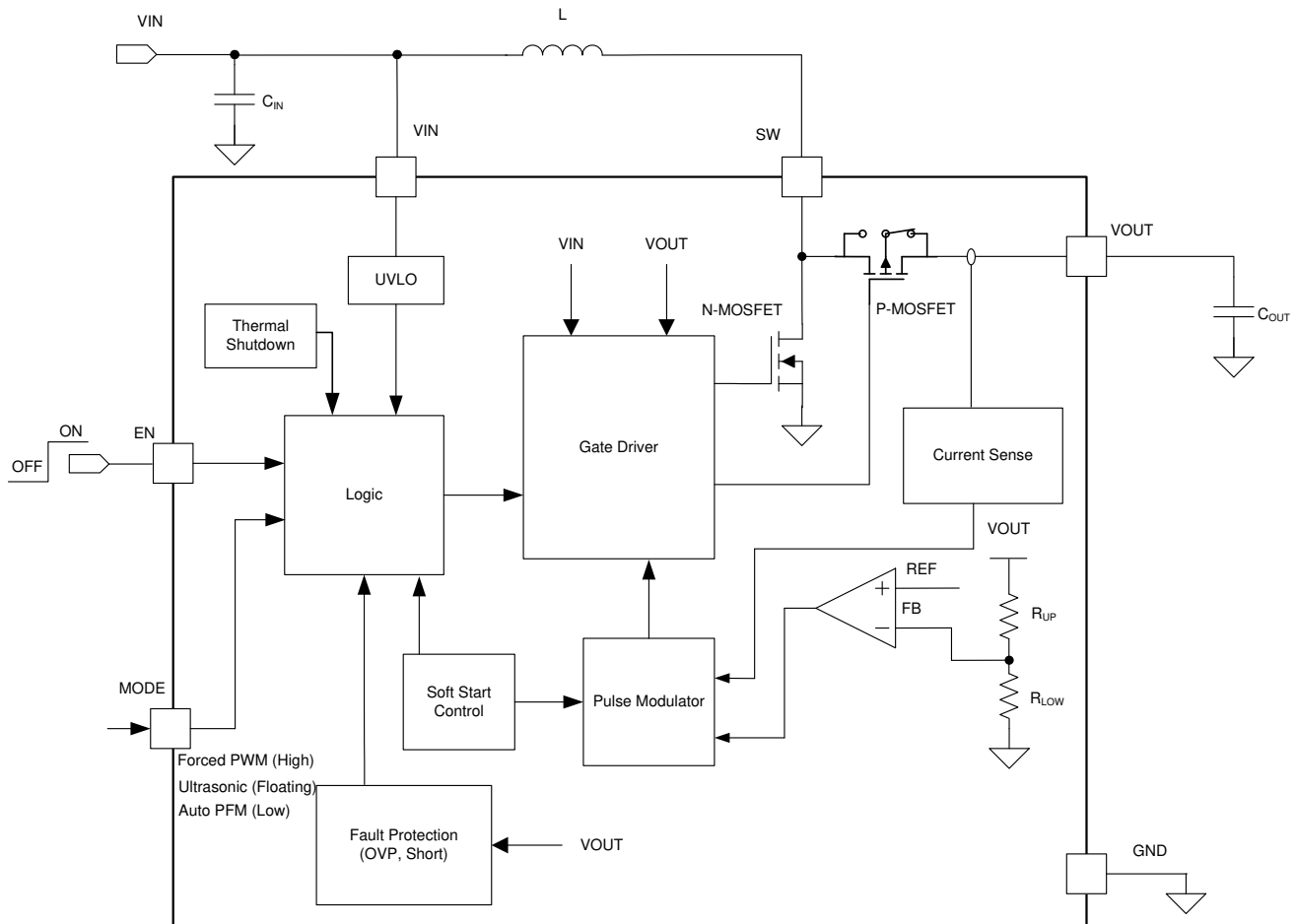

7.3 Feature Description

7.3.1 Start-up

The TPS61253x integrates an internal circuit that controls the ramp up of the output voltage during start-up and prevents the converter from the large inrush current. When the device is enabled, the high-side rectifying switch turns on to charge the output capacitor linearly which is called the pre-charge phase. During the pre-charge phase, the output current is limited to the pre-charge current limit I_{LIM_DC} . The pre-charge phase terminates when the output voltage getting close to the input voltage.

Once the output capacitor has been biased close to the input voltage, the device starts switching which is called the soft-start phase. During the soft start phase, a soft-start voltage is used to regulate the FB pin voltage, and the output voltage rising slope follows the soft-start voltage slope. The device successfully completes the soft-start phase and operates normally once the nominal output voltage is reached.

Table 7-1. Start-up Mode Description

| MODE | DESCRIPTION | CONDITION |
|------------------|--|--|
| Pre-charge | V_{OUT} linearly starts up without switching | $V_{OUT} < V_{IN} - 300\text{mV}$ |
| Boost soft start | V_{OUT} starts up with switching phase | $V_{OUT_BOOST} \geq V_{OUT} \geq V_{IN} - 300\text{mV}$ |

7.3.2 Enable and Disable

The device is enabled by setting the EN pin to a voltage above 1.2V (TPS61253A) or 0.9V (TPS61253E and TPS61253F) and the V_{IN} above the UVLO threshold. At first, the internal reference is activated and the internal

analog circuits are settled. Afterwards, the start-up phase is activated and the output voltage increases. When the EN pin is grounded, the TPS61253x enters shutdown mode, then device stops switching and the internal control circuitry is turned off.

7.3.3 Undervoltage Lockout (UVLO)

The undervoltage lockout circuit prevents the device from malfunctioning when the battery voltage is too low due to excessive discharge. The device starts operation once the rising V_{IN} trips the undervoltage lockout (UVLO) threshold and it disables the output stage of the converter once the V_{IN} is below UVLO falling threshold.

7.3.4 Current Limit Operation

During the start-up phase, the output current is limited to the pre-charge current limit which is specified as the I_{LIM_DC} in [Section 6.5](#).

The TPS61253x employs a valley current sensing scheme during the normal boost switching phase. When the output load increases, the cycle-by-cycle valley current limit will be triggered. As shown in [Figure 7-1](#), the maximum continuous output current before entering the current limit operation can be defined by [Equation 1](#):

$$I_{OUT_LIM} = (1-D) \times (I_{VALLEY_LIM} + \frac{1}{2} \Delta I_L) \quad (1)$$

$$D = 1 - \frac{V_{IN} \times \eta}{V_{OUT}} \quad (2)$$

$$\Delta I_L = \frac{V_{IN}}{L} \times \frac{D}{f} \quad (3)$$

where

- I_{OUT_LIM} is the output current limit, I_{VALLEY_LIM} is switching valley current limit
- ΔI_L is the peak-peak inductor current ripple
- D is the duty cycle, f is the switching frequency, η is the efficiency, L is the inductor
- V_{OUT} is the output voltage, V_{IN} is the input voltage

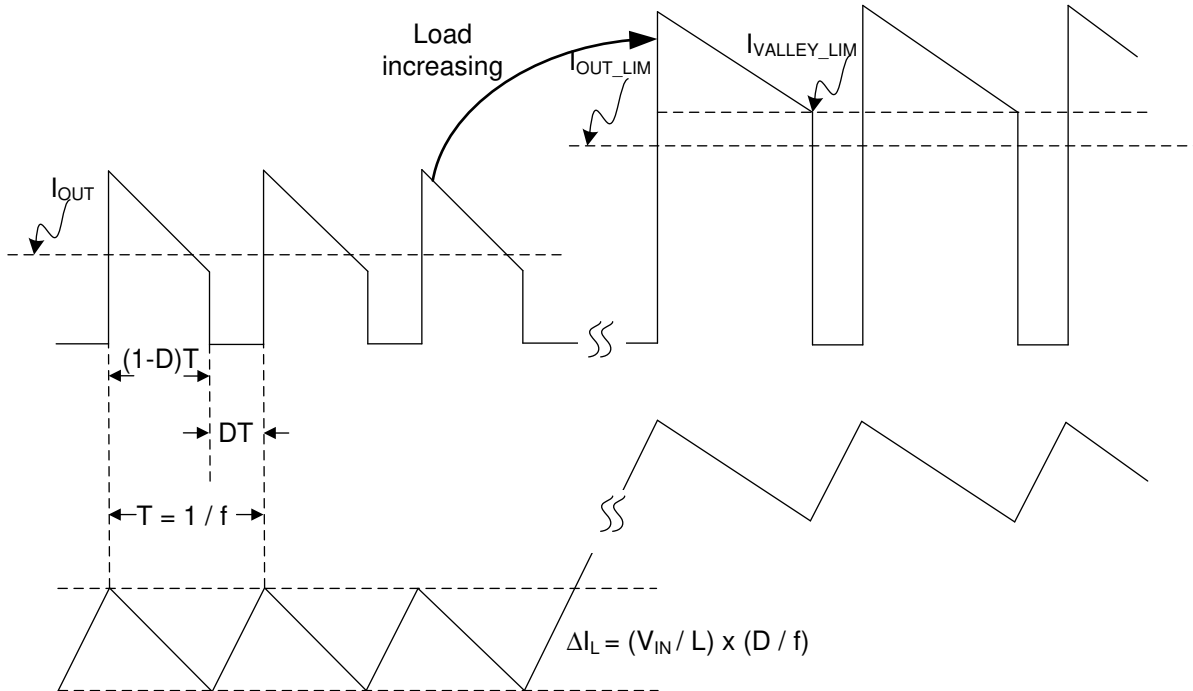

Figure 7-1. Current Limit Operation

If the output current is further increased and triggers the short protection threshold (typical 6A of inductor current), the TPS61253x enters hiccup mode. Once the hiccup is triggered, the device turns on the high-side FET for around 1ms with the pre-charge current limit and stops for around 20ms. The hiccup on / off cycle repeats again and again if the short condition is present. Figure 7-2 illustrates the TPS61253x working scheme of the hiccup mode. The average current and thermal will be much lowered at the hiccup steady state and the device can recover automatically as long as the short releases.

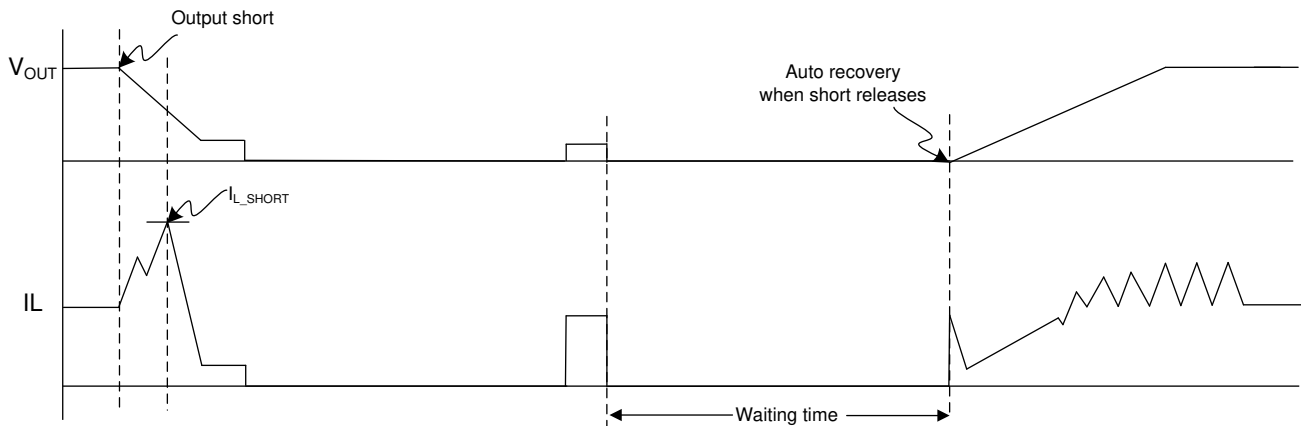

Figure 7-2. Hiccup Mode Short Protection

7.3.5 Load Disconnection

TPS61253x has load disconnection function. When the converter is disabled, it disconnects the output from the input of the power supply. If a battery is connected, this function also prevents the battery from discharging while the converter is off.

7.3.6 Thermal Shutdown

The TPS61253x has a built-in temperature sensor that monitors the internal junction temperature, T_J . If the junction temperature exceeds the threshold (typical 150°C), the device goes into thermal shutdown, and the

high-side and low-side FETs are turned off. When the junction temperature falls below the thermal shutdown falling threshold (typical 130°C), the device resumes the operation.

7.4 Device Functional Modes

7.4.1 Auto PFM Mode

The device integrates power save mode with pulse frequency modulation (Auto PFM) to improve the efficiency at the light load. At the light load operation, when the valley current of the inductor triggers the Auto PFM threshold, the device enters into Auto PFM mode operation. During the Auto PFM operation, the output voltage is regulated at typically 100.8% of voltage of the heavy load with the off-time extended to lower the switching frequency. The Auto PFM operation exists when valley current exceeds the Auto PFM threshold. Figure 7-3 shows the output voltage behavior of Auto PFM operation.

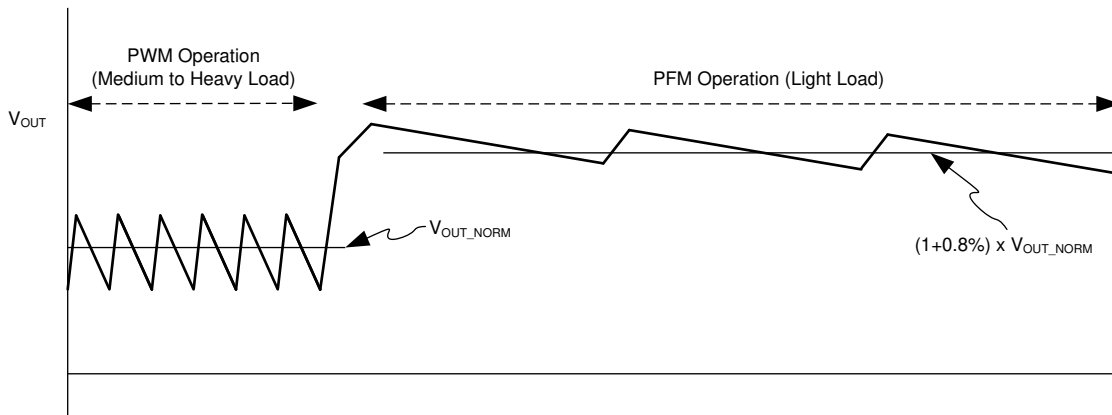

Figure 7-3. Output Voltage in Auto PFM / PWM Mode

7.4.2 Forced PWM Mode

In forced PWM mode, the TPS61253x keeps the switching frequency being constant for the whole load range. When the load current decreases, the output of the internal error amplifier decreases as well to lower the inductor peak current and delivers less power from input to output. The high-side FET is not turned off even if the current through the FET goes negative to keep the switching frequency being the same as that of the heavy load.

7.4.3 Ultrasonic Mode

The ultrasonic mode is an unique control feature that keeps the switching frequency above the acoustic audible frequency toward no load condition. The ultrasonic mode control circuit monitors the switching frequency and keeps the switching frequency above 25kHz to avoid the acoustic band. The output voltage becomes typically 1.6% higher than PWM operation. Figure 7-4 illustrates the details of ultrasonic mode operation.

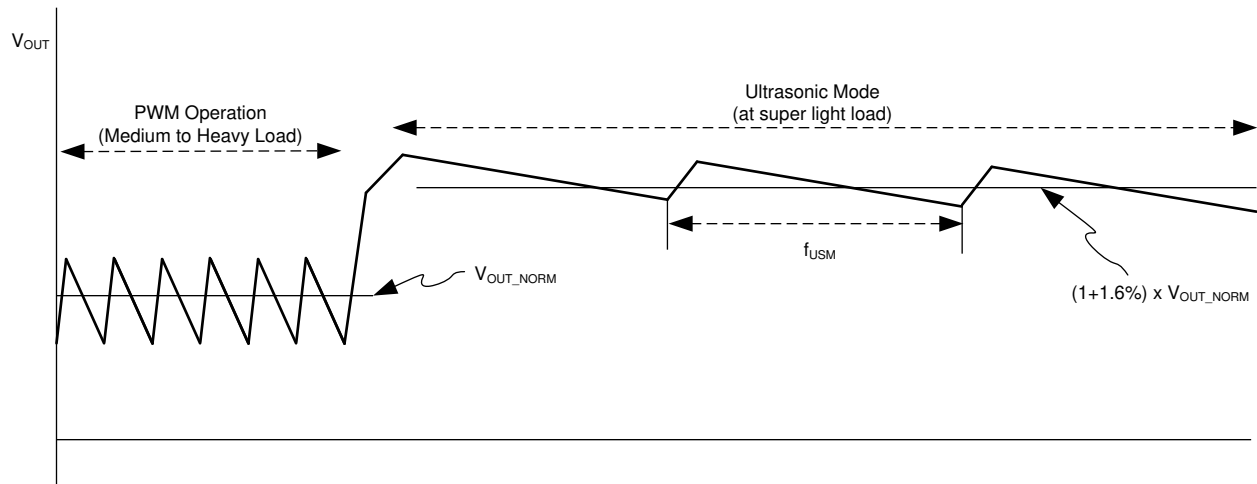

Figure 7-4. Ultrasonic Mode Operation

7.4.4 Pass-Through Mode

When the input voltage is higher than $V_{OUT} + 0.1V$ and V_{OUT} is higher than the nominal output voltage, the device automatically enters pass-through mode. In pass-through mode, the high-side FET is fully turned on and the low-side switch is turned off. The output voltage follows the input with the drop caused by the inductor resistance and the high-side FET resistance.

8 Application and Implementation

Note

Information in the following applications sections is not part of the TI component specification, and TI does not warrant its accuracy or completeness. TI's customers are responsible for determining suitability of components for their purposes, as well as validating and testing their design implementation to confirm system functionality.

8.1 Application Information

With a wide input voltage range, the TPS61253x supports applications powered by Li-Ion batteries with extended voltage range. Intended for the low-power applications, it supports up to 1500mA load current from a battery discharged as low as 3V and allows the use of low cost chip inductor and capacitors. The TPS61253x offers a very small solution size due to minimum amount of external components. It allows the use of small inductors and input capacitors to achieve a small solution size. During the pass-through mode, the output voltage is biased to the input voltage.

8.2 Typical Application

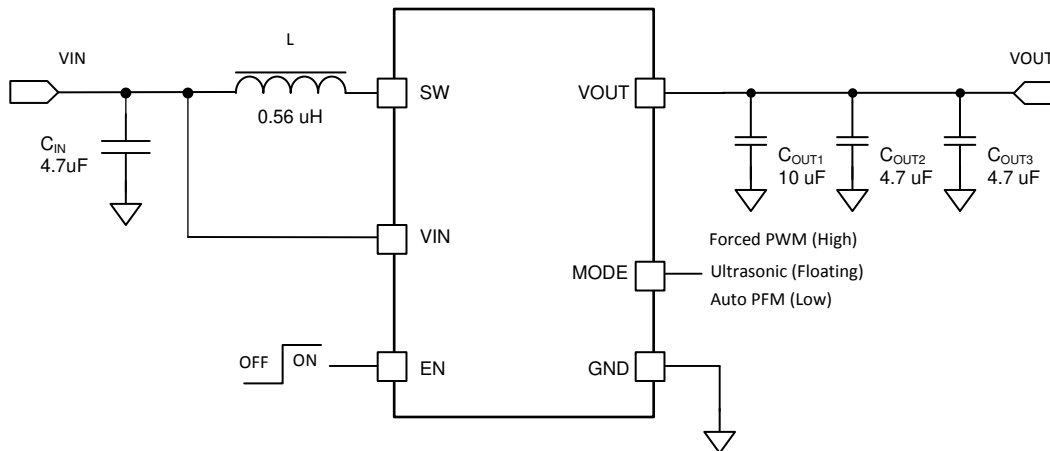

Figure 8-1. Typical Application Circuit

8.2.1 Design Requirements

In this example, TPS61253x is used to design a 5V output Boost converter. The TPS61253x can be powered by one-cell Li-ion battery. It supports up to 1500mA output current from the input voltage as low as 3V. During shutdown, the load is completely disconnected from the battery.

8.2.2 Detailed Design Procedure

8.2.2.1 Custom Design With WEBENCH® Tools

[Click here](#) to create a custom design using the TPS61253x device with the WEBENCH® Power Designer.

1. Start by entering the input voltage (V_{IN}), output voltage (V_{OUT}), and output current (I_{OUT}) requirements.
2. Optimize the design for key parameters such as efficiency, footprint, and cost using the optimizer dial.
3. Compare the generated design with other possible solutions from Texas Instruments.

The WEBENCH Power Designer provides a customized schematic along with a list of materials with real-time pricing and component availability.

In most cases, these actions are available:

- Run electrical simulations to see important waveforms and circuit performance
- Run thermal simulations to understand board thermal performance

- Export customized schematic and layout into popular CAD formats
- Print PDF reports for the design, and share the design with colleagues

Get more information about WEBENCH tools at www.ti.com/WEBENCH.

8.2.2.2 Inductor Selection

A boost converter normally requires two main passive components for storing energy during the conversion, an inductor and an output capacitor. It is advisable to select an inductor with a saturation current rating higher than the possible peak current flowing through the power switches.

The inductor peak current varies as a function of the load, the input and output voltages. It can be estimated using [Equation 4](#).

$$I_{L(\text{PEAK})} = \frac{V_{\text{IN}} \cdot D}{2 \cdot f \cdot L} + \frac{I_{\text{OUT}}}{(1-D)} \quad \text{with } D = 1 - \frac{V_{\text{IN}} \cdot \eta}{V_{\text{OUT}}} \quad (4)$$

Selecting an inductor with insufficient saturation current can lead to excessive peak current in the converter. This could eventually harm the device and reduce its reliability. When selecting the inductor, as well as the inductance, parameters of importance are: the maximum current rating, series resistance, and operating temperature. The inductor DC current rating should be greater (by some margin) than the maximum input average current, refer to [Equation 5](#) for more details.

$$I_{L(\text{DC})} = \frac{V_{\text{OUT}}}{V_{\text{IN}}} \cdot \frac{1}{\eta} \cdot I_{\text{OUT}} \quad (5)$$

The TPS61253x series of step-up converters could support operating with an effective inductance in the range of 0.33µH to 1.3µH and with effective output capacitance in the range of 3.5µF to 30µF. The internal compensation is optimized for an output filter of the inductance between 0.56µH and 1µH and output capacitance from 5µF to 10µF. Larger or smaller inductor and capacitor values can be used to optimize the performance of the device for specific operating conditions. For more details, see [Section 8.2.2.5](#).

In high-frequency converter applications, the efficiency is essentially affected by the inductor AC resistance (that is, quality factor) and to a smaller extent by the inductor DCR value. To achieve high efficiency operation, care should be taken in selecting inductors featuring a quality factor above 25 at the switching frequency. Increasing the inductor value produces lower RMS current, but degrades transient response. For a given physical inductor size, increased inductance usually results in an inductor with lower saturation current.

The total losses of the coil consist of both the losses in the DC resistance, R(DC), and the following frequency dependent components:

- The losses in the core material (magnetic hysteresis loss, especially at high switching frequencies)
- Additional losses in the conductor from the skin effect (current displacement at high frequencies)
- Magnetic field losses of the neighboring windings (proximity effect)
- Radiation losses

The following inductor series from different suppliers have been used with the TPS61253x converters.

Table 8-1. List of Inductors

| MANUFACTURER ⁽¹⁾ | SERIES | DESCRIPTION | DIMENSIONS (W × L × H) |
|-----------------------------|------------------|---|------------------------|
| Colicraft | XEL3515-561MEB | 0.56µH, 21.5mΩ DCR, 6.5A I _{sat} | 3.2mm × 3.5mm × 1.5mm |
| Murata | 1277AS-H-1R0M=P2 | 1µH, 34mΩ DCR, 4.6A I _{sat} | 3.2mm × 2.5mm × 1.2mm |

(1) See [Section 9.1.1](#).

8.2.2.3 Output Capacitor

For the output capacitor, it is recommended to use small ceramic capacitors placed as close as possible to the V_{OUT} and GND pins of the IC. If, for any reason, the application requires the use of large capacitors which cannot be placed close to the IC, using a smaller ceramic capacitor in parallel to the large one is highly recommended. This small capacitor should be placed as close as possible to the V_{OUT} and GND pins of the IC. To get an estimate of the recommended minimum output capacitance, [Equation 6](#) can be used.

$$C_{\text{MIN}} = \frac{I_{\text{OUT}} \cdot (V_{\text{OUT}} - V_{\text{IN}})}{f \cdot \Delta V \cdot V_{\text{OUT}}} \quad (6)$$

where

- f is the switching frequency which is 3.8MHz (typ.)
- ΔV is the maximum allowed output ripple

With a chosen ripple voltage of 25mV, a minimum effective capacitance of 7 μ F is needed for maximum 1500mA load. The capacitor can be smaller if the load is lower or the ripple can be larger. The total ripple is larger due to the ESR of the output capacitor. This additional component of the ripple can be calculated using [Equation 7](#)

$$V_{\text{ESR}} = I_{\text{OUT}} \cdot R_{\text{ESR}} \quad (7)$$

An MLCC capacitor with twice the value of the calculated minimum should be used due to DC bias effects. This is required to maintain control loop stability. The output capacitor requires either an X7R or X5R dielectric. Y5V and Z5U dielectric capacitors, aside from their wide variation in capacitance over temperature, become resistive at high frequencies. There are no additional requirements regarding minimum ESR. Larger capacitors cause lower output voltage ripple as well as lower output voltage drop during load transients but the total effective output capacitance value should not exceed ca. 30 μ F.

DC bias effect: high cap. ceramic capacitors exhibit DC bias effects, which have a strong influence on the effective capacitance of the device. Therefore, the right capacitor value has to be chosen very carefully. Package size and voltage rating in combination with material are responsible for differences between the rated capacitor value and effective capacitance. For instance, a 10 μ F X5R 6.3V 0603 MLCC capacitor would typically show an effective capacitance of less than 4 μ F under 5V bias condition.

8.2.2.4 Input Capacitor

Multilayer ceramic capacitors are an excellent choice for input decoupling of the step-up converter since they have extremely low ESR and are available in small footprints. Input capacitors should be located as close as possible to the device. While a 4.7 μ F input capacitor is sufficient for most applications, larger values can be used to reduce input current ripple without limitations.

Take care when using only ceramic input capacitors. When a ceramic capacitor is used at the input and the power is being supplied through long wires, such as from a wall adapter, a load step at the output can induce ringing at the V_{IN} pin. This ringing can couple to the output and be mistaken as loop instability or could even damage the part. Additional "bulk" capacitance (electrolytic or tantalum) should in this circumstance be placed between C_{IN} and the power source lead to reduce ringing that can occur between the inductance of the power source leads and C_{IN}.

8.2.2.5 Checking Loop Stability

The first step of circuit and stability evaluation is to look from a steady-state perspective at the following signals:

- Switching node, SW
- Inductor current, I_L
- Output ripple voltage, V_{OUT(AC)}

These are the basic signals that need to be measured when evaluating a switching converter. When the switching waveform shows large duty cycle jitter or the oscillation happens for the output voltage or inductor current, the regulation loop can be unstable. This is often a result of board layout, L-C combination, or both.

As a next step in the evaluation of the regulation loop, the load transient response is tested. The time between the application of the load transient and the turn on of the high-side FET, the output capacitor must supply all of the current required by the load. V_{OUT} immediately shifts by an amount equal to $\Delta I_{(LOAD)} \times ESR$, where ESR is the effective series resistance of C_{OUT} . $\Delta I_{(LOAD)}$ begins to charge or discharge C_{OUT} generating a feedback error signal used by the regulator to return V_{OUT} to its steady-state value. The results are most easily interpreted when the device operates in PWM mode.

During this recovery time, V_{OUT} can be monitored for settling time, overshoot, or ringing that helps judge the stability of the converter. Without any ringing, the loop has usually more than 45° of phase margin. Because the damping factor of the circuitry is directly related to several resistive parameters (for example, MOSFET $r_{DS(on)}$) that are temperature dependent, the loop stability analysis has to be done over the input voltage range, load current range, and temperature range.

8.2.2.6 Application Curves

This section is based on the test results of TPS61253A, unless otherwise noted.

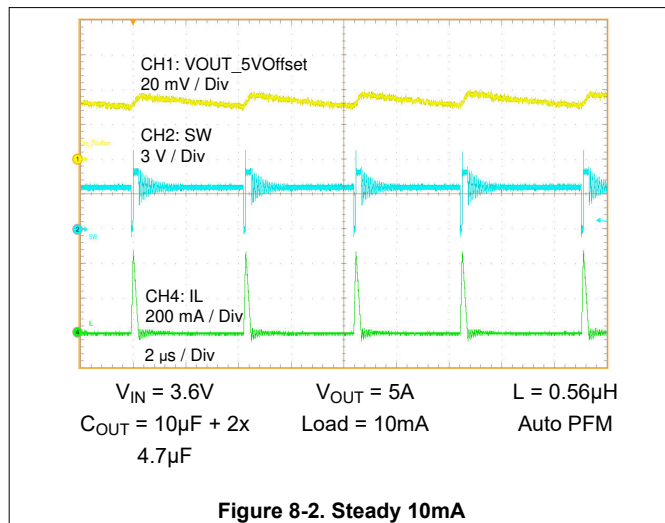

Figure 8-2. Steady 10mA

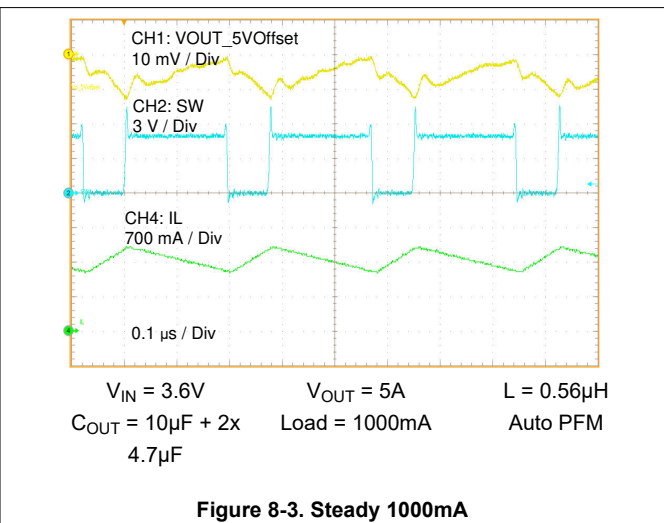

Figure 8-3. Steady 1000mA

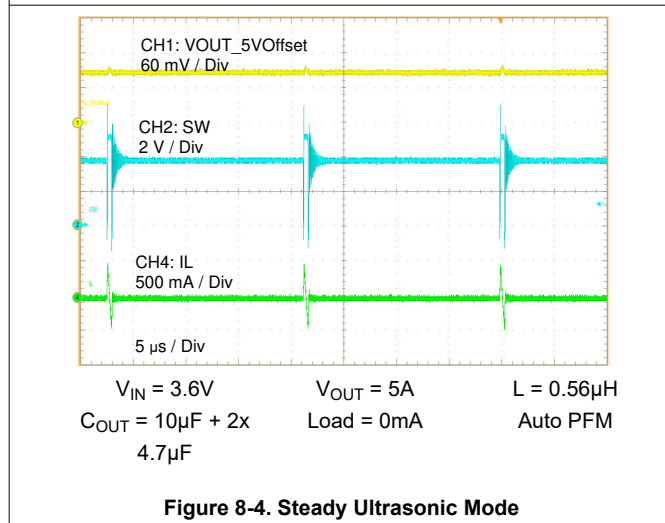

Figure 8-4. Steady Ultrasonic Mode

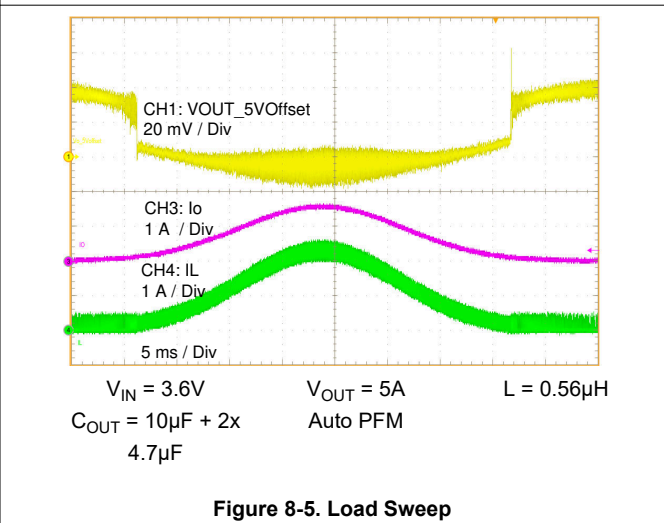

Figure 8-5. Load Sweep

8.2.2.6 Application Curves (continued)

This section is based on the test results of TPS61253A, unless otherwise noted.

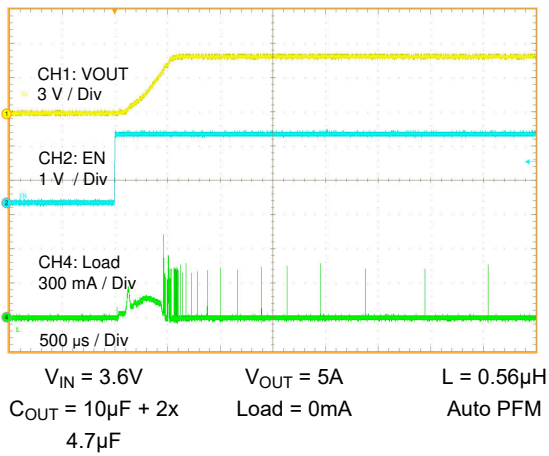

Figure 8-6. Start-up by EN

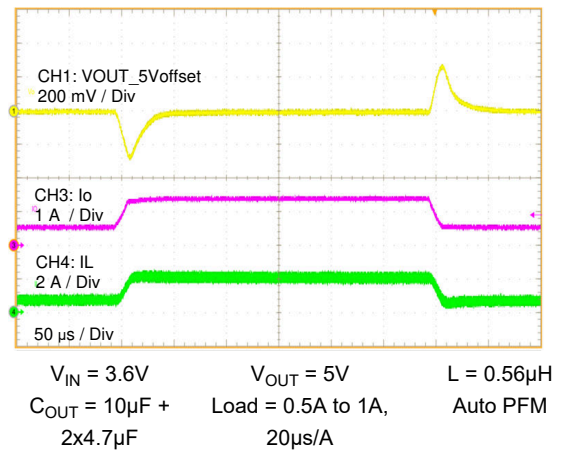

Figure 8-7. Load Transient

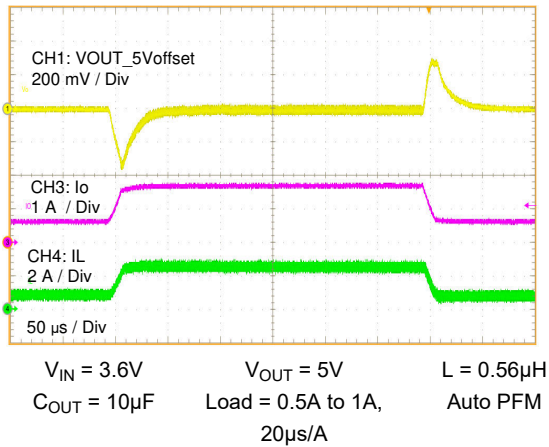

Figure 8-8. Load Transient with 10 μ F C_{OUT}

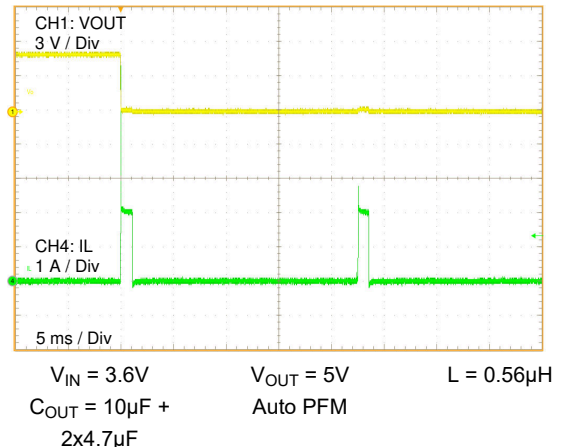

Figure 8-9. Short Output

8.2.3 System Examples

For the < 1000mA output current application, the output capacitors could be less. Figure 8-10 shows the typical application circuit for the lower current applications.

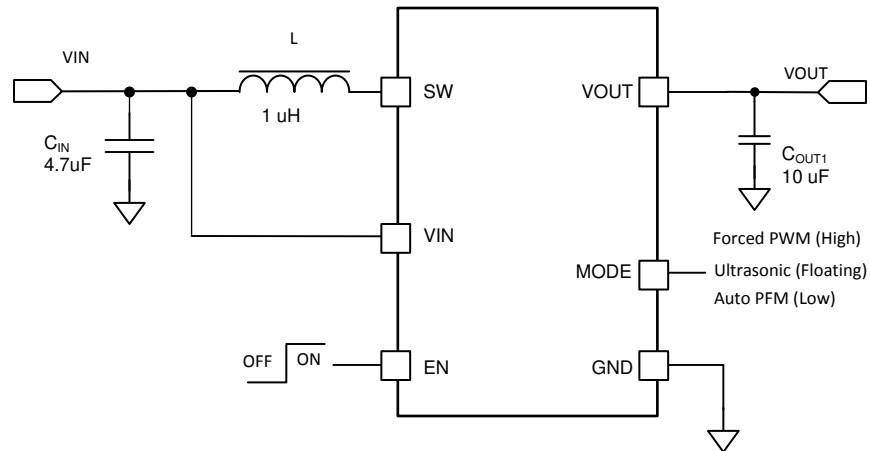

Figure 8-10. Typical Application with Minimum Output Capacitance

8.3 Power Supply Recommendations

The power supply can be three-cell alkaline, NiCd or NiMH, or one-cell Li-Ion or Li-Polymer battery. The input supply should be well regulated with the rating of TPS61253x. If the input supply is located more than a few inches from the device, additional bulk capacitance may be required in addition to the ceramic bypass capacitors. An electrolytic or tantalum capacitor with a value of 47µF is a typical choice.

8.4 Layout

8.4.1 Layout Guidelines

For all switching power supplies, the layout is an important step in the design, especially at high peak currents and high switching frequencies. If the layout is not carefully done, the regulator can show stability problems as well as EMI problems. Therefore, use wide and short traces for the main current path and for the power ground tracks. The input capacitor, output capacitor, and the inductor should be placed as close as possible to the IC. Use a common ground node for power ground and a different one for control ground to minimize the effects of ground noise. Connect these ground nodes at any place close to the ground pins of the IC.

8.4.2 Layout Example

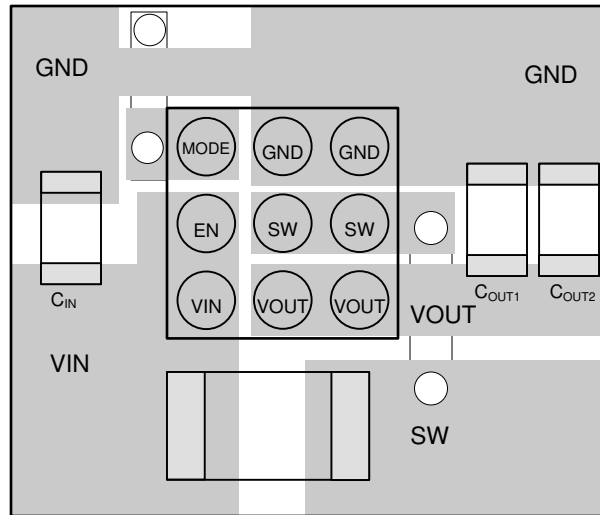

Figure 8-11. Recommended Layout

8.4.3 Thermal Considerations

Implementation of integrated circuits in low-profile and fine-pitch surface-mount packages typically requires special attention to power dissipation. Many system-dependent issues such as thermal coupling, airflow, added heat sinks and convection surfaces, and the presence of other heat-generating components affect the power-dissipation limits of a given component.

The following are three basic approaches for enhancing thermal performance:

- Improving the power dissipation capability of the PCB design
- Improving the thermal coupling of the component to the PCB
- Introducing airflow in the system

As power demand in portable designs is more and more important, designers must figure the best trade-off between efficiency, power dissipation and solution size. Due to integration and miniaturization, junction temperature can increase significantly which could lead to bad application behaviors (that is, premature thermal shutdown or worst case reduce device reliability).

Junction-to-ambient thermal resistance is highly dependent on application and board-layout. In applications where high maximum power dissipation exists, special care must be paid to thermal dissipation issues in board design. The device operating junction temperature (T_J) should be kept below 125°C.

9 Device and Documentation Support

9.1 Device Support

9.1.1 Third-Party Products Disclaimer

TI'S PUBLICATION OF INFORMATION REGARDING THIRD-PARTY PRODUCTS OR SERVICES DOES NOT CONSTITUTE AN ENDORSEMENT REGARDING THE SUITABILITY OF SUCH PRODUCTS OR SERVICES OR A WARRANTY, REPRESENTATION OR ENDORSEMENT OF SUCH PRODUCTS OR SERVICES, EITHER ALONE OR IN COMBINATION WITH ANY TI PRODUCT OR SERVICE.

9.1.2 Development Support

9.1.2.1 Custom Design With WEBENCH® Tools

[Click here](#) to create a custom design using the TPS61253x device with the WEBENCH® Power Designer.

1. Start by entering the input voltage (V_{IN}), output voltage (V_{OUT}), and output current (I_{OUT}) requirements.
2. Optimize the design for key parameters such as efficiency, footprint, and cost using the optimizer dial.
3. Compare the generated design with other possible solutions from Texas Instruments.

The WEBENCH Power Designer provides a customized schematic along with a list of materials with real-time pricing and component availability.

In most cases, these actions are available:

- Run electrical simulations to see important waveforms and circuit performance
- Run thermal simulations to understand board thermal performance
- Export customized schematic and layout into popular CAD formats
- Print PDF reports for the design, and share the design with colleagues

Get more information about WEBENCH tools at www.ti.com/WEBENCH.

9.2 Documentation Support

9.2.1 Related Documentation

For related documentation see the following:

TPS61253AEVM-803 User's Guide, [SLVUAP5](#)

9.3 Receiving Notification of Documentation Updates

To receive notification of documentation updates, navigate to the device product folder on ti.com. Click on *Notifications* to register and receive a weekly digest of any product information that has changed. For change details, review the revision history included in any revised document.

9.4 Support Resources

[TI E2E™ support forums](#) are an engineer's go-to source for fast, verified answers and design help — straight from the experts. Search existing answers or ask your own question to get the quick design help you need.

Linked content is provided "AS IS" by the respective contributors. They do not constitute TI specifications and do not necessarily reflect TI's views; see TI's [Terms of Use](#).

9.5 Trademarks

TI E2E™ is a trademark of Texas Instruments.

All trademarks are the property of their respective owners.

9.6 Electrostatic Discharge Caution



This integrated circuit can be damaged by ESD. Texas Instruments recommends that all integrated circuits be handled with appropriate precautions. Failure to observe proper handling and installation procedures can cause damage.

ESD damage can range from subtle performance degradation to complete device failure. Precision integrated circuits may be more susceptible to damage because very small parametric changes could cause the device not to meet its published specifications.

9.7 Glossary

[TI Glossary](#) This glossary lists and explains terms, acronyms, and definitions.

10 Revision History

NOTE: Page numbers for previous revisions may differ from page numbers in the current version.

| Changes from Revision E (June 2023) to Revision F (January 2026) | Page |
|---|-------------|
|---|-------------|

- | | |
|--|-------------------|
| • Added TPS61253F device..... | 1 |
| • Added explanation of the differences between TPS61253F, TPS61253A, TPS61253E and TPS612532A..... | 1 |
-

| Changes from Revision D (January 2021) to Revision E (June 2023) | Page |
|---|-------------|
|---|-------------|

- | | |
|----------------------------------|-------------------|
| • TPS61253E initial release..... | 1 |
|----------------------------------|-------------------|
-

| Changes from Revision C (November 2020) to Revision D (January 2021) | Page |
|---|-------------|
|---|-------------|

- | | |
|--|--------------------|
| • Adding HS FET to the functional block diagram..... | 12 |
|--|--------------------|
-

11 Mechanical, Packaging, and Orderable Information

The following pages include mechanical, packaging, and orderable information. This information is the most current data available for the designated devices. This data is subject to change without notice and revision of this document. For browser-based versions of this data sheet, refer to the left-hand navigation.

PACKAGING INFORMATION

| Orderable part number | Status (1) | Material type (2) | Package Pins | Package qty Carrier | RoHS (3) | Lead finish/ Ball material (4) | MSL rating/ Peak reflow (5) | Op temp (°C) | Part marking (6) |
|--------------------------------|---------------|----------------------|-----------------|-----------------------|-------------|--------------------------------------|-----------------------------------|--------------|---------------------|
| TPS612532AYFFR | Active | Production | DSBGA (YFF) 9 | 3000 LARGE T&R | Yes | SNAGCU | Level-1-260C-UNLIM | -40 to 125 | 2CHI |
| TPS612532AYFFR.A | Active | Production | DSBGA (YFF) 9 | 3000 LARGE T&R | Yes | SNAGCU | Level-1-260C-UNLIM | -40 to 125 | 2CHI |
| TPS61253AYFFR | Active | Production | DSBGA (YFF) 9 | 3000 LARGE T&R | Yes | SNAGCU | Level-1-260C-UNLIM | -40 to 85 | 17NI |
| TPS61253AYFFR.A | Active | Production | DSBGA (YFF) 9 | 3000 LARGE T&R | Yes | SNAGCU | Level-1-260C-UNLIM | -40 to 125 | 17NI |
| TPS61253AYFFT | Active | Production | DSBGA (YFF) 9 | 250 SMALL T&R | Yes | SNAGCU | Level-1-260C-UNLIM | -40 to 85 | 17NI |
| TPS61253AYFFT.A | Active | Production | DSBGA (YFF) 9 | 250 SMALL T&R | Yes | SNAGCU | Level-1-260C-UNLIM | -40 to 125 | 17NI |
| TPS61253EYFFR | Active | Production | DSBGA (YFF) 9 | 3000 LARGE T&R | Yes | SNAGCU | Level-1-260C-UNLIM | -40 to 125 | 32UH |
| TPS61253EYFFR.A | Active | Production | DSBGA (YFF) 9 | 3000 LARGE T&R | Yes | SNAGCU | Level-1-260C-UNLIM | -40 to 125 | 32UH |
| TPS61253FYFFR | Active | Production | DSBGA (YFF) 9 | 3000 LARGE T&R | - | SNAGCU | Level-1-260C-UNLIM | -40 to 125 | 3ZQH |

(1) **Status:** For more details on status, see our [product life cycle](#).

(2) **Material type:** When designated, preproduction parts are prototypes/experimental devices, and are not yet approved or released for full production. Testing and final process, including without limitation quality assurance, reliability performance testing, and/or process qualification, may not yet be complete, and this item is subject to further changes or possible discontinuation. If available for ordering, purchases will be subject to an additional waiver at checkout, and are intended for early internal evaluation purposes only. These items are sold without warranties of any kind.

(3) **RoHS values:** Yes, No, RoHS Exempt. See the [TI RoHS Statement](#) for additional information and value definition.

(4) **Lead finish/Ball material:** Parts may have multiple material finish options. Finish options are separated by a vertical ruled line. Lead finish/Ball material values may wrap to two lines if the finish value exceeds the maximum column width.

(5) **MSL rating/Peak reflow:** The moisture sensitivity level ratings and peak solder (reflow) temperatures. In the event that a part has multiple moisture sensitivity ratings, only the lowest level per JEDEC standards is shown. Refer to the shipping label for the actual reflow temperature that will be used to mount the part to the printed circuit board.

(6) **Part marking:** There may be an additional marking, which relates to the logo, the lot trace code information, or the environmental category of the part.

Multiple part markings will be inside parentheses. Only one part marking contained in parentheses and separated by a "-" will appear on a part. If a line is indented then it is a continuation of the previous line and the two combined represent the entire part marking for that device.

Important Information and Disclaimer: The information provided on this page represents TI's knowledge and belief as of the date that it is provided. TI bases its knowledge and belief on information provided by third parties, and makes no representation or warranty as to the accuracy of such information. Efforts are underway to better integrate information from third parties. TI has taken and continues to take reasonable steps to provide representative

and accurate information but may not have conducted destructive testing or chemical analysis on incoming materials and chemicals. TI and TI suppliers consider certain information to be proprietary, and thus CAS numbers and other limited information may not be available for release.

In no event shall TI's liability arising out of such information exceed the total purchase price of the TI part(s) at issue in this document sold by TI to Customer on an annual basis.

TAPE AND REEL INFORMATION

QUADRANT ASSIGNMENTS FOR PIN 1 ORIENTATION IN TAPE

*All dimensions are nominal

| Device | Package Type | Package Drawing | Pins | SPQ | Reel Diameter (mm) | Reel Width W1 (mm) | A0 (mm) | B0 (mm) | K0 (mm) | P1 (mm) | W (mm) | Pin1 Quadrant |
|----------------|--------------|-----------------|------|------|--------------------|--------------------|---------|---------|---------|---------|--------|---------------|
| TPS612532AYFFR | DSBGA | YFF | 9 | 3000 | 180.0 | 8.4 | 1.31 | 1.41 | 0.69 | 4.0 | 8.0 | Q1 |
| TPS61253AYFFR | DSBGA | YFF | 9 | 3000 | 180.0 | 8.4 | 1.31 | 1.41 | 0.69 | 4.0 | 8.0 | Q1 |
| TPS61253AYFFT | DSBGA | YFF | 9 | 250 | 180.0 | 8.4 | 1.31 | 1.41 | 0.69 | 4.0 | 8.0 | Q1 |
| TPS61253EYFFR | DSBGA | YFF | 9 | 3000 | 180.0 | 8.4 | 1.31 | 1.41 | 0.69 | 4.0 | 8.0 | Q1 |
| TPS61253FYFFR | DSBGA | YFF | 9 | 3000 | 180.0 | 8.4 | 1.31 | 1.41 | 0.69 | 4.0 | 8.0 | Q1 |

TAPE AND REEL BOX DIMENSIONS

*All dimensions are nominal

| Device | Package Type | Package Drawing | Pins | SPQ | Length (mm) | Width (mm) | Height (mm) |
|----------------|--------------|-----------------|------|------|-------------|------------|-------------|
| TPS612532AYFFR | DSBGA | YFF | 9 | 3000 | 182.0 | 182.0 | 20.0 |
| TPS61253AYFFR | DSBGA | YFF | 9 | 3000 | 182.0 | 182.0 | 20.0 |
| TPS61253AYFFT | DSBGA | YFF | 9 | 250 | 182.0 | 182.0 | 20.0 |
| TPS61253EYFFR | DSBGA | YFF | 9 | 3000 | 182.0 | 182.0 | 20.0 |
| TPS61253FYFFR | DSBGA | YFF | 9 | 3000 | 182.0 | 182.0 | 20.0 |

YFF0009

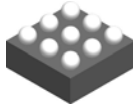

PACKAGE OUTLINE

DSBGA - 0.625 mm max height

DIE SIZE BALL GRID ARRAY

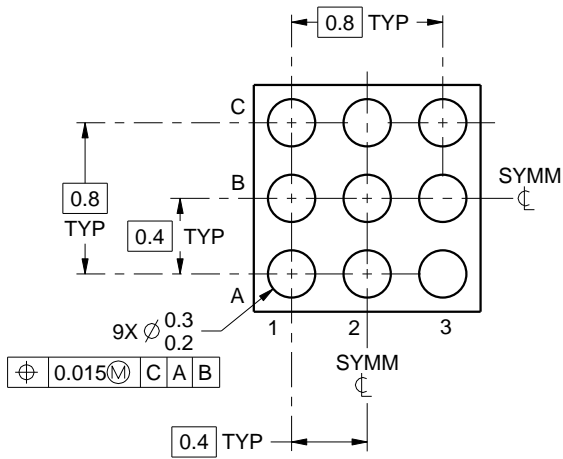
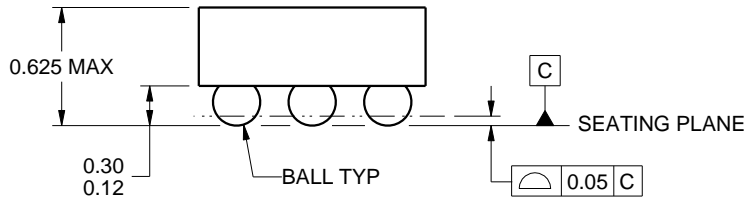
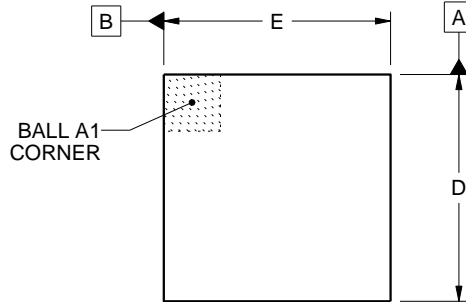

D: Max = 1.318 mm, Min = 1.258 mm
E: Max = 1.222 mm, Min = 1.162 mm

4219552/A 05/2016

NOTES:

- 1. All linear dimensions are in millimeters. Any dimensions in parenthesis are for reference only. Dimensioning and tolerancing per ASME Y14.5M.
- 2. This drawing is subject to change without notice.

EXAMPLE BOARD LAYOUT

YFF0009

DSBGA - 0.625 mm max height

DIE SIZE BALL GRID ARRAY

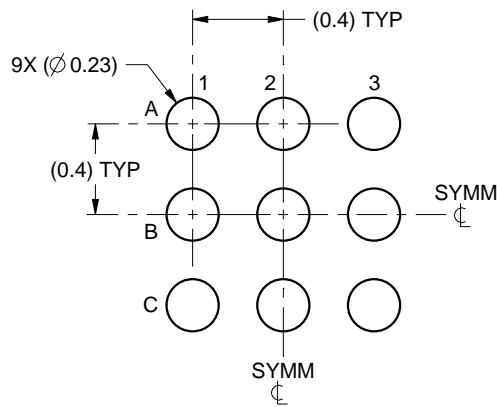

LAND PATTERN EXAMPLE
SCALE:30X

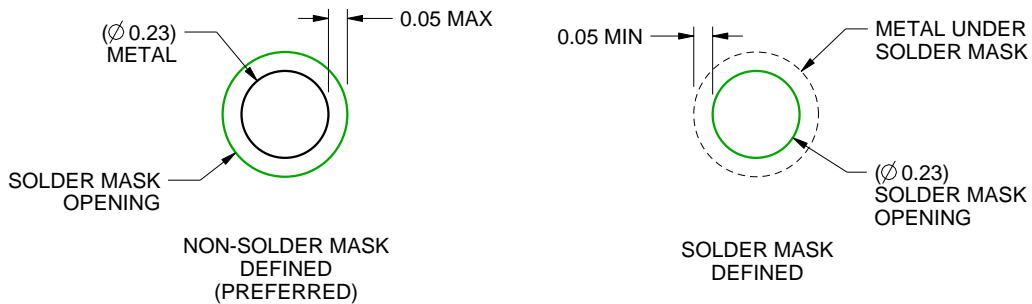

SOLDER MASK DETAILS
NOT TO SCALE

4219552/A 05/2016

NOTES: (continued)

3. Final dimensions may vary due to manufacturing tolerance considerations and also routing constraints. For more information, see Texas Instruments literature number SNVA009 (www.ti.com/lit/snva009).

EXAMPLE STENCIL DESIGN

YFF0009

DSBGA - 0.625 mm max height

DIE SIZE BALL GRID ARRAY

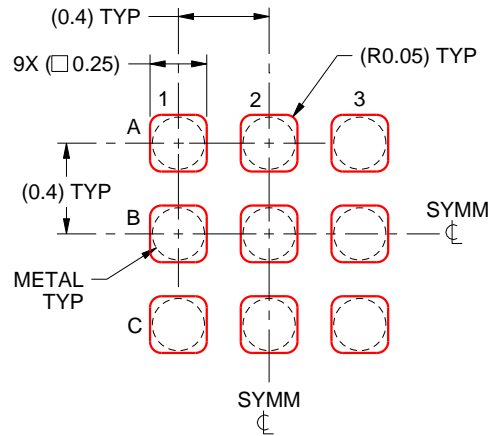

SOLDER PASTE EXAMPLE
BASED ON 0.1 mm THICK STENCIL
SCALE:30X

4219552/A 05/2016

NOTES: (continued)

4. Laser cutting apertures with trapezoidal walls and rounded corners may offer better paste release.

IMPORTANT NOTICE AND DISCLAIMER

TI PROVIDES TECHNICAL AND RELIABILITY DATA (INCLUDING DATASHEETS), DESIGN RESOURCES (INCLUDING REFERENCE DESIGNS), APPLICATION OR OTHER DESIGN ADVICE, WEB TOOLS, SAFETY INFORMATION, AND OTHER RESOURCES "AS IS" AND WITH ALL FAULTS, AND DISCLAIMS ALL WARRANTIES, EXPRESS AND IMPLIED, INCLUDING WITHOUT LIMITATION ANY IMPLIED WARRANTIES OF MERCHANTABILITY, FITNESS FOR A PARTICULAR PURPOSE OR NON-INFRINGEMENT OF THIRD PARTY INTELLECTUAL PROPERTY RIGHTS.

These resources are intended for skilled developers designing with TI products. You are solely responsible for (1) selecting the appropriate TI products for your application, (2) designing, validating and testing your application, and (3) ensuring your application meets applicable standards, and any other safety, security, regulatory or other requirements.

These resources are subject to change without notice. TI grants you permission to use these resources only for development of an application that uses the TI products described in the resource. Other reproduction and display of these resources is prohibited. No license is granted to any other TI intellectual property right or to any third party intellectual property right. TI disclaims responsibility for, and you fully indemnify TI and its representatives against any claims, damages, costs, losses, and liabilities arising out of your use of these resources.

TI's products are provided subject to [TI's Terms of Sale](#), [TI's General Quality Guidelines](#), or other applicable terms available either on [ti.com](#) or provided in conjunction with such TI products. TI's provision of these resources does not expand or otherwise alter TI's applicable warranties or warranty disclaimers for TI products. Unless TI explicitly designates a product as custom or customer-specified, TI products are standard, catalog, general purpose devices.

TI objects to and rejects any additional or different terms you may propose.

Copyright © 2026, Texas Instruments Incorporated

Last updated 10/2025