

TPS6286x 1.75V to 5.5V Input, 0.6/1A Synchronous Step-Down Converter With I²C/VSEL Interface

1 Features

- 2.3µA operating quiescent current
- Up to 4MHz switching frequency
- 1% output voltage accuracy
- DVS output from
 - 0.4V to 1.9875V (12.5mV steps)
- I²C user interface to adjust
 - Output voltage presets
 - Ramp speed
- VSEL pin to toggle output voltage during operation
- Power-good indication
- Supports < 6mm² design size
- Supports < 0.6mm design height
- Tiny, 8-pin, 0.35mm pitch WCSP package
- Optimized pinout to support 0201 components

2 Applications

- [Wearable electronics](#)
- [Portable electronics](#)
- [Mobile phones](#)
- [Medical sensor patches and patient monitors](#)

3 Description

The TPS6286x devices are high-frequency, synchronous step-down converters with I²C- and VSEL-Interface. The devices provide an efficient, flexible, and high-power density point-of-load DC/DC design. At medium to heavy loads, the converter operates in PWM mode and automatically enters Power Save Mode operation at light load to maintain high efficiency over the entire load current range. The device can also be forced in PWM mode operation for the smallest output voltage ripple. Together, with the DCS-Control architecture, excellent load transient performance and tight output voltage accuracy are achieved. With the I²C interface and a dedicated VSEL pin, the output voltage is quickly adjusted to adapt the power consumption of the load to the ever-changing performance needs of the application. The device family is available with two VSEL pins and four factory preset voltages to allow usage without I²C interface.

Device Information

PART NUMBER ⁽³⁾	CURRENT	PACKAGE ⁽¹⁾	PACKAGE SIZE ⁽²⁾
TPS62861	1A	YCH (DSBGA, 8)	1.40mm × 0.70mm
TPS62860	0.6A		

- (1) For more information, see [Section 12](#).
- (2) The package size (length × width) is a nominal value and includes pins, where applicable.
- (3) See the [Device Comparison Table](#).

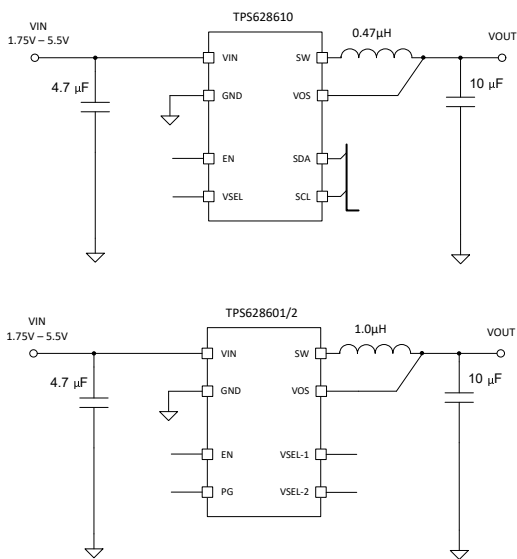

Typical Application

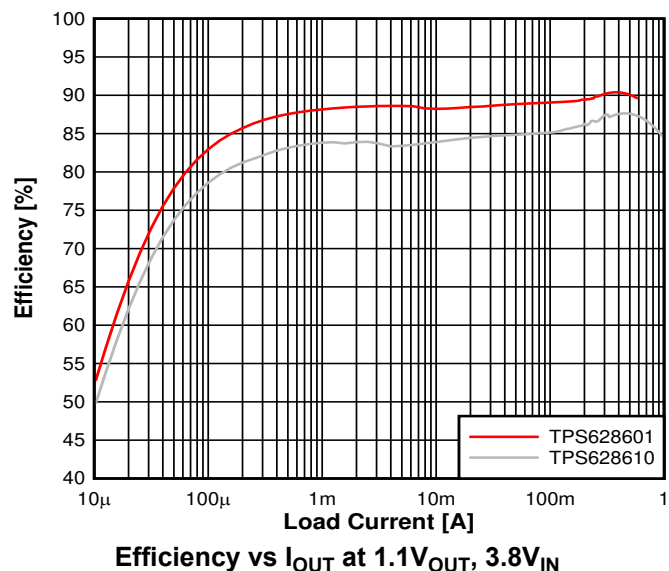

Table of Contents

1 Features	1	8.2 Register Address Byte.....	17
2 Applications	1	8.3 V _{OUT} Register 1.....	17
3 Description	1	8.4 V _{OUT} Register 2.....	18
4 Device Comparison Table	3	8.5 CONTROL Register.....	18
5 Pin Configuration and Functions	4	8.6 STATUS Register.....	19
6 Specifications	5	9 Application and Implementation	20
6.1 Absolute Maximum Ratings.....	5	9.1 Application Information.....	20
6.2 ESD Ratings.....	5	9.2 Typical Application, TPS628610.....	20
6.3 Recommended Operating Conditions.....	5	9.3 Typical Application, TPS628600, TPS62860x.....	26
6.4 Thermal Information.....	5	9.4 Power Supply Recommendations.....	27
6.5 Electrical Characteristics.....	6	9.5 Layout.....	27
6.6 I ² C Interface Timing Characteristics.....	7	10 Device and Documentation Support	28
6.7 Typical Characteristics.....	9	10.1 Device Support.....	28
7 Detailed Description	10	10.2 Receiving Notification of Documentation Updates..	28
7.1 Overview.....	10	10.3 Support Resources.....	28
7.2 Functional Block Diagram.....	10	10.4 Trademarks.....	28
7.3 Feature Description.....	11	10.5 Electrostatic Discharge Caution.....	28
7.4 Device Functional Modes.....	13	10.6 Glossary.....	28
7.5 Programming.....	14	11 Revision History	29
8 Register Map	17	12 Mechanical, Packaging, and Orderable Information	29
8.1 I2C Address Byte.....	17		

4 Device Comparison Table

ORDERABLE NUMBER	OUTPUT CURRENT (A)	DEFAULT V _{OUT} SETTING (V)	DEFAULT OPERATION	I2C ADDRESS	SWITCHING FREQUENCY f _{sw} (MHz)	USER INTERFACE
TPS628600YCH	0.6	0.6, 1.1	Normal (PWM, PFM) operation ⁽¹⁾	0x40	1.5	EN, I2C, VSEL
TPS628601YCH	0.6	0.6, 0.7, 0.8, 1.0	Normal (PWM, PFM) operation	0x40	1.5	2× VSEL, EN, PG
TPS628603YCH	0.6	1.05, 0.65	Normal (PWM, PFM) operation	0x40	1.5	EN, I2C, VSEL
TPS628604YCH	0.6	0.85, 1.1	Normal (PWM, PFM) operation	0x40	1.5	EN, I2C, VSEL
TPS628610YCH	1	0.6, 1.1	Normal (PWM, PFM) operation	0x40	4	EN, I2C, VSEL
TPS628605YCH	0.6	1.8, 1.8	VSEL = LOW (normal (PWM, PFM) operation), VSEL = HIGH (FPWM operation) ⁽²⁾	0x41	1.5	EN, I2C, VSEL
TPS628606YCH	0.6	1.0125, 1.0125	VSEL = LOW (normal (PWM, PFM) operation), VSEL = HIGH (FPWM operation)	0x40	1.5	EN, I2C, VSEL

- (1) Normal operation: default value of operation mode[7] of Vout Register 2 = 0 ([Table 8-3](#)).
(2) FPWM operation: default value of operation mode[7] of Vout Register 2 = 1 ([Table 8-3](#)).

5 Pin Configuration and Functions

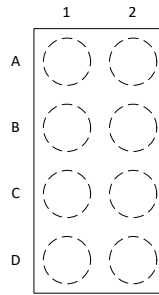

Figure 5-1. 8-Pin DSBGA YCH Package (Top View)

Table 5-1. Pin Functions, TPS628610, TPS628600, TPS628603, TPS628604, TPS628605, and TPS628606

PIN		TYPE	DESCRIPTION
NAME	NO.		
GND	D2	PWR	GND supply pin. Connect this pin close to the GND terminal of the input and output capacitor.
VOS	D1	IN	Output voltage sense pin for the internal feedback divider network and regulation loop. This pin also discharges V_{OUT} by an internal MOSFET when the converter is disabled. Connect this pin directly to the output capacitor with a short trace.
VIN	C2	PWR	V_{IN} power supply pin. Connect the input capacitor close to this pin for best noise and voltage spike suppression. A ceramic capacitor is required.
SW	C1	PWR	The switch pin is connected to the internal MOSFET switches. Connect the inductor to this terminal.
VSEL	B2	IN	Voltage selection pin. Can be toggled during operation. LOW = 0.6 V (TPS628600, TPS628610), 1.05 V (TPS628603), HIGH = 1.1 V (TPS628600, TPS628610), 0.65 V (TPS628603)
EN	B1	IN	A high level enables the devices and a low level turns the device off. The pin features an internal pulldown resistor, which is disabled after the device has started up.
SDA	A2	IN	I ² C serial data pin. Do not leave floating.
SCL	A1	IN	I ² C serial clock pin. Do not leave floating.

Table 5-2. Pin Functions, TPS628601

PIN		TYPE	DESCRIPTION
NAME	NO.		
GND	D2	PWR	GND supply pin. Connect this pin close to the GND terminal of the input and output capacitor.
VOS	D1	IN	Output voltage sense pin for the internal feedback divider network and regulation loop. This pin also discharges V_{OUT} by an internal MOSFET when the converter is disabled. Connect this pin directly to the output capacitor with a short trace.
VIN	C2	PWR	V_{IN} power supply pin. Connect the input capacitor close to this pin for best noise and voltage spike suppression. A ceramic capacitor is required.
SW	C1	PWR	The switch pin is connected to the internal MOSFET switches. Connect the inductor to this terminal.
PG	B2	OUT	Open-drain power-good output
EN	B1	IN	A high level enables the devices and a low level turns the device off. The pin features an internal pulldown resistor, which is disabled after the device has started up.
VSEL-1	A2	IN	Voltage Selection Pin. Can be toggled during operation.
VSEL-2	A1	IN	Voltage Selection Pin. Can be toggled during operation.

6 Specifications

6.1 Absolute Maximum Ratings

over operating free-air temperature range (unless otherwise noted) ⁽¹⁾

		MIN	MAX	UNIT
Pin voltage	VIN	-0.3	6	V
Pin voltage	SW, DC	-0.3	V _{IN} +0.3V	V
Pin voltage	SW, transient < 10 ns, while switching	-2.5	9	V
Pin voltage	EN, VSEL, SDA, SCL, PG	-0.3	6	V
Pin voltage	VOS	-0.3	5	V
T _J	Operating junction temperature	-40	150	°C
T _{stg}	Storage temperature	-55	150	°C

- (1) Stresses beyond those listed under *Absolute Maximum Ratings* may cause permanent damage to the device. These are stress ratings only, which do not imply functional operation of the device at these or any other conditions beyond those indicated under *Recommended Operating Conditions*. Exposure to absolute-maximum-rated conditions for extended periods may affect device reliability.

6.2 ESD Ratings

			VALUE	UNIT
V _(ESD)	Electrostatic discharge	Human-body model (HBM), per ANSI/ESDA/JEDEC JS-001 ⁽¹⁾	±2000	V
		Charged-device model (CDM), per ANSI/ESDA/JEDEC JS-002 ⁽²⁾	±500	

- (1) JEDEC document JEP155 states that 500-V HBM allows safe manufacturing with a standard ESD control process.
(2) JEDEC document JEP157 states that 250-V CDM allows safe manufacturing with a standard ESD control process.

6.3 Recommended Operating Conditions

Over operating junction temperature range (unless otherwise noted)

		MIN	NOM	MAX	UNIT
V _{IN}	Input supply voltage range	1.75		5.5	V
V _{OUT}	Output voltage range	0.4		1.9875	V
	Pin voltage	0		5.5	V
	Pin voltage	0		5.5	V
I _{OUT}	Output current range			1	A
I _{OUT}	Output current range			0.7	A
I _{OUT}	Output current range			0.6	A
I _{PG}	Power Good input current capability			1	mA
T _J	Operating junction temperature	-40		125	°C
C _{IN}	Effective Input Capacitance	2	4.7		µF
L	Effective Inductance	0.33	0.47	0.82	µH
CO _{UT}	Effective Output Capacitance	2		26	µF
L	Effective Inductance	0.7	1.0	1.2	µH
CO _{UT}	Effective Output Capacitance	3		26	µF

6.4 Thermal Information

THERMAL METRIC ⁽¹⁾		DEVICE	UNIT
		YCH (DSBGA)	
		8 PINS	
R _{θJA}	Junction-to-ambient thermal resistance	121.9	°C/W
R _{θJC(top)}	Junction-to-case (top) thermal resistance	1.1	°C/W
R _{θJB}	Junction-to-board thermal resistance	33.7	°C/W
ψ _{JT}	Junction-to-top characterization parameter	0.7	°C/W

6.4 Thermal Information (continued)

THERMAL METRIC ⁽¹⁾		DEVICE	UNIT
		YCH (DSBGA)	
		8 PINS	
Ψ_{JB}	Junction-to-board characterization parameter	33.5	°C/W

(1) For more information about traditional and new thermal metrics, see the [Semiconductor and IC Package Thermal Metrics](#) application note.

6.5 Electrical Characteristics

$T_J = -40^{\circ}\text{C}$ to $+125^{\circ}\text{C}$, $V_{IN} = 3.6\text{ V}$. Typical values are at $T_J = 25^{\circ}\text{C}$ (unless otherwise noted)

PARAMETER		TEST CONDITIONS	MIN	TYP	MAX	UNIT
SUPPLY						
$I_{Q(VIN)}$	VIN quiescent current	EN = VIN, IOU = 0 μ A, VOUT = 1.2 V device not switching, $T_J = -40^{\circ}\text{C}$ to $+85^{\circ}\text{C}$		2.3	4	μ A
		EN = VIN, IOU = 0 μ A, VOUT = 1.2 V, device switching		2.5		μ A
$I_{SD(VIN)}$	VIN shutdown supply current	EN = GND, shutdown current into VIN VSEL/MODE = GND, $T_J = -40^{\circ}\text{C}$ to $+85^{\circ}\text{C}$		120	250	nA
UVLO						
$V_{UVLO(R)}$	VIN UVLO rising threshold	V_{IN} rising		1.65	1.75	V
$V_{UVLO(F)}$	VIN UVLO falling threshold	V_{IN} falling		1.56	1.7	V
$V_{UVLO(H)}$	VIN UVLO hysteresis			100		mV
LOGIC PINS						
V_{IH}	High-level input voltage threshold		0.8			V
V_{IL}	Low-level input voltage threshold				0.4	V
I_{LKG}	Input leakage current into SDA, SCL, VSEL	Pin connected to VIN		10	25	nA
	EN internal pull-down resistance	EN pin to GND		0.5		M Ω
I_{LKG}	Input Leakage into EN	Pin connected to VIN		10	25	nA
VOUT VOLTAGE						
V_{OUT}	Output Voltage Accuracy	PWM Mode, no load, $T_J = 25^{\circ}\text{C}$ to 85°C	-1		+1	%
V_{OUT}	Output Voltage Accuracy	PWM Mode, no load, $T_J = -40^{\circ}\text{C}$ to 125°C	-2		+1.7	%
$I_{VOS(LKG)}$	VOS input leakage current	EN = VIN, VOUT = 1.2 V (internal 12M Ω resistor divider), $T_J = -40^{\circ}\text{C}$ to $+85^{\circ}\text{C}$		100	400	nA
SWITCHING FREQUENCY						
$f_{SW(FCCM)}$	Switching frequency, TPS62861x	VIN = 3.6V, VOUT = 1.2V, PWM operation		4		MHz
$f_{SW(FCCM)}$	Switching frequency, TPS62860x	VIN = 3.6V, VOUT = 1.2V, PWM operation		1.5		MHz
STARTUP						
	Internal fixed soft-start time	from VOUT = 0V to 95% of VOUT nominal		0.125	0.2	ms
	EN HIGH to start of switching delay			500	1000	μ s
POWER STAGE						
$R_{DS(ON)(HS)}$	High-side MOSFET on-resistance	IOU = 500 mA		120	170	m Ω
$R_{DS(ON)(LS)}$	Low-side MOSFET on-resistance	IOU = 500 mA		80	115	m Ω
OVERCURRENT PROTECTION						
$I_{HS(OC)}$	High-side peak current limit	TPS628610	1.3	1.45	1.55	A
$I_{LS(OC)}$	Low-side valley current limit	TPS628610	1.2	1.35	1.45	A
$I_{HS(OC)}$	High-side peak current limit	TPS628601	0.95	1.1	1.2	A
$I_{LS(OC)}$	Low-side valley current limit	TPS628601	0.85	1.0	1.1	A
$I_{LS(NOC)}$	Low-side negative current limit	Sinking current limit on LS FET		0.8		A
POWER GOOD						
V_{PGTH}	Power Good threshold	PGOOD low, VOS falling		93%		
V_{PGTH}	Power Good threshold	PGOOD high, VOS rising		96%		
$t_{PG,DLY}$	Power good deglitch delay	PG rising edge		16		μ s

6.5 Electrical Characteristics (continued)

$T_J = -40^{\circ}\text{C}$ to $+125^{\circ}\text{C}$, $V_{IN} = 3.6\text{ V}$. Typical values are at $T_J = 25^{\circ}\text{C}$ (unless otherwise noted)

PARAMETER		TEST CONDITIONS	MIN	TYP	MAX	UNIT
$I_{PG,LKG}$	Input leakage current into PG-pin	$V_{PG} = 5.0\text{V}$		10	100	nA
	PG-pin output low-level voltage	$I_{PG} = 1\text{mA}$			400	mV
OUTPUT DISCHARGE						
	Output discharge resistor on VOS pin	EN = GND, IVOS = -10 mA into VOS pin $T_J = -40^{\circ}\text{C}$ to $+85^{\circ}\text{C}$		7	11	Ω
THERMAL SHUTDOWN						
$T_{J(SD)}$	Thermal shutdown threshold ⁽¹⁾	Temperature rising, PWM Mode		160		$^{\circ}\text{C}$
$T_{J(HYS)}$	Thermal shutdown hysteresis ⁽¹⁾			20		$^{\circ}\text{C}$

(1) Specified by design. Not production tested.

6.6 I²C Interface Timing Characteristics

PARAMETER		TEST CONDITIONS	MIN	TYP	MAX	UNIT
f_{SCL}	SCL Clock Frequency	Standard mode			100	kHz
		Fast mode			400	kHz
		Fast mode plus			1	MHz
t_{BUF}	Bus Free Time Between a STOP and START Condition	Standard mode	4.7			μs
		Fast mode	1.3			μs
		Fast mode plus	0.5			μs
t_{HD}, t_{STA}	Hold Time (Repeated) START condition	Standard mode	4			μs
		Fast mode	600			ns
		Fast mode plus	260			ns
t_{LOW}	LOW Period of the SCL Clock	Standard mode	4.7			μs
		Fast mode	1.3			μs
		Fast mode plus	0.5			μs
t_{HIGH}	HIGH Period of the SCL Clock	Standard mode	4			μs
		Fast mode	600			ns
		Fast mode plus	260			ns
t_{SU}, t_{STA}	Setup Time for a Repeated START Condition	Standard mode	4.7			μs
		Fast mode	600			ns
		Fast mode plus	260			ns
t_{SU}, t_{DAT}	Data Setup Time	Standard mode	250			ns
		Fast mode	100			ns
		Fast mode plus	50			ns
t_{HD}, t_{DAT}	Data Hold Time	Standard mode	0		3.45	μs
		Fast mode	0		0.9	μs
		Fast mode plus	0			μs
t_{RCL}	Rise Time of SCL Signal	Standard mode			1000	ns
		Fast mode	$20+0.1C_B$		300	ns
		Fast mode plus			120	ns
t_{RCL1}	Rise Time of SCL Signal After a Repeated START Condition and After an Acknowledge BIT	Standard mode	$20+0.1C_B$		1000	ns
		Fast mode	$20+0.1C_B$		300	ns
		Fast mode plus			120	ns

6.6 I²C Interface Timing Characteristics (continued)

PARAMETER		TEST CONDITIONS	MIN	TYP	MAX	UNIT
t _{FCL}	Fall Time of SCL Signal	Standard mode	20+0.1C B		300	ns
		Fast mode			300	ns
		Fast mode plus			120	ns
t _{RDA}	Rise Time of SDA Signal	Standard mode			1000	ns
		Fast mode	20+0.1C B		300	ns
		Fast mode plus			120	ns
t _{FDA}	Fall Time of SDA Signal	Standard mode			300	ns
		Fast mode	20+0.1C B		300	ns
		Fast mode plus			120	ns
t _{SU} , t _{STO}	Setup Time of STOP Condition	Standard mode	4			µs
		Fast mode	600			ns
		Fast mode plus	260			ns
CB	Capacitive Load for SDA and SCL	Standard mode			400	pF
		Fast mode			400	pF
		Fast mode plus			550	pF

6.7 Typical Characteristics

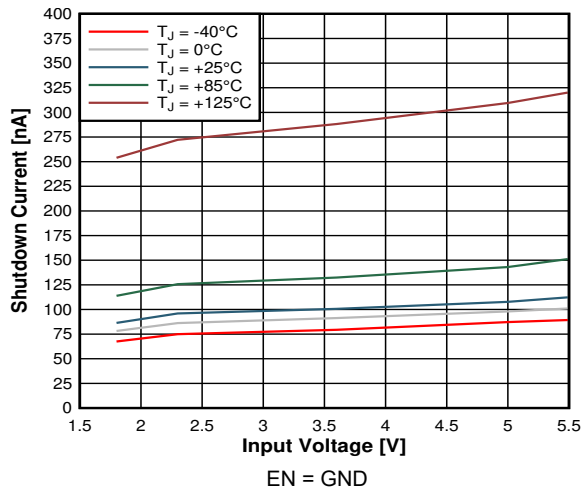

Figure 6-1. Shutdown Current I_{SD}

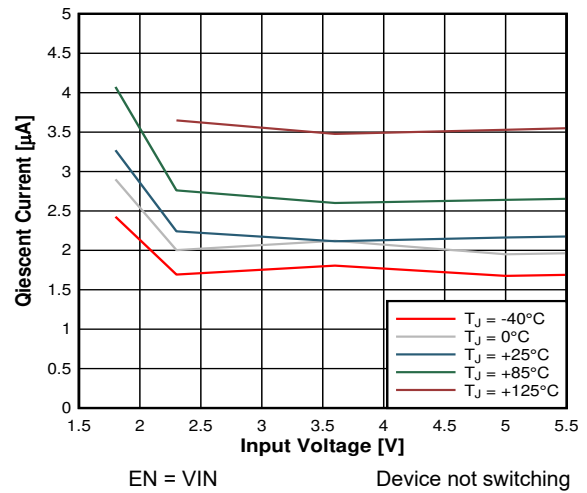

Figure 6-2. Quiescent Current I_Q

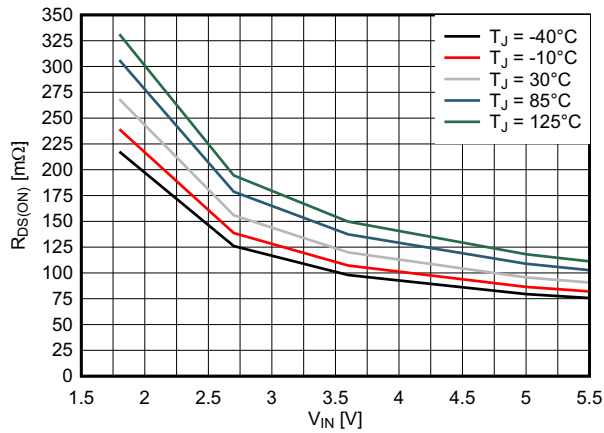

Figure 6-3. High-side Switch Drain Source Resistance $R_{DS(ON)}$

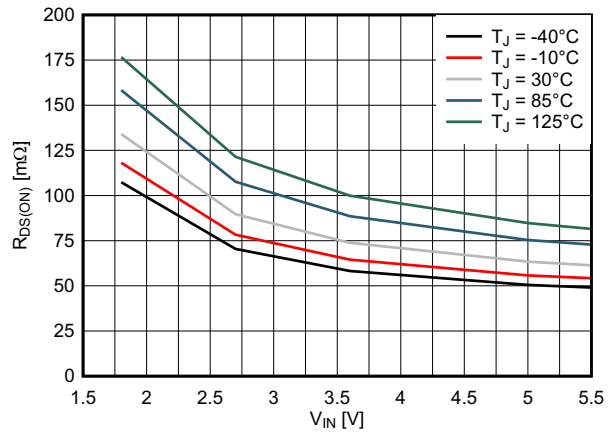

Figure 6-4. Low-side Switch Drain Source Resistance $R_{DS(ON)}$

7 Detailed Description

7.1 Overview

The TPS6286x is a high-frequency synchronous step-down converter with ultra-low quiescent current consumption and flexible output voltage by I²C or VSEL interface. Using TI's DCS-Control topology, the device extends the high efficiency operation area down to microamperes of load current during Power Save Mode Operation. TI's DCS-Control (direct control with seamless transition into power save mode) is an advanced regulation topology, which combines the advantages of hysteretic and voltage mode control. Characteristics of DCS-Control are excellent AC load regulation and transient response, low output ripple voltage, and a seamless transition between PFM and PWM mode operation. DCS-Control includes an AC loop which senses the output voltage (VOS pin) and directly feeds the information to a fast comparator stage. This comparator sets the switching frequency, which is constant for steady state operating conditions, and provides immediate response to dynamic load changes. To achieve accurate DC load regulation, a voltage feedback loop is used. The internally compensated regulation network achieves fast and stable operation with small external components and low ESR capacitors.

7.2 Functional Block Diagram

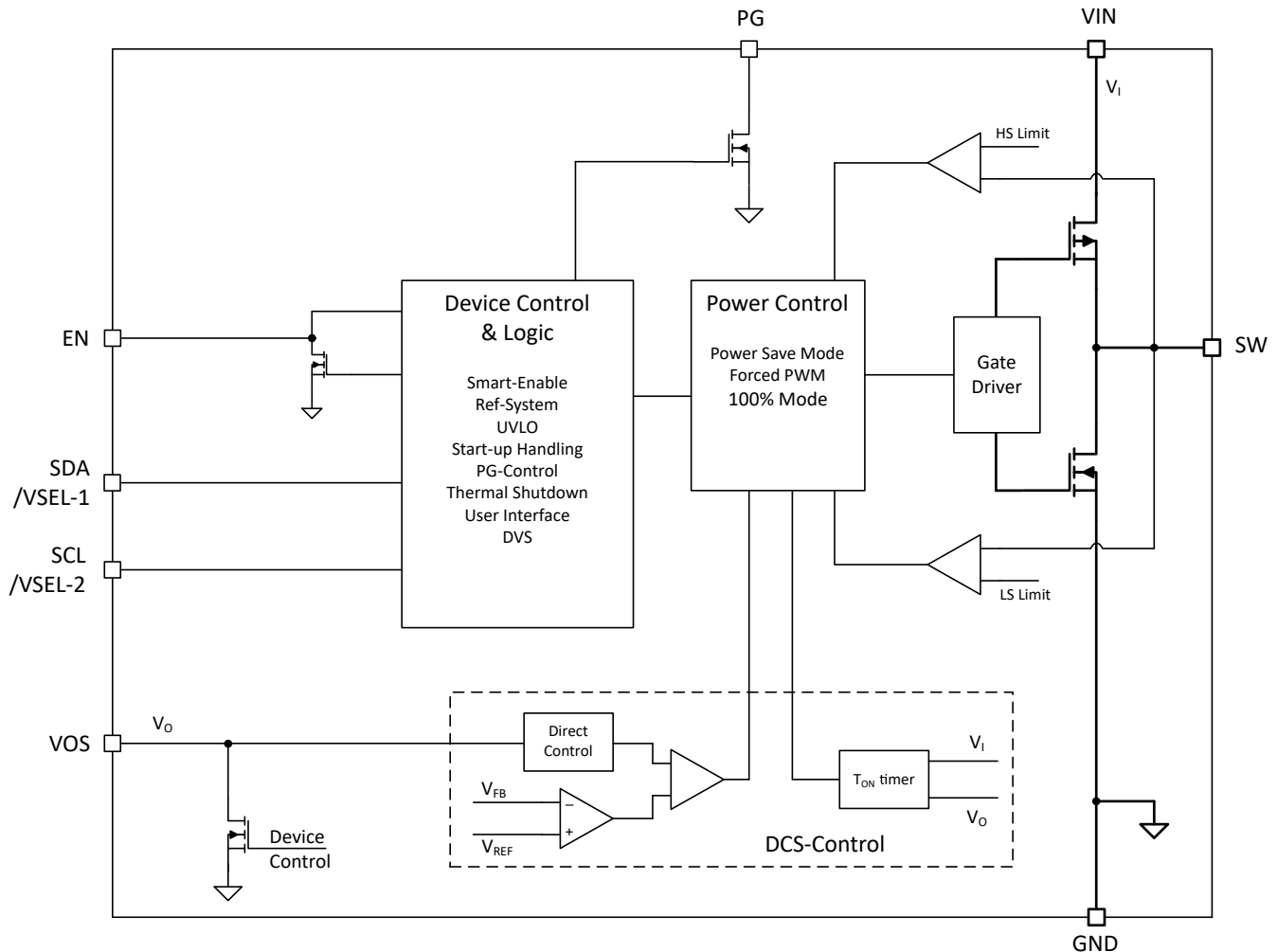

7.3 Feature Description

7.3.1 Soft Start

After the device has been enabled with EN high, it initializes and powers up the internal circuits. This occurs during the regulator start-up delay time, t_{Delay} . After t_{Delay} expires, the internal soft-start circuitry ramps up the output voltage within the soft-start time, t_{Ramp} . See [Figure 7-1](#).

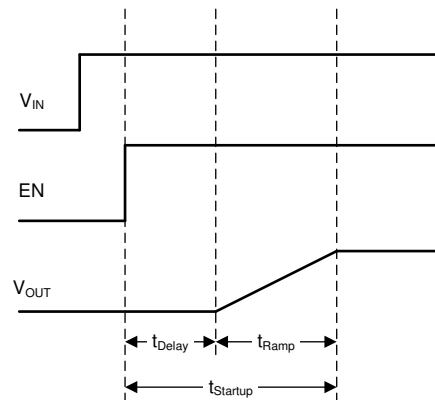

Figure 7-1. Start-up Sequence

7.3.2 Output Voltage Selection (VSEL) for TPS62860x

The optional VSEL Interface allows setting the output voltage by a 2-pin HIGH/LOW setting. Using and applying a digital pattern to the "VSEL-1" and "VSEL-2" pins sets the output voltage according to [Table 7-1](#).

Table 7-1. Target Output Voltage Setting by VSEL Interface

VSEL-2	VSEL-1	TPS628601	TPS628602	OPERATION MODE
0	0	0.6 V	1.05 V	PFM Mode
0	1	0.7 V	0.9 V	PFM Mode
1	0	0.8 V	0.875 V	PFM Mode
1	1	1.0 V	0.625 V	PFM Mode

7.3.3 Output Voltage Selection (VSEL and I²C)

The TPS6286x has two options to select the output voltage.

The voltage on the VSEL pin can change the output voltage. Putting this pin HIGH selects the output voltage according to V_{OUT} register 2. Putting this pin LOW selects the voltage according to V_{OUT} Register 1. The pin can be toggled during operation.

The pin can also be selected by the value in the V_{OUT} register that is chosen by VSEL at the moment. The voltage changes right after the I²C command is received.

7.3.4 Undervoltage Lockout (UVLO)

To avoid misoperation of the device at low input voltages, an undervoltage lockout (UVLO) comparator monitors the supply voltage. The UVLO comparator shuts down the device at an input voltage of 1.7 V (maximum) with falling V_{IN} . The device starts at an input voltage of 1.8 V (maximum) rising V_{IN} . After the device re-enters operation out of an undervoltage lockout condition, the device behaves like being enabled.

7.3.5 Power Good (PG)

The built-in power-good (PG) signal indicates that the output voltage has reached the target and the device is ready. The PG signal can be used for start-up sequencing of multiple rails or to indicate any overload behavior on the output. The PG pin is an open-drain output that requires a pullup resistor to any voltage up to the recommended input voltage level. PG is low when the device is turned off due to EN or thermal shutdown. V_{IN}

must remain present for the PG pin to stay LOW. When applying V_{IN} the first time, PG stays HIGH until the first enabling of the device.

If the power-good output is not used, TI recommends to tie to GND or leave open.

Table 7-2. Power Good Indicator Functional Table

LOGIC SIGNALS					PG STATUS
V_I	EN-PIN	THERMAL SHUTDOWN	V_{OUT}	DVS TRANSITION ACTIVE	
$V_I > UVLO$	HIGH	NO	V_{OUT} on target	NO	High Impedance
			$V_{OUT} < target$	YES	LOW
	LOW	x	x	x	LOW
				x	LOW
$V_I < UVLO$	x	x	x	x	Undefined

The PG indicator triggers immediately (after internal comparator delay) when V_O crosses the lower V_{PGTH} to indicate that the voltage has left the target setting. It features a delay after crossing the upper V_{PGTH} when going high to make sure V_O has reached the target again. [Figure 7-2](#) sketches the behavior.

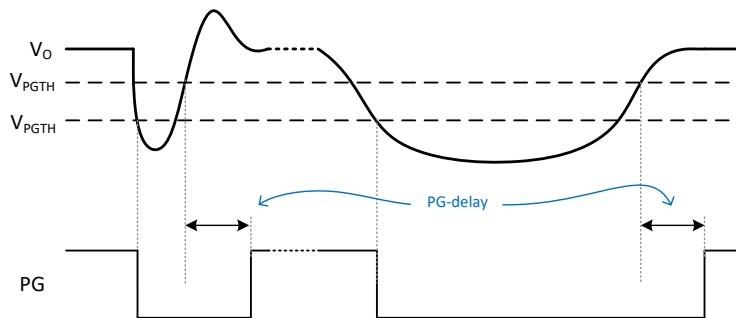

Figure 7-2. Power Good Transient and De-glitch Behavior

The PG Indicator is by default pulled low during DVS transition of the output voltage without any blanking or delay time. [Figure 7-2](#) shows an example of this behavior. After V_O has reached the new target, the PG is again active as shown in [Figure 7-2](#).

7.3.6 Switch Current Limit and Short Circuit Protection

The TPS6286x integrates a current limit on the high-side and low-side MOSFETs to protect the converter against overload or short-circuit conditions. The current in the switches is monitored cycle by cycle. If the high-side MOSFET current limit, I_{LIMF} , trips, the high-side MOSFET is turned off and the low-side MOSFET is turned on to ramp down the inductor current. After the inductor current through the low-side switch decreases below the low-side MOSFET current limit, I_{LIMF} , the low-side MOSFET is turned off and the high-side MOSFET turns on again.

7.3.7 Thermal Shutdown

The junction temperature (T_J) of the device is monitored by an internal temperature sensor. If T_J exceeds the thermal shutdown temperature TSD of 160°C (typ), the device enters thermal shutdown. Both the high-side and low-side power FETs are turned off. When T_J decreases below the hysteresis amount of typically 20°C, the converter resumes operation, beginning with a soft start to the originally set V_{OUT} . The thermal shutdown is not active in Power Save Mode.

7.3.8 Output Voltage Discharge

The purpose of the output discharge function is to make sure a defined down-ramp of the output voltage when the device is disabled and to keep the output voltage close to 0 V. The output discharge feature is only active

after the device has been enabled at least once since the supply voltage was applied. The output discharge function is not active if the device is disabled and the supply voltage is applied the first time. The internal discharge resistor is connected to the VOS pin. The discharge function is enabled as soon as the device is disabled. The minimum supply voltage required to keep the discharge function active is $V_I > V_{TH_UVLO}$.

7.4 Device Functional Modes

7.4.1 Smart Enable and Shutdown (EN)

An internal 500-k Ω resistor pulls the EN pin to GND and avoids the pin to be floating. This prevents an uncontrolled start-up of the device in case the EN pin cannot be driven to low level safely. With EN low, the device is in shutdown mode. The device is turned on with EN set to a high level. The pulldown control circuit disconnects the pulldown resistor on the EN pin after the internal control logic and the reference have been powered up. With EN set to a low level, the device enters shutdown mode and the pulldown resistor is activated again.

7.4.2 Forced PWM Operation

Through I²C, set the device in forced PWM (FPWM) mode by the CONTROL register. The device switches continuously, even with a light load. This reduces the output voltage ripple and allows simple filtering of the switching frequency for noise-sensitive applications. Efficiency at light load is lower in FPWM mode.

7.4.3 Forced PWM Mode During Output Voltage Change

In normal operation, the device does not force PWM operation during VOUT change after VSEL toggle or I²C command. For ramping down, this mode provides the remaining energy, stored in the output capacitor to the load of the DC/DC and save battery charge. See [Figure 9-14](#).

Through I²C, the device can be set to forced PWM (FPWM) switching during output voltage change. This allows a controlled ramp of V_{OUT} up and especially down, regardless of the load condition. See [Figure 9-15](#).

This feature follows the internal I²C ramp and is only recommended for the setting 1 mV/ μ s and 0.1 mV/ μ s. During the faster slopes (10 mV/ μ s and 5 mV/ μ s), the mode is likely to be left before the voltage reached the new target value.

7.4.4 Power Save Mode

As the load current decreases, the device enters Power Save Mode (PSM) operation. PSM occurs when the inductor current becomes discontinuous, which is when the inductor current reaches 0 A during a switching cycle. In power save mode, the output voltage rises slightly above the nominal output voltage. This effect is minimized by increasing the output capacitor or inductor value.

7.5 Programming

7.5.1 Serial Interface Description

I²C™ is a 2-wire serial interface developed by Philips Semiconductor, now NXP Semiconductors (see I²C-Bus Specification, Version .6, 2014). The bus consists of a data line (SDA) and a clock line (SCL) with pullup structures. When the bus is *idle*, both SDA and SCL lines are pulled high. All the I²C-compatible devices connect to the I²C bus through open-drain I/O pins, SDA and SCL. A *controller* device, usually a microcontroller or a digital signal processor, controls the bus. The controller is responsible for generating the SCL signal and device addresses. The controller also generates specific conditions that indicate the START and STOP of data transfer. A *target* device receives, transmits data, or both on the bus under control of the controller device.

The TPS6286x device works as a *target* and supports the following data transfer *modes*, as defined in the I²C-Bus Specification: standard mode (100 kbps), fast mode (400 kbps), and fast mode plus (1 Mbps). The interface adds flexibility to the power supply solution, enabling most functions to be programmed to new values depending on the instantaneous application requirements. Register contents remain intact as long as the input voltage remains above 1.8 V.

The data transfer protocol for standard and fast modes is exactly the same, therefore, the modes are referred to as F/S-mode in this document. The protocol for high-speed mode is different and must not be used.

TI recommends that the I²C controller initiates a STOP condition on the I²C bus after the initial power up of SDA and SCL pullup voltages to make sure of reset of the I²C engine.

7.5.2 Standard- and Fast-Mode Protocol

The controller initiates data transfer by generating a start condition. The start condition is when a high-to-low transition occurs on the SDA line while SCL is high, as shown in Figure 7-3. All I²C-compatible devices recognize a start condition.

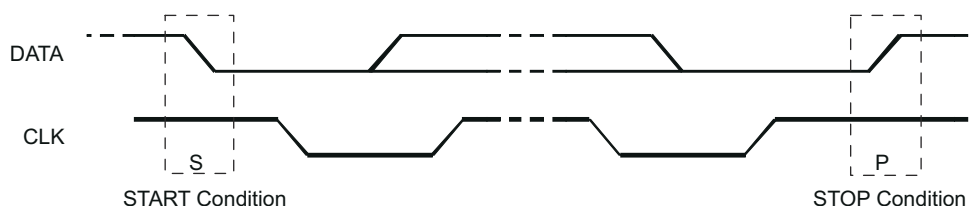

Figure 7-3. START and STOP Conditions

The controller then generates the SCL pulses, and transmits the 7-bit address and the read/write direction bit R/W on the SDA line. During all transmissions, the controller makes sure that data is valid. A valid data condition requires the SDA line to be stable during the entire high period of the clock pulse (see Figure 7-4). All devices recognize the address sent by the controller and compare to the internal fixed addresses. Only the target device with a matching address generates an acknowledge (see Figure 7-5) by pulling the SDA line low during the entire high period of the ninth SCL cycle. Upon detecting this acknowledge, the controller knows that communication link with a target has been established.

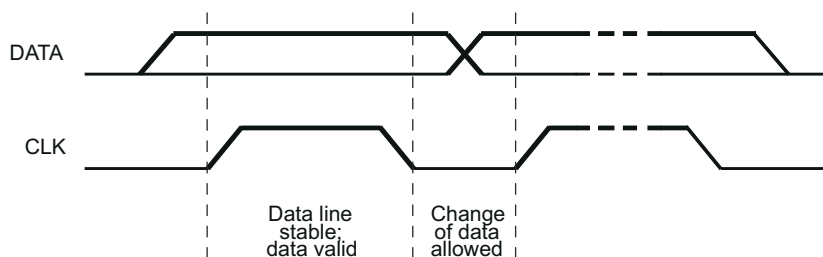

Figure 7-4. Bit Transfer on the Serial Interface

The controller generates further SCL cycles to either transmit data to the target (R/W bit 1) or receive data from the target (R/W bit 0). In either case, the receiver must acknowledge the data sent by the transmitter. An acknowledge signal can either be generated by the controller or by the target, depending on which one is the receiver. 9-bit valid data sequences consisting of 8-bit data and 1-bit acknowledge can continue as long as necessary.

To signal the end of the data transfer, the controller generates a stop condition by pulling the SDA line from low to high while the SCL line is high (see Figure 7-3). This action releases the bus and stops the communication link with the addressed target. All I²C-compatible devices must recognize the stop condition. Upon the receipt of a stop condition, all devices know that the bus is released, and the devices wait for a start condition followed by a matching address.

Attempting to read data from register addresses not listed in this section results in 00h being read out.

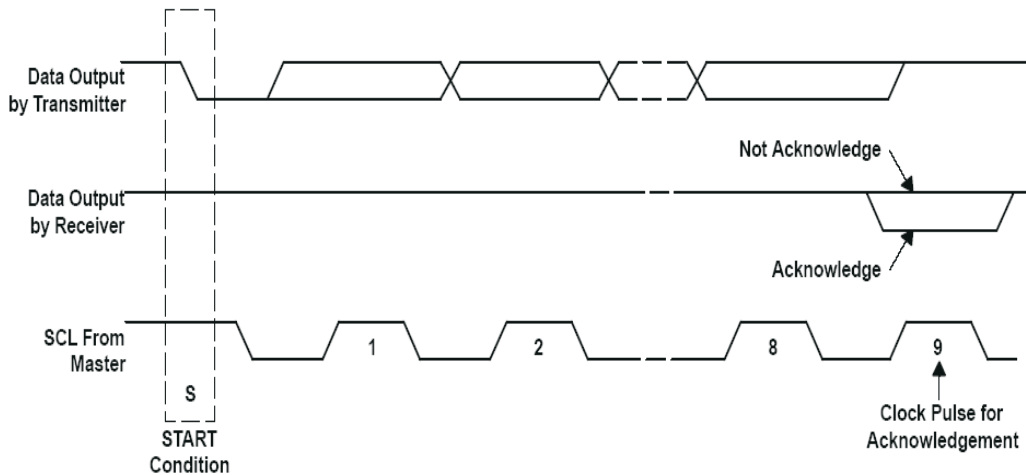

Figure 7-5. Acknowledge on the I²C Bus

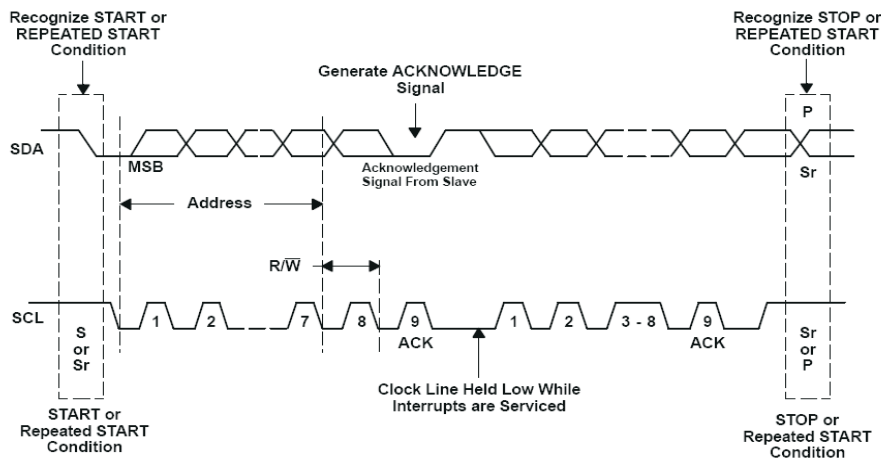

Figure 7-6. Bus Protocol

7.5.3 I²C Update Sequence

The requires the following:

- A start condition
- A valid I²C address
- A register address byte
- A data byte for a single update

After the receipt of each byte, the device acknowledges by pulling the SDA line low during the high period of a single clock pulse. A valid I²C address selects the device. The device performs an update on the falling edge of the acknowledge signal that follows the LSB byte.

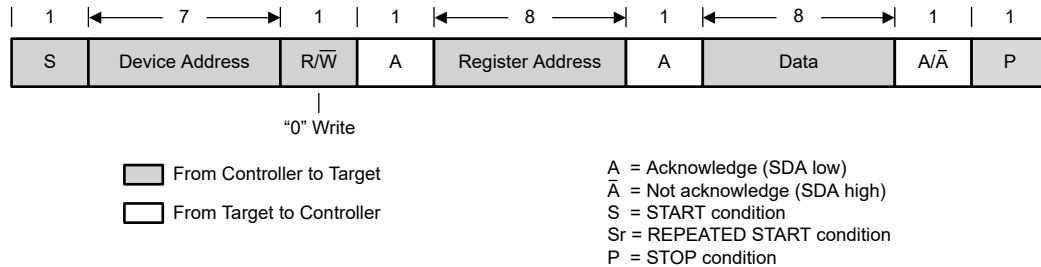

Figure 7-7. “Write” Data Transfer Format in Standard-, Fast, and Fast-Plus Modes

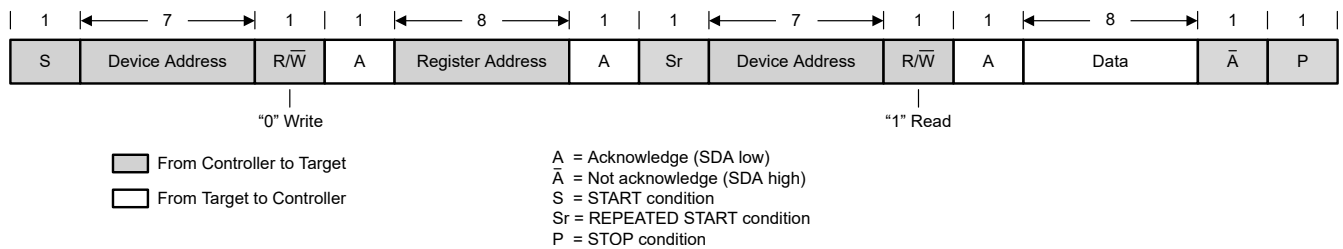

Figure 7-8. “Read” Data Transfer Format in Standard-, Fast, and Fast-Plus Modes

7.5.4 I²C Register Reset

The I²C registers can be reset by the following:

- Pull the input voltage below 1.8 V (typ).
- A high to low transition on EN. The previous value of the "Enable Output Discharge" bit is latched until the next EN rising edge or pulling the input voltage below 1.0 V (typ).
- Set the Reset bit in the CONTROL register. When Reset is set to 1, all registers are reset to the default values and a new start-up begins immediately. After t_{Delay} , the I²C registers can be programmed again.

8 Register Map

Table 8-1. Register Map

REGISTER ADDRESS (HEX)	REGISTER NAME	FACTORY DEFAULT (HEX)	DESCRIPTION
0x01	V _{OUT} Register 1	0x10	Sets the target output voltage
0x02	V _{OUT} Register 2	0x38	Sets the target output voltage
0x03	CONTROL Register		Sets miscellaneous configuration bits
0x05	STATUS Register	0x00	Returns status flags, cleared on read-out

8.1 I2C Address Byte

7	6	5	4	3	2	1	0
1	x	x	x	x	x	x	R/W

The target I2C address byte is the first byte received following the START condition from the controller device. The 7-bit target I2C address is internally set and has the value according the Device Comparison Table in [Section 4](#).

8.2 Register Address Byte

7	6	5	4	3	2	1	0
0	0	0	0	0	D2	D1	D0

Following the successful acknowledgment of the target I2C address, the bus controller sends a byte to the device, which contains the address of the register to be accessed.

8.3 V_{OUT} Register 1

Table 8-2. V_{OUT} Register 1 Description (Output Voltage Range 0.4 V to 1.9875 V)

REGISTER ADDRESS 0X01 READ/WRITE			
BIT	FIELD	VALUE (HEX)	OUTPUT VOLTAGE (TYP)
6:0	VO1_SET	0x00	0.400V
		0x01	0.4125V
		...	
		0x10	0.600V (default value for TPS628600/TPS628610)
		0x24	0.85V (default value for TPS628604)
		0x31	1.0125V (default value for TPS628606)
		...	
		0x34	1.05V (default value for TPS628603)
		...	
		0x70	1.8V (default value for TPS628605)
		0x7E	1.975V
		0x7F	1.9875 V

8.4 V_{OUT} Register 2

Table 8-3. V_{OUT} Register 2 Description (Output Voltage Range 0.4 V to 1.9875 V)

REGISTER ADDRESS 0X02 READ/WRITE			
BIT	FIELD	VALUE (HEX)	DESCRIPTION
7	Operation Mode	0x0	Keep PFM/PWM selection as in CONTROL-Register
		0x1	Sets the device in PWM operation for this Voltage selection (default value for TPS628605 and TPS628606)
BIT	FIELD	VALUE (HEX)	OUTPUT VOLTAGE (TYP)
6:0	VO2_SET	0x00	0.400V
		0x01	0.4125V
		...	
		0x14	0.65V (default value for TPS628603)
		...	
		0x31	1.0125V (default value for TPS628606)
		0x38	1.10V (default value for TPS628600/04 and TPS628610)
		...	
		0x70	1.8V (default value for TPS628605)
		0x7E	1.975V
0x7F	1.9875V		

8.5 CONTROL Register

Table 8-4. CONTROL Register Description

REGISTER ADDRESS 0X03 READ/WRITE				
BIT	FIELD	TYPE	DEFAULT	DESCRIPTION
7	Reset	W	0	1 - Reset all registers to default. This bit triggers a shutdown followed by a re-reading of the internal OTP settings and a new soft start.
6	Enable FPWM Mode during Output Voltage Change	R/W	1	0 - Keep the current mode status during output voltage change. 1 - Force the device in FPWM during output voltage change.
5	Software Enable Device	R/W	1	0 - Disable the device. All registers values are still kept. 1 - Re-enable the device with a new start-up without the t _{Delay} period.
4	Enable FPWM Mode	R/W	0	0 - Set the device in power save mode at light loads. 1 - Set the device in forced PWM mode at light loads.
3	Enable Output Discharge	R/W	1	0 - Disable output discharge. 1 - Enable output discharge. This setting is used for the next disable cycle (Software or Hardware).
2	Reserved			
0:1	Voltage Ramp Speed	R/W	11 ⁽¹⁾	00 - 10mV/μs 01 - 5 mV/μs 10 - 1 mV/μs 11 - 0.1 mV/μs

(1) The default value is programmed with 00 for TPS628603

8.6 STATUS Register

Table 8-5. STATUS Register Description

REGISTER ADDRESS 0X05 READ ONLY ⁽¹⁾				
BIT	FIELD	TYPE	DEFAULT	DESCRIPTION
7:5	Reserved			
4	Thermal Shutdown Tripped	R	0	1: Thermal Shutdown has tripped since the last reading. 0: No Thermal Shutdown event occurred during the last reading.
3	Reserved			
2	Power Bad	R	0	1: Output voltage is or was below 0.95xVO 0: No Power Bad event occurred since last reading
1:0	Reserved			

- (1) All bit values are latched until the device is reset, or the STATUS register is read. Then, the STATUS register is reset to the default values.

9 Application and Implementation

Note

Information in the following applications sections is not part of the TI component specification, and TI does not warrant its accuracy or completeness. TI's customers are responsible for determining suitability of components for their purposes, as well as validating and testing their design implementation to confirm system functionality.

9.1 Application Information

The following section discusses the design of the external components to complete the power supply design for several input and output voltage options by using typical applications as a reference.

9.2 Typical Application, TPS628610

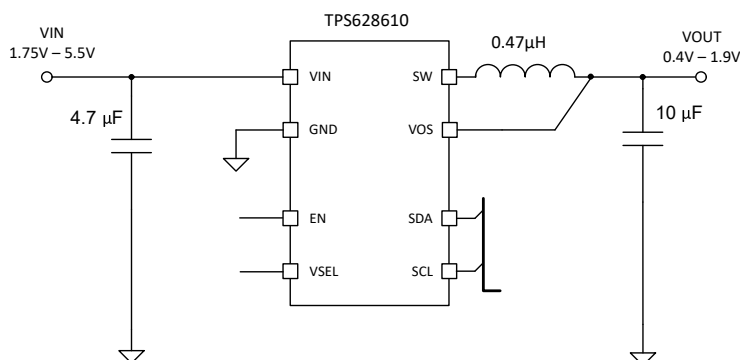

Figure 9-1. TPS628610, Typical Application

9.2.1 Design Requirements

Table 9-1 shows the list of components for the application circuit and the characteristic application curves.

Table 9-1. Components for Application Characteristic Curves

REFERENCE	DESCRIPTION	VALUE	SIZE [L x W x T]	MANUFACTURER ⁽¹⁾
TPS628610	Step down converter, 1 A		1.4 mm × 0.70 mm × 0.4 mm maximum	Texas Instruments
C _{IN}	Ceramic capacitor, GRM155R60J475ME47D	4.7 µF	0402 (1 mm × 0.5 mm × 0.6 mm maximum)	Murata
C _{OUT}	Ceramic capacitor, GRM155R60J106ME15D	10 µF	0402 (1 mm × 0.5 mm × 0.65 mm maximum)	Murata
L	Inductor DFE18SANR47MG0L	0.47 µH	0603 (1.6 mm × 0.8 mm × 1.0 mm maximum)	Murata

(1) See [Third-party Products Disclaimer](#).

9.2.2 Detailed Design Procedure

9.2.2.1 Inductor Selection

The inductor value affects the peak-to-peak ripple current, the PWM-to-PFM transition point, the output voltage ripple, and the efficiency. The selected inductor has to be rated for the DC resistance and saturation current. The inductor ripple current (ΔI_L) decreases with higher inductance and increases with higher V_{IN} or V_{OUT} and can be estimated according to [Equation 1](#).

[Equation 2](#) calculates the maximum inductor current under static load conditions. The saturation current of the inductor must be rated higher than the maximum inductor current, as calculated with [Equation 2](#). TI recommends this rating because during a heavy load transient the inductor current rises above the calculated value. A more conservative way is to select the inductor saturation current according to the high side MOSFET switch current limit, I_{LIMF} .

$$\Delta I_L = V_{out} \times \frac{1 - \frac{V_{out}}{V_{in}}}{L \times f} \quad (1)$$

$$I_{Lmax} = I_{outmax} + \frac{\Delta I_L}{2} \quad (2)$$

where

- f = Switching frequency
- L = Inductor value
- ΔI_L = Peak-to-peak inductor ripple current
- I_{Lmax} = Maximum inductor current

[Table 9-2](#) shows a list of possible inductors.

Table 9-2. List of Possible Inductors

INDUCTANCE [μH]	INDUCTOR SERIES	SIZE IMPERIAL (METRIC)	DIMENSIONS L × W × T	SUPPLIER ⁽¹⁾
0.47	DFE18SAN_G0	0603 (1608)	1.6 mm × 0.8 mm × 1.0 mm maximum	Murata
0.47	HTEB16080F	0603 (1608)	1.6 mm × 0.8 mm × 0.6 mm maximum	Cyntec
0.47	HTET1005FE	0402 (1005)	1.0 mm × 0.5 mm × 0.65 mm maximum	Cyntec
0.47	TFM160808ALC	0603 (1608)	1.6 mm × 0.8 mm × 0.8 mm maximum	TDK

(1) See [Third-party Products Disclaimer](#)

9.2.2.2 Output Capacitor Selection

The DCS-Control scheme of the TPS6286x allows the use of tiny ceramic capacitors. Ceramic capacitors with low ESR values have the lowest output voltage ripple and are recommended. The output capacitor requires either an X7R or X5R dielectric. At light-load currents, the converter operates in power save mode and the output voltage ripple is dependent on the output capacitor value. A larger output capacitors can be used reducing the output voltage ripple.

The inductor and output capacitor together provide a low-pass filter. [Table 9-3](#) outlines possible inductor and capacitor value combinations to simplify this process.

Table 9-3. Recommended LC Output Filter Combinations

DEVICE	NOMINAL INDUCTOR VALUE (μH)	NOMINAL OUTPUT CAPACITOR VALUE (μF)			
		4.7 μF	10 μF	2 × 10 μF	22 μF
	0.47 ⁽¹⁾	√	√ ⁽³⁾	√	√
TPS62860x	1.0 ⁽²⁾	√	√ ⁽³⁾	√	√

- (1) TI recommends an effective inductance range of 0.33 μH to 0.82 μH . TI recommends an effective capacitance range of 2 μF to 26 μF .
(2) TI recommends an effective inductance range of 0.7 μH to 1.2 μH . TI recommends an effective capacitance range of 3 μF to 26 μF .
(3) Typical application configuration. Other check marks indicate alternative filter combinations.

9.2.2.3 Input Capacitor Selection

Because the buck converter has a pulsating input current, a low ESR ceramic input capacitor is required for best input voltage filtering to minimize input voltage spikes. For most applications, a 4.7- μF input capacitor is sufficient. When operating from a high-impedance source (such as a coin cell), TI recommends a larger input buffer capacitor ≥ 10 μF to avoid voltage drops during start-up and load transients. The input capacitance can be increased without any limit for better input voltage filtering. The leakage current of the input capacitor adds to the overall current consumption.

Table 9-4 shows a selection of input and output capacitors.

Table 9-4. Capacitor Options

CAPACITANCE [μF]	CAPACITOR PART NUMBER	SIZE IMPERIAL (METRIC)	DIMENSIONS L × W × T	SUPPLIER ⁽¹⁾
4.7	GRM155R60J475ME47D	0402 (1005)	1.0 mm × 0.5 mm × 0.6 mm maximum	Murata
4.7	GRM035R60J475ME15	0201 (0603)	0.6 mm × 0.3 mm × 0.55 mm maximum	Murata
10	GRM155R60J106ME15D	0402 (1005)	1.0 mm × 0.5 mm × 0.65 mm maximum	Murata

- (1) See [Third-party Products Disclaimer](#).

9.2.3 Application Curves

$V_{IN} = 3.8\text{ V}$, $V_{OUT} = 1.1\text{ V}$, $T_A = 25^\circ\text{C}$, unless otherwise noted

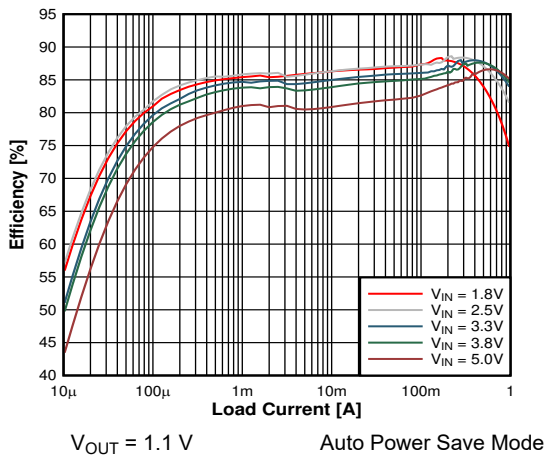

Figure 9-2. Efficiency

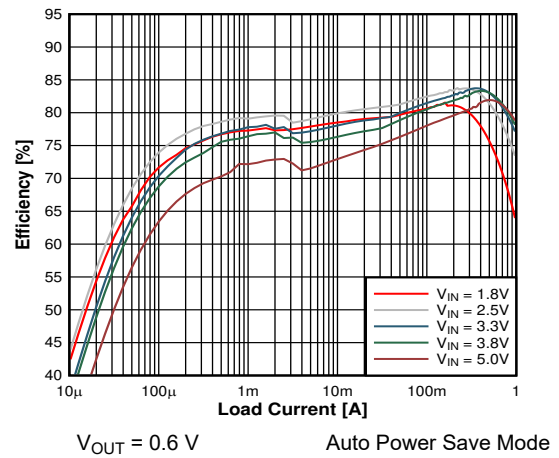

Figure 9-3. Efficiency

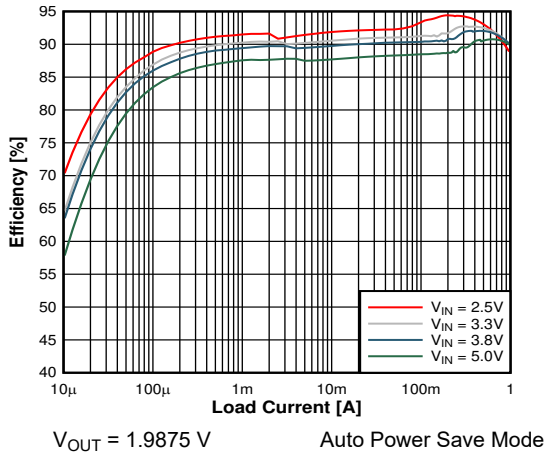

Figure 9-4. Efficiency

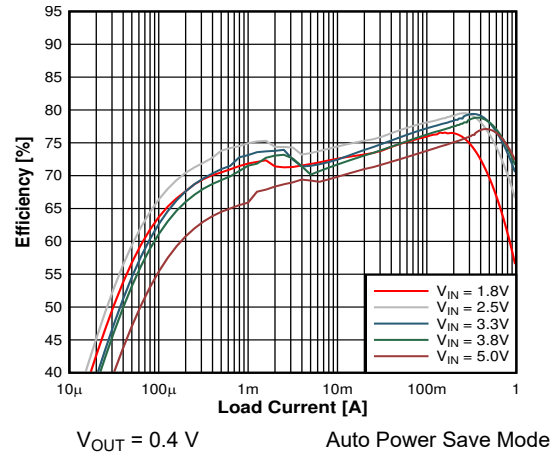

Figure 9-5. Efficiency

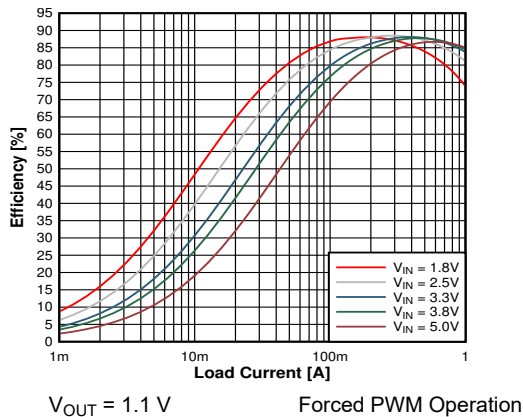

Figure 9-6. Efficiency, Inductor Comparison

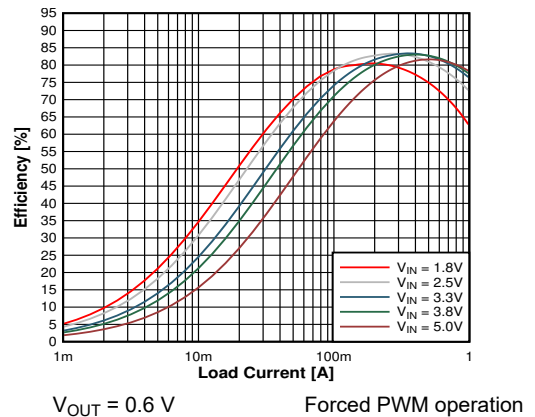
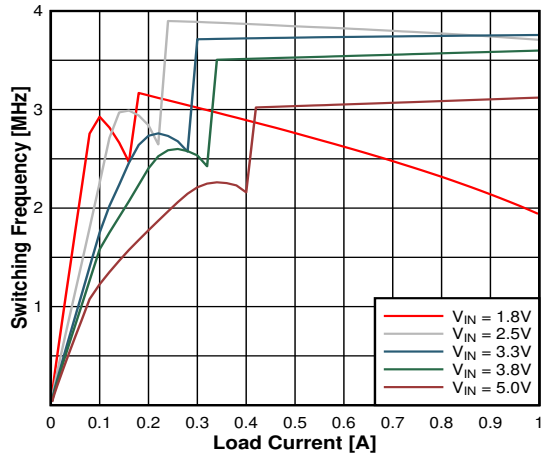
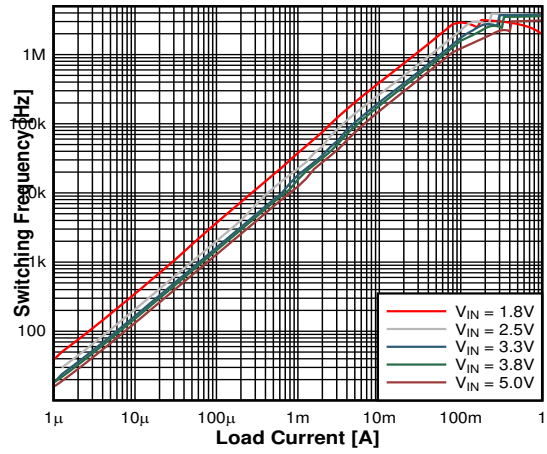

Figure 9-7. Efficiency



$V_{OUT} = 1.1\text{ V}$ Auto Power Save Mode

Figure 9-8. Switching Frequency



$V_{OUT} = 1.1\text{ V}$

Figure 9-9. Switching Frequency

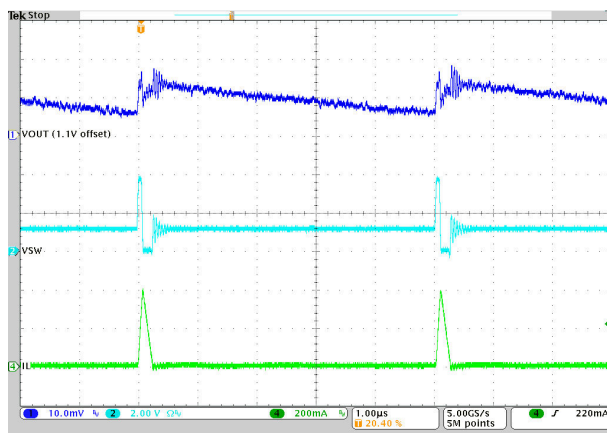

VSEL = HIGH

Figure 9-10. PFM Mode Operation

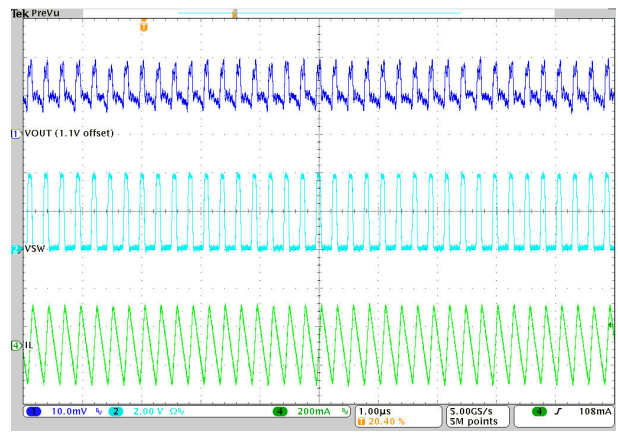

$I_{OUT} = 500\text{ mA}$

VSEL = HIGH

Figure 9-11. PWM-Mode Operation

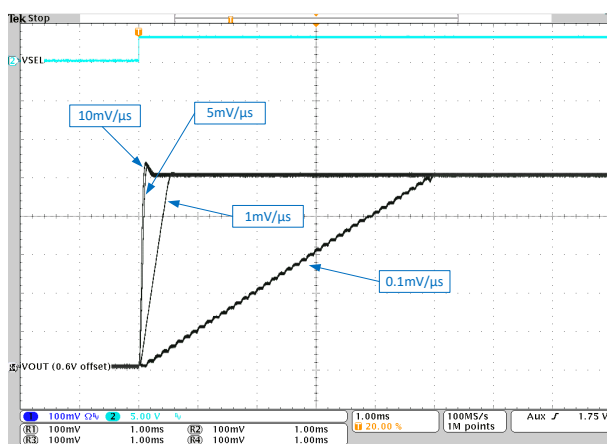

Default voltage setting

Figure 9-12. DVS by VSEL, Different Ramp Speed Settings

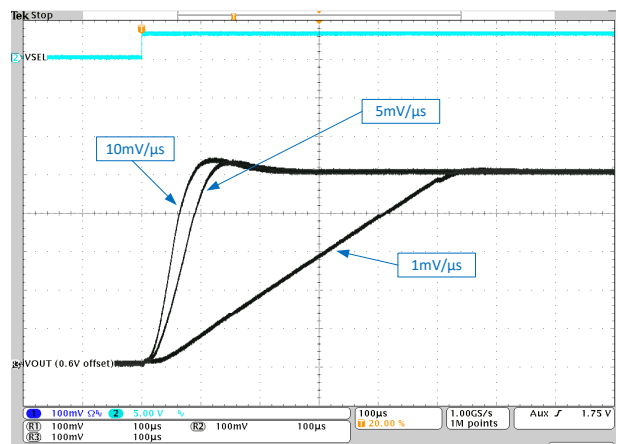

Default voltage setting

Figure 9-13. DVS by VSEL, Different Ramp Speed Settings

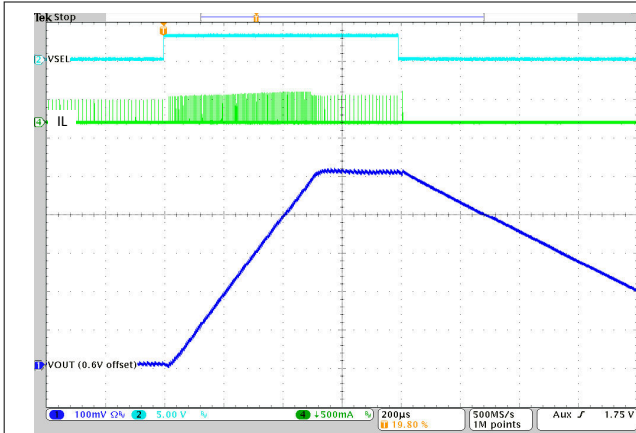

Power Save Mode is active

Figure 9-14. Standard Operation: V_{OUT} Change

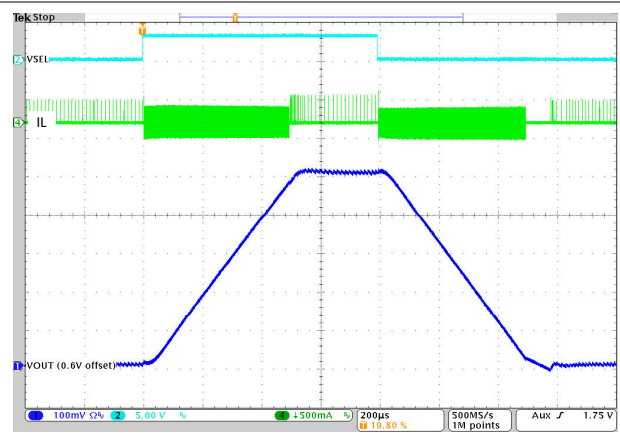

Power Save Mode is active

Figure 9-15. FPWM-Mode During V_{OUT} Change Enabled

9.3 Typical Application, TPS628600, TPS62860x

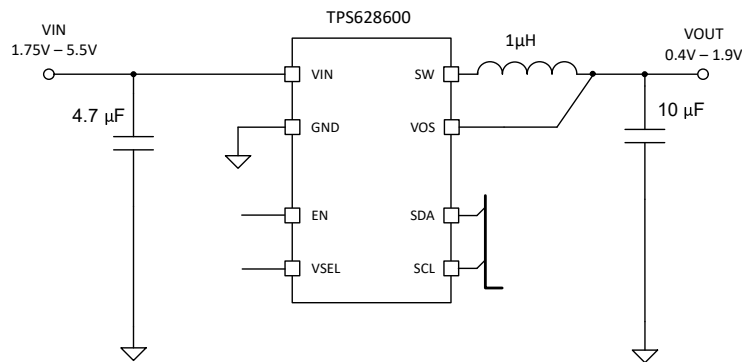

Figure 9-16. TPS628600, Typical Application

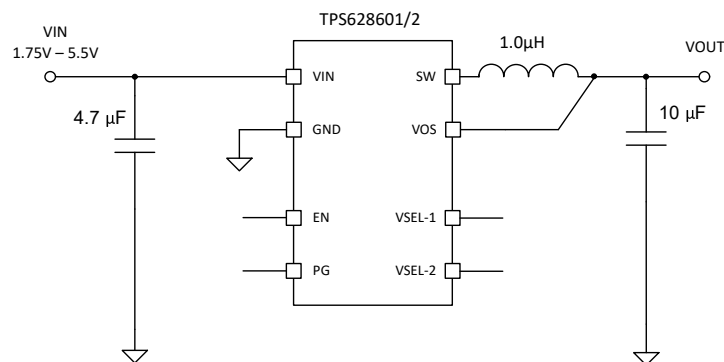

Figure 9-17. TPS62860x, Typical Application

9.3.1 Design Requirements

Table 9-5 shows the list of components for the application circuit and the characteristic application curves.

Table 9-5. Components for Application Characteristic Curves

REFERENCE	DESCRIPTION	VALUE	SIZE [L × W × T]	MANUFACTURER ⁽¹⁾
TPS628610	Step down converter, 1 A		1.4 mm × 0.70 mm × 0.4 mm maximum	Texas Instruments
C _{IN}	Ceramic capacitor, GRM155R60J475ME47D	4.7 μF	0402 (1 mm × 0.5 mm × 0.6 mm maximum)	Murata
C _{OUT}	Ceramic capacitor, GRM155R60J106ME15D	10 μF	0402 (1 mm × 0.5 mm × 0.65 mm max.)	Murata
L	Inductor DFE201610E	1 μH	0805 (2.0 mm × 1.6 mm × 1.0 mm max.)	Murata

(1) See [Third-party Products Disclaimer](#).

9.3.2 Detailed Design Procedure

See [Section 9.2.2](#).

9.3.3 Application Curves

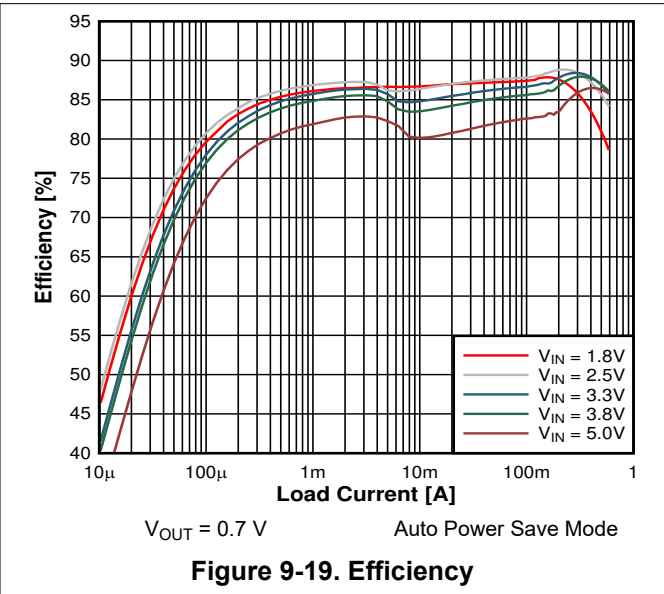
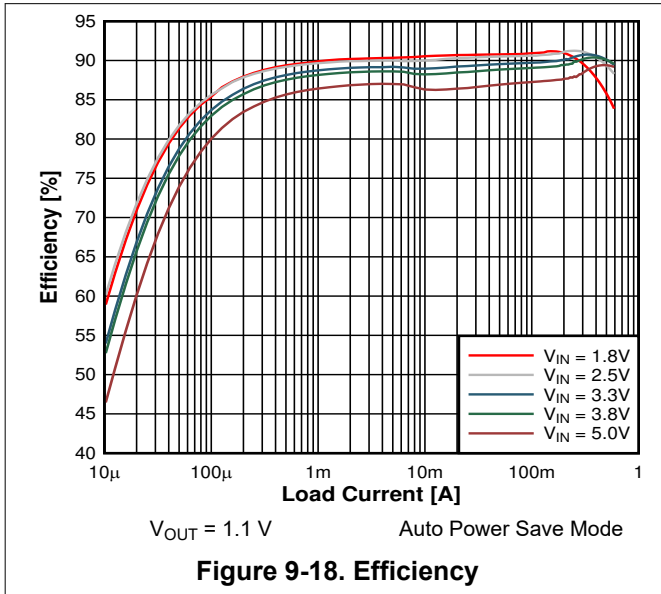

9.4 Power Supply Recommendations

The power supply must provide a current rating according to the supply voltage, output voltage, and output current of the TPS6286x.

9.5 Layout

9.5.1 Layout Guidelines

The pinout of the TPS6286x converter has been optimized to enable a single top layer PCB routing of the converter and the critical passive components such as C_{IN} , C_{OUT} , and L . This pinout allows the connection of tiny components such as 0201 (0603) size capacitors and 0402 (1005) size inductor. A design size smaller than 5 mm^2 can be achieved with a fixed output voltage.

- As for all switching power supplies, the layout is an important step in the design. A specified performance requires the correct on board layout.
- Provide a low inductance, low impedance ground path. Therefore, use wide and short traces for the main current paths.
- Place the input capacitor as close as possible to the V_{IN} and GND pins of the converter. This is the most critical component placement.
- The VOS line is a sensitive, high impedance line and must be connected to the output capacitor and routed away from noisy components and traces (for example, SW line) or other noise sources.

9.5.2 Layout Example

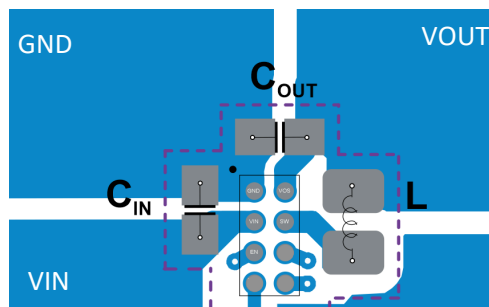

Figure 9-20. PCB Layout Example

10 Device and Documentation Support

10.1 Device Support

10.1.1 Third-Party Products Disclaimer

TI'S PUBLICATION OF INFORMATION REGARDING THIRD-PARTY PRODUCTS OR SERVICES DOES NOT CONSTITUTE AN ENDORSEMENT REGARDING THE SUITABILITY OF SUCH PRODUCTS OR SERVICES OR A WARRANTY, REPRESENTATION OR ENDORSEMENT OF SUCH PRODUCTS OR SERVICES, EITHER ALONE OR IN COMBINATION WITH ANY TI PRODUCT OR SERVICE.

10.2 Receiving Notification of Documentation Updates

To receive notification of documentation updates, navigate to the device product folder on ti.com. Click on *Notifications* to register and receive a weekly digest of any product information that has changed. For change details, review the revision history included in any revised document.

10.3 Support Resources

[TI E2E™ support forums](#) are an engineer's go-to source for fast, verified answers and design help — straight from the experts. Search existing answers or ask your own question to get the quick design help you need.

Linked content is provided "AS IS" by the respective contributors. They do not constitute TI specifications and do not necessarily reflect TI's views; see TI's [Terms of Use](#).

10.4 Trademarks

I2C™ is a trademark of NXP Semiconductors.

TI E2E™ is a trademark of Texas Instruments.

All trademarks are the property of their respective owners.

10.5 Electrostatic Discharge Caution



This integrated circuit can be damaged by ESD. Texas Instruments recommends that all integrated circuits be handled with appropriate precautions. Failure to observe proper handling and installation procedures can cause damage.

ESD damage can range from subtle performance degradation to complete device failure. Precision integrated circuits may be more susceptible to damage because very small parametric changes could cause the device not to meet its published specifications.

10.6 Glossary

[TI Glossary](#) This glossary lists and explains terms, acronyms, and definitions.

11 Revision History

NOTE: Page numbers for previous revisions may differ from page numbers in the current version.

Changes from Revision F (October 2023) to Revision G (January 2025)	Page
• Changed all instances of legacy terminology to controller and target where I ² C is mentioned	1
• Added TPS628605 and TPS628606 to the data sheet.....	1
• Added TPS628605 and TPS628606 to <i>Device Comparison</i> table.....	3
• Added column for I2C Address to the <i>Device Comparison</i> table.....	3
• Added TPS628605 and TPS628606 to Table 5-1	4
• Moved sub-sections Section 7.4.1 , Section 7.4.2 , Section 7.4.3 , and Section 7.4.4 from the <i>Feature Description</i> into the <i>Device Functional Modes</i>	13

Changes from Revision E (April 2023) to Revision F (October 2023)	Page
• Added TPS628604 and removed TPS628602 in the data sheet.....	1

12 Mechanical, Packaging, and Orderable Information

The following pages include mechanical, packaging, and orderable information. This information is the most current data available for the designated devices. This data is subject to change without notice and revision of this document. For browser-based versions of this data sheet, refer to the left-hand navigation.

PACKAGING INFORMATION

Orderable part number	Status (1)	Material type (2)	Package Pins	Package qty Carrier	RoHS (3)	Lead finish/ Ball material (4)	MSL rating/ Peak reflow (5)	Op temp (°C)	Part marking (6)
TPS628600YCHR	Active	Production	DSBGA (YCH) 8	12000 LARGE T&R	Yes	SNAGCU	Level-1-260C-UNLIM	-40 to 125	S
TPS628600YCHR.A	Active	Production	DSBGA (YCH) 8	12000 LARGE T&R	Yes	SNAGCU	Level-1-260C-UNLIM	-40 to 125	S
TPS628601YCHR	Active	Production	DSBGA (YCH) 8	12000 LARGE T&R	Yes	SNAGCU	Level-1-260C-UNLIM	-40 to 125	T
TPS628601YCHR.A	Active	Production	DSBGA (YCH) 8	12000 LARGE T&R	Yes	SNAGCU	Level-1-260C-UNLIM	-40 to 125	T
TPS628603YCHR	Active	Production	DSBGA (YCH) 8	12000 LARGE T&R	Yes	SNAGCU	Level-1-260C-UNLIM	-40 to 125	Q
TPS628603YCHR.A	Active	Production	DSBGA (YCH) 8	12000 LARGE T&R	Yes	SNAGCU	Level-1-260C-UNLIM	-40 to 125	Q
TPS628604YCHR	Active	Production	DSBGA (YCH) 8	12000 LARGE T&R	Yes	SNAGCU	Level-1-260C-UNLIM	-40 to 125	Q
TPS628604YCHR.A	Active	Production	DSBGA (YCH) 8	12000 LARGE T&R	Yes	SNAGCU	Level-1-260C-UNLIM	-40 to 125	Q
TPS628605YCHR	Active	Production	DSBGA (YCH) 8	12000 LARGE T&R	Yes	SNAGCU	Level-1-260C-UNLIM	-40 to 125	3
TPS628605YCHR.A	Active	Production	DSBGA (YCH) 8	12000 LARGE T&R	Yes	SNAGCU	Level-1-260C-UNLIM	-40 to 125	3
TPS628606YCHR	Active	Production	DSBGA (YCH) 8	12000 LARGE T&R	Yes	SNAGCU	Level-1-260C-UNLIM	-40 to 125	2
TPS628606YCHR.A	Active	Production	DSBGA (YCH) 8	12000 LARGE T&R	Yes	SNAGCU	Level-1-260C-UNLIM	-40 to 125	2
TPS628610YCHR	Active	Production	DSBGA (YCH) 8	12000 LARGE T&R	Yes	SNAGCU	Level-1-260C-UNLIM	-40 to 125	U
TPS628610YCHR.A	Active	Production	DSBGA (YCH) 8	12000 LARGE T&R	Yes	SNAGCU	Level-1-260C-UNLIM	-40 to 125	U

(1) **Status:** For more details on status, see our [product life cycle](#).

(2) **Material type:** When designated, preproduction parts are prototypes/experimental devices, and are not yet approved or released for full production. Testing and final process, including without limitation quality assurance, reliability performance testing, and/or process qualification, may not yet be complete, and this item is subject to further changes or possible discontinuation. If available for ordering, purchases will be subject to an additional waiver at checkout, and are intended for early internal evaluation purposes only. These items are sold without warranties of any kind.

(3) **RoHS values:** Yes, No, RoHS Exempt. See the [TI RoHS Statement](#) for additional information and value definition.

(4) **Lead finish/Ball material:** Parts may have multiple material finish options. Finish options are separated by a vertical ruled line. Lead finish/Ball material values may wrap to two lines if the finish value exceeds the maximum column width.

(5) **MSL rating/Peak reflow:** The moisture sensitivity level ratings and peak solder (reflow) temperatures. In the event that a part has multiple moisture sensitivity ratings, only the lowest level per JEDEC standards is shown. Refer to the shipping label for the actual reflow temperature that will be used to mount the part to the printed circuit board.

(6) **Part marking:** There may be an additional marking, which relates to the logo, the lot trace code information, or the environmental category of the part.

Multiple part markings will be inside parentheses. Only one part marking contained in parentheses and separated by a "~" will appear on a part. If a line is indented then it is a continuation of the previous line and the two combined represent the entire part marking for that device.

Important Information and Disclaimer: The information provided on this page represents TI's knowledge and belief as of the date that it is provided. TI bases its knowledge and belief on information provided by third parties, and makes no representation or warranty as to the accuracy of such information. Efforts are underway to better integrate information from third parties. TI has taken and continues to take reasonable steps to provide representative and accurate information but may not have conducted destructive testing or chemical analysis on incoming materials and chemicals. TI and TI suppliers consider certain information to be proprietary, and thus CAS numbers and other limited information may not be available for release.

In no event shall TI's liability arising out of such information exceed the total purchase price of the TI part(s) at issue in this document sold by TI to Customer on an annual basis.

TAPE AND REEL INFORMATION

QUADRANT ASSIGNMENTS FOR PIN 1 ORIENTATION IN TAPE

*All dimensions are nominal

Device	Package Type	Package Drawing	Pins	SPQ	Reel Diameter (mm)	Reel Width W1 (mm)	A0 (mm)	B0 (mm)	K0 (mm)	P1 (mm)	W (mm)	Pin1 Quadrant
TPS628600YCHR	DSBGA	YCH	8	12000	180.0	8.4	0.81	1.53	0.43	2.0	8.0	Q1
TPS628601YCHR	DSBGA	YCH	8	12000	180.0	8.4	0.81	1.53	0.43	2.0	8.0	Q1
TPS628603YCHR	DSBGA	YCH	8	12000	180.0	8.4	0.81	1.53	0.43	2.0	8.0	Q1
TPS628604YCHR	DSBGA	YCH	8	12000	180.0	8.4	0.81	1.53	0.43	2.0	8.0	Q1
TPS628605YCHR	DSBGA	YCH	8	12000	180.0	8.4	0.81	1.53	0.43	2.0	8.0	Q1
TPS628606YCHR	DSBGA	YCH	8	12000	180.0	8.4	0.81	1.53	0.43	2.0	8.0	Q1
TPS628610YCHR	DSBGA	YCH	8	12000	180.0	8.4	0.81	1.53	0.43	2.0	8.0	Q1

TAPE AND REEL BOX DIMENSIONS

*All dimensions are nominal

Device	Package Type	Package Drawing	Pins	SPQ	Length (mm)	Width (mm)	Height (mm)
TPS628600YCHR	DSBGA	YCH	8	12000	182.0	182.0	20.0
TPS628601YCHR	DSBGA	YCH	8	12000	182.0	182.0	20.0
TPS628603YCHR	DSBGA	YCH	8	12000	182.0	182.0	20.0
TPS628604YCHR	DSBGA	YCH	8	12000	182.0	182.0	20.0
TPS628605YCHR	DSBGA	YCH	8	12000	182.0	182.0	20.0
TPS628606YCHR	DSBGA	YCH	8	12000	182.0	182.0	20.0
TPS628610YCHR	DSBGA	YCH	8	12000	182.0	182.0	20.0

YCH0008

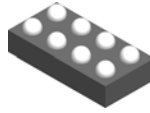

PACKAGE OUTLINE

DSBGA - 0.4 mm max height

DIE SIZE BALL GRID ARRAY

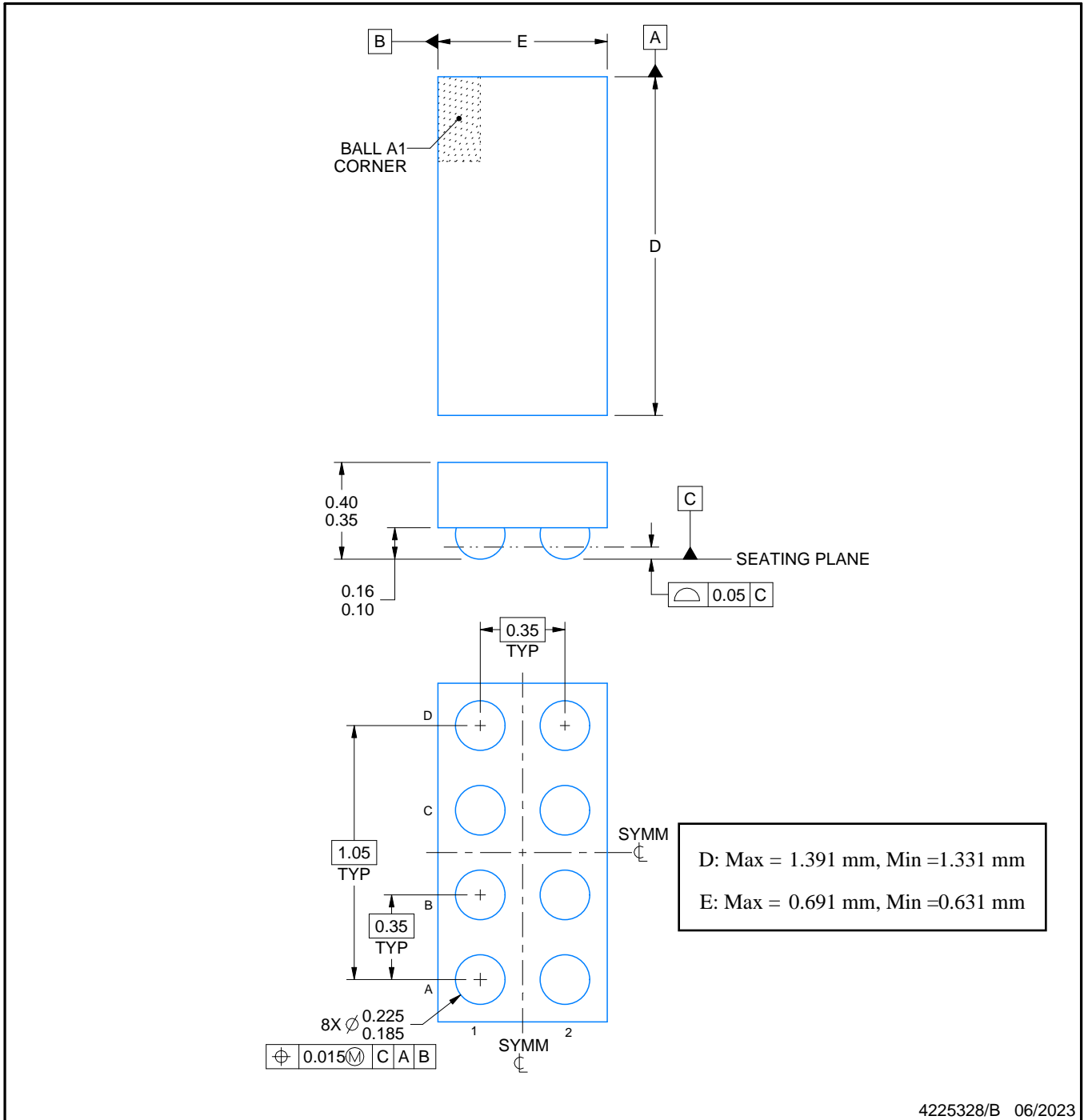

NOTES:

- All linear dimensions are in millimeters. Any dimensions in parenthesis are for reference only. Dimensioning and tolerancing per ASME Y14.5M.
- This drawing is subject to change without notice.

EXAMPLE BOARD LAYOUT

YCH0008

DSBGA - 0.4 mm max height

DIE SIZE BALL GRID ARRAY

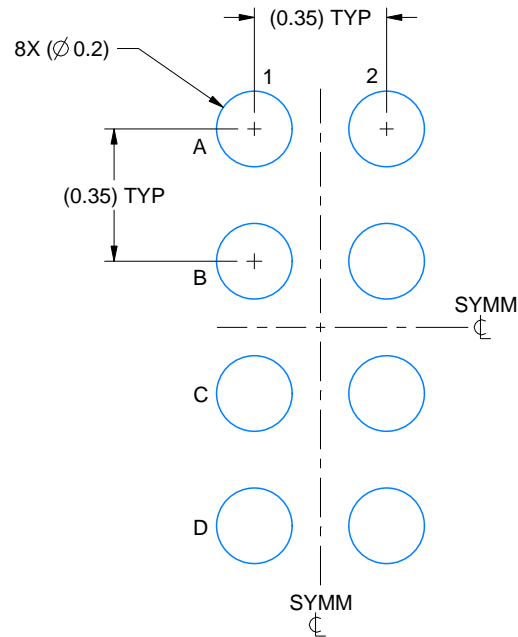

LAND PATTERN EXAMPLE
EXPOSED METAL SHOWN
SCALE: 50X

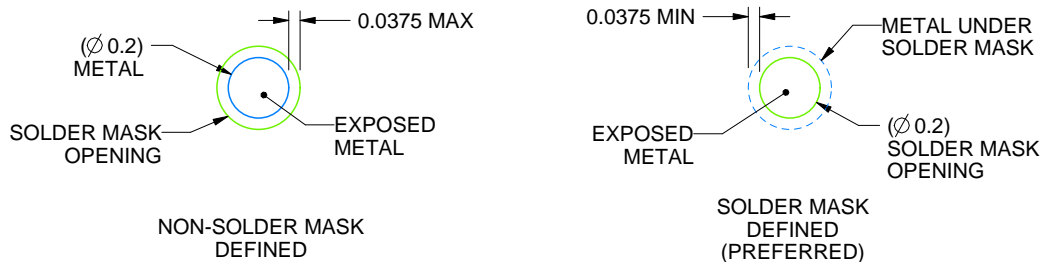

SOLDER MASK DETAILS
NOT TO SCALE

4225328/B 06/2023

NOTES: (continued)

- Final dimensions may vary due to manufacturing tolerance considerations and also routing constraints. See Texas Instruments Literature No. SNVA009 (www.ti.com/lit/snva009).

EXAMPLE STENCIL DESIGN

YCH0008

DSBGA - 0.4 mm max height

DIE SIZE BALL GRID ARRAY

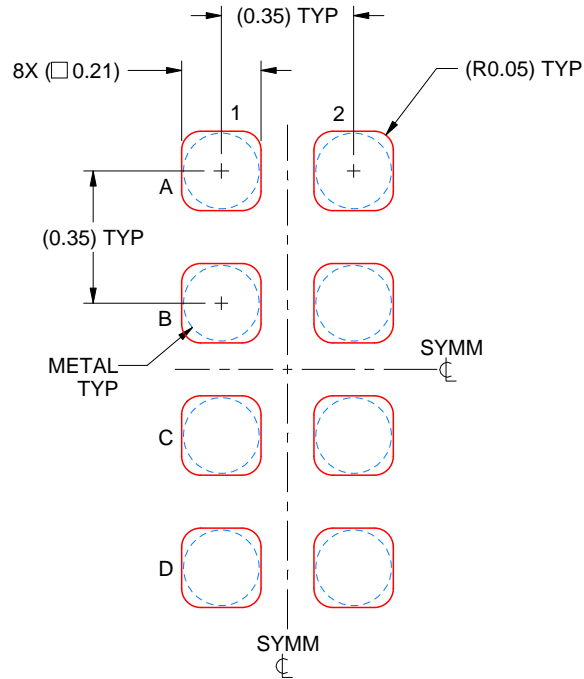

SOLDER PASTE EXAMPLE
BASED ON 0.075 mm THICK STENCIL
SCALE: 50X

4225328/B 06/2023

NOTES: (continued)

4. Laser cutting apertures with trapezoidal walls and rounded corners may offer better paste release.

IMPORTANT NOTICE AND DISCLAIMER

TI PROVIDES TECHNICAL AND RELIABILITY DATA (INCLUDING DATASHEETS), DESIGN RESOURCES (INCLUDING REFERENCE DESIGNS), APPLICATION OR OTHER DESIGN ADVICE, WEB TOOLS, SAFETY INFORMATION, AND OTHER RESOURCES "AS IS" AND WITH ALL FAULTS, AND DISCLAIMS ALL WARRANTIES, EXPRESS AND IMPLIED, INCLUDING WITHOUT LIMITATION ANY IMPLIED WARRANTIES OF MERCHANTABILITY, FITNESS FOR A PARTICULAR PURPOSE OR NON-INFRINGEMENT OF THIRD PARTY INTELLECTUAL PROPERTY RIGHTS.

These resources are intended for skilled developers designing with TI products. You are solely responsible for (1) selecting the appropriate TI products for your application, (2) designing, validating and testing your application, and (3) ensuring your application meets applicable standards, and any other safety, security, regulatory or other requirements.

These resources are subject to change without notice. TI grants you permission to use these resources only for development of an application that uses the TI products described in the resource. Other reproduction and display of these resources is prohibited. No license is granted to any other TI intellectual property right or to any third party intellectual property right. TI disclaims responsibility for, and you fully indemnify TI and its representatives against any claims, damages, costs, losses, and liabilities arising out of your use of these resources.

TI's products are provided subject to [TI's Terms of Sale](#), [TI's General Quality Guidelines](#), or other applicable terms available either on [ti.com](#) or provided in conjunction with such TI products. TI's provision of these resources does not expand or otherwise alter TI's applicable warranties or warranty disclaimers for TI products. Unless TI explicitly designates a product as custom or customer-specified, TI products are standard, catalog, general purpose devices.

TI objects to and rejects any additional or different terms you may propose.

Copyright © 2025, Texas Instruments Incorporated

Last updated 10/2025