

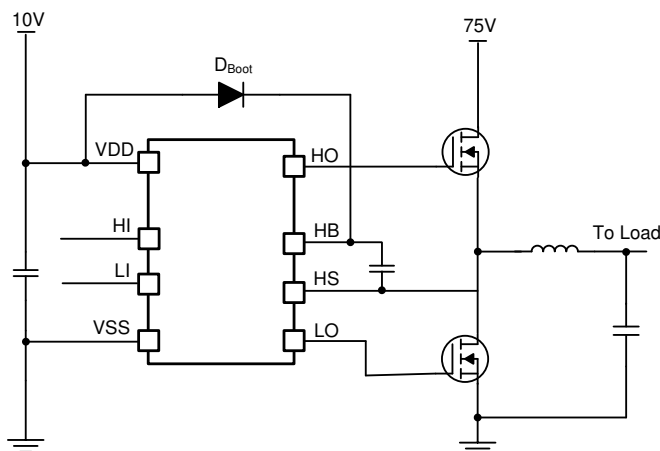
# UCC27288 3-A 120-V Half-Bridge Driver with 8-V UVLO and External Bootstrap Diode

## 1 Features

- Drives two N-channel MOSFETs in high-side low-side configuration
- 16-ns typical propagation delay
- 12-ns rise, 10-ns typical fall time with 1800-pF load
- 1-ns typical delay matching
- Configurable external bootstrap diode
- 8-V typical undervoltage lockout
- Absolute maximum negative voltage handling on inputs (–5 V)
- Absolute maximum negative voltage handling on HS (–14 V)
- ±3-A peak output current
- Absolute maximum boot voltage 120 V
- Inputs are independent of each other and VDD
- Under voltage lockout for both channels
- Specified from –40°C to 140°C junction temperature

## 2 Applications

- [Solar power optimizer](#)
- [Merchant network & server PSU](#)
- [Merchant telecom rectifiers](#)
- [DC input BLDC motor drive](#)
- [Test & measurement equipment](#)



Simplified Application Diagram

## 3 Description

The UCC27288 is a robust N-channel MOSFET driver with a maximum switch node (HS) voltage rating of 100 V. It allows for two N-channel MOSFETs to be controlled in half-bridge or synchronous buck configuration based topologies. Its 3-A peak source and sink current along with low pull-up and pull-down resistance allows the UCC27288 to drive large power MOSFETs with minimum switching losses during the transition of the MOSFET Miller plateau. Since the inputs are independent of the supply voltage, UCC27288 can be used in conjunction with both analog and digital controllers. Two inputs are completely independent of each other and therefore provides added control design flexibility.

The input pins as well as the HS pin are able to tolerate significant negative voltage, which improves system robustness. The inputs are completely independent of each other. This allows for control flexibility where two outputs can be overlapped by overlapping inputs if needed. Small propagation delay and delay matching specifications minimize the dead-time requirement which improves system efficiency.

Under voltage lockout (UVLO) is provided for both the high-side and low-side driver stages forcing the outputs low if the VDD voltage is below the specified threshold. No integrated bootstrap diode allows user to use application-appropriate external bootstrap diode. UCC27288 is offered in an SOIC8 package to improve system robustness in harsh environments.

### Device Information

PART NUMBER	PACKAGE (SIZE) <sup>(1)</sup>
UCC27288	SOIC8 (6 mm x 5mm)

- (1) For all available packages, see the orderable addendum at the end of the data sheet.



## Table of Contents

<b>1 Features</b> .....	1	7.4 Device Functional Modes.....	13
<b>2 Applications</b> .....	1	<b>8 Application and Implementation</b> .....	15
<b>3 Description</b> .....	1	8.1 Application Information.....	15
<b>4 Revision History</b> .....	2	8.2 Typical Application.....	16
<b>5 Pin Configuration and Functions</b> .....	3	<b>9 Power Supply Recommendations</b> .....	24
<b>6 Specifications</b> .....	4	<b>10 Layout</b> .....	25
6.1 Absolute Maximum Ratings.....	4	10.1 Layout Guidelines.....	25
6.2 ESD Ratings.....	4	10.2 Layout Example.....	25
6.3 Recommended Operating Conditions.....	4	<b>11 Device and Documentation Support</b> .....	26
6.4 Thermal Information.....	5	11.1 Receiving Notification of Documentation Updates..	26
6.5 Electrical Characteristics.....	5	11.2 Support Resources.....	26
6.6 Switching Characteristics.....	6	11.3 Trademarks.....	26
6.7 Typical Characteristics.....	7	11.4 Electrostatic Discharge Caution.....	26
<b>7 Detailed Description</b> .....	11	11.5 Glossary.....	26
7.1 Overview.....	11	<b>12 Mechanical, Packaging, and Orderable Information</b> .....	26
7.2 Functional Block Diagram.....	11		
7.3 Feature Description.....	12		

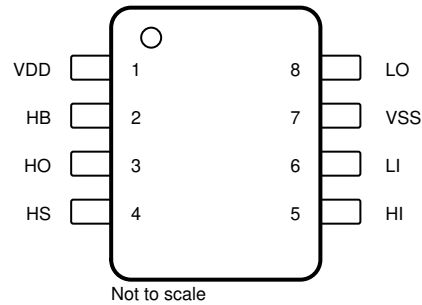
## 4 Revision History

Changes from Revision A (October 2020) to Revision B (April 2022)	Page
• Updated typical peak pullup/pulldown current from +2.5A/-3.5A to ±3A in Electrical Characteristics.....	5
• Updated I <sub>HBS</sub> typical leakage to 5.0µA and test voltage from 110V to 100V in Electrical Characteristics.....	5

---

Changes from Revision * (June 2020) to Revision A (October 2020)	Page
• Changed marketing status from Advance Information to initial release. ....	1

## 5 Pin Configuration and Functions



**Figure 5-1. D Package 8-Pin SOIC Top View**

### Pin Functions

PIN		I/O <sup>(1)</sup>	DESCRIPTION
Name	D		
HB	2	P	High-side bootstrap supply. The external bootstrap diode and the external bootstrap capacitor is required to generate bootstrap supply from VDD. Connect positive side of the bootstrap capacitor and cathode of an external diode to this pin. The external diode should be 100V (minimum) rated. Higher voltage rated diode is acceptable too. Typical recommended value of HB bypass capacitor is 0.1 $\mu$ F. This value primarily depends on the gate charge of the high-side MOSFET.
HI	5	I	High-side input.
HO	3	O	High-side output. Connect to the gate of the high-side power MOSFET or one end of external gate resistor, when used.
HS	4	P	High-side source connection. Connect to source of high-side power MOSFET. Connect negative side of bootstrap capacitor to this pin.
LI	6	I	Low-side input
LO	8	O	Low-side output. Connect to the gate of the low-side power MOSFET or one end of external gate resistor, when used.
VDD	1	P	Positive supply to the low-side gate driver. Decouple this pin to VSS. Typical decoupling capacitor value is 1 $\mu$ F. When using an external boot diode, connect the anode to this pin. If series resistor is used in series with the boot diode then connect one end of series boot resistor to this pin and other end of the resistor should be connected to the anode of the external boot diode.
VSS	7	G	Negative supply terminal for the device which is generally the system ground.

(1) P = Power, G = Ground, I = Input, O = Output, I/O = Input/Output

## 6 Specifications

### 6.1 Absolute Maximum Ratings

All voltages are with respect to  $V_{SS}$  <sup>(1)</sup> <sup>(2)</sup>

			MIN	MAX	UNIT
$V_{DD}$	Supply voltage		-0.3	20	V
$V_{HI}, V_{LI}$	Input voltages on HI and LI		-5	20	V
$V_{LO}$	Output voltage on LO	DC	-0.3	$V_{DD} + 0.3$	V
		Pulses < 100 ns <sup>(3)</sup>	-2	$V_{DD} + 0.3$	
$V_{HO}$	Output voltage on HO	DC	$V_{HS} - 0.3$	$V_{HB} + 0.3$	V
		Pulses < 100 ns <sup>(3)</sup>	$V_{HS} - 2$	$V_{HB} + 0.3$	
$V_{HS}$	Voltage on HS	DC	-10	100	V
		Pulses < 100 ns <sup>(3)</sup>	-14	100	
$V_{HB}$	Voltage on HB		-0.3	120	V
$V_{HB-HS}$	Voltage on HB with respect to HS		-0.3	20	V
$T_J$	Operating junction temperature		-40	150	°C
	Lead temperature (soldering, 10 sec.)			300	°C
$T_{stg}$	Storage temperature		-65	150	°C

- (1) Stresses beyond those listed under *Absolute Maximum Ratings* may cause permanent damage to the device. These are stress ratings only, which do not imply functional operation of the device at these or any other conditions beyond those indicated under *Recommended Operating Conditions*. Exposure to absolute-maximum-rated conditions for extended periods may affect device reliability.
- (2) All voltages are with respect to  $V_{SS}$ . Currents are positive into, negative out of the specified terminal.
- (3) Values are verified by characterization only.

### 6.2 ESD Ratings

			VALUE	UNIT
$V_{(ESD)}$	Electrostatic discharge	Human-body model (HBM), per ANSI/ESDA/JEDEC JS-001 <sup>(1)</sup> <sup>(2)</sup>	±2000	V
		Charged-device model (CDM), per JEDEC specification JESD22-C101 <sup>(3)</sup>	±1500	

- (1) JEDEC document JEP155 states that 500-V HBM allows safe manufacturing with a standard ESD control process.
- (2) Pins HS, HB and HO are rated at 500V HBM
- (3) JEDEC document JEP157 states that 250-V CDM allows safe manufacturing with a standard ESD control process.

### 6.3 Recommended Operating Conditions

over operating free-air temperature range (unless otherwise noted)

		MIN	NOM	MAX	UNIT
$V_{DD}$	Supply voltage	8	12	16	V
$V_{HI}, V_{LI}$	Input Voltage	0		$V_{DD}$	
$V_{LO}$	Low side output voltage	0		$V_{DD}$	
$V_{HO}$	High side output voltage	$V_{HS}$		$V_{HB}$	
$V_{HS}$	Voltage on HS <sup>(1)</sup>	-8		100	V
	Voltage on HS (Pulses < 100 ns) <sup>(1)</sup>	-12		100	
$V_{HB}$	Voltage on HB	$V_{HS} + 8$		$V_{HS} + 16$	V
$V_{sr}$	Voltage slew rate on HS			50	V/ns
$T_J$	Operating junction temperature	-40		140	°C

- (1)  $V_{HB-HS} < 16V$  (Voltage on HB with respect to HS must be less than 16V)

## 6.4 Thermal Information

THERMAL METRIC <sup>(1)</sup>		UCC27288	
		D	
		8 PINS	
			UNIT
R <sub>θJA</sub>	Junction-to-ambient thermal resistance	118.3	°C/W
R <sub>θJC(top)</sub>	Junction-to-case (top) thermal resistance	53.6	°C/W
R <sub>θJB</sub>	Junction-to-board thermal resistance	63.1	°C/W
ψ <sub>JT</sub>	Junction-to-top characterization parameter	10.7	°C/W
ψ <sub>JB</sub>	Junction-to-board characterization parameter	62.1	°C/W
R <sub>θJC(bot)</sub>	Junction-to-case (bottom) thermal resistance	n/a	°C/W

(1) For more information about traditional and new thermal metrics, see the Semiconductor and IC Package Thermal Metrics application report, SPRA953.

## 6.5 Electrical Characteristics

V<sub>DD</sub> = V<sub>HB</sub> = 12 V, V<sub>HS</sub> = V<sub>SS</sub> = 0 V, No load on LO or HO, T<sub>J</sub> = -40°C to +140°C, (unless otherwise noted)

PARAMETER		TEST CONDITIONS	MIN	TYP	MAX	UNIT
<b>SUPPLY CURRENTS</b>						
I <sub>DD</sub>	VDD quiescent current	V <sub>LI</sub> = V <sub>HI</sub> = 0	0.36	0.45		mA
I <sub>DDO</sub>	VDD operating current	f = 500 kHz, C <sub>LOAD</sub> = 0	2.2	4.5		mA
I <sub>HB</sub>	HB quiescent current	V <sub>LI</sub> = V <sub>HI</sub> = 0 V	0.2	0.4		mA
I <sub>HBO</sub>	HB operating current	f = 500 kHz, C <sub>LOAD</sub> = 0	2.5	4		mA
I <sub>HBS</sub>	HB to VSS quiescent current	V <sub>HS</sub> = V <sub>HB</sub> = 100 V	5.0	50		μA
I <sub>HBSO</sub>	HB to VSS operating current <sup>(1)</sup>	f = 500 kHz, C <sub>LOAD</sub> = 0	0.1			mA
<b>INPUT</b>						
V <sub>HIT</sub>	Input rising threshold (HI and LI)		1.9	2.1	2.4	V
V <sub>LIT</sub>	Input falling threshold (HI and LI)		0.9	1.1	1.3	V
V <sub>IHYS</sub>	Input voltage Hysteresis (HI and LI)			1.0		V
R <sub>IN</sub>	Input pulldown resistance (HI and LI)		100	250	350	kΩ
<b>UNDERVOLTAGE LOCKOUT PROTECTION (UVLO)</b>						
V <sub>DDR</sub>	VDD rising threshold		6.5	7.0	7.8	V
V <sub>DDF</sub>	VDD falling threshold		5.7	6.5	7.3	V
V <sub>DDHYS</sub>	VDD threshold hysteresis			0.5		V
V <sub>HBR</sub>	HB rising threshold with respect to HS pin		5.5	6.3	7.1	V
V <sub>HBF</sub>	HB falling threshold with respect to HS pin		5.0	5.8	6.6	V
V <sub>HBHYS</sub>	HB threshold hysteresis			0.5		V
<b>LO GATE DRIVER</b>						
V <sub>LOL</sub>	Low level output voltage	I <sub>LO</sub> = 100 mA	0.085	0.4		V
V <sub>LOH</sub>	High level output voltage	I <sub>LO</sub> = -100 mA, V <sub>LOH</sub> = V <sub>DD</sub> - V <sub>LO</sub>	0.13	0.42		V
	Peak pullup current <sup>(1)</sup>	V <sub>LO</sub> = 0 V		3.0		A
	Peak pulldown current <sup>(1)</sup>	V <sub>LO</sub> = 12 V		3.0		A
<b>HO GATE DRIVER</b>						
V <sub>HOL</sub>	Low level output voltage	I <sub>HO</sub> = 100 mA	0.1	0.4		V
V <sub>HOH</sub>	High level output voltage	I <sub>HO</sub> = -100 mA, V <sub>HOH</sub> = V <sub>HB</sub> - V <sub>HO</sub>	0.13	0.42		V
	Peak pullup current <sup>(1)</sup>	V <sub>HO</sub> = 0 V		3.0		A
	Peak pulldown current <sup>(1)</sup>	V <sub>HO</sub> = 12 V		3.0		A

(1) Parameter not tested in production

## 6.6 Switching Characteristics

$V_{DD} = V_{HB} = 12\text{ V}$ ,  $V_{HS} = V_{SS} = 0\text{ V}$ , No load on LO or HO,  $T_J = -40^\circ\text{C}$  to  $+140^\circ\text{C}$ , (unless otherwise noted)

PARAMETER	TEST CONDITIONS	MIN	TYP	MAX	UNIT	
<b>PROPAGATION DELAYS</b>						
$t_{DLFF}$	$V_{LI}$ falling to $V_{LO}$ falling	See Figure 6-1		16	30	ns
$t_{DHFF}$	$V_{HI}$ falling to $V_{HO}$ falling	See Figure 6-1		16	30	ns
$t_{DLRR}$	$V_{LI}$ rising to $V_{LO}$ rising	See Figure 6-1		16	30	ns
$t_{DHRR}$	$V_{HI}$ rising to $V_{HO}$ rising	See Figure 6-1		16	30	ns
<b>DELAY MATCHING</b>						
$t_{MON}$	From LO being ON to HO being OFF	See Figure 6-1		1	7	ns
$t_{MOFF}$	From LO being OFF to HO being ON	See Figure 6-1		1	7	ns
<b>OUTPUT RISE AND FALL TIME</b>						
$t_R$	LO, HO rise time	$C_{LOAD} = 1800\text{ pF}$ , 10% to 90%		12		ns
$t_F$	LO, HO fall time	$C_{LOAD} = 1800\text{ pF}$ , 90% to 10%		10		ns
$t_R$	LO, HO (3 V to 9 V) rise time	$C_{LOAD} = 0.1\text{ }\mu\text{F}$ , 30% to 70%		0.33	0.6	$\mu\text{s}$
$t_F$	LO, HO (3 V to 9 V) fall time	$C_{LOAD} = 0.1\text{ }\mu\text{F}$ , 70% to 30%		0.23	0.6	$\mu\text{s}$
<b>MISCELLANEOUS</b>						
$T_{PW,min}$	Minimum input pulse width that changes the output			20		ns

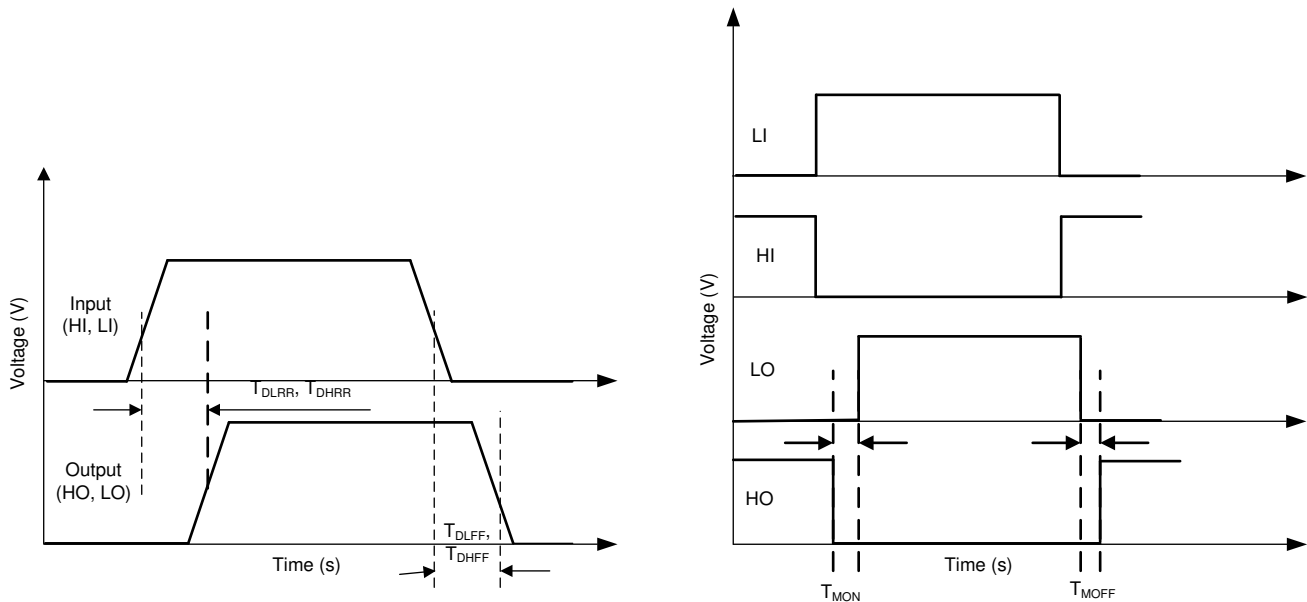


Figure 6-1. Timing Diagram

## 6.7 Typical Characteristics

Unless otherwise specified  $V_{DD}=V_{HB} = 12\text{ V}$ ,  $V_{HS}=V_{VSS} = 0\text{ V}$ , No load on outputs

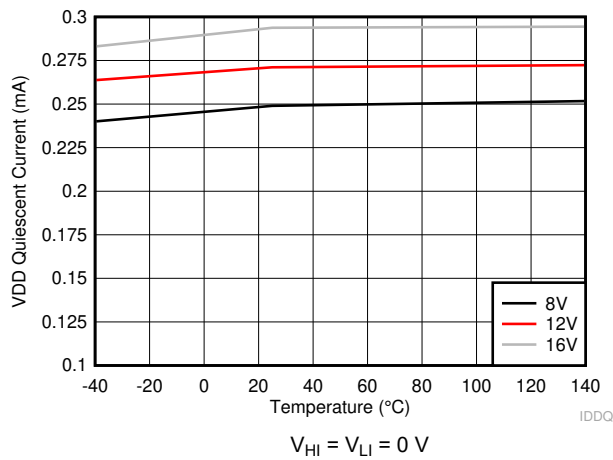


Figure 6-2. VDD Quiescent Current

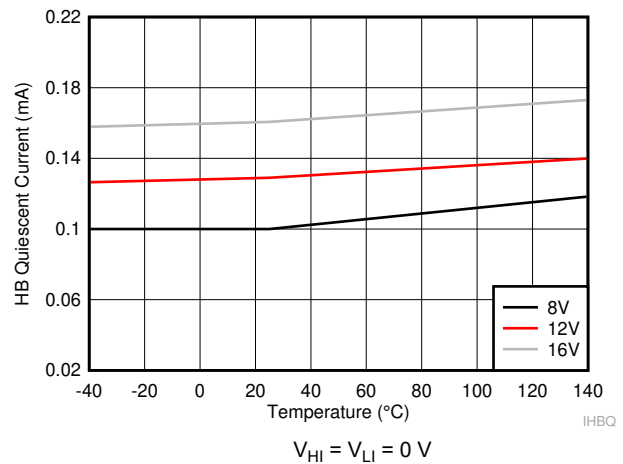


Figure 6-3. HB Quiescent Current

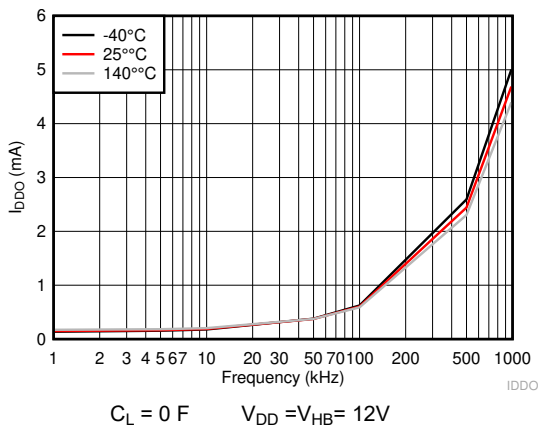


Figure 6-4. VDD Operating Current

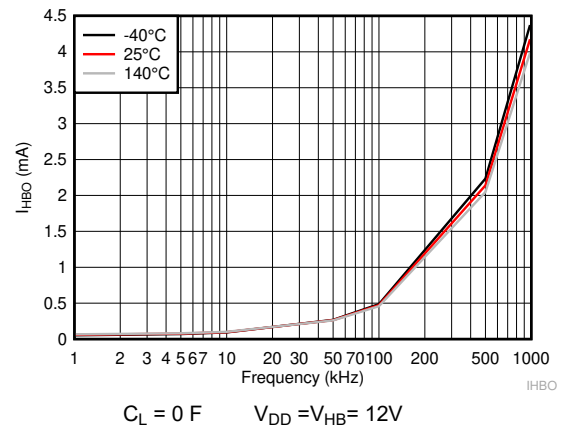


Figure 6-5. HB Operating Current

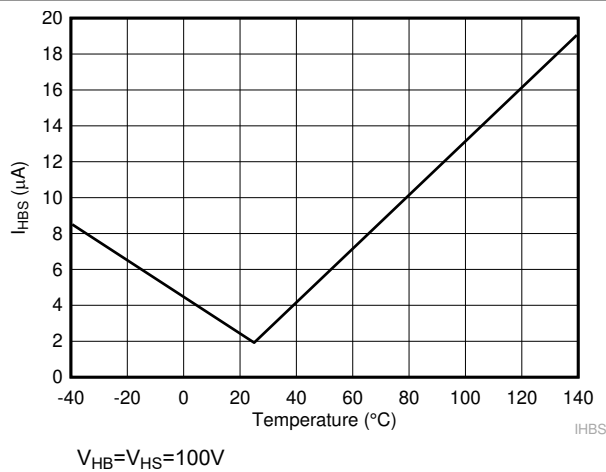


Figure 6-6. HB to VSS Quiescent Current

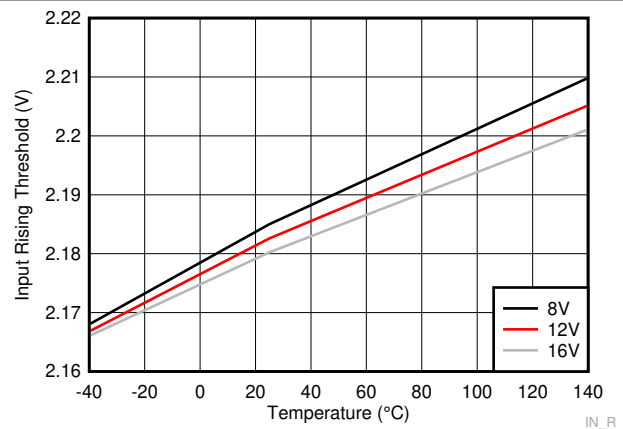
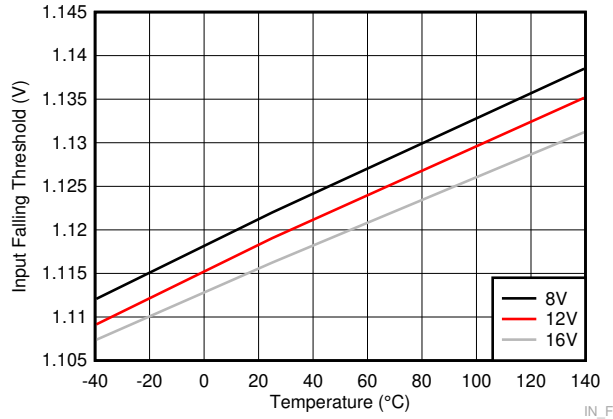
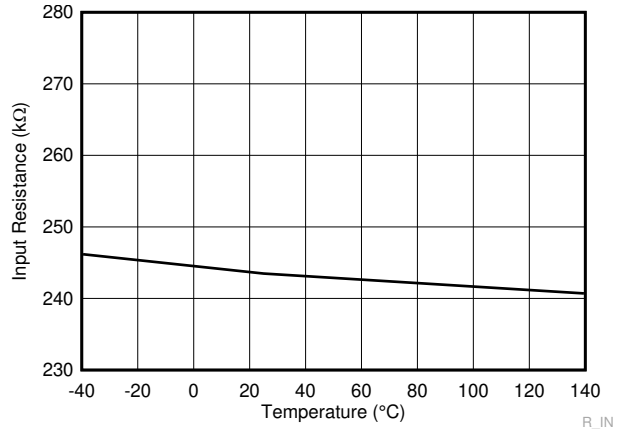


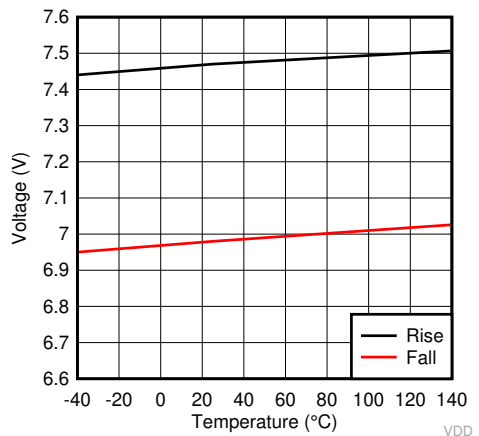
Figure 6-7. Input Rising Threshold



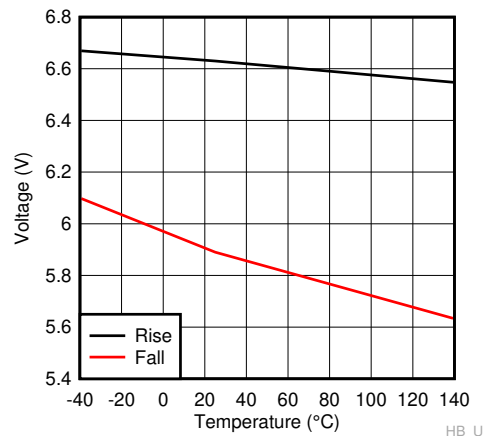
**Figure 6-8. Input Falling Threshold**



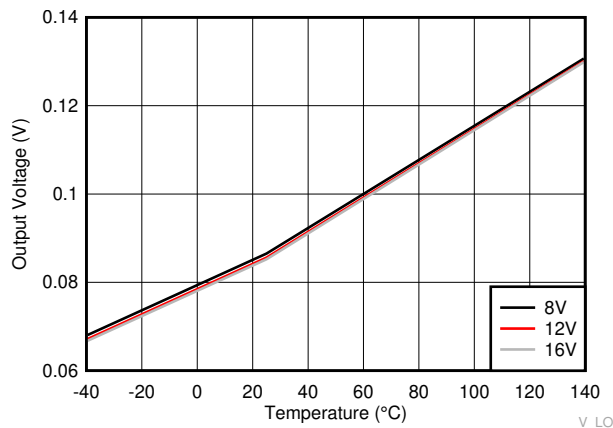
**Figure 6-9. Input Pull-down Resistor**



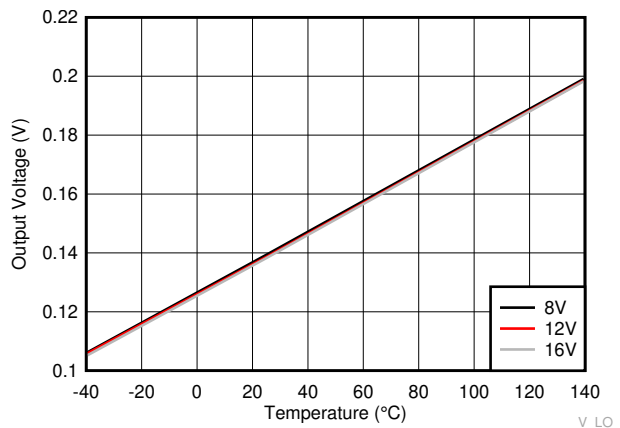
**Figure 6-10. VDD UVLO Threshold**



**Figure 6-11. HB UVLO Threshold**

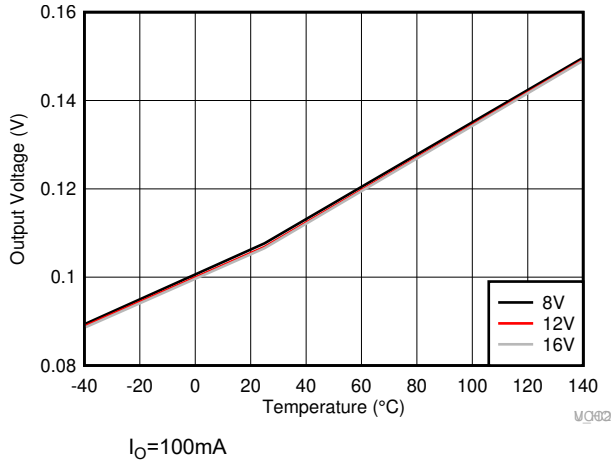


**Figure 6-12. LO Low Output Voltage ( $V_{LOL}$ )**  
 $I_O=100mA$

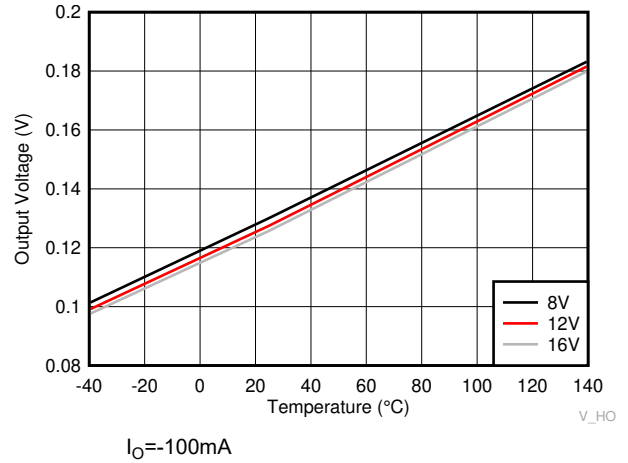


**Figure 6-13. LO High Output Voltage ( $V_{LOH}$ )**  
 $I_O=-100mA$

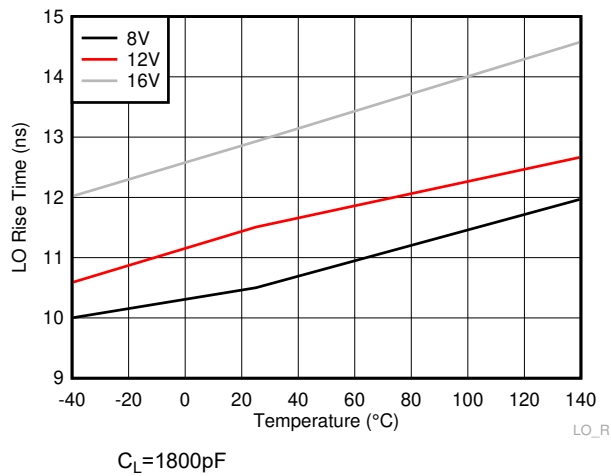




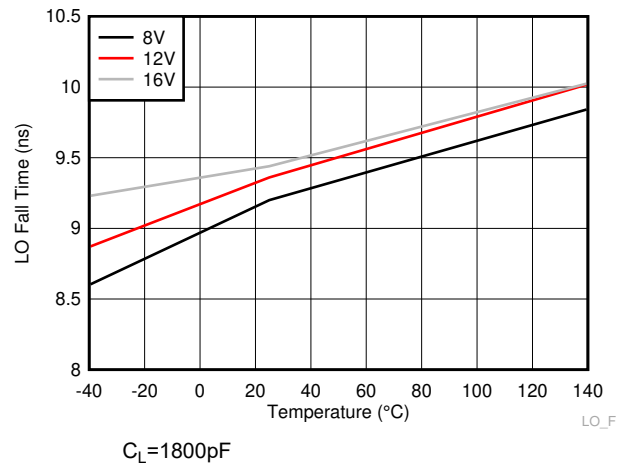
**Figure 6-14. HO Low Output Voltage ( $V_{HOL}$ )**



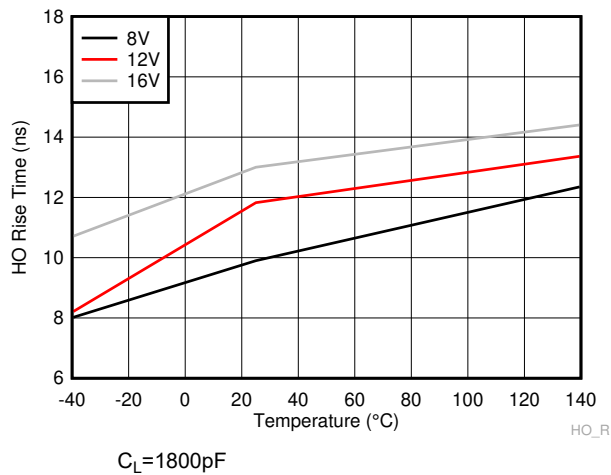
**Figure 6-15. HO High Output Voltage ( $V_{HOH}$ )**



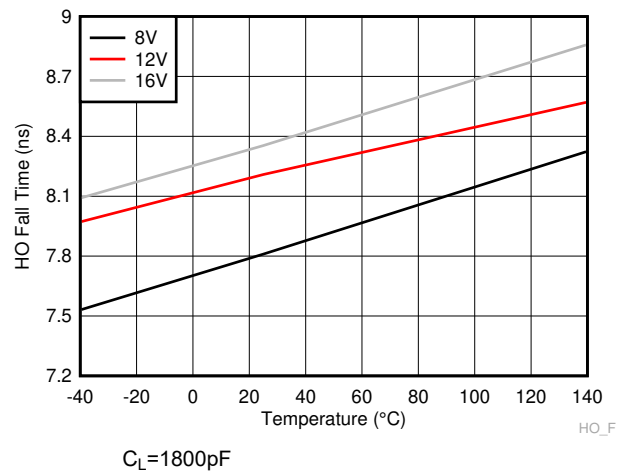
**Figure 6-16. LO Rise Time**



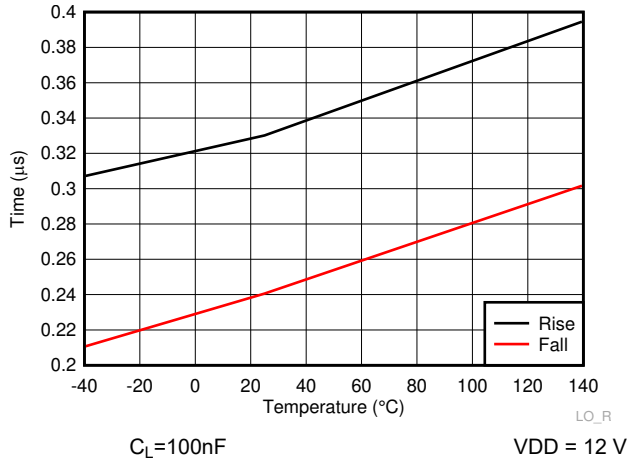
**Figure 6-17. LO Fall Time**



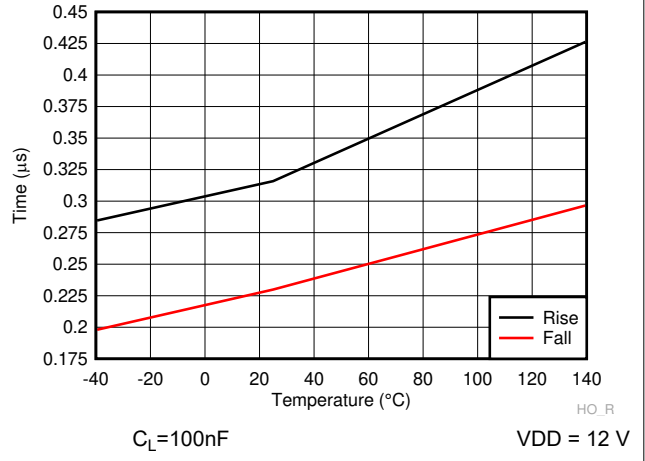
**Figure 6-18. HO Rise Time**



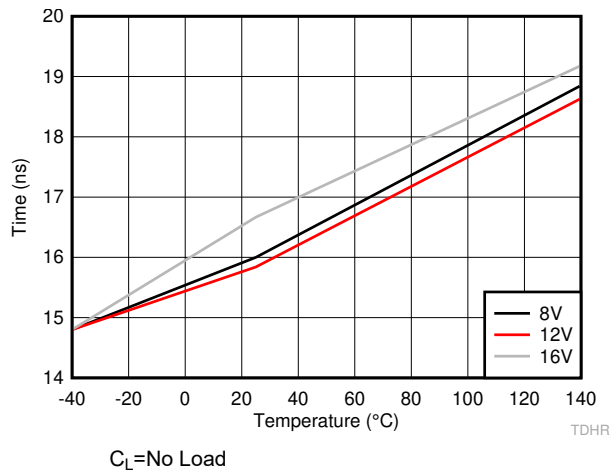
**Figure 6-19. HO Fall Time**



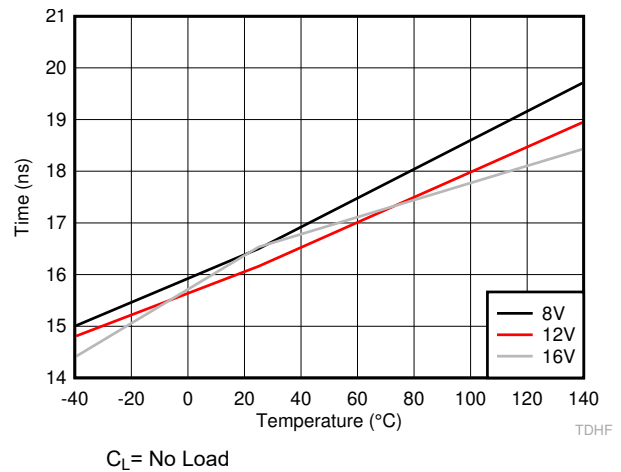
**Figure 6-20. LO Rise & Fall Time**



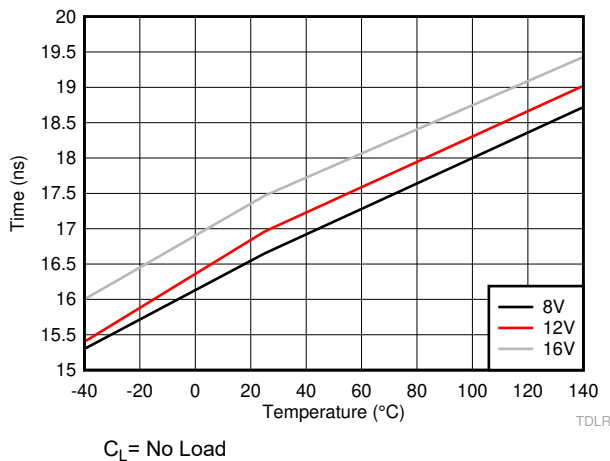
**Figure 6-21. HO Rise & Fall Time**



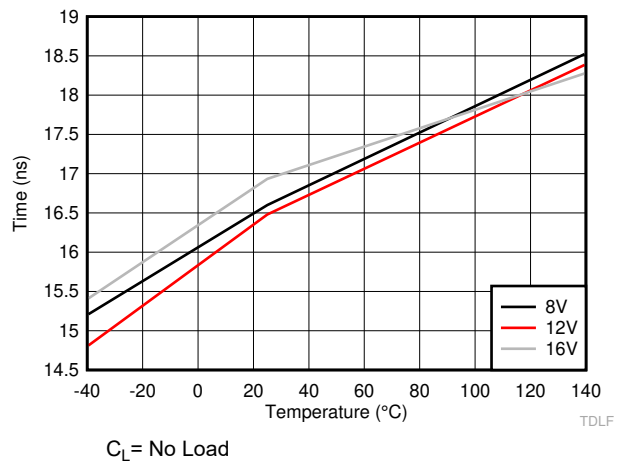
**Figure 6-22. HO Rising Propagation Delay (TDHRR)**



**Figure 6-23. HO Falling Propagation Delay (TDHFF)**



**Figure 6-24. LO Rising Propagation Delay (TDLRR)**



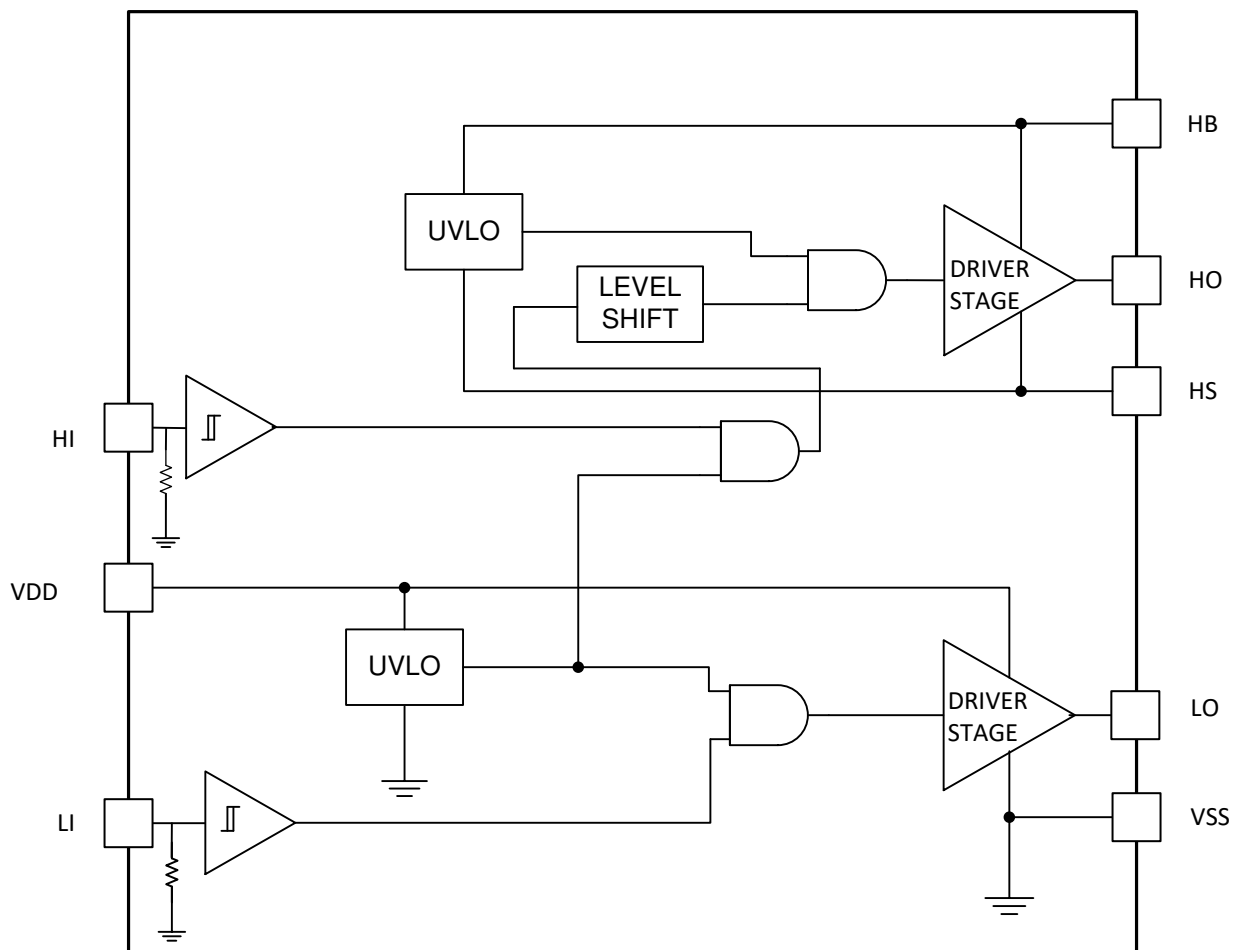
**Figure 6-25. LO Falling Propagation Delay (TDLFF)**

## 7 Detailed Description

### 7.1 Overview

The UCC27288 is a high-voltage gate driver designed to drive both the high-side and the low-side N-channel FETs in a synchronous buck or a half-bridge configurations. The two outputs are independently controlled with two TTL-compatible input signals. The device can also work with CMOS type control signals at its inputs as long as signals meet turn-on and turn-off threshold specifications of the UCC27288. The floating high-side driver is capable of working with HS voltage up to 100 V with respect to VSS. There is no internal bootstrap diode in the UCC27288 device to charge high-side gate drive bootstrap capacitor. An external 100-V (minimum) rated boot diode should be used if bootstrap bias supply is desired for the high-side output. It is also acceptable to use higher voltage external bootstrap diode. A robust level shifter operates at high speed while consuming low power and provides clean level transitions from the control logic to the high-side gate driver. Undervoltage lockout (UVLO) is provided on both the low-side and the high-side power rails.

### 7.2 Functional Block Diagram



Copyright © 2018, Texas Instruments Incorporated

## 7.3 Feature Description

### 7.3.1 Start-up and UVLO

Both the high-side and the low-side driver stages include UVLO protection circuitry which monitors the supply voltage ( $V_{DD}$ ) and the bootstrap capacitor voltage ( $V_{HB-HS}$ ). The UVLO circuit inhibits each output until sufficient supply voltage is available to turn on the external MOSFETs. The built-in UVLO hysteresis prevents chattering during supply voltage variations. When the supply voltage is applied to the VDD pin of the device, both the outputs are held low until VDD exceeds the UVLO threshold, typically 7.0 V. Any UVLO condition on the bootstrap capacitor ( $V_{HB-HS}$ ) disables only the high-side output (HO).

**Table 7-1. VDD UVLO Logic Operation**

Condition ( $V_{HB-HS} > V_{HBR}$ )	HI	LI	HO	LO
$V_{DD}-V_{SS} < V_{DDR}$ during device start-up	H	L	L	L
	L	H	L	L
	H	H	L	L
	L	L	L	L
$V_{DD}-V_{SS} < V_{DDR} - V_{DDH}$ after device start-up	H	L	L	L
	L	H	L	L
	H	H	L	L
	L	L	L	L

**Table 7-2. HB UVLO Logic Operation**

Condition ( $V_{DD} > V_{DDR}$ )	HI	LI	HO	LO
$V_{HB-HS} < V_{HBR}$ during device start-up	H	L	L	L
	L	H	L	H
	H	H	L	H
	L	L	L	L
$V_{HB-HS} < V_{HBR} - V_{HBH}$ after device start-up	H	L	L	L
	L	H	L	H
	H	H	L	H
	L	L	L	L

### 7.3.2 Input Stages

The two inputs operate independent of each other. The two inputs can overlap and output shall follow the input signals. The independence allows for full control of two outputs compared to the gate drivers that have a single input. There is no fixed time de-glitch filter implemented in the device and therefore propagation delay and delay matching are not sacrificed. In other words, there is no built-in dead-time. If the dead time between two outputs is desired then that shall be programmed through the micro-controller. If noise on the input signal is expected in a way that could cause the inputs to overlap then the outputs shall follow the inputs and shoot-through may occur. To avoid such situation small input filter shall be implemented at the front of the gate driver inputs, HI and LI. Because the inputs are independent of supply voltage, they can be connected to outputs of either digital controller or analog controller. Inputs can accept wide slew rate signals and input can withstand negative voltage to increase the robustness. Small filter at the inputs of the driver further improves system robustness in noise prone applications, as mentioned earlier. The inputs have internal pull down resistors with typical value of 250 k $\Omega$ . Thus, when the inputs are floating, the outputs are held low.

### 7.3.3 Level Shifter

The level shift circuit is the interface from the high-side input, which is a VSS referenced signal, to the high-side driver stage which is referenced to the switch node (HS pin). The level shift allows control of the HO output which is referenced to the HS pin. The delay introduced by the level shifter is kept as low as possible and therefore the device provides excellent propagation delay characteristic and delay matching with the low-side driver output. Low delay matching allows power stages to operate with less dead time. The reduction in dead-time is very important in applications where high efficiency is required.

### 7.3.4 Output Stage

The output stages are the interface from level shifter output to the power MOSFETs in the power train. High slew rate, low resistance, and high peak current capability of both outputs allow for efficient switching of the power MOSFETs. The low-side output stage is referenced to VSS and the high-side is referenced to HS. The device output stages are robust to handle harsh environment, such as  $-2$  V transient for 100 ns. The device can also sustain positive transients on the outputs. The device output stages feature a pull-up structure which delivers the highest peak source current when it is most needed, during the Miller plateau region of the power switch turn on transition. The output pull-up and pull-down structure of the device is totem pole NMOS-PMOS structure.

### 7.3.5 Negative Voltage Transients

In most applications, the body diode of the external low-side power MOSFET clamps the HS node to ground. In some situations, board capacitances and inductances can cause the HS node to transiently swing several volts below ground, before the body diode of the external low-side MOSFET clamps this swing. When used in conjunction with the UCC27288, the HS node can swing below ground as long as specifications are not violated and conditions mentioned in this section are followed.

HS must always be at a lower potential than HO. Pulling HO more negative than specified conditions can activate parasitic transistors which may result in excessive current flow from the HB supply. This may result in damage to the device. The same relationship is true with LO and VSS. If necessary, a Schottky diode can be placed externally between HO and HS or LO and VSS to protect the device from this type of transient. The diode must be placed as close to the device pins as possible in order to be effective.

Ensure that the HB to HS operating voltage is 16 V or less. Hence, if the HS pin transient voltage is  $-5$  V, then VDD (and thus HB) is ideally limited to 11 V to keep the HB to HS voltage below 16 V. Generally when HS swings negative, HB follows HS instantaneously and therefore the HB to HS voltage may not significantly overshoot.

Low ESR bypass capacitors from HB to HS and from VDD to VSS are essential for proper operation of the gate driver device. The capacitor should be located at the leads of the device to minimize series inductance. The peak currents from LO and HO can be quite large. Any series inductances with the bypass capacitor causes voltage ringing at the leads of the device which must be avoided for reliable operation.

Based on application board design and other operating parameters, along with HS pin, other pins such as inputs, HI and LI, might also transiently swing below ground. To accommodate such operating conditions UCC27288 input pins are capable of handling absolute maximum of  $-5$ V. As explained earlier, based on the layout and other design constraints, some times the outputs, HO and LO, might also see transient voltages for short durations. Therefore, UCC27288 gate drivers can also handle  $-2$  V 100 ns transients on output pins, HO and LO.

## 7.4 Device Functional Modes

The device operates in normal mode and UVLO mode. See [Start-up and UVLO](#) for more information on UVLO operation mode. In normal mode when the  $V_{DD}$  and  $V_{HB-HS}$  are above UVLO threshold, the output stage is dependent on the states of the HI and LI pins. The output HO and LO will be low if input state is floating.

**Table 7-3. Input/Output Logic in Normal Mode of Operation**

HI	LI	HO <sup>(1)</sup>	LO <sup>(2)</sup>
H	H	H	H
L	H	L	H
H	L	H	L
L	L	L	L
Floating	L	L	L
Floating	H	L	H
L	Floating	L	L
H	Floating	H	L
Floating	Floating	L	L

(1) HO is measured with respect to HS

(2) LO is measured with respect to VSS

## 8 Application and Implementation

---

### Note

Information in the following applications sections is not part of the TI component specification, and TI does not warrant its accuracy or completeness. TI's customers are responsible for determining suitability of components for their purposes. Customers should validate and test their design implementation to confirm system functionality.

---

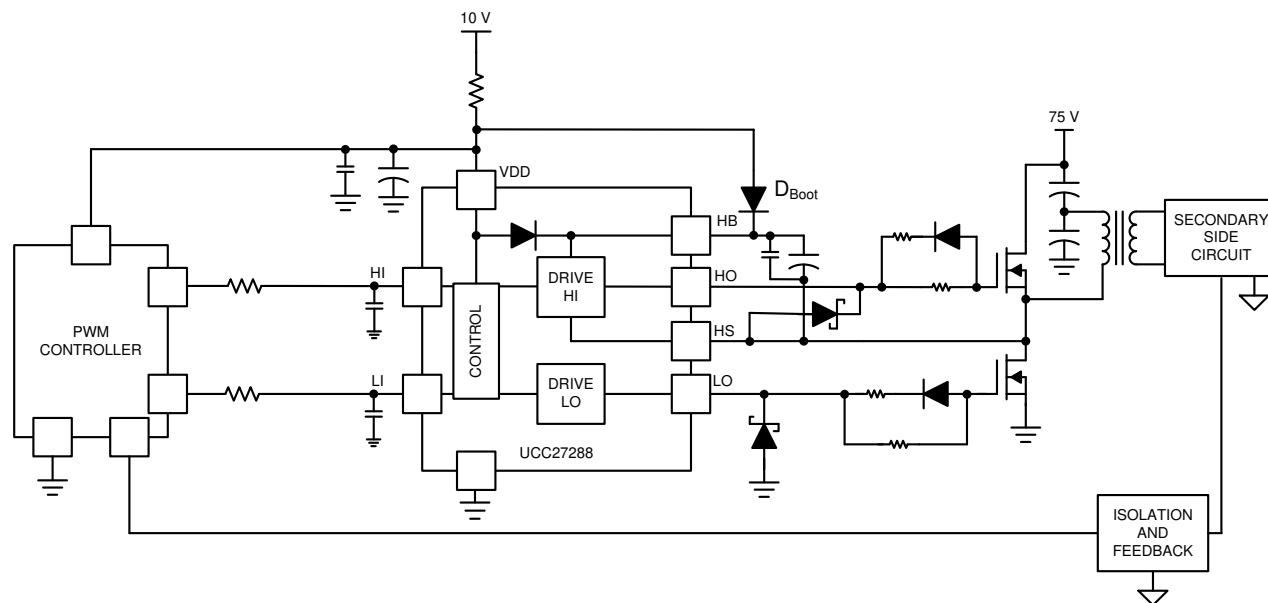
### 8.1 Application Information

Most electronic devices and applications are becoming more and more power hungry. These applications are also reducing in overall size. One way to achieve both high power and low size is to improve the efficiency and distribute the power loss optimally. Most of these applications employ power MOSFETs and they are being switched at higher and higher frequencies. To operate power MOSFETs at high switching frequencies and to reduce associated switching losses, a powerful gate driver is employed between the PWM output of controller and the gates of the power semiconductor devices, such as power MOSFETs, IGBTs, SiC FETs, and GaN FETs. Many of these applications require proper UVLO protection so that power semiconductor devices are turned ON and OFF optimally. Also, gate drivers are indispensable when it is impossible for the PWM controller to directly drive the gates of the switching devices. With the advent of digital power, this situation is often encountered because the PWM signal from the digital controller is often a 3.3-V logic signal which cannot effectively turn on a power switch. A level-shift circuit is needed to boost the 3.3-V signal to the gate-drive voltage (such as 12 V or 5 V) in order to fully turn-on the power device, minimize conduction losses, and minimize the switching losses. Traditional buffer drive circuits based on NPN/PNP bipolar transistors in totem-pole arrangement prove inadequate with digital power because they lack level-shifting capability and under voltage lockout protection. Gate drivers effectively combine both the level-shifting and buffer-drive functions. Gate drivers also solve other problems such as minimizing the effect of high-frequency switching noise (by placing the high-current driver device physically close to the power switch), driving gate-drive transformers and controlling floating power device gates. This helps reduce power dissipation and thermal stress in controllers by moving gate charge power losses from the controller IC to the gate driver.

UCC27288 gate drivers offer high voltage (100 V), small delays (16 ns), and good driving capability ( $\pm 3$ -A) in a single device. The floating high-side driver is capable of operating with switch node voltages up to 100 V. This allows for N-channel MOSFETs control in half-bridge, full-bridge, synchronous buck, synchronous boost, and active clamp topologies. UCC27288 gate driver IC does not have built-in bootstrap diode and therefore to generate high-side bias from the VDD voltage an external boot diode shall be used. This allows users to select application-appropriate external bootstrap diode such as fast recovery and low forward voltage drop Schottky diode. Each channel is controlled by its respective input pins (HI and LI), allowing flexibility to control ON and OFF state of the output.

Switching power devices such as MOSFETs have two main loss components; switching losses and conduction losses. Conduction loss is dominated by current through the device and ON resistance of the device. Switching losses are dominated by gate charge of the switching device, gate voltage of the switching device, and switching frequency. Applications where operating switching frequency is high, the switching losses start to impact overall system efficiency. In such applications, to reduce the switching losses it becomes essential to reduce the gate voltage. The gate voltage is determined by the supply voltage the gate driver ICs, therefore, the gate driver IC needs to operate at lower supply voltage in such applications. UCC27288 gate driver has typical UVLO level of 7.0V and therefore, they are perfectly suitable for applications where bias voltage need to be reduced from 12V to 10V or even 9.5V. HB UVLO is lower than the VDD UVLO so that bootstrap diode voltage drop does not inhibit this lower bias voltage operation. There is enough UVLO hysteresis provided to avoid any chattering or nuisance tripping which improves system robustness.

## 8.2 Typical Application



Copyright © 2020, Texas Instruments Incorporated

**Figure 8-1. Typical Application**

### 8.2.1 Design Requirements

Table below lists the system parameters. UCC27288 needs to operate satisfactorily in conjunction with them.

**Table 8-1. Design Requirements**

Parameter	Value
MOSFET	CSD19535KTT
Maximum Bus/Input Voltage, $V_{in}$	75V
Operating Bias Voltage, $V_{DD}$	10V
Switching Frequency, $F_{sw}$	300kHz
Total Gate Charge of FET at given $V_{DD}$ , $Q_G$	52nC
MOSFET Internal Gate Resistance, $R_{GFET\_Int}$	1.4
Maximum Duty Cycle, $D_{Max}$	0.5
Gate Driver	UCC27288

### 8.2.2 Detailed Design Procedure

#### 8.2.2.1 Select Bootstrap and VDD Capacitor

The bootstrap capacitor must maintain the  $V_{HB-HS}$  voltage above the UVLO threshold for normal operation. Calculate the maximum allowable drop across the bootstrap capacitor,  $\Delta V_{HB}$ , with [Equation 1](#).

$$\begin{aligned} \Delta V_{HB} &= V_{DD} - V_{DH} - V_{HBL} \\ &= (10\text{ V} - 1\text{ V} - (7.1\text{ V} - 0.5\text{ V})) = 2.4\text{ V} \end{aligned} \quad (1)$$

where

- $V_{DD}$  is the supply voltage of gate driver device
- $V_{DH}$  is the bootstrap diode forward voltage drop
- $V_{HBL}$  is the HB falling threshold ( $V_{HBR(max)} - V_{HBH}$ )

In this example the allowed voltage drop across bootstrap capacitor is 2.4 V.



It is generally recommended that ripple voltage on both the bootstrap capacitor and VDD capacitor should be minimized as much as possible. Many of commercial, industrial, and automotive applications use ripple value of 0.5 V.

Use [Equation 2](#) to estimate the total charge needed per switching cycle from bootstrap capacitor.

$$Q_{\text{TOTAL}} = Q_G + I_{\text{HBS}} \times \left( \frac{D_{\text{MAX}}}{f_{\text{SW}}} \right) + \left( \frac{I_{\text{HB}}}{f_{\text{SW}}} \right)$$

$$= 52 \text{ nC} + 0.083 \text{ nC} + 1.33 \text{ nC} = 53.41 \text{ nC} \quad (2)$$

where

- $Q_G$  is the total MOSFET gate charge
- $I_{\text{HBS}}$  is the HB to VSS leakage current from datasheet
- $D_{\text{Max}}$  is the converter maximum duty cycle
- $I_{\text{HB}}$  is the HB quiescent current from the datasheet

The calculated total charge is 53.41 nC.

Next, use [Equation 3](#) to estimate the minimum bootstrap capacitor value.

$$C_{\text{BOOT (min)}} = \frac{Q_{\text{TOTAL}}}{\Delta V_{\text{HB}}} = \frac{53.41 \text{ nC}}{2.4 \text{ V}} = 22.25 \text{ nF} \quad (3)$$

The calculated value of minimum bootstrap capacitor is 22.25 nF. It should be noted that, this value of capacitance is needed at full bias voltage. In practice, the value of the bootstrap capacitor must be greater than calculated value to allow for situations where the power stage may skip pulse due to various transient conditions. It is recommended to use a 100-nF bootstrap capacitor in this example. It is also recommended to include enough margin and place the bootstrap capacitor as close to the HB and HS pins as possible. Also place a small size, 0402, low value, 1000 pF, capacitor to filter high frequency noise, in parallel with main bypass capacitor.

For this application, choose a  $C_{\text{BOOT}}$  capacitor that has the following specifications: 0.1  $\mu\text{F}$ , 25 V, X7R

As a general rule the local VDD bypass capacitor must be greater than the value of bootstrap capacitor value (generally 10 times the bootstrap capacitor value). For this application choose a  $C_{\text{VDD}}$  capacitor with the following specifications: 1  $\mu\text{F}$ , 25 V, X7R

$C_{\text{VDD}}$  capacitor is placed across VDD and VSS pin of the gate driver. Similar to bootstrap capacitors, place a small size and low value capacitor in parallel with the main bypass capacitor. For this application, choose 0402, 1000 pF, capacitance in parallel with main bypass capacitor to filter high frequency noise.

The bootstrap and bias capacitors must be ceramic types with X7R dielectric or better. Choose a capacitor with a voltage rating at least twice the maximum voltage that it will be exposed to. Choose this value because most ceramic capacitors lose significant capacitance when biased. This value also improves the long term reliability of the system.

### 8.2.2.2 External Bootstrap Diode and Series Resistor

The UCC27288 does not incorporate the bootstrap diode necessary to generate the high-side bias for HO to work satisfactorily. The characteristics of this diode are important to achieve efficient, reliable operation. The characteristics to consider are reverse voltage handling capability, repetitive peak forward current, forward voltage drop, forward and reverse recovery time, and dynamic resistance. As the UCC27288 is 100V rated gate driver, the external bootstrap diode must be at least 100V rated. Peak forward current rating depends on multiple system parameters such as high-side and low-side duty cycle, value of bootstrap capacitor, value of series resistor, and allowed voltage ripple on the bootstrap capacitor. Generally, low forward voltage drop diodes are preferred for low power loss during charging of the bootstrap capacitor. Schottky diodes have low forward voltage drop and can be used with the UCC27288. The dynamic characteristics to consider are diode recovery time and stored charge. Diode that has less than 50ns of forward and reverse recovery times is suitable in most applications.

Specifically in very high switching frequency applications, for example in excess of 1 MHz, and where the low-side minimum pulse widths are very small, the diode peak forward current could be very high and peak reverse current could also be very high, specifically if high bootstrap capacitor value has been chosen. In such applications it might be advisable to use Schottkey diode as bootstrap diode and provision of external series resistor. MURS210 diode with 1 Ohm series resistor will work with the application example described here.

### 8.2.2.3 Estimate Driver Power Losses

The total power loss in gate driver device such as the UCC27288 is the summation of the power loss in different functional blocks of the gate driver device. These power loss components are explained in this section.

1. Equation 4 describes how quiescent currents ( $I_{DD}$  and  $I_{HB}$ ) affect the static power losses,  $P_{QC}$ .

$$P_{QC} = (V_{DD} \times I_{DD}) + (V_{DD} - V_{DH}) \times I_{HB}$$

$$= 10 \text{ V} \times 0.4 \text{ mA} + 9 \text{ V} \times 0.4 \text{ mA} = 7.6 \text{ mW} \quad (4)$$

it is not shown here, but for more conservative approximation, add no load operating current,  $I_{DDO}$  and  $I_{HBO}$  in above equation.

2. Equation 5 shows how high-side to low-side leakage current ( $I_{HBS}$ ) affects level-shifter losses ( $P_{IHBS}$ ).

$$P_{IHBS} = V_{HB} \times I_{HBS} \times D = 85 \text{ V} \times 50 \mu\text{A} \times 0.5 = 2.12 \text{ mW} \quad (5)$$

where

- $D$  is the high-side MOSFET duty cycle
- $V_{HB}$  is the sum of input voltage and voltage across bootstrap capacitor.

3. Equation 6 shows how MOSFETs gate charge ( $Q_G$ ) affects the dynamic losses,  $P_{QG}$ .

$$P_{QG} = 2 \times V_{DD} \times Q_G \times f_{SW} \times \frac{R_{GD\_R}}{R_{GD\_R} + R_{GATE} + R_{GFET(int)}}$$

$$= 2 \times 10 \text{ V} \times 52 \text{ nC} \times 300 \text{ kHz} \times 0.74 = 0.23 \text{ W} \quad (6)$$

where

- $Q_G$  is the total MOSFET gate charge
- $f_{SW}$  is the switching frequency
- $R_{GD\_R}$  is the average value of pullup and pulldown resistor
- $R_{GATE}$  is the external gate drive resistor
- $R_{GFET(int)}$  is the power MOSFETs internal gate resistor

Assume there is no external gate resistor in this example. The average value of maximum pull-up and pull down resistance of the driver output section is approximately 4  $\Omega$ . Substitute the application values to calculate the dynamic loss due to gate charge, which is 230 mW here.

4. Equation 7 shows how parasitic level-shifter charge ( $Q_P$ ) on each switching cycle affects dynamic losses, ( $P_{LS}$ ) during high-side switching.

$$P_{LS} = V_{HB} \times Q_P \times f_{SW} \quad (7)$$

For this example and simplicity, it is assumed that value of parasitic charge  $Q_P$  is 1 nC. Substituting values results in 25.5 mW as level shifter dynamic loss. This estimate is very high for level shifter dynamic losses.

The sum of all the losses is 265.22 mW as a total gate driver loss. As shown in this example, in most applications the dynamic loss due to gate charge dominates the total power loss in gate driver device. For gate drivers that include bootstrap diode, one should also estimate losses in bootstrap diode. Diode forward conduction loss is computed as product of average forward voltage drop and average forward current.

Equation 8 estimates the maximum allowable power loss of the device for a given ambient temperature.

$$P_{MAX} = \frac{(T_J - T_A)}{R_{\theta JA}} \quad (8)$$

where

- $P_{MAX}$  is the maximum allowed power dissipation in the gate driver device
- $T_J$  is the recommended maximum operating junction temperature
- $T_A$  is the ambient temperature of the gate driver device
- $R_{\theta JA}$  is the junction-to-ambient thermal resistance

To better estimate the junction temperature of the gate driver device in the application, it is recommended to first accurately measure the case temperature and then determine the power dissipation in a given application. Then use  $\psi_{JT}$  to calculate junction temperature. After estimating junction temperature and measuring ambient temperature in the application, calculate  $\theta_{JA(\text{effective})}$ . Then, if design parameters (such as the value of an external gate resistor or power MOSFET) change during the development of the project, use  $\theta_{JA(\text{effective})}$  to estimate how these changes affect junction temperature of the gate driver device.

The [Thermal Information](#) table summarizes the thermal metrics for the driver package. For detailed information regarding the thermal information table, please refer to the [Semiconductor and Device Package Thermal Metrics](#) application report.

#### 8.2.2.4 Selecting External Gate Resistor

In high-frequency switching power supply applications where high-current gate drivers such as the UCC27288 are used, parasitic inductances, parasitic capacitances and high-current loops can cause noise and ringing on the gate of power MOSFETs. Often external gate resistors are used to damp this ringing and noise. In some applications the gate charge, which is load on gate driver device, is significantly larger than gate driver peak output current capability. In such applications external gate resistors can limit the peak output current of the gate driver. It is recommended that there should be provision of external gate resistor whenever the layout or application permits.

Use [Equation 9](#) to calculate the driver high-side pull-up current.

$$I_{OHH} = \frac{V_{DD} - V_{DH}}{R_{HOH} + R_{GATE} + R_{GFET(int)}} \quad (9)$$

where

- $I_{OHH}$  is the high-side, peak pull-up current
- $V_{DH}$  is the bootstrap diode forward voltage drop
- $R_{HOH}$  is the gate driver internal high-side pull-up resistor. Value either directly provided in datasheet or can be calculated from test conditions ( $R_{HOH} = V_{HOH}/I_{HO}$ )
- $R_{GATE}$  is the external gate resistance connected between driver output and power MOSFET gate
- $R_{GFET(int)}$  is the MOSFET internal gate resistance provided by MOSFET datasheet

Use [Equation 10](#) to calculate the driver high-side sink current.

$$I_{OLH} = \frac{V_{DD} - V_{DH}}{R_{HOL} + R_{GATE} + R_{GFET(int)}} \quad (10)$$

where

- $R_{HOL}$  is the gate driver internal high-side pull-down resistance

Use [Equation 11](#) to calculate the driver low-side source current.

$$I_{OHL} = \frac{V_{DD}}{R_{LOH} + R_{GATE} + R_{GFET(int)}} \quad (11)$$

where

- $R_{LOH}$  is the gate driver internal low-side pull-up resistance

Use [Equation 12](#) to calculate the driver low-side sink current.

$$I_{OLL} = \frac{V_{DD}}{R_{LOL} + R_{GATE} + R_{GFET(int)}} \quad (12)$$

where

- $R_{LOL}$  is the gate driver internal low-side pull-down resistance

Both high and low-side channels of the gate driver have a peak current rating of  $\pm 3$  A. These equations help reduce the peak current if needed. To establish different rise time value compared to fall time value, external gate resistor can be anti-paralleled with diode-resistor combination as shown in [Figure 8-1](#). Generally selecting an optimal value or configuration of external gate resistor is an iterative process. For additional information on selecting external gate resistor please refer to [External Gate Resistor Design Guide for Gate Drivers](#)

#### 8.2.2.5 Delays and Pulse Width

The total delay encountered in the PWM, driver and power stage need to be considered for a number of reasons, primarily delay in current limit response. Also to be considered are differences in delays between the drivers which can lead to various concerns depending on the topology. The synchronous buck topology switching requires careful selection of dead-time between the high-side and low-side switches to avoid cross conduction as well as excessive body diode conduction.

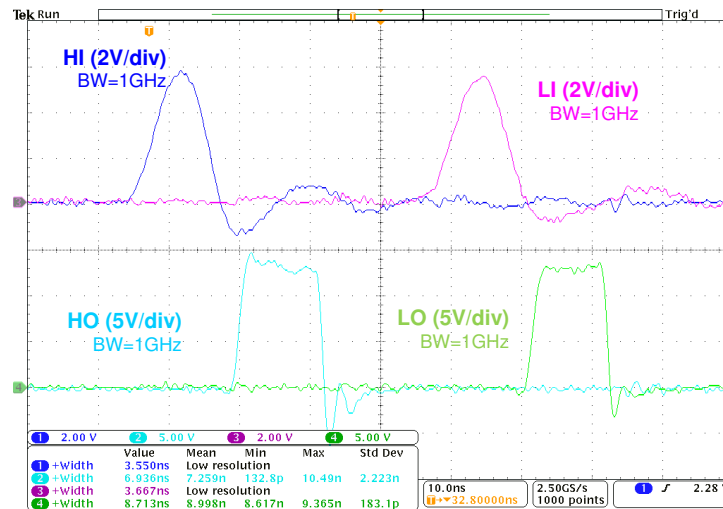
Bridge topologies can be affected by a volt-second imbalance on the transformer if there is imbalance in the high-side and low-side pulse widths in any operating condition. The UCC27288 device has maximum propagation delay, across process, and temperature variation, of 30 ns and delay matching of 7 ns, which is one of the best in the industry.

Narrow input pulse width performance is an important consideration in gate driver devices, because output may not follow input signals satisfactorily when input pulse widths are very narrow. Although there may be relatively wide steady state PWM output signals from controller, very narrow pulses may be encountered under following operating conditions.

- soft-start period
- large load transients
- short circuit conditions

These narrow pulses appear as an input signal to the gate driver device and the gate driver device need to respond properly to these narrow signals.

[Figure 8-2](#) shows that the UCC27288 device produces reliable output pulse even when the input pulses are very narrow. The propagation delay and delay matching do not get affected when the input pulse width is very narrow.



**Figure 8-2. Input and Output Pulse Width**

### 8.2.2.6 VDD and Input Filter

Some switching power supply applications are extremely noisy. Noise may come from ground bouncing and ringing at the inputs, (which are the HI and LI pins of the gate driver device). To mitigate such situations, the UCC27288 offers both negative input voltage handling capability and wide input threshold hysteresis. If these features are not enough, then the application might need an input filter. Small filter such as 10-Ω resistor and 47-pF capacitor might be sufficient to filter noise at the inputs of the gate driver device. This RC filter would introduce delay and therefore need to be considered carefully. High frequency noise on bias supply can cause problems in performance of the gate driver device. To filter this noise it is recommended to use 1-Ω resistor in series with VDD pin as shown in Figure 8-1. This resistor also acts as a current limiting element. In the event of short circuit on the bias rail, this resistor opens up and prevents further damage. This resistor can also be helpful in debugging the design during development phase.

### 8.2.2.7 Transient Protection

As mentioned in previous sections, high power high switching frequency power supplies are inherently noisy. High dV/dt and dI/dt in the circuit can cause negative voltage on different pins such as HO, LO, and HS. The device tolerates negative voltage on all of these pins as mentioned in specification tables. If parasitic elements of the circuit cause very large negative swings, circuit might require additional protection. In such cases fast acting and low leakage type Schottky diode should be used. This diode must be placed as close to the gate driver device pin as possible for it to be effective in clamping excessive negative voltage on the gate driver device pin. Sometimes a small resistor, (for example 2 Ω, in series with HS pin) is also effective in improving performance reliability. To avoid the possibility of driver device damage due to over-voltage on its output pins or supply pins, low leakage Zener diode can be used. A 15-V Zener diode is often sufficient to clamp the voltage below the maximum recommended value of 16 V.

### 8.2.3 Application Curves

To minimize the switching losses in power supplies, turn-ON and turn-OFF of the power MOSFETs need to be as fast as possible. Higher the drive current capability of the driver, faster the switching. Therefore, the UCC27288 is designed with high drive current capability and low resistance of the output stages. One of the common way to test the drive capability of the gate driver device, is to test it under heavy load. Rise time and fall time of the outputs would provide idea of drive capability of the gate driver device. There must not be any resistance in this test circuit. Figure 8-3 and Figure 8-4 shows rise time and fall time of HO respectively of UCC27288. Figure 8-5 and Figure 8-6 shows rise time and fall time of LO respectively of UCC27288. For accuracy purpose, the VDD and HB pin of the gate driver device were connected together. HS and VSS pins are also connected together for this test.

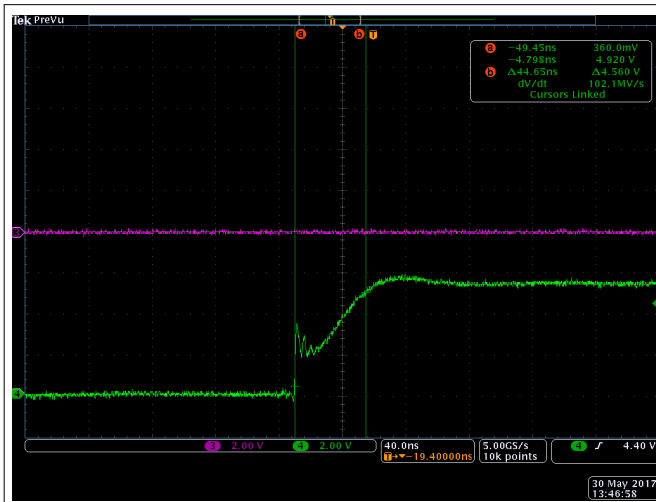
Peak current capability can be estimated using the fastest dV/dt along the rise and fall curve of the plot. This method is also useful in comparing performance of two or more gate driver devices.

**UCC27288**

SLUSE21B – JUNE 2020 – REVISED APRIL 2022

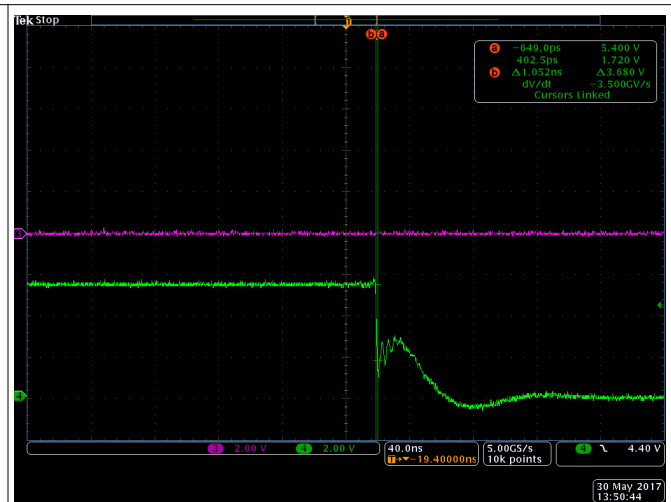
As explained in Section 8.2.2.5, propagation delay plays an important role in reliable operation of many applications. Figure 8-7 and Figure 8-8

Figure 8-8 shows propagation delay and delay matching of UCC27288.



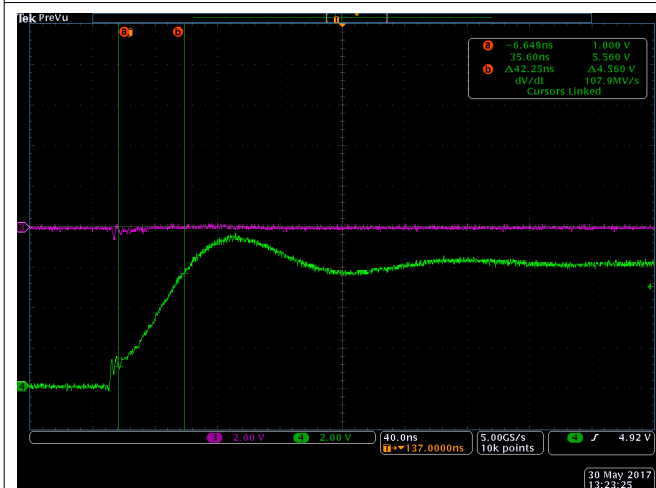
$V_{DD}=V_{HB}=6\text{ V}$ ,  $HS=V_{SS}$   $C_{LOAD}=10\text{ nF}$  Ch4=HO

**Figure 8-3. HO Rise Time**



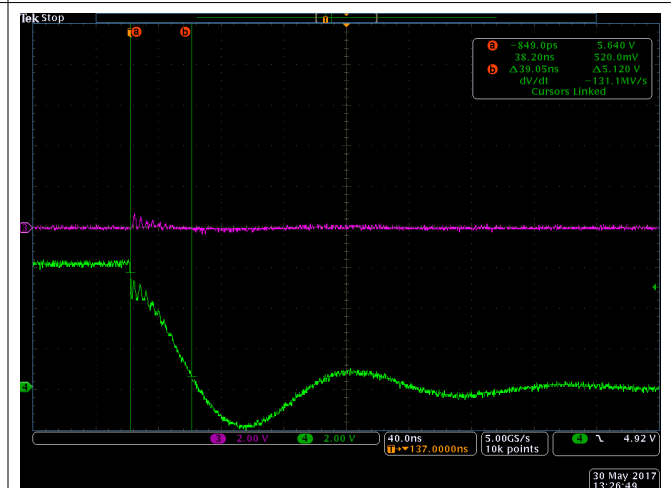
$V_{DD}=V_{HB}=6\text{ V}$ ,  $HS=V_{SS}$   $C_{LOAD}=10\text{ nF}$  Ch4=HO

**Figure 8-4. HO Fall Time**



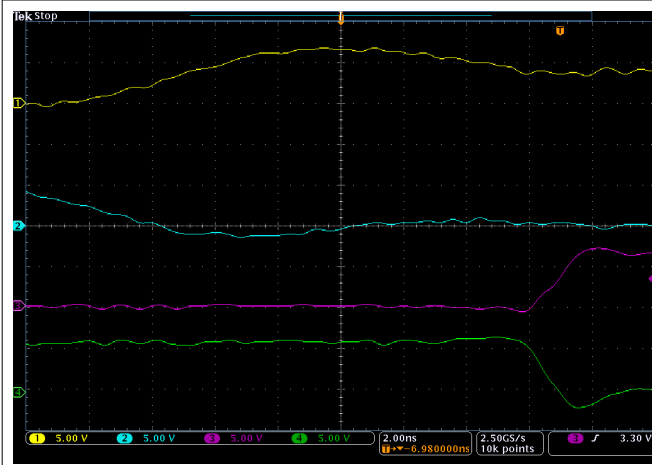
$V_{DD}=V_{HB}=6\text{ V}$ ,  $HS=V_{SS}$   $C_{LOAD}=10\text{ nF}$  Ch4=LO

**Figure 8-5. LO Rise Time**



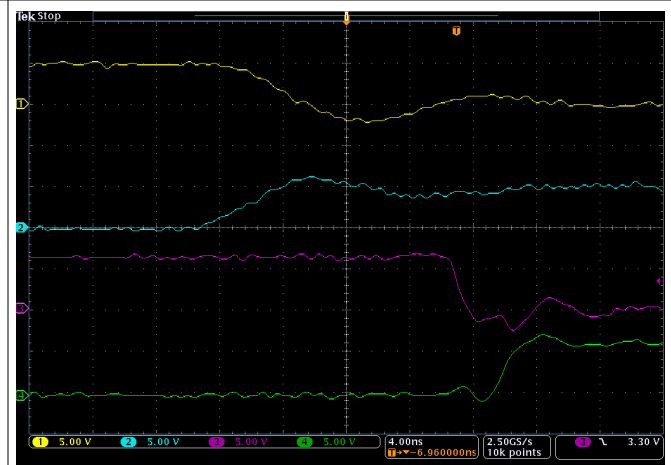
$V_{DD}=V_{HB}=6\text{ V}$ ,  $HS=V_{SS}$   $C_{LOAD}=10\text{ nF}$  Ch4=LO

**Figure 8-6. LO Fall Time**



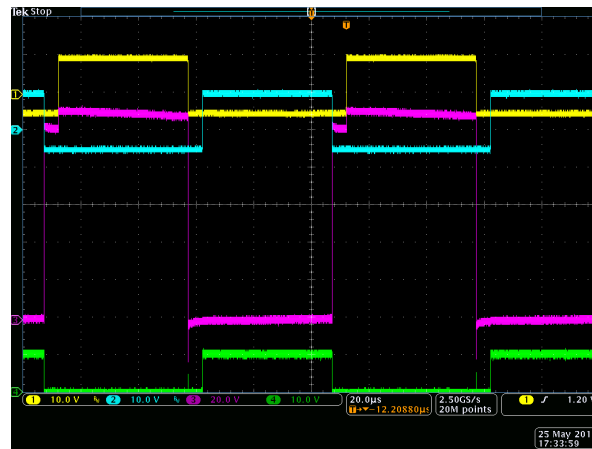
$V_{DD}=6\text{ V}$   $C_{LOAD}=2\text{ nF}$  Ch1=HI Ch2=LI Ch3=HO Ch4=LO

**Figure 8-7. Propagation Delay and Delay Matching**



$V_{DD}=6\text{ V}$   $C_{LOAD}=2\text{ nF}$  Ch1=HI Ch2=LI Ch3=HO Ch4=LO

**Figure 8-8. Propagation Delay and Delay Matching**



$V_{DD}=10\text{ V}$   $V_{in}=100\text{ V}$

$C_L=1\text{ nF}$

Ch1=HI Ch2=LI Ch3=HO Ch4=LO

**Figure 8-9. Input Negative Voltage**

## 9 Power Supply Recommendations

The recommended bias supply voltage range for UCC27288 is from 8 V to 16 V. The lower end of this range is governed by the internal under voltage-lockout (UVLO) protection feature, 7.0 V typical, of the  $V_{DD}$  supply circuit block. The upper end of this range is driven by the 16-V recommended maximum voltage rating of the  $V_{VDD}$ . It is recommended that voltage on VDD pin should be lower than maximum recommended voltage.

The UVLO protection feature also involves a hysteresis function. This means that once the device is operating in normal mode, if the VDD voltage drops, the device continues to operate in normal mode as far as the voltage drop do not exceeds the hysteresis specification,  $V_{DDHYS}$ . If the voltage drop is more than hysteresis specification, the device shuts down. Therefore, while operating at or near the 8-V range, the voltage ripple on the auxiliary power supply output should be smaller than the hysteresis specification of UCC27288 to avoid triggering device shutdown.

A local bypass capacitor should be placed between the VDD and GND pins. This capacitor should be located as close to the device as possible. A low ESR, ceramic surface mount capacitor is recommended. It is recommended to use two capacitors across VDD and GND: a low capacitance ceramic surface-mount capacitor for high frequency filtering placed very close to VDD and GND pin, and another high capacitance value surface-mount capacitor for device bias requirements. In a similar manner, the current pulses delivered by the HO pin are sourced from the HB pin. Therefore, two capacitors across the HB to HS are recommended. One low value small size capacitor for high frequency filtering and another one high capacitance value capacitor to deliver HO pulses.

In applications where noise is very dominant and there is space on the PWB (Printed Wiring Board), it is recommended to place a small RC filter at the inputs. This allows for improving the overall performance of the design. In such applications, it is also recommended to have a place holder for power MOSFET external gate resistor. This resistor allows the control of not only the drive capability but also the slew rate on HS, which impacts the performance of the high-side circuit. If diode is used across the external gate resistor, it is recommended to use a resistor in series with the diode, which provides further control of fall time.

In power supply applications such as motor drives, there exist lot of transients through-out the system. This sometime causes over voltage and under voltage spikes on almost all pins of the gate driver device. To increase the robustness of the design, it is recommended that the clamp diode should be used on HO and LO pins. If user does not wish to use power MOSFET parasitic diode, external clamp diode on HS pin is recommended, which needs to be high voltage high current type (same rating as MOSFET) and very fast acting. The leakage of these diodes across the temperature needs to be minimal.

In power supply applications where it is almost certain that there is excessive negative HS voltage, it is recommended to place a small resistor between the HS pin and the switch node. This resistance helps limit current into the driver device up to some extent. This resistor will impact the high side drive capability and therefore needs to be considered carefully.



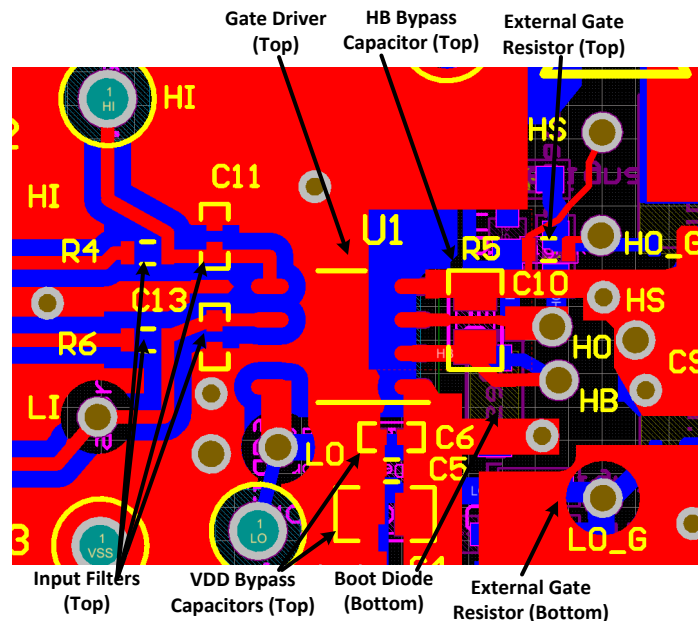
## 10 Layout

### 10.1 Layout Guidelines

To achieve optimum performance of high-side and low-side gate drivers, one must consider following printed wiring board (PWB) layout guidelines.

- Low ESR/ESL capacitors must be connected close to the device between VDD and VSS pins and between HB and HS pins to support high peak currents drawn from VDD and HB pins during the turn-on of the external MOSFETs.
- To prevent large voltage transients at the drain of the top MOSFET, a low ESR electrolytic capacitor and a good quality ceramic capacitor must be connected between the high side MOSFET drain and ground (VSS).
- In order to avoid large negative transients on the switch node (HS) pin, the parasitic inductances between the source of the high-side MOSFET and the source of the low-side MOSFET (synchronous rectifier) must be minimized.
- Overlapping of HS plane and ground (VSS) plane should be minimized as much as possible so that coupling of switching noise into the ground plane is minimized.
- Thermal pad should be connected to large heavy copper plane to improve the thermal performance of the device. Generally it is connected to the ground plane which is the same as VSS of the device. It is recommended to connect this pad to the VSS pin only.
- Grounding considerations:
  - The first priority in designing grounding connections is to confine the high peak currents that charge and discharge the MOSFET gates to a minimal physical area. This confinement decreases the loop inductance and minimize noise issues on the gate terminals of the MOSFETs. Place the gate driver as close to the MOSFETs as possible.
  - The second consideration is the high current path that includes the bootstrap capacitor, the bootstrap diode, the local ground referenced bypass capacitor, and the low-side MOSFET body diode. The bootstrap capacitor is recharged on a cycle-by-cycle basis through the bootstrap diode from the ground referenced VDD bypass capacitor. The recharging occurs in a short time interval and involves high peak current. Minimizing this loop length and area on the circuit board is important to ensure reliable operation.

### 10.2 Layout Example



**Figure 10-1. Layout Example**

## 11 Device and Documentation Support

### 11.1 Receiving Notification of Documentation Updates

To receive notification of documentation updates, navigate to the device product folder on [ti.com](http://ti.com). Click on *Subscribe to updates* to register and receive a weekly digest of any product information that has changed. For change details, review the revision history included in any revised document.

### 11.2 Support Resources

TI E2E™ [support forums](#) are an engineer's go-to source for fast, verified answers and design help — straight from the experts. Search existing answers or ask your own question to get the quick design help you need.

Linked content is provided "AS IS" by the respective contributors. They do not constitute TI specifications and do not necessarily reflect TI's views; see TI's [Terms of Use](#).

### 11.3 Trademarks

TI E2E™ is a trademark of Texas Instruments.

All trademarks are the property of their respective owners.

### 11.4 Electrostatic Discharge Caution



This integrated circuit can be damaged by ESD. Texas Instruments recommends that all integrated circuits be handled with appropriate precautions. Failure to observe proper handling and installation procedures can cause damage.

ESD damage can range from subtle performance degradation to complete device failure. Precision integrated circuits may be more susceptible to damage because very small parametric changes could cause the device not to meet its published specifications.

### 11.5 Glossary

[TI Glossary](#) This glossary lists and explains terms, acronyms, and definitions.

## 12 Mechanical, Packaging, and Orderable Information

The following pages include mechanical, packaging, and orderable information. This information is the most current data available for the designated devices. This data is subject to change without notice and revision of this document. For browser-based versions of this data sheet, refer to the left-hand navigation.

**PACKAGING INFORMATION**

Orderable part number	Status (1)	Material type (2)	Package   Pins	Package qty   Carrier	RoHS (3)	Lead finish/ Ball material (4)	MSL rating/ Peak reflow (5)	Op temp (°C)	Part marking (6)
<a href="#">UCC27288D</a>	Active	Production	SOIC (D)   8	75   TUBE	Yes	NIPDAU	Level-2-260C-1 YEAR	-40 to 125	U288
UCC27288D.A	Active	Production	SOIC (D)   8	75   TUBE	Yes	NIPDAU	Level-2-260C-1 YEAR	-40 to 125	U288
<a href="#">UCC27288DR</a>	Active	Production	SOIC (D)   8	2500   LARGE T&R	Yes	NIPDAU	Level-2-260C-1 YEAR	-40 to 125	U288
UCC27288DR.A	Active	Production	SOIC (D)   8	2500   LARGE T&R	Yes	NIPDAU	Level-2-260C-1 YEAR	-40 to 125	U288
UCC27288DRG4	Active	Production	SOIC (D)   8	2500   LARGE T&R	Yes	NIPDAU	Level-2-260C-1 YEAR	-40 to 125	U288
UCC27288DRG4.A	Active	Production	SOIC (D)   8	2500   LARGE T&R	Yes	NIPDAU	Level-2-260C-1 YEAR	-40 to 125	U288

(1) **Status:** For more details on status, see our [product life cycle](#).

(2) **Material type:** When designated, preproduction parts are prototypes/experimental devices, and are not yet approved or released for full production. Testing and final process, including without limitation quality assurance, reliability performance testing, and/or process qualification, may not yet be complete, and this item is subject to further changes or possible discontinuation. If available for ordering, purchases will be subject to an additional waiver at checkout, and are intended for early internal evaluation purposes only. These items are sold without warranties of any kind.

(3) **RoHS values:** Yes, No, RoHS Exempt. See the [TI RoHS Statement](#) for additional information and value definition.

(4) **Lead finish/Ball material:** Parts may have multiple material finish options. Finish options are separated by a vertical ruled line. Lead finish/Ball material values may wrap to two lines if the finish value exceeds the maximum column width.

(5) **MSL rating/Peak reflow:** The moisture sensitivity level ratings and peak solder (reflow) temperatures. In the event that a part has multiple moisture sensitivity ratings, only the lowest level per JEDEC standards is shown. Refer to the shipping label for the actual reflow temperature that will be used to mount the part to the printed circuit board.

(6) **Part marking:** There may be an additional marking, which relates to the logo, the lot trace code information, or the environmental category of the part.

Multiple part markings will be inside parentheses. Only one part marking contained in parentheses and separated by a "~" will appear on a part. If a line is indented then it is a continuation of the previous line and the two combined represent the entire part marking for that device.

**Important Information and Disclaimer:** The information provided on this page represents TI's knowledge and belief as of the date that it is provided. TI bases its knowledge and belief on information provided by third parties, and makes no representation or warranty as to the accuracy of such information. Efforts are underway to better integrate information from third parties. TI has taken and continues to take reasonable steps to provide representative and accurate information but may not have conducted destructive testing or chemical analysis on incoming materials and chemicals. TI and TI suppliers consider certain information to be proprietary, and thus CAS numbers and other limited information may not be available for release.

In no event shall TI's liability arising out of such information exceed the total purchase price of the TI part(s) at issue in this document sold by TI to Customer on an annual basis.





D0008A

# PACKAGE OUTLINE

SOIC - 1.75 mm max height

SMALL OUTLINE INTEGRATED CIRCUIT



4214825/C 02/2019

### NOTES:

1. Linear dimensions are in inches [millimeters]. Dimensions in parenthesis are for reference only. Controlling dimensions are in inches. Dimensioning and tolerancing per ASME Y14.5M.
2. This drawing is subject to change without notice.
3. This dimension does not include mold flash, protrusions, or gate burrs. Mold flash, protrusions, or gate burrs shall not exceed  $.006$  [0.15] per side.
4. This dimension does not include interlead flash.
5. Reference JEDEC registration MS-012, variation AA.

# EXAMPLE BOARD LAYOUT

D0008A

SOIC - 1.75 mm max height

SMALL OUTLINE INTEGRATED CIRCUIT



LAND PATTERN EXAMPLE  
EXPOSED METAL SHOWN  
SCALE:8X



SOLDER MASK DETAILS

4214825/C 02/2019

NOTES: (continued)

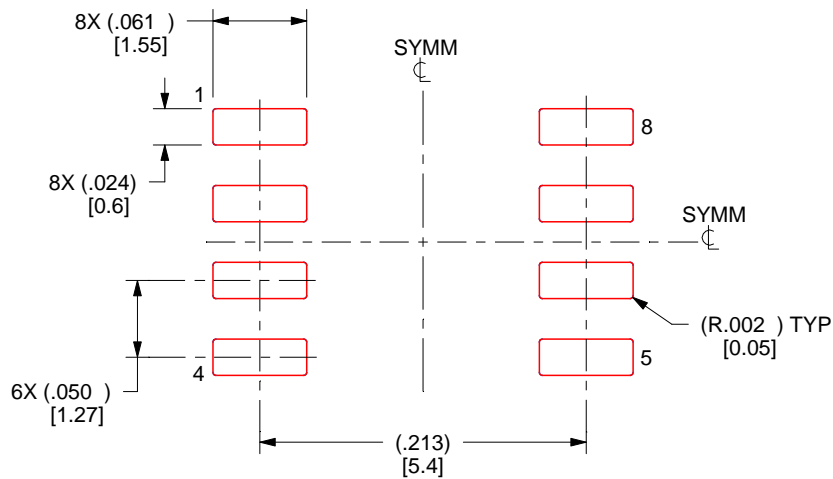
- 6. Publication IPC-7351 may have alternate designs.
- 7. Solder mask tolerances between and around signal pads can vary based on board fabrication site.

# EXAMPLE STENCIL DESIGN

D0008A

SOIC - 1.75 mm max height

SMALL OUTLINE INTEGRATED CIRCUIT



SOLDER PASTE EXAMPLE  
BASED ON .005 INCH [0.125 MM] THICK STENCIL  
SCALE:8X

4214825/C 02/2019

NOTES: (continued)

8. Laser cutting apertures with trapezoidal walls and rounded corners may offer better paste release. IPC-7525 may have alternate design recommendations.
9. Board assembly site may have different recommendations for stencil design.

## IMPORTANT NOTICE AND DISCLAIMER

TI PROVIDES TECHNICAL AND RELIABILITY DATA (INCLUDING DATASHEETS), DESIGN RESOURCES (INCLUDING REFERENCE DESIGNS), APPLICATION OR OTHER DESIGN ADVICE, WEB TOOLS, SAFETY INFORMATION, AND OTHER RESOURCES "AS IS" AND WITH ALL FAULTS, AND DISCLAIMS ALL WARRANTIES, EXPRESS AND IMPLIED, INCLUDING WITHOUT LIMITATION ANY IMPLIED WARRANTIES OF MERCHANTABILITY, FITNESS FOR A PARTICULAR PURPOSE OR NON-INFRINGEMENT OF THIRD PARTY INTELLECTUAL PROPERTY RIGHTS.

These resources are intended for skilled developers designing with TI products. You are solely responsible for (1) selecting the appropriate TI products for your application, (2) designing, validating and testing your application, and (3) ensuring your application meets applicable standards, and any other safety, security, regulatory or other requirements.

These resources are subject to change without notice. TI grants you permission to use these resources only for development of an application that uses the TI products described in the resource. Other reproduction and display of these resources is prohibited. No license is granted to any other TI intellectual property right or to any third party intellectual property right. TI disclaims responsibility for, and you fully indemnify TI and its representatives against any claims, damages, costs, losses, and liabilities arising out of your use of these resources.

TI's products are provided subject to [TI's Terms of Sale](#), [TI's General Quality Guidelines](#), or other applicable terms available either on [ti.com](http://ti.com) or provided in conjunction with such TI products. TI's provision of these resources does not expand or otherwise alter TI's applicable warranties or warranty disclaimers for TI products. Unless TI explicitly designates a product as custom or customer-specified, TI products are standard, catalog, general purpose devices.

TI objects to and rejects any additional or different terms you may propose.

Copyright © 2025, Texas Instruments Incorporated

Last updated 10/2025