



## ABSTRACT

This report discusses the radiation characterization results of the INA950-SEP current-sense amplifier. The study was done to determine Total Ionizing Dose (TID) effects under high dose rate (HDR) up to 30krad(Si) and low dose rate (LDR) up to 30krad(Si) as a one-time characterization. The results show that all samples passed within the specified limits up to 30krad(Si). To specify the following results, the Radiation Lot Acceptance Testing (RLAT) was performed using five units at a dose level of 30krad(Si) that are required for future wafer lots. Furthermore, the INA950 is packaged in a space enhanced plastic for low outgassing characteristics and is Single Event Latch-Up (SEL) immune up to 50.4MeV-cm<sup>2</sup> /mg making the device designed for low Earth orbit space applications.

## 1 Device Information

The INA950-SEP is a radiation-tolerant, single channel, ultra-precise current-sense amplifier that can measure voltage drops across shunt resistors over a common-mode range of 2.7V to 80V. The INA950-SEP operates from a single 2.7V or 5.5V supply with only drawing 370µA of a supply current per channel.

### 1.1 Device Details

Table 1-1 lists the device information used for TID HDR characterization and qualification.

**Table 1-1. Device and Exposure Details**

TID HDR Details: Up to 30krad (Si)	
TI Device Number	INA950-SEP
Package	8-pin PW
Technology	LBCSOI2
Die Lot Number	1316082
A/T Lot Number / Lot Trace Code	4695075ML4/4AA4LJK
Quantity Tested	15 irradiated devices + 2 control devices
Lot Accept/Reject	Devices passed 30krad (Si)
HDR Radiation Facility	Texas Instruments CLAB, Dallas, TX
HDR Dose Level	30krad (Si)
HDR Dose Rate	260 rad(Si)/
HDR Radiation Source	Gammacell (GR420) Co-60
Irradiation Temperature	Ambient, room temperature
LDR Radiation Facility	VPT Rad, Chelmsford, Massachusetts
LDR Dose Level	30krad(Si)
LDR Dose Rate	10mrad(Si)/s ionizing radiation with increments
LDR Radiation Source	JLSA-81-22
VID	V62/25635



**Figure 1-1. INA950-SEP Device**

## 2 Total Dose Test Setup

### 2.1 Test Overview

#### HDR Testing

The INA950-SEP samples were irradiated at a high dose rate of 50-300 rad(Si)/s up to 30krad(Si) and then put through full electrical parametric testing on the production Automated Test Equipment (ATE). The samples were functional and passed all electrical parametric tests with readings within data sheet electrical specification limits.

#### LDR Testing

The INA950-SEP samples were irradiated at a low dose rate of 10mrad(Si)/s up to 30krad(Si) and then put through full electrical parametric testing on the production Automated Test Equipment (ATE). The samples were functional and passed all electrical parametric tests with readings within data sheet electrical specification limits.

### 2.2 Test Description and Facilities

The INA950-SEP HDR exposure was performed on biased devices in a Co60 gamma cell at TI CLAB facility in Dallas, Texas. The unattenuated dose rate of this cell is 50-300 rad(Si)/s. After exposure, the devices completed a full post irradiation electrical evaluation using Texas Instruments ATE. The ATE guard band test limits are set within the electrical specifications in the data sheet to ensure a minimum Cpk and test error margin based on initial qualification and characterization data. Post-irradiation measurements were taken within 30 minutes of radiation.

The INA950-SEP LDR exposure was performed on unbiased devices in a Co60 gamma cell at VPT Rad facility in Chelmsford, Massachusetts. A uniform radiation beam is emitted through a single divergent beam port on the irradiator. A range of dose rates from 0.01 to 0.1 rad(Si)/sec is available by varying the distance to the beam port. Lead-aluminum test boxes provide energy spectrum hardening for the device under test (DUT). The DUT is positioned using a precise and versatile positioning system. An adjacent laboratory area provides a location for bias power supplies, monitoring, and test instrumentation. After exposure, the devices completed a full post irradiation electrical evaluation using Texas Instruments ATE. ATE guard band test limits are set within data sheet electrical specifications to ensure a minimum Cpk and test error margin based on initial qualification and characterization data.

## 2.3 Test Setup Details

The devices were tested in biased conditions as shown in the following sections.

### 2.3.1 Biased

Figure 2-1 shows the bias conditions for each pin during irradiation.

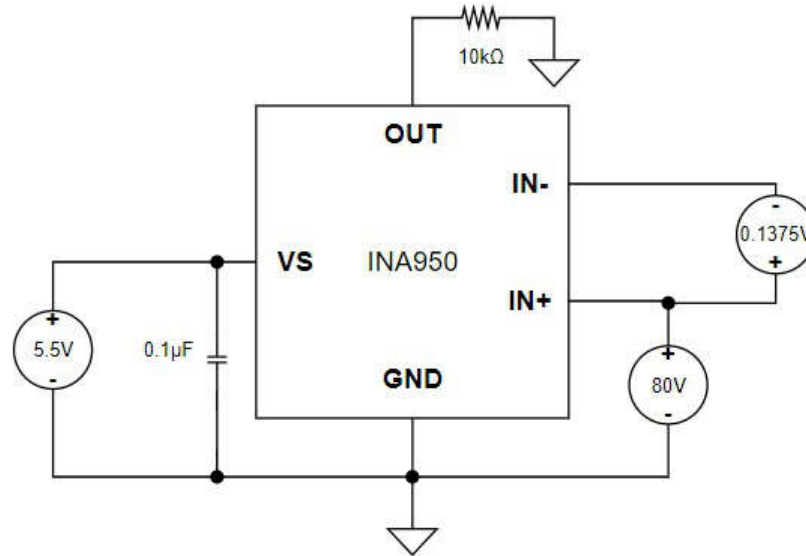

Figure 2-1. INA950-SEP Biased Diagram

## 2.4 Test Configuration and Condition

To determine what testing should be used for the RLAT testing of any future lots of the INA950-SEP, an ELDRS (Enhanced Low Dose Rate Sensitivity) study was performed to compare the results of the HDR stress to the results of the LDR stress. After comparing the results of the mean HDR and LDR stresses, it was determined that the delta ratio remained under 1.5x, thus defining the HDR as the worst-case stress and the device as *ELDRS-free*. This conclusion allows for the RLAT testing of future lots to be done with biased HDR testing.

[Table 2-1](#) and [Table 2-2](#) list the serialized samples used for the ELDRS comparison.

**Table 2-1. HDR = 260 rad(Si)/s Device Information**

HDR = 260 rad(Si)/s	
Total Samples: 10	
Exposure Levels	
30krad (Si)	30krad (Si)
Biased	Unbiased
1, 2, 3, 4, 5	6, 7, 8, 9, 10

**Table 2-2. LDR = 10 mrad(Si)/s Device Information**

LDR = 10mrad(Si)/s	
Total Samples: 10	
Exposure Levels	
30krad (Si)	30krad (Si)
Biased	Unbiased
1, 2, 3, 4, 5	5, 6, 7, 8, 9

### 3 Total Ionizing Dose (RHA) Characterization Test Results

#### 3.1 Total Ionizing Dose RHA Characterization Summary Results

The parametric data for the-SEP is within data sheet limits up to 30krad(Si) for biased setup conditions.

##### 3.1.1 Quiescent Current HDR

Quiescent current showed little variation at 30 krad(Si) but is still within data sheet limits. [Figure 3-1](#) and [Figure 3-2](#) show the minimum, average, and maximum data post irradiation for each dose level.

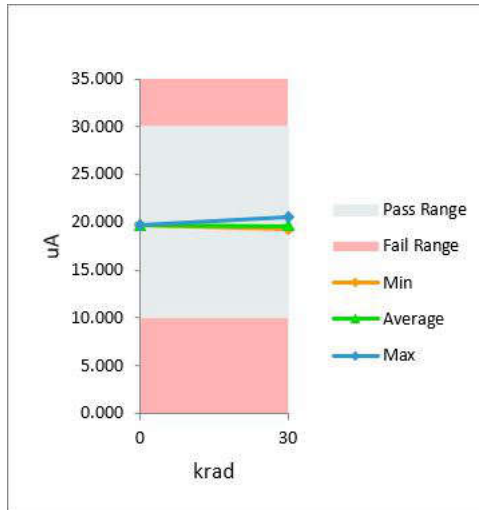

Figure 3-1. HDR Radiation Exposure Effect on Positive Quiescent Current

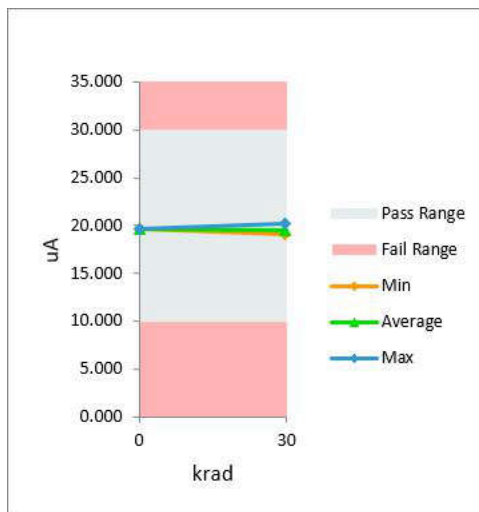
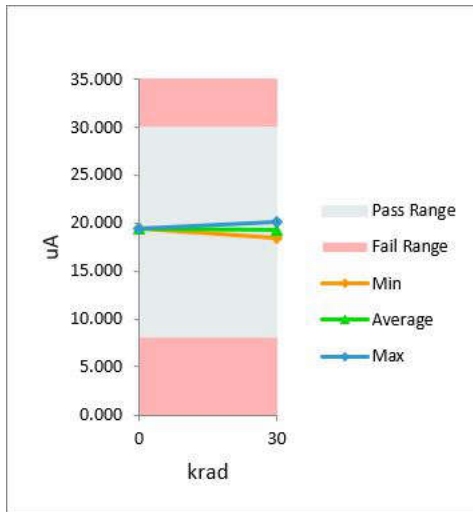

Figure 3-2. HDR Radiation Exposure Effect on Negative Quiescent Current

### 3.1.2 Quiescent Current LDR

Quiescent current showed little variation at 30krad(Si) but is still within data sheet limits. [Figure 3-3](#) and [Figure 3-4](#) show the minimum, average, and maximum data post irradiation for each dose level.



**Figure 3-3. LDR Radiation Exposure Effect on Positive Quiescent Current**

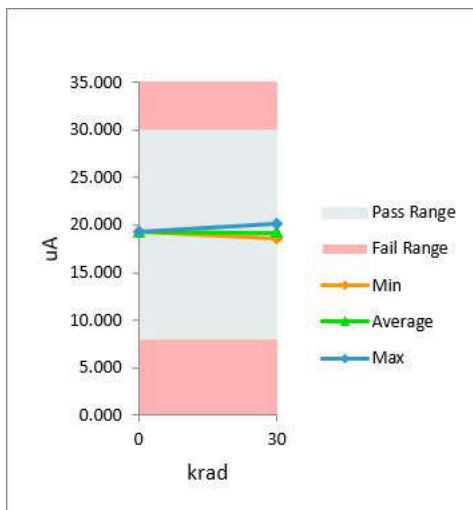

**Figure 3-4. LDR Radiation Exposure Effect on Negative Quiescent Current**

## **A Total Ionizing Dose Report**

This appendix provides both the INA950-SEP TID HDR and the TID LDR report. The reports show the variation for each parameter up to 30krad(Si).



HDR TID Report  
INA950A1MPWTSEP

# HDR TID Report INA950A1MPWTSEP

20.0\_n20CM\_IQ\_VS\_5p0\_48V\_0

Test Site	Junkins	Junkins
Tester	FETS36401	FETS36401
Test Number	EQ0581	EQ0581
Unit	uA	uA
Max Limit	100	100
Min Limit	-100	-100

krad	Serial #	Pre-HDR	Post-HDR	Delta	Delta %	% of Limit Range
30	1	10.424	17.438	7.014	67.29%	3.51%
30	2	21.849	18.607	-3.242	-14.84%	1.62%
30	3	8.768	20.117	11.349	129.44%	5.67%
30	4	20.973	15.100	-5.873	-28.00%	2.94%
30	5	10.911	19.435	8.524	78.12%	4.26%
30	6	22.725	18.363	-4.362	-19.19%	2.18%
30	7	14.028	17.194	3.166	22.57%	1.58%
30	8	23.649	19.289	-4.360	-18.44%	2.18%
30	9	10.959	17.535	6.576	60.01%	3.29%
30	10	22.287	18.022	-4.265	-19.14%	2.13%
0	11	22.238	16.707	-5.531	-24.87%	2.77%
Max		23.649	20.117	11.349	129.44%	5.67%
Average		17.165	17.982	0.818	21.18%	2.92%
Min		8.768	15.100	-5.873	-28.00%	1.58%
Std Dev		6.040	1.413	6.545	54.09%	1.23%

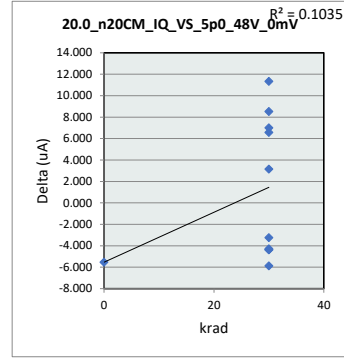

20.0\_n20CM\_IQ\_VS\_5p0\_48V

Test Site	Junkins
Tester	FETS36401
Test Number	EQ0581
Max Limit	100 uA
Min Limit	-100 uA
krad	0 30
LL	-100.000 -100.000
Min	16.707 15.100
Average	16.707 18.110
Max	16.707 20.117
UL	100.000 100.000

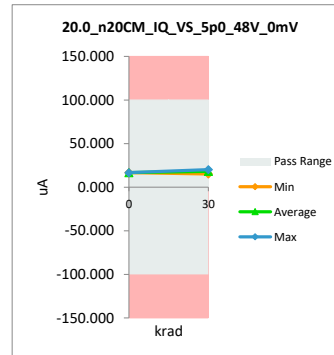

# HDR TID Report INA950A1MPWTSEP

20.1\_n20CM\_IB\_Pos\_VS\_5p0\_48V\_0m

Test Site	Junkins	Junkins
Tester	FETS36401	FETS36401
Test Number	EQ0581	EQ0581
Unit	uA	uA
Max Limit	10	10
Min Limit	-10	-10

krad	Serial #	Pre-HDR	Post-HDR	Delta	Delta %	% of Limit Range
30	1	-0.489	-0.387	0.102	-20.86%	0.51%
30	2	-0.164	-0.095	0.069	-42.07%	0.35%
30	3	-0.028	-0.192	-0.164	585.71%	0.82%
30	4	-0.114	-0.241	-0.127	111.40%	0.63%
30	5	-0.330	-0.148	0.182	-55.15%	0.91%
30	6	0.003	0.029	0.026	866.67%	0.13%
30	7	-0.105	-0.214	-0.109	103.81%	0.55%
30	8	0.003	0.109	0.106	3533.33%	0.53%
30	9	-0.194	-0.032	0.162	-83.51%	0.81%
30	10	-0.051	-0.034	0.017	-33.33%	0.08%
0	11	-0.034	-0.012	0.022	-64.71%	0.11%
Max		0.003	0.109	0.182	3533.33%	0.91%
Average		-0.137	-0.111	0.026	445.57%	0.49%
Min		-0.489	-0.387	-0.164	-83.51%	0.08%
Std Dev		0.154	0.142	0.116	1069.37%	0.30%

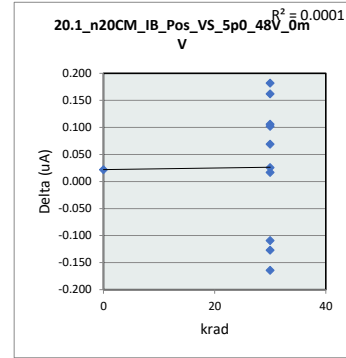

20.1\_n20CM\_IB\_Pos\_VS\_5p0

Test Site	Junkins
Tester	FETS36401
Test Number	EQ0581
Max Limit	10 uA
Min Limit	-10 uA
krad	0 30
LL	-10.000 -10.000
Min	-0.012 -0.387
Average	-0.012 -0.121
Max	-0.012 0.109
UL	10.000 10.000

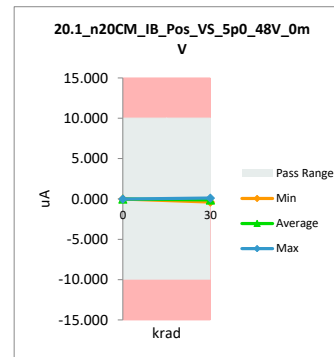

# HDR TID Report INA950A1MPWTSEP

**20.2\_n20CM\_IB\_Neg\_VS\_5p0\_4**

Test Site	Junkins	Junkins
Tester	FETS36401	FETS36401
Test Number	EQ0581	EQ0581
Unit	uA	uA
Max Limit	10	10
Min Limit	-10	-10

krad	Serial #	Pre-HDR	Post-HDR	Delta	Delta %	% of Limit Range
30	1	-0.704	0.735	1.439	-204.40%	7.20%
30	2	-0.278	1.202	1.480	-532.37%	7.40%
30	3	-0.292	1.215	1.507	-516.10%	7.54%
30	4	-0.157	1.142	1.299	-827.39%	6.49%
30	5	-0.658	1.053	1.711	-260.03%	8.55%
30	6	-0.253	0.460	0.713	-281.82%	3.56%
30	7	-0.011	1.176	1.187	-10790.91%	5.93%
30	8	0.092	-0.090	-0.182	-197.83%	0.91%
30	9	-0.569	0.805	1.374	-241.48%	6.87%
30	10	0.325	1.305	0.980	301.54%	4.90%
0	11	0.574	0.081	-0.493	-85.89%	2.47%
Max		0.574	1.305	1.711	301.54%	8.55%
Average		-0.176	0.826	1.001	-1239.70%	5.62%
Min		-0.704	-0.090	-0.493	-10790.91%	0.91%
Std Dev		0.401	0.483	0.718	3180.52%	2.39%

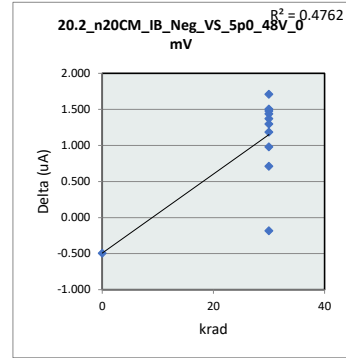

**20.2\_n20CM\_IB\_Neg\_VS\_5p0**

Test Site	Junkins
Tester	FETS36401
Test Number	EQ0581
Max Limit	10 uA
Min Limit	-10 uA
krad	0 30
LL	-10.000 -10.000
Min	0.081 -0.090
Average	0.081 0.900
Max	0.081 1.305
UL	10.000 10.000

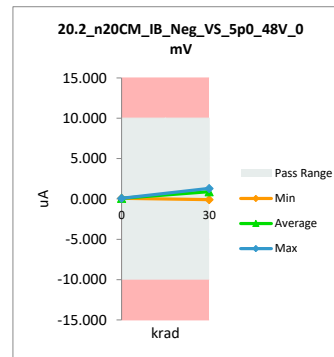

# HDR TID Report INA950A1MPWTSEP

## 30.0\_IQ\_VS\_2p7V\_48V\_25mV

Test Site	Junkins	Junkins
Tester	FETS36401	FETS36401
Test Number	EQ0581	EQ0581
Unit	uA	uA
Max Limit	600	600
Min Limit	100	100

krad	Serial #	Pre-HDR	Post-HDR	Delta	Delta %	% of Limit Range
30	1	359.032	360.007	0.975	0.27%	0.19%
30	2	326.921	321.722	-5.199	-1.59%	1.04%
30	3	365.316	370.235	4.919	1.35%	0.98%
30	4	354.658	358.058	3.400	0.96%	0.68%
30	5	345.540	347.391	1.851	0.54%	0.37%
30	6	345.510	347.683	2.173	0.63%	0.43%
30	7	351.190	353.041	1.851	0.53%	0.37%
30	8	346.434	356.159	9.725	2.81%	1.95%
30	9	352.749	359.714	6.965	1.97%	1.39%
30	10	340.157	343.592	3.435	1.01%	0.69%
0	11	348.527	349.680	1.153	0.33%	0.23%
Max		365.316	370.235	9.725	2.81%	1.95%
Average		348.730	351.571	2.841	0.80%	0.76%
Min		326.921	321.722	-5.199	-1.59%	0.19%
Std Dev		10.068	12.417	3.778	1.10%	0.54%

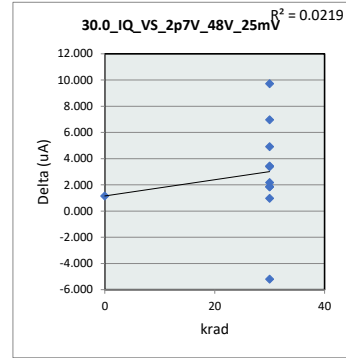

30.0_IQ_VS_2p7V_48V_25mV		
Test Site	Junkins	
Tester	FETS36401	
Test Number	EQ0581	
Max Limit	600	uA
Min Limit	100	uA
krad	0	30
LL	100.000	100.000
Min	349.680	321.722
Average	349.680	351.760
Max	349.680	370.235
UL	600.000	600.000

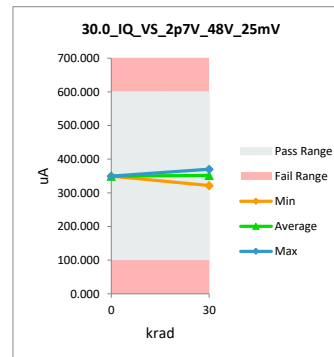

# HDR TID Report INA950A1MPWTSEP

## 30.1\_IQ\_VS\_5p0V\_48V\_25mV

Test Site	Junkins	Junkins
Tester	FETS36401	FETS36401
Test Number	EQ0581	EQ0581
Unit	uA	uA
Max Limit	600	600
Min Limit	100	100

krad	Serial #	Pre-HDR	Post-HDR	Delta	Delta %	% of Limit Range
30	1	406.036	402.188	-3.848	-0.95%	0.77%
30	2	374.949	366.923	-8.026	-2.14%	1.61%
30	3	413.635	421.964	8.329	2.01%	1.67%
30	4	401.275	404.283	3.008	0.75%	0.60%
30	5	393.080	393.810	0.730	0.19%	0.15%
30	6	394.900	392.203	-2.697	-0.68%	0.54%
30	7	394.346	396.343	1.997	0.51%	0.40%
30	8	391.640	400.337	8.697	2.22%	1.74%
30	9	402.383	404.721	2.338	0.58%	0.47%
30	10	389.548	390.060	0.512	0.13%	0.10%
0	11	395.533	396.733	1.200	0.30%	0.24%
Max		413.635	421.964	8.697	2.22%	1.74%
Average		396.120	397.233	1.113	0.27%	0.75%
Min		374.949	366.923	-8.026	-2.14%	0.10%
Std Dev		9.983	13.266	4.885	1.24%	0.62%

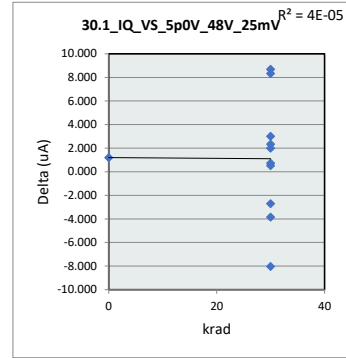

30.1_IQ_VS_5p0V_48V_25mV		
Test Site	Junkins	
Tester	FETS36401	
Test Number	EQ0581	
Max Limit	600	uA
Min Limit	100	uA
krad	0	30
LL	100.000	100.000
Min	396.733	366.923
Average	396.733	397.283
Max	396.733	421.964
UL	600.000	600.000

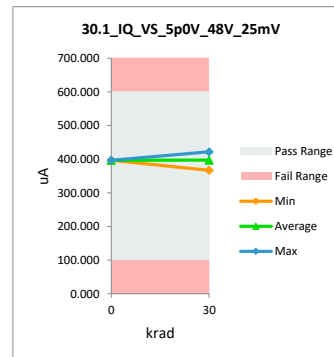

# HDR TID Report INA950A1MPWTSEP

## 30.2\_IQ\_VS\_12p0V\_48V\_25mV

Test Site	Junkins	Junkins
Tester	FETS36401	FETS36401
Test Number	EQ0581	EQ0581
Unit	uA	uA
Max Limit	500	500
Min Limit	200	200

krad	Serial #	Pre-HDR	Post-HDR	Delta	Delta %	% of Limit Range
30	1	410.761	407.254	-3.507	-0.85%	1.17%
30	2	379.864	372.476	-7.388	-1.94%	2.46%
30	3	418.408	424.399	5.991	1.43%	2.00%
30	4	406.433	410.907	4.474	1.10%	1.49%
30	5	394.444	395.564	1.120	0.28%	0.37%
30	6	399.523	398.048	-1.475	-0.37%	0.49%
30	7	400.483	402.042	1.559	0.39%	0.52%
30	8	398.258	407.156	8.898	2.23%	2.97%
30	9	406.280	410.566	4.286	1.05%	1.43%
30	10	394.462	394.200	-0.262	-0.07%	0.09%
0	11	400.593	402.627	2.034	0.51%	0.68%
Max		418.408	424.399	8.898	2.23%	2.97%
Average		400.864	402.294	1.430	0.34%	1.24%
Min		379.864	372.476	-7.388	-1.94%	0.09%
Std Dev		9.990	13.029	4.560	1.15%	0.93%

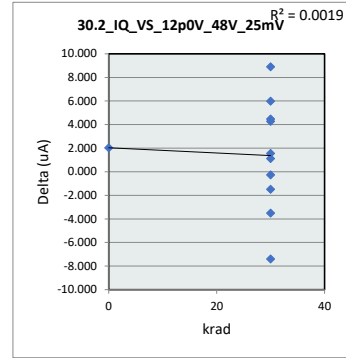

30.2_IQ_VS_12p0V_48V_25mV		
Test Site	Junkins	
Tester	FETS36401	
Test Number	EQ0581	
Max Limit	500	uA
Min Limit	200	uA
krad	0	30
LL	200.000	200.000
Min	402.627	372.476
Average	402.627	402.261
Max	402.627	424.399
UL	500.000	500.000

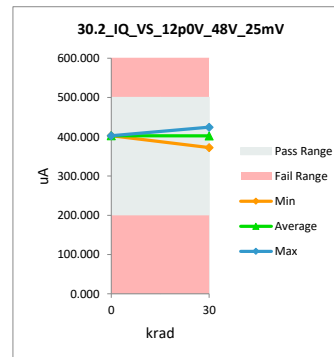

# HDR TID Report INA950A1MPWTSEP

## 30.3 IQ\_VS\_20p0V\_48V\_25mV

Test Site	Junkins	Junkins
Tester	FETS36401	FETS36401
Test Number	EQ0581	EQ0581
Unit	uA	uA
Max Limit	500	500
Min Limit	200	200

krad	Serial #	Pre-HDR	Post-HDR	Delta	Delta %	% of Limit Range
30	1	416.168	416.021	-0.147	-0.04%	0.05%
30	2	385.509	375.593	-9.916	-2.57%	3.31%
30	3	422.597	430.244	7.647	1.81%	2.55%
30	4	411.104	414.755	3.651	0.89%	1.22%
30	5	402.139	401.117	-1.022	-0.25%	0.34%
30	6	406.773	403.260	-3.513	-0.86%	1.17%
30	7	405.159	406.962	1.803	0.45%	0.60%
30	8	404.438	412.758	8.320	2.06%	2.77%
30	9	410.858	413.927	3.069	0.75%	1.02%
30	10	400.253	401.993	1.740	0.43%	0.58%
0	11	406.433	408.374	1.941	0.48%	0.65%
Max		422.597	430.244	8.320	2.06%	3.31%
Average		406.494	407.728	1.234	0.28%	1.30%
Min		385.509	375.593	-9.916	-2.57%	0.05%
Std Dev		9.474	13.487	5.055	1.27%	1.08%

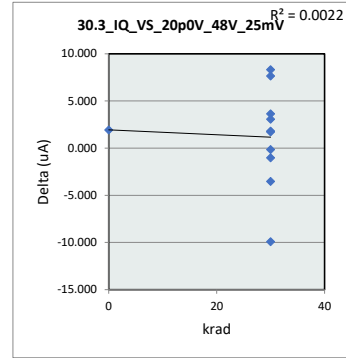

## 30.3 IQ\_VS\_20p0V\_48V\_25mV

Test Site	Junkins	Junkins
Tester	FETS36401	FETS36401
Test Number	EQ0581	EQ0581
Max Limit	500	uA
Min Limit	200	uA
krad	0	30
LL	200.000	200.000
Min	408.374	375.593
Average	408.374	407.663
Max	408.374	430.244
UL	500.000	500.000

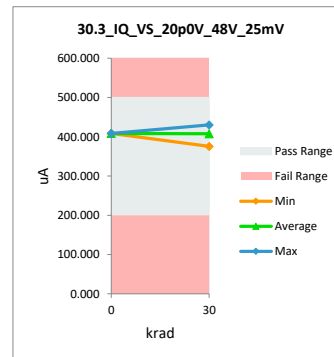



# HDR TID Report INA950A1MPWTSEP

40.0\_IB\_Pos\_VS\_5p0V\_48V\_0m

Test Site	Junkins	Junkins
Tester	FETS36401	FETS36401
Test Number	EQ0581	EQ0581
Unit	uA	uA
Max Limit	30	30
Min Limit	8	8

krad	Serial #	Pre-HDR	Post-HDR	Delta	Delta %	% of Limit Range
30	1	19.765	19.646	-0.119	-0.60%	0.54%
30	2	18.886	18.594	-0.292	-1.55%	1.33%
30	3	18.546	18.886	0.340	1.83%	1.55%
30	4	18.843	19.136	0.293	1.55%	1.33%
30	5	19.590	19.403	-0.187	-0.95%	0.85%
30	6	18.657	18.672	0.015	0.08%	0.07%
30	7	18.950	19.031	0.081	0.43%	0.37%
30	8	18.227	18.430	0.203	1.11%	0.92%
30	9	18.950	18.909	-0.041	-0.22%	0.19%
30	10	18.436	18.363	-0.073	-0.40%	0.33%
0	11	18.870	18.872	0.002	0.01%	0.01%
Max		19.765	19.646	0.340	1.83%	1.55%
Average		18.884	18.904	0.020	0.12%	0.68%
Min		18.227	18.363	-0.292	-1.55%	0.01%
Std Dev		0.456	0.392	0.197	1.05%	0.55%

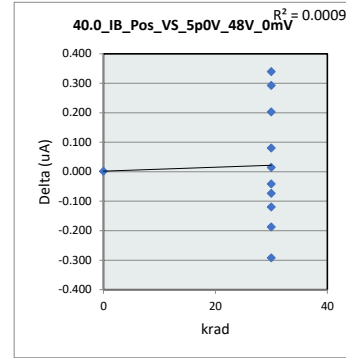

40.0\_IB\_Pos\_VS\_5p0V\_48V\_0

Test Site	Junkins
Tester	FETS36401
Test Number	EQ0581
Max Limit	30 uA
Min Limit	8 uA
krad	0 30
LL	8.000 8.000
Min	18.872 18.363
Average	18.872 18.907
Max	18.872 19.646
UL	30.000 30.000

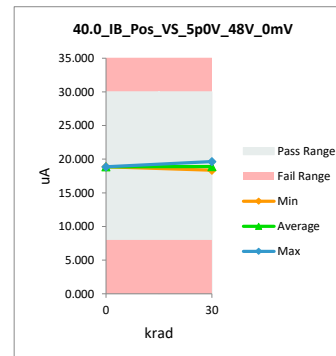

# HDR TID Report INA950A1MPWTSEP

40.1\_IB\_Neg\_VS\_5p0V\_48V\_0mV

Test Site	Junkins	Junkins
Tester	FETS36401	FETS36401
Test Number	EQ0581	EQ0581
Unit	uA	uA
Max Limit	30	30
Min Limit	8	8

krad	Serial #	Pre-HDR	Post-HDR	Delta	Delta %	% of Limit Range
30	1	19.620	19.685	0.065	0.33%	0.30%
30	2	18.754	18.643	-0.111	-0.59%	0.50%
30	3	18.416	18.964	0.548	2.98%	2.49%
30	4	18.759	19.164	0.405	2.16%	1.84%
30	5	19.470	19.442	-0.028	-0.14%	0.13%
30	6	18.613	18.706	0.093	0.50%	0.42%
30	7	18.852	19.088	0.236	1.25%	1.07%
30	8	18.041	18.453	0.412	2.28%	1.87%
30	9	18.827	18.942	0.115	0.61%	0.52%
30	10	18.308	18.373	0.065	0.36%	0.30%
0	11	18.984	18.877	-0.107	-0.56%	0.49%
Max		19.620	19.685	0.548	2.98%	2.49%
Average		18.786	18.940	0.154	0.83%	0.90%
Min		18.041	18.373	-0.59%	0.13%	
Std Dev		0.465	0.398	0.220	1.19%	0.80%

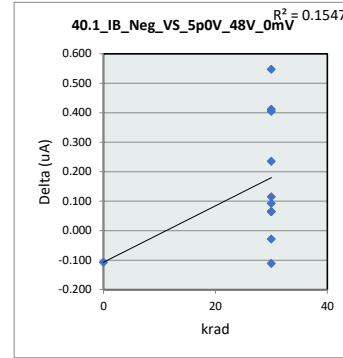

40.1\_IB\_Neg\_VS\_5p0V\_48V\_0mV

Test Site	Junkins
Tester	FETS36401
Test Number	EQ0581
Max Limit	30 uA
Min Limit	8 uA
krad	0 30
LL	8.000 8.000
Min	18.877 18.373
Average	18.877 18.946
Max	18.877 19.685
UL	30.000 30.000

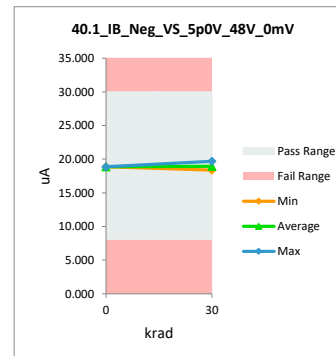

# HDR TID Report INA950A1MPWTSEP

**45.0\_IB\_Pos\_VS\_5p0V\_60V\_0m**

Test Site	Junkins	Junkins
Tester	FETS36401	FETS36401
Test Number	EQ0581	EQ0581
Unit	uA	uA
Max Limit	30	30
Min Limit	8	8

krad	Serial #	Pre-HDR	Post-HDR	Delta	Delta %	% of Limit Range
30	1	20.221	20.089	-0.132	-0.65%	0.60%
30	2	19.190	19.294	0.104	0.54%	0.47%
30	3	19.089	19.270	0.181	0.95%	0.82%
30	4	19.000	19.704	0.704	3.71%	3.20%
30	5	20.021	19.919	-0.102	-0.51%	0.46%
30	6	18.796	19.055	0.259	1.38%	1.18%
30	7	19.592	19.289	-0.303	-1.55%	1.38%
30	8	18.436	18.831	0.395	2.14%	1.80%
30	9	19.397	19.431	0.034	0.18%	0.15%
30	10	18.552	18.948	0.396	2.13%	1.80%
0	11	18.825	19.421	0.596	3.17%	2.71%
Max		20.221	20.089	0.704	3.71%	3.20%
Average		19.193	19.386	0.194	1.04%	1.32%
Min		18.436	18.831	-0.303	-1.55%	0.15%
Std Dev		0.572	0.390	0.313	1.65%	0.98%

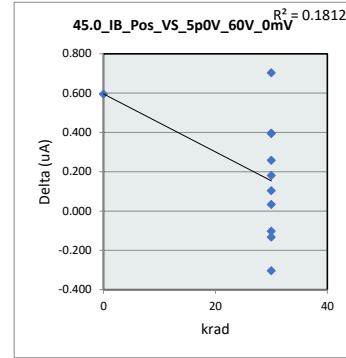

**45.0\_IB\_Pos\_VS\_5p0V\_60V\_0**

Test Site	Junkins
Tester	FETS36401
Test Number	EQ0581
Max Limit	30 uA
Min Limit	8 uA
krad	0 30
LL	8.000 8.000
Min	19.421 18.831
Average	19.421 19.383
Max	19.421 20.089
UL	30.000 30.000

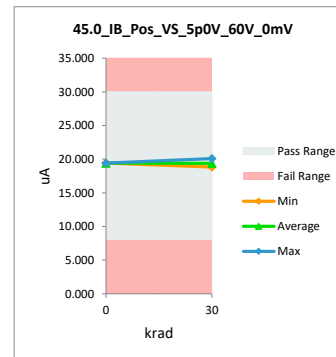

# HDR TID Report INA950A1MPWTSEP

## 45.1\_IB\_Neg\_VS\_5p0V\_60V\_0m

Test Site	Junkins	Junkins
Tester	FETS36401	FETS36401
Test Number	EQ0581	EQ0581
Unit	uA	uA
Max Limit	30	30
Min Limit	8	8

krad	Serial #	Pre-HDR	Post-HDR	Delta	Delta %	% of Limit Range
30	1	20.470	20.470	0.000	0.00%	0.00%
30	2	19.186	19.490	0.304	1.58%	1.38%
30	3	19.051	20.012	0.961	5.04%	4.37%
30	4	19.240	20.187	0.947	4.92%	4.30%
30	5	20.183	20.417	0.234	1.16%	1.06%
30	6	18.976	19.500	0.524	2.76%	2.38%
30	7	19.617	20.265	0.648	3.30%	2.95%
30	8	18.567	19.246	0.679	3.66%	3.09%
30	9	19.651	19.861	0.210	1.07%	0.95%
30	10	18.899	19.222	0.323	1.71%	1.47%
0	11	19.464	19.685	0.221	1.14%	1.00%
Max		20.470	20.470	0.961	5.04%	4.37%
Average		19.391	19.850	0.459	2.40%	2.09%
Min		18.567	19.222	0.000	0.00%	0.00%
Std Dev		0.565	0.453	0.316	1.66%	1.44%

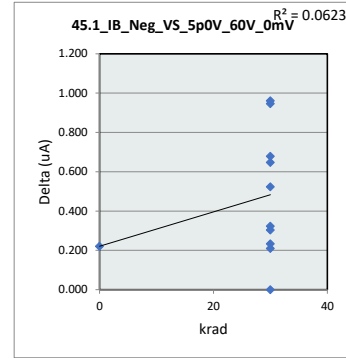

## 45.1\_IB\_Neg\_VS\_5p0V\_60V\_0

Test Site	Junkins
Tester	FETS36401
Test Number	EQ0581
Max Limit	30 uA
Min Limit	8 uA
krad	0 30
LL	8.000 8.000
Min	19.685 19.222
Average	19.685 19.867
Max	19.685 20.470
UL	30.000 30.000

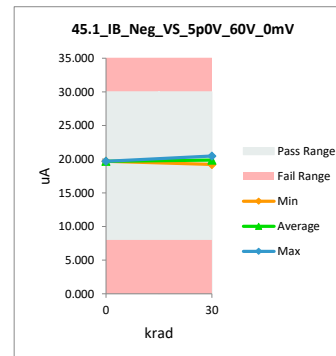

# HDR TID Report INA950A1MPWTSEP

45.2\_IB\_Pos\_VS\_5p0V\_80V\_0m

Test Site	Junkins	Junkins
Tester	FETS36401	FETS36401
Test Number	EQ0581	EQ0581
Unit	uA	uA
Max Limit	30	30
Min Limit	8	8

krad	Serial #	Pre-HDR	Post-HDR	Delta	Delta %	% of Limit Range
30	1	20.499	20.499	0.000	0.00%	0.00%
30	2	19.297	19.484	0.187	0.97%	0.85%
30	3	19.236	19.548	0.312	1.62%	1.42%
30	4	19.215	19.943	0.728	3.79%	3.31%
30	5	20.202	20.299	0.097	0.48%	0.44%
30	6	18.937	19.397	0.460	2.43%	2.09%
30	7	19.509	19.738	0.229	1.17%	1.04%
30	8	18.523	19.265	0.742	4.01%	3.37%
30	9	19.514	19.524	0.010	0.05%	0.05%
30	10	18.767	19.236	0.469	2.50%	2.13%
0	11	19.137	19.792	0.655	3.42%	2.98%
Max		20.499	20.499	0.742	4.01%	3.37%
Average		19.349	19.702	0.354	1.86%	1.61%
Min		18.523	19.236	0.000	0.00%	0.00%
Std Dev		0.581	0.408	0.276	1.46%	1.25%

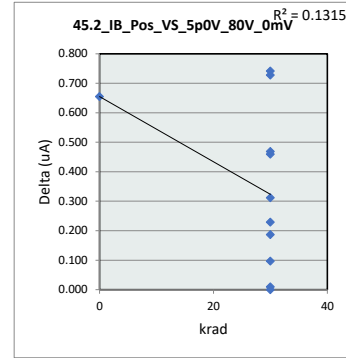

45.2\_IB\_Pos\_VS\_5p0V\_80V\_0

Test Site	Junkins
Tester	FETS36401
Test Number	EQ0581
Max Limit	30 uA
Min Limit	8 uA
krad	0 30
LL	8.000 8.000
Min	19.792 19.236
Average	19.792 19.693
Max	19.792 20.499
UL	30.000 30.000

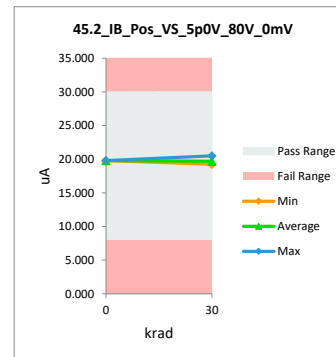

# HDR TID Report INA950A1MPWTSEP

45.3\_IB\_Neg\_VS\_5p0V\_80V\_0mV

Test Site	Junkins	Junkins
Tester	FETS36401	FETS36401
Test Number	EQ0581	EQ0581
Unit	uA	uA
Max Limit	30	30
Min Limit	8	8

krad	Serial #	Pre-HDR	Post-HDR	Delta	Delta %	% of Limit Range
30	1	20.236	20.246	0.010	0.05%	0.05%
30	2	19.249	19.110	-0.139	-0.72%	0.63%
30	3	19.261	19.437	0.176	0.91%	0.80%
30	4	19.274	19.695	0.421	2.18%	1.91%
30	5	20.275	20.105	-0.170	-0.84%	0.77%
30	6	19.050	19.446	0.396	2.08%	1.80%
30	7	19.549	19.602	0.053	0.27%	0.24%
30	8	18.504	19.178	0.674	3.64%	3.06%
30	9	19.402	19.383	-0.019	-0.10%	0.09%
30	10	18.733	19.124	0.391	2.09%	1.78%
0	11	19.196	19.661	0.465	2.42%	2.11%
Max		20.275	20.246	0.674	3.64%	3.06%
Average		19.339	19.544	0.205	1.09%	1.20%
Min		18.504	19.110	-0.170	-0.84%	0.05%
Std Dev		0.540	0.373	0.279	1.47%	0.98%

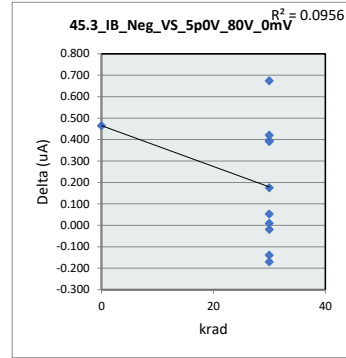

45.3\_IB\_Neg\_VS\_5p0V\_80V\_0mV

Test Site	Junkins
Tester	FETS36401
Test Number	EQ0581
Max Limit	30 uA
Min Limit	8 uA
krad	0 30
LL	8.000 8.000
Min	19.661 19.110
Average	19.661 19.533
Max	19.661 20.246
UL	30.000 30.000

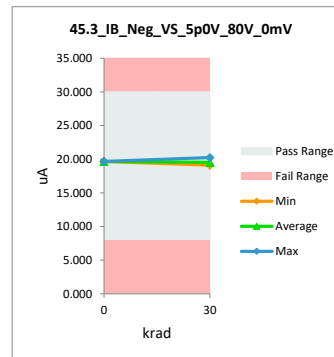

# HDR TID Report INA950A1MPWTSEP

51.0_Vin_5V_48V_2p5mV		
Test Site	Junkins	Junkins
Tester	FETS36401	FETS36401
Test Number	EQ0581	EQ0581
Unit	mV	mV
Max Limit	3	3
Min Limit	2	2

krad	Serial #	Pre-HDR	Post-HDR	Delta	Delta %	% of Limit Range
30	1	2.520	2.503	-0.017	-0.69%	1.74%
30	2	2.498	2.500	0.001	0.06%	0.15%
30	3	2.501	2.497	-0.004	-0.16%	0.39%
30	4	2.497	2.496	-0.001	-0.05%	0.12%
30	5	2.501	2.495	-0.006	-0.22%	0.55%
30	6	2.497	2.495	-0.002	-0.09%	0.23%
30	7	2.501	2.495	-0.006	-0.23%	0.57%
30	8	2.497	2.495	-0.002	-0.09%	0.22%
30	9	2.501	2.495	-0.006	-0.25%	0.62%
30	10	2.497	2.495	-0.002	-0.09%	0.23%
0	11	2.497	2.495	-0.002	-0.09%	0.23%
Max		2.520	2.503	0.001	0.06%	1.74%
Average		2.501	2.496	-0.004	-0.17%	0.46%
Min		2.497	2.495	-0.017	-0.69%	0.12%
Std Dev		0.007	0.003	0.005	0.19%	0.46%

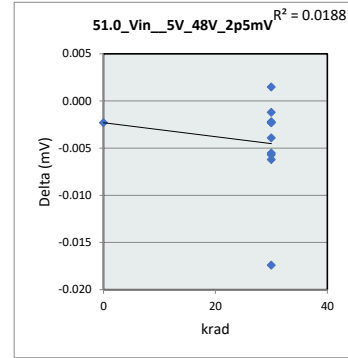

51.0_Vin_5V_48V_2p5mV		
Test Site	Junkins	
Tester	FETS36401	
Test Number	EQ0581	
Max Limit	3	mV
Min Limit	2	mV
krad	0	30
LL	2.000	2.000
Min	2.495	2.495
Average	2.495	2.496
Max	2.495	2.503
UL	3.000	3.000

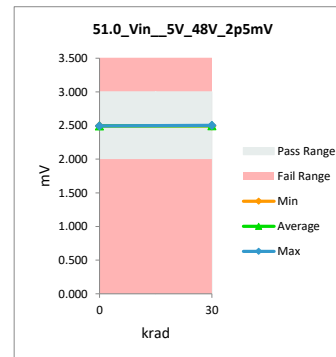

# HDR TID Report INA950A1MPWTSEP

## 51.1\_Vin\_5V\_48V\_225mV

Test Site	Junkins	Junkins
Tester	FETS36401	FETS36401
Test Number	EQ0581	EQ0581
Unit	mV	mV
Max Limit	235	235
Min Limit	215	215

krad	Serial #	Pre-HDR	Post-HDR	Delta	Delta %	% of Limit Range
30	1	224.929	224.937	0.008	0.00%	0.04%
30	2	224.951	224.935	-0.016	-0.01%	0.08%
30	3	224.929	224.935	0.006	0.00%	0.03%
30	4	224.955	224.933	-0.022	-0.01%	0.11%
30	5	224.933	224.938	0.005	0.00%	0.03%
30	6	224.954	224.934	-0.020	-0.01%	0.10%
30	7	224.930	224.936	0.006	0.00%	0.03%
30	8	224.955	224.932	-0.024	-0.01%	0.12%
30	9	224.928	224.933	0.005	0.00%	0.02%
30	10	224.951	224.936	-0.015	-0.01%	0.07%
0	11	224.970	224.934	-0.036	-0.02%	0.18%
Max		224.970	224.938	0.008	0.00%	0.18%
Average		224.944	224.935	-0.009	0.00%	0.07%
Min		224.928	224.932	-0.036	-0.02%	0.02%
Std Dev		0.015	0.002	0.016	0.01%	0.05%

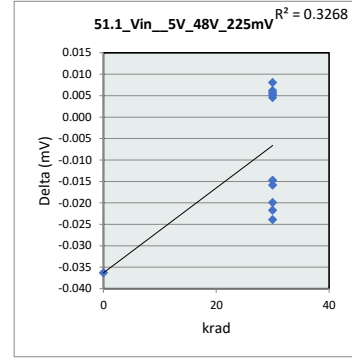

## 51.1\_Vin\_5V\_48V\_225mV

Test Site	Junkins
Tester	FETS36401
Test Number	EQ0581
Max Limit	235 mV
Min Limit	215 mV
krad	0 30
LL	215.000 215.000
Min	224.934 224.935
Average	224.934 224.935
Max	224.934 224.938
UL	235.000 235.000

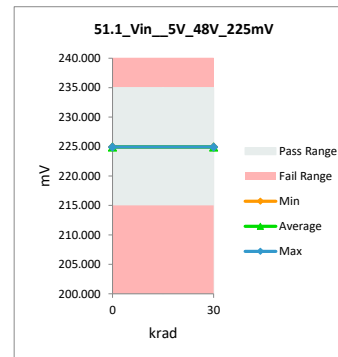



# HDR TID Report INA950A1MPWTSEP

51.2_Vout_5V_48V_50mV		
Test Site	Junkins	Junkins
Tester	FETS36401	FETS36401
Test Number	EQ0581	EQ0581
Unit	mV	mV
Max Limit	60	60
Min Limit	40	40

krad	Serial #	Pre-HDR	Post-HDR	Delta	Delta %	% of Limit Range
30	1	50.394	50.217	-0.177	-0.35%	0.88%
30	2	50.078	50.269	0.191	0.38%	0.96%
30	3	50.242	50.254	0.012	0.02%	0.06%
30	4	50.050	50.235	0.185	0.37%	0.93%
30	5	50.040	50.154	0.114	0.23%	0.57%
30	6	50.003	50.169	0.166	0.33%	0.83%
30	7	50.267	50.230	-0.036	-0.07%	0.18%
30	8	49.961	50.124	0.163	0.33%	0.81%
30	9	50.313	50.137	-0.177	-0.35%	0.88%
30	10	49.981	50.169	0.188	0.38%	0.94%
0	11	50.087	50.253	0.166	0.33%	0.83%
Max		50.394	50.269	0.191	0.38%	0.96%
Average		50.129	50.201	0.072	0.15%	0.72%
Min		49.961	50.124	-0.177	-0.35%	0.06%
Std Dev		0.149	0.052	0.144	0.29%	0.31%

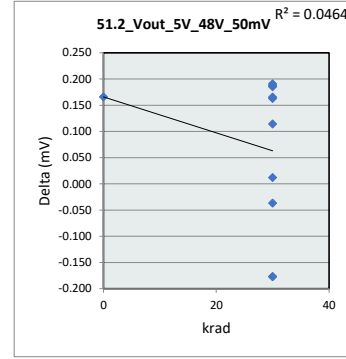

51.2_Vout_5V_48V_50mV		
Test Site	Junkins	
Tester	FETS36401	
Test Number	EQ0581	
Max Limit	60	mV
Min Limit	40	mV
krad	0	30
LL	40.000	40.000
Min	50.253	50.124
Average	50.253	50.196
Max	50.253	50.269
UL	60.000	60.000

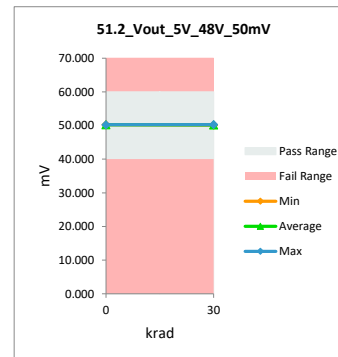

### HDR TID Report INA950A1MPWTSEP

51.3_Vout_5V_48V_4p5V		
Test Site	Junkins	Junkins
Tester	FETS36401	FETS36401
Test Number	EQ0581	EQ0581
Unit	V	V
Max Limit	5	5
Min Limit	4	4

krad	Serial #	Pre-HDR	Post-HDR	Delta	Delta %	% of Limit Range
30	1	4.498	4.499	0.000	0.00%	0.01%
30	2	4.499	4.499	0.000	0.00%	0.00%
30	3	4.497	4.498	0.001	0.03%	0.12%
30	4	4.498	4.498	0.000	0.00%	0.00%
30	5	4.497	4.498	0.001	0.03%	0.12%
30	6	4.498	4.498	0.000	0.00%	0.01%
30	7	4.497	4.498	0.001	0.02%	0.11%
30	8	4.498	4.498	0.000	0.00%	0.01%
30	9	4.498	4.498	0.000	0.00%	0.01%
30	10	4.498	4.498	0.000	0.00%	0.00%
0	11	4.498	4.498	0.000	0.00%	0.00%
Max		4.499	4.499	0.001	0.03%	0.12%
Average		4.498	4.498	0.000	0.01%	0.04%
Min		4.497	4.498	0.000	0.00%	0.00%
Std Dev		0.001	0.000	0.001	0.01%	0.05%

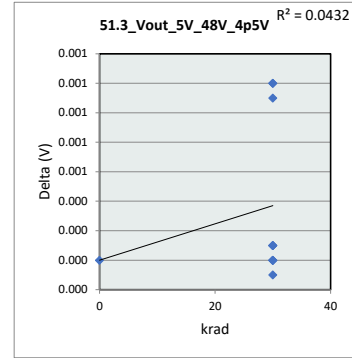

51.3_Vout_5V_48V_4p5V		
Test Site	Junkins	
Tester	FETS36401	
Test Number	EQ0581	
Max Limit	5	V
Min Limit	4	V
krad	0	30
LL	4.000	4.000
Min	4.498	4.498
Average	4.498	4.498
Max	4.498	4.499
UL	5.000	5.000

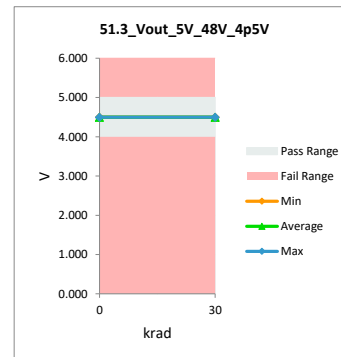

# HDR TID Report INA950A1MPWTSEP

## 51.4\_Gain\_5V\_48V

Test Site	Junkins	Junkins
Tester	FETS36401	FETS36401
Test Number	EQ0581	EQ0581
Unit	V/V	V/V
Max Limit	22	22
Min Limit	18	18

krad	Serial #	Pre-HDR	Post-HDR	Delta	Delta %	% of Limit Range
30	1	20.000	19.999	-0.001	-0.01%	0.03%
30	2	19.998	19.998	0.001	0.00%	0.02%
30	3	19.993	19.998	0.005	0.02%	0.12%
30	4	19.995	19.996	0.001	0.01%	0.03%
30	5	19.992	19.996	0.004	0.02%	0.09%
30	6	19.996	19.996	0.001	0.00%	0.02%
30	7	19.994	19.997	0.004	0.02%	0.10%
30	8	19.994	19.995	0.001	0.01%	0.03%
30	9	19.997	19.998	0.001	0.00%	0.02%
30	10	19.996	19.997	0.001	0.00%	0.01%
0	11	19.993	19.996	0.002	0.01%	0.06%
Max		20.000	19.999	0.005	0.02%	0.12%
Average		19.995	19.997	0.002	0.01%	0.05%
Min		19.992	19.995	-0.001	-0.01%	0.01%
Std Dev		0.002	0.001	0.002	0.01%	0.04%

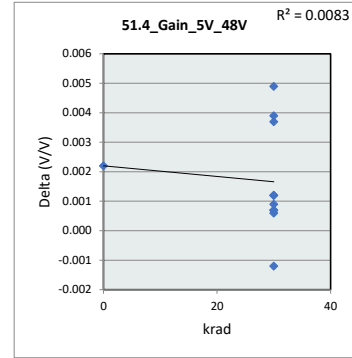

## 51.4\_Gain\_5V\_48V

Test Site	Junkins	
Tester	FETS36401	
Test Number	EQ0581	
Max Limit	22	V/V
Min Limit	18	V/V
krad	0	30
LL	18.000	18.000
Min	19.996	19.995
Average	19.996	19.997
Max	19.996	19.999
UL	22.000	22.000

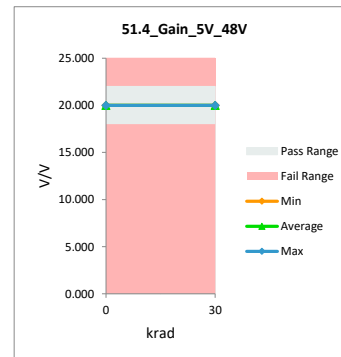

# HDR TID Report INA950A1MPWTSEP

## 51.5\_Gain\_Error\_5V\_48V

Test Site	Junkins	Junkins
Tester	FETS36401	FETS36401
Test Number	EQ0581	EQ0581
Unit	m%	m%
Max Limit	150	150
Min Limit	-150	-150

krad	Serial #	Pre-HDR	Post-HDR	Delta	Delta %	% of Limit Range
30	1	-1.419	-7.538	-6.119	431.06%	2.04%
30	2	-11.628	-7.757	3.871	-33.29%	1.29%
30	3	-34.857	-10.692	24.166	-69.33%	8.06%
30	4	-24.463	-18.652	5.810	-23.75%	1.94%
30	5	-39.908	-21.700	18.208	-45.63%	6.07%
30	6	-22.451	-18.056	4.395	-19.58%	1.46%
30	7	-31.841	-12.539	19.302	-60.62%	6.43%
30	8	-30.768	-25.081	5.686	-18.48%	1.90%
30	9	-13.903	-10.270	3.633	-26.13%	1.21%
30	10	-17.952	-14.791	3.161	-17.61%	1.05%
0	11	-32.491	-21.674	10.817	-33.29%	3.61%
Max		-1.419	-7.538	24.166	431.06%	8.06%
Average		-23.789	-15.341	8.448	7.58%	3.19%
Min		-39.908	-25.081	-6.119	-69.33%	1.05%
Std Dev		11.636	6.063	8.837	141.51%	2.50%

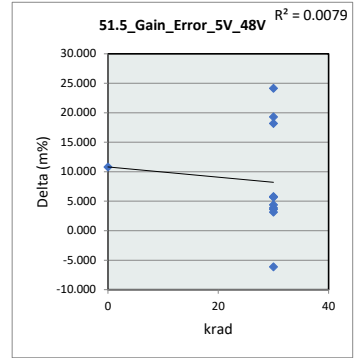

## 51.5\_Gain\_Error\_5V\_48V

Test Site	Junkins
Tester	FETS36401
Test Number	EQ0581
Max Limit	150 m%
Min Limit	-150 m%
krad	0 30
LL	-150.000 -150.000
Min	-21.674 -25.081
Average	-21.674 -14.708
Max	-21.674 -7.538
UL	150.000 150.000

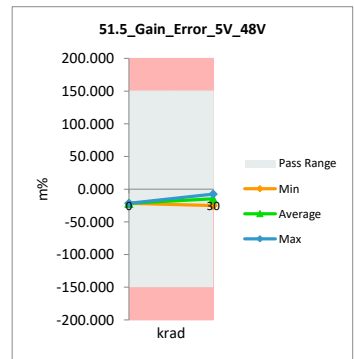

# HDR TID Report INA950A1MPWTSEP

## 61.0\_Offset\_5V\_48V

Test Site	Junkins	Junkins
Tester	FETS36401	FETS36401
Test Number	EQ0581	EQ0581
Unit	uV	uV
Max Limit	25	25
Min Limit	-25	-25

krad	Serial #	Pre-HDR	Post-HDR	Delta	Delta %	% of Limit Range
30	1	-0.679	8.050	8.729	-1285.25%	17.46%
30	2	6.119	14.019	7.900	129.10%	15.80%
30	3	12.331	16.306	3.975	32.23%	7.95%
30	4	5.805	16.181	10.376	178.74%	20.75%
30	5	2.385	13.191	10.807	453.16%	21.61%
30	6	3.543	14.020	10.477	295.69%	20.95%
30	7	13.533	16.896	3.363	24.85%	6.73%
30	8	1.559	11.695	10.136	649.97%	20.27%
30	9	15.262	12.451	-2.811	-18.42%	5.62%
30	10	2.429	13.976	11.547	475.41%	23.09%
0	11	7.921	18.271	10.350	130.65%	20.70%
Max		15.262	18.271	11.547	649.97%	23.09%
Average		6.383	14.096	7.713	96.92%	16.45%
Min		-0.679	8.050	-2.811	-1285.25%	5.62%
Std Dev		5.300	2.835	4.433	505.71%	6.54%

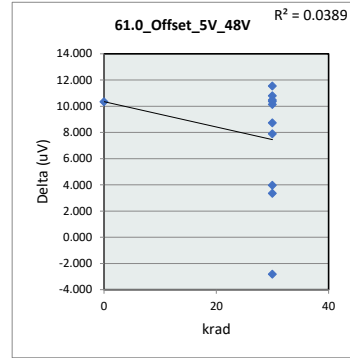

## 61.0\_Offset\_5V\_48V

Test Site	Junkins	
Tester	FETS36401	
Test Number	EQ0581	
Max Limit	25 uV	
Min Limit	-25 uV	
krad	0	30
LL	-25.000	-25.000
Min	18.271	8.050
Average	18.271	13.679
Max	18.271	16.896
UL	25.000	25.000

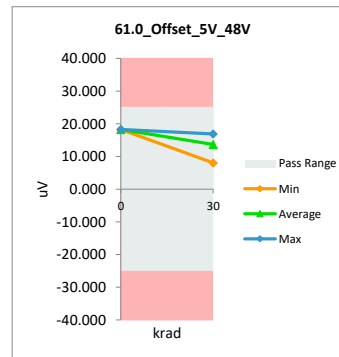

# HDR TID Report INA950A1MPWTSEP

	71.0_Vin__2p7V_48V_25mV	
Test Site	Junkins	Junkins
Tester	FETS36401	FETS36401
Test Number	EQ0581	EQ0581
Unit	mV	mV
Max Limit	30	30
Min Limit	20	20

krad	Serial #	Pre-HDR	Post-HDR	Delta	Delta %	% of Limit Range
30	1	25.022	25.022	0.000	0.00%	0.00%
30	2	24.987	25.022	0.035	0.14%	0.35%
30	3	25.021	25.022	0.001	0.00%	0.01%
30	4	24.986	25.022	0.036	0.14%	0.36%
30	5	25.021	25.021	0.000	0.00%	0.00%
30	6	24.987	25.021	0.035	0.14%	0.35%
30	7	25.021	25.021	-0.001	0.00%	0.01%
30	8	24.986	25.021	0.034	0.14%	0.34%
30	9	25.022	25.020	-0.002	-0.01%	0.02%
30	10	24.986	25.021	0.036	0.14%	0.36%
0	11	24.986	25.021	0.035	0.14%	0.35%
Max		25.022	25.022	0.036	0.14%	0.36%
Average		25.002	25.021	0.019	0.08%	0.19%
Min		24.986	25.020	-0.002	-0.01%	0.00%
Std Dev		0.018	0.001	0.018	0.07%	0.18%

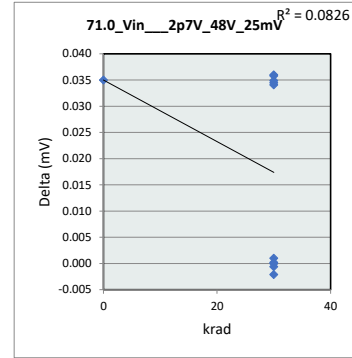

	71.0_Vin__2p7V_48V_25mV	
Test Site	Junkins	
Tester	FETS36401	
Test Number	EQ0581	
Max Limit	30	mV
Min Limit	20	mV
krad	0	30
LL	20.000	20.000
Min	25.021	25.020
Average	25.021	25.021
Max	25.021	25.022
UL	30.000	30.000

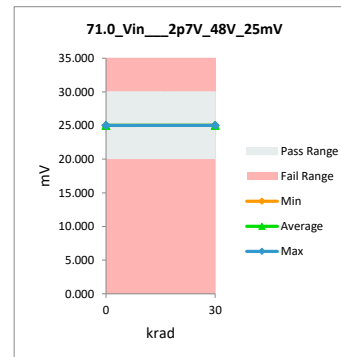

# HDR TID Report INA950A1MPWTSEP

71.1_Vin_20p0V_48V_25mV		
Test Site	Junkins	Junkins
Tester	FETS36401	FETS36401
Test Number	EQ0581	EQ0581
Unit	mV	mV
Max Limit	30	30
Min Limit	20	20

krad	Serial #	Pre-HDR	Post-HDR	Delta	Delta %	% of Limit Range
30	1	25.022	25.021	-0.001	0.00%	0.01%
30	2	24.987	25.022	0.035	0.14%	0.35%
30	3	25.022	25.022	0.000	0.00%	0.00%
30	4	24.988	25.021	0.033	0.13%	0.33%
30	5	25.021	25.022	0.000	0.00%	0.00%
30	6	24.987	25.021	0.034	0.14%	0.34%
30	7	25.021	25.022	0.000	0.00%	0.00%
30	8	24.987	25.021	0.034	0.14%	0.34%
30	9	25.021	25.021	0.000	0.00%	0.00%
30	10	24.986	25.022	0.036	0.14%	0.36%
0	11	24.987	25.020	0.033	0.13%	0.33%
Max		25.022	25.022	0.036	0.14%	0.36%
Average		25.003	25.021	0.019	0.08%	0.19%
Min		24.986	25.020	-0.001	0.00%	0.00%
Std Dev		0.018	0.001	0.018	0.07%	0.18%

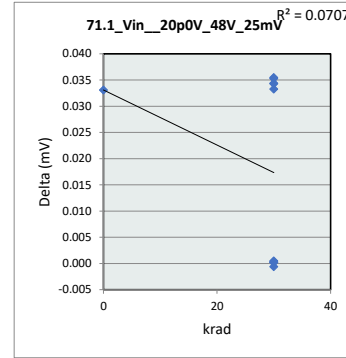

71.1_Vin_20p0V_48V_25mV		
Test Site	Junkins	
Tester	FETS36401	
Test Number	EQ0581	
Max Limit	30	mV
Min Limit	20	mV
krad	0	30
LL	20.000	20.000
Min	25.020	25.021
Average	25.020	25.022
Max	25.020	25.022
UL	30.000	30.000

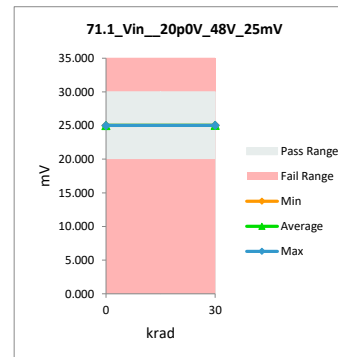





# HDR TID Report INA950A1MPWTSEP

## 71.3\_Vout\_20p0V\_48V\_25mV

Test Site	Junkins	Junkins
Tester	FETS36401	FETS36401
Test Number	EQ0581	EQ0581
Unit	mV	mV
Max Limit	600	600
Min Limit	400	400

krad	Serial #	Pre-HDR	Post-HDR	Delta	Delta %	% of Limit Range
30	1	500.095	499.886	-0.208	-0.04%	0.10%
30	2	499.655	499.949	0.294	0.06%	0.15%
30	3	499.874	499.940	0.065	0.01%	0.03%
30	4	499.589	499.849	0.260	0.05%	0.13%
30	5	499.625	499.777	0.151	0.03%	0.08%
30	6	499.544	499.821	0.277	0.06%	0.14%
30	7	499.872	499.898	0.026	0.01%	0.01%
30	8	499.469	499.721	0.252	0.05%	0.13%
30	9	499.998	499.806	-0.192	-0.04%	0.10%
30	10	499.533	499.832	0.299	0.06%	0.15%
0	11	499.591	499.869	0.278	0.06%	0.14%
Max		500.095	499.949	0.299	0.06%	0.15%
Average		499.713	499.850	0.136	0.03%	0.10%
Min		499.469	499.721	-0.208	-0.04%	0.01%
Std Dev		0.210	0.069	0.191	0.04%	0.05%

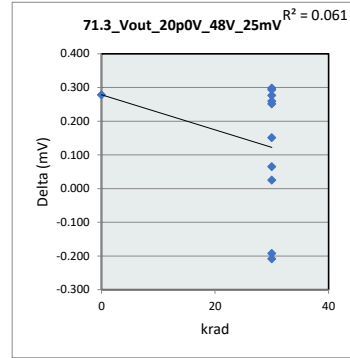

## 71.3\_Vout\_20p0V\_48V\_25mV

Test Site	Junkins
Tester	FETS36401
Test Number	EQ0581
Max Limit	600 mV
Min Limit	400 mV
krad	0      30
LL	400.000      400.000
Min	499.869      499.721
Average	499.869      499.848
Max	499.869      499.949
UL	600.000      600.000

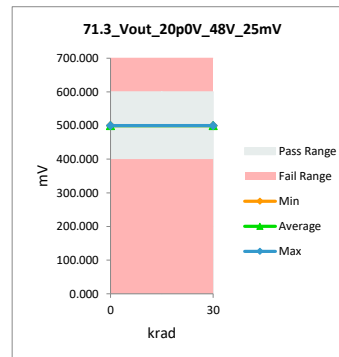

### HDR TID Report INA950A1MPWTSEP

71.4_PSRR_V_V		
Test Site	Junkins	Junkins
Tester	FETS36401	FETS36401
Test Number	EQ0581	EQ0581
Unit	nV/V	nV/V
Max Limit	500	500
Min Limit	-500	-500

krad	Serial #	Pre-HDR	Post-HDR	Delta	Delta %	% of Limit Range
30	1	20.420	-68.682	-89.101	-436.35%	8.91%
30	2	47.346	8.184	-39.162	-82.71%	3.92%
30	3	198.224	8.796	-189.428	-95.56%	18.94%
30	4	33.200	-39.012	-72.212	-217.50%	7.22%
30	5	71.918	-7.114	-79.032	-109.89%	7.90%
30	6	-0.229	72.210	72.440	-31564.18%	7.24%
30	7	161.572	16.980	-144.591	-89.49%	14.46%
30	8	-83.543	-57.373	26.170	-31.33%	2.62%
30	9	56.294	-84.669	-140.963	-250.40%	14.10%
30	10	-55.687	-29.296	26.391	-47.39%	2.64%
0	11	42.919	68.079	25.159	58.62%	2.52%
	Max	198.224	72.210	72.440	58.62%	18.94%
	Average	44.767	-10.172	-54.939	-2987.84%	8.22%
	Min	-83.543	-84.669	-189.428	-31564.18%	2.52%
	Std Dev	82.084	51.722	84.649	9478.62%	5.52%

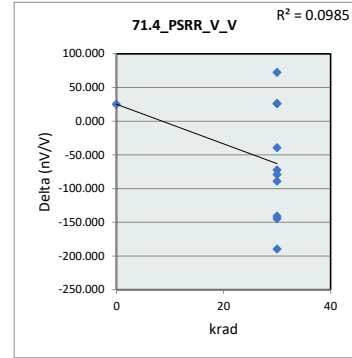

71.4_PSRR_V_V		
Test Site	Junkins	
Tester	FETS36401	
Test Number	EQ0581	
Max Limit	500	nV/V
Min Limit	-500	nV/V
krad	0	30
LL	-500.000	-500.000
Min	68.079	-84.669
Average	68.079	-17.998
Max	68.079	72.210
UL	500.000	500.000

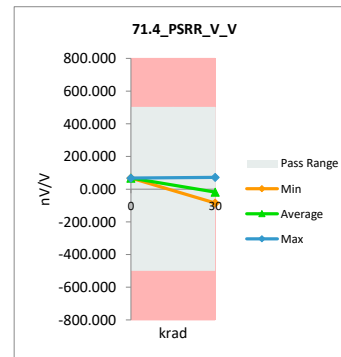



# HDR TID Report INA950A1MPWTSEP

	80.1_Vin_5V_60V_25mV	
Test Site	Junkins	Junkins
Tester	FETS36401	FETS36401
Test Number	EQ0581	EQ0581
Unit	uV	uV
Max Limit	30	30
Min Limit	-20	-20

krad	Serial #	Pre-HDR	Post-HDR	Delta	Delta %	% of Limit Range
30	1	25.023	25.023	0.000	0.00%	0.00%
30	2	24.989	25.023	0.034	0.14%	0.07%
30	3	25.022	25.023	0.001	0.00%	0.00%
30	4	24.988	25.022	0.035	0.14%	0.07%
30	5	25.023	25.021	-0.001	-0.01%	0.00%
30	6	24.988	25.022	0.035	0.14%	0.07%
30	7	25.023	25.022	0.000	0.00%	0.00%
30	8	24.988	25.023	0.035	0.14%	0.07%
30	9	25.022	25.022	0.000	0.00%	0.00%
30	10	24.988	25.021	0.034	0.13%	0.07%
0	11	24.987	25.022	0.035	0.14%	0.07%
Max		25.023	25.023	0.035	0.14%	0.07%
Average		25.004	25.022	0.019	0.08%	0.04%
Min		24.987	25.021	-0.001	-0.01%	0.00%
Std Dev		0.018	0.001	0.018	0.07%	0.04%

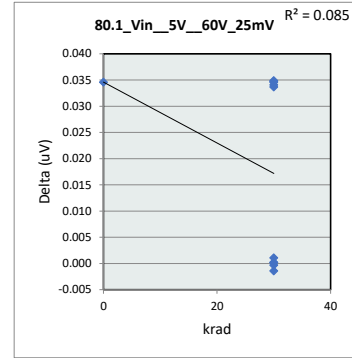

	80.1_Vin_5V_60V_25mV	
Test Site	Junkins	
Tester	FETS36401	
Test Number	EQ0581	
Max Limit	30	uV
Min Limit	-20	uV
krad	0	30
LL	-20.000	-20.000
Min	25.022	25.021
Average	25.022	25.022
Max	25.022	25.023
UL	30.000	30.000

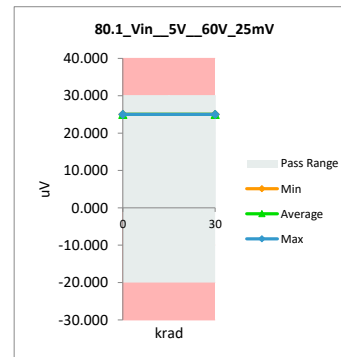



### HDR TID Report INA950A1MPWTSEP

80.7_Vout_5V_2p7V_25mV		
Test Site	Junkins	Junkins
Tester	FETS36401	FETS36401
Test Number	EQ0581	EQ0581
Unit	mV	mV
Max Limit	600	600
Min Limit	400	400

krad	Serial #	Pre-HDR	Post-HDR	Delta	Delta %	% of Limit Range
30	1	500.051	499.855	-0.195	-0.04%	0.10%
30	2	499.623	499.922	0.298	0.06%	0.15%
30	3	499.823	499.900	0.077	0.02%	0.04%
30	4	499.538	499.830	0.293	0.06%	0.15%
30	5	499.545	499.715	0.171	0.03%	0.09%
30	6	499.488	499.775	0.287	0.06%	0.14%
30	7	499.834	499.855	0.021	0.00%	0.01%
30	8	499.379	499.681	0.302	0.06%	0.15%
30	9	499.946	499.769	-0.177	-0.04%	0.09%
30	10	499.497	499.783	0.286	0.06%	0.14%
0	11	499.537	499.816	0.278	0.06%	0.14%
Max		500.051	499.922	0.302	0.06%	0.15%
Average		499.660	499.809	0.149	0.03%	0.11%
Min		499.379	499.681	-0.195	-0.04%	0.01%
Std Dev		0.217	0.074	0.192	0.04%	0.05%

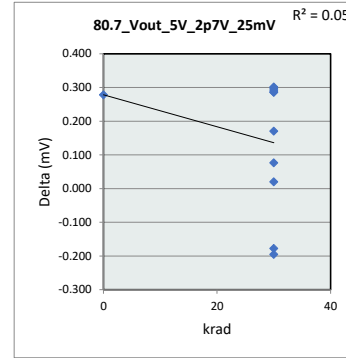

80.7_Vout_5V_2p7V_25mV		
Test Site	Junkins	
Tester	FETS36401	
Test Number	EQ0581	
Max Limit	600	mV
Min Limit	400	mV
krad	0	30
LL	400.000	400.000
Min	499.816	499.681
Average	499.816	499.809
Max	499.816	499.922
UL	600.000	600.000

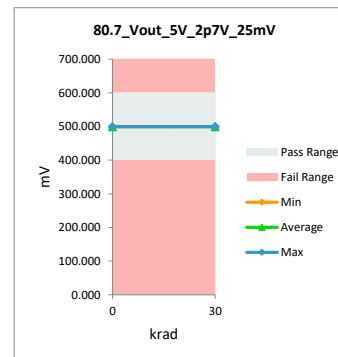

## HDR TID Report INA950A1MPWTSEP

80.8_Vout_5V_60V_25mV		
Test Site	Junkins	Junkins
Tester	FETS36401	FETS36401
Test Number	EQ0581	EQ0581
Unit	mV	mV
Max Limit	600	600
Min Limit	400	400

krad	Serial #	Pre-HDR	Post-HDR	Delta	Delta %	% of Limit Range
30	1	500.056	499.879	-0.177	-0.04%	0.09%
30	2	499.656	499.923	0.267	0.05%	0.13%
30	3	499.851	499.912	0.061	0.01%	0.03%
30	4	499.563	499.847	0.284	0.06%	0.14%
30	5	499.573	499.747	0.174	0.03%	0.09%
30	6	499.520	499.784	0.265	0.05%	0.13%
30	7	499.836	499.882	0.046	0.01%	0.02%
30	8	499.415	499.678	0.264	0.05%	0.13%
30	9	499.973	499.787	-0.186	-0.04%	0.09%
30	10	499.505	499.795	0.290	0.06%	0.15%
0	11	499.569	499.848	0.279	0.06%	0.14%
Max		500.056	499.923	0.290	0.06%	0.15%
Average		499.683	499.826	0.142	0.03%	0.10%
Min		499.415	499.678	-0.186	-0.04%	0.02%
Std Dev		0.211	0.075	0.183	0.04%	0.04%

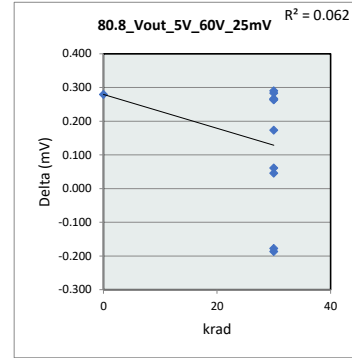

80.8_Vout_5V_60V_25mV		
Test Site	Junkins	
Tester	FETS36401	
Test Number	EQ0581	
Max Limit	600	mV
Min Limit	400	mV
krad	0	30
LL	400.000	400.000
Min	499.848	499.678
Average	499.848	499.823
Max	499.848	499.923
UL	600.000	600.000

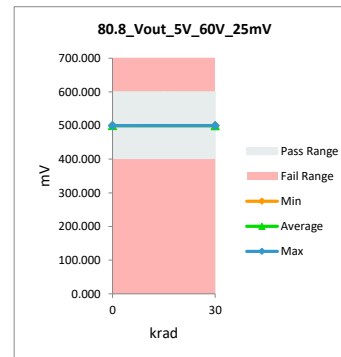

# HDR TID Report INA950A1MPWTSEP

80.9_Vout_5V_80V_25mV		
Test Site	Junkins	Junkins
Tester	FETS36401	FETS36401
Test Number	EQ0581	EQ0581
Unit	mV	mV
Max Limit	600	600
Min Limit	400	400

krad	Serial #	Pre-HDR	Post-HDR	Delta	Delta %	% of Limit Range
30	1	500.073	499.847	-0.226	-0.05%	0.11%
30	2	499.657	499.926	0.269	0.05%	0.13%
30	3	499.836	499.907	0.071	0.01%	0.04%
30	4	499.553	499.833	0.279	0.06%	0.14%
30	5	499.572	499.728	0.156	0.03%	0.08%
30	6	499.527	499.807	0.280	0.06%	0.14%
30	7	499.849	499.872	0.023	0.00%	0.01%
30	8	499.406	499.672	0.266	0.05%	0.13%
30	9	499.979	499.793	-0.186	-0.04%	0.09%
30	10	499.506	499.797	0.292	0.06%	0.15%
0	11	499.586	499.847	0.261	0.05%	0.13%
Max		500.073	499.926	0.292	0.06%	0.15%
Average		499.686	499.821	0.135	0.03%	0.10%
Min		499.406	499.672	-0.226	-0.05%	0.01%
Std Dev		0.215	0.074	0.192	0.04%	0.05%

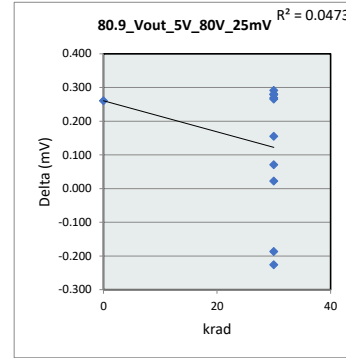

80.9_Vout_5V_80V_25mV		
Test Site	Junkins	
Tester	FETS36401	
Test Number	EQ0581	
Max Limit	600	mV
Min Limit	400	mV
krad	0	30
LL	400.000	400.000
Min	499.847	499.672
Average	499.847	499.818
Max	499.847	499.926
UL	600.000	600.000

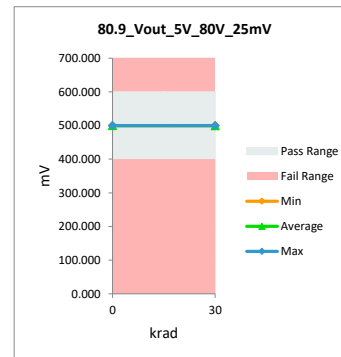



# HDR TID Report INA950A1MPWTSEP

## 80.14\_CMRR\_V\_V\_60V

Test Site	Junkins	Junkins
Tester	FETS36401	FETS36401
Test Number	EQ0581	EQ0581
Unit	nV/V	nV/V
Max Limit	1000	1000
Min Limit	-1000	-1000

krad	Serial #	Pre-HDR	Post-HDR	Delta	Delta %	% of Limit Range
30	1	4.618	20.090	15.472	335.03%	0.77%
30	2	28.404	1.270	-27.134	-95.53%	1.36%
30	3	24.023	10.276	-13.746	-57.22%	0.69%
30	4	22.634	14.434	-8.199	-36.23%	0.41%
30	5	24.717	27.253	2.536	10.26%	0.13%
30	6	27.368	7.968	-19.400	-70.89%	0.97%
30	7	1.386	23.440	22.054	1591.32%	1.10%
30	8	31.181	-1.963	-33.144	-106.30%	1.66%
30	9	24.018	16.050	-7.968	-33.18%	0.40%
30	10	6.582	10.623	4.041	61.40%	0.20%
0	11	27.486	28.292	0.806	2.93%	0.04%
Max		31.181	28.292	22.054	1591.32%	1.66%
Average		20.220	14.339	-5.880	145.60%	0.70%
Min		1.386	-1.963	-33.144	-106.30%	0.04%
Std Dev		10.631	9.939	17.028	494.61%	0.53%

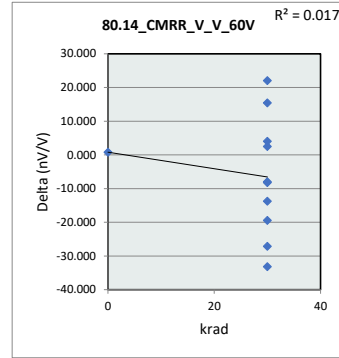

80.14_CMRR_V_V_60V		
Test Site	Junkins	
Tester	FETS36401	
Test Number	EQ0581	
Max Limit	1000	nV/V
Min Limit	-1000	nV/V
krad	0	30
LL	-1000.000	-1000.000
Min	28.292	-1.963
Average	28.292	12.944
Max	28.292	27.253
UL	1000.000	1000.000

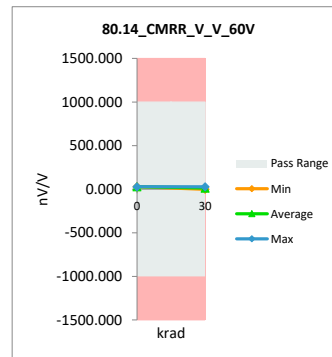

# HDR TID Report INA950A1MPWTSEP

## 80.15\_CMRR\_V\_V\_80V

Test Site	Junkins	Junkins
Tester	FETS36401	FETS36401
Test Number	EQ0581	EQ0581
Unit	nV/V	nV/V
Max Limit	1000	1000
Min Limit	-1000	-1000

krad	Serial #	Pre-HDR	Post-HDR	Delta	Delta %	% of Limit Range
30	1	14.549	-5.306	-19.856	-136.47%	0.99%
30	2	21.911	2.996	-18.915	-86.33%	0.95%
30	3	8.219	4.451	-3.768	-45.85%	0.19%
30	4	10.358	1.455	-8.902	-85.95%	0.45%
30	5	17.637	7.790	-9.847	-55.83%	0.49%
30	6	25.080	20.886	-4.195	-16.72%	0.21%
30	7	9.674	11.042	1.368	14.14%	0.07%
30	8	17.207	-5.821	-23.028	-133.83%	1.15%
30	9	21.826	15.834	-5.992	-27.45%	0.30%
30	10	5.564	9.415	3.852	69.23%	0.19%
0	11	31.503	20.031	-11.473	-36.42%	0.57%
Max		31.503	20.886	3.852	69.23%	1.15%
Average		16.684	7.525	-9.160	-49.23%	0.51%
Min		5.564	-5.821	-23.028	-136.47%	0.07%
Std Dev		7.963	9.108	8.670	61.07%	0.37%

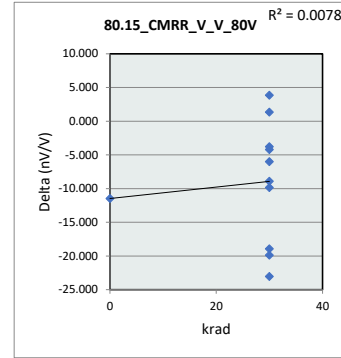

## 80.15\_CMRR\_V\_V\_80V

Test Site	Junkins
Tester	FETS36401
Test Number	EQ0581
Max Limit	1000 nV/V
Min Limit	-1000 nV/V
krad	0 30
LL	-1000.000 -1000.000
Min	20.031 -5.821
Average	20.031 6.274
Max	20.031 20.886
UL	1000.000 1000.000

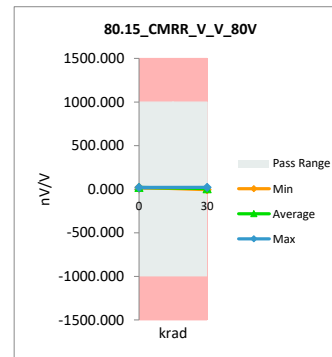

### HDR TID Report INA950A1MPWTSEP

80.20A_CMRR_dB_2p7V_80V		
Test Site	Junkins	Junkins
Tester	FETS36401	FETS36401
Test Number	EQ0581	EQ0581
Unit	dB	dB
Max Limit	500	500
Min Limit	140	140

krad	Serial #	Pre-HDR	Post-HDR	Delta	Delta %	% of Limit Range
30	1	156.743	165.504	8.761	5.59%	2.43%
30	2	153.187	170.470	17.283	11.28%	4.80%
30	3	161.704	167.031	5.327	3.29%	1.48%
30	4	159.695	176.742	17.047	10.67%	4.74%
30	5	155.072	162.170	7.098	4.58%	1.97%
30	6	152.013	153.603	1.590	1.05%	0.44%
30	7	160.288	159.139	-1.149	-0.72%	0.32%
30	8	155.286	164.700	9.414	6.06%	2.62%
30	9	153.220	156.008	2.788	1.82%	0.77%
30	10	165.093	160.523	-4.570	-2.77%	1.27%
0	11	150.033	153.966	3.933	2.62%	1.09%
Max		165.093	176.742	17.283	11.28%	4.80%
Average		156.576	162.714	6.138	3.95%	1.99%
Min		150.033	153.603	-4.570	-2.77%	0.32%
Std Dev		4.612	7.139	6.833	4.34%	1.56%

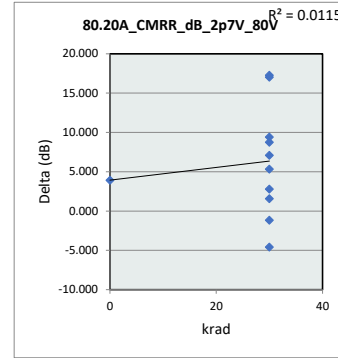

80.20A_CMRR_dB_2p7V_80V		
Test Site	Junkins	
Tester	FETS36401	
Test Number	EQ0581	
Max Limit	500	dB
Min Limit	140	dB
krad	0	30
LL	140.000	140.000
Min	153.966	153.603
Average	153.966	163.589
Max	153.966	176.742
UL	500.000	500.000

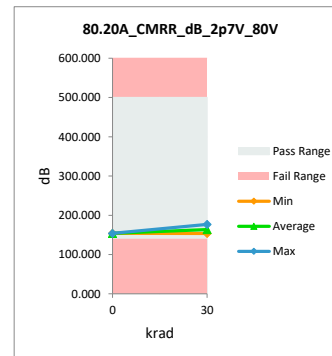

# HDR TID Report INA950A1MPWTSEP

90.0\_Swing\_Low\_5V\_48V\_n1

Test Site	Junkins	Junkins
Tester	FETS36401	FETS36401
Test Number	EQ0581	EQ0581
Unit	mV	mV
Max Limit	15	15
Min Limit	0	0

krad	Serial #	Pre-HDR	Post-HDR	Delta	Delta %	% of Limit Range
30	1	5.140	5.206	0.066	1.28%	0.44%
30	2	3.992	4.217	0.225	5.64%	1.50%
30	3	5.990	5.957	-0.033	-0.55%	0.22%
30	4	5.046	5.440	0.394	7.81%	2.63%
30	5	4.828	4.917	0.089	1.84%	0.59%
30	6	4.575	4.543	-0.032	-0.70%	0.21%
30	7	4.984	4.649	-0.335	-6.72%	2.23%
30	8	4.897	4.966	0.069	1.41%	0.46%
30	9	5.185	4.973	-0.212	-4.09%	1.41%
30	10	4.537	4.509	-0.028	-0.62%	0.19%
0	11	4.847	4.848	0.001	0.02%	0.01%
Max		5.990	5.957	0.394	7.81%	2.63%
Average		4.911	4.930	0.019	0.48%	0.90%
Min		3.992	4.217	-0.335	-6.72%	0.01%
Std Dev		0.492	0.481	0.195	4.00%	0.90%

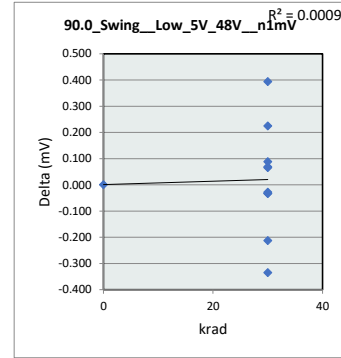

90.0\_Swing\_Low\_5V\_48V\_n1

Test Site	Junkins
Tester	FETS36401
Test Number	EQ0581
Max Limit	15 mV
Min Limit	0 mV
krad	0 30
LL	0.000 0.000
Min	4.848 4.217
Average	4.848 4.938
Max	4.848 5.957
UL	15.000 15.000

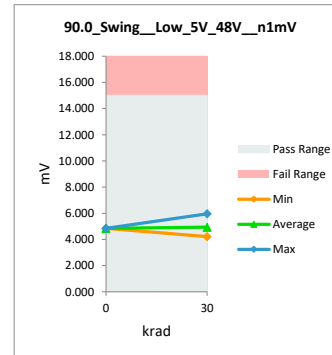

# HDR TID Report INA950A1MPWTSEP

## 100.0\_Swing\_Rest\_5V\_48V\_0

Test Site	Junkins	Junkins
Tester	FETS36401	FETS36401
Test Number	EQ0581	EQ0581
Unit	mV	mV
Max Limit	15	15
Min Limit	0	0

krad	Serial #	Pre-HDR	Post-HDR	Delta	Delta %	% of Limit Range
30	1	5.202	5.243	0.041	0.79%	0.27%
30	2	4.062	4.247	0.185	4.55%	1.23%
30	3	6.056	5.983	-0.073	-1.21%	0.49%
30	4	5.125	5.470	0.345	6.73%	2.30%
30	5	4.894	4.951	0.057	1.16%	0.38%
30	6	4.654	4.603	-0.051	-1.10%	0.34%
30	7	5.048	4.700	-0.348	-6.89%	2.32%
30	8	4.971	5.022	0.051	1.03%	0.34%
30	9	5.248	5.030	-0.218	-4.15%	1.45%
30	10	4.612	4.568	-0.044	-0.95%	0.29%
0	11	4.925	4.911	-0.014	-0.28%	0.09%
Max		6.056	5.983	0.345	6.73%	2.32%
Average		4.982	4.975	-0.006	-0.03%	0.86%
Min		4.062	4.247	-0.348	-6.89%	0.09%
Std Dev		0.490	0.475	0.184	3.71%	0.83%

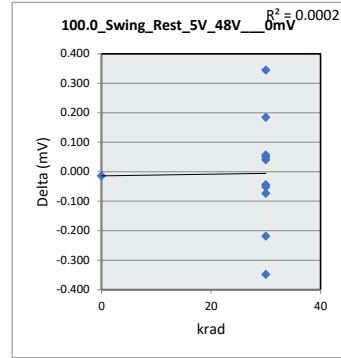

## 100.0\_Swing\_Rest\_5V\_48V

Test Site	Junkins
Tester	FETS36401
Test Number	EQ0581
Max Limit	15 mV
Min Limit	0 mV
krad	0 30
LL	0.000 0.000
Min	4.911 4.247
Average	4.911 4.982
Max	4.911 5.983
UL	15.000 15.000

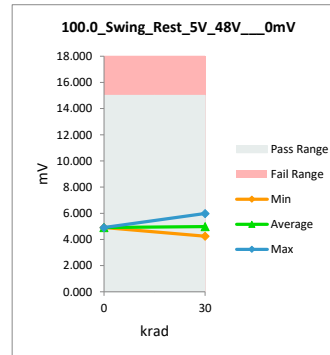

# HDR TID Report INA950A1MPWTSEP

## 110.0\_Swing\_High\_5V\_48V\_250mV

Test Site	Junkins	Junkins
Tester	FETS36401	FETS36401
Test Number	EQ0581	EQ0581
Unit	mV	mV
Max Limit	200	200
Min Limit	35	35

krad	Serial #	Pre-HDR	Post-HDR	Delta	Delta %	% of Limit Range
30	1	61.832	64.920	3.088	4.99%	1.87%
30	2	61.325	65.214	3.889	6.34%	2.36%
30	3	62.191	65.146	2.955	4.75%	1.79%
30	4	61.280	65.013	3.733	6.09%	2.26%
30	5	61.644	64.685	3.041	4.93%	1.84%
30	6	61.764	63.406	1.642	2.66%	1.00%
30	7	62.126	63.198	1.072	1.73%	0.65%
30	8	61.540	63.319	1.779	2.89%	1.08%
30	9	62.356	63.319	0.963	1.54%	0.58%
30	10	61.511	63.363	1.852	3.01%	1.12%
0	11	61.271	61.465	0.194	0.32%	0.12%
Max		62.356	65.214	3.889	6.34%	2.36%
Average		61.713	63.913	2.201	3.57%	1.33%
Min		61.271	61.465	0.194	0.32%	0.12%
Std Dev		0.379	1.175	1.213	1.98%	0.73%

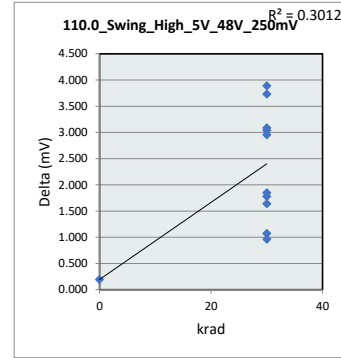

## 110.0\_Swing\_High\_5V\_48V\_250mV

Test Site	Junkins
Tester	FETS36401
Test Number	EQ0581
Max Limit	200 mV
Min Limit	35 mV
krad	0      30
LL	35.000      35.000
Min	61.465      63.198
Average	61.465      64.158
Max	61.465      65.214
UL	200.000      200.000

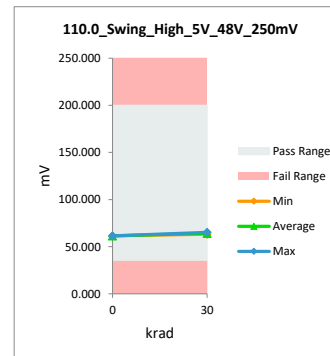

# HDR TID Report INA950A1MPWTSEP

## 120.0\_Swing\_High\_20V\_48V\_1V

Test Site	Junkins	Junkins
Tester	FETS36401	FETS36401
Test Number	EQ0581	EQ0581
Unit	mV	mV
Max Limit	500	500
Min Limit	150	150

krad	Serial #	Pre-HDR	Post-HDR	Delta	Delta %	% of Limit Range
30	1	241.433	252.848	11.415	4.73%	3.26%
30	2	240.665	255.072	14.407	5.99%	4.12%
30	3	243.207	253.736	10.529	4.33%	3.01%
30	4	240.114	253.769	13.655	5.69%	3.90%
30	5	241.278	252.712	11.434	4.74%	3.27%
30	6	241.429	247.738	6.309	2.61%	1.80%
30	7	242.927	247.289	4.362	1.80%	1.25%
30	8	240.781	247.094	6.313	2.62%	1.80%
30	9	243.514	247.284	3.770	1.55%	1.08%
30	10	240.943	247.659	6.716	2.79%	1.92%
0	11	240.478	241.142	0.664	0.28%	0.19%
Max		243.514	255.072	14.407	5.99%	4.12%
Average		241.524	249.668	8.143	3.37%	2.33%
Min		240.114	241.142	0.664	0.28%	0.19%
Std Dev		1.164	4.247	4.415	1.84%	1.26%

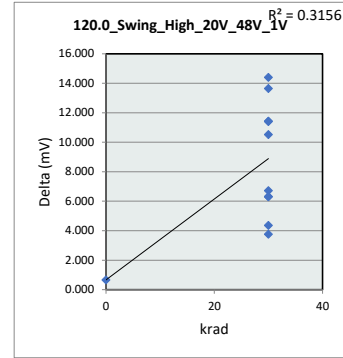

## 120.0\_Swing\_High\_20V\_48V

Test Site	Junkins
Tester	FETS36401
Test Number	EQ0581
Max Limit	500 mV
Min Limit	150 mV
krad	0      30
LL	150.000      150.000
Min	241.142      247.094
Average	241.142      250.520
Max	241.142      255.072
UL	500.000      500.000

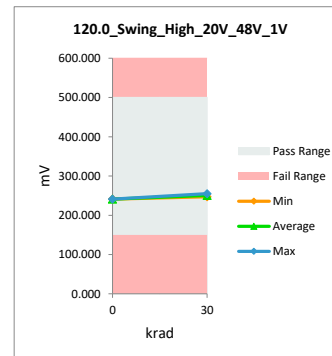





# HDR TID Report INA950A1MPWTSEP

135.0_Delta_IQ_Ref_5V		
Test Site	Junkins	Junkins
Tester	FETS36401	FETS36401
Test Number	EQ0581	EQ0581
Unit	uA	uA
Max Limit	600	600
Min Limit	200	200

krad	Serial #	Pre-HDR	Post-HDR	Delta	Delta %	% of Limit Range
30	1	405.881	404.054	-1.827	-0.45%	0.46%
30	2	375.843	368.028	-7.815	-2.08%	1.95%
30	3	414.033	420.706	6.673	1.61%	1.67%
30	4	402.312	405.529	3.217	0.80%	0.80%
30	5	392.672	393.351	0.679	0.17%	0.17%
30	6	395.525	394.514	-1.011	-0.26%	0.25%
30	7	396.639	397.430	0.791	0.20%	0.20%
30	8	393.208	400.122	6.914	1.76%	1.73%
30	9	401.494	404.625	3.131	0.78%	0.78%
30	10	389.831	391.148	1.317	0.34%	0.33%
0	11	396.872	397.113	0.241	0.06%	0.06%
Max		414.033	420.706	6.914	1.76%	1.95%
Average		396.755	397.875	1.119	0.27%	0.76%
Min		375.843	368.028	-7.815	-2.08%	0.06%
Std Dev		9.753	12.796	4.087	1.05%	0.70%

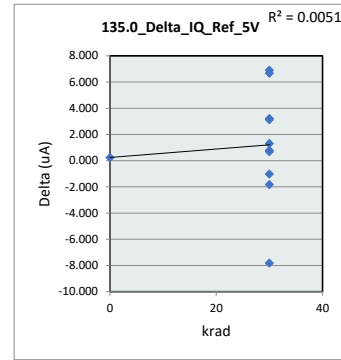

135.0_Delta_IQ_Ref_5V		
Test Site	Junkins	
Tester	FETS36401	
Test Number	EQ0581	
Max Limit	600	uA
Min Limit	200	uA
krad	0	30
LL	200.000	200.000
Min	397.113	368.028
Average	397.113	397.951
Max	397.113	420.706
UL	600.000	600.000

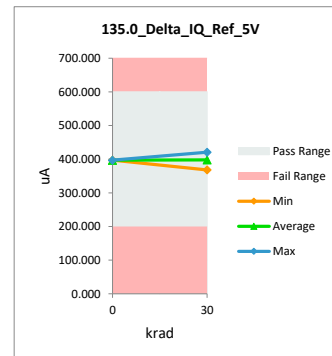

# HDR TID Report INA950A1MPWTSEP

## 135.1\_Delta\_IQ\_5V\_to\_2p7V

Test Site	Junkins	Junkins
Tester	FETS36401	FETS36401
Test Number	EQ0581	EQ0581
Unit	uA	uA
Max Limit	70	70
Min Limit	20	20

krad	Serial #	Pre-HDR	Post-HDR	Delta	Delta %	% of Limit Range
30	1	46.848	44.047	-2.801	-5.98%	5.60%
30	2	48.921	46.307	-2.614	-5.34%	5.23%
30	3	48.718	50.471	1.753	3.60%	3.51%
30	4	47.654	47.471	-0.183	-0.38%	0.37%
30	5	47.132	45.960	-1.172	-2.49%	2.34%
30	6	50.016	46.831	-3.185	-6.37%	6.37%
30	7	45.448	44.389	-1.059	-2.33%	2.12%
30	8	46.773	43.963	-2.810	-6.01%	5.62%
30	9	48.745	44.911	-3.834	-7.87%	7.67%
30	10	49.674	47.556	-2.118	-4.26%	4.24%
0	11	48.345	47.432	-0.913	-1.89%	1.83%
	Max	50.016	50.471	1.753	3.60%	7.67%
	Average	48.025	46.303	-1.721	-3.57%	4.08%
	Min	45.448	43.963	-3.834	-7.87%	0.37%
	Std Dev	1.383	1.953	1.604	3.30%	2.24%

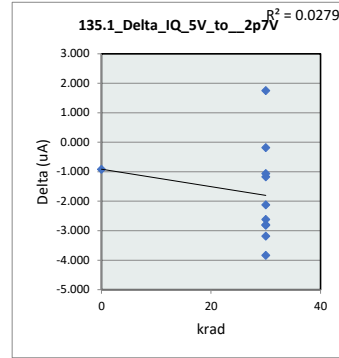

## 135.1\_Delta\_IQ\_5V\_to\_2p7V

Test Site	Junkins
Tester	FETS36401
Test Number	EQ0581
Max Limit	70 uA
Min Limit	20 uA
krad	0 30
LL	20.000 20.000
Min	47.432 43.963
Average	47.432 46.191
Max	47.432 50.471
UL	70.000 70.000

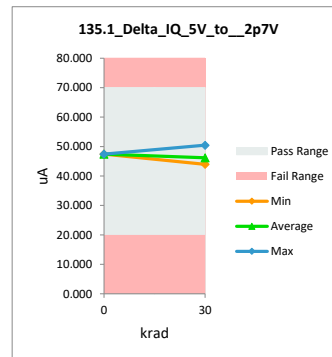

# HDR TID Report INA950A1MPWTSEP

## 135.2\_Delta\_IQ\_5V\_to\_5p0V

Test Site	Junkins	Junkins
Tester	FETS36401	FETS36401
Test Number	EQ0581	EQ0581
Unit	uA	uA
Max Limit	10	10
Min Limit	-10	-10

krad	Serial #	Pre-HDR	Post-HDR	Delta	Delta %	% of Limit Range
30	1	-0.155	1.866	2.021	-1303.87%	10.11%
30	2	0.893	1.105	0.212	23.74%	1.06%
30	3	0.399	-1.258	-1.657	-415.29%	8.29%
30	4	1.037	1.246	0.209	20.15%	1.05%
30	5	-0.407	-0.459	-0.052	12.78%	0.26%
30	6	0.625	2.311	1.686	269.76%	8.43%
30	7	2.293	1.087	-1.206	-52.59%	6.03%
30	8	1.568	-0.216	-1.784	-113.78%	8.92%
30	9	-0.889	-0.096	0.793	-89.20%	3.96%
30	10	0.284	1.088	0.804	283.10%	4.02%
0	11	1.339	0.380	-0.959	-71.62%	4.79%
	Max	2.293	2.311	2.021	283.10%	10.11%
	Average	0.635	0.641	0.006	-130.62%	5.17%
	Min	-0.889	-1.258	-1.784	-1303.87%	0.26%
	Std Dev	0.925	1.069	1.288	432.17%	3.47%

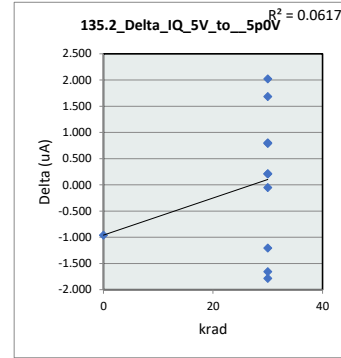

## 135.2\_Delta\_IQ\_5V\_to\_5p0V

Test Site	Junkins
Tester	FETS36401
Test Number	EQ0581
Max Limit	10 uA
Min Limit	-10 uA
krad	0 30
LL	-10.000 -10.000
Min	0.380 -1.258
Average	0.380 0.667
Max	0.380 2.311
UL	10.000 10.000

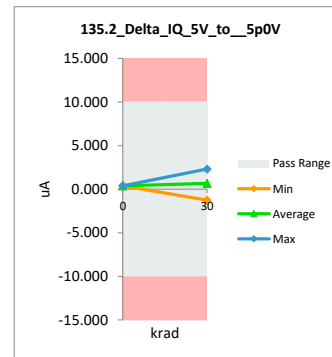

# HDR TID Report INA950A1MPWTSEP

## 135.3\_Delta\_IQ\_5V\_to\_12p0V

Test Site	Junkins	Junkins
Tester	FETS36401	FETS36401
Test Number	EQ0581	EQ0581
Unit	uA	uA
Max Limit	10	10
Min Limit	-20	-20

krad	Serial #	Pre-HDR	Post-HDR	Delta	Delta %	% of Limit Range
30	1	-4.880	-3.200	1.680	-34.43%	5.60%
30	2	-4.021	-4.448	-0.427	10.62%	1.42%
30	3	-4.375	-3.693	0.682	-15.59%	2.27%
30	4	-4.121	-5.378	-1.257	30.50%	4.19%
30	5	-1.771	-2.213	-0.442	24.96%	1.47%
30	6	-3.998	-3.534	0.464	-11.61%	1.55%
30	7	-3.845	-4.612	-0.767	19.95%	2.56%
30	8	-5.050	-7.035	-1.985	39.31%	6.62%
30	9	-4.786	-5.941	-1.155	24.13%	3.85%
30	10	-4.631	-3.052	1.579	-34.10%	5.26%
0	11	-3.722	-5.514	-1.792	48.15%	5.97%
Max		-1.771	-2.213	1.680	48.15%	6.62%
Average		-4.109	-4.420	-0.311	9.26%	3.71%
Min		-5.050	-7.035	-1.985	-34.43%	1.42%
Std Dev		0.894	1.444	1.263	28.79%	1.95%

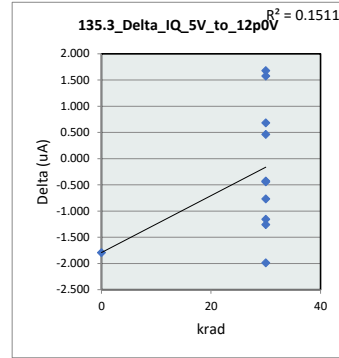

## 135.3\_Delta\_IQ\_5V\_to\_12p0V

Test Site	Junkins
Tester	FETS36401
Test Number	EQ0581
Max Limit	10 uA
Min Limit	-20 uA
krad	0 30
LL	-20.000 -20.000
Min	-5.514 -7.035
Average	-5.514 -4.311
Max	-5.514 -2.213
UL	10.000 10.000

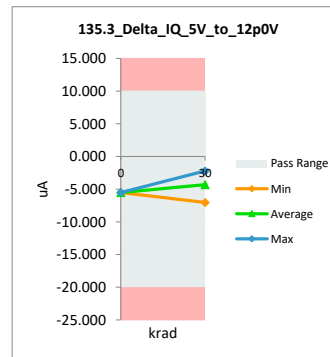

# HDR TID Report INA950A1MPWTSEP

## 135.4\_Delta\_IQ\_5V\_to\_20p0V

Test Site	Junkins	Junkins
Tester	FETS36401	FETS36401
Test Number	EQ0581	EQ0581
Unit	uA	uA
Max Limit	10	10
Min Limit	-30	-30

krad	Serial #	Pre-HDR	Post-HDR	Delta	Delta %	% of Limit Range
30	1	-10.287	-11.968	-1.681	16.34%	4.20%
30	2	-9.666	-7.565	2.101	-21.74%	5.25%
30	3	-8.564	-9.538	-0.974	11.37%	2.43%
30	4	-8.792	-9.226	-0.434	4.94%	1.09%
30	5	-9.467	-7.765	1.702	-17.98%	4.26%
30	6	-11.248	-8.746	2.502	-22.24%	6.25%
30	7	-8.521	-9.532	-1.011	11.86%	2.53%
30	8	-11.230	-12.636	-1.406	12.52%	3.52%
30	9	-9.364	-9.302	0.062	-0.66%	0.16%
30	10	-10.422	-10.845	-0.423	4.06%	1.06%
0	11	-9.561	-11.262	-1.701	17.79%	4.25%
Max		-8.521	-7.565	2.502	17.79%	6.25%
Average		-9.738	-9.853	-0.115	1.48%	3.18%
Min		-11.248	-12.636	-1.701	-22.24%	0.16%
Std Dev		0.963	1.640	1.532	15.23%	1.90%

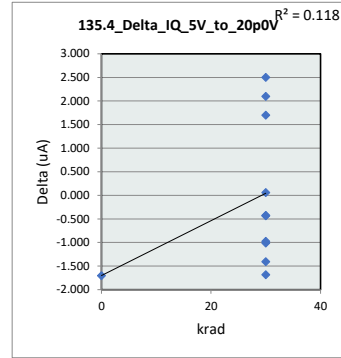

## 135.4\_Delta\_IQ\_5V\_to\_20p0V

Test Site	Junkins
Tester	FETS36401
Test Number	EQ0581
Max Limit	10 uA
Min Limit	-30 uA
krad	0 30
LL	-30.000 -30.000
Min	-11.262 -12.636
Average	-11.262 -9.712
Max	-11.262 -7.565
UL	10.000 10.000

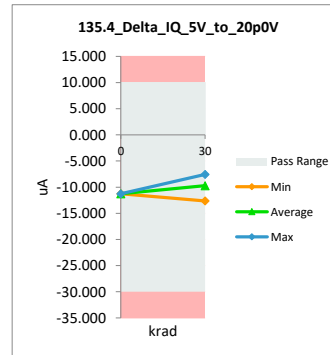

LDR TID Report  
INA950A1MPWTSEP

# LDR TID Report

## INA950A1MPWTSEP

20.0\_n20CM\_IQ\_VS\_5p0\_48V\_0

Test Site	Junkins	Junkins
Tester	FETS36401	FETS36401
Test Number	EQ0581	EQ0581
Unit	uA	uA
Max Limit	100	100
Min Limit	-100	-100

krad	Serial #	NA950 LDR Pre-Te	IA950 LDR Post-Te	Delta	Delta %	% of Limit Range
30	1	16.269	15.343	-0.926	-5.69%	0.46%
30	2	18.948	14.710	-4.238	-22.37%	2.12%
30	3	14.515	15.538	1.023	7.05%	0.51%
30	4	14.710	16.366	1.656	11.26%	0.83%
30	5	17.779	13.833	-3.946	-22.19%	1.97%
30	6	17.779	19.873	2.094	11.78%	1.05%
30	7	16.756	16.853	0.097	0.58%	0.05%
30	8	16.707	15.976	-0.731	-4.38%	0.37%
30	9	18.363	16.707	-1.656	-9.02%	0.83%
30	10	17.145	15.051	-2.094	-12.21%	1.05%
0	11	14.564	14.028	-0.536	-3.68%	0.27%
Max		18.948	19.873	2.094	11.78%	2.12%
Average		16.685	15.843	-0.842	-4.44%	0.86%
Min		14.515	13.833	-4.238	-22.37%	0.05%
Std Dev		1.544	1.670	2.067	11.78%	0.67%

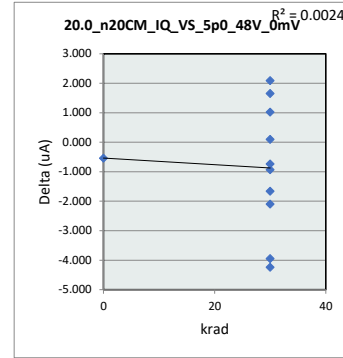

20.0\_n20CM\_IQ\_VS\_5p0\_48V

Test Site	Junkins
Tester	FETS36401
Test Number	EQ0581
Max Limit	100 uA
Min Limit	-100 uA
krad	0 30
LL	-100.000 -100.000
Min	14.028 13.833
Average	14.028 16.025
Max	14.028 19.873
UL	100.000 100.000

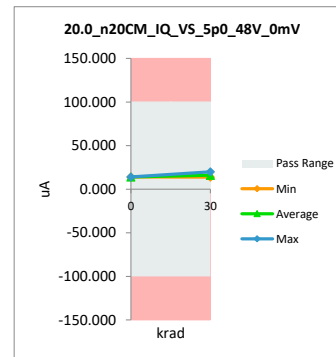

LDR TID Report  
INA950A1MPWTSEP

20.1\_n20CM\_IB\_Pos\_VS\_5p0\_48V\_0m

Test Site	Junkins	Junkins
Tester	FETS36401	FETS36401
Test Number	EQ0581	EQ0581
Unit	uA	uA
Max Limit	10	10
Min Limit	-10	-10

krad	Serial #	NA950 LDR Pre-Te	IA950 LDR Post-Te	Delta	Delta %	% of Limit Range
30	1	0.079	-0.029	-0.108	-136.71%	0.54%
30	2	-0.237	-0.337	-0.100	42.19%	0.50%
30	3	-0.279	-0.167	0.112	-40.14%	0.56%
30	4	0.029	0.056	0.027	93.10%	0.14%
30	5	-0.027	-0.064	-0.037	137.04%	0.19%
30	6	0.068	0.128	0.060	88.24%	0.30%
30	7	-0.131	0.061	0.192	-146.56%	0.96%
30	8	-0.021	0.019	0.040	-190.48%	0.20%
30	9	-0.038	0.062	0.100	-263.16%	0.50%
30	10	0.017	0.010	-0.007	-41.18%	0.04%
0	11	-0.096	0.045	0.141	-146.88%	0.71%
	Max	0.079	0.128	0.192	137.04%	0.96%
	Average	-0.058	-0.020	0.038	-54.96%	0.42%
	Min	-0.279	-0.337	-0.108	-263.16%	0.04%
	Std Dev	0.118	0.131	0.096	132.05%	0.28%

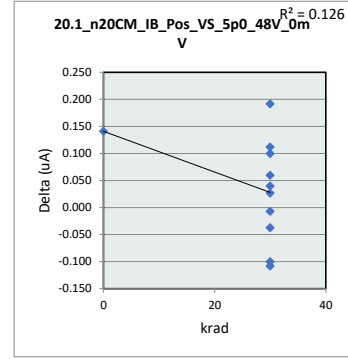

20.1\_n20CM\_IB\_Pos\_VS\_5p0

Test Site	Junkins
Tester	FETS36401
Test Number	EQ0581
Max Limit	10 uA
Min Limit	-10 uA
krad	0 30
LL	-10.000 -10.000
Min	0.045 -0.337
Average	0.045 -0.026
Max	0.045 0.128
UL	10.000 10.000

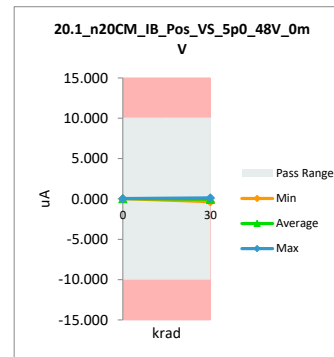



LDR TID Report  
INA950A1MPWTSEP

20.2\_n20CM\_IB\_Neg\_VS\_5p0\_4

Test Site	Junkins	Junkins
Tester	FETS36401	FETS36401
Test Number	EQ0581	EQ0581
Unit	uA	uA
Max Limit	10	10
Min Limit	-10	-10

krad	Serial #	NA950 LDR Pre-Te	IA950 LDR Post-Te	Delta	Delta %	% of Limit Range
30	1	-0.036	-0.769	-0.733	2036.11%	3.66%
30	2	-0.600	-0.457	0.143	-23.83%	0.72%
30	3	-0.405	-0.115	0.290	-71.60%	1.45%
30	4	-0.673	0.151	0.824	-122.44%	4.12%
30	5	1.275	-0.495	-1.770	-138.82%	8.85%
30	6	-0.230	-0.032	0.198	-86.09%	0.99%
30	7	-0.101	-0.235	-0.134	132.67%	0.67%
30	8	-0.893	0.569	1.462	-163.72%	7.31%
30	9	1.165	-0.588	-1.753	-150.47%	8.76%
30	10	0.313	0.175	-0.138	-44.09%	0.69%
0	11	-0.602	-0.488	0.114	-18.94%	0.57%
Max		1.275	0.569	1.462	2036.11%	8.85%
Average		-0.072	-0.208	-0.136	122.62%	3.44%
Min		-0.893	-0.769	-1.770	-163.72%	0.57%
Std Dev		0.723	0.400	0.977	640.08%	3.38%

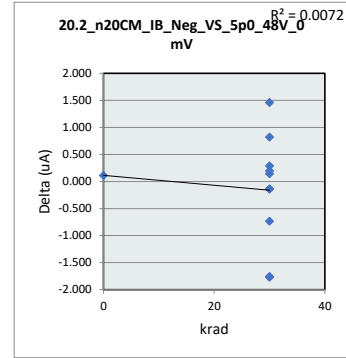

20.2\_n20CM\_IB\_Neg\_VS\_5p0

Test Site	Junkins
Tester	FETS36401
Test Number	EQ0581
Max Limit	10 uA
Min Limit	-10 uA
krad	0 30
LL	-10.000 -10.000
Min	-0.488 -0.769
Average	-0.488 -0.180
Max	-0.488 0.569
UL	10.000 10.000

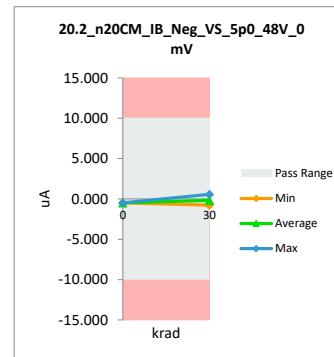

### LDR TID Report INA950A1MPWTSEP

30.0 IQ_VS_2p7V_48V_25mV		
Test Site	Junkins	Junkins
Tester	FETS36401	FETS36401
Test Number	EQ0581	EQ0581
Unit	uA	uA
Max Limit	600	600
Min Limit	100	100

krad	Serial #	NA950 LDR Pre-Te	IA950 LDR Post-Te	Delta	Delta %	% of Limit Range
30	1	361.176	362.442	1.266	0.35%	0.25%
30	2	361.614	363.270	1.656	0.46%	0.33%
30	3	352.262	352.311	0.049	0.01%	0.01%
30	4	352.457	358.497	6.040	1.71%	1.21%
30	5	349.339	351.288	1.949	0.56%	0.39%
30	6	337.747	337.162	-0.585	-0.17%	0.12%
30	7	355.623	356.792	1.169	0.33%	0.23%
30	8	347.878	347.975	0.097	0.03%	0.02%
30	9	337.454	345.540	8.086	2.40%	1.62%
30	10	342.033	341.984	-0.049	-0.01%	0.01%
0	11	343.981	342.764	-1.217	-0.35%	0.24%
Max		361.614	363.270	8.086	2.40%	1.62%
Average		349.233	350.911	1.678	0.48%	0.40%
Min		337.454	337.162	-1.217	-0.35%	0.01%
Std Dev		8.416	8.675	2.868	0.84%	0.52%

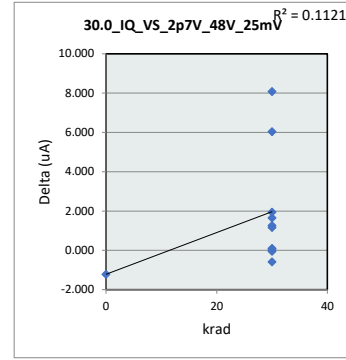

30.0 IQ_VS_2p7V_48V_25mV		
Test Site	Junkins	
Tester	FETS36401	
Test Number	EQ0581	
Max Limit	600	uA
Min Limit	100	uA
krad	0	30
LL	100.000	100.000
Min	342.764	337.162
Average	342.764	351.726
Max	342.764	363.270
UL	600.000	600.000

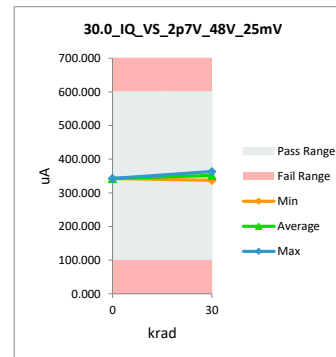

# LDR TID Report INA950A1MPWTSEP

**30.1\_IQ\_VS\_5p0V\_48V\_25mV**

Test Site	Junkins	Junkins
Tester	FETS36401	FETS36401
Test Number	EQ0581	EQ0581
Unit	uA	uA
Max Limit	600	600
Min Limit	100	100

krad	Serial #	NA950 LDR Pre-Te	IA950 LDR Post-Te	Delta	Delta %	% of Limit Range
30	1	409.982	411.833	1.851	0.45%	0.37%
30	2	410.176	410.225	0.049	0.01%	0.01%
30	3	402.432	401.360	-1.072	-0.27%	0.21%
30	4	400.435	404.526	4.091	1.02%	0.82%
30	5	392.739	394.784	2.045	0.52%	0.41%
30	6	379.539	379.149	-0.390	-0.10%	0.08%
30	7	406.426	403.357	-3.069	-0.76%	0.61%
30	8	395.661	395.174	-0.487	-0.12%	0.10%
30	9	387.040	393.031	5.991	1.55%	1.20%
30	10	385.432	388.063	2.631	0.68%	0.53%
0	11	399.022	397.074	-1.948	-0.49%	0.39%
Max		410.176	411.833	5.991	1.55%	1.20%
Average		397.171	398.052	0.881	0.23%	0.43%
Min		379.539	379.149	-3.069	-0.76%	0.01%
Std Dev		10.168	9.599	2.709	0.69%	0.35%

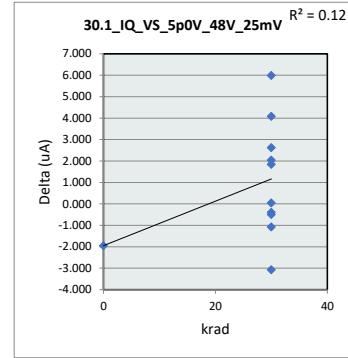

**30.1\_IQ\_VS\_5p0V\_48V\_25mV**

Test Site	Junkins	
Tester	FETS36401	
Test Number	EQ0581	
Max Limit	600 uA	
Min Limit	100 uA	
krad	0	30
LL	100.000	100.000
Min	397.074	379.149
Average	397.074	398.150
Max	397.074	411.833
UL	600.000	600.000

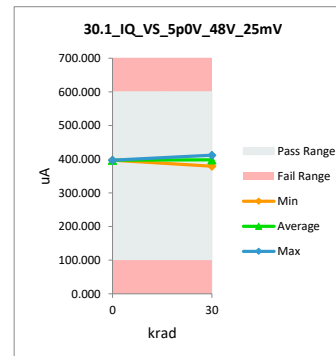

# LDR TID Report INA950A1MPWTSEP

## 30.2 IQ\_VS\_12p0V\_48V\_25mV

Test Site	Junkins	Junkins
Tester	FETS36401	FETS36401
Test Number	EQ0581	EQ0581
Unit	uA	uA
Max Limit	500	500
Min Limit	200	200

krad	Serial #	NA950 LDR Pre-Te	IA950 LDR Post-Te	Delta	Delta %	% of Limit Range
30	1	417.337	417.824	0.487	0.12%	0.16%
30	2	414.219	414.073	-0.146	-0.04%	0.05%
30	3	406.572	405.452	-1.120	-0.28%	0.37%
30	4	403.552	409.787	6.235	1.55%	2.08%
30	5	396.733	398.925	2.192	0.55%	0.73%
30	6	382.607	383.094	0.487	0.13%	0.16%
30	7	412.076	409.300	-2.776	-0.67%	0.93%
30	8	402.383	400.435	-1.948	-0.48%	0.65%
30	9	392.446	398.048	5.602	1.43%	1.87%
30	10	392.349	392.690	0.341	0.09%	0.11%
0	11	403.406	401.409	-1.997	-0.50%	0.67%
Max		417.337	417.824	6.235	1.55%	2.08%
Average		402.153	402.822	0.669	0.17%	0.71%
Min		382.607	383.094	-2.776	-0.67%	0.05%
Std Dev		10.486	9.933	2.958	0.74%	0.69%

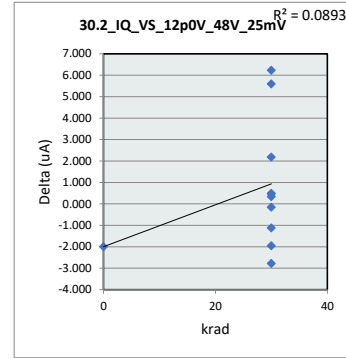

## 30.2 IQ\_VS\_12p0V\_48V\_25m

Test Site	Junkins
Tester	FETS36401
Test Number	EQ0581
Max Limit	500 uA
Min Limit	200 uA
krad	0      30
LL	200.000      200.000
Min	401.409      383.094
Average	401.409      402.963
Max	401.409      417.824
UL	500.000      500.000

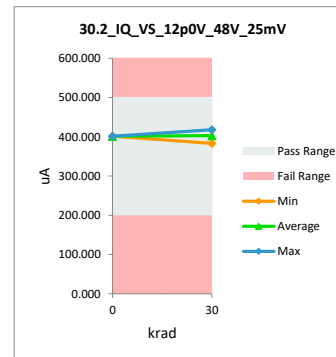

LDR TID Report  
INA950A1MPWTSEP

**30.3 IQ\_VS\_20p0V\_48V\_25mV**

Test Site	Junkins	Junkins
Tester	FETS36401	FETS36401
Test Number	EQ0581	EQ0581
Unit	uA	uA
Max Limit	500	500
Min Limit	200	200

krad	Serial #	NA950 LDR Pre-Te	IA950 LDR Post-Te	Delta	Delta %	% of Limit Range
30	1	421.136	421.282	0.146	0.03%	0.05%
30	2	419.967	419.285	-0.682	-0.16%	0.23%
30	3	412.953	410.128	-2.825	-0.68%	0.94%
30	4	410.079	414.414	4.335	1.06%	1.44%
30	5	400.142	402.724	2.582	0.65%	0.86%
30	6	387.770	387.624	-0.146	-0.04%	0.05%
30	7	417.726	416.411	-1.315	-0.31%	0.44%
30	8	407.010	405.208	-1.802	-0.44%	0.60%
30	9	397.610	403.455	5.845	1.47%	1.95%
30	10	396.928	396.489	-0.439	-0.11%	0.15%
0	11	407.644	407.692	0.048	0.01%	0.02%
Max		421.136	421.282	5.845	1.47%	1.95%
Average		407.179	407.701	0.522	0.13%	0.61%
Min		387.770	387.624	-2.825	-0.68%	0.02%
Std Dev		10.651	10.116	2.651	0.66%	0.64%

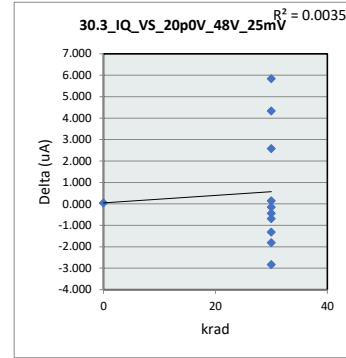

**30.3 IQ\_VS\_20p0V\_48V\_25m**

Test Site	Junkins
Tester	FETS36401
Test Number	EQ0581
Max Limit	500 uA
Min Limit	200 uA
krad	0      30
LL	200.000      200.000
Min	407.692      387.624
Average	407.692      407.702
Max	407.692      421.282
UL	500.000      500.000

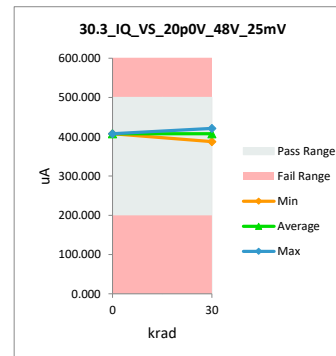

### LDR TID Report INA950A1MPWTSEP

40.0_IB_Pos_VS_5p0V_48V_0m		
Test Site	Junkins	Junkins
Tester	FETS36401	FETS36401
Test Number	EQ0581	EQ0581
Unit	uA	uA
Max Limit	30	30
Min Limit	8	8

krad	Serial #	NA950 LDR Pre-Te	IA950 LDR Post-Te	Delta	Delta %	% of Limit Range
30	1	18.782	18.787	0.005	0.03%	0.02%
30	2	19.228	19.353	0.125	0.65%	0.57%
30	3	19.443	19.410	-0.033	-0.17%	0.15%
30	4	18.259	18.271	0.012	0.07%	0.05%
30	5	17.787	17.761	-0.026	-0.15%	0.12%
30	6	17.944	17.979	0.035	0.20%	0.16%
30	7	18.720	18.605	-0.115	-0.61%	0.52%
30	8	18.604	18.631	0.027	0.15%	0.12%
30	9	18.530	18.516	-0.014	-0.08%	0.06%
30	10	18.334	18.380	0.046	0.25%	0.21%
0	11	18.485	18.488	0.003	0.02%	0.01%
Max		19.443	19.410	0.125	0.65%	0.57%
Average		18.556	18.562	0.006	0.03%	0.18%
Min		17.787	17.761	-0.115	-0.61%	0.01%
Std Dev		0.493	0.501	0.059	0.31%	0.19%

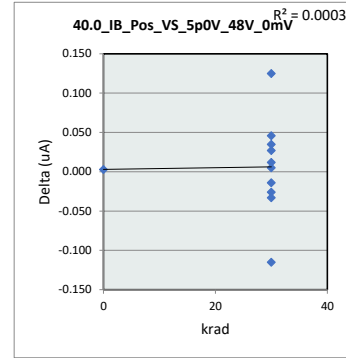

40.0_IB_Pos_VS_5p0V_48V_0		
Test Site	Junkins	
Tester	FETS36401	
Test Number	EQ0581	
Max Limit	30	uA
Min Limit	8	uA
krad	0	30
LL	8.000	8.000
Min	18.488	17.761
Average	18.488	18.569
Max	18.488	19.410
UL	30.000	30.000

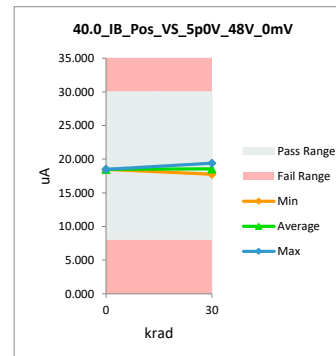

# LDR TID Report INA950A1MPWTSEP

40.1\_IB\_Neg\_VS\_5p0V\_48V\_0m

Test Site	Junkins	Junkins
Tester	FETS36401	FETS36401
Test Number	EQ0581	EQ0581
Unit	uA	uA
Max Limit	30	30
Min Limit	8	8

krad	Serial #	NA950 LDR Pre-Te	IA950 LDR Post-Te	Delta	Delta %	% of Limit Range
30	1	18.851	18.845	-0.006	-0.03%	0.03%
30	2	19.213	19.408	0.195	1.01%	0.89%
30	3	19.474	19.461	-0.013	-0.07%	0.06%
30	4	18.338	18.361	0.023	0.13%	0.10%
30	5	17.811	17.813	0.002	0.01%	0.01%
30	6	17.974	18.012	0.038	0.21%	0.17%
30	7	18.772	18.643	-0.129	-0.69%	0.59%
30	8	18.621	18.675	0.054	0.29%	0.25%
30	9	18.534	18.577	0.043	0.23%	0.20%
30	10	18.329	18.367	0.038	0.21%	0.17%
0	11	18.552	18.578	0.026	0.14%	0.12%
Max		19.474	19.461	0.195	1.01%	0.89%
Average		18.588	18.613	0.025	0.13%	0.23%
Min		17.811	17.813	-0.129	-0.69%	0.01%
Std Dev		0.489	0.504	0.076	0.40%	0.27%

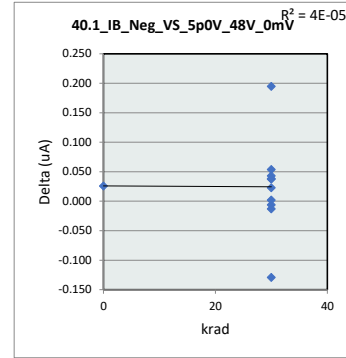

40.1\_IB\_Neg\_VS\_5p0V\_48V\_0

Test Site	Junkins
Tester	FETS36401
Test Number	EQ0581
Max Limit	30 uA
Min Limit	8 uA
krad	0 30
LL	8.000 8.000
Min	18.578 17.813
Average	18.578 18.616
Max	18.578 19.461
UL	30.000 30.000

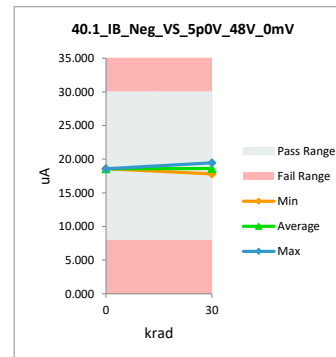

# LDR TID Report INA950A1MPWTSEP

**45.0\_IB\_Pos\_VS\_5p0V\_60V\_0m**

Test Site	Junkins	Junkins
Tester	FETS36401	FETS36401
Test Number	EQ0581	EQ0581
Unit	uA	uA
Max Limit	30	30
Min Limit	8	8

krad	Serial #	NA950 LDR Pre-Te	IA950 LDR Post-Te	Delta	Delta %	% of Limit Range
30	1	19.236	19.270	0.034	0.18%	0.15%
30	2	19.616	19.811	0.195	0.99%	0.89%
30	3	19.865	19.919	0.054	0.27%	0.25%
30	4	18.621	18.958	0.337	1.81%	1.53%
30	5	18.397	18.221	-0.176	-0.96%	0.80%
30	6	18.397	18.631	0.234	1.27%	1.06%
30	7	19.250	19.221	-0.029	-0.15%	0.13%
30	8	18.948	19.299	0.351	1.85%	1.60%
30	9	19.031	19.104	0.073	0.38%	0.33%
30	10	18.763	18.933	0.170	0.91%	0.77%
0	11	19.002	18.880	-0.122	-0.64%	0.55%
Max		19.865	19.919	0.351	1.85%	1.60%
Average		19.011	19.113	0.102	0.54%	0.73%
Min		18.397	18.221	-0.176	-0.96%	0.13%
Std Dev		0.466	0.484	0.173	0.92%	0.51%

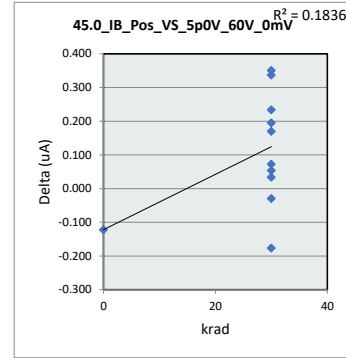

**45.0\_IB\_Pos\_VS\_5p0V\_60V\_0**

Test Site	Junkins
Tester	FETS36401
Test Number	EQ0581
Max Limit	30 uA
Min Limit	8 uA
krad	0 30
LL	8.000 8.000
Min	18.880 18.221
Average	18.880 19.137
Max	18.880 19.919
UL	30.000 30.000

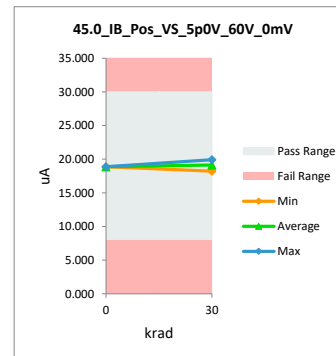



LDR TID Report  
INA950A1MPWTSEP

45.1_IB_Neg_VS_5p0V_60V_0m		
Test Site	Junkins	Junkins
Tester	FETS36401	FETS36401
Test Number	EQ0581	EQ0581
Unit	uA	uA
Max Limit	30	30
Min Limit	8	8

krad	Serial #	NA950 LDR Pre-Te	IA950 LDR Post-Te	Delta	Delta %	% of Limit Range
30	1	19.719	19.714	-0.005	-0.03%	0.02%
30	2	20.144	20.378	0.234	1.16%	1.06%
30	3	20.353	20.451	0.098	0.48%	0.45%
30	4	19.227	19.461	0.234	1.22%	1.06%
30	5	18.676	18.754	0.078	0.42%	0.35%
30	6	18.993	18.905	-0.088	-0.46%	0.40%
30	7	19.661	19.602	-0.059	-0.30%	0.27%
30	8	19.612	19.583	-0.029	-0.15%	0.13%
30	9	19.739	19.510	-0.229	-1.16%	1.04%
30	10	19.246	19.217	-0.029	-0.15%	0.13%
0	11	19.432	19.753	0.321	1.65%	1.46%
Max		20.353	20.451	0.321	1.65%	1.46%
Average		19.527	19.575	0.048	0.24%	0.58%
Min		18.676	18.754	-0.229	-1.16%	0.02%
Std Dev		0.486	0.523	0.164	0.84%	0.49%

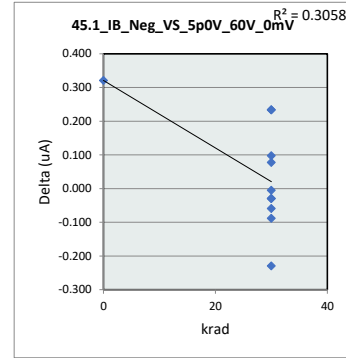

45.1_IB_Neg_VS_5p0V_60V_0		
Test Site	Junkins	
Tester	FETS36401	
Test Number	EQ0581	
Max Limit	30	uA
Min Limit	8	uA
krad	0	30
LL	8.000	8.000
Min	19.753	18.754
Average	19.753	19.558
Max	19.753	20.451
UL	30.000	30.000

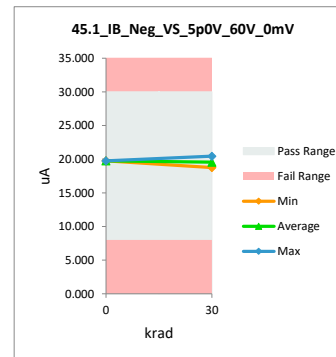

### LDR TID Report INA950A1MPWTSEP

45.2\_IB\_Pos\_VS\_5p0V\_80V\_0m

Test Site	Junkins	Junkins
Tester	FETS36401	FETS36401
Test Number	EQ0581	EQ0581
Unit	uA	uA
Max Limit	30	30
Min Limit	8	8

krad	Serial #	NA950 LDR Pre-Te	IA950 LDR Post-Te	Delta	Delta %	% of Limit Range
30	1	19.470	19.611	0.141	0.72%	0.64%
30	2	20.016	20.163	0.147	0.73%	0.67%
30	3	20.182	20.163	-0.019	-0.09%	0.09%
30	4	19.075	18.894	-0.181	-0.95%	0.82%
30	5	18.680	18.519	-0.161	-0.86%	0.73%
30	6	18.597	18.836	0.239	1.29%	1.09%
30	7	19.543	19.450	-0.093	-0.48%	0.42%
30	8	19.367	19.421	0.054	0.28%	0.25%
30	9	19.465	19.265	-0.200	-1.03%	0.91%
30	10	19.119	19.187	0.068	0.36%	0.31%
0	11	19.197	19.445	0.248	1.29%	1.13%
Max		20.182	20.163	0.248	1.29%	1.13%
Average		19.337	19.359	0.022	0.11%	0.64%
Min		18.597	18.519	-0.200	-1.03%	0.09%
Std Dev		0.487	0.511	0.164	0.86%	0.34%

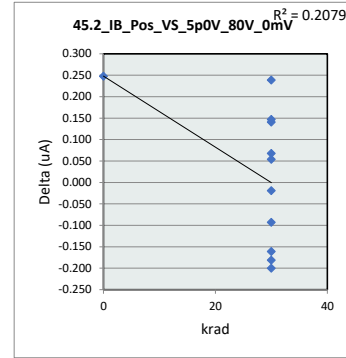

45.2\_IB\_Pos\_VS\_5p0V\_80V\_0

Test Site	Junkins
Tester	FETS36401
Test Number	EQ0581
Max Limit	30 uA
Min Limit	8 uA
krad	0 30
LL	8.000 8.000
Min	19.445 18.519
Average	19.445 19.351
Max	19.445 20.163
UL	30.000 30.000

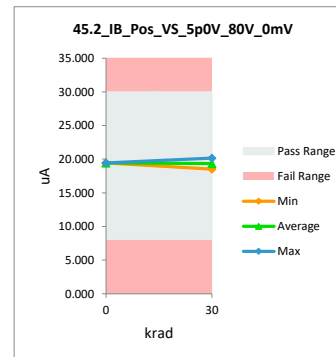

### LDR TID Report INA950A1MPWTSEP

45.3\_IB\_Neg\_VS\_5p0V\_80V\_0m

Test Site	Junkins	Junkins
Tester	FETS36401	FETS36401
Test Number	EQ0581	EQ0581
Unit	uA	uA
Max Limit	30	30
Min Limit	8	8

krad	Serial #	NA950 LDR Pre-Te	IA950 LDR Post-Te	Delta	Delta %	% of Limit Range
30	1	19.232	19.461	0.229	1.19%	1.04%
30	2	19.836	20.153	0.317	1.60%	1.44%
30	3	20.178	20.022	-0.156	-0.77%	0.71%
30	4	18.920	18.793	-0.127	-0.67%	0.58%
30	5	18.471	18.549	0.078	0.42%	0.35%
30	6	18.505	18.783	0.278	1.50%	1.26%
30	7	19.178	19.256	0.078	0.41%	0.35%
30	8	19.222	19.280	0.058	0.30%	0.26%
30	9	19.154	19.202	0.048	0.25%	0.22%
30	10	18.905	19.134	0.229	1.21%	1.04%
0	11	19.007	19.305	0.298	1.57%	1.35%
Max		20.178	20.153	0.317	1.60%	1.44%
Average		19.146	19.267	0.121	0.64%	0.78%
Min		18.471	18.549	-0.156	-0.77%	0.22%
Std Dev		0.505	0.489	0.164	0.85%	0.46%

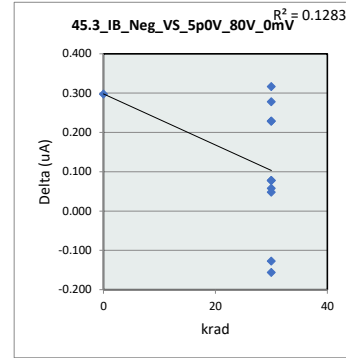

45.3\_IB\_Neg\_VS\_5p0V\_80V\_0

Test Site	Junkins
Tester	FETS36401
Test Number	EQ0581
Max Limit	30 uA
Min Limit	8 uA
krad	0 30
LL	8.000 8.000
Min	19.305 18.549
Average	19.305 19.263
Max	19.305 20.153
UL	30.000 30.000

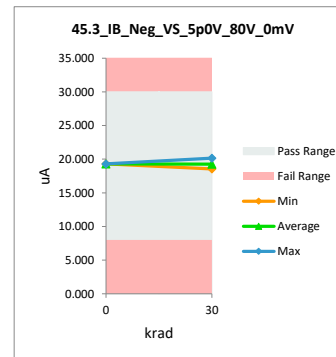

LDR TID Report  
INA950A1MPWTSEP

51.0_Vin_5V_48V_2p5mV		
Test Site	Junkins	Junkins
Tester	FETS36401	FETS36401
Test Number	EQ0581	EQ0581
Unit	mV	mV
Max Limit	3	3
Min Limit	2	2

krad	Serial #	NA950 LDR Pre-Te	IA950 LDR Post-Te	Delta	Delta %	% of Limit Range
30	1	2.488	2.495	0.007	0.29%	0.71%
30	2	2.488	2.495	0.007	0.28%	0.70%
30	3	2.489	2.495	0.007	0.27%	0.66%
30	4	2.488	2.495	0.007	0.28%	0.70%
30	5	2.488	2.495	0.007	0.29%	0.72%
30	6	2.488	2.495	0.007	0.29%	0.71%
30	7	2.488	2.495	0.007	0.29%	0.73%
30	8	2.488	2.495	0.007	0.29%	0.71%
30	9	2.488	2.495	0.007	0.29%	0.71%
30	10	2.488	2.495	0.007	0.29%	0.72%
0	11	2.488	2.495	0.007	0.29%	0.72%
	Max	2.489	2.495	0.007	0.29%	0.73%
	Average	2.488	2.495	0.007	0.28%	0.71%
	Min	2.488	2.495	0.007	0.27%	0.66%
	Std Dev	0.000	0.000	0.000	0.01%	0.02%

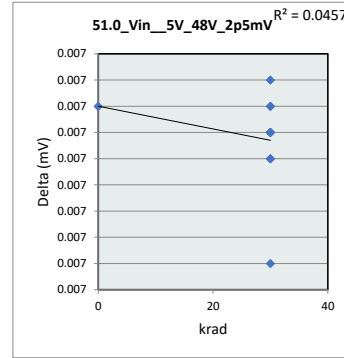

51.0_Vin_5V_48V_2p5mV		
Test Site	Junkins	
Tester	FETS36401	
Test Number	EQ0581	
Max Limit	3	mV
Min Limit	2	mV
krad	0	30
LL	2.000	2.000
Min	2.495	2.495
Average	2.495	2.495
Max	2.495	2.495
UL	3.000	3.000

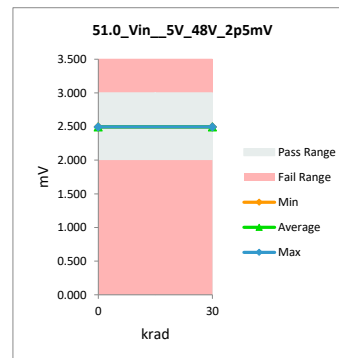

# LDR TID Report INA950A1MPWTSEP

## 51.1\_Vin\_5V\_48V\_225mV

Test Site	Junkins	Junkins
Tester	FETS36401	FETS36401
Test Number	EQ0581	EQ0581
Unit	mV	mV
Max Limit	235	235
Min Limit	215	215

krad	Serial #	NA950 LDR Pre-Te	IA950 LDR Post-Te	Delta	Delta %	% of Limit Range
30	1	224.929	224.937	0.008	0.00%	0.04%
30	2	224.929	224.936	0.007	0.00%	0.04%
30	3	224.926	224.936	0.009	0.00%	0.05%
30	4	224.932	224.936	0.004	0.00%	0.02%
30	5	224.931	224.939	0.007	0.00%	0.04%
30	6	224.928	224.933	0.005	0.00%	0.02%
30	7	224.929	224.934	0.005	0.00%	0.02%
30	8	224.931	224.938	0.007	0.00%	0.03%
30	9	224.930	224.936	0.007	0.00%	0.03%
30	10	224.930	224.934	0.005	0.00%	0.02%
0	11	224.929	224.934	0.005	0.00%	0.03%
Max		224.932	224.939	0.009	0.00%	0.05%
Average		224.929	224.936	0.006	0.00%	0.03%
Min		224.926	224.933	0.004	0.00%	0.02%
Std Dev		0.001	0.002	0.002	0.00%	0.01%

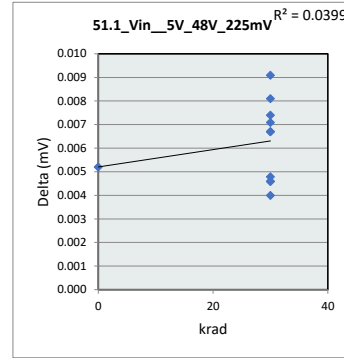

51.1_Vin_5V_48V_225mV		
Test Site	Junkins	
Tester	FETS36401	
Test Number	EQ0581	
Max Limit	235	mV
Min Limit	215	mV
krad	0	30
LL	215.000	215.000
Min	224.934	224.933
Average	224.934	224.936
Max	224.934	224.939
UL	235.000	235.000

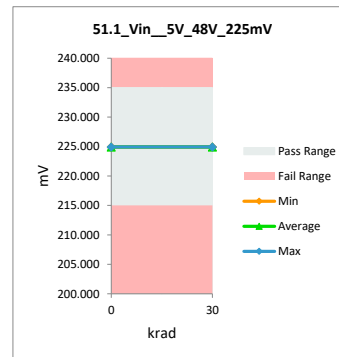

LDR TID Report  
INA950A1MPWTSEP

51.2_Vout_5V_48V_50mV		
Test Site	Junkins	Junkins
Tester	FETS36401	FETS36401
Test Number	EQ0581	EQ0581
Unit	mV	mV
Max Limit	60	60
Min Limit	40	40

krad	Serial #	NA950 LDR Pre-Te	IA950 LDR Post-Te	Delta	Delta %	% of Limit Range
30	1	49.975	50.245	0.269	0.54%	1.35%
30	2	49.968	50.100	0.132	0.26%	0.66%
30	3	49.957	50.167	0.210	0.42%	1.05%
30	4	49.935	50.293	0.358	0.72%	1.79%
30	5	49.893	50.183	0.290	0.58%	1.45%
30	6	49.890	50.135	0.245	0.49%	1.22%
30	7	49.659	50.087	0.428	0.86%	2.14%
30	8	49.928	50.164	0.236	0.47%	1.18%
30	9	49.995	50.222	0.227	0.45%	1.13%
30	10	50.032	50.159	0.127	0.25%	0.64%
0	11	49.858	50.192	0.335	0.67%	1.67%
Max		50.032	50.293	0.428	0.86%	2.14%
Average		49.917	50.177	0.260	0.52%	1.30%
Min		49.659	50.087	0.127	0.25%	0.64%
Std Dev		0.099	0.061	0.091	0.18%	0.45%

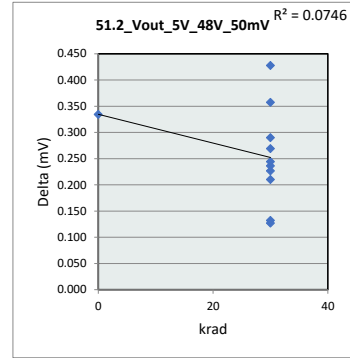

51.2_Vout_5V_48V_50mV		
Test Site	Junkins	
Tester	FETS36401	
Test Number	EQ0581	
Max Limit	60	mV
Min Limit	40	mV
krad	0	30
LL	40.000	40.000
Min	50.192	50.087
Average	50.192	50.176
Max	50.192	50.293
UL	60.000	60.000

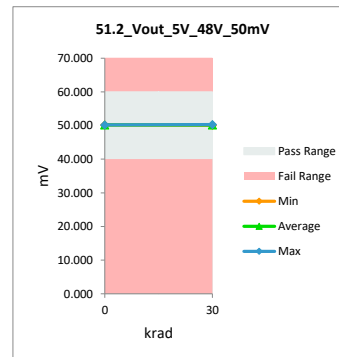

LDR TID Report  
INA950A1MPWTSEP

51.3_Vout_5V_48V_4p5V		
Test Site	Junkins	Junkins
Tester	FETS36401	FETS36401
Test Number	EQ0581	EQ0581
Unit	V	V
Max Limit	5	5
Min Limit	4	4

krad	Serial #	NA950 LDR Pre-Te	IA950 LDR Post-Te	Delta	Delta %	% of Limit Range
30	1	4.498	4.498	0.000	0.01%	0.03%
30	2	4.498	4.498	0.000	0.00%	0.02%
30	3	4.498	4.498	0.000	0.00%	0.02%
30	4	4.498	4.498	0.001	0.01%	0.06%
30	5	4.498	4.498	0.000	0.01%	0.03%
30	6	4.498	4.498	0.000	0.00%	0.01%
30	7	4.497	4.498	0.001	0.02%	0.07%
30	8	4.498	4.498	0.000	0.00%	0.01%
30	9	4.498	4.498	0.000	0.00%	0.02%
30	10	4.498	4.498	0.000	0.00%	0.00%
0	11	4.498	4.498	0.000	0.01%	0.04%
Max		4.498	4.498	0.001	0.02%	0.07%
Average		4.498	4.498	0.000	0.01%	0.03%
Min		4.497	4.498	0.000	0.00%	0.00%
Std Dev		0.000	0.000	0.000	0.00%	0.02%

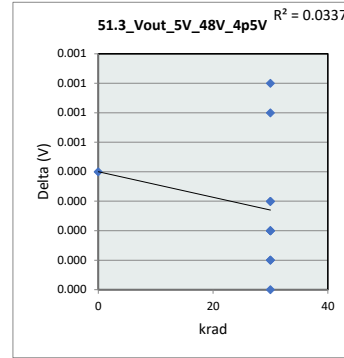

51.3_Vout_5V_48V_4p5V		
Test Site	Junkins	
Tester	FETS36401	
Test Number	EQ0581	
Max Limit	5	V
Min Limit	4	V
krad	0	30
LL	4.000	4.000
Min	4.498	4.498
Average	4.498	4.498
Max	4.498	4.498
UL	5.000	5.000

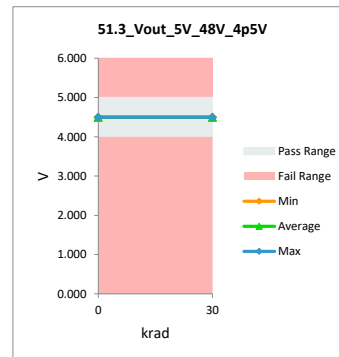

LDR TID Report  
INA950A1MPWTSEP

51.4_Gain_5V_48V		
Test Site	Junkins	Junkins
Tester	FETS36401	FETS36401
Test Number	EQ0581	EQ0581
Unit	V/V	V/V
Max Limit	22	22
Min Limit	18	18

krad	Serial #	NA950 LDR Pre-Te	IA950 LDR Post-Te	Delta	Delta %	% of Limit Range
30	1	19.996	19.997	0.000	0.00%	0.01%
30	2	19.996	19.996	0.000	0.00%	0.01%
30	3	19.997	19.997	0.000	0.00%	0.01%
30	4	19.995	19.996	0.001	0.01%	0.03%
30	5	19.996	19.996	0.000	0.00%	0.01%
30	6	19.996	19.996	0.000	0.00%	0.01%
30	7	19.993	19.994	0.001	0.01%	0.03%
30	8	19.994	19.994	0.000	0.00%	0.01%
30	9	19.996	19.996	0.000	0.00%	0.01%
30	10	19.996	19.996	0.000	0.00%	0.00%
0	11	19.995	19.996	0.000	0.00%	0.01%
	Max	19.997	19.997	0.001	0.01%	0.03%
	Average	19.995	19.996	0.000	0.00%	0.01%
	Min	19.993	19.994	0.000	0.00%	0.00%
	Std Dev	0.001	0.001	0.001	0.00%	0.01%

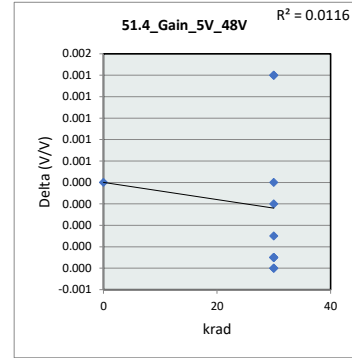

51.4_Gain_5V_48V		
Test Site	Junkins	
Tester	FETS36401	
Test Number	EQ0581	
Max Limit	22	V/V
Min Limit	18	V/V
krad	0	30
LL	18.000	18.000
Min	19.996	19.994
Average	19.996	19.996
Max	19.996	19.997
UL	22.000	22.000

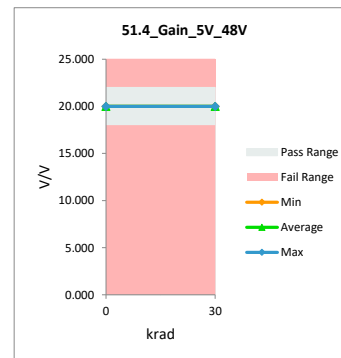



## LDR TID Report INA950A1MPWTSEP

51.5_Gain_Error_5V_48V						
Test Site	Junkins	Junkins				
Tester	FETS36401	FETS36401				
Test Number	EQ0581	EQ0581				
Unit	m%	m%				
Max Limit	150	150				
Min Limit	-150	-150				
krad	Serial #	NA950 LDR Pre-Te	IA950 LDR Post-Te	Delta	Delta %	% of Limit Range
30	1	-18.621	-17.503	1.118	-6.01%	0.37%
30	2	-22.214	-20.099	2.114	-9.52%	0.70%
30	3	-13.261	-15.677	-2.417	18.22%	0.81%
30	4	-27.045	-20.084	6.961	-25.74%	2.32%
30	5	-20.401	-22.316	-1.914	9.38%	0.64%
30	6	-20.725	-21.876	-1.151	5.55%	0.38%
30	7	-35.104	-28.056	7.048	-20.08%	2.35%
30	8	-27.658	-28.938	-1.280	4.63%	0.43%
30	9	-20.335	-21.894	-1.560	7.67%	0.52%
30	10	-20.270	-21.237	-0.966	4.77%	0.32%
0	11	-23.869	-22.192	1.677	-7.03%	0.56%
Max		-13.261	-15.677	7.048	18.22%	2.35%
Average		-22.682	-21.807	0.875	-1.65%	0.85%
Min		-35.104	-28.938	-2.417	-25.74%	0.32%
Std Dev		5.704	3.907	3.377	13.29%	0.75%

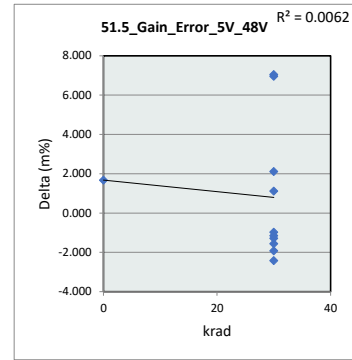

51.5_Gain_Error_5V_48V		
Test Site	Junkins	
Tester	FETS36401	
Test Number	EQ0581	
Max Limit	150	m%
Min Limit	-150	m%
krad	0	30
LL	-150.000	-150.000
Min	-22.192	-28.938
Average	-22.192	-21.768
Max	-22.192	-15.677
UL	150.000	150.000

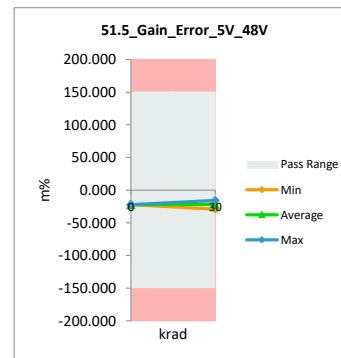

LDR TID Report  
INA950A1MPWTSEP

61.0_Offset_5V_48V		
Test Site	Junkins	Junkins
Tester	FETS36401	FETS36401
Test Number	EQ0581	EQ0581
Unit	uV	uV
Max Limit	25	25
Min Limit	-25	-25

krad	Serial #	NA950 LDR Pre-Te	IA950 LDR Post-Te	Delta	Delta %	% of Limit Range
30	1	11.118	17.437	6.319	56.84%	12.64%
30	2	10.783	10.280	-0.503	-4.66%	1.01%
30	3	9.711	13.612	3.902	40.18%	7.80%
30	4	9.355	19.998	10.643	113.77%	21.29%
30	5	7.045	14.368	7.322	103.94%	14.64%
30	6	6.931	12.050	5.120	73.87%	10.24%
30	7	-4.168	9.767	13.934	-334.34%	27.87%
30	8	8.991	13.742	4.750	52.83%	9.50%
30	9	12.352	16.633	4.281	34.66%	8.56%
30	10	14.257	13.359	-0.899	-6.30%	1.80%
0	11	5.470	15.007	9.538	174.37%	19.08%
	Max	14.257	19.998	13.934	174.37%	27.87%
	Average	8.350	14.205	5.855	27.74%	12.22%
	Min	-4.168	9.767	-0.899	-334.34%	1.01%
	Std Dev	4.863	3.026	4.452	131.08%	8.12%

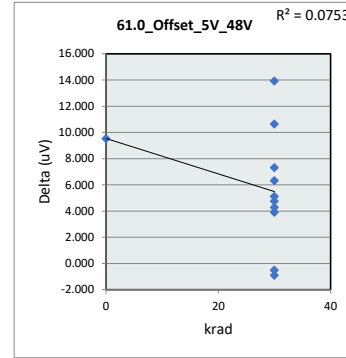

61.0_Offset_5V_48V		
Test Site	Junkins	
Tester	FETS36401	
Test Number	EQ0581	
Max Limit	25	uV
Min Limit	-25	uV
krad	0	30
LL	-25.000	-25.000
Min	15.008	9.767
Average	15.008	14.125
Max	15.008	19.998
UL	25.000	25.000

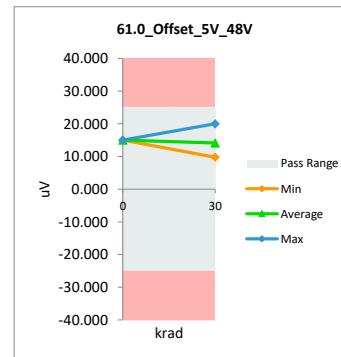

LDR TID Report  
INA950A1MPWTSEP

	71.0_Vin__2p7V_48V_25mV	
Test Site	Junkins	Junkins
Tester	FETS36401	FETS36401
Test Number	EQ0581	EQ0581
Unit	mV	mV
Max Limit	30	30
Min Limit	20	20

krad	Serial #	NA950 LDR Pre-Te	IA950 LDR Post-Te	Delta	Delta %	% of Limit Range
30	1	25.022	25.028	0.006	0.02%	0.06%
30	2	25.021	25.027	0.006	0.02%	0.06%
30	3	25.022	25.027	0.006	0.02%	0.06%
30	4	25.020	25.028	0.008	0.03%	0.08%
30	5	25.021	25.027	0.006	0.02%	0.06%
30	6	25.022	25.027	0.006	0.02%	0.06%
30	7	25.020	25.027	0.007	0.03%	0.07%
30	8	25.021	25.028	0.007	0.03%	0.07%
30	9	25.020	25.027	0.007	0.03%	0.07%
30	10	25.021	25.027	0.006	0.03%	0.06%
0	11	25.021	25.027	0.006	0.02%	0.06%
Max		25.022	25.028	0.008	0.03%	0.08%
Average		25.021	25.027	0.006	0.03%	0.06%
Min		25.020	25.027	0.006	0.02%	0.06%
Std Dev		0.001	0.000	0.001	0.00%	0.01%

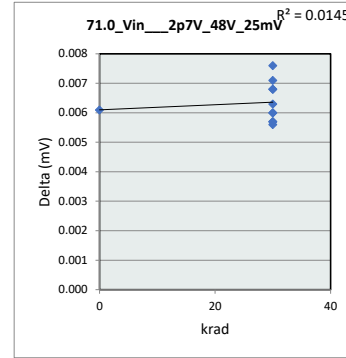

	71.0_Vin__2p7V_48V_25mV	
Test Site	Junkins	
Tester	FETS36401	
Test Number	EQ0581	
Max Limit	30	mV
Min Limit	20	mV
krad	0	30
LL	20.000	20.000
Min	25.027	25.027
Average	25.027	25.027
Max	25.027	25.028
UL	30.000	30.000

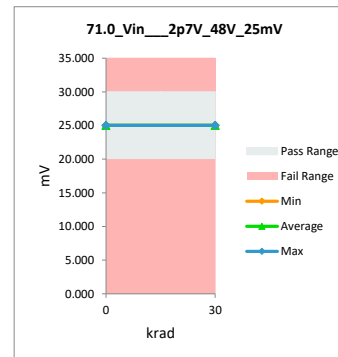

### LDR TID Report INA950A1MPWTSEP

71.1_Vin_20p0V_48V_25mV		
Test Site	Junkins	Junkins
Tester	FETS36401	FETS36401
Test Number	EQ0581	EQ0581
Unit	mV	mV
Max Limit	30	30
Min Limit	20	20

krad	Serial #	NA950 LDR Pre-Te	IA950 LDR Post-Te	Delta	Delta %	% of Limit Range
30	1	25.022	25.028	0.006	0.02%	0.06%
30	2	25.022	25.027	0.005	0.02%	0.05%
30	3	25.022	25.027	0.005	0.02%	0.05%
30	4	25.022	25.027	0.005	0.02%	0.05%
30	5	25.022	25.028	0.006	0.02%	0.06%
30	6	25.021	25.028	0.007	0.03%	0.07%
30	7	25.021	25.027	0.006	0.02%	0.06%
30	8	25.021	25.028	0.007	0.03%	0.07%
30	9	25.021	25.028	0.007	0.03%	0.07%
30	10	25.021	25.027	0.007	0.03%	0.07%
0	11	25.021	25.028	0.006	0.03%	0.06%
Max		25.022	25.028	0.007	0.03%	0.07%
Average		25.021	25.028	0.006	0.02%	0.06%
Min		25.021	25.027	0.005	0.02%	0.05%
Std Dev		0.000	0.000	0.001	0.00%	0.01%

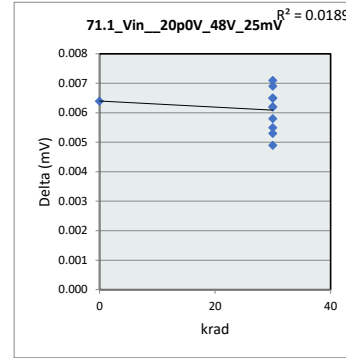

71.1_Vin_20p0V_48V_25mV		
Test Site	Junkins	
Tester	FETS36401	
Test Number	EQ0581	
Max Limit	30	mV
Min Limit	20	mV
krad	0	30
LL	20.000	20.000
Min	25.028	25.027
Average	25.028	25.028
Max	25.028	25.028
UL	30.000	30.000

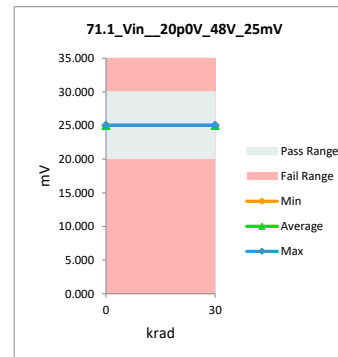

LDR TID Report  
INA950A1MPWTSEP

71.2_Vout_2p7V_48V_25mV		
Test Site	Junkins	Junkins
Tester	FETS36401	FETS36401
Test Number	EQ0581	EQ0581
Unit	mV	mV
Max Limit	600	600
Min Limit	400	400

krad	Serial #	NA950 LDR Pre-Te	IA950 LDR Post-Te	Delta	Delta %	% of Limit Range
30	1	499.848	500.000	0.153	0.03%	0.08%
30	2	499.883	499.945	0.063	0.01%	0.03%
30	3	499.866	499.979	0.113	0.02%	0.06%
30	4	499.785	500.054	0.269	0.05%	0.13%
30	5	499.792	499.954	0.162	0.03%	0.08%
30	6	499.780	499.906	0.127	0.03%	0.06%
30	7	499.532	499.874	0.342	0.07%	0.17%
30	8	499.785	499.905	0.120	0.02%	0.06%
30	9	499.857	499.982	0.125	0.02%	0.06%
30	10	499.934	499.941	0.007	0.00%	0.00%
0	11	499.735	499.959	0.223	0.04%	0.11%
Max		499.934	500.054	0.342	0.07%	0.17%
Average		499.800	499.955	0.155	0.03%	0.08%
Min		499.532	499.874	0.007	0.00%	0.00%
Std Dev		0.106	0.050	0.094	0.02%	0.05%

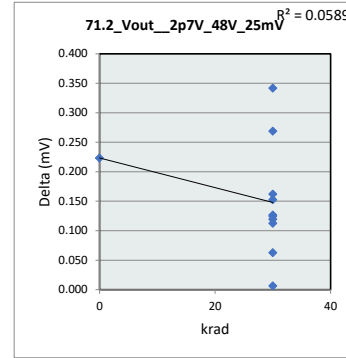

71.2_Vout_2p7V_48V_25mV		
Test Site	Junkins	
Tester	FETS36401	
Test Number	EQ0581	
Max Limit	600	mV
Min Limit	400	mV
krad	0	30
LL	400.000	400.000
Min	499.959	499.874
Average	499.959	499.954
Max	499.959	500.054
UL	600.000	600.000

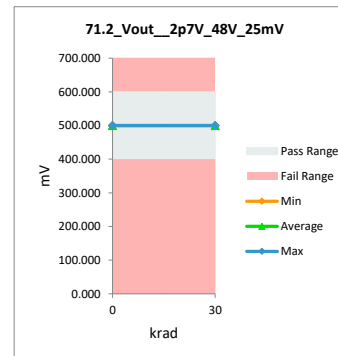

LDR TID Report  
INA950A1MPWTSEP

71.3_Vout_20p0V_48V_25mV		
Test Site	Junkins	Junkins
Tester	FETS36401	FETS36401
Test Number	EQ0581	EQ0581
Unit	mV	mV
Max Limit	600	600
Min Limit	400	400

krad	Serial #	NA950 LDR Pre-Te	IA950 LDR Post-Te	Delta	Delta %	% of Limit Range
30	1	499.864	500.030	0.165	0.03%	0.08%
30	2	499.846	499.895	0.048	0.01%	0.02%
30	3	499.885	499.962	0.077	0.02%	0.04%
30	4	499.794	500.061	0.267	0.05%	0.13%
30	5	499.782	499.936	0.154	0.03%	0.08%
30	6	499.762	499.898	0.136	0.03%	0.07%
30	7	499.477	499.816	0.340	0.07%	0.17%
30	8	499.782	499.920	0.138	0.03%	0.07%
30	9	499.892	499.982	0.090	0.02%	0.05%
30	10	499.931	499.930	-0.001	0.00%	0.00%
0	11	499.730	499.953	0.222	0.04%	0.11%
	Max	499.931	500.061	0.340	0.07%	0.17%
	Average	499.795	499.944	0.149	0.03%	0.07%
	Min	499.477	499.816	-0.001	0.00%	0.00%
	Std Dev	0.123	0.067	0.099	0.02%	0.05%

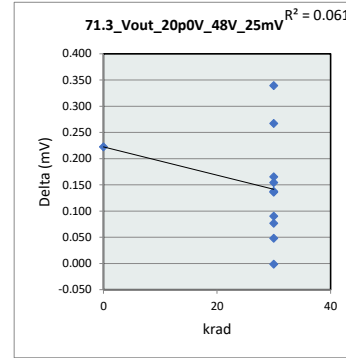

71.3_Vout_20p0V_48V_25mV		
Test Site	Junkins	
Tester	FETS36401	
Test Number	EQ0581	
Max Limit	600	mV
Min Limit	400	mV
krad	0	30
LL	400.000	400.000
Min	499.953	499.816
Average	499.953	499.943
Max	499.953	500.061
UL	600.000	600.000

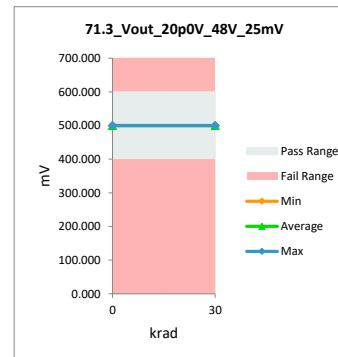

LDR TID Report  
INA950A1MPWTSEP

71.4_PSRR_V_V		
Test Site	Junkins	Junkins
Tester	FETS36401	FETS36401
Test Number	EQ0581	EQ0581
Unit	nV/V	nV/V
Max Limit	500	500
Min Limit	-500	-500

krad	Serial #	NA950 LDR Pre-Te	IA950 LDR Post-Te	Delta	Delta %	% of Limit Range
30	1	48.113	85.135	37.022	76.95%	3.70%
30	2	-104.491	-146.558	-42.067	40.26%	4.21%
30	3	53.005	-50.329	-103.334	-194.95%	10.33%
30	4	24.403	19.429	-4.974	-20.38%	0.50%
30	5	-28.303	-51.328	-23.025	81.35%	2.30%
30	6	-50.868	-23.713	27.154	-53.38%	2.72%
30	7	-160.583	-167.532	-6.949	4.33%	0.69%
30	8	-8.185	44.523	52.708	-643.93%	5.27%
30	9	101.124	1.530	-99.594	-98.49%	9.96%
30	10	-8.873	-30.903	-22.030	248.28%	2.20%
0	11	-15.299	-18.053	-2.753	18.00%	0.28%
Max		101.124	85.135	52.708	248.28%	10.33%
Average		-13.632	-30.709	-17.077	-49.27%	3.83%
Min		-160.583	-167.532	-103.334	-643.93%	0.28%
Std Dev		73.740	74.695	50.141	226.95%	3.49%

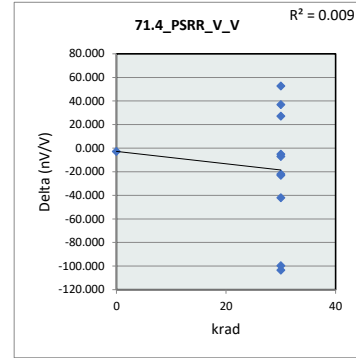

71.4_PSRR_V_V		
Test Site	Junkins	
Tester	FETS36401	
Test Number	EQ0581	
Max Limit	500	nV/V
Min Limit	-500	nV/V
krad	0	30
LL	-500.000	-500.000
Min	-18.053	-167.532
Average	-18.053	-31.975
Max	-18.053	85.135
UL	500.000	500.000

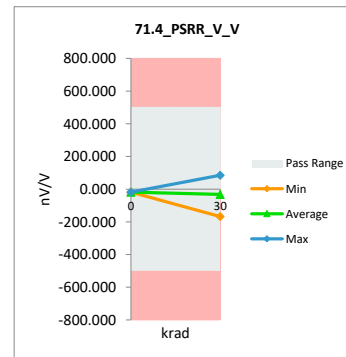

LDR TID Report  
INA950A1MPWTSEP

80.0_Vin_5V_2p7V_25mV		
Test Site	Junkins	Junkins
Tester	FETS36401	FETS36401
Test Number	EQ0581	EQ0581
Unit	mV	mV
Max Limit	30	30
Min Limit	-20	-20

krad	Serial #	NA950 LDR Pre-Te	IA950 LDR Post-Te	Delta	Delta %	% of Limit Range
30	1	25.021	25.028	0.007	0.03%	0.01%
30	2	25.021	25.028	0.007	0.03%	0.01%
30	3	25.022	25.027	0.005	0.02%	0.01%
30	4	25.021	25.028	0.007	0.03%	0.01%
30	5	25.021	25.027	0.006	0.02%	0.01%
30	6	25.021	25.027	0.006	0.03%	0.01%
30	7	25.021	25.028	0.007	0.03%	0.01%
30	8	25.021	25.026	0.006	0.02%	0.01%
30	9	25.021	25.028	0.007	0.03%	0.01%
30	10	25.021	25.027	0.006	0.02%	0.01%
0	11	25.021	25.027	0.006	0.02%	0.01%
Max		25.022	25.028	0.007	0.03%	0.01%
Average		25.021	25.027	0.006	0.03%	0.01%
Min		25.021	25.026	0.005	0.02%	0.01%
Std Dev		0.000	0.000	0.001	0.00%	0.00%

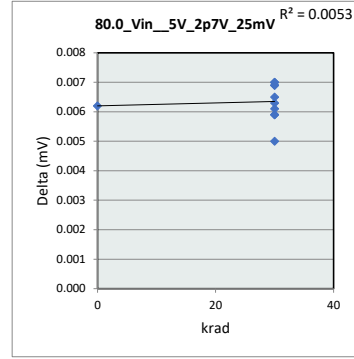

80.0_Vin_5V_2p7V_25mV		
Test Site	Junkins	
Tester	FETS36401	
Test Number	EQ0581	
Max Limit	30	mV
Min Limit	-20	mV
krad	0	30
LL	-20.000	-20.000
Min	25.027	25.026
Average	25.027	25.027
Max	25.027	25.028
UL	30.000	30.000

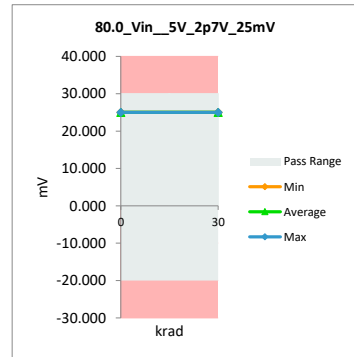



### LDR TID Report INA950A1MPWTSEP

80.1_Vin_5V_60V_25mV		
Test Site	Junkins	Junkins
Tester	FETS36401	FETS36401
Test Number	EQ0581	EQ0581
Unit	uV	uV
Max Limit	30	30
Min Limit	-20	-20

krad	Serial #	NA950 LDR Pre-Te	IA950 LDR Post-Te	Delta	Delta %	% of Limit Range
30	1	25.022	25.028	0.007	0.03%	0.01%
30	2	25.023	25.029	0.006	0.03%	0.01%
30	3	25.022	25.028	0.006	0.02%	0.01%
30	4	25.022	25.028	0.005	0.02%	0.01%
30	5	25.022	25.029	0.006	0.03%	0.01%
30	6	25.022	25.029	0.006	0.03%	0.01%
30	7	25.021	25.029	0.007	0.03%	0.01%
30	8	25.023	25.028	0.006	0.02%	0.01%
30	9	25.021	25.028	0.007	0.03%	0.01%
30	10	25.022	25.028	0.007	0.03%	0.01%
0	11	25.022	25.028	0.006	0.02%	0.01%
Max		25.023	25.029	0.007	0.03%	0.01%
Average		25.022	25.028	0.006	0.03%	0.01%
Min		25.021	25.028	0.005	0.02%	0.01%
Std Dev		0.000	0.000	0.001	0.00%	0.00%

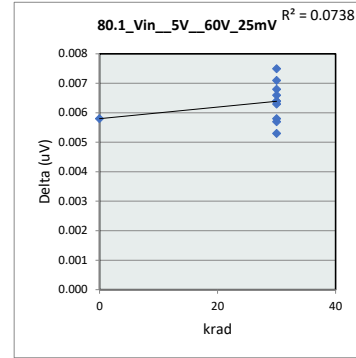

80.1_Vin_5V_60V_25mV		
Test Site	Junkins	
Tester	FETS36401	
Test Number	EQ0581	
Max Limit	30	uV
Min Limit	-20	uV
krad	0	30
LL	-20.000	-20.000
Min	25.028	25.028
Average	25.028	25.029
Max	25.028	25.029
UL	30.000	30.000

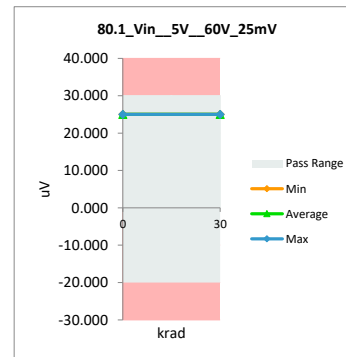

LDR TID Report  
INA950A1MPWTSEP

80.2_Vin_5V_80V_25mV		
Test Site	Junkins	Junkins
Tester	FETS36401	FETS36401
Test Number	EQ0581	EQ0581
Unit	uV	uV
Max Limit	30	30
Min Limit	-20	-20

krad	Serial #	NA950 LDR Pre-Te	IA950 LDR Post-Te	Delta	Delta %	% of Limit Range
30	1	25.022	25.029	0.006	0.03%	0.01%
30	2	25.023	25.029	0.006	0.02%	0.01%
30	3	25.023	25.029	0.006	0.02%	0.01%
30	4	25.023	25.028	0.005	0.02%	0.01%
30	5	25.022	25.029	0.007	0.03%	0.01%
30	6	25.022	25.028	0.006	0.02%	0.01%
30	7	25.021	25.028	0.007	0.03%	0.01%
30	8	25.022	25.029	0.007	0.03%	0.01%
30	9	25.022	25.028	0.006	0.02%	0.01%
30	10	25.022	25.028	0.006	0.02%	0.01%
0	11	25.022	25.028	0.006	0.02%	0.01%
Max		25.023	25.029	0.007	0.03%	0.01%
Average		25.022	25.029	0.006	0.02%	0.01%
Min		25.021	25.028	0.005	0.02%	0.01%
Std Dev		0.001	0.000	0.001	0.00%	0.00%

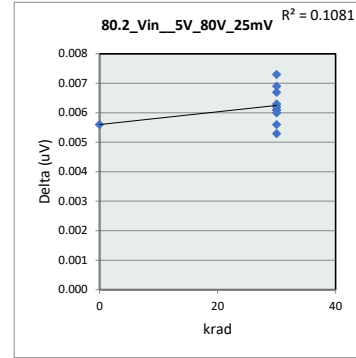

80.2_Vin_5V_80V_25mV		
Test Site	Junkins	
Tester	FETS36401	
Test Number	EQ0581	
Max Limit	30	uV
Min Limit	-20	uV
krad	0	30
LL	-20.000	-20.000
Min	25.028	25.028
Average	25.028	25.029
Max	25.028	25.029
UL	30.000	30.000

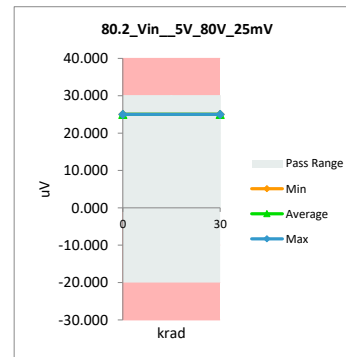

LDR TID Report  
INA950A1MPWTSEP

80.7_Vout_5V_2p7V_25mV		
Test Site	Junkins	Junkins
Tester	FETS36401	FETS36401
Test Number	EQ0581	EQ0581
Unit	mV	mV
Max Limit	600	600
Min Limit	400	400

krad	Serial #	NA950 LDR Pre-Te	IA950 LDR Post-Te	Delta	Delta %	% of Limit Range
30	1	499.812	499.973	0.160	0.03%	0.08%
30	2	499.802	499.852	0.049	0.01%	0.02%
30	3	499.823	499.930	0.107	0.02%	0.05%
30	4	499.746	500.012	0.266	0.05%	0.13%
30	5	499.731	499.916	0.185	0.04%	0.09%
30	6	499.726	499.859	0.132	0.03%	0.07%
30	7	499.386	499.784	0.398	0.08%	0.20%
30	8	499.730	499.862	0.132	0.03%	0.07%
30	9	499.846	499.953	0.107	0.02%	0.05%
30	10	499.884	499.891	0.007	0.00%	0.00%
0	11	499.687	499.904	0.217	0.04%	0.11%
	Max	499.884	500.012	0.398	0.08%	0.20%
	Average	499.743	499.903	0.160	0.03%	0.08%
	Min	499.386	499.784	0.007	0.00%	0.00%
	Std Dev	0.133	0.064	0.107	0.02%	0.05%

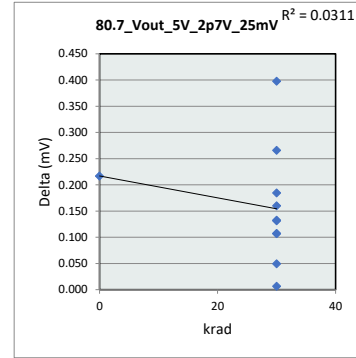

80.7_Vout_5V_2p7V_25mV		
Test Site	Junkins	
Tester	FETS36401	
Test Number	EQ0581	
Max Limit	600	mV
Min Limit	400	mV
krad	0	30
LL	400.000	400.000
Min	499.904	499.784
Average	499.904	499.903
Max	499.904	500.012
UL	600.000	600.000

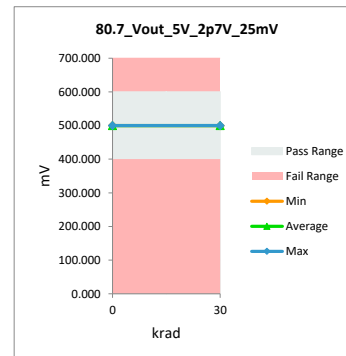

## LDR TID Report INA950A1MPWTSEP

80.8_Vout_5V_60V_25mV		
Test Site	Junkins	Junkins
Tester	FETS36401	FETS36401
Test Number	EQ0581	EQ0581
Unit	mV	mV
Max Limit	600	600
Min Limit	400	400

krad	Serial #	NA950 LDR Pre-Te	IA950 LDR Post-Te	Delta	Delta %	% of Limit Range
30	1	499.842	500.009	0.168	0.03%	0.08%
30	2	499.826	499.872	0.046	0.01%	0.02%
30	3	499.819	499.940	0.121	0.02%	0.06%
30	4	499.772	500.022	0.251	0.05%	0.13%
30	5	499.776	499.926	0.150	0.03%	0.08%
30	6	499.745	499.887	0.142	0.03%	0.07%
30	7	499.419	499.810	0.391	0.08%	0.20%
30	8	499.757	499.873	0.116	0.02%	0.06%
30	9	499.870	499.958	0.088	0.02%	0.04%
30	10	499.897	499.905	0.008	0.00%	0.00%
0	11	499.699	499.942	0.243	0.05%	0.12%
	Max	499.897	500.022	0.391	0.08%	0.20%
	Average	499.766	499.922	0.156	0.03%	0.08%
	Min	499.419	499.810	0.008	0.00%	0.00%
	Std Dev	0.129	0.062	0.107	0.02%	0.05%

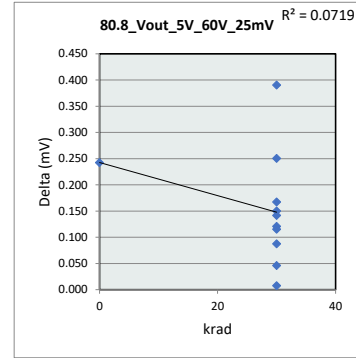

80.8_Vout_5V_60V_25mV		
Test Site	Junkins	
Tester	FETS36401	
Test Number	EQ0581	
Max Limit	600	mV
Min Limit	400	mV
krad	0	30
LL	400.000	400.000
Min	499.942	499.810
Average	499.942	499.920
Max	499.942	500.023
UL	600.000	600.000

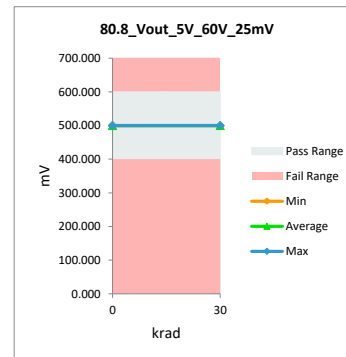

LDR TID Report  
INA950A1MPWTSEP

80.9_Vout_5V_80V_25mV		
Test Site	Junkins	Junkins
Tester	FETS36401	FETS36401
Test Number	EQ0581	EQ0581
Unit	mV	mV
Max Limit	600	600
Min Limit	400	400

krad	Serial #	NA950 LDR Pre-Te	IA950 LDR Post-Te	Delta	Delta %	% of Limit Range
30	1	499.848	499.999	0.151	0.03%	0.08%
30	2	499.816	499.865	0.048	0.01%	0.02%
30	3	499.825	499.943	0.118	0.02%	0.06%
30	4	499.797	500.039	0.242	0.05%	0.12%
30	5	499.767	499.915	0.148	0.03%	0.07%
30	6	499.742	499.879	0.137	0.03%	0.07%
30	7	499.431	499.805	0.374	0.07%	0.19%
30	8	499.745	499.892	0.147	0.03%	0.07%
30	9	499.877	499.961	0.084	0.02%	0.04%
30	10	499.886	499.895	0.008	0.00%	0.00%
0	11	499.719	499.940	0.221	0.04%	0.11%
	Max	499.886	500.039	0.374	0.07%	0.19%
	Average	499.768	499.921	0.153	0.03%	0.08%
	Min	499.431	499.805	0.008	0.00%	0.00%
	Std Dev	0.125	0.065	0.100	0.02%	0.05%

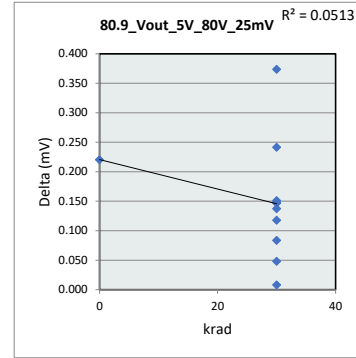

80.9_Vout_5V_80V_25mV		
Test Site	Junkins	
Tester	FETS36401	
Test Number	EQ0581	
Max Limit	600	mV
Min Limit	400	mV
krad	0	30
LL	400.000	400.000
Min	499.940	499.805
Average	499.940	499.919
Max	499.940	500.039
UL	600.000	600.000

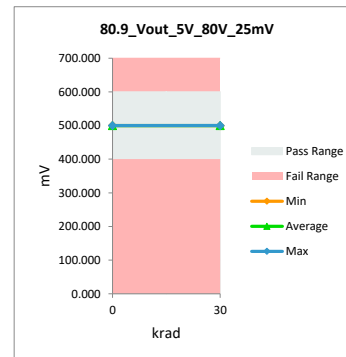

# LDR TID Report INA950A1MPWTSEP

## 80.14\_CMRR\_V\_V\_60V

Test Site	Junkins	Junkins
Tester	FETS36401	FETS36401
Test Number	EQ0581	EQ0581
Unit	nV/V	nV/V
Max Limit	1000	1000
Min Limit	-1000	-1000

krad	Serial #	NA950 LDR Pre-Te	IA950 LDR Post-Te	Delta	Delta %	% of Limit Range
30	1	25.866	32.217	6.351	24.55%	0.32%
30	2	20.786	17.899	-2.887	-13.89%	0.14%
30	3	-3.695	8.314	12.009	-325.01%	0.60%
30	4	22.520	9.123	-13.397	-59.49%	0.67%
30	5	38.569	8.661	-29.908	-77.54%	1.50%
30	6	16.167	24.250	8.084	50.00%	0.40%
30	7	28.758	22.404	-6.354	-22.09%	0.32%
30	8	23.906	9.816	-14.089	-58.94%	0.70%
30	9	21.017	4.042	-16.975	-80.77%	0.85%
30	10	11.548	12.472	0.924	8.00%	0.05%
0	11	10.855	33.258	22.403	206.38%	1.12%
Max		38.569	33.258	22.403	206.38%	1.50%
Average		19.663	16.587	-3.076	-31.71%	0.61%
Min		-3.695	4.042	-29.908	-325.01%	0.05%
Std Dev		10.996	10.118	15.026	126.71%	0.43%

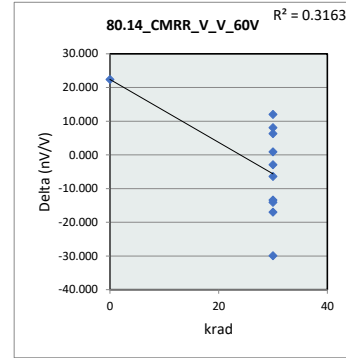

## 80.14\_CMRR\_V\_V\_60V

Test Site	Junkins
Tester	FETS36401
Test Number	EQ0581
Max Limit	1000 nV/V
Min Limit	-1000 nV/V
krad	0 30
LL	-1000.000 -1000.000
Min	33.258 4.042
Average	33.258 14.920
Max	33.258 32.217
UL	1000.000 1000.000

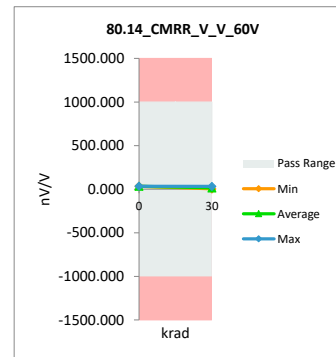

LDR TID Report  
INA950A1MPWTSEP

**80.15\_CMRR\_V\_V\_80V**

Test Site	Junkins	Junkins
Tester	FETS36401	FETS36401
Test Number	EQ0581	EQ0581
Unit	nV/V	nV/V
Max Limit	1000	1000
Min Limit	-1000	-1000

krad	Serial #	NA950 LDR Pre-Te	IA950 LDR Post-Te	Delta	Delta %	% of Limit Range
30	1	23.026	17.119	-5.906	-25.65%	0.30%
30	2	9.245	8.389	-0.856	-9.26%	0.04%
30	3	0.942	7.960	7.019	745.50%	0.35%
30	4	32.958	17.205	-15.753	-47.80%	0.79%
30	5	22.855	-0.770	-23.625	-103.37%	1.18%
30	6	9.844	13.097	3.253	33.04%	0.16%
30	7	29.536	13.868	-15.668	-53.05%	0.78%
30	8	9.845	19.775	9.931	100.87%	0.50%
30	9	20.030	4.794	-15.237	-76.07%	0.76%
30	10	1.370	2.397	1.027	75.00%	0.05%
0	11	20.887	23.198	2.311	11.06%	0.12%
	Max	32.958	23.198	9.931	745.50%	1.18%
	Average	16.412	11.548	-4.864	59.12%	0.46%
	Min	0.942	-0.770	-23.625	-103.37%	0.04%
	Std Dev	10.806	7.604	11.064	235.94%	0.38%

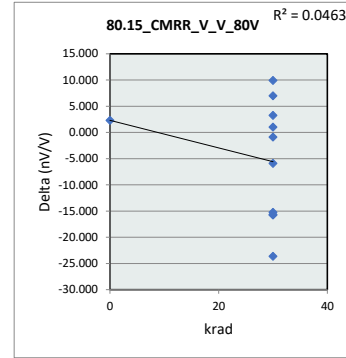

80.15_CMRR_V_V_80V		
Test Site	Junkins	
Tester	FETS36401	
Test Number	EQ0581	
Max Limit	1000	nV/V
Min Limit	-1000	nV/V
krad	0	30
LL	-1000.000	-1000.000
Min	23.198	-0.770
Average	23.198	10.383
Max	23.198	19.775
UL	1000.000	1000.000

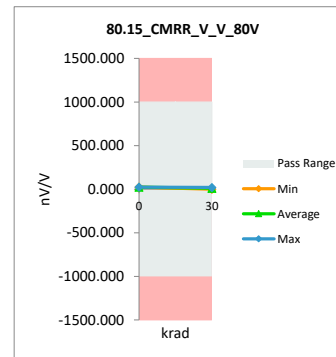

### LDR TID Report INA950A1MPWTSEP

80.20A_CMRR_dB_2p7V_80V		
Test Site	Junkins	Junkins
Tester	FETS36401	FETS36401
Test Number	EQ0581	EQ0581
Unit	dB	dB
Max Limit	500	500
Min Limit	140	140

krad	Serial #	NA950 LDR Pre-Te	IA950 LDR Post-Te	Delta	Delta %	% of Limit Range
30	1	152.756	155.330	2.575	1.69%	0.72%
30	2	160.682	161.526	0.844	0.53%	0.23%
30	3	180.524	161.981	-18.542	-10.27%	5.15%
30	4	149.641	155.287	5.646	3.77%	1.57%
30	5	152.820	182.266	29.445	19.27%	8.18%
30	6	160.137	157.657	-2.480	-1.55%	0.69%
30	7	150.593	157.160	6.567	4.36%	1.82%
30	8	160.136	154.078	-6.058	-3.78%	1.68%
30	9	153.966	166.387	12.421	8.07%	3.45%
30	10	177.268	172.407	-4.861	-2.74%	1.35%
0	11	153.602	152.691	-0.911	-0.59%	0.25%
Max		180.524	182.266	29.445	19.27%	8.18%
Average		159.284	161.524	2.240	1.70%	2.28%
Min		149.641	152.691	-18.542	-10.27%	0.23%
Std Dev		10.447	9.040	12.081	7.56%	2.44%

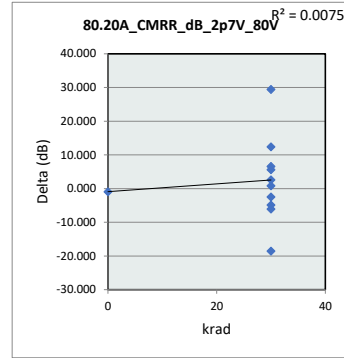

80.20A_CMRR_dB_2p7V_80V		
Test Site	Junkins	
Tester	FETS36401	
Test Number	EQ0581	
Max Limit	500	dB
Min Limit	140	dB
krad	0	30
LL	140.000	140.000
Min	152.691	154.078
Average	152.691	162.408
Max	152.691	182.266
UL	500.000	500.000

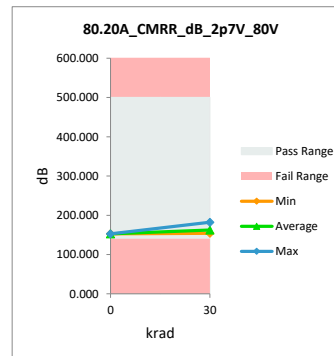



LDR TID Report  
INA950A1MPWTSEP

90.0_Swing_Low_5V_48V_n1		
Test Site	Junkins	Junkins
Tester	FETS36401	FETS36401
Test Number	EQ0581	EQ0581
Unit	mV	mV
Max Limit	15	15
Min Limit	0	0

krad	Serial #	NA950 LDR Pre-Te	IA950 LDR Post-Te	Delta	Delta %	% of Limit Range
30	1	5.006	5.180	0.174	3.48%	1.16%
30	2	5.212	5.366	0.154	2.95%	1.03%
30	3	5.053	5.207	0.154	3.05%	1.03%
30	4	4.959	5.092	0.133	2.68%	0.89%
30	5	4.664	4.894	0.230	4.93%	1.53%
30	6	4.038	4.022	-0.016	-0.40%	0.11%
30	7	4.984	4.966	-0.018	-0.36%	0.12%
30	8	4.617	4.603	-0.014	-0.30%	0.09%
30	9	4.714	4.770	0.056	1.19%	0.37%
30	10	4.718	4.675	-0.043	-0.91%	0.29%
0	11	4.960	4.934	-0.026	-0.52%	0.17%
Max		5.212	5.366	0.230	4.93%	1.53%
Average		4.811	4.883	0.071	1.43%	0.62%
Min		4.038	4.022	-0.043	-0.91%	0.09%
Std Dev		0.317	0.368	0.099	2.05%	0.52%

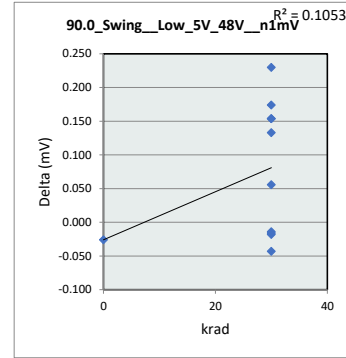

90.0_Swing_Low_5V_48V_n1		
Test Site	Junkins	
Tester	FETS36401	
Test Number	EQ0581	
Max Limit	15	mV
Min Limit	0	mV
krad	0	30
LL	0.000	0.000
Min	4.934	4.022
Average	4.934	4.878
Max	4.934	5.366
UL	15.000	15.000

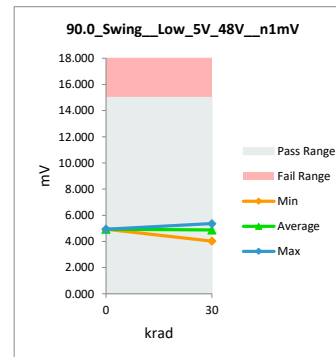

# LDR TID Report INA950A1MPWTSEP

## 100.0\_Swing\_Rest\_5V\_48V\_0

Test Site	Junkins	Junkins
Tester	FETS36401	FETS36401
Test Number	EQ0581	EQ0581
Unit	mV	mV
Max Limit	15	15
Min Limit	0	0

krad	Serial #	NA950 LDR Pre-Te	IA950 LDR Post-Te	Delta	Delta %	% of Limit Range
30	1	5.060	5.217	0.157	3.10%	1.05%
30	2	5.271	5.414	0.143	2.71%	0.95%
30	3	5.108	5.247	0.139	2.72%	0.93%
30	4	5.014	5.139	0.125	2.49%	0.83%
30	5	4.717	4.926	0.209	4.43%	1.39%
30	6	4.087	4.069	-0.018	-0.44%	0.12%
30	7	5.038	5.019	-0.019	-0.38%	0.13%
30	8	4.671	4.658	-0.013	-0.28%	0.09%
30	9	4.773	4.828	0.055	1.15%	0.37%
30	10	4.773	4.726	-0.047	-0.98%	0.31%
0	11	5.015	4.982	-0.033	-0.66%	0.22%
Max		5.271	5.414	0.209	4.43%	1.39%
Average		4.866	4.930	0.063	1.26%	0.58%
Min		4.087	4.069	-0.047	-0.98%	0.09%
Std Dev		0.319	0.366	0.093	1.89%	0.46%

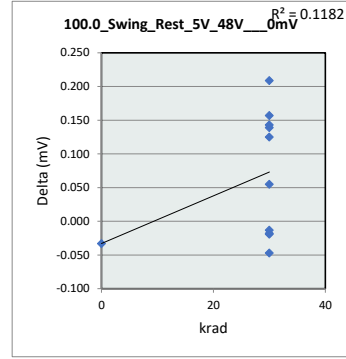

## 100.0\_Swing\_Rest\_5V\_48V

Test Site	Junkins
Tester	FETS36401
Test Number	EQ0581
Max Limit	15 mV
Min Limit	0 mV
krad	0 30
LL	0.000 0.000
Min	4.982 4.069
Average	4.982 4.924
Max	4.982 5.414
UL	15.000 15.000

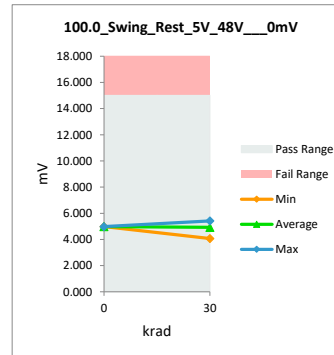

### LDR TID Report INA950A1MPWTSEP

#### 110.0\_Swing\_High\_5V\_48V\_250mV

Test Site	Junkins	Junkins
Tester	FETS36401	FETS36401
Test Number	EQ0581	EQ0581
Unit	mV	mV
Max Limit	200	200
Min Limit	35	35

krad	Serial #	NA950 LDR Pre-Te	IA950 LDR Post-Te	Delta	Delta %	% of Limit Range
30	1	62.035	65.096	3.061	4.93%	1.86%
30	2	62.150	65.246	3.096	4.98%	1.88%
30	3	61.802	64.667	2.865	4.64%	1.74%
30	4	61.832	65.141	3.309	5.35%	2.01%
30	5	62.203	65.385	3.182	5.12%	1.93%
30	6	62.542	64.602	2.060	3.29%	1.25%
30	7	62.256	64.134	1.878	3.02%	1.14%
30	8	62.435	64.240	1.805	2.89%	1.09%
30	9	61.966	64.137	2.171	3.50%	1.32%
30	10	62.202	64.251	2.049	3.29%	1.24%
0	11	61.798	61.372	-0.426	-0.69%	0.26%
	Max	62.542	65.385	3.309	5.35%	2.01%
	Average	62.111	64.388	2.277	3.67%	1.43%
	Min	61.798	61.372	-0.426	-0.69%	0.26%
	Std Dev	0.251	1.104	1.064	1.72%	0.52%

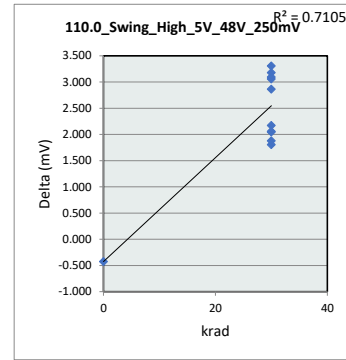

#### 110.0\_Swing\_High\_5V\_48V\_250mV

Test Site	Junkins
Tester	FETS36401
Test Number	EQ0581
Max Limit	200 mV
Min Limit	35 mV
krad	0      30
LL	35.000      35.000
Min	61.372      64.134
Average	61.372      64.690
Max	61.372      65.385
UL	200.000      200.000

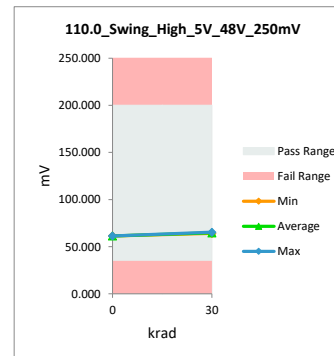

# LDR TID Report INA950A1MPWTSEP

## 120.0\_Swing\_High\_20V\_48V\_1V

Test Site	Junkins	Junkins
Tester	FETS36401	FETS36401
Test Number	EQ0581	EQ0581
Unit	mV	mV
Max Limit	500	500
Min Limit	150	150

krad	Serial #	NA950 LDR Pre-Te	IA950 LDR Post-Te	Delta	Delta %	% of Limit Range
30	1	242.146	254.002	11.856	4.90%	3.39%
30	2	242.537	254.408	11.871	4.89%	3.39%
30	3	242.064	253.362	11.298	4.67%	3.23%
30	4	242.016	254.357	12.341	5.10%	3.53%
30	5	242.958	254.970	12.012	4.94%	3.43%
30	6	243.685	252.278	8.593	3.53%	2.46%
30	7	242.765	250.464	7.699	3.17%	2.20%
30	8	243.788	251.392	7.604	3.12%	2.17%
30	9	242.794	251.086	8.292	3.42%	2.37%
30	10	243.596	251.965	8.369	3.44%	2.39%
0	11	242.479	240.919	-1.560	-0.64%	0.45%
Max		243.788	254.970	12.341	5.10%	3.53%
Average		242.803	251.746	8.943	3.68%	2.64%
Min		242.016	240.919	-1.560	-0.64%	0.45%
Std Dev		0.646	3.896	3.976	1.64%	0.91%

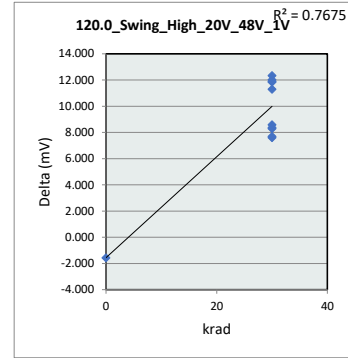

## 120.0\_Swing\_High\_20V\_48V

Test Site	Junkins
Tester	FETS36401
Test Number	EQ0581
Max Limit	500 mV
Min Limit	150 mV
krad	0      30
LL	150.000      150.000
Min	240.919      250.464
Average	240.919      252.828
Max	240.919      254.970
UL	500.000      500.000

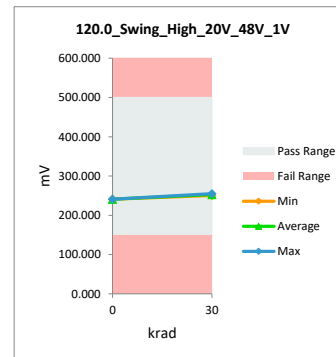

LDR TID Report  
INA950A1MPWTSEP

130.0\_Swing\_High\_2p7V\_48V\_1

Test Site	Junkins	Junkins
Tester	FETS36401	FETS36401
Test Number	EQ0581	EQ0581
Unit	mV	mV
Max Limit	100	100
Min Limit	15	15

krad	Serial #	NA950 LDR Pre-Te	IA950 LDR Post-Te	Delta	Delta %	% of Limit Range
30	1	35.129	37.233	2.104	5.99%	2.48%
30	2	35.116	37.193	2.077	5.91%	2.44%
30	3	35.110	37.071	1.961	5.59%	2.31%
30	4	35.400	37.628	2.228	6.29%	2.62%
30	5	35.548	37.668	2.120	5.96%	2.49%
30	6	36.225	37.383	1.158	3.20%	1.36%
30	7	35.241	36.321	1.080	3.06%	1.27%
30	8	35.700	36.719	1.019	2.85%	1.20%
30	9	35.541	36.608	1.067	3.00%	1.26%
30	10	35.601	36.716	1.115	3.13%	1.31%
0	11	35.248	34.937	-0.311	-0.88%	0.37%
Max		36.225	37.668	2.228	6.29%	2.62%
Average		35.442	36.862	1.420	4.01%	1.74%
Min		35.110	34.937	-0.311	-0.88%	0.37%
Std Dev		0.335	0.768	0.768	2.18%	0.75%

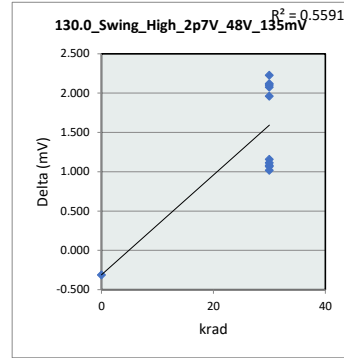

130.0\_Swing\_High\_2p7V\_48V

Test Site	Junkins
Tester	FETS36401
Test Number	EQ0581
Max Limit	100 mV
Min Limit	15 mV
krad	0 30
LL	15.000 15.000
Min	34.937 36.321
Average	34.937 37.054
Max	34.937 37.668
UL	100.000 100.000

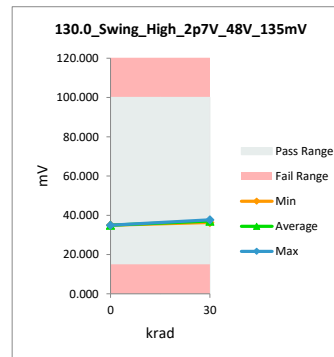

### LDR TID Report INA950A1MPWTSEP

135.0_Delta_IQ_Ref_5V		
Test Site	Junkins	Junkins
Tester	FETS36401	FETS36401
Test Number	EQ0581	EQ0581
Unit	uA	uA
Max Limit	600	600
Min Limit	200	200

krad	Serial #	NA950 LDR Pre-Te	IA950 LDR Post-Te	Delta	Delta %	% of Limit Range
30	1	411.166	412.368	1.202	0.29%	0.30%
30	2	409.344	410.199	0.855	0.21%	0.21%
30	3	402.896	401.328	-1.568	-0.39%	0.39%
30	4	401.367	406.149	4.782	1.19%	1.20%
30	5	393.976	395.779	1.803	0.46%	0.45%
30	6	381.667	381.007	-0.660	-0.17%	0.17%
30	7	407.175	405.827	-1.348	-0.33%	0.34%
30	8	397.904	397.235	-0.669	-0.17%	0.17%
30	9	388.535	393.356	4.821	1.24%	1.21%
30	10	388.032	389.111	1.079	0.28%	0.27%
0	11	398.256	398.212	-0.044	-0.01%	0.01%
Max		411.166	412.368	4.821	1.24%	1.21%
Average		398.211	399.143	0.932	0.24%	0.43%
Min		381.667	381.007	-1.568	-0.39%	0.01%
Std Dev		9.450	9.352	2.198	0.56%	0.40%

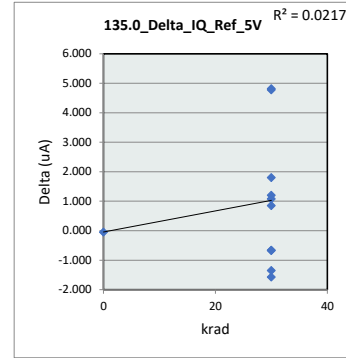

135.0_Delta_IQ_Ref_5V		
Test Site	Junkins	
Tester	FETS36401	
Test Number	EQ0581	
Max Limit	600	uA
Min Limit	200	uA
krad	0	30
LL	200.000	200.000
Min	398.212	381.007
Average	398.212	399.236
Max	398.212	412.368
UL	600.000	600.000

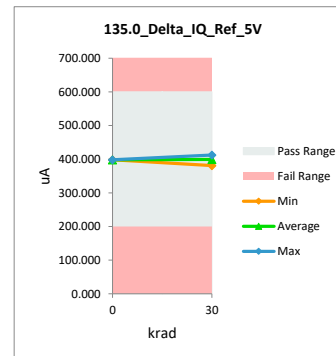

# LDR TID Report INA950A1MPWTSEP

## 135.1\_Delta\_IQ\_5V\_to\_2p7V

Test Site	Junkins	Junkins
Tester	FETS36401	FETS36401
Test Number	EQ0581	EQ0581
Unit	uA	uA
Max Limit	70	70
Min Limit	20	20

krad	Serial #	NA950 LDR Pre-Te	IA950 LDR Post-Te	Delta	Delta %	% of Limit Range
30	1	49.991	49.926	-0.065	-0.13%	0.13%
30	2	47.730	46.929	-0.801	-1.68%	1.60%
30	3	50.634	49.018	-1.616	-3.19%	3.23%
30	4	48.911	47.653	-1.258	-2.57%	2.52%
30	5	44.637	44.491	-0.146	-0.33%	0.29%
30	6	43.920	43.845	-0.075	-0.17%	0.15%
30	7	51.552	49.035	-2.517	-4.88%	5.03%
30	8	50.026	49.259	-0.767	-1.53%	1.53%
30	9	51.080	47.816	-3.264	-6.39%	6.53%
30	10	45.999	47.127	1.128	2.45%	2.26%
0	11	54.274	55.448	1.174	2.16%	2.35%
Max		54.274	55.448	1.174	2.45%	6.53%
Average		48.978	48.232	-0.746	-1.48%	2.33%
Min		43.920	43.845	-3.264	-6.39%	0.13%
Std Dev		3.144	3.065	1.377	2.71%	2.02%

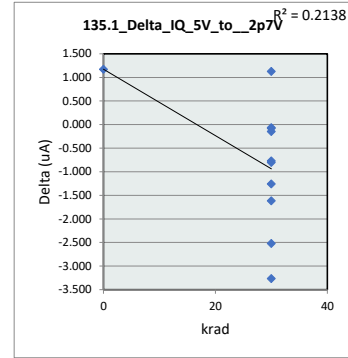

## 135.1\_Delta\_IQ\_5V\_to\_2p7V

Test Site	Junkins
Tester	FETS36401
Test Number	EQ0581
Max Limit	70 uA
Min Limit	20 uA
krad	0 30
LL	20.000 20.000
Min	55.448 43.845
Average	55.448 47.510
Max	55.448 49.926
UL	70.000 70.000

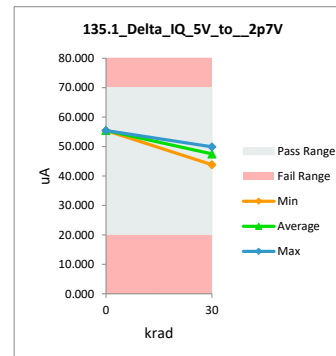

LDR TID Report  
INA950A1MPWTSEP

135.2\_Delta\_IQ\_5V\_to\_5p0V

Test Site	Junkins	Junkins
Tester	FETS36401	FETS36401
Test Number	EQ0581	EQ0581
Unit	uA	uA
Max Limit	10	10
Min Limit	-10	-10

krad	Serial #	NA950 LDR Pre-Te	IA950 LDR Post-Te	Delta	Delta %	% of Limit Range
30	1	1.185	0.535	-0.650	-54.85%	3.25%
30	2	-0.832	-0.026	0.806	-96.88%	4.03%
30	3	0.464	-0.032	-0.496	-106.90%	2.48%
30	4	0.933	1.623	0.690	73.95%	3.45%
30	5	1.238	0.994	-0.244	-19.71%	1.22%
30	6	2.128	1.858	-0.270	-12.69%	1.35%
30	7	0.749	2.470	1.721	229.77%	8.61%
30	8	2.243	2.060	-0.183	-8.16%	0.92%
30	9	1.495	0.325	-1.170	-78.26%	5.85%
30	10	2.599	1.049	-1.550	-59.64%	7.75%
0	11	-0.767	1.138	1.905	-248.37%	9.53%
	Max	2.599	2.470	1.905	229.77%	9.53%
	Average	1.040	1.090	0.051	-34.70%	4.40%
	Min	-0.832	-0.032	-1.550	-248.37%	0.92%
	Std Dev	1.119	0.844	1.109	118.67%	3.08%

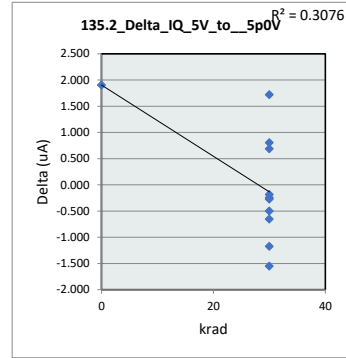

135.2\_Delta\_IQ\_5V\_to\_5p0V

Test Site	Junkins
Tester	FETS36401
Test Number	EQ0581
Max Limit	10 uA
Min Limit	-10 uA
krad	0 30
LL	-10.000 -10.000
Min	1.138 -0.032
Average	1.138 1.086
Max	1.138 2.470
UL	10.000 10.000

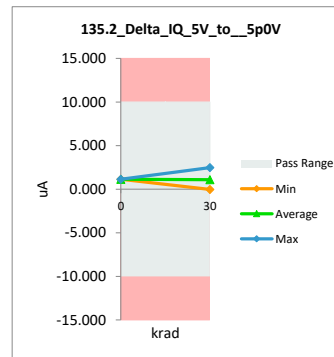



### LDR TID Report INA950A1MPWTSEP

#### 135.3\_Delta\_IQ\_5V\_to\_12p0V

Test Site	Junkins	Junkins
Tester	FETS36401	FETS36401
Test Number	EQ0581	EQ0581
Unit	uA	uA
Max Limit	10	10
Min Limit	-20	-20

krad	Serial #	NA950 LDR Pre-Te	IA950 LDR Post-Te	Delta	Delta %	% of Limit Range
30	1	-6.170	-5.456	0.714	-11.57%	2.38%
30	2	-4.875	-3.874	1.001	-20.53%	3.34%
30	3	-3.676	-4.124	-0.448	12.19%	1.49%
30	4	-2.185	-3.637	-1.452	66.45%	4.84%
30	5	-2.756	-3.146	-0.390	14.15%	1.30%
30	6	-0.941	-2.087	-1.146	121.79%	3.82%
30	7	-4.901	-3.473	1.428	-29.14%	4.76%
30	8	-4.479	-3.200	1.279	-28.56%	4.26%
30	9	-3.912	-4.692	-0.780	19.94%	2.60%
30	10	-4.317	-3.579	0.738	-17.10%	2.46%
0	11	-5.150	-3.197	1.953	-37.92%	6.51%
Max		-0.941	-2.087	1.953	121.79%	6.51%
Average		-3.942	-3.679	0.263	8.15%	3.43%
Min		-6.170	-5.456	-1.452	-37.92%	1.30%
Std Dev		1.490	0.881	1.147	48.18%	1.58%

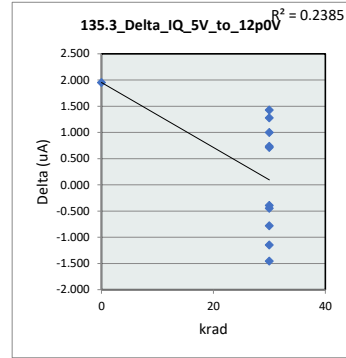

#### 135.3\_Delta\_IQ\_5V\_to\_12p0V

Test Site	Junkins
Tester	FETS36401
Test Number	EQ0581
Max Limit	10 uA
Min Limit	-20 uA
krad	0 30
LL	-20.000 -20.000
Min	-3.197 -5.456
Average	-3.197 -3.727
Max	-3.197 -2.087
UL	10.000 10.000

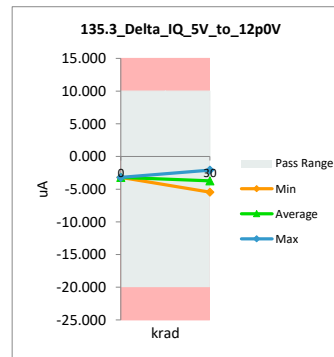

### LDR TID Report INA950A1MPWTSEP

#### 135.4\_Delta\_IQ\_5V\_to\_20p0V

Test Site	Junkins	Junkins
Tester	FETS36401	FETS36401
Test Number	EQ0581	EQ0581
Unit	uA	uA
Max Limit	10	10
Min Limit	-30	-30

krad	Serial #	NA950 LDR Pre-Te	IA950 LDR Post-Te	Delta	Delta %	% of Limit Range
30	1	-9.970	-8.914	1.056	-10.59%	2.64%
30	2	-10.623	-9.086	1.537	-14.47%	3.84%
30	3	-10.057	-8.800	1.257	-12.50%	3.14%
30	4	-8.712	-8.265	0.447	-5.13%	1.12%
30	5	-6.166	-6.945	-0.779	12.63%	1.95%
30	6	-6.104	-6.617	-0.513	8.40%	1.28%
30	7	-10.551	-10.584	-0.033	0.31%	0.08%
30	8	-9.106	-7.973	1.133	-12.44%	2.83%
30	9	-9.075	-10.099	-1.024	11.28%	2.56%
30	10	-8.896	-7.378	1.518	-17.06%	3.80%
0	11	-9.388	-9.481	-0.093	0.99%	0.23%
Max		-6.104	-6.617	1.537	12.63%	3.84%
Average		-8.968	-8.558	0.410	-3.51%	2.13%
Min		-10.623	-10.584	-1.024	-17.06%	0.08%
Std Dev		1.542	1.264	0.945	10.83%	1.31%

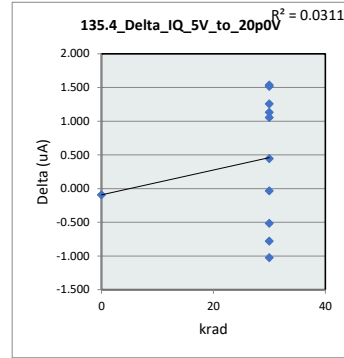

#### 135.4\_Delta\_IQ\_5V\_to\_20p0V

Test Site	Junkins
Tester	FETS36401
Test Number	EQ0581
Max Limit	10 uA
Min Limit	-30 uA
krad	0 30
LL	-30.000 -30.000
Min	-9.481 -10.584
Average	-9.481 -8.466
Max	-9.481 -6.617
UL	10.000 10.000

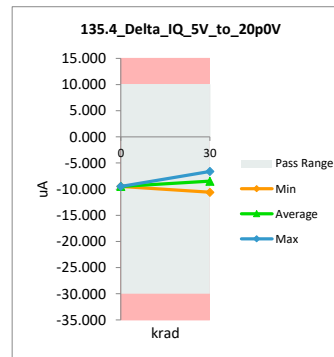

## 5 Revision History

NOTE: Page numbers for previous revisions may differ from page numbers in the current version.

<b>Changes from Revision * (February 2025) to Revision A (March 2025)</b>	<b>Page</b>
• Changed 43MeV-cm2/mg to 50.4MeV-cm2/mg to reflect accurate energy level.....	1
• Changed 20krad(Si) to 30krad(Si) to reflect accurate radiation level.....	3
• Clarified the delta ratio remained under 1.5x, and explicitly stated that future HDR testing would be done biased.....	5
• Repaired the graphics to remove clerical information (continuity, leakage, and so on.).....	8

## Important Limitations on Use of Data Exceeding Specified Limits

TI is providing this data for your convenience. However, we want to make clear the significant limitations of its usefulness as an indicator of how devices may perform in various applications.

THIS DATA IS PROVIDED "AS IS" WITHOUT ANY EXPRESS OR IMPLIED WARRANTY OF ANY KIND INCLUDING WARRANTIES OF MERCHANTABILITY, NONINFRINGEMENT OF INTELLECTUAL PROPERTY, OR FITNESS FOR ANY PARTICULAR PURPOSE. IN NO EVENT SHALL TI OR ITS SUPPLIERS BE LIABLE FOR ANY DAMAGES WHATSOEVER (INCLUDING, WITHOUT LIMITATION, DAMAGES FOR LOSS OF PROFITS, BUSINESS INTERRUPTION, LOSS OF INFORMATION) ARISING OUT OF THE USE OF OR INABILITY TO USE THE INFORMATION, EVEN IF TI HAS BEEN ADVISED OF THE POSSIBILITY OF SUCH DAMAGES.

Your use of this data, and all consequences of such use, is solely your responsibility. You must perform sufficient engineering and additional qualification testing in order to properly evaluate your application and determine whether a candidate device is suitable for use in that application.

TI semiconductor components are specifically designed and manufactured to be used within the electrical, thermal, mechanical and other parameters set forth in TI's product data sheets. Quality and reliability data provided by Texas Instruments, such as MTBF and fit rate data, is intended to be an estimate of product performance based upon history only. It does not imply that any performance levels reflected in such data can be met if the product is operated outside the conditions expressly stated in the latest published data sheet for a device.

Plastic encapsulated TI semiconductor devices are neither designed nor warranted as suitable for use in military applications and/or military environments.

THIS INFORMATION SHOULD NOT BE USED TO ASSIST IN THE PRACTICE OF "UPRATING" OR "UPSCREENING" DEVICES FOR USE IN MILITARY OR OTHER CRITICAL APPLICATIONS. There are significant limitations of this information as an indicator of how commercial, off-the-shelf (COTS) devices may perform in such applications or environments, and about the hazards of using COTS devices in such applications. TI strongly believes that semiconductor components should never be used outside their specified tolerance levels as up-screening can lead directly to system or component failure. Such failures may present distinct risks to end-users and to third parties. TI cannot accept any responsibility for component or system failures that occur due to the misuse of its products, including misuse that may result from the practice of up-screening.

Any use of TI components beyond their rated limits voids all warranty responsibility of TI with respect to such devices, and also voids all responsibility of TI with respect to any applications assistance, product design, software performance or services of any kind that were or may have been performed in connection with the sale of any such devices. Further, resale of TI's products or services with statements different from or beyond the parameters stated by TI for that product or service in official TI data books or data sheets, or without the warnings or instructions provided by TI, voids all express and any implied warranties for the associated TI product or service, and is an unfair and deceptive business practice.

## IMPORTANT NOTICE AND DISCLAIMER

TI PROVIDES TECHNICAL AND RELIABILITY DATA (INCLUDING DATA SHEETS), DESIGN RESOURCES (INCLUDING REFERENCE DESIGNS), APPLICATION OR OTHER DESIGN ADVICE, WEB TOOLS, SAFETY INFORMATION, AND OTHER RESOURCES "AS IS" AND WITH ALL FAULTS, AND DISCLAIMS ALL WARRANTIES, EXPRESS AND IMPLIED, INCLUDING WITHOUT LIMITATION ANY IMPLIED WARRANTIES OF MERCHANTABILITY, FITNESS FOR A PARTICULAR PURPOSE OR NON-INFRINGEMENT OF THIRD PARTY INTELLECTUAL PROPERTY RIGHTS.

These resources are intended for skilled developers designing with TI products. You are solely responsible for (1) selecting the appropriate TI products for your application, (2) designing, validating and testing your application, and (3) ensuring your application meets applicable standards, and any other safety, security, regulatory or other requirements.

These resources are subject to change without notice. TI grants you permission to use these resources only for development of an application that uses the TI products described in the resource. Other reproduction and display of these resources is prohibited. No license is granted to any other TI intellectual property right or to any third party intellectual property right. TI disclaims responsibility for, and you will fully indemnify TI and its representatives against, any claims, damages, costs, losses, and liabilities arising out of your use of these resources.

TI's products are provided subject to [TI's Terms of Sale](#) or other applicable terms available either on [ti.com](https://www.ti.com) or provided in conjunction with such TI products. TI's provision of these resources does not expand or otherwise alter TI's applicable warranties or warranty disclaimers for TI products.

TI objects to and rejects any additional or different terms you may have proposed.

Mailing Address: Texas Instruments, Post Office Box 655303, Dallas, Texas 75265  
Copyright © 2025, Texas Instruments Incorporated

## IMPORTANT NOTICE AND DISCLAIMER

TI PROVIDES TECHNICAL AND RELIABILITY DATA (INCLUDING DATA SHEETS), DESIGN RESOURCES (INCLUDING REFERENCE DESIGNS), APPLICATION OR OTHER DESIGN ADVICE, WEB TOOLS, SAFETY INFORMATION, AND OTHER RESOURCES "AS IS" AND WITH ALL FAULTS, AND DISCLAIMS ALL WARRANTIES, EXPRESS AND IMPLIED, INCLUDING WITHOUT LIMITATION ANY IMPLIED WARRANTIES OF MERCHANTABILITY, FITNESS FOR A PARTICULAR PURPOSE OR NON-INFRINGEMENT OF THIRD PARTY INTELLECTUAL PROPERTY RIGHTS.

These resources are intended for skilled developers designing with TI products. You are solely responsible for (1) selecting the appropriate TI products for your application, (2) designing, validating and testing your application, and (3) ensuring your application meets applicable standards, and any other safety, security, regulatory or other requirements.

These resources are subject to change without notice. TI grants you permission to use these resources only for development of an application that uses the TI products described in the resource. Other reproduction and display of these resources is prohibited. No license is granted to any other TI intellectual property right or to any third party intellectual property right. TI disclaims responsibility for, and you will fully indemnify TI and its representatives against, any claims, damages, costs, losses, and liabilities arising out of your use of these resources.

TI's products are provided subject to [TI's Terms of Sale](#) or other applicable terms available either on [ti.com](https://www.ti.com) or provided in conjunction with such TI products. TI's provision of these resources does not expand or otherwise alter TI's applicable warranties or warranty disclaimers for TI products.

TI objects to and rejects any additional or different terms you may have proposed.

Mailing Address: Texas Instruments, Post Office Box 655303, Dallas, Texas 75265

Copyright © 2025, Texas Instruments Incorporated