



Cris Kobierowski

ABSTRACT

This application note is intended to reduce the EMI concern of the LMK3H0102-Q1 and showcase different layout techniques to improve EMI performance.

Table of Contents

1 Introduction	2
2 Test Setup	3
2.1 Board Variation Summary Table.....	3
2.2 Schematics.....	4
2.3 Layouts.....	5
2.4 Stack-Up.....	6
3 CISPR-25	7
3.1 CISPR-25 Summary.....	8
3.2 CISPR-25 Results.....	11
4 CISPR-32	30
4.1 CISPR-32 Summary.....	31
4.2 CISPR-32 Results.....	32
5 Summary	39
6 References	40

Trademarks

All trademarks are the property of their respective owners.

1 Introduction

Electromagnetic interference (EMI) is any unwanted interference in an electrical circuit caused by an external source. EMI can be categorized as conducted or radiated. Conducted EMI is a form of conduction coupling caused by parasitic impedance, power, and ground connections. Radiated EMI is the coupling of unwanted signals from radio transmission. This report focus on radiated EMI.

The LMK3H0102-Q1 is a clock generator capable of replacing up to five LVCMOS oscillators (XOs). The part uses an internal BAW oscillator as a reference, along with two fractional output dividers for up to two frequency domains (Figure 1-1). Through the use of BAW technology, the LMK3H0102-Q1 can provide increased flexibility and clocking stability when compared to a quartz oscillator (Table 1-1).

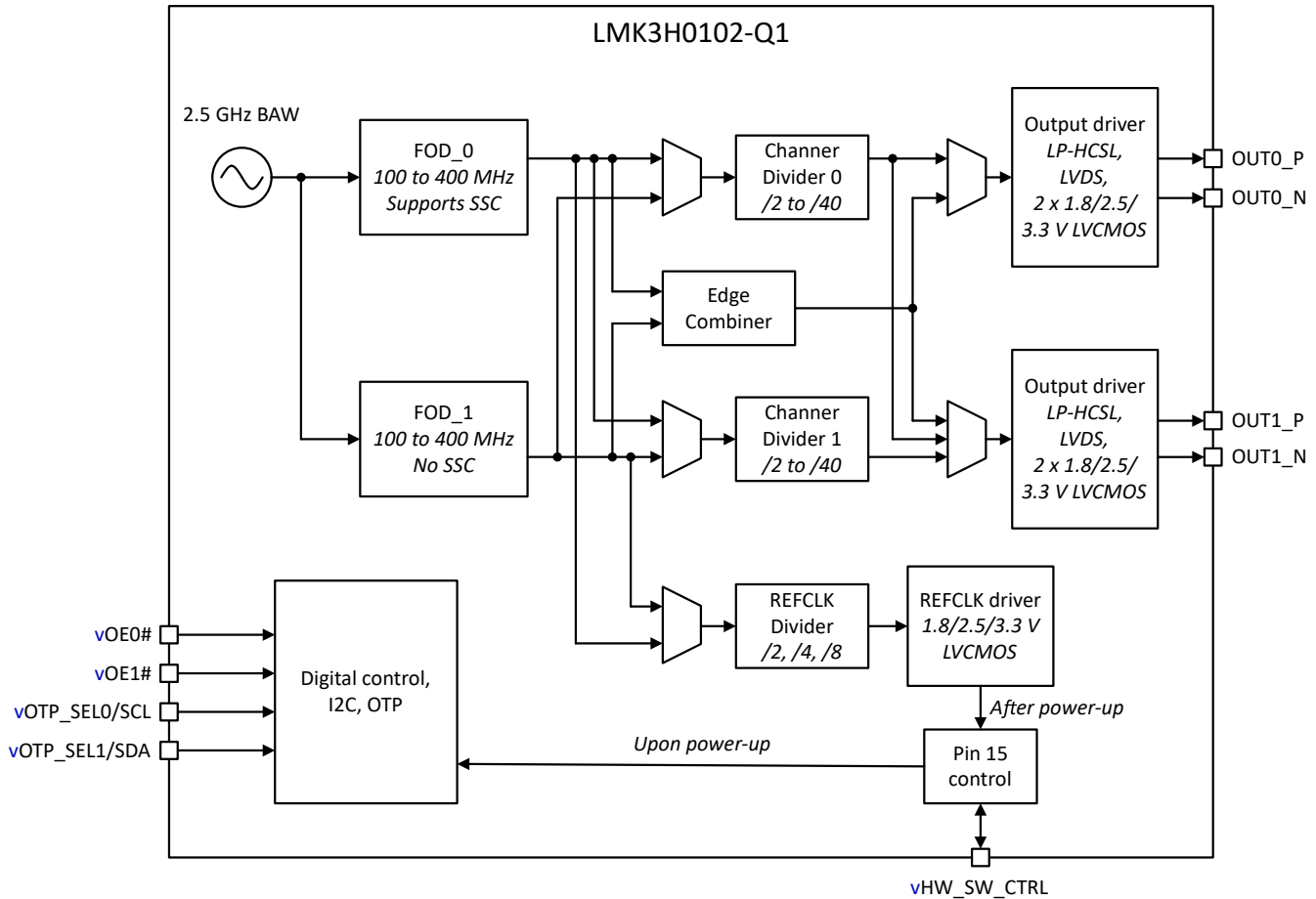

Figure 1-1. LMK3H0102-Q1 Functional Block Diagram

Table 1-1. BAW vs. Quartz Oscillator

Parameter	BAW Technology	Quartz Oscillator Technology
Frequency Flexibility	BAW oscillator devices supports multiple frequencies with single die	Frequency limitations. Different frequencies need different crystals.
Temperature Stability	BAW has ± 10 ppm from -40°C to $+105^{\circ}\text{C}$	As temperature increases, so does ppm stability.
Vibration Sensitivity	BAW meets MIL_STF_883F Method 2002 Condition (Typical is 1ppb/g)	Typically does not pass MIL-STD Can be as high as >10 ppb/g
Mechanical Shock	BAW meets MIL_STD_883F Method 2007 Condition B	Typically does not pass MIL-STD Can fail at 2,000g

Longer PCB traces are often required to reach various end devices when multiple oscillators are replaced with a clock generator, such as the LMK3H0102-Q1. Using longer traces for clock generator routing can result in worse EMI performance than using multiple oscillators, which can be placed close to each end device.

This application note intends to reduce the EMI concern of the LMK3H0102-Q1 and showcase different layout techniques to improve EMI performance.

2 Test Setup

This application note focuses on two comparisons with different test setups:

1. Equal comparison between LMK3H0102-Q1 and Oscillators

- a. The EMI performance of LMK3H0102-Q1 was compared with five Kyocera MC2520Z25.0000C19XSH oscillators.
- b. All outputs are 25MHz LVCMOS and terminated with $C_L = 5\text{pF}$.
- c. Oscillators are mounted on board with same stackup and power filtering and connected to same capacitive load ($C_L = 5\text{pF}$) as LMK3H0102-Q1.
- d. Oscillators are routed with shortest trace possible to C_L (66 mil inches) to represent typical use case.
- e. LMK3H0102-Q1 is routed with shortest trace possible (66 mil inches) for *best* typical clock gen case and 9-12inch traces for *worst* case (see [Section 2.3](#)).

2. Comparison of LMK3H0102-Q1 across different layouts

- a. The EMI performance of the LMK3H0102-Q1 was recorded across four similar board layouts with one change in the parameter (such as trace length) as outlined in [Table 2-1](#).

All boards were tested in Texas Instruments' pre-compliant EMI chamber set up for CISPR-25 and CISPR-32.

2.1 Board Variation Summary Table

Table 2-1. Board Variation Summary Table

Board Variant	Device	Trace Routing	Shielding Vias	Clock Layer	Trace Length
1	LMK3H0102-Q1	Immediate Termination	No	L1	66mil
2	LMK3H0102-Q1	Immediate Branch Out	Yes (400mil spaced array)	L6	9 - 12in
3	LMK3H0102-Q1	Immediate Branch Out	No	L6	9 - 12in
4	Competitor Oscillator	Immediate Termination	No	L1	66mil

2.3 Layouts

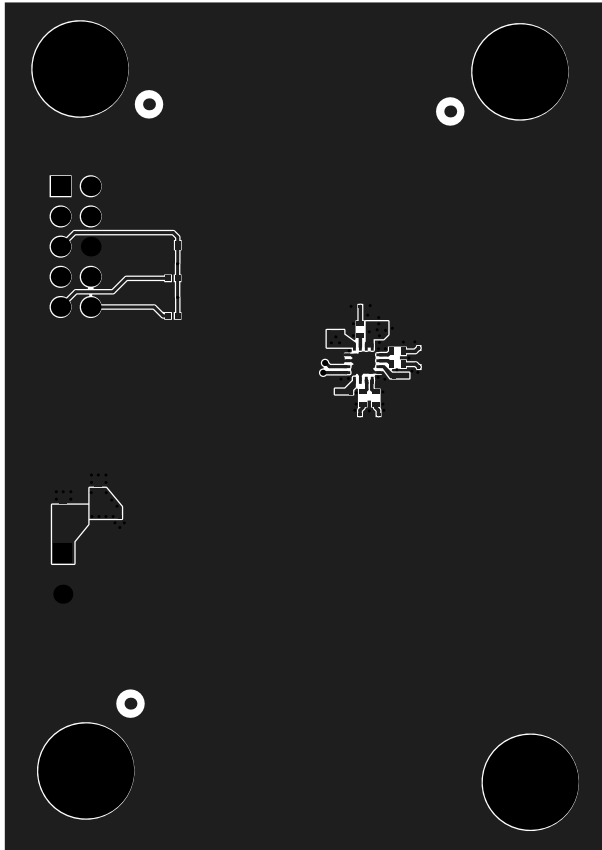

Figure 2-3. Variant 1 Signal Layer Layout

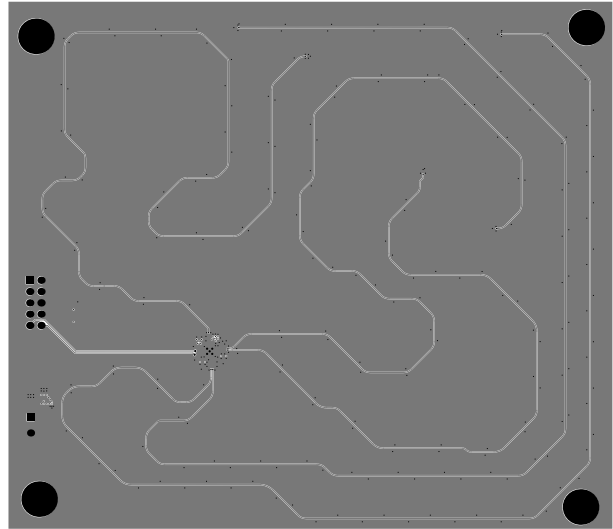

Figure 2-4. Variant 2 Signal Layer Layout

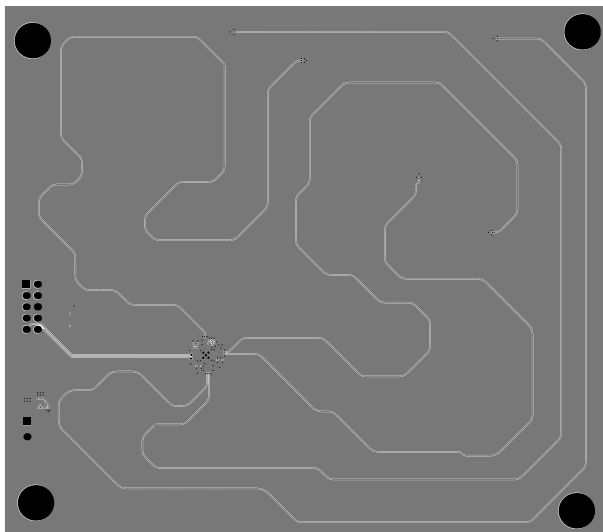

Figure 2-5. Variant 3 Signal Layer Layout

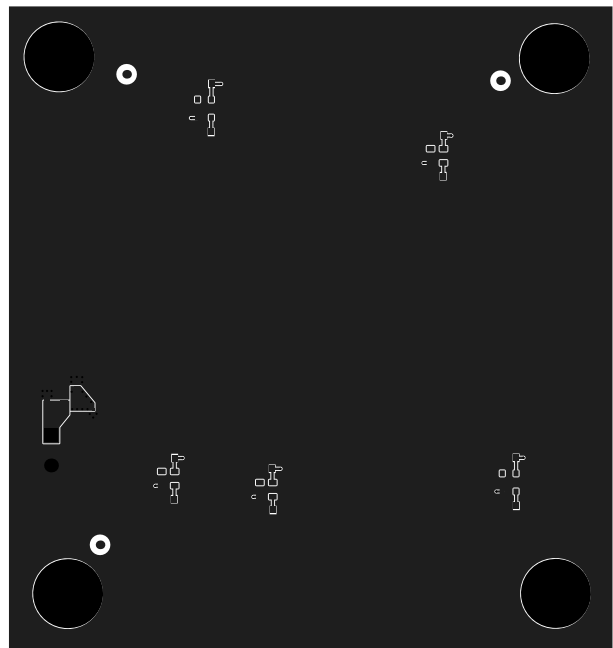

Figure 2-6. Variant 4 Signal Layer Layout

2.4 Stack-Up

#	Name	Material	Type	Weight	Thickness	Dk	GlassTransTemp
	Top Overlay		Overlay				
	Top Solder	Solder Resist	Solder Mask		0.4mil	3.5	
1	L1-Top Layer	CF-004	Signal	1oz	1.4mil		
	Dielectric1	FR-4	Prepreg		6mil	3.84	356°F
2	L2-GND	CF-004	Signal	1oz	1.4mil		
	Dielectric2	FR-4	Core		8mil	3.74	356°F
3	L3-Power Plane	CF-004	Signal	1oz	1.4mil		
	Dielectric3	FR-4	Prepreg		3mil	3.5	356°F
4	L4-GND	CF-004	Signal	1oz	1.4mil		
	Dielectric4	FR-4	Core		12mil	3.76	356°F
5	L5-GND	CF-004	Signal	1oz	1.4mil		
	Dielectric5	FR-4	Prepreg		3mil	3.5	356°F
6	L6-Signal	CF-004	Signal	1oz	1.4mil		
	Dielectric6	FR-4	Core		8mil	3.74	356°F
7	L7-GND	CF-004	Signal	1oz	1.4mil		
	Dielectric7	FR-4	Prepreg		6mil	3.84	356°F
8	L8-Bottom Layer	CF-004	Signal	1oz	1.4mil		
	Bottom Solder	Solder Resist	Solder Mask		0.4mil	3.5	
	Bottom Overlay		Overlay				

Figure 2-7. Test Board Stack-Up

3 CISPR-25

CISPR-25 is the automotive standard for EMI. Four separate antennas are used to cover the 150kHz to 6GHz range.

Table 3-1. CISPR-25 Antenna Frequency Ranges

Antenna	Frequency Range
Monopole	150kHz - 30MHz
Bi-Conical	30MHz - 200MHz
Log-Periodic	200MHz - 1GHz
Horn	1GHz - 6GHz

EMI spurs are measured in dBuV/m, with the antenna set 1m away from the center of the power supply line.

CISPR-25 limits are defined by certification class, with Class 1 being the least stringent, and Class 5 being the most stringent. All limits specified in this test report are Class 5.

Limits for maximum allowed EMI impact are specific to individual frequency bands. For example, TV Band 1 has a Class 5 Max Peak limit of 34dBuV/m, while Analogue UHF has a Class 5 Max Peak limit of 38dBuV/m.

Ground plane is shared between the conductive table and system.

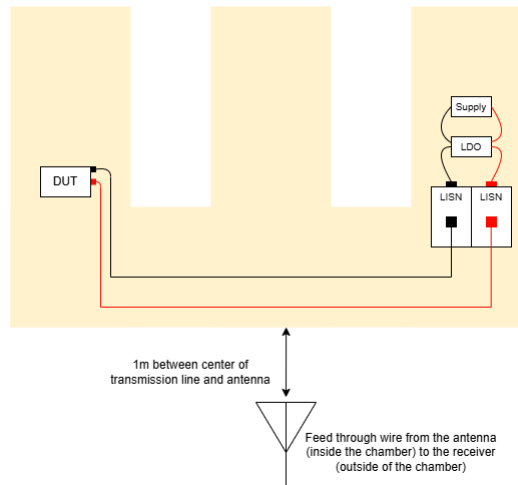

Figure 3-1. CISPR-25 Setup Diagram

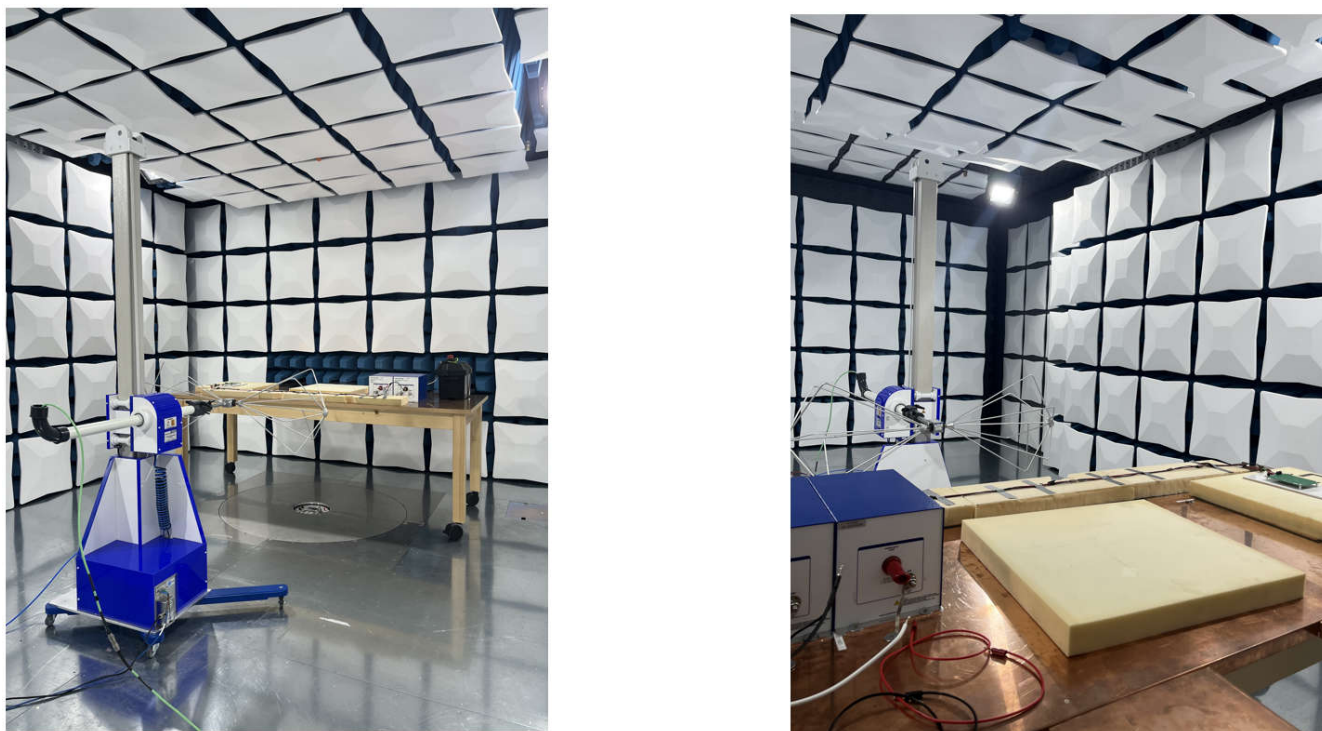

Figure 3-2. CISPR-25 Chamber Setup

3.1 CISPR-25 Summary

At 3.3V, the LMK3H0102-Q1 with no shielding vias and 8+ in trace length passes Class 5 standards for all bands except for TV Band IV, Analogue UHF, GPS L1, and GPS L5. For best performance, use of additional GND vias and SSC is recommended.

At 1.8V, the LMK3H0102-Q1 with no shielding vias and 8+ in trace length passes Class 5 standards for all bands except for TV Band IV, GPS L1, and GPS L5. For best performance, use of additional GND vias or SSC is highly recommended.

Table 3-2. Board Variation Summary Table

Board Variant	Device	Trace Routing	Shielding Vias	Clock Layer	Trace Length
1	LMK3H0102-Q1	Immediate Termination	No	L1	66mil
2	LMK3H0102-Q1	Immediate Branch Out	Yes (400mil spaced array)	L6	9 - 12in
3	LMK3H0102-Q1	Immediate Branch Out	No	L6	9 - 12in
4	Competitor Oscillator	Immediate Termination	No	L1	66mil

			CISPR-25 Radiation Limits (ALSE method) [dBuV/m]									1.8V							
			Class 5			Class 4			Class 3			Class for CISPR-25				Significant Spurs [dBuV/m]			
Service/Band	Frequency (MHz)	Antenna	Peak	Quasi-Peak	Average	Peak	Quasi-Peak	Average	Peak	Quasi-Peak	Average	LMK3H0102 Variant 1	LMK3H0102 Variant 2	LMK3H0102 Variant 3	Competitor XO Variant 4	LMK3H0102 Variant 1	LMK3H0102 Variant 2	LMK3H0102 Variant 3	Competitor XO Variant 4
Analog broadcast services																			
LW	0.15 to 0.3	Monopole	46	33	26	56	43	36	66	53	46	Class 5	Class 5	Class 5	Class 5				
MW	0.53 to 1.8	Monopole	40	27	20	48	35	28	56	43	36	Class 5	Class 5	Class 5	Class 5				
SW	5.9 to 6.2	Monopole	40	27	20	46	33	26	52	39	32	Class 5	Class 5	Class 5	Class 5				
FM	76 to 108	Bi-conical	38	25	18	44	31	24	50	37	30	Class 5	Class 5	Class 5	Class 5				
TV Band I	41 to 88	Bi-conical	28	-	18	34	-	24	40	-	30	Class 5	Class 5	Class 5	Class 5				
TV Band III	174 to 230	Bi-con/LPA	20	-	10	26	-	16	32	-	22	Class 5	Class 5	Class 5	Class 5				
TV Band IV	470 to 944	Log-Periodic	41	-	31	47	-	37	53	-	43	Class 5	Class 5	Class 5	Class 5				
Digital broadcast services																			
DAB III	171 to 245	Bi-con/LPA	30	-	20	36	-	26	42	-	32	Class 5	Class 5	Class 5	Class 5				
TV Band III	174 to 230	Bi-con/LPA	30	-	20	36	-	26	42	-	32	Class 5	Class 5	Class 5	Class 5				
DTV	470 to 770	Log-Periodic	46	-	36	52	-	42	58	-	48	Class 5	Class 5	Class 5	Class 5				
DAB L Band	147 to 1,494	LPA/Horn	54	-	44	60	-	50	66	-	56	Class 5	Class 5	Class 5	Class 5				
SDARS	320 to 2,345	LPA/Horn	58	-	48	64	-	54	70	-	60	Class 5	Class 5	Class 5	Class 5				
Mobile services																			
CB	26 to 28	Monopole	40	27	20	46	33	26	52	39	32	Class 5	Class 5	Class 5	Class 5				
VHF	30 to 54	Bi-conical	40	27	20	46	33	26	52	39	32	Class 5	Class 5	Class 5	Class 5				
VHF	68 to 87	Bi-conical	35	22	15	41	28	21	47	34	27	Class 5	Class 5	Class 5	Class 5				
VHF	142 to 175	Bi-conical	35	22	15	41	28	21	47	34	27	Class 5	Class 5	Class 5	Class 5				
Analog UHF	380 to 512	Log-Periodic	38	25	18	44	31	24	50	37	30	Class 5	Class 5	Class 5	Class 5				
RKE & TPMS 1	300 to 330	Log-Periodic	32	-	18	38	-	24	44	-	30	Class 5	Class 5	Class 5	Class 5	400 MHz: AVG = 12.7			475 MHz: AVG = 8.1
RKE & TPMS 2	420 to 450	Log-Periodic	32	-	18	38	-	24	44	-	30	Class 5	Class 5	Class 5	Class 5				
Analog UHF	820 to 960	Log-Periodic	44	31	24	50	37	30	56	43	36	Class 5	Class 5	Class 5	Class 5				
GPS L5	1,156.45 to 1,196.45	Horn	-	-	20	-	-	26	-	-	32	Class 5	Class 5	Class 4-5	Class 5				1075 MHz: AVG = 19.4
BDS, B1I	1,553.098 to 1,569.098	Horn	-	-	5.5	-	-	11.5	-	-	17.5	Class 5	Class 5	Class 5	Class 5				
GPS L1	1,567.42 to 1,583.42	Horn	-	-	10	-	-	16	-	-	22	Class 4	Class 5	Class 3-4	Class 4	1575 MHz: AVG = 12			1575 MHz: AVG = 15
GLONASS L1	1,590.781 to 1,616.594	Horn	-	-	10	-	-	16	-	-	22	Class 5	Class 5	Class 5	Class 5				1575 MHz: AVG = 10
Wi-Fi / Bluetooth	2,402 to 2,494	Horn	52	-	32	58	-	38	64	-	44	Class 5	Class 5	Class 5	Class 5				
Wi-Fi	5,150 to 5,350	Horn	59	-	39	65	-	45	71	-	51	Class 5	Class 5	Class 5	Class 5				
Wi-Fi	5,470 to 5,725	Horn	59	-	39	65	-	45	71	-	51	Class 5	Class 5	Class 5	Class 5				
V2X (Wi-Fi)	5,850 to 5,925	Horn	84	-	64	90	-	70	96	-	76	Class 5	Class 5	Class 5	Class 5				

Figure 3-5. CISPR-25 - 1.8V Supply - Summary Table

			CISPR-25 Radiation Limits (ALSE method) [dBuV/m]									1.8V							
			Class 5			Class 4			Class 3			Class for CISPR-25				Significant Spurs [dBuV/m]			
Service/Band	Frequency (MHz)	Antenna	Peak	Quasi-Peak	Average	Peak	Quasi-Peak	Average	Peak	Quasi-Peak	Average	LMK3H0102 Variant 1	LMK3H0102 Variant 2	LMK3H0102 Variant 3	Competitor XO Variant 4	LMK3H0102 Variant 1	LMK3H0102 Variant 2	LMK3H0102 Variant 3	Competitor XO Variant 4
Analog broadcast services																			
LW	0.15 to 0.3	Monopole	46	33	26	56	43	36	66	53	46	Class 5	Class 5	Class 5	Class 5				
MW	0.53 to 1.8	Monopole	40	27	20	48	35	28	56	43	36	Class 5	Class 5	Class 5	Class 5				
SW	5.9 to 6.2	Monopole	40	27	20	46	33	26	52	39	32	Class 5	Class 5	Class 5	Class 5				
FM	76 to 108	Bi-conical	38	25	18	44	31	24	50	37	30	Class 5	Class 5	Class 5	Class 5				
TV Band I	41 to 88	Bi-conical	28	-	18	34	-	24	40	-	30	Class 5	Class 5	Class 5	Class 5				
TV Band III	174 to 230	Bi-con/LPA	20	-	10	26	-	16	32	-	22	Class 5	Class 5	Class 5	Class 5				
TV Band IV	470 to 944	Log-Periodic	41	-	31	47	-	37	53	-	43	Class 5	Class 5	Class 5	Class 5				
Digital broadcast services																			
DAB III	171 to 245	Bi-con/LPA	30	-	20	36	-	26	42	-	32	Class 5	Class 5	Class 5	Class 5				
TV Band III	174 to 230	Bi-con/LPA	30	-	20	36	-	26	42	-	32	Class 5	Class 5	Class 5	Class 5				
DTV	470 to 770	Log-Periodic	46	-	36	52	-	42	58	-	48	Class 5	Class 5	Class 5	Class 5				
DAB L Band	147 to 1,494	LPA/Horn	54	-	44	60	-	50	66	-	56	Class 5	Class 5	Class 5	Class 5				
SDARS	320 to 2,345	LPA/Horn	58	-	48	64	-	54	70	-	60	Class 5	Class 5	Class 5	Class 5				
Mobile services																			
CB	26 to 28	Monopole	40	27	20	46	33	26	52	39	32	Class 5	Class 5	Class 5	Class 5				
VHF	30 to 54	Bi-conical	40	27	20	46	33	26	52	39	32	Class 5	Class 5	Class 5	Class 5				
VHF	68 to 87	Bi-conical	35	22	15	41	28	21	47	34	27	Class 5	Class 5	Class 5	Class 5				
VHF	142 to 175	Bi-conical	35	22	15	41	28	21	47	34	27	Class 5	Class 5	Class 5	Class 5				
Analog UHF	380 to 512	Log-Periodic	38	25	18	44	31	24	50	37	30	Class 5	Class 5	Class 5	Class 5				
RKE & TPMS 1	300 to 330	Log-Periodic	32	-	18	38	-	24	44	-	30	Class 5	Class 5	Class 5	Class 5				
RKE & TPMS 2	420 to 450	Log-Periodic	32	-	18	38	-	24	44	-	30	Class 5	Class 5	Class 5	Class 5				
Analog UHF	820 to 960	Log-Periodic	44	31	24	50	37	30	56	43	36	Class 5	Class 5	Class 5	Class 5				
GPS L5	1,156.45 to 1,196.45	Horn	-	-	20	-	-	26	-	-	32	Class 5	Class 5	Class 5	Class 5				1075 MHz: AVG = 12
BDS, B1I	1,553.098 to 1,569.098	Horn	-	-	5.5	-	-	11.5	-	-	17.5	Class 5	Class 5	Class 5	Class 5				
GPS L1	1,567.42 to 1,583.42	Horn	-	-	10	-	-	16	-	-	22	Class 5	Class 5	Class 5	Class 4-5				1575 MHz: AVG = 10
GLONASS L1	1,590.781 to 1,616.594	Horn	-	-	10	-	-	16	-	-	22	Class 5	Class 5	Class 5	Class 5				
Wi-Fi / Bluetooth	2,402 to 2,494	Horn	52	-	32	58	-	38	64	-	44	Class 5	Class 5	Class 5	Class 5				
Wi-Fi	5,150 to 5,350	Horn	59	-	39	65	-	45	71	-	51	Class 5	Class 5	Class 5	Class 5				
Wi-Fi	5,470 to 5,725	Horn	59	-	39	65	-	45	71	-	51	Class 5	Class 5	Class 5	Class 5				
V2X (Wi-Fi)	5,850 to 5,925	Horn	84	-	64	90	-	70	96	-	76	Class 5	Class 5	Class 5	Class 5				

Figure 3-6. CISPR-25 - 1.8V Supply - With -0.5% SSC - Summary Table

3.2 CISPR-25 Results

Note

Spectrum Overview plots represent both horizontal and vertical measurements

3.2.1 Monopole

Table 3-3. Board Variation Summary Table

Board Variant	Device	Trace Routing	Shielding Vias	Clock Layer	Trace Length
1	LMK3H0102-Q1	Immediate Termination	No	L1	66mil
2	LMK3H0102-Q1	Immediate Branch Out	Yes (400mil spaced array)	L6	9 - 12in
3	LMK3H0102-Q1	Immediate Branch Out	No	L6	9 - 12in
4	Competitor Oscillator	Immediate Termination	No	L1	66mil

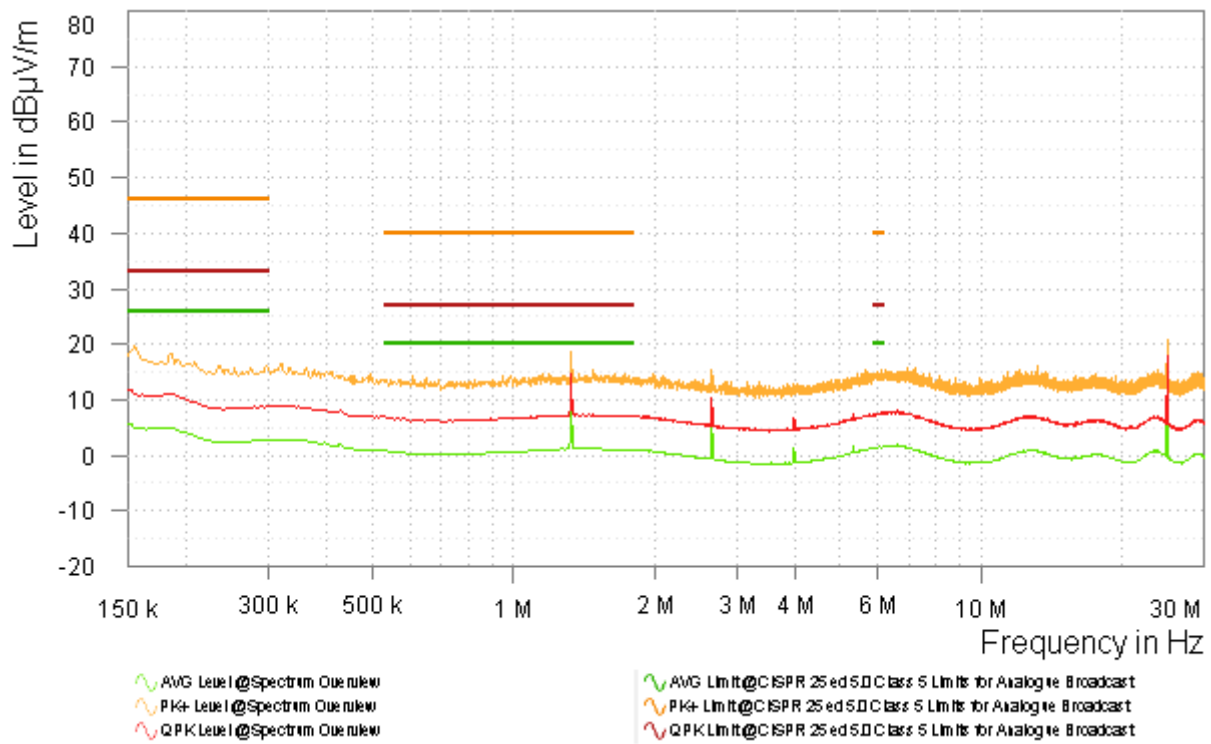

Figure 3-7. Variant 3 LMK3H0102-Q1 3.3V Spectrum Overview - Monopole

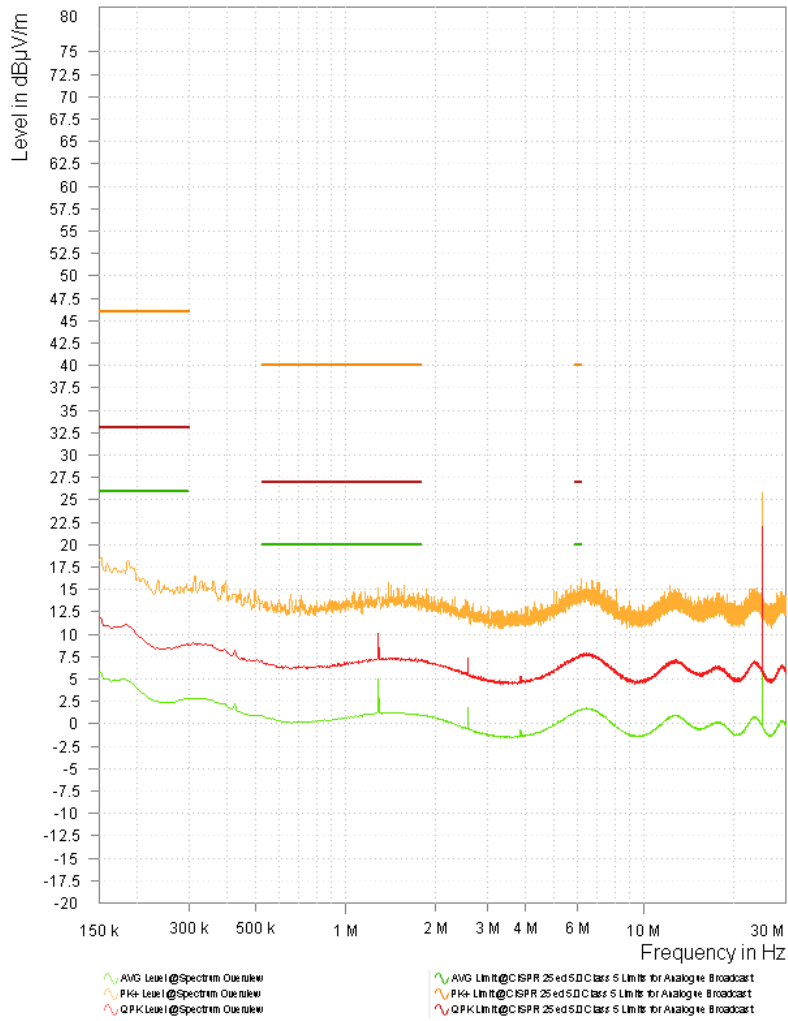

Figure 3-8. Variant 4 Competitor Oscillator 3.3V Spectrum Overview - Monopole

Table 3-4. Average Spur Level - Competitor Oscillator vs. LMK3H0102-Q1 with 3.3V Supply - Monopole

Frequency (MHz)	Competitor Oscillator (dBuV/m)	LMK3H0102-Q1 (dBuV/m)	TI Delta
1.3	5.08	12.38	+7.30
2.6	1.85	7.08	+5.28
25	17.20	17.17	-0.03

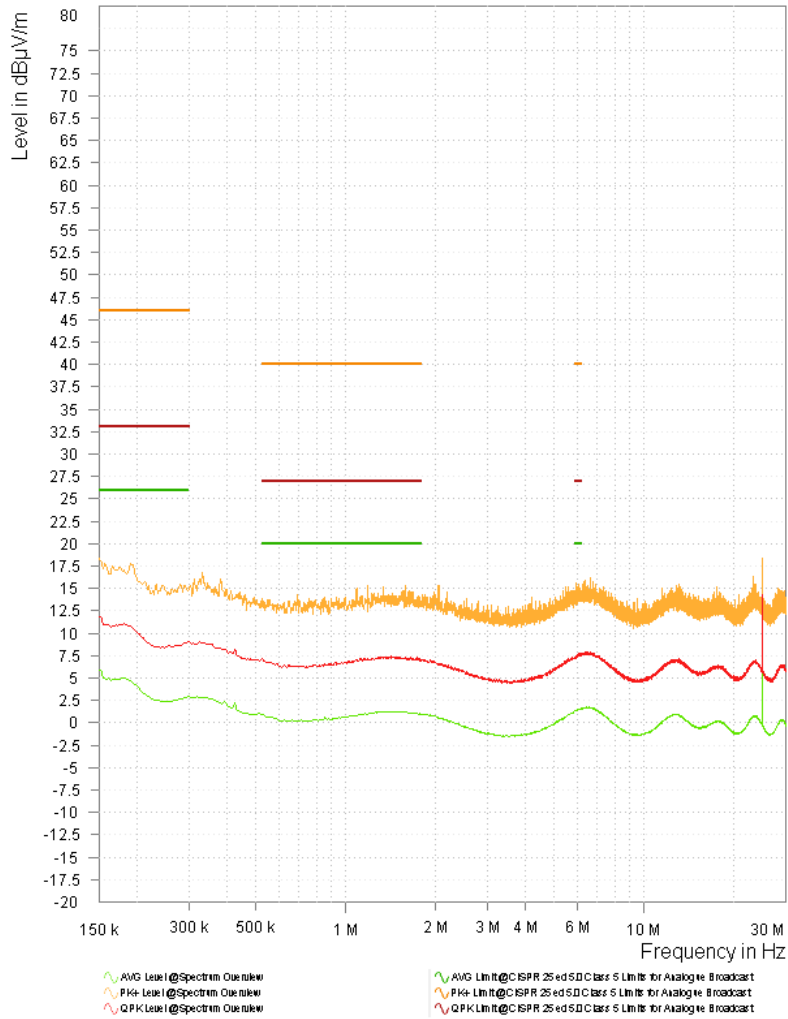

Figure 3-9. Variant 3 LMK3H0102-Q1 1.8V Spectrum Overview - Monopole

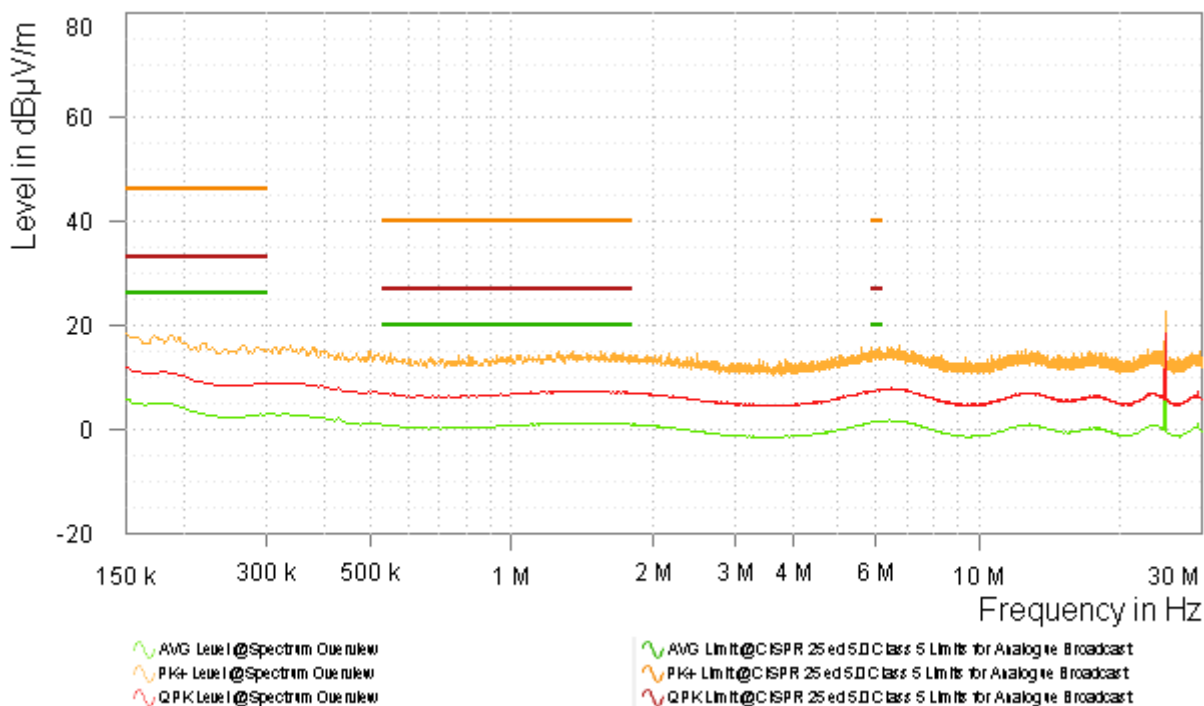

Figure 3-10. Variant 4 Competitor Oscillator 1.8V Spectrum Overview - Monopole

Table 3-5. Average Spur Level - Competitor Oscillator vs. LMK3H0102-Q1 with 1.8V Supply - Monopole

Frequency (MHz)	Competitor Oscillator (dBuV/m)	LMK3H0102-Q1 (dBuV/m)	TI Delta
25	13.73	12.20	-1.53

3.2.2 Bi-Conical

Table 3-6. Board Variation Summary Table

Board Variant	Device	Trace Routing	Shielding Vias	Clock Layer	Trace Length
1	LMK3H0102-Q1	Immediate Termination	No	L1	66mil
2	LMK3H0102-Q1	Immediate Branch Out	Yes (400mil spaced array)	L6	9 - 12in
3	LMK3H0102-Q1	Immediate Branch Out	No	L6	9 - 12in
4	Competitor Oscillator	Immediate Termination	No	L1	66mil

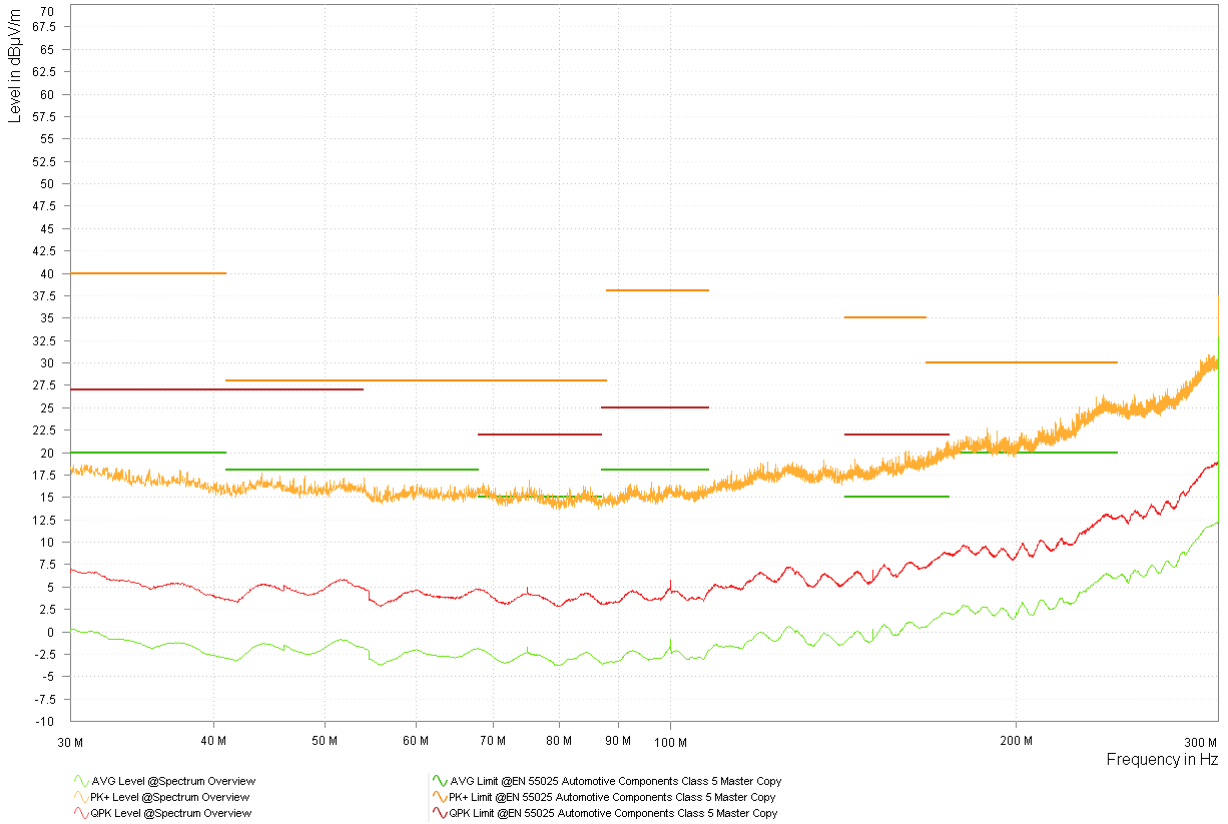

Figure 3-11. Variant 3 LMK3H0102-Q1 3.3V Spectrum Overview - Bi-Conical

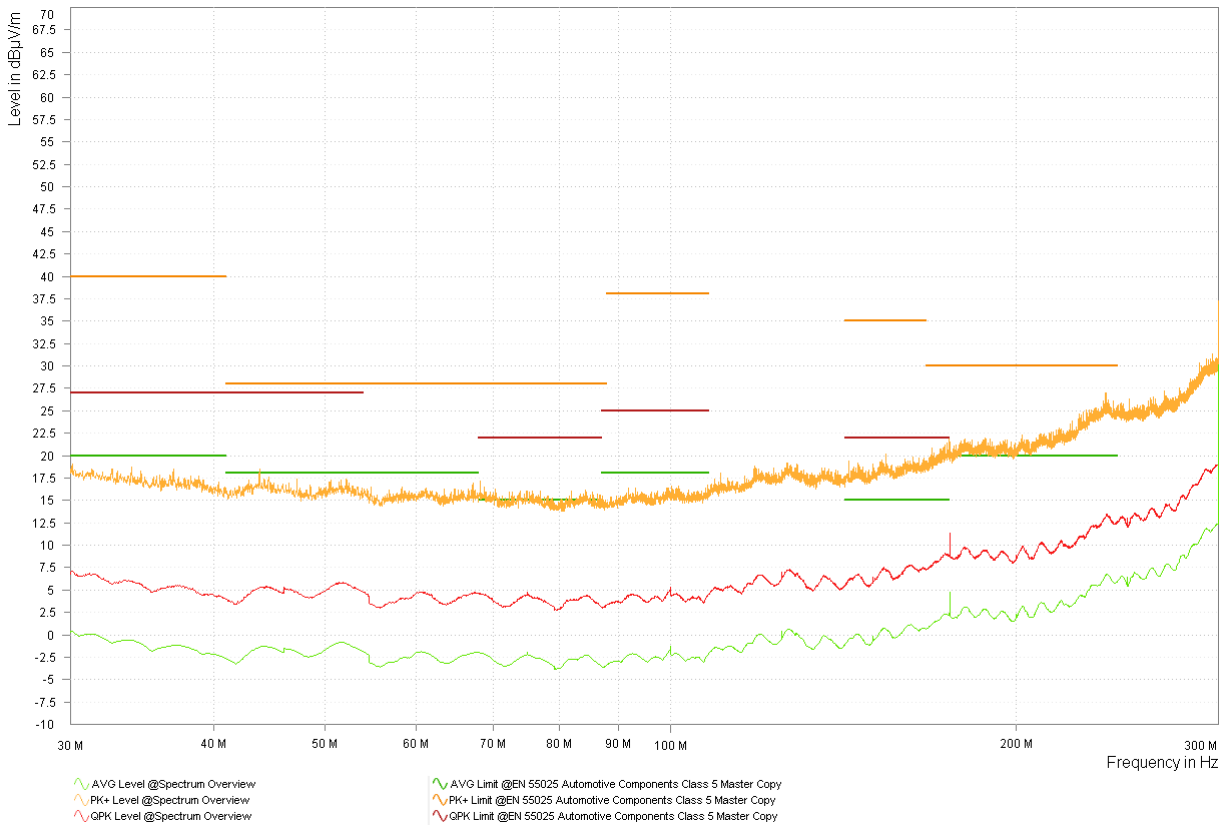

Figure 3-12. Variant 4 Competitor Oscillator 3.3V Spectrum Overview - Bi-Conical

Table 3-7. Average Spur Level - Competitor Oscillator vs. LMK3H0102-Q1 with 3.3V Supply - Bi-Conical

Frequency (MHz)	Competitor Oscillator (dBuV/m)	LMK3H0102-Q1 (dBuV/m)	TI Delta
75	-1.95	-1.75	+0.20
100	-1.27	-0.83	+0.44
150	-0.16	0.01	+0.17
175	4.75	2.09	-2.66

3.2.3 Log-Periodic

Table 3-8. Board Variation Summary Table

Board Variant	Device	Trace Routing	Shielding Vias	Clock Layer	Trace Length
1	LMK3H0102-Q1	Immediate Termination	No	L1	66mil
2	LMK3H0102-Q1	Immediate Branch Out	Yes (400mil spaced array)	L6	9 - 12in
3	LMK3H0102-Q1	Immediate Branch Out	No	L6	9 - 12in
4	Competitor Oscillator	Immediate Termination	No	L1	66mil



Figure 3-13. Variant 1 LMK3H0102-Q1 3.3V Spectrum Overview - Log-Periodic

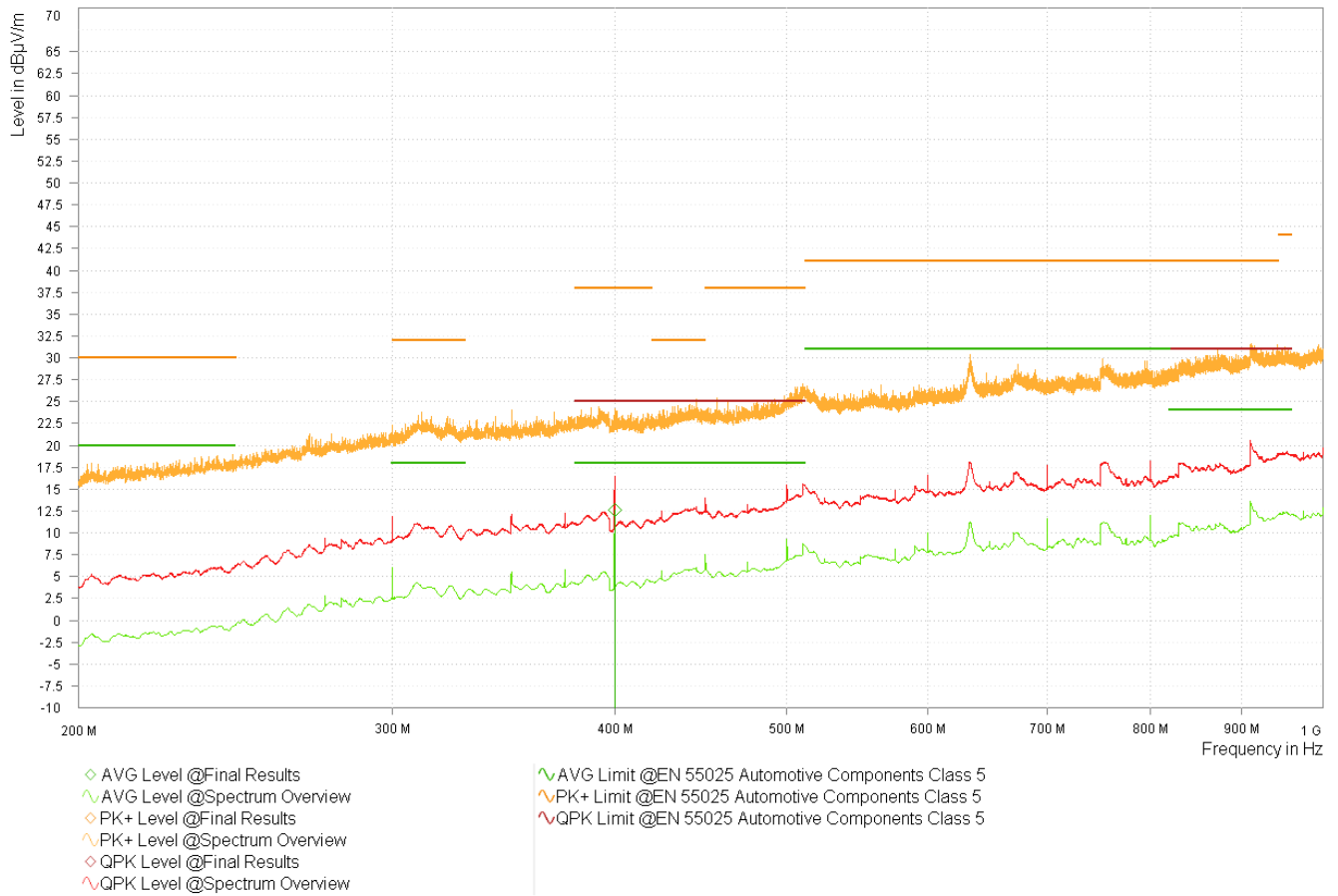

Figure 3-14. Variant 2 LMK3H0102-Q1 3.3V Spectrum Overview - Log-Periodic

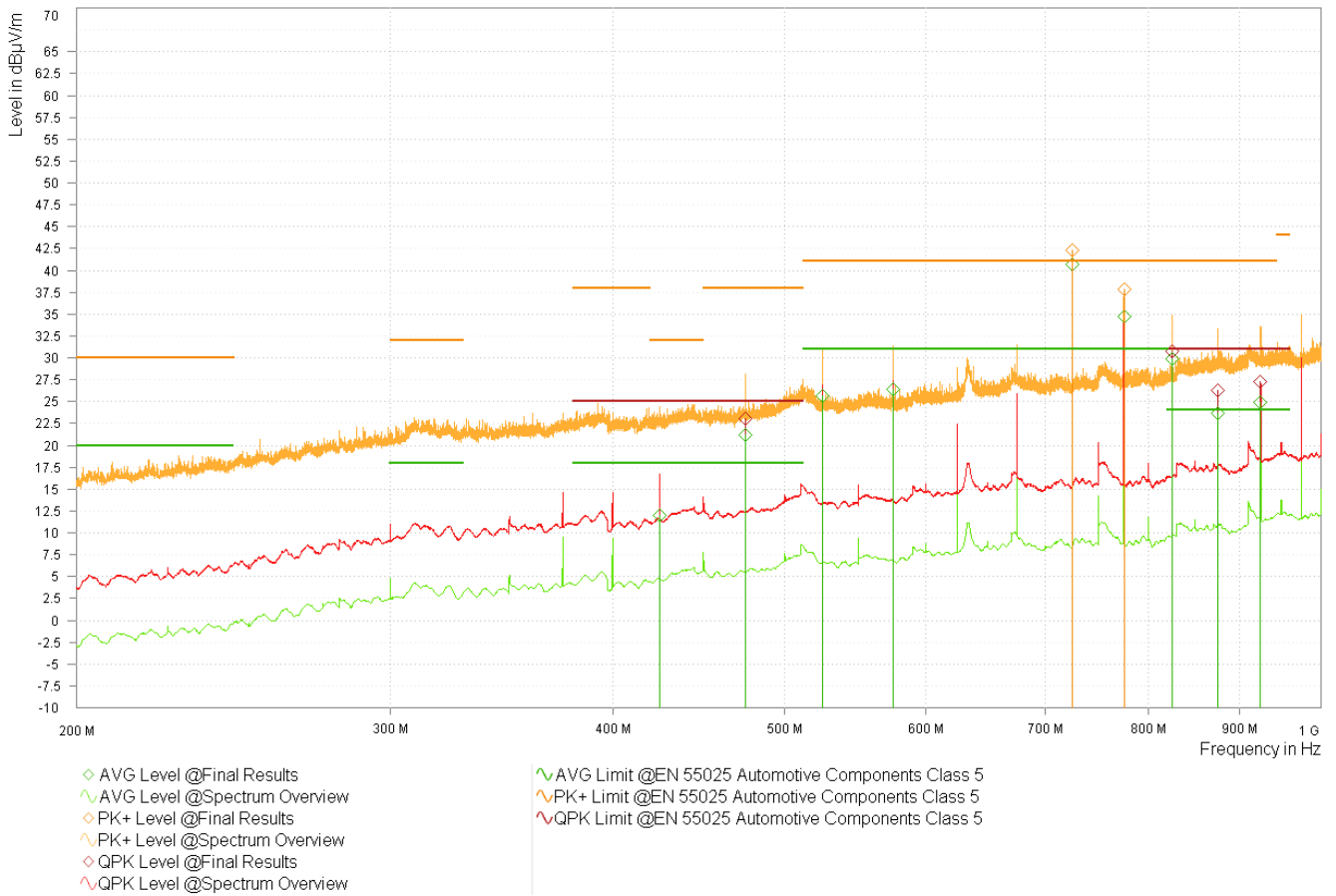

Figure 3-15. Variant 3 LMK3H0102-Q1 3.3V Spectrum Overview - Log-Periodic

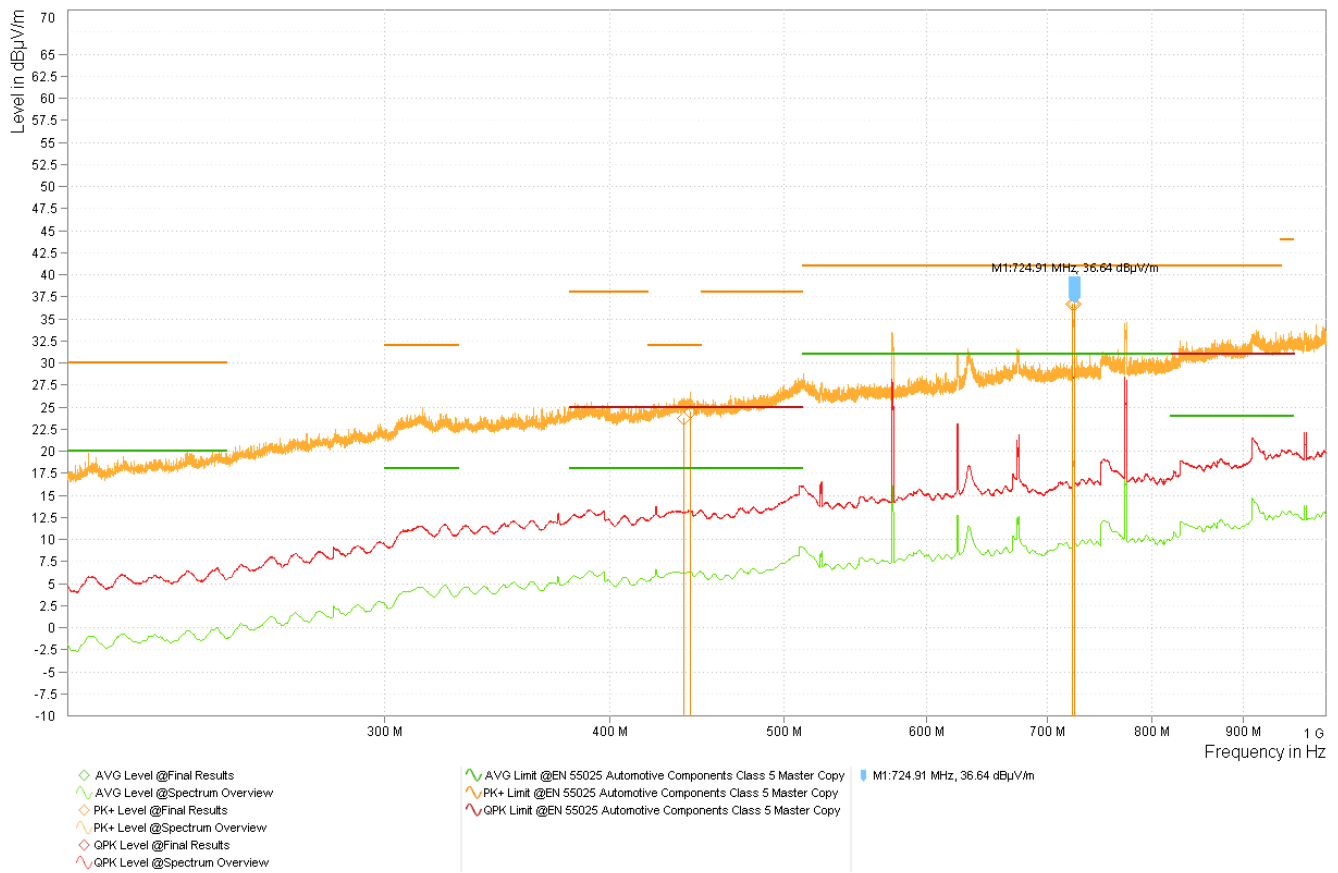

Figure 3-16. Variant 4 LMK3H0102-Q1 3.3V with -0.5% SSC Spectrum Overview - Log-Periodic

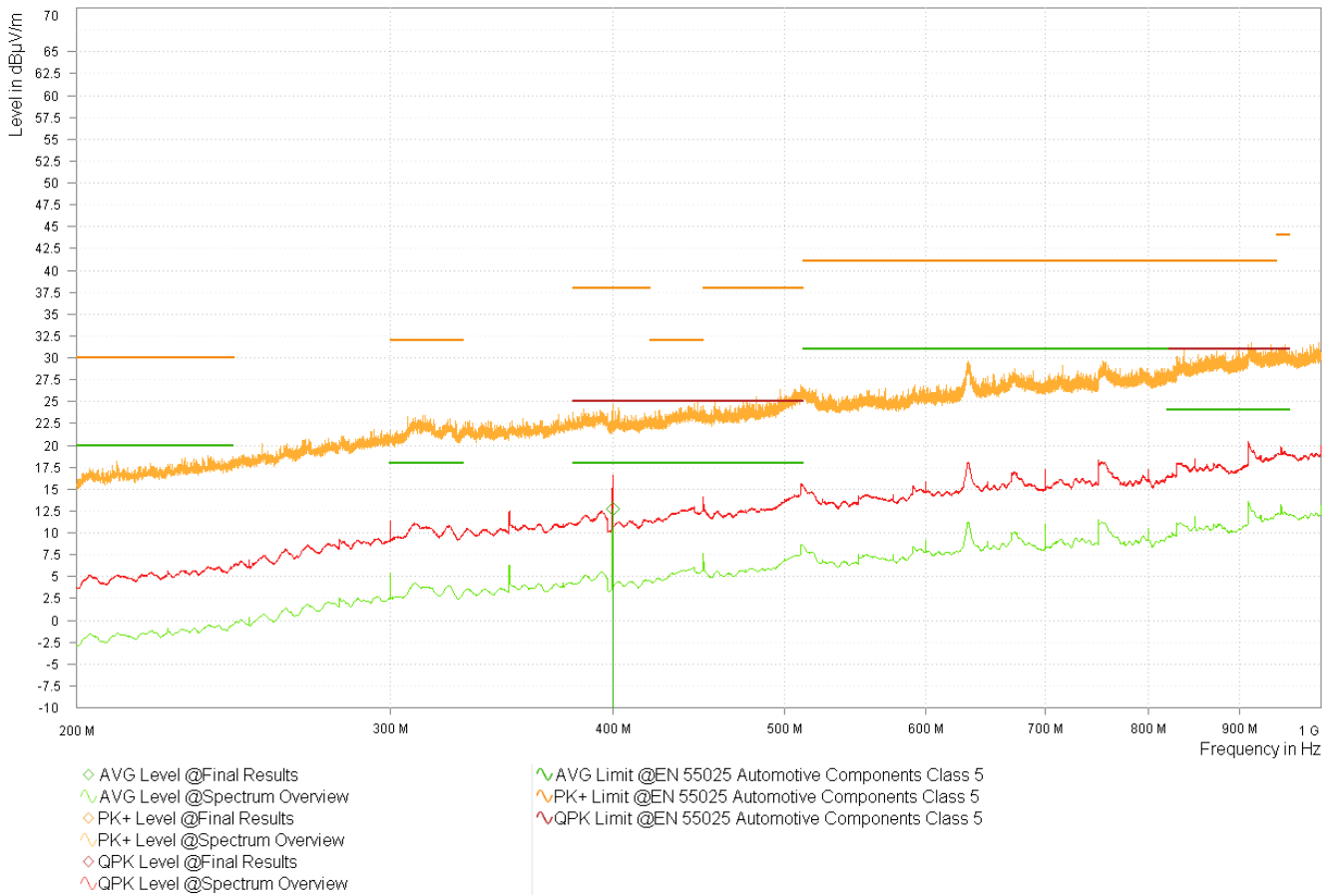

Figure 3-17. Variant 1 LMK3H0102-Q1 1.8V Spectrum Overview - Log-Periodic

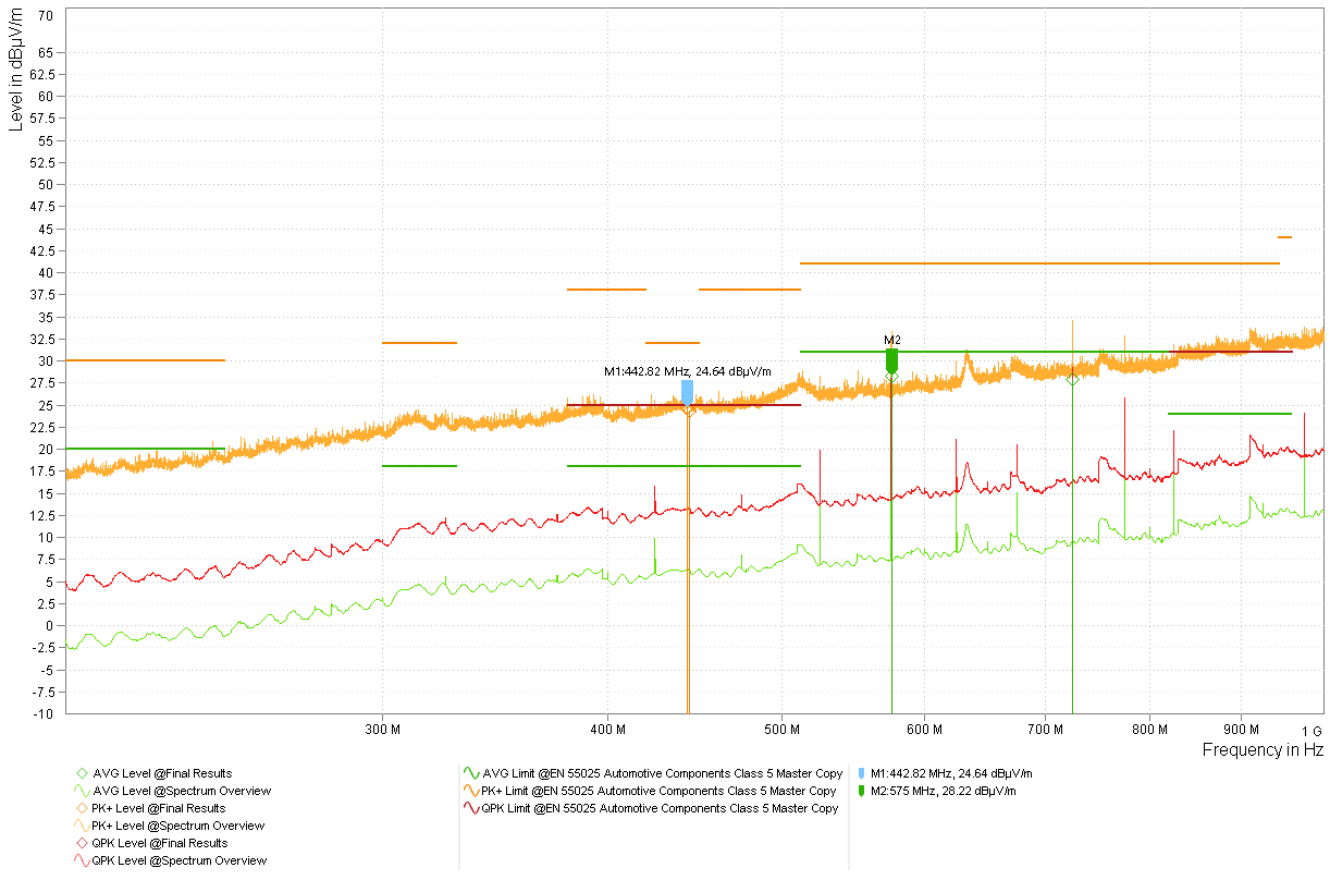

Figure 3-18. Variant 3 LMK3H0102-Q1 1.8V Spectrum Overview - Log-Periodic



Figure 3-19. Competitor Oscillator 3.3V Spectrum Overview - Log-Periodic

3.2.4 Horn

Table 3-9. Board Variation Summary Table

Board Variant	Device	Trace Routing	Shielding Vias	Clock Layer	Trace Length
1	LMK3H0102-Q1	Immediate Termination	No	L1	66mil
2	LMK3H0102-Q1	Immediate Branch Out	Yes (400mil spaced array)	L6	9 - 12in
3	LMK3H0102-Q1	Immediate Branch Out	No	L6	9 - 12in
4	Competitor Oscillator	Immediate Termination	No	L1	66mil

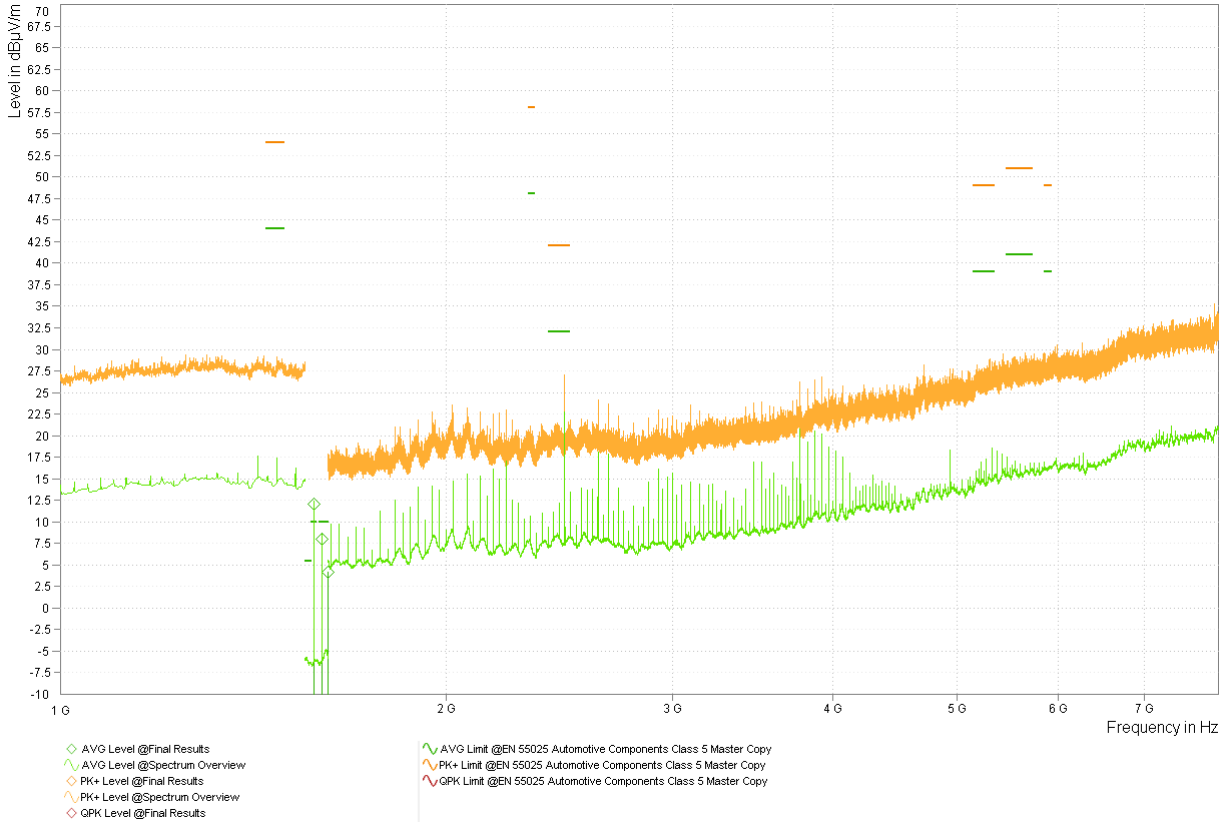

Figure 3-20. Variant 2 LMK3H0102-Q1 3.3V Spectrum Overview - Horn

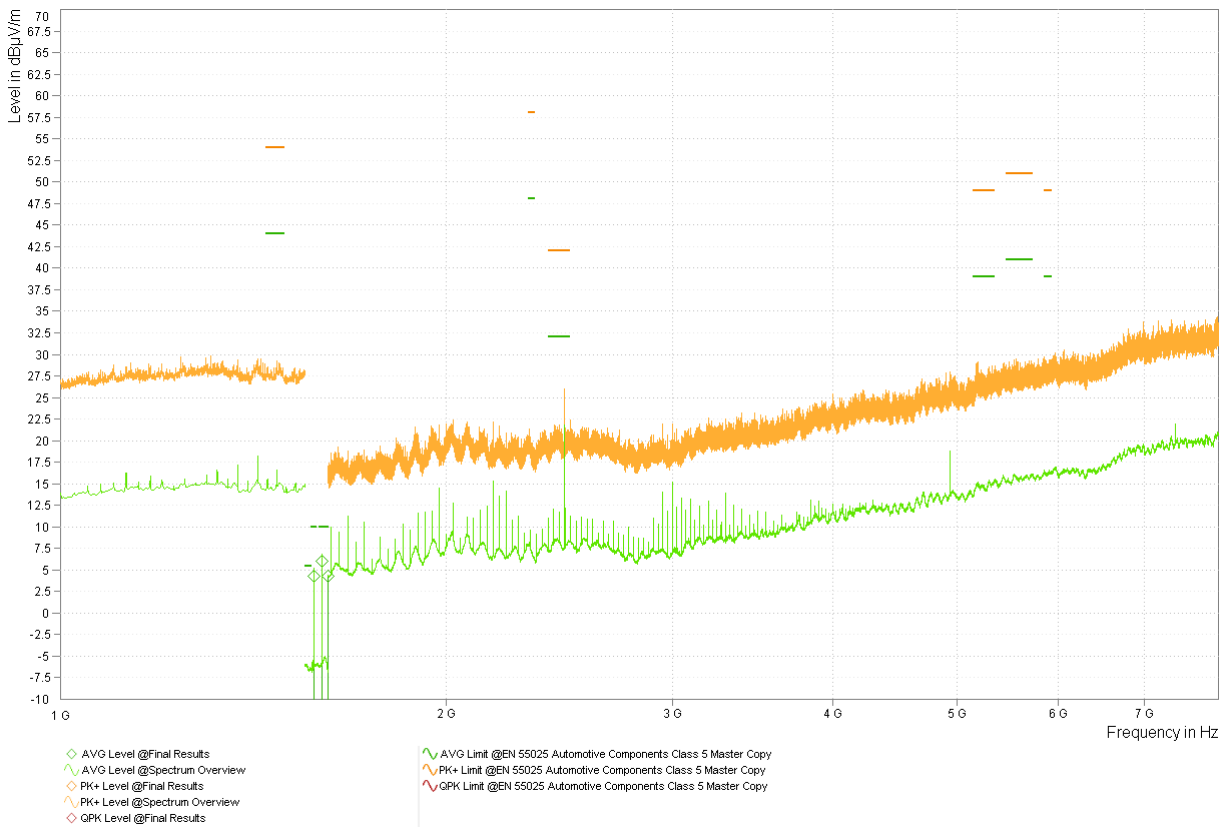

Figure 3-21. Variant 2 LMK3H0102-Q1 3.3V with -0.5% SSC Spectrum Overview - Horn

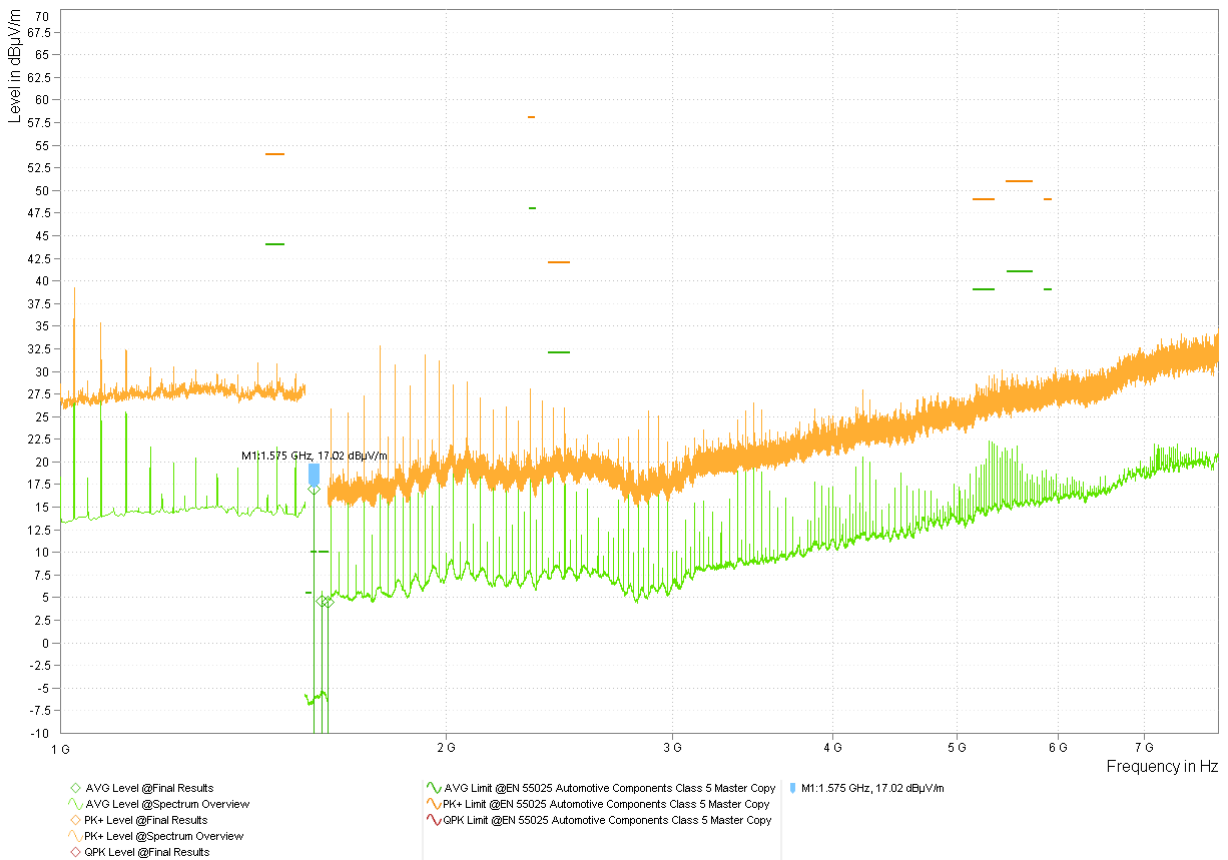

Figure 3-22. Variant 3 LMK3H0102-Q1 3.3V Spectrum Overview - Horn

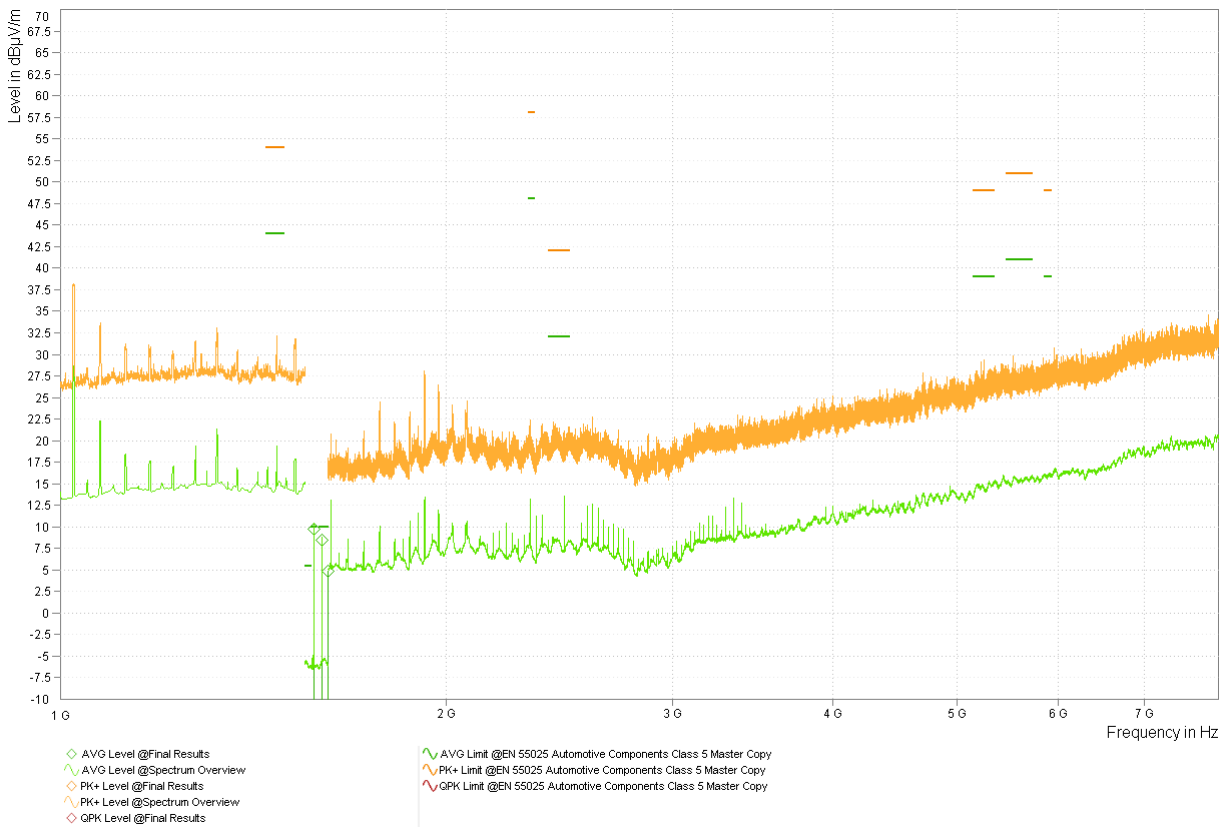
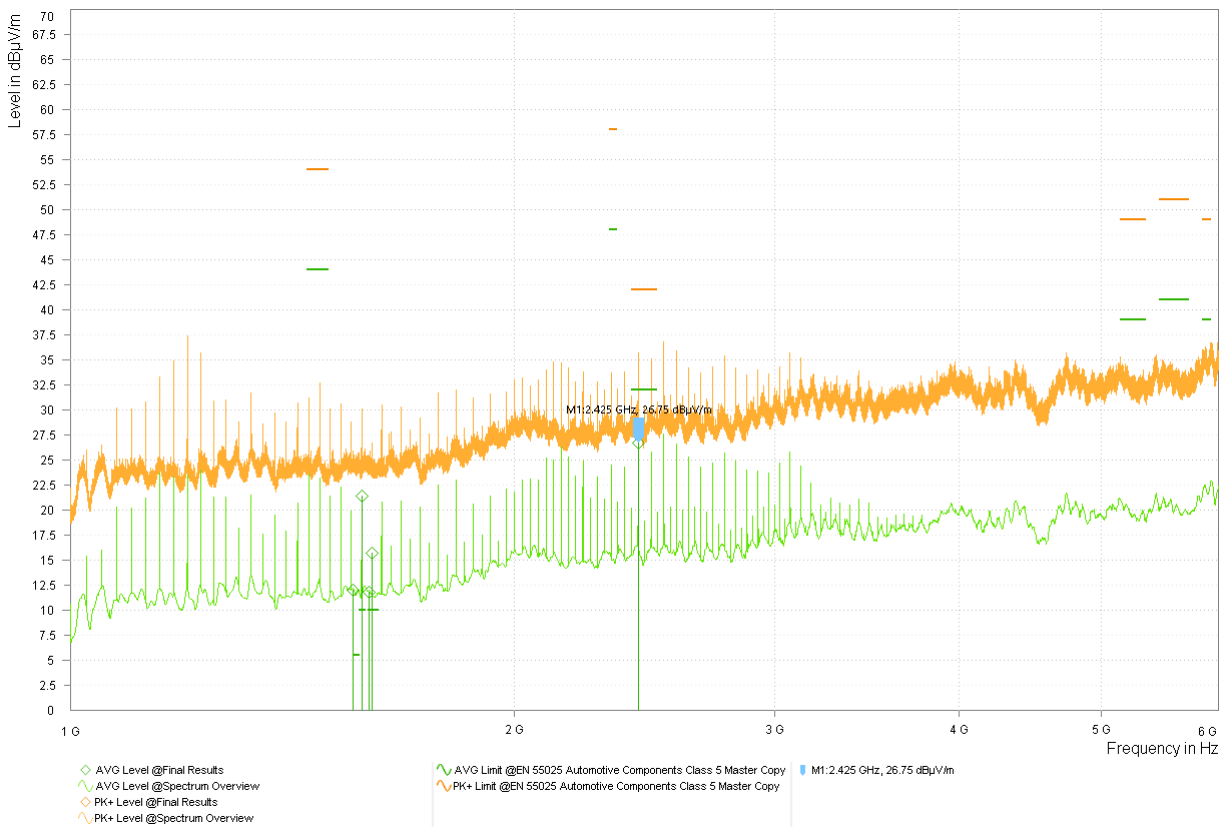

Figure 3-23. Variant 3 LMK3H0102-Q1 3.3V with -0.5% Spectrum Overview - Horn



Note

The 1.5GHz to 1.6GHz band did not have the proper measurement settings in the above capture. See following for corrected measurement of this band.

Figure 3-24. Variant 4 Competitor Oscillator 3.3V Spectrum Overview - Horn



Figure 3-25. Variant 4 Competitor Oscillator 3.3V 1.5GHz to 1.6GHz Band Spectrum Overview - Horn

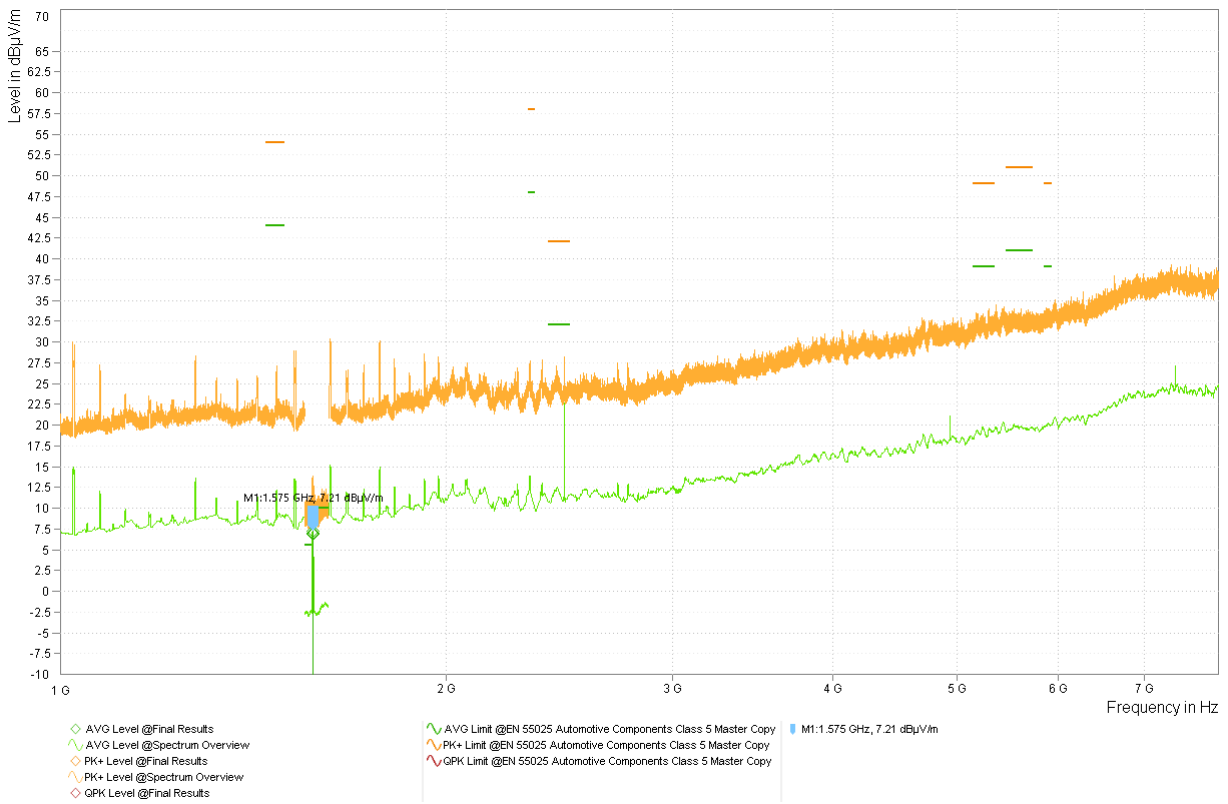

Figure 3-26. Variant 3 LMK3H0102-Q1 1.8V with -0.5% SSC Spectrum Overview - Horn

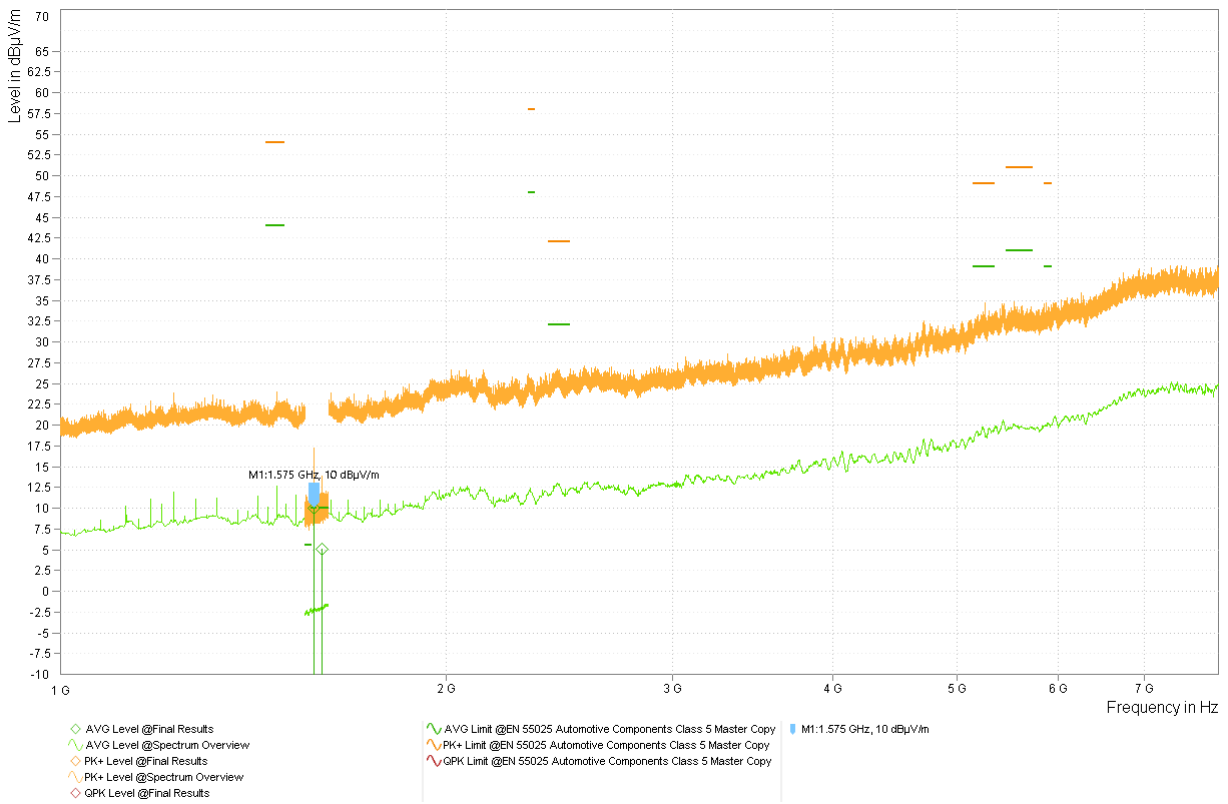

Figure 3-27. Variant 4 Competitor Oscillator 1.8V Spectrum Overview - Horn

4 CISPR-32

CISPR-32 is the Industrial standard for EMI. One JB3 antenna is used to cover the 30MHz to 3GHz range for the X, Y, and Z axes.

Note

New CISPR-32 standards require measurements up to 6GHz. These measurements are scheduled to be taken at a later date.

CISPR-32 limits are defined by certification class, with Class A being the least stringent, and Class B being the most stringent. All limits specified in this test report are Class B.

Limits for maximum allowed EMI impact are specific to individual frequency bands. For example, 30MHz to 230MHz has a Class B Quasi-Peak limit of 40dBuV/m, and a Class A limit of 50dBuV/m.



Figure 4-1. CISPR-32 Test Chamber Setup

4.1 CISPR-32 Summary

The LMK3H0102-Q1 performed similarly to XOs across all frequency bands and passes CISPR-32 Class B across 30 to 3000MHz up to 12in trace length with both 1.8V and 3.3V supply voltage.

		CISPR-32 Radiation Limits (ALSE method) [dBμV/m]						3.3V			
		Class B			Class A			Highest Passing Class for CISPR-32			
Frequency (MHz)	Antenna	Peak	Quasi-Peak	Average	Peak	Quasi-Peak	Average	LMK3H0102 Variant 1	LMK3H0102 Variant 2	LMK3H0102 Variant 3	Competitor XO Variant 4
30 to 230	JB3	-	40	-	-	50	-	Class B	Class B	Class B	Class B
230 to 1000	JB3	-	47	-	-	57	-	Class B	Class B	Class B	Class B
1000 to 3000	JB3	70	-	50	76	-	56	Class B	Class B	Class B	Class B

Figure 4-2. CISPR-32 - 3.3V Supply - Summary Table

		CISPR-32 Radiation Limits (ALSE method) [dBμV/m]						1.8V			
		Class B			Class A			Highest Passing Class for CISPR-32			
Frequency (MHz)	Antenna	Peak	Quasi-Peak	Average	Peak	Quasi-Peak	Average	LMK3H0102 Variant 1	LMK3H0102 Variant 2	LMK3H0102 Variant 3	Competitor XO Variant 4
30 to 230	JB3	-	40	-	-	50	-	Class B	Class B	Class B	Class B
230 to 1000	JB3	-	47	-	-	57	-	Class B	Class B	Class B	Class B
1000 to 3000	JB3	70	-	50	76	-	56	Class B	Class B	Class B	Class B

Figure 4-3. CISPR-32 - 1.8V Supply - Summary Table

4.2 CISPR-32 Results

Note

Spectrum Overview plots represent both horizontal and vertical measurements

Table 4-1. Board Variation Summary Table

Board Variant	Device	Trace Routing	Shielding Vias	Clock Layer	Trace Length
1	LMK3H0102-Q1	Immediate Termination	No	L1	66mil
2	LMK3H0102-Q1	Immediate Branch Out	Yes (400mil spaced array)	L6	9 - 12in
3	LMK3H0102-Q1	Immediate Branch Out	No	L6	9 - 12in
4	Competitor Oscillator	Immediate Termination	No	L1	66mil

X-Axis

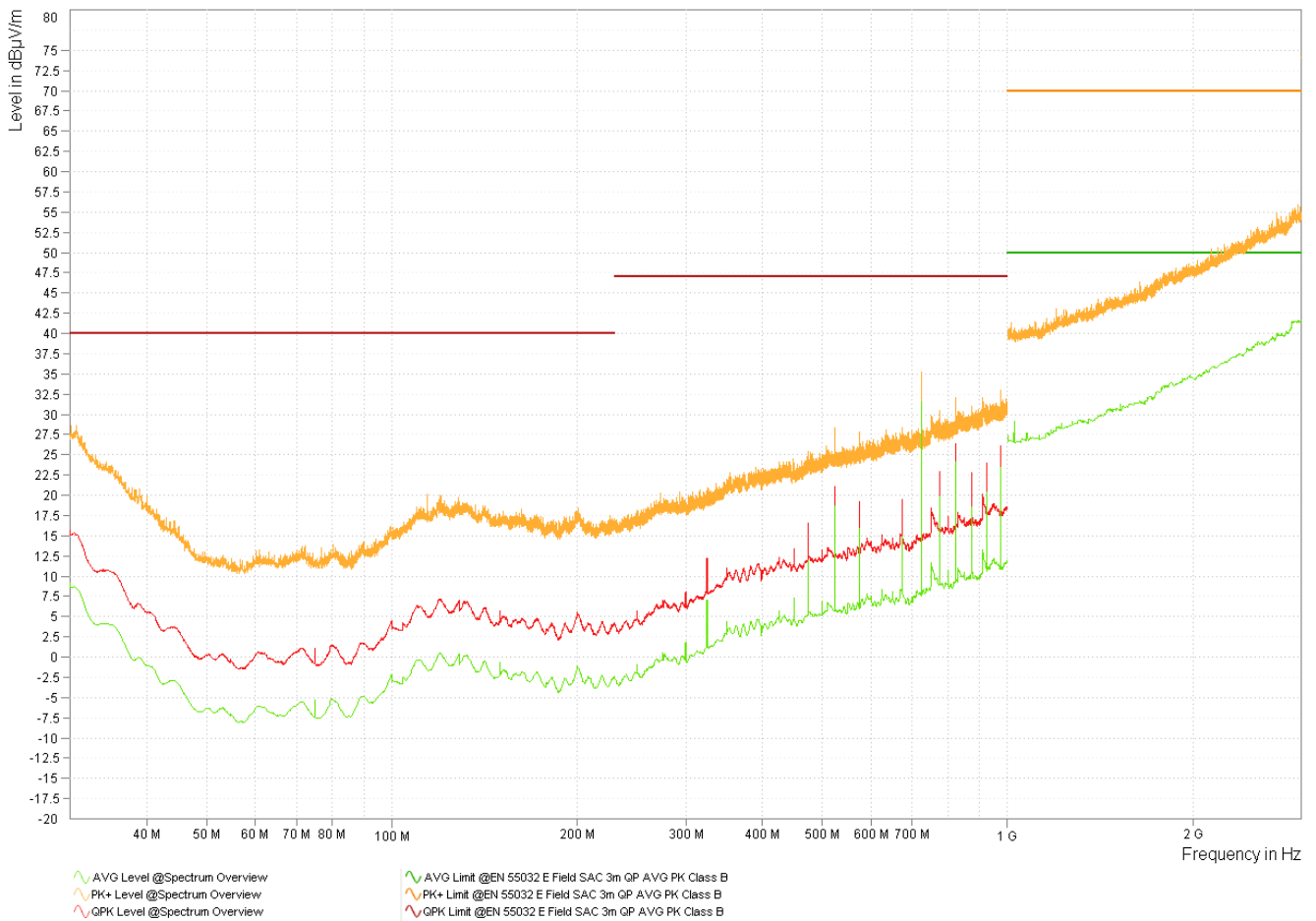

Figure 4-4. Variant 3 LMK3H0102-Q1 3.3V X-Axis Spectrum Overview

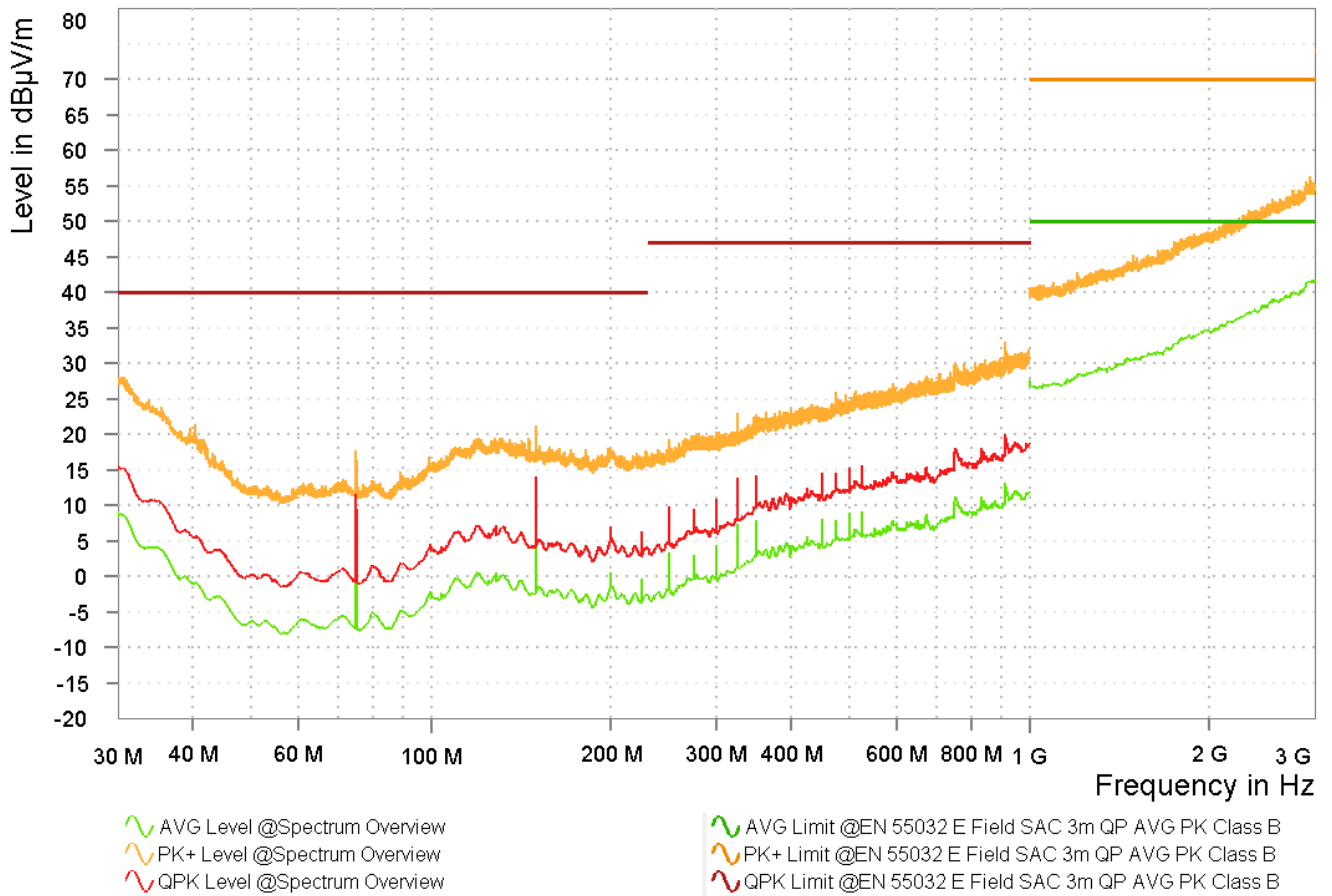

Figure 4-5. Variant 4 Competitor Oscillator 3.3V X-Axis Spectrum Overview

Y Axis

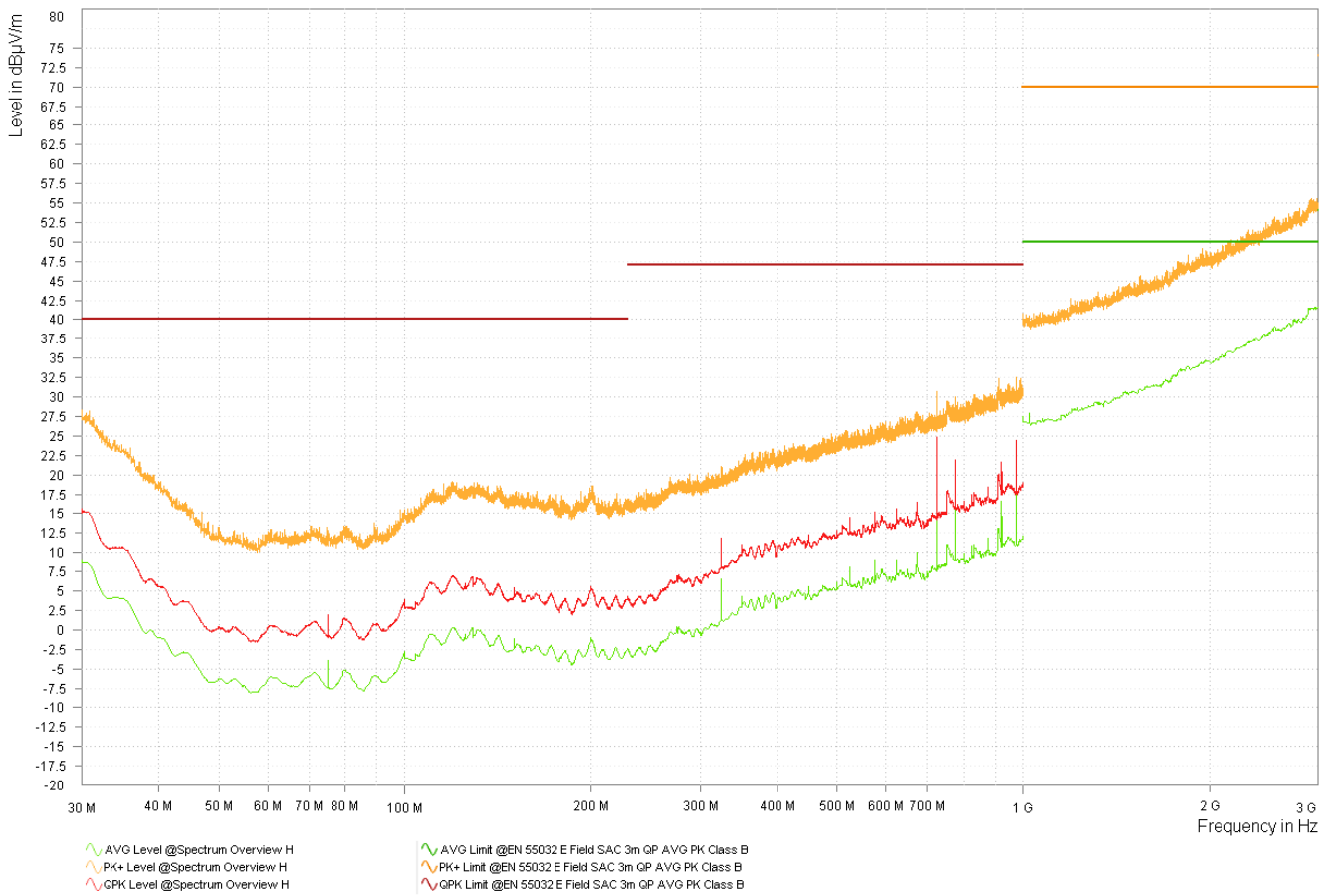

Figure 4-6. Variant 3 LMK3H0102-Q1 3.3V Y-Axis Spectrum Overview - Horizontal

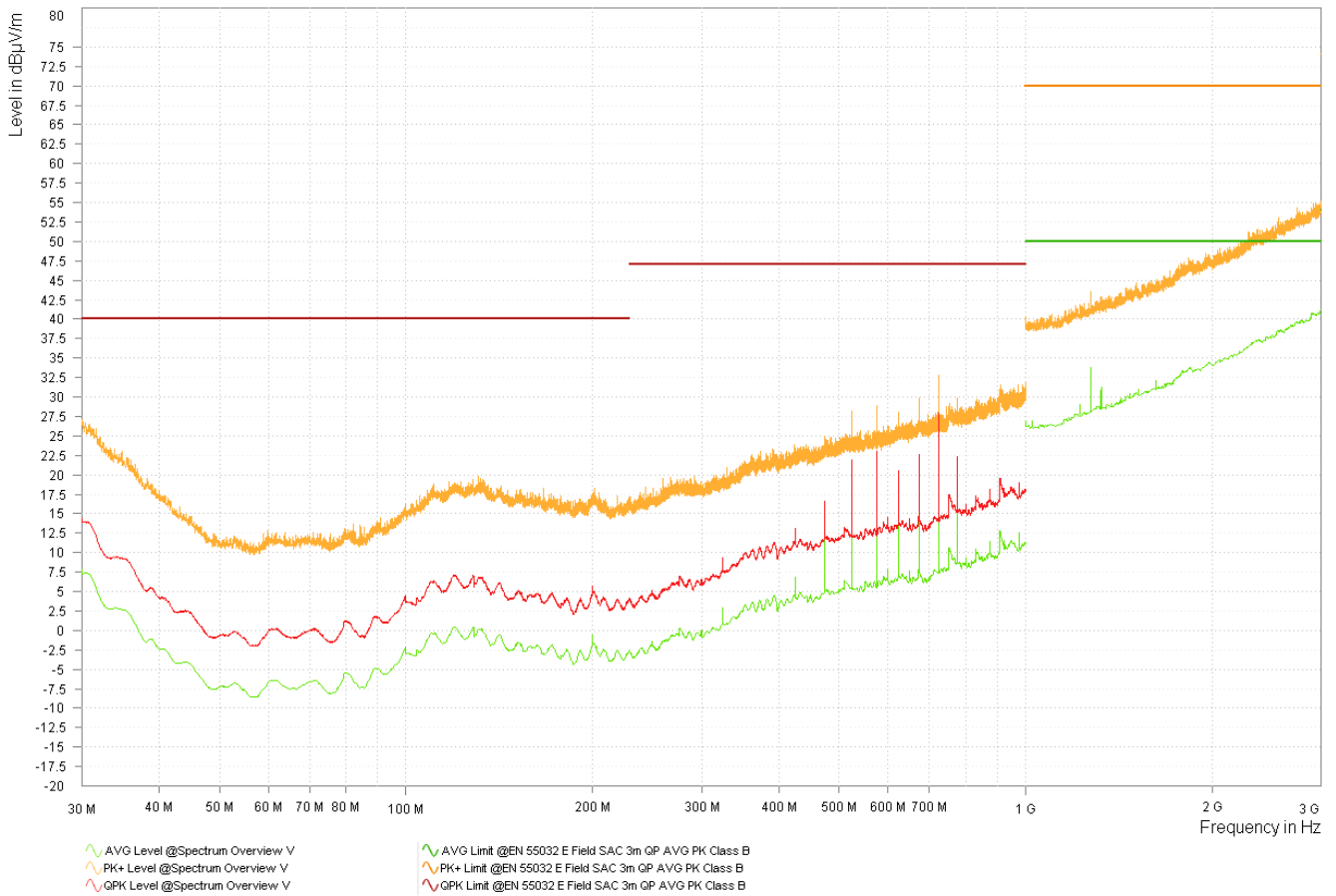

Figure 4-7. Variant 3 LMK3H0102 3.3V Y-Axis Spectrum Overview - Vertical

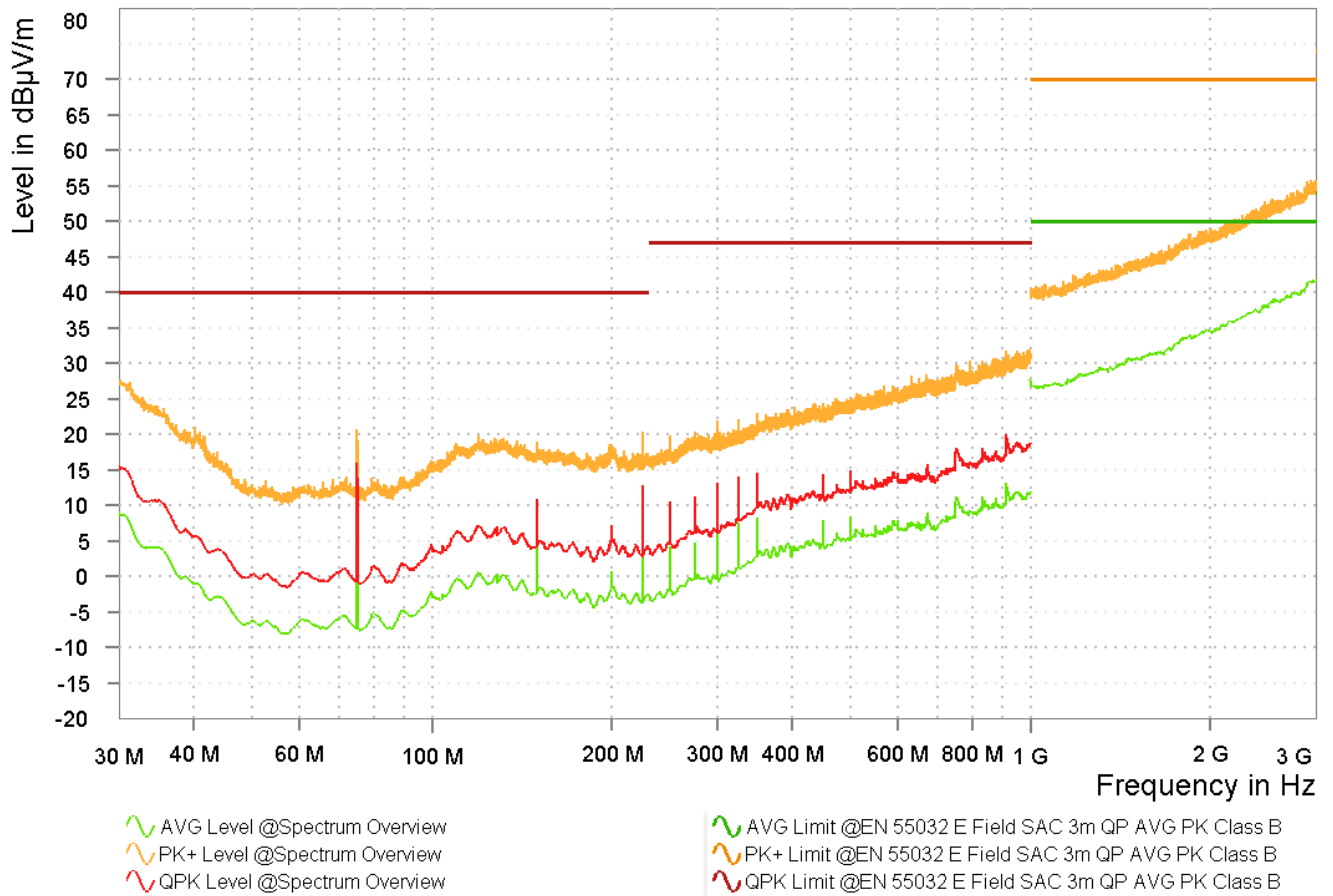

Figure 4-8. Variant 4 Competitor Oscillator 3.3V Y-Axis Spectrum Overview

Z Axis

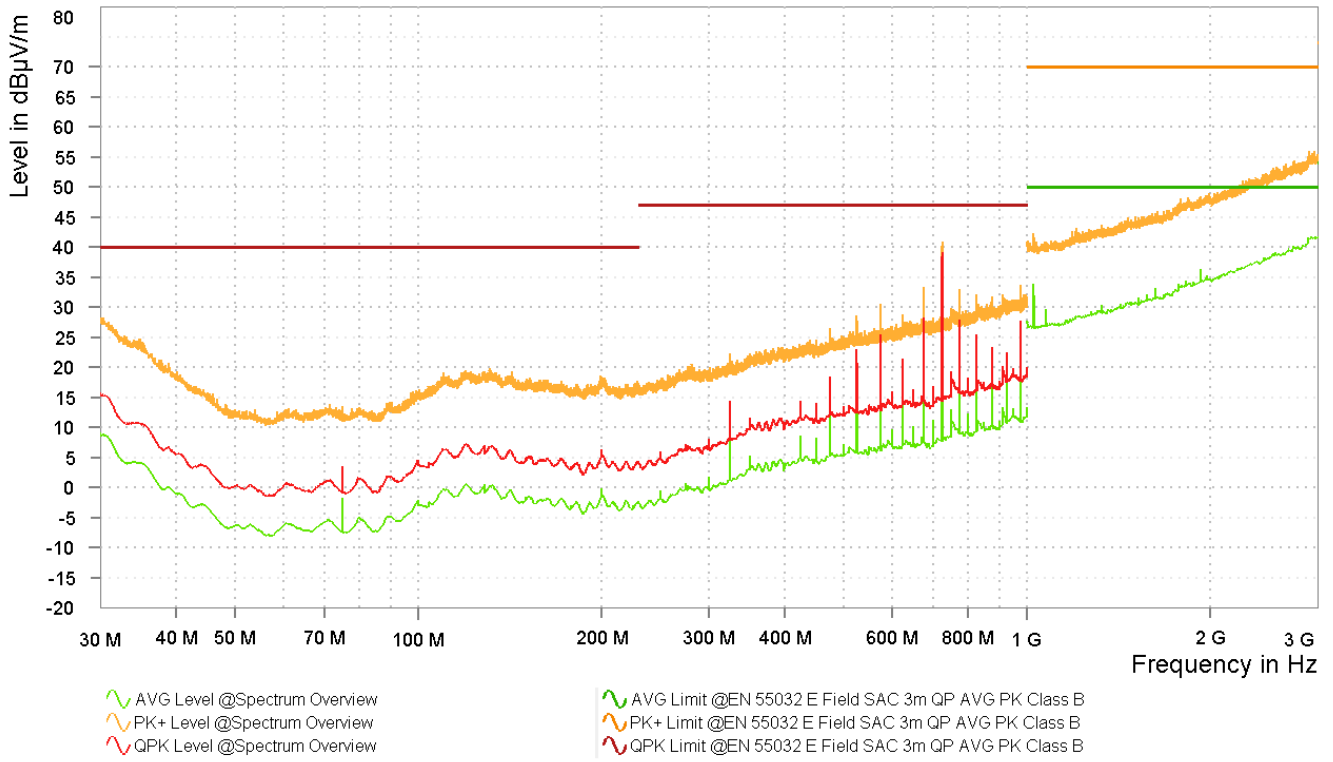

Figure 4-9. Variant 3 LMK3H0102-Q1 3.3V Z-Axis Spectrum Overview

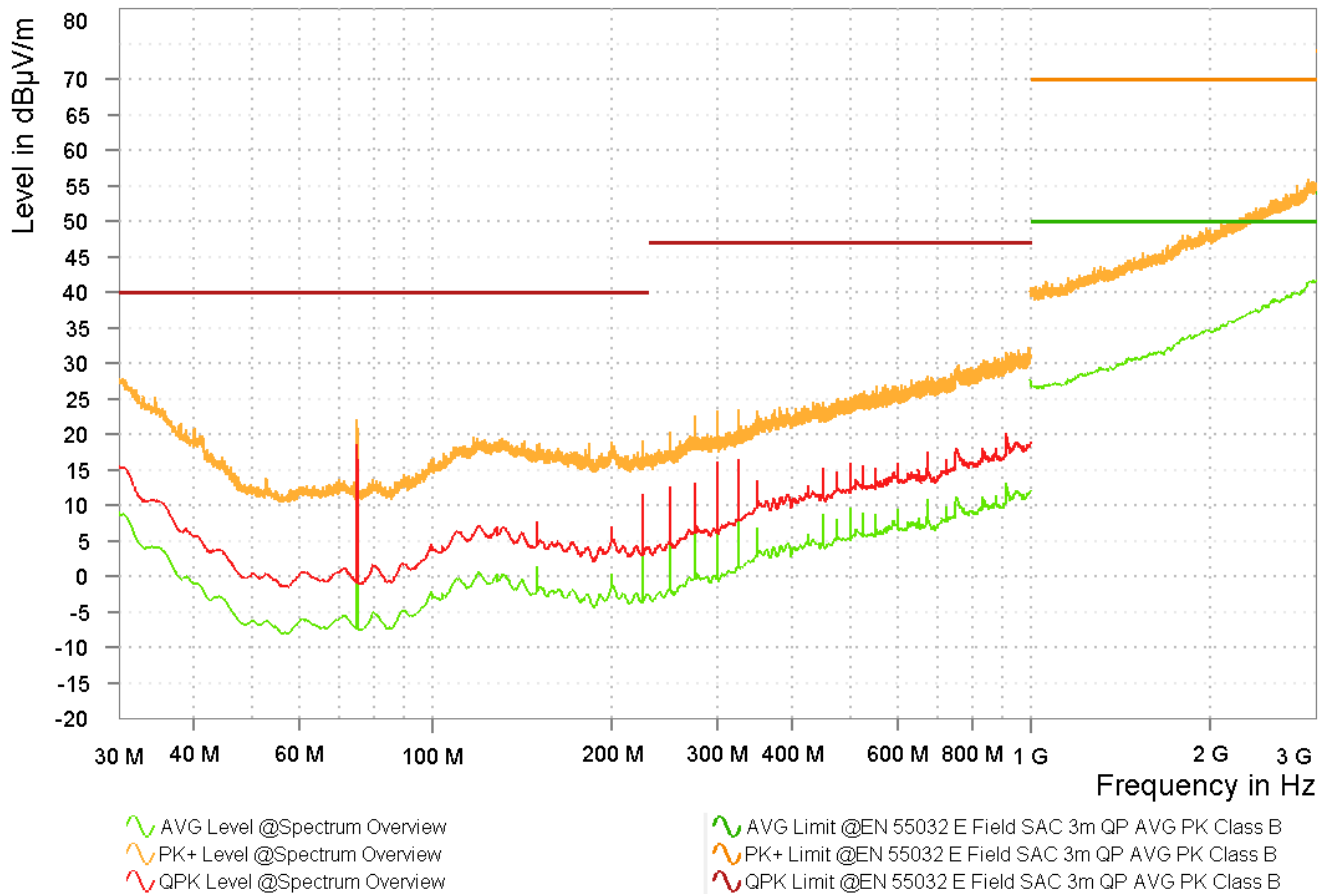

Figure 4-10. Variant 4 Competitor Oscillator 3.3V Z-Axis Spectrum Overview

Table 4-2. Competitor Oscillator vs. LMK3H0102-Q1 with 3.3V Supply - JB3 - Z-Axis

Frequency (MHz)	Competitor Oscillator (dBuV/m)	LMK3H0102-Q1 Var 3 (dBuV/m)	TI Delta
75	12.34	-1.71	-14.05
150	1.38	-1.55	-2.93
225	5.24	-3.01	-8.26
250	6.40	-0.57	-6.97
275	6.71	0	-6.72
300	9.92	1.76	-8.16
325	10.20	10.41	+0.21
350	6.76	5.13	-1.63
475	8.09	14.44	+6.35
675	10.82	26.91	+16.09
725	9.81	38.94	+29.12
775	9.66	26.33	+16.66
825	9.54	23.18	+13.63
975	11.55	25.73	+14.18

5 Summary

The following summary describes the LMK3H0102-Q1 EMI performance when outputting five 25MHz LVCMOS clocks.

Overall, Variant 2 performed best due to the additional GND vias creating a strong GND for the circuit. When designing PCBs for EMI performance, consider using common tactics such as GND vias and SSC.

CISPR-25

At 3.3V, the LMK3H0102-Q1 with no shielding vias and 8+ in trace length passes Class 5 standards for all bands except for TV Band IV (470MHz to 944MHz), Analogue UHF (380MHz to 512MHz and 820MHz to 960MHz), GPS L1 (1567.42MHz to 1583.42MHz), and GPS L5 (1156.45MHz to 1196.45MHz). For best performance, use of additional GND vias and SSC is recommended.

At 1.8V, the LMK3H0102-Q1 with no shielding vias and 8+ in trace length passes Class 5 standards for all bands except for TV Band IV, GPS L1, and GPS L5. For best performance, TI recommends using additional GND vias or SSC.

CISPR-32

The LMK3H0102-Q1 performed similarly to XOs across all frequency bands and passes CISPR-32 Class B across 30MHz to 3000MHz with no shielding vias and 8+ in trace length with both 1.8V and 3.3V supply voltage.

6 References

- International Electrotechnical Commission, [2021 CISPR-25 Standards](#)
- International Electrotechnical Commission, [2021 CISPR-32 Standards](#)
- Texas Instruments, [EMI Reduction Strategies With Clocking Devices](#), application note.

IMPORTANT NOTICE AND DISCLAIMER

TI PROVIDES TECHNICAL AND RELIABILITY DATA (INCLUDING DATA SHEETS), DESIGN RESOURCES (INCLUDING REFERENCE DESIGNS), APPLICATION OR OTHER DESIGN ADVICE, WEB TOOLS, SAFETY INFORMATION, AND OTHER RESOURCES "AS IS" AND WITH ALL FAULTS, AND DISCLAIMS ALL WARRANTIES, EXPRESS AND IMPLIED, INCLUDING WITHOUT LIMITATION ANY IMPLIED WARRANTIES OF MERCHANTABILITY, FITNESS FOR A PARTICULAR PURPOSE OR NON-INFRINGEMENT OF THIRD PARTY INTELLECTUAL PROPERTY RIGHTS.

These resources are intended for skilled developers designing with TI products. You are solely responsible for (1) selecting the appropriate TI products for your application, (2) designing, validating and testing your application, and (3) ensuring your application meets applicable standards, and any other safety, security, regulatory or other requirements.

These resources are subject to change without notice. TI grants you permission to use these resources only for development of an application that uses the TI products described in the resource. Other reproduction and display of these resources is prohibited. No license is granted to any other TI intellectual property right or to any third party intellectual property right. TI disclaims responsibility for, and you will fully indemnify TI and its representatives against, any claims, damages, costs, losses, and liabilities arising out of your use of these resources.

TI's products are provided subject to [TI's Terms of Sale](#) or other applicable terms available either on [ti.com](https://www.ti.com) or provided in conjunction with such TI products. TI's provision of these resources does not expand or otherwise alter TI's applicable warranties or warranty disclaimers for TI products.

TI objects to and rejects any additional or different terms you may have proposed.

Mailing Address: Texas Instruments, Post Office Box 655303, Dallas, Texas 75265

Copyright © 2025, Texas Instruments Incorporated