

# 1.8 V Logic for Muxes and Signal Switches



A common need of any system is controlling multiple devices through digital logic. Systems continue to move to lower voltage nodes for power savings. With this trend, using devices that are not natively compatible with the control logic of the system can lead to extra system costs through board size and BOM count. Also, the use of more components in the design of the system creates more opportunities for power sequencing issues. Using devices that have integrated support for the control logic of the system achieves a cost effective solution.

To prevent digital logic control issues, the system must ensure that the output high ( $V_{OH}$ ) logic output is higher than the input high ( $V_{IH}$ ) logic input it is controlling. In addition, the output low ( $V_{OL}$ ) of the logic output must be lower than the input low ( $V_{IL}$ ) of the logic input it is controlling. See Figure 1 for this logic standard. Some components may not meet the standard, but having  $V_{IH} < V_{OH}$  and  $V_{IL} > V_{OL}$  ensures proper system operation.

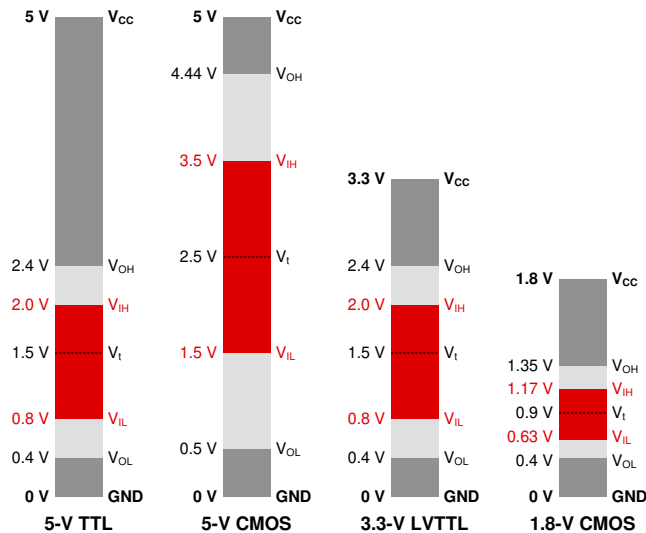

Figure 1. Logic Thresholds

If a processor on a 1.8 V voltage rail is controlling a signal switch with a supply rail of 3.3 V without integrated 1.8 V logic capability, the system is required to use an external translator as shown in Figure 2 or a translator. The voltage domain translation is necessary because the  $V_{IH}$  for a 3.3 V device is higher than the  $V_{OH}$  of a 1.8 V processor that is controlling the device.

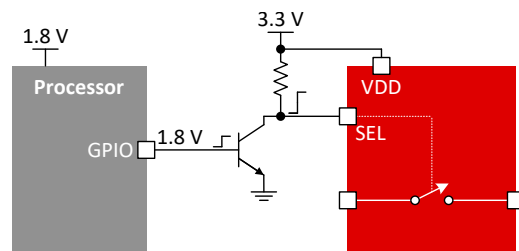

Figure 2. Discrete BJT Translator

### Example Application

In Figure 3, an 8 to 1 MUX expands the sensors being sampled by an ADC. Without 1.8 V logic, a 12 pin (4 bit) translator is required in between the processor and the MUX. By adding a 4 bit translator to an 8:1 MUX the board area for the MUX is increased by more than 25%.

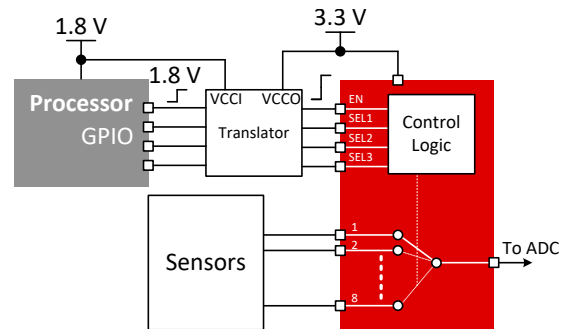
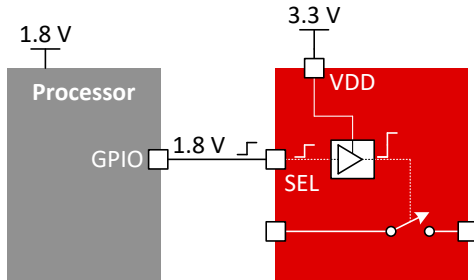

Figure 3. 8:1 MUX Without 1.8 V Logic

By choosing a device with integrated 1.8 V logic, the discrete components can be removed, see [Figure 4](#). This leads to a direct connection of the logic control from the processor to the device even with a supply domain mismatch. Not only does this remove component cost and board space, any supply sequencing requirements associated with the translator are also removed from the system operation requirements.



**Figure 4. MUX/Switch With Integrated 1.8 V Logic**

### Different Forms of 1.8 V Logic and Their Tradeoffs

With 1.8 V logic there are different implementations with their own benefits and drawbacks. When the input to a typical CMOS logic buffer is not at the supply rail, a shoot through current can be observed from the device supply to ground. This is due to both transistors being partially on creating a path to ground, with an increase in  $I_{CC}$  as shown in [Figure 5](#). An example device is the TS5A2066 that has an input thresholds of 70% of  $V_{CC}$  for  $V_{IH}$  and 30% of  $V_{CC}$  for  $V_{IL}$  and is not 1.8 V logic compatible.

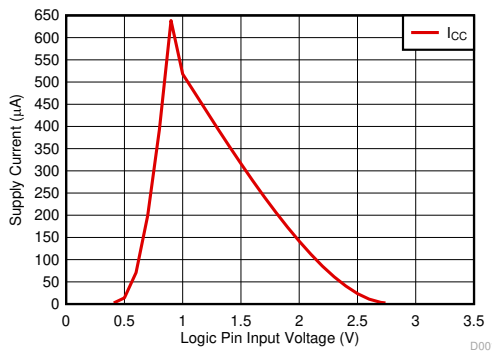
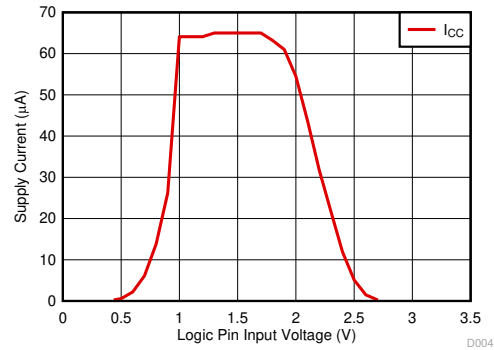

**Figure 5. 70%/30% Threshold  $I_{CC}$  Vs Logic Input Voltage**

### 1.8 V Compatible logic Inputs

With the proper implementation, 1.8 V compatible inputs can be achieved while minimizing the shoot through current observed in a standard CMOS buffer input. In [Figure 6](#), the shoot through current is remains low compared to the TS5A2066 while still operating from a 3.3 V supply. When the input voltage is at the supply rails, the  $I_{CC}$  is minimal. With this

approach the external translator is no longer needed and the low  $I_{CC}$  is maintained.



**Figure 6. 1.8 V Compatible  $I_{CC}$  Vs Logic Input Voltage**

### Fixed Logic Thresholds

The TMUX136 is a high-speed 2:1 MUX that supports fixed thresholds across the supply range for 1.8 V logic inputs. This method has little to no change in  $I_{CC}$  with change in logic input voltage as shown in [Figure 7](#). The static current consumption with this device will be higher as a trade-off.

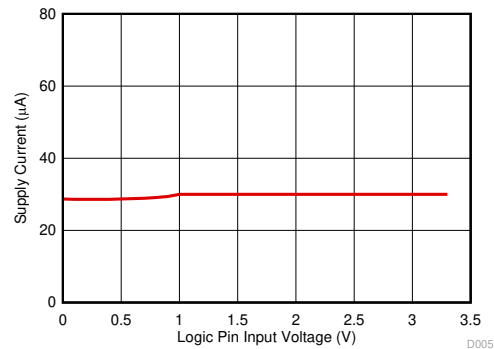

**Figure 7. Fixed Threshold  $I_{CC}$  Vs Logic Input Voltage**

### Logic Supply Input Pin

Another approach is to use the TS5A26542 with an input logic supply pin ( $V_{IO}$ ) to set the desired voltage of the input logic. Because the logic buffer is supplied by a rail that matches the input voltage, there is no shoot through current from the VCC pin as shown in [Figure 8](#) even with a 3.3 V supply (The  $I_{CC}$  for this measurement is in 10-20 nA range). There is a small shoot through current from the logic supply pin, but it is minimal. The trade-off is an extra pin is required to achieve this functionality.

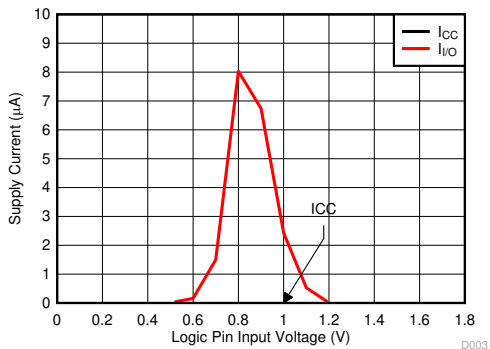

**Figure 8. Separate Logic Supply Pin  $I_{CC}$  Vs Logic Input Voltage**

**Table 1. Alternative Device Recommendations**

Device	Configuration	Key Features
<a href="#">TMUX1574</a>	4-channel 2:1	Powered-off protection, Low Con (7.5pF), Low Ron ( $2\Omega$ ), Wide bandwidth (2GHz), <a href="#">1.8V Logic Compatible</a>
<a href="#">TMUX1575</a>	4-channel 2:1	1.3 mm x 1.3 mm package, 1.2-V compatible control inputs, Powered-off protection, Low Con (10 pF), Low Ron ( $1.7\Omega$ ), 1.8 GHz Bandwidth.
<a href="#">TMUX1511</a>	4-channel 1:1	Powered-off protection, Low Con (3.3pF), Low Ron ( $2\Omega$ ), Wide bandwidth (3GHz), <a href="#">1.8V Logic Compatible</a>
<a href="#">TS3A27518E</a>	6-channel 2:1	Powered-off protection, 1.8-V compatible control inputs
<a href="#">TMUX1308</a>	1-channel 8:1	1.8-V compatible control inputs, Injection current control

**Trademarks**

All trademarks are the property of their respective owners.

## IMPORTANT NOTICE AND DISCLAIMER

TI PROVIDES TECHNICAL AND RELIABILITY DATA (INCLUDING DATASHEETS), DESIGN RESOURCES (INCLUDING REFERENCE DESIGNS), APPLICATION OR OTHER DESIGN ADVICE, WEB TOOLS, SAFETY INFORMATION, AND OTHER RESOURCES "AS IS" AND WITH ALL FAULTS, AND DISCLAIMS ALL WARRANTIES, EXPRESS AND IMPLIED, INCLUDING WITHOUT LIMITATION ANY IMPLIED WARRANTIES OF MERCHANTABILITY, FITNESS FOR A PARTICULAR PURPOSE OR NON-INFRINGEMENT OF THIRD PARTY INTELLECTUAL PROPERTY RIGHTS.

These resources are intended for skilled developers designing with TI products. You are solely responsible for (1) selecting the appropriate TI products for your application, (2) designing, validating and testing your application, and (3) ensuring your application meets applicable standards, and any other safety, security, or other requirements. These resources are subject to change without notice. TI grants you permission to use these resources only for development of an application that uses the TI products described in the resource. Other reproduction and display of these resources is prohibited. No license is granted to any other TI intellectual property right or to any third party intellectual property right. TI disclaims responsibility for, and you will fully indemnify TI and its representatives against, any claims, damages, costs, losses, and liabilities arising out of your use of these resources.

TI's products are provided subject to TI's Terms of Sale (<https://www.ti.com/legal/termsofsale.html>) or other applicable terms available either on [ti.com](https://www.ti.com) or provided in conjunction with such TI products. TI's provision of these resources does not expand or otherwise alter TI's applicable warranties or warranty disclaimers for TI products.

Mailing Address: Texas Instruments, Post Office Box 655303, Dallas, Texas 75265  
Copyright © 2021, Texas Instruments Incorporated