

Transimpedance amplifier circuit with MSP430™ smart analog combo

Design Goals

Input		Output		BW	Supply	
I_{iMin}	I_{iMax}	V_{oMin}	V_{oMax}	f_p	V_{cc}	V_{ee}
0 A	30 μ A	0.2 V	3.2 V	10 kHz	3.3V	0 V

Design Description

Some MSP430™ microcontrollers (MCUs) contain configurable integrated signal chain elements such as op-amps, DACs, and programmable gain stages. These elements make up a peripheral called the smart analog combo (SAC). For information on the different types of SACs and how to leverage their configurable analog signal chain capabilities, visit [MSP430 MCUs Smart Analog Combo Training](#). To get started with your design, download the [MSP430 Transimpedance Amplifier Circuit Design Files](#).

The transimpedance op amp circuit configuration converts an input current source into an output voltage. The current to voltage gain is based on the feedback resistance. The circuit can maintain a constant voltage bias across the input source as the input current changes, which benefits many sensors. The characteristics of the Transimpedance Amplifier (TIA) module in [MSP430FR2311](#) make it especially suited for this functionality; however, this circuit can also be implemented with the [MSP430FR2311](#) SAC_L1, or with the [MSP430FR2355](#) SAC_L3 with additional built-in DAC and PGA capabilities. The output of these integrated amplifiers can be sampled directly by the on-board ADC or monitored by the on-board comparator for further processing inside the MCU.

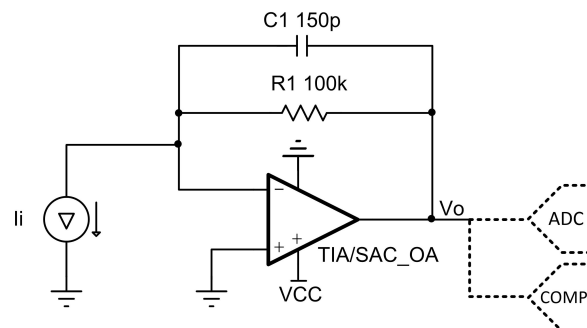

Design Notes

- An op amp with low input bias current reduces DC errors.
- A bias voltage can be added to the non-inverting input to set the output voltage for 0-A input currents. The integrated 12-bit DAC in MSP430FR2355 SAC_L3 can be used for this purpose.
- Operate within the linear output voltage swing (see A_{ol} specification) to minimize non-linearity errors.
- If the solution is implemented with the MSP430FR2311, this circuit can be realized by the TransImpedance Amplifier (TIA) module, or by the SAC_L1.
- If the solution is implemented with the MSP430FR2355 SAC_L3, the op-amp should be configured in general-purpose mode.
- The [MSP430 Transimpedance Amplifier Circuit Design Files](#) include code examples showing how to properly initialize the peripherals.

Design Steps

1. Select the gain resistor.

$$R_1 = \frac{V_{oMax} - V_{oMin}}{I_{iMax}} = \frac{3.2V - 0.2V}{30\mu A} = 100k\Omega$$

2. Select the feedback capacitor to meet the circuit bandwidth.

$$C_1 \leq \frac{1}{2 \times \pi \times R_1 \times f_p}$$

$$C_1 \leq \frac{1}{2 \times \pi \times 100k\Omega \times 10kHz} \leq 159pF \approx 150pF \text{ (Standard Value)}$$

3. Calculate the necessary op amp gain bandwidth (GBW) for the circuit to be stable.

$$GBW > \frac{C_{in} + C_1}{2 \times \pi \times R_1 \times C_1^2} > \frac{7pF + 150pF}{2 \times \pi \times 100k\Omega \times (150pF)^2} > 11.10kHz$$

Design Simulations

DC Simulation Results

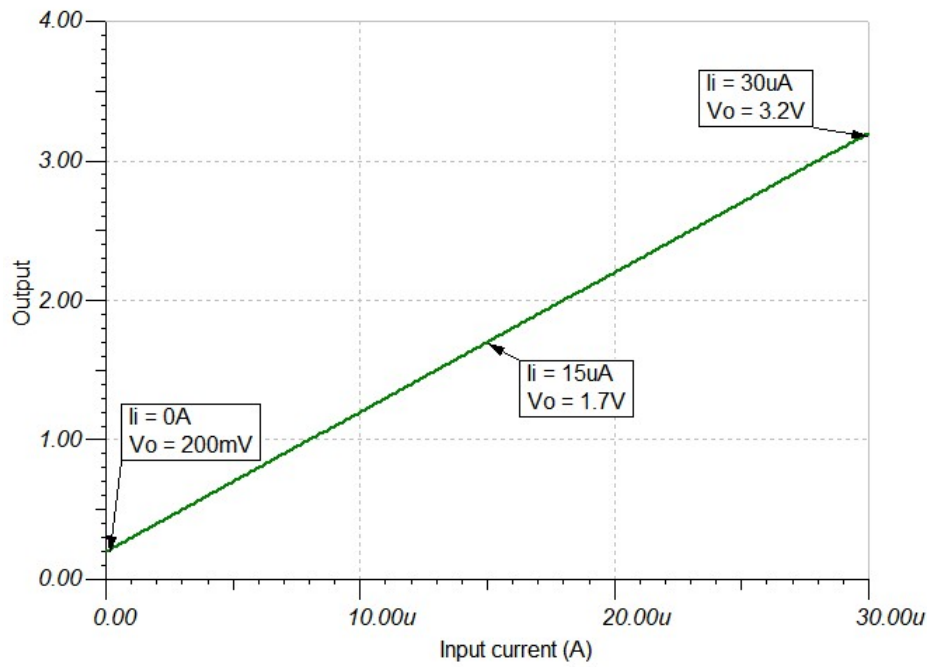

AC Simulation Results

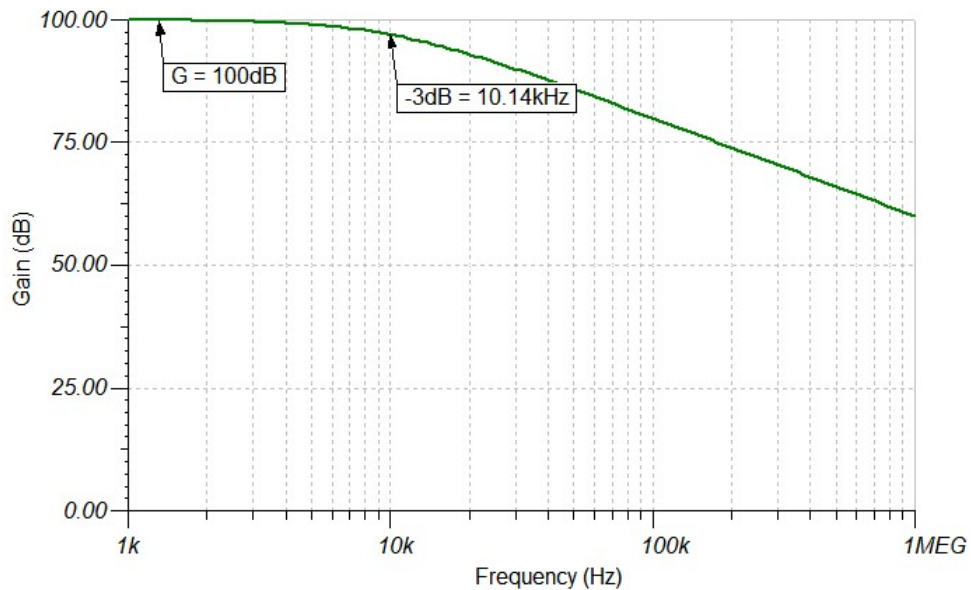

Target Applications

- [Smoke and Heat Detectors](#)
- [Air Quality and Gas Detection](#)
- [Gas Detectors](#)
- [Motion Detectors](#)
- [Pulse Oximeters](#)
- [Blood Glucose Monitors](#)

Design References

1. [MSP430 Transimpedance Amplifier Circuit Code Examples and SPICE Simulation Files](#)
2. [Analog Engineer's Circuit Cookbooks](#)
3. [MSP430FR2311 TINA-TI Spice Model](#)
4. [MSP430 MCUs Smart Analog Combo Training](#)





Design Featured Op Amp

MSP430FR2311 Transimpedance Amplifier	
V_{CC}	2.0 V to 3.6 V
V_{CM}	-0.1 V to $V_{CC}/2$ V
V_{out}	Rail-to-rail
V_{os}	± 5 mV
A_{OL}	100 dB
I_q	350 μ A (high-speed mode)
	120 μ A (low-power mode)
I_b	5 pA (TSSOP-16 with OA-dedicated pin input)
	50 pA (TSSOP-20 and VQFN-16)
UGBW	5 MHz (high-speed mode)
	1.8 MHz (low-power mode)
SR	4 V/ μ s (high-speed mode)
	1 V/ μ s (low-power mode)
Number of channels	1
http://www.ti.com/product/MSP430FR2311	

Design Alternate Op Amp

MSP430FRxx Smart Analog Combo		
	MSP430FR2311 SAC_L1	MSP430FR2355 SAC_L3
V_{CC}	2.0 V to 3.6 V	
V_{CM}	-0.1 V to $V_{CC} + 0.1$ V	
V_{out}	Rail-to-rail	
V_{os}	± 5 mV	
A_{OL}	100 dB	
I_q	350 μ A (high-speed mode)	
	120 μ A (low-power mode)	
I_b	50 pA	
UGBW	4 MHz (high-speed mode)	2.8 MHz (high-speed mode)
	1.4 MHz (low-power mode)	1 MHz (low-power mode)
SR	3 V/ μ s (high-speed mode)	
	1 V/ μ s (low-power mode)	
Number of channels	1	4
http://www.ti.com/product/MSP430FR2311		
http://www.ti.com/product/MSP430FR2355		

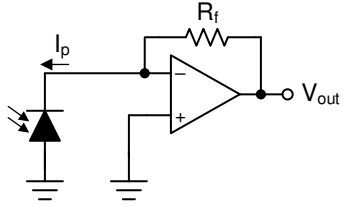
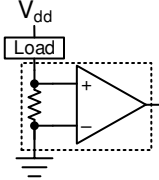
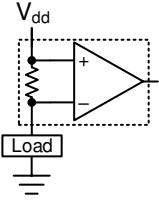
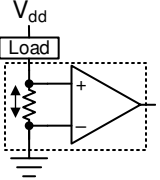
Related MSP430 Circuits

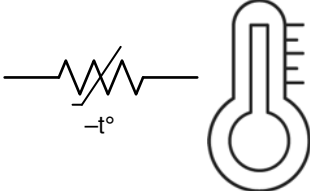
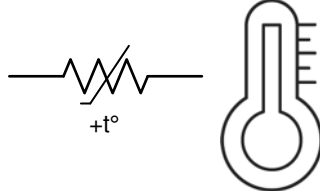
<p>Low-noise and long-range PIR sensor conditioner circuit</p> 	<p>Bridge amplifier circuit</p> 	<p>Transimpedance amplifier circuit</p> 
<p>Single-supply, low-side, unidirectional current-sensing circuit</p> 	<p>High-side current sensing with discrete difference amplifier circuit</p> 	<p>Low-side, bidirectional current-sensing circuit</p> 
<p>Half-wave rectifier circuit</p> 	<p>Temperature sensing with NTC thermistor circuit</p> 	<p>Temperature sensing with PTC thermistor circuit</p> 

Revision History

NOTE: Page numbers for previous revisions may differ from page numbers in the current version.

Changes from December 13, 2019 to March 6, 2020	Page
• Added <i>Related MSP430 Circuits</i> section.....	5

IMPORTANT NOTICE AND DISCLAIMER

TI PROVIDES TECHNICAL AND RELIABILITY DATA (INCLUDING DATASHEETS), DESIGN RESOURCES (INCLUDING REFERENCE DESIGNS), APPLICATION OR OTHER DESIGN ADVICE, WEB TOOLS, SAFETY INFORMATION, AND OTHER RESOURCES "AS IS" AND WITH ALL FAULTS, AND DISCLAIMS ALL WARRANTIES, EXPRESS AND IMPLIED, INCLUDING WITHOUT LIMITATION ANY IMPLIED WARRANTIES OF MERCHANTABILITY, FITNESS FOR A PARTICULAR PURPOSE OR NON-INFRINGEMENT OF THIRD PARTY INTELLECTUAL PROPERTY RIGHTS.

These resources are intended for skilled developers designing with TI products. You are solely responsible for (1) selecting the appropriate TI products for your application, (2) designing, validating and testing your application, and (3) ensuring your application meets applicable standards, and any other safety, security, or other requirements. These resources are subject to change without notice. TI grants you permission to use these resources only for development of an application that uses the TI products described in the resource. Other reproduction and display of these resources is prohibited. No license is granted to any other TI intellectual property right or to any third party intellectual property right. TI disclaims responsibility for, and you will fully indemnify TI and its representatives against, any claims, damages, costs, losses, and liabilities arising out of your use of these resources.

TI's products are provided subject to TI's Terms of Sale (www.ti.com/legal/termsofsale.html) or other applicable terms available either on ti.com or provided in conjunction with such TI products. TI's provision of these resources does not expand or otherwise alter TI's applicable warranties or warranty disclaimers for TI products.

Mailing Address: Texas Instruments, Post Office Box 655303, Dallas, Texas 75265
Copyright © 2020, Texas Instruments Incorporated