

10 MHz Butterworth Filter Using the Operational Amplifier THS4001

Dirk Gehrke and Andreas Hahn

MSLP/AAP

ABSTRACT

This application report describes the design of an active 10MHz second-order Butterworth low-pass filter useful for band-limiting applications. As an active component, TI's operational amplifier type THS4001, which has a bandwidth of 300 MHz, was used.

The design of the filter described in this report is typical of practical applications, and the steps involved in calculating component values can be completed easily. This filter has the following features:

- The component values are easily calculated.
 - It is a second-order filter.
 - It has an attenuation of 40 dB/decade (12 dB/octave).
 - The amplitude frequency response is linear up to the cutoff frequency.
-

Contents

1	Introduction	3
2	The Basic Theory of Low-Pass Filters	3
3	The Correct Choice of a Filter Type	4
4	Low-Pass First-Order RC Filter	5
5	Filter Orders	6
6	Filters of Higher Order	6
7	Pole Quality Q of an Active Filter	7
8	Filters With Simple Coupling	7
9	Calculation of Filter Component Values	9
10	Printed Circuit Board	13
11	Summary	13
	References	14

List of Figures

1	The Amplitude Response With Frequency and Limits of a Low-Pass Filter	3
2	Amplitude Frequency Response for Fifth-Order Filters	4
3	RC Network Used as a Low-Pass Filter	5
4	Active Low-Pass Filter of Second-Order With Simple Positive Feedback	8
5	Amplitude and Phase Response of the Filter With $R_1, R_2 = 1 \text{ k}\Omega$	10
6	Amplitude and Phase Response of the Filter With R_1 and $R_2 = 910\Omega$	11
7	Passive Circuit Around the THS4001	12
8	Frequency Responses of Passive Circuit	12
9	Circuit Board Layout and Component Placement Plan	13

List of Tables

1	Filter Coefficients for 3 dB Cutoff Frequency	7
2	Component Values That Result for the Low-Pass Filter	10
3	Modified Values of the Components for a Cut-Off Frequency of 10 MHz	11

1 Introduction

Texas Instruments produces a variety of operational amplifier products for high-frequency applications. The operational amplifiers that are now available attain much greater bandwidths than previous models and allow the design of circuits that take full account of more demanding requirements. SMD components and smaller semiconductor packages make it easier to meet requirements for more compact applications with improved performance.

Although digital circuits play a dominant role, analog components remain important in a variety of systems because they are essential for signal conditioning and processing in many circuits. Special low-pass filters are commonly needed in such cases. Analog filter circuits are usually designed with passive components (R,L,C), or they are constructed in combination with active components, such as operational amplifiers and transistors.

2 The Basic Theory of Low-Pass Filters

An electronic filter can be considered as a network. This network changes the signal amplitude and phase as a function of the frequency, and no new frequency components are added to the signal. An ideal low-pass filter must attenuate all signals 100% which are higher than the cutoff frequency (f_g), and the signal response must be linear up to the cutoff frequency. From the stop frequency (f_s), a specified attenuation must not be exceeded. In practice, however, the ideal cannot be attained; compromises must always be reached.

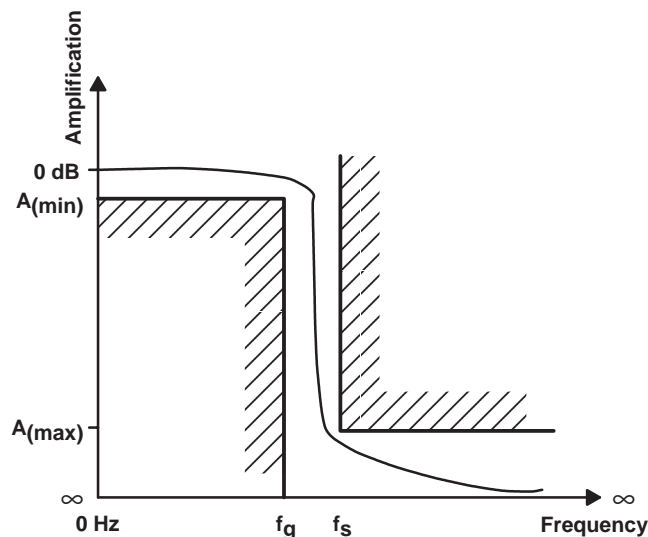

Figure 1. The Amplitude Response With Frequency and Limits of a Low-Pass Filter

A wide variety of filter types is available, each characterized by different properties. For every application requirement, a particular type of filter fulfills the requirements specific to the application. The three most important types of filters are the Butterworth low-pass filter, the Tschebyscheff low-pass filter, and a Bessel low-pass filter.

A Butterworth low-pass filter features a horizontal amplitude frequency response that changes direction abruptly at the cutoff frequency, depending on the order number. However, the square pulse response of this filter shows a considerable overshoot when compared to the Bessel filter. This increases with increasing filter order.

With a Tschebyscheff low-pass filter, the reduction of the amplification is even more pronounced than with the Butterworth low-pass filter. The amplitude frequency response within the pass band is not monotone, but instead contains ripples of constant amplitude. The higher the permissible ripple for the filter order used, the greater is the reduction in the amplification above the cutoff frequency.

In a Bessel low-pass filter, the amplitude frequency response does not change direction as abruptly as with the Butterworth and Tschebyscheff low-pass filters. However, this filter has an optimum square-wave response.

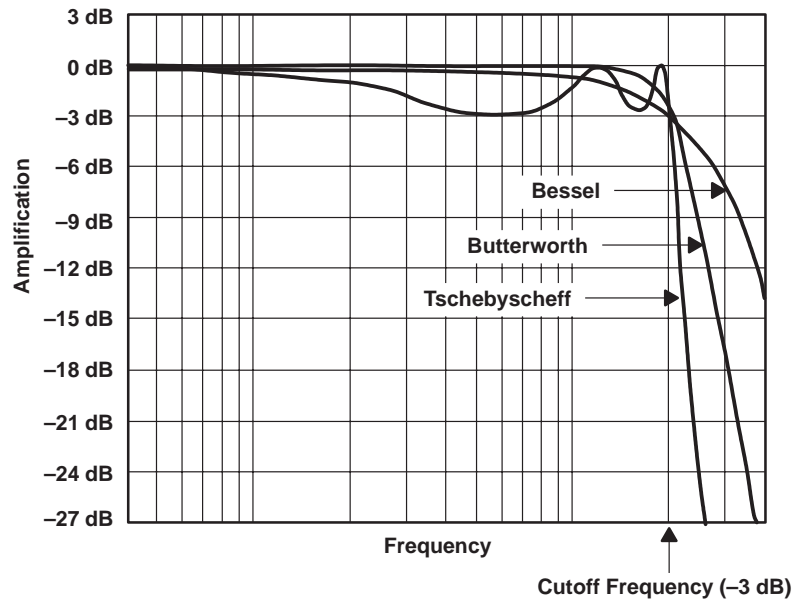

Figure 2. Amplitude Frequency Response for Fifth-Order Filters

3 The Correct Choice of a Filter Type

The most important consideration in choosing a filter type is the intended use of the filter. For example, if the requirement is to attain optimum behavior with square-wave signals, together with good frequency limiting, then the Bessel low-pass filter is the logical choice. This filter provides the least overshoot as a response to transients, when compared with Tschebyscheff or Butterworth low-pass filters. The disadvantage of this filter is the less abrupt kink in the amplitude frequency response. If, however, square-wave behavior is of less importance than the attenuation of sine-wave signals, then the decision will be in favor of Tschebyscheff or Butterworth filters.

From the cutoff frequency onward, the Tschebyscheff filter has a strongly accentuated reduction in amplification. However, the amplitude frequency response within the pass band is not monotone, but instead features ripples with constant amplitude. The higher the permitted ripple of the order in question, the greater the attenuation above the cutoff frequency. The advantage of the greater reduction in amplification must be set against the higher ripple before the cutoff frequency. In contrast, the Butterworth filter features an almost linear amplitude frequency response up to the cutoff frequency. It is used mainly when a minimum distortion of the input signal is required; only the part of the signal above the cutoff frequency will be attenuated. Figure 2 shows the principal amplitude frequency response of the three types of filters.

The design proposal discussed later is based on a second-order Butterworth low-pass filter. This design offers a linear amplitude frequency response of up to the cutoff frequency of 10 MHz.

4 Low-Pass First-Order RC Filter

A low-pass first-order filter is most simply constructed with an RC network. The resistor is in the signal path, and the capacitor is in parallel with the output.

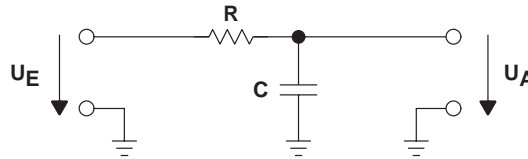

Figure 3. RC Network Used as a Low-Pass Filter

The following equation can be used to express the relationship between the output and the input voltage:

$$\underline{H}(j\omega) = \frac{U_A}{U_E} = \frac{1}{(1 + j\omega RC)} \quad (1)$$

By replacing $j\omega$ with s , the following transfer function results:

$$H(s) = \frac{1}{1 + sRC} \quad (2)$$

The absolute value for the amplitude response at the frequency in question can be calculated as:

$$|H(f)| = \frac{|U_A|}{|U_E|} = \frac{1}{\sqrt{1^2 + (\omega RC)^2}} \quad (3)$$

The following formula describes the phase relationship at the frequency in question:

$$\phi = -\arctan(\omega RC) \quad (4)$$

In order to derive a transfer function that is generally applicable, the frequency must be normalized. For this purpose, the cutoff frequency is usually used, but any desired frequency can be chosen. If the result is examined after normalization with the cutoff frequency, then the advantages here become clearly apparent.

After normalization ($j\omega$) with the cutoff frequency (ω_g) to $j \frac{\omega}{\omega_g} = j\Omega$ and correspondingly s to $\frac{s}{s_g} = S$, with the cutoff frequency $f_g = \frac{1}{2\pi RC}$, the transfer function (1) results in:

$$H(S) = \frac{1}{1 + S} \quad (5)$$

The formula is now universal and independent of a definite frequency. It is easier to see the behavior for different frequencies. For $\omega \gg \omega_g$ the value is obtained of $H(S) = \frac{1}{S}$, the amplification is thus reduced in proportion to the frequency. This corresponds to an attenuation of 20 dB per decade of frequency.

5 Filter Orders

The order of a filter can be determined by observing the transfer function. With the power of S , the order of the filter can be determined at the same time. The highest power of S in the transfer function is a direct measure of the magnitude of the filter order. With every increase of order n , the attenuation at higher frequencies increases by n 20 dB. The order of a filter is usually the same as the number of inductors and capacitors that are found in the circuit. In this case, groups of C or L , which represent an order, are brought together as a group component. The order is then reflected in the number of components; the number of components determines the cost, as well as the size and complexity of the layout. An important advantage of a filter of higher order is the increase of attenuation of 20 dB per order.

6 Filters of Higher Order

Until this point, only passive components have been used. If an active component is employed, the expression used is of active filters. Second-order active filters can be constructed with an operational amplifier. Using the decoupling property of the operational amplifier, several filters can be connected in series. To design a filter with an order higher than two, first-order and second-order filters are connected in series to form the required order of the filter.

The general transfer function formula for low-pass filters is as follows:

$$H(S) = \frac{K}{(b_1 S^2 + a_1 S + 1) (b_2 S^2 + a_2 S + 1) \dots (b_i S^2 + a_i S + 1)} \quad (6)$$

Taking $i = 1$ and $b = 0$ and $k = 1$ forms the transfer function (5) of a passive low-pass filter of first order having the coefficient $a_i = 1$. The behavior of this passive filter is changed when it is loaded. To prevent this from happening, a voltage follower is inserted in the circuit after the filter. From the passive filter with a coefficient of $a_i = 1$, an active filter with a coefficient of a_i , usually not equal to 1, is created.

By means of suitable coupling, a second-order low-pass filter is formed from the first-order active low-pass filter. The following transfer function is obtained:

$$H(S) = \frac{K}{(bS^2 + aS + 1)} \quad (7)$$

To obtain filters of higher order, filters of first and second order are connected in succession. The coefficients a and b determine the type of filter as a result of the transfer behavior. From filter tables (see Table 1), the coefficients can be determined for the individual types of filters: Butterworth, Tschebyscheff, or Bessel. Table 1 shows the coefficients a and b for these three types of filters.

7 Pole Quality Q of an Active Filter

The parameter Q stands for the pole quality. It indicates whether a filter has a tendency toward

instability. The pole quality Q is defined as $Q = \frac{\sqrt{b_i}}{a_i}$. The larger the pole quality Q , the more abrupt will be the kink in the transfer function at the cutoff frequency. Close to the cutoff frequency (f_g), the amplification increases by a factor of Q when compared to the dc voltage amplification. A pole quality Q that is too high often gives rise to a tendency to oscillation.

Table 1. Filter Coefficients for 3 dB Cutoff Frequency

Butterworth WITH 3 dB CUTOFF FREQUENCY						
FILTER ORDER	ORDER PER FILTER	i	a_i	b_i	$\frac{f_{gi}}{f_g}$	Q_i
1	First	1	1.0000	0.0000	1.000	–
2	Second	1	1.4142	1.0000	1.000	0.71
3	First	1	1.0000	0.0000	1.000	–
	Second	2	1.0000	1.0000	1.272	1.00
4	Second	1	1.8478	1.0000	.719	0.54
	Second	2	0.7654	1.0000	1.390	1.31
Tschebyscheff WITH 3 dB RIPPLE						
FILTER ORDER	ORDER PER FILTER	i	a_i	b_i	$\frac{f_{gi}}{f_g}$	Q_i
1	First	1	1.0000	0.0000	1.000	–
2	Second	1	1.0650	1.9305	1.000	1.30
2	First	1	3.3496	0.0000	0.299	–
	Second	2	0.3559	1.1923	1.396	3.07
2	Second	1	2.1853	5.5339	0.557	1.08
	Second	2	0.1964	1.2009	1.410	5.58
Bessel WITH 3 dB CUTOFF FREQUENCY						
FILTER ORDER	ORDER PER FILTER	i	a_i	b_i	$\frac{f_{gi}}{f_g}$	Q_i
1	First	1	1.0000	0.0000	1.000	–
2	Second	1	1.3617	0.6180	1.000	0.58
2	First	1	0.7560	0.0000	1.323	–
	Second	2	0.9996	0.4772	1.414	0.69
2	Second	1	1.3397	0.4889	0.978	0.52
	Second	2	0.7743	0.3890	1.797	0.81

8 Filters With Simple Coupling

Designing active filters can be approached in various ways. The following example describes the layout and the calculation of the component values for an active second-order filter. The capacitor C_2 is connected in the positive feedback loop. This filter, which has simple positive feedback, is known as a Sallen-and-Key low-pass filter. Figure 4 shows the basic layout of the filter.

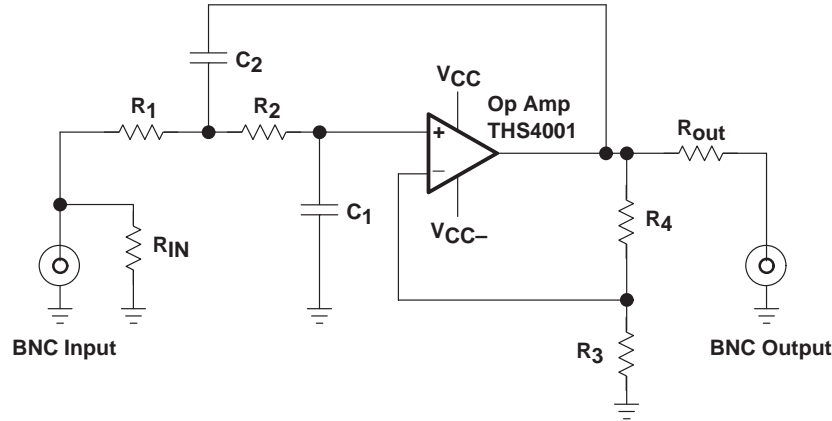

Figure 4. Active Low-Pass Filter of Second-Order With Simple Positive Feedback

The following formula gives the transfer function of an active second-order low-pass filter with simple positive feedback:

$$H(S) = \frac{K}{R_1 C_1 R_2 C_2 \omega_g^2 S^2 + [C_1(R_1 + R_2) + R_1 C_2(1-K)]\omega_g S + 1} \quad (8)$$

The desired filter type is designed by selecting the appropriate filter coefficients from Table 1. Several methods exist for finding the values for the components of the Sallen-Key filter. For two components and the factor K , a fixed value is chosen, and the other values for the missing components can be calculated.

A special case is created by choosing the same values for $R_1 = R_2 = R$ and for $C_1 = C_2 = C$. This special case results in a simplification in the choice of components and it simplifies Formula (8) as follows:

$$H(S) = \frac{K}{(RC\omega_g)^2 S^2 + RC(3-K)\omega_g S + 1} \quad (9)$$

When the Butterworth coefficients $a_1 = 1.4142$ $b_1 = 1$ from Table 1 are inserted in the normalized expression (7), the normalized form of a second order Butterworth low-pass results:

$$H(S) = \frac{K}{(1S^2 + 1.4142S + 1)} \quad (10)$$

Considering Formula (9), the calculation of the amplification factor K results in:

$$K = 3 - \frac{a_1}{\sqrt{b_1}} = 3 - \frac{1}{Q_i} = 1 + \frac{R_4}{R_3} = 1.586 \quad (11)$$

The potential divider, consisting of R_3 and R_4 , results in feedback of the output signal and amplification by the circuit. For the special case using the pole quality Q , the amplification factor K for the potential divider R_3 and R_4 can be calculated. This means that the amplification depends only on the pole quality Q and not on the cutoff frequency f_g . For low frequencies the amplification results in 1.586 equal 4 dB by the special case. This amplification can be corrected with a resistor divider at the input or output.

After a comparison of the coefficients from the normalized formula (10) with the formula (9) of the special case, the following formula is obtained for the resistors:

$$R = \frac{\sqrt{b_1}}{2\pi f_g C} = \frac{1}{2\pi f_g C} \quad (12)$$

The value for the capacitors C can be freely chosen. The use of a stereo potentiometer, instead of the resistors R_1 and R_2 , allows the cutoff frequency to be varied over an almost unlimited range. This is possible because the type of filter is decided exclusively by the amplification factor K , whereas C_1 , C_2 , R_1 , and R_2 determine the cutoff frequency. A problem that arises in practice is that passive components have tolerances on their actual values. These tolerances have a considerable effect on the characteristics of the filter. In particular, filters with a high cutoff frequency exhibit RF effects that are unimportant in filters for lower frequencies. Close attention must be paid to layout when working at higher frequencies. The use of SMD components and the shortest possible signal paths are important factors in layout design. In addition, only close tolerance components should be used for the construction of filter circuits. The selection of pairs of components that determine the frequency response ensures the best possible filter characteristics. In practice, components with a maximum tolerance of 1% should be used.

9 Calculation of Filter Component Values

Because of the simplification of the formula, calculating component values for the second-order filter requires only minimal computing effort and simplifies planning and design.

A value for the capacitors $C_1 = C_2 = C$ is first determined by the user. The value must be chosen so that a positive real figure results when calculating the values for resistors. A capacitance value that is considerably higher than the input capacitance of the operational amplifier should be selected. Otherwise, the input capacitance must be taken into account. Capacitors that are available in the E6 series should be chosen. These SMD chip capacitors are available from many suppliers with 1% tolerance.

In this particular case, a capacitance of 15 pF was chosen for C_1 and C_2 . If higher values are chosen for the capacitors, then the resistor values decrease. However, resistor values that are too low are also a load for the output and result in additional phase shifting. Testing showed that 15 pF is the best value for a 10 MHz cutoff frequency.

To calculate the values of the resistors R_1 and R_2 , only the values for the cutoff frequency, the capacitance, and the quadratic factor b_1 are needed from Table 1.

$$R = \frac{\sqrt{b_1}}{2\pi f_g C} \quad (13)$$

$$R = \frac{\sqrt{1}}{2\pi \times 10 \times 10^6 \times 15 \times 10^{-12}} \Omega \quad (14)$$

$$R = 1061 \Omega \quad (15)$$

Table 2. Component Values That Result for the Low-Pass Filter

COMPONENTS DESIGNATION	VALUES OF COMPONENTS	
	CALCULATED OR FIXED	USED
C_1, C_2	15 pF	15 pF
R_1, R_2	1061 Ω	1k Ω
R_{out}, R_{in}	50 Ω	51 Ω
R_3	1.3 Ω	1.3 k Ω
R_4	761.5 Ω	750 Ω
C_3, C_5	100 nF	100 nF
C_4, C_6	6.8 μ F	6.8 μ F/35 V Tantalum

The amplification factor K is calculated according to the formula $K = 1 + \frac{R_4}{R_3}$. By deriving a figure for K from Formula (11) and inserting R_3 , the value for R_4 can be calculated.

The value for R_3 must be selected carefully because the -3 dB bandwidth of the THS4001 is depending on the value of the feedback resistor. Because of the stray capacitances and their influence on high-speed designs, low value resistors should be chosen to minimize the effects of stray capacitances. Measurements showed best results for values of 1300 Ω (R_3) and 750 Ω (R_4).

The component values used for the test circuit are shown in Table 2.

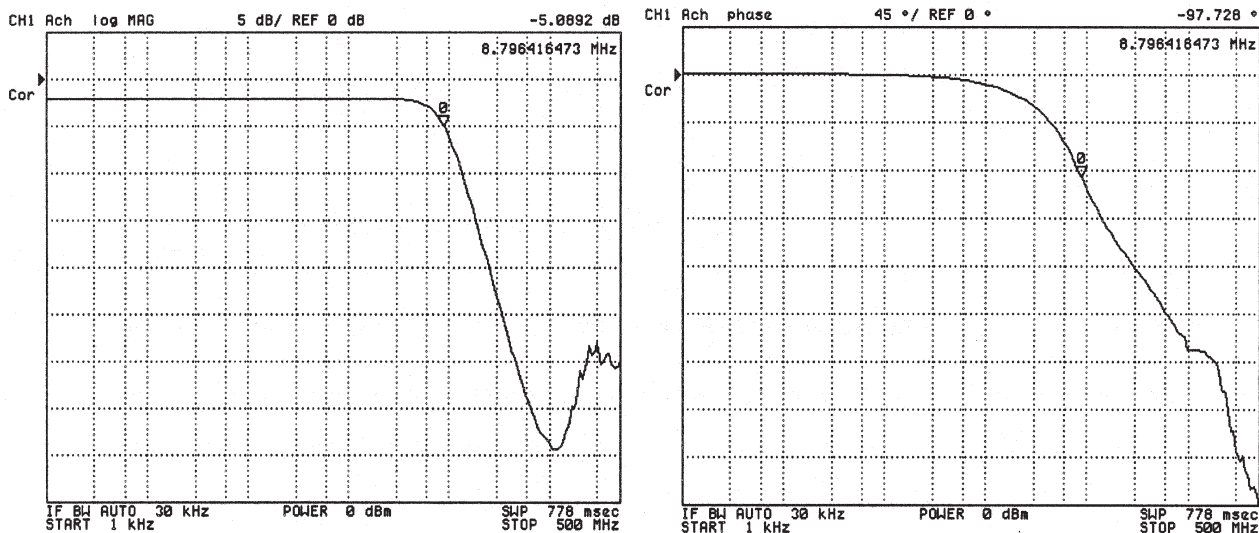
**Figure 5. Amplitude and Phase Response of the Filter With $R_1, R_2 = 1$ k Ω**

The above diagrams (Figure 5) were recorded with a Network Analyzer Type 4395A from Hewlett-Packard. The first diagram shows the amplitude response of the signal versus frequency. The corresponding phase response can be seen on the other diagram.

The results of measurement showed a cutoff frequency of 8.8 MHz with a corresponding phase response of -97.7° . This deviation of 12% from the calculated cutoff frequency has several causes. The THS4001 has an input capacitance of typical 1.5 pF and an open loop gain of 20 dB at 10 MHz. The output capacitance still occurs for this, the load of 100 Ω , and the impedance depending on the layout. To achieve a cutoff frequency of 10 MHz, the measured frequency of 8.8 MHz has to increase by 13.4%. According to Equation 12, the frequency is proportionally opposite to resistance. Since the capacity of 15 pF has a small value against the input capacitance, it is the only possibility for increasing the frequency by decreasing the resistance values by 13.4% (866 Ω). However, lower resistance values result in an increase of the output load with a simultaneous phase shifting. A resistance value of 910 Ω from the E24 series is selected so that the THS4001 output is not burdened too strongly.

Table 3. Modified Values of the Components for a Cut-Off Frequency of 10 MHz

COMPONENTS DESIGNATION	VALUES OF COMPONENTS	
	CALCULATED OR FIXED	USED
C_1, C_2	15 pF	15 pF
R_1, R_2	1061 Ω	910 Ω

Using the values shown in Table 3 yields the following results:

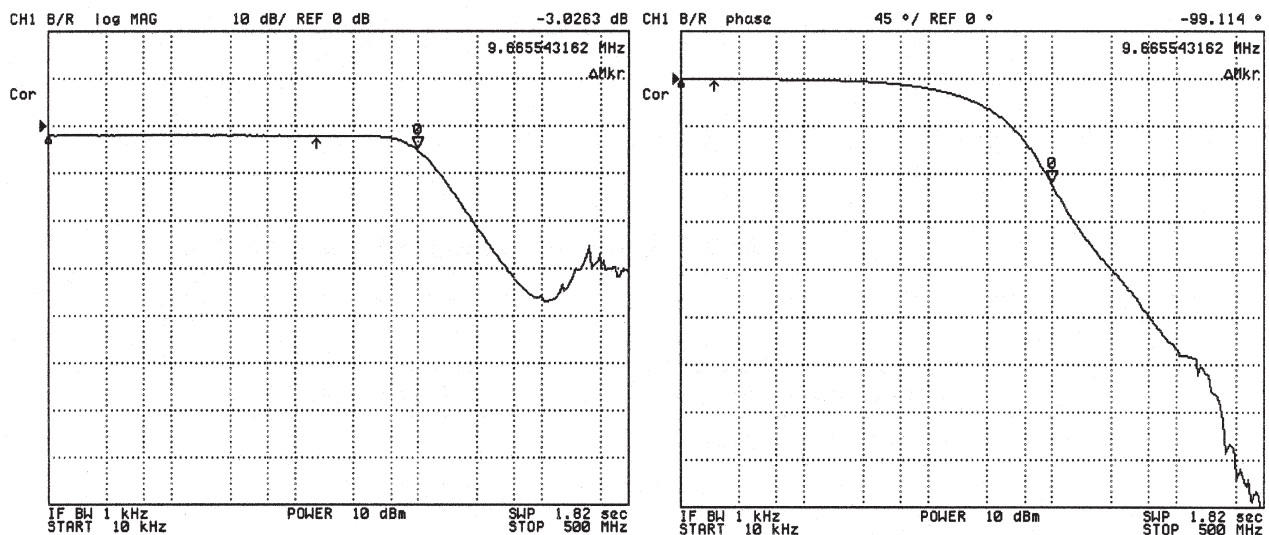

Figure 6. Amplitude and Phase Response of the Filter With R_1 and $R_2=910 \Omega$

The measured response curve agrees with the response expected from a Butterworth filter. The cutoff frequency is 9.7 MHz at a corresponding phase shift of -99° .

The THS4001 has an open loop gain at 100 MHz below 4 dB, according to the data sheet. From this frequency, the acting circuit loses its influence on the frequency response. Without the influence of the THS4001, a passive high-pass filter is formed (see Figure 7). This circuit has a frequency response, which is shown in Figure 8.

The sinking amplification of the THS4001 and the increasing influence of the high-pass filter resulted in a decreasing attenuation. This behavior starts around 100 MHz and can be seen in Figure 6.

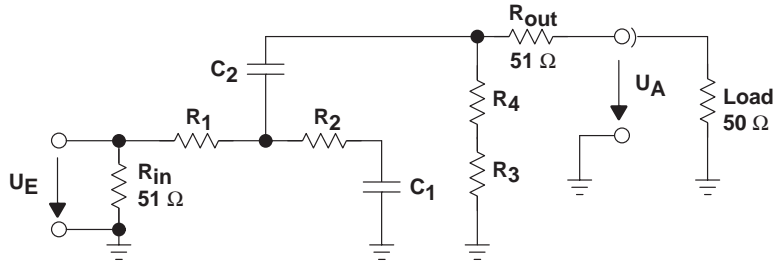

Figure 7. Passive Circuit Around the THS4001

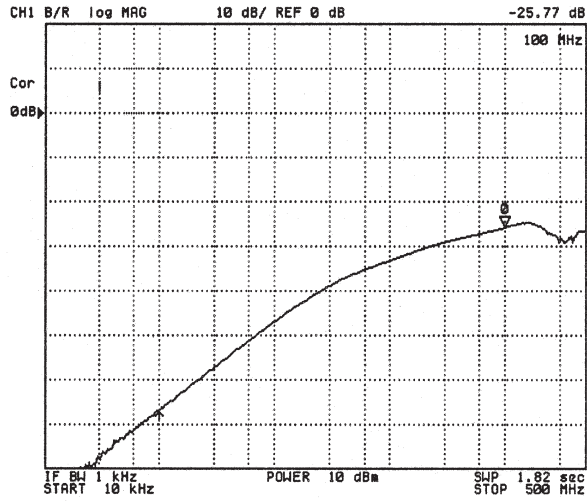

Figure 8. Frequency Responses of Passive Circuit

10 Printed Circuit Board

Figure 9 shows printed-circuit boards as an example of the actual construction of a filter design. In this application, resistors of type 1206 SMD from the E24 series having a tolerance of 1% are used. The inserted capacitors are a part of the E6 series.

In order to decouple and stabilize the supply voltage and prevent any tendency to oscillation, the ceramic 100 nF SMD capacitors C_3 and C_5 , having a tolerance of $\pm 5\%$, are used. For C_4 and C_6 , two tantalum chip capacitors with a value of 6.8 μF and a voltage rating of 35 V were chosen. As specified in the data sheet, the supply voltage should be a maximum of ± 15 V.

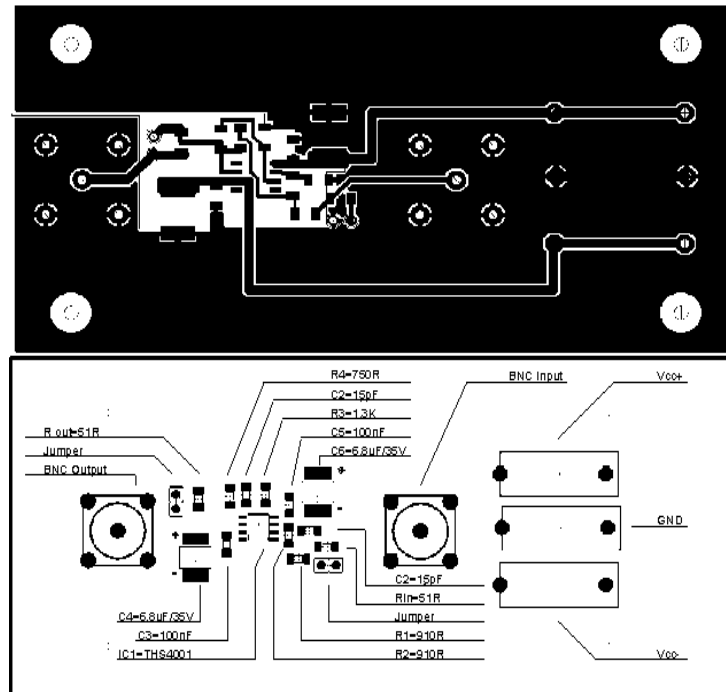

Figure 9. Circuit Board Layout and Component Placement Plan

11 Summary

High frequency filters are typically designed with passive components. But depending on parasitic impedances they are sometimes difficult to design.

Another design uses the THS4001 to build a low-pass filter up to 10 MHz. However, at frequencies above 1 MHz the component values have to be changed from the calculated values. Making C too large has consequences in that R may become so small that additional phases and amplification shift causes errors. If R is too large C may become so small that the parasitic capacitors, together with the amplifier input capacitor, cause errors. A small change in the component values brings the cutoff frequency in the desired direction.

The THS4001 can build an active 2nd order low-pass for high frequencies.

References

1. Horst Wupper, Professionelle Schaltungstechnik mit Operationsverstärkern (professional circuit design with operational amplifiers), Franzis Verlag, ISBN 3-7723-6732-1
2. U. Tietze & Ch. Schenk, Halbleiter-Schaltungstechnik (semiconductor circuit techniques), Springer Verlag, ISBN 3-540-16720-X
3. Don Lancaster, Das AKTIV-FILTER Kochbuch (the active filter cook-book), IWT Verlag, ISBN 3-88322-007-8
4. Analysis of the Sallen-Key-Architecture, Texas Instruments Application Report, Literature Number SLOA024, July 1999

IMPORTANT NOTICE

Texas Instruments and its subsidiaries (TI) reserve the right to make changes to their products or to discontinue any product or service without notice, and advise customers to obtain the latest version of relevant information to verify, before placing orders, that information being relied on is current and complete. All products are sold subject to the terms and conditions of sale supplied at the time of order acknowledgement, including those pertaining to warranty, patent infringement, and limitation of liability.

TI warrants performance of its semiconductor products to the specifications applicable at the time of sale in accordance with TI's standard warranty. Testing and other quality control techniques are utilized to the extent TI deems necessary to support this warranty. Specific testing of all parameters of each device is not necessarily performed, except those mandated by government requirements.

CERTAIN APPLICATIONS USING SEMICONDUCTOR PRODUCTS MAY INVOLVE POTENTIAL RISKS OF DEATH, PERSONAL INJURY, OR SEVERE PROPERTY OR ENVIRONMENTAL DAMAGE ("CRITICAL APPLICATIONS"). TI SEMICONDUCTOR PRODUCTS ARE NOT DESIGNED, AUTHORIZED, OR WARRANTED TO BE SUITABLE FOR USE IN LIFE-SUPPORT DEVICES OR SYSTEMS OR OTHER CRITICAL APPLICATIONS. INCLUSION OF TI PRODUCTS IN SUCH APPLICATIONS IS UNDERSTOOD TO BE FULLY AT THE CUSTOMER'S RISK.

In order to minimize risks associated with the customer's applications, adequate design and operating safeguards must be provided by the customer to minimize inherent or procedural hazards.

TI assumes no liability for applications assistance or customer product design. TI does not warrant or represent that any license, either express or implied, is granted under any patent right, copyright, mask work right, or other intellectual property right of TI covering or relating to any combination, machine, or process in which such semiconductor products or services might be or are used. TI's publication of information regarding any third party's products or services does not constitute TI's approval, warranty or endorsement thereof.