

Operating UCC2888x Offline Buck in Saturation for Cost Reduction

Chen, Wei-Hao

Field Applications Engineer

ABSTRACT

The economical UCC28880 and UCC28881 high voltage switchers are designed for AC/DC offline buck converters in low power applications. The device integrates a 700-V power MOSFET and HV Start-up Current Source that allows the design to operate directly from the rectified mains voltage and minimize excessive external components.

Contents

1	Introduction	2
2	Functional Schematic	2
3	Benefits and Trade-offs	2
4	Output Inductor Selection.....	3
5	System Level and Performance Comparison	4
6	Output Ripple and Inductor Current Waveforms.....	5
7	EMI Performance	7
8	Conclusion	8
9	References	8

List of Figures

1	Offline High-Side Buck Converter with On/Off Control	2
2	Current Runaway Protection Extends t_{OFF} Cycle-By-Cycle to Reduce Inductor Current	4
3	Efficiency Comparison for UCC28881EVM with 560 μ H Saturating and 1 mH Standard Inductor.....	5
4	115 VAC Standby Output Ripple	5
5	115 VAC Standby Output Ripple	5
6	230 VAC Standby Output Ripple	5
7	230 VAC Standby Output Ripple	5
8	115 VAC 215 mA Load Output Ripple	5
9	115 VAC 215 mA Load Output Ripple	5
10	230 VAC 215 mA Load Output Ripple	6
11	230 VAC 215 mA Load Output Ripple	6
12	EMI Measurement 115 VAC, 13 V / 215 mA Load, Neutral	7
13	EMI Measurement 115 VAC, 13 V / 215 mA Load, Neutral	7
14	EMI Measurement 115 VAC, 13 V / 215 mA Load, Line	7
15	EMI Measurement 115 VAC, 13 V / 215 mA Load, Line	7
16	EMI Measurement 230 VAC, 13 V / 215 mA Load, Neutral	7
17	EMI Measurement 230 VAC, 13 V / 215 mA Load, Neutral	7
18	EMI Measurement 230 VAC, 13 V / 215 mA Load, Line	7
19	EMI Measurement 230 VAC, 13 V / 215 mA Load, Line	7

List of Tables

1	Benefits and Trade-offs of Driving Output Inductor into Saturation	3
---	--	---

Trademarks

WEBENCH is a registered trademark of Texas Instruments.
All other trademarks are the property of their respective owners.

1 Introduction

See [Figure 1](#) below for the functional schematic of an offline high-side buck converter using UCC2888x. To make the design more economical, this application report reveals an alternative design approach to drive the output inductor into saturation with a much smaller inductor. By doing this, the cost and physical size of the output inductor can be significantly reduced with minor trade-offs in system efficiency, EMI emissions, and output noises. A set of bench tests had been conducted to validate this design approach and the results are included in this application report. This is recommended for low power non-isolated offline power supplies, but which struggle to meet confined space requirements and low budget constraints. The UCC2888x switcher ideally suited for various industrial, appliance and IoT applications such as:

- Smart Meters
- Home Automation Equipment
- LED Lighting
- White Goods
- Bias Power for MCU, RF, and IoT Enabled Devices

2 Functional Schematic

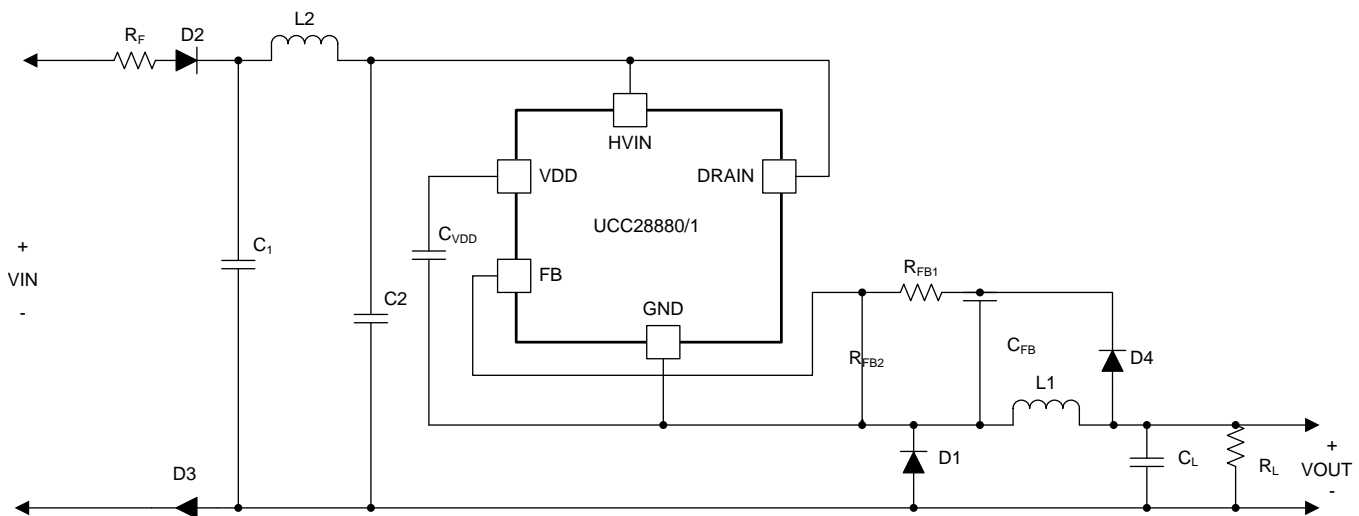

Figure 1. Offline High-Side Buck Converter with On/Off Control

3 Benefits and Trade-offs

The main benefits of driving the output inductor into saturation are cost and board size reductions. The inductor with smaller inductance or lower saturation current rating could be used in this design approach, which may save the cost roughly by 15% - 80%, and PCB size by 20% - 40% for the output inductor, depending on the type of inductor used, manufacturer, distributor and the number of units purchased. Despite all the benefits, there are some minor performance trade-offs such as lower system efficiency and larger EMI emissions for this design approach. The benefits and trade-offs are summarized in [Table 1](#).

Table 1. Benefits and Trade-offs of Driving Output Inductor into Saturation

Benefit	Reason
Overall Board Size Reduction	Inductors with lower inductance or lower Isat rating tend to be smaller in physical size.
Increased Power Density	Reduction in board size increases overall power density.
System BOM Cost Reduction	Smaller or lower Isat rating inductors and smaller size PCBs are less expensive in general.
Smaller Output Ripple	The system switching frequency increases as the effective inductance drops in saturation.
Trade-off	Reason
Lower Efficiency	<ul style="list-style-type: none"> • Larger switching loss: Higher system switching frequency incurs higher switching loss. • Larger conduction loss: Higher RMS current causes more energy to be dissipated through R_{dson} and DCR.
Larger ESL Voltage Spike	A higher leading-edge voltage spike is generated due to larger di/dt through ESL of the output capacitor when the inductor is saturated.
Thermal Performance	Extra loss in smaller package inductor
EMI	Worse EMI performance due to higher switching frequency and larger ESL spike noise.

4 Output Inductor Selection

In general UCC2888x design guideline, the standard output inductor L1 is selected to meet the following requirements:

1. Inductance large enough to have peak inductor current smaller than ILIMIT for supporting CCM-operation at full load.
2. The inductor saturation current rating higher than the peak inductor current or the maximum current limit $I_{LIMIT(MAX)}$.

In this design approach, the output inductor can be selected to have much lower inductance value and saturation current rating for reducing the cost and size. However, it still has to follow these two rules:

1. An inductor with smaller inductance can be selected, but must keep $L1 > L_{MIN}$ from [Equation 1](#).
2. An inductor with lower saturation current rating can be selected, but must ensure its effective inductance is larger than L_{MIN} when it saturates.

The minimal inductance value can be calculated using [Equation 1](#):

$$L_{MIN} \geq \frac{V_{IN(MAX)} \times \sqrt{2}}{I_{LIMIT(MIN)}} \times T_{ON_TO}$$

where

- L_{MIN} is the minimal inductance required to avoid current runaway protection
- V_{IN} is the maximum voltage on the DC input.
- $I_{LIMIT(MIN)}$ is the worst case current limit. Use 140 mA for UCC28880; and 315 mA for UCC28881.
- T_{ON_TO} is the Inductor Current Runaway Protection time threshold, which has a typical value of 450 ns.

(1)

Otherwise if the selected inductance is too small or the effective inductance drops too much due to saturation, the inductor current could reach the current limit I_{LIMIT} in a very short duration of time ($< T_{ON_TO}$) due to high di/dt in saturation. This will unintentionally trigger the Current Runaway Protection and limit the output power capability of the design.

The Inductor Runaway Protection is originally designed to prevent the loss of control of the inductor current from overload conditions, including a short circuit at the output. Under fault conditions, inductor current I_L would increase from the pre-existing high value because the demagnetization is slow. To prevent I_L rising too high, the current runaway protection will be triggered if the I_L reaches the current-limit I_{LIMIT} before the MOSFET minimum on-time t_{ON_TO} . The UCC2888x device progressively extends MOSFET off-time t_{OFF} cycle-by-cycle to reduce the I_L until $t_{ON} > t_{ON_TO}$ as Figure 2 illustrated below. Consequently, the output power is reduced and the converter fails to supply the full power to the load.

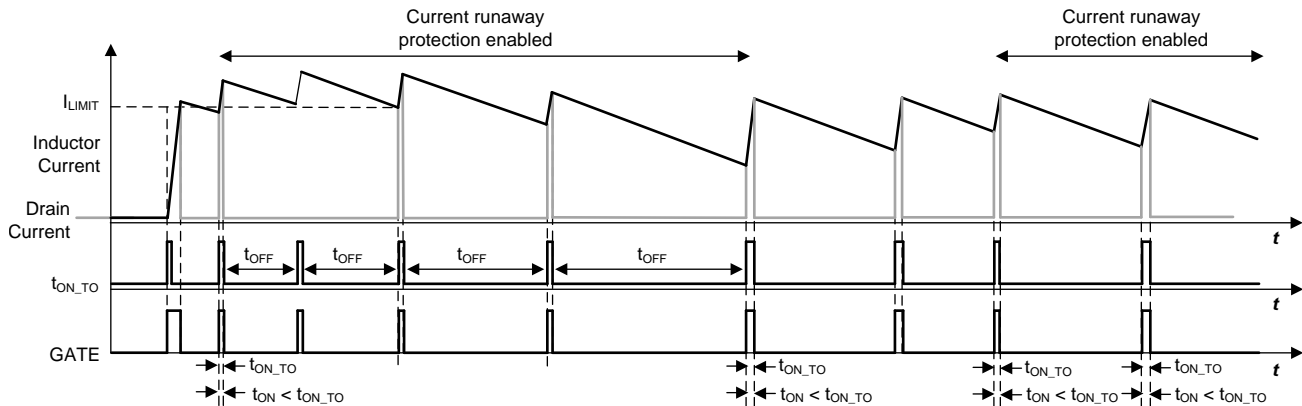

Figure 2. Current Runaway Protection Extends t_{OFF} Cycle-By-Cycle to Reduce Inductor Current

5 System Level and Performance Comparison

To prove the viability of driving the output inductor into saturation for the cost and board size reduction, a 560 μH inductor with 300 mA I_{sat} rating was tested on the UCC28881EVM-680 to compare the cost and size benefits and performance trade-offs against the standard 1 mH inductor on the EVM. The results are summarized below.

Table 2. System and Performance ⁽¹⁾⁽²⁾

Inductor	Saturating Inductor	Standard Inductor
Inductance	560 μH	1 mH
I_{sat}	300 mA	600 mA
Inductor Size (mm)	7.30 (W) x 7.30 (L) x 4.5 (H)	\varnothing 11.0 x 11.5 (H)
	(78% smaller in volume ; 44% smaller in area)	
Relative Cost Scale	0.216	1
Peak I_L ⁽³⁾	804 mA	424 mA
Max. Efficiency ⁽⁴⁾	75.91% _(230 VAC)	80.66% _(230 VAC)
	78.70% _(115 VAC)	80.14% _(115 VAC)
Output Ripple ⁽³⁾	± 8.4 mV (No load)	± 13.4 mV (No load)
	± 6.1 mV (Full load)	± 7.6 mV (Full load)
ESL Spike on top of V_{out} ⁽³⁾	34.8 mV	16.6 mV
EMI Performance	CISPR 22 / EN 55022 Class B ⁽⁵⁾	CISPR 22 / EN 55022 Class B

(1) All tests were conducted at 25°C room temperature.

(2) The relative cost scale is only for reference purposes and was calculated based on the 1 kU price from online electronics component distributors. The actual price may vary depending on different distributor, manufacturer and the number of units purchased.

(3) The measurements were conducted with 230 VAC input.

(4) The saturating inductor and the UCC28881 IC are slightly hotter than the original EVM design due to the additional losses.

(5) An extra ferrite bead needs to be added before the pi-filter to meet the CISPR 22 and EN 55022 Class B EMI emission requirements, which may raise the cost on EMI filter design by a small portion and reduce the overall cost gain slightly, depending on the EMI requirement.

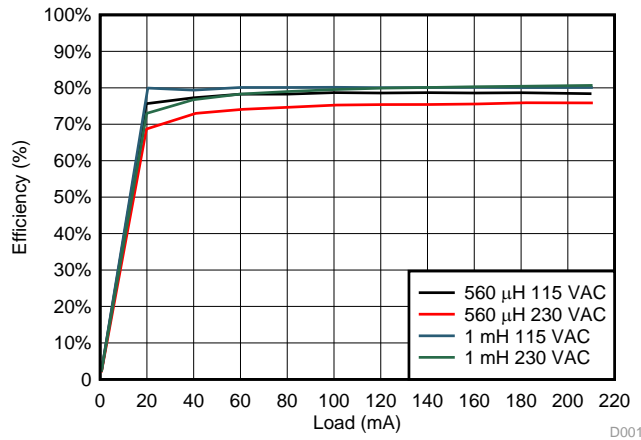

Figure 3. Efficiency Comparison for UCC2881EVM with 560 uH Saturating and 1 mh Standard Inductor

6 Output Ripple and Inductor Current Waveforms

UCC2881EVM Test Waveforms of Output Ripple Voltage, Inductor Current, Load Current.

All measurements were made at 25°C room temperature.

Left column - 560 uH Saturating Inductor

Right column - 1 mH Standard Inductor

Legend

- Dark Blue - Ch2 Inductor Current, I_L
- Purple - Ch3 Output Voltage, V_{OUT}
- Green - Ch4 Output Current, I_{OUT}

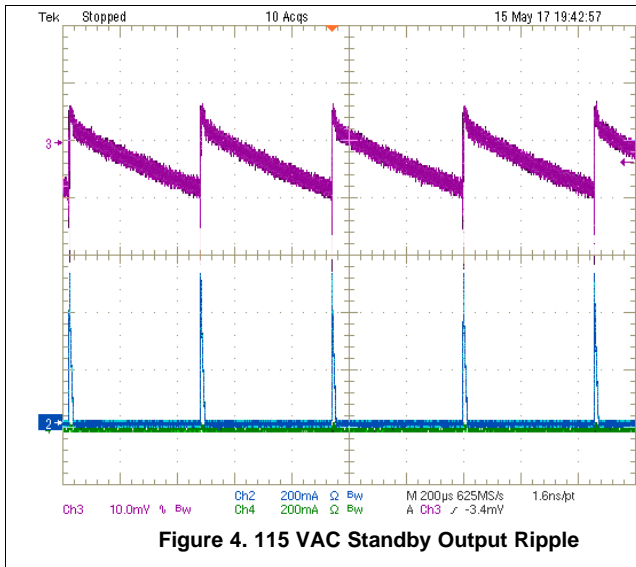

Figure 4. 115 VAC Standby Output Ripple

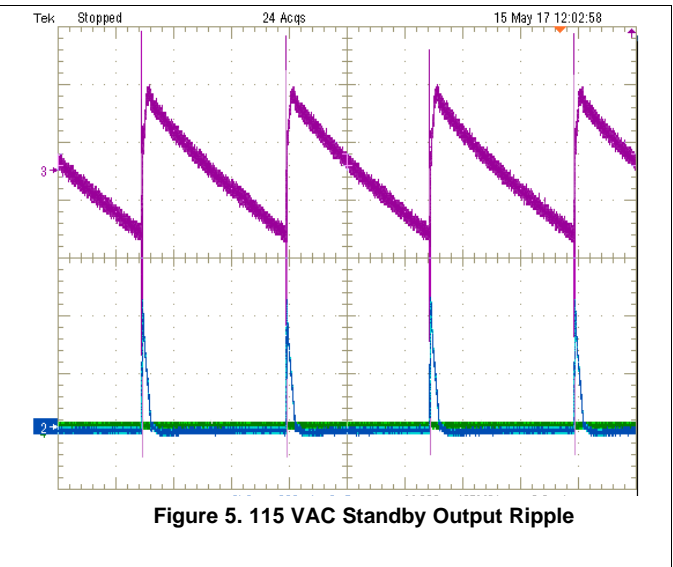

Figure 5. 115 VAC Standby Output Ripple

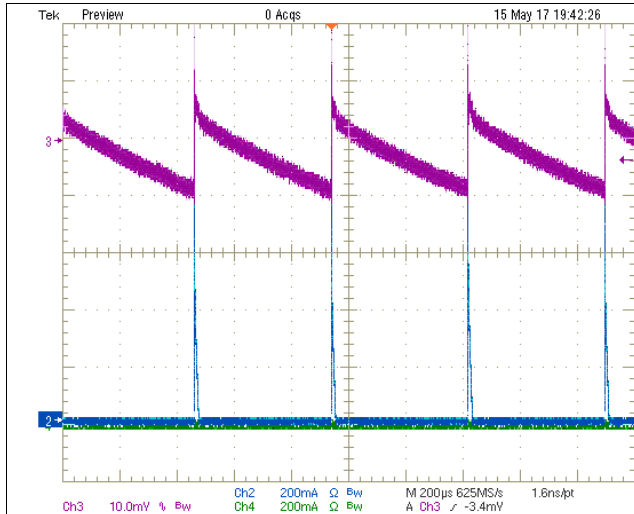

Figure 6. 230 VAC Standby Output Ripple

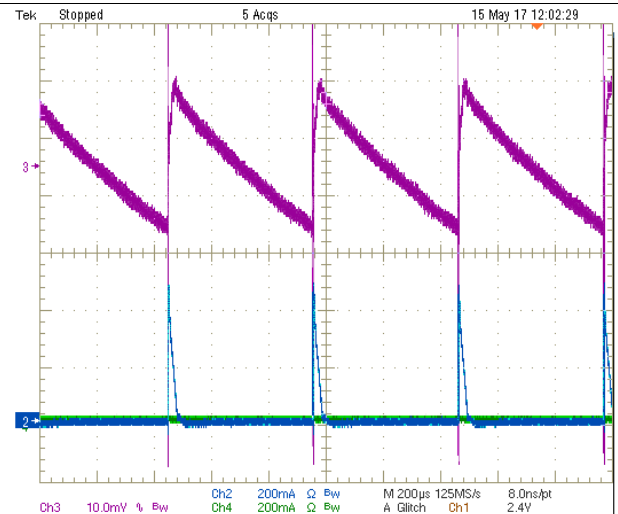

Figure 7. 230 VAC Standby Output Ripple

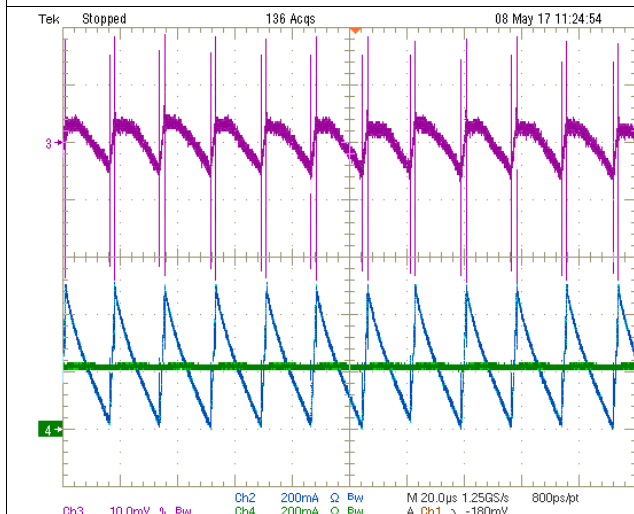

Figure 8. 115 VAC 215 mA Load Output Ripple

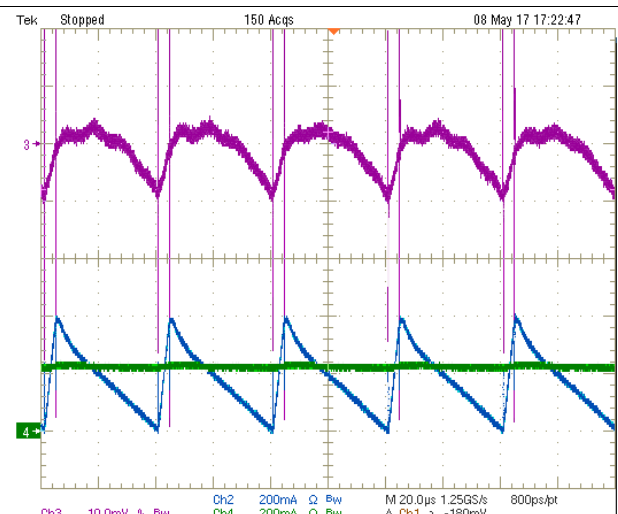

Figure 9. 115 VAC 215 mA Load Output Ripple

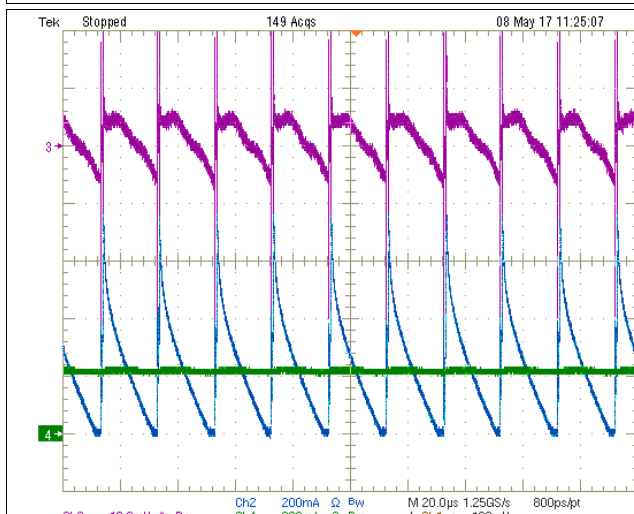

Figure 10. 230 VAC 215 mA Load Output Ripple

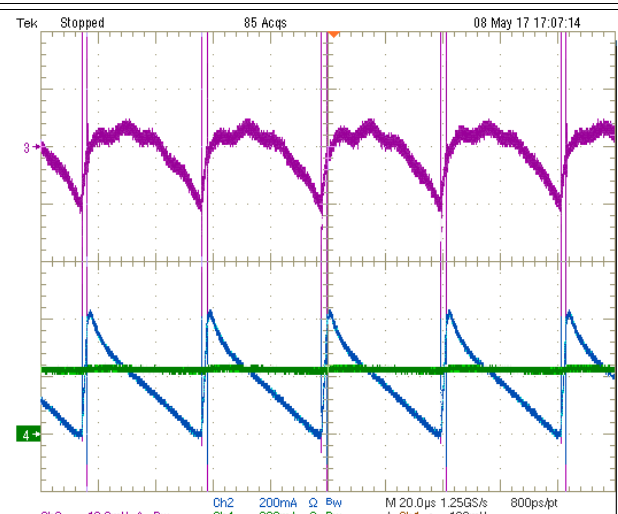
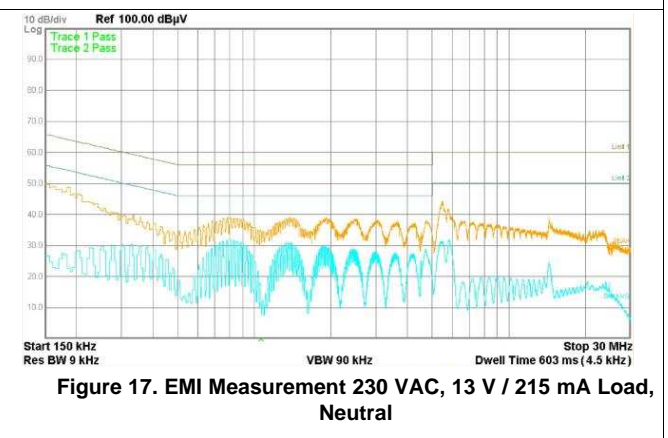
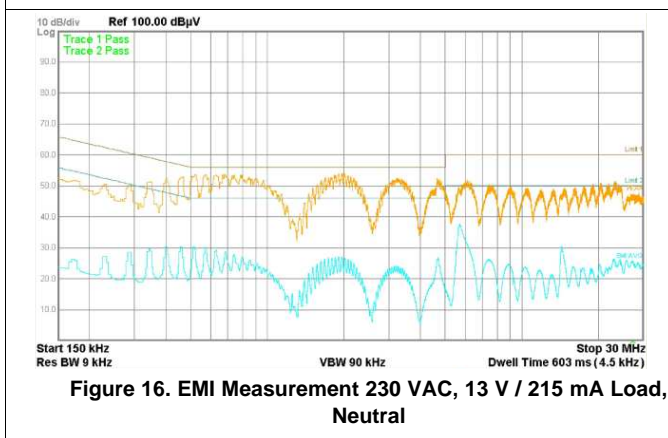
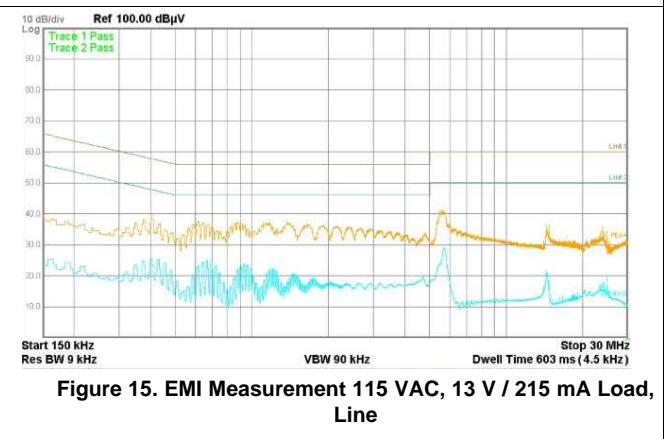
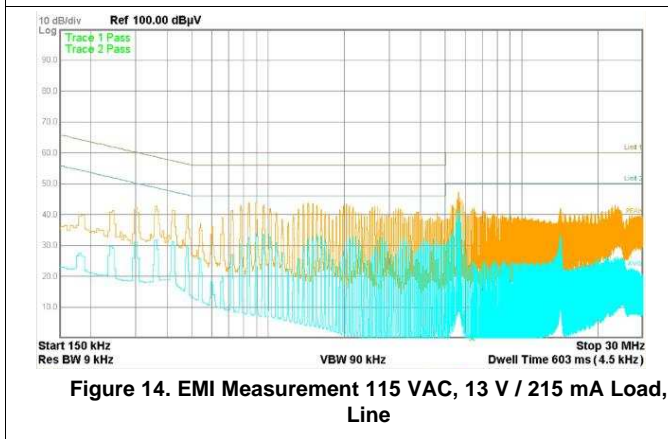
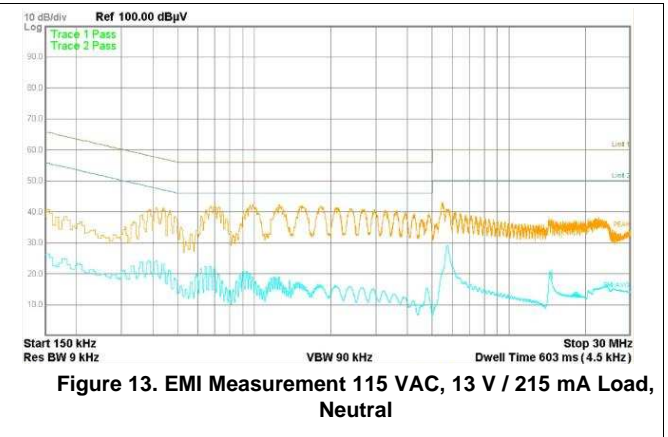
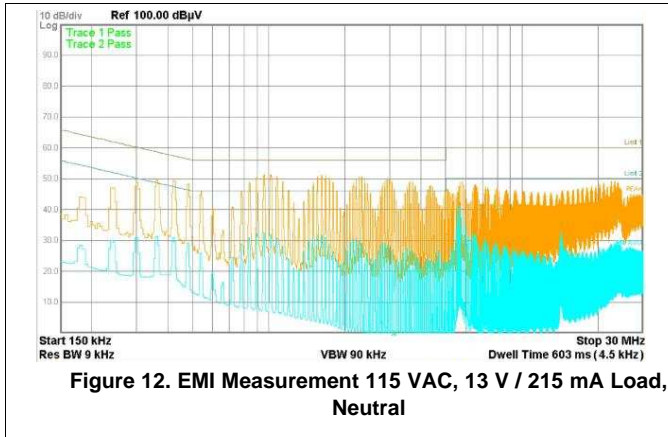

Figure 11. 230 VAC 215 mA Load Output Ripple

7 EMI Performance

Left column - 560 uH Saturating Inductor

Right column - 1 mH Standard Inductor



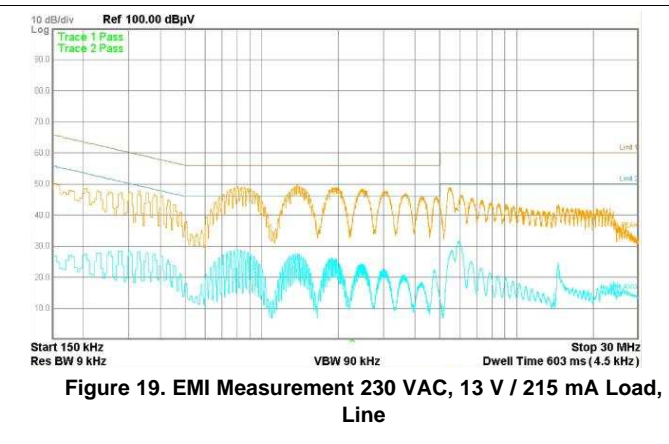
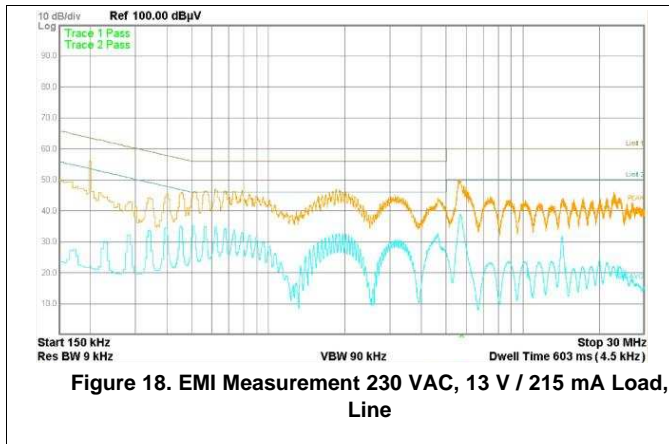

8 Conclusion

Driving the output inductor into saturation for UCC2888x offline buck converter reduces a significant amount of production cost and system board size with minor trade-offs in system efficiency, output noises and EMI emissions. This offers a very cost effective, highly integrated and compact low power AC/DC offline solution ideally suited for many industrial, appliance and IoT applications. Want to achieve high power density at minimal cost while maintaining a good system performance? UCC28880 and UCC28881 Switchers are right in front of your eyes, so why wait?

9 References

- Learn more about UCC2888x Switcher by visiting: <http://www.ti.com/product/UCC28880> and <http://www.ti.com/product/UCC28881>
- Do not miss the training video "How to Modify UCC28880 EVM for Your Custom Design"
- Start the development of your design via [WEBENCH® Design Center](#) and get your [UCC28881EVM-680](#) evaluation board today.

IMPORTANT NOTICE AND DISCLAIMER

TI PROVIDES TECHNICAL AND RELIABILITY DATA (INCLUDING DATASHEETS), DESIGN RESOURCES (INCLUDING REFERENCE DESIGNS), APPLICATION OR OTHER DESIGN ADVICE, WEB TOOLS, SAFETY INFORMATION, AND OTHER RESOURCES "AS IS" AND WITH ALL FAULTS, AND DISCLAIMS ALL WARRANTIES, EXPRESS AND IMPLIED, INCLUDING WITHOUT LIMITATION ANY IMPLIED WARRANTIES OF MERCHANTABILITY, FITNESS FOR A PARTICULAR PURPOSE OR NON-INFRINGEMENT OF THIRD PARTY INTELLECTUAL PROPERTY RIGHTS.

These resources are intended for skilled developers designing with TI products. You are solely responsible for (1) selecting the appropriate TI products for your application, (2) designing, validating and testing your application, and (3) ensuring your application meets applicable standards, and any other safety, security, or other requirements. These resources are subject to change without notice. TI grants you permission to use these resources only for development of an application that uses the TI products described in the resource. Other reproduction and display of these resources is prohibited. No license is granted to any other TI intellectual property right or to any third party intellectual property right. TI disclaims responsibility for, and you will fully indemnify TI and its representatives against, any claims, damages, costs, losses, and liabilities arising out of your use of these resources.

TI's products are provided subject to TI's Terms of Sale (www.ti.com/legal/termsofsale.html) or other applicable terms available either on ti.com or provided in conjunction with such TI products. TI's provision of these resources does not expand or otherwise alter TI's applicable warranties or warranty disclaimers for TI products.

Mailing Address: Texas Instruments, Post Office Box 655303, Dallas, Texas 75265
Copyright © 2019, Texas Instruments Incorporated