

# **Designing Switching Voltage Regulators With TL497A**

---

*John Spencer and Eugene J. Tobaben*
*Linear Products Department*

## **ABSTRACT**

Switching voltage regulators, represented by the TL497, can achieve high-efficiency power conversion at large input/output voltage differentials. The TL497A eliminates complex circuit designs previously required and provides greater efficiency than systems using series pass regulators. The principle of operation is discussed, and practical design exercises for step-down, step-up, and inverting regulators are provided.

---

## **Contents**

|   |           |
|---|-----------|
| <b>Introduction</b> .....   | <b>3</b>  |
| <b>Principle of Operation</b> .....   | <b>3</b>  |
| <b>The TL497A</b> .....   | <b>3</b>  |
| General .....   | 3         |
| Programming .....   | 4         |
| Oscillator .....  | 4         |
| Current Limiting .....  | 5         |
| Pass Transistor .....   | 5         |
| Catch Diode .....   | 5         |
| Enable Circuitry .....  | 5         |
| <b>Design and Operation of a Step-Down Switching Voltage Regulator</b> .....                | <b>6</b>  |
| Summary .....   | 8         |
| A Step-Down Switching Regulator Design Exercise With TL497A .....                           | 9         |
| <b>Design and Operation of a Step-Up Switching Voltage Regulator</b> .....                  | <b>13</b> |
| A Step-Up Switching Regulator Design Exercise With TL497A .....                             | 14        |
| <b>Design and Operation of Switching Voltage Regulator in Inverting Configuration</b> ..... | <b>16</b> |
| An Inverting Regulator Design Exercise With TL497A .....                                    | 17        |
| <b>Special TL497A Circuits</b> .....  | <b>18</b> |
| <b>Design Variations For Improved Performance</b> .....                                     | <b>19</b> |
| Extended Voltage Operation .....  | 21        |
| Low Voltage Operation .....   | 21        |
| Switching Regulator Design Tips .....   | 21        |
| Inductor Sources .....  | 22        |
| <b>Appendix</b> .....   | <b>23</b> |

## **List of Figures**

|   |   |
|---|---|
| Figure 1. Step-Down Switching Voltage Regulator ..... | 3 |
| Figure 2. TL497A Block Diagram .....                  | 4 |

|               |  |    |
|---------------|--|----|
| Figure 3.     | $C_T$ Voltage Waveform   | 4  |
| Figure 4.     | Typical $C_T$ Voltage Waveform During Start-Up and Quiescent Operation | 5  |
| Figure 5.     | $C_T$ Voltage Waveform   | 5  |
| Figure 6.     | Basic Step-Down Regulator  | 6  |
| Figure 7.     | Inductor Current Waveform  | 6  |
| Figure 8.     | Inductor Current and Capacitor Current Waveform                        | 7  |
| Figure 9.     | Capacitor Current Waveform ( $\Delta Q+$ )                             | 7  |
| Figure 10.    | Capacitor Current Waveform ( $\Delta Q-$ )                             | 7  |
| Figure 11.    | Capacitor Current Waveform (Continuous Mode)                           | 8  |
| Figure 12.    | Basic Step-Down Regulator  | 9  |
| Figure 13.    | 15 Volt to 5 Volt Switching Regulator for Output Currents to 200 mA    | 10 |
| Figure 14.    | Circuit Performance Waveforms  | 10 |
| Figure 15.    | Techniques for Obtaining Peak Currents Greater Than 500 mA             | 10 |
| Figure 16.    | TL497A in High-Voltage-High-Current Applications                       | 11 |
| Figure 17.    | TL497A Logic Array Power Supply, Step-Down Circuit                     | 12 |
| Figure 18.    | Step-Down Regulator  | 12 |
| Figure 19.    | Basic Step-Up Regulator Circuit  | 13 |
| Figure 20.    | Inductor and Capacitor Step-Up Regulator                               | 13 |
| Figure 21.    | Basic Step-Up Regulator Using the TL497A                               | 14 |
| Figure 22.    | 5 Volt to 15 Volt Switching Regulator                                  | 15 |
| Figure 23.    | TL497A Step-Up Circuit, 5V Input to 12V @ 80 mA Output                 | 15 |
| Figure 24.    | Basic Inverting Regulator Circuit                                      | 16 |
| Figure 25.    | Basic Inverting Regulator  | 17 |
| Figure 26.    | +5 Volt to -5 Volt Switching Regulator                                 | 18 |
| Figure 27.    | 12V to 8.5V Step-Up/Down Circuit                                       | 18 |
| Figure 28.    | TL497A Dual Supply +12 Volts and -12 Volts From +5 Volts               | 18 |
| Figure 29.    | Basic Regulator Architectures  | 19 |
| Figure 30(a). | Step-Down Regulator  | 19 |
| Figure 30(b). | TL497A With External PNP Switch For Improved Performance               | 19 |
| Figure 31.    | $C_T$ Waveforms  | 19 |
| Figure 32.    | Basic Regulator With Feedback Diodes                                   | 20 |
| Figure 33.    |  | 20 |
| Figure 34.    |  | 21 |
| Figure 35.    |  | 21 |

### List of Tables

|          |                                    |    |
|----------|------------------------------------|----|
| Table 1. | TL497A Operation From a 5V Supply  | 24 |
| Table 2. | TL497A Operation From a 12V Supply | 24 |

## INTRODUCTION

The TL497 represents a revolution in the implementation of a monolithic, highly efficient switching regulator.

Conventional series regulators employ an active element, usually a transistor operating in a linear mode, which functions as a variable resistor. The product of this resistance and the load current create a changing differential voltage required to step down from an unregulated input voltage to a fixed output voltage. In this type of circuit, current requirements defined by the load, must be experienced by the pass element. As the input to output voltage differential or load current requirement increases the power dissipated in the pass element increases proportionally. This power represents a loss to the system and limits the efficiency of series regulators.

The switching regulator, on the other hand, does not operate in the linear mode and is capable of achieving high efficiency power conversion even at large input/output voltage differentials. In the past the complexity of the circuitry required to construct a switching regulator negated the advantage of efficiency gained over series pass regulators. Use of the TL497A, however, eliminates the complex circuit designs previously required and offers marked performance improvements in efficiency over systems using series pass regulators.

## PRINCIPLE OF OPERATION

The principle of operation and the method by which voltage conversion at high efficiencies can be achieved using switching regulators can best be demonstrated by analyzing the basic configuration of a step-down switching voltage regulator (Figure 1).

Q1 is the switch transistor which is turned on and off by the regulator's control circuitry at a frequency and duty cycle required to maintain the desired output. Because this transistor is always in the saturated state when it is conducting, or otherwise completely nonconducting, the power dissipated in the switch is much lower than that dissipated in a series regulator whose pass transistor is continuously operated in the linear region. This is the primary contributor to the increased efficiency experienced

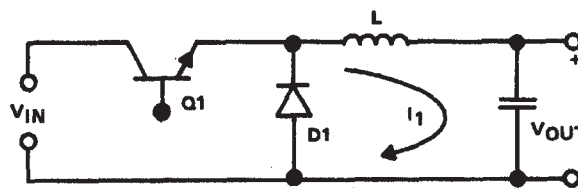

FIGURE 1. Step-Down Switching Voltage Regulator

with a switching voltage regulator. The transfer of energy from the input to the output is achieved through the inductor L. During the time Q1 is on ( $t_{ON}$ ) the input voltage is applied to the LC filter and the current in the inductor increases. When Q1 is turned off the energy developed in the inductor during the previous half cycle, maintains the current flow to the load through the catch diode D1 and delivers that energy to the load.

The output voltage is determined by the input voltage ( $V_{IN}$ ) and the duty cycle of the switch Q1.

$$V_{OUT} = V_{IN} \frac{t_{ON}}{T}$$

$$\text{where } T = t_{ON} + t_{OFF}$$

Therefore, by controlling the duty cycle ( $t_{ON}/T$ ), changes in the input voltage can be compensated for. If  $V_{IN}$  increases, the control circuit will cause a corresponding reduction in the duty cycle and thereby maintain a constant  $V_{OUT}$ , without increasing the amount of power dissipated internally in the regulator.

## THE TL497A

### General

The TL497A incorporates on a single monolithic chip all the active functions required in the construction of a Switching Voltage Regulator: a precision 1.22-volt reference, a pulse generator, a high-gain comparator, current limit sense and shut-down circuitry, a catch diode, and a series pass transistor. The TL497A was designed to offer versatility and to optimize the ease of its use in the various step-up, step-down, and voltage inversion applications requiring high efficiency.

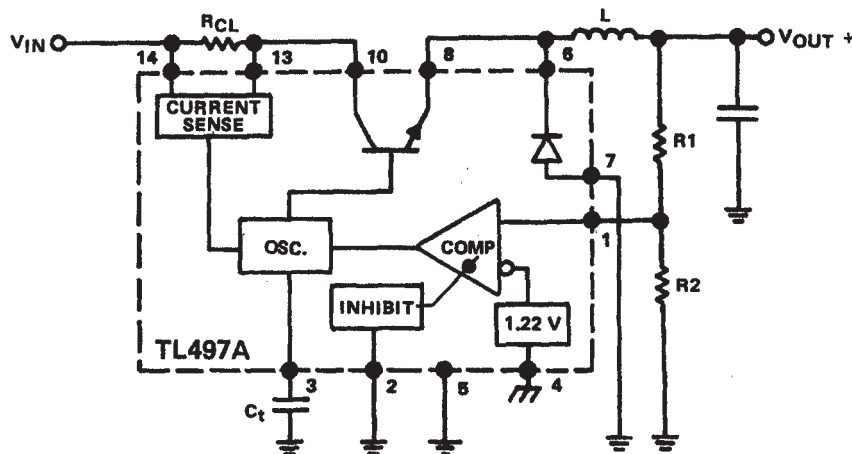

FIGURE 2. TL497A Block Diagram

### Programming

A block diagram of the TL497A is shown in Figure 2. The internal 1.22-volt precision band-gap reference is internally connected between the substrate terminal and the inverting input of the high-gain comparator. The output of the circuit is sensed through a resistor ladder network (R1-R2) by the noninverting input of the comparator and is programmed by the resistors R1 and R2 such that the feedback voltage equals the 1.22 volt reference. Thus;

$$V_{OUT} \frac{R_2}{R_1 + R_2} = 1.22 \text{ volts}$$

To keep it simple the voltage across R2 is 1.22 volts. For 1mA programming current R2 becomes 1.22 K $\Omega$ . Therefore:

$$\text{SET } R_2 = 1.22 \text{ K}\Omega$$

$$\text{AND CALCULATE } R_1 = (V_{OUT} - 1.22) \text{ K}\Omega$$

### Oscillator

The oscillator is composed of a current pulse generator which charges and discharges the external timing capacitor ( $C_t$ ) at fixed current rates whenever the feedback voltage is less than 1.22 v. The charging rate is 1/6 that of the discharge rate which results in the voltage waveform shown in Figure 3. The total period of the charge/discharge cycle is determined by the external timing capacitor ( $C_t$ ) and is constant for all input voltages within the TL497A recommended operating ranges.

The charge/discharge period (T) varies with  $C_t$  as shown in Table I.

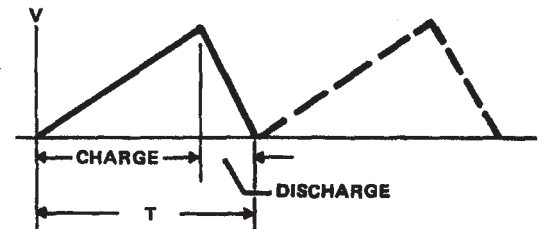

FIGURE 3.  $C_t$  Voltage Waveform

The dotted line of Figure 3 shows the timing capacitor waveform under continuous operation conditions. Only under these conditions does T determine the oscillators frequency ( $F_{max} = 1/T$ ). These conditions exist during initial power-up of the system or whenever the comparator indicates the output voltage is less than the desired voltage-out. After the timing capacitor is discharged, the oscillator control circuit will sample the output of the comparator to determine if the output voltage is at a satisfactory level. If the comparator indicates the output is deficient, the current generator will retrigger and the oscillator will go through another  $C_t$  charge/discharge cycle; after which it will sample the comparator again and so forth. If on the other hand, the comparator indicates the output voltage is satisfactory, the current generator will be on standby until it is triggered by the comparator as illustrated in Figure 4. The pass transistor is turned "ON" during the charging portion ( $t_C$ ) and turned "OFF" during the discharge portion ( $t_D$ ) and any subsequent standby

Table I. Charge/Discharge Period Vs.  $C_t$

|              |     |     |     |     |     |     |      |      |      |
|--------------|-----|-----|-----|-----|-----|-----|------|------|------|
| $C_t$ (pF)   | 200 | 250 | 350 | 400 | 500 | 750 | 1000 | 1500 | 2000 |
| T ( $\mu$ s) | 23  | 27  | 32  | 39  | 50  | 70  | 95   | 140  | 230  |

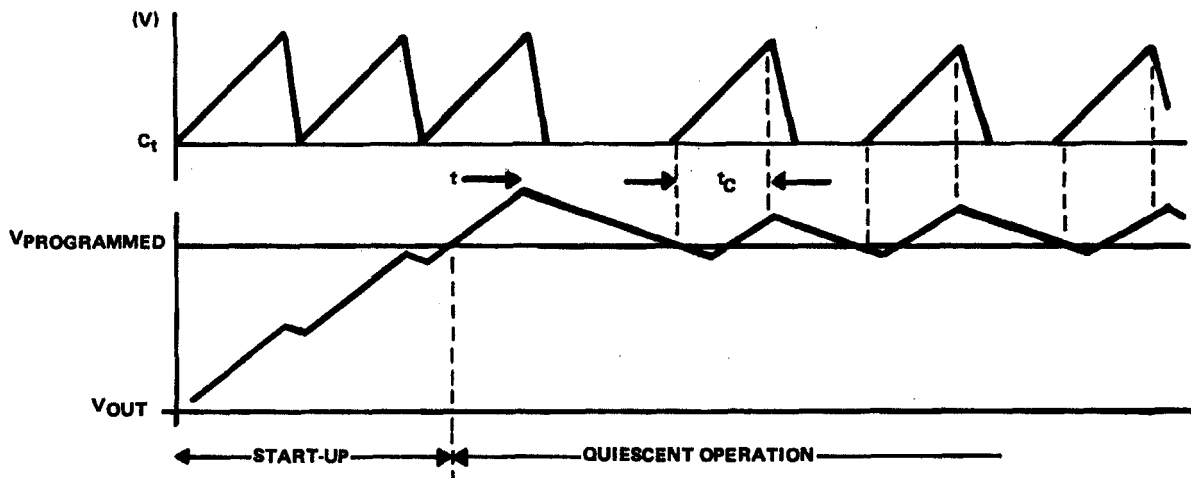

FIGURE 4. Typical  $C_T$  Voltage Waveform During Start-Up and Quiescent Operation

Table II. On-Time Vs.  $C_T$

| $C_T$ (pF)       | 200 | 250 | 350 | 400 | 500 | 750 | 1000 | 1500 | 2000 |
|------------------|-----|-----|-----|-----|-----|-----|------|------|------|
| $t_C$ ( $\mu$ s) | 19  | 22  | 26  | 32  | 44  | 56  | 80   | 120  | 180  |

period after the charge/discharge cycle of  $C_T$ . Under these conditions the operating frequency becomes dependent on the load requirement and  $C_T$  only determines the ON time ( $t_{ON}$ ) which remains constant. Thus the duty cycle is modulated by the changing frequency. The on-time of the switching transistor coincides with  $t_C$  as shown in Table II.

#### Current Limiting

Current limiting is accomplished with the current-limit control provided. The voltage developed across the user selected series current limit resistor ( $R_{CL}$ ) is sensed. When this voltage becomes greater than one  $V_{BE}$  drop (0.5 V typically) the current limit circuitry provides an additional current path to charge the timing capacitor. This, in effect, shortens the on-time of the switching transistor and reduces the amount of energy developed in the inductor. This can be observed as an increase in the slope of the charging portion of the charge/discharge cycle of the timing capacitor (Figure 5). With current limiting, saturation of the power inductor may be prevented and soft start-up achieved. If not used, the current limit sense should be tied to  $V_{CC+}$  (pin-14).

#### Pass Transistor

The switching transistor provided in the TL497A is a high-gain device designed to switch up to 500 mA peak using the base drive circuitry provided by the TL497A. Access to the internal base current limiting resistor is made available, however, it is not recommended the base drive circuitry be tampered with. The emitter and collector are brought out also, for user versatility.

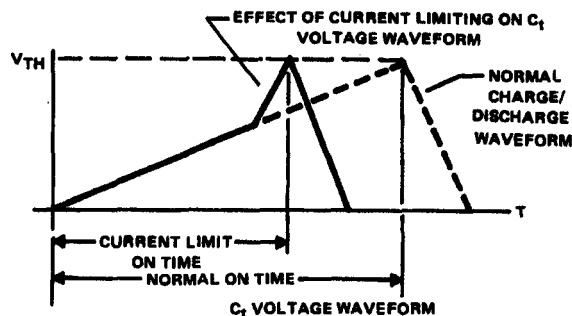

FIGURE 5.  $C_T$  Voltage Waveform

#### Catch Diode

An uncommitted catch diode capable of operating at peak currents to 500 mA is available for commutation and blocking purposes, however, an external diode may be desired for optimum circuit performance.

#### Enable Circuitry

Shutdown circuitry is provided for external control which allows the user to enable and disable the TL497A by an external TTL logic command. A logic high disables the TL497A and turns off the switching transistor. A logic low enables the TL497A and allows it to operate according to the previous discussion.

## DESIGN AND OPERATION of a STEP-DOWN SWITCHING VOLTAGE REGULATOR

The circuit in Figure 6 shows the basic configuration for a step-down switching voltage regulator. A thorough understanding of this circuit is necessary to optimize the design of a step-down switching voltage regulator using the TL497A.

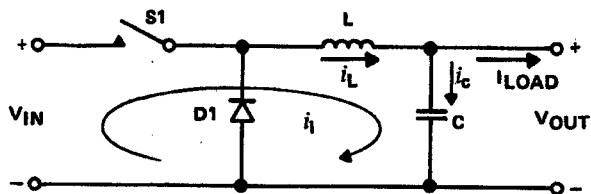

FIGURE 6. Basic Step-Down Regulator

First, define the initial conditions (prior to the closing of S1).

Initial Conditions ( $t = 0^-$ ):

$$V_C = V_{OUT}$$

$$i_L = 0$$

When the switch S1 is closed, the current in the inductor and the voltage across the filter capacitor (C) cannot change instantaneously.

at S1 closed ( $t = 0^+$ ):

$$V_C = V_{OUT}$$

$$i_L = i_1 = 0$$

Writing a loop equation around the circuit

$$V_{in} = R_s i_1 + L \frac{di_1}{dt} + V_C$$

Substituting  $i_1 = 0$  and  $V_C = V_{out}$  at  $t = 0^+$

$$V_{in} = L \frac{di_1}{dt} + V_{out}$$

Therefore 
$$\frac{di_1}{dt} = \frac{V_{in} - V_{out}}{L}$$

The current through the inductor ( $i_L$ ) at any given time (t) is

$$I = \frac{V_{in} - V_{out}}{L} t$$

For a constant  $V_{IN}$ ,  $V_{OUT}$ , and  $L$ ,  $I$  varies linearly with  $t$ .

The current increases while S1 is closed according to the waveform shown in Figure 7. The peak current in the inductor, therefore, is dependent on the period of time S1 is closed, which is the on-time of the switch ( $t_{ON}$ ).

$$\therefore I_{pk} = \frac{V_{in} - V_{out}}{L} t_{ON}$$

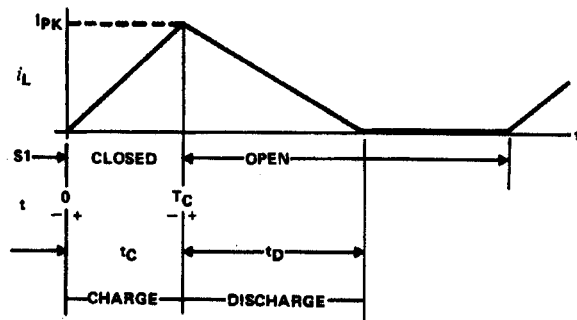

FIGURE 7. Inductor Current Waveform

When S1 opens ( $t = t_{C+}$ ), the current through the inductor is  $I_{pk}$  since the current cannot change instantaneously, the voltage across the inductor inverts, and the blocking diode (D1) is forward biased to provide a current path for the discharge of the inductor into the load and filter capacitor. The inductor current then discharges linearly as illustrated in Figure 7.

Prior to S1 open ( $t = T_C^-$ )

$$i_L = I_{pk}$$

$$V_C = V_{OUT}$$

At S1 open ( $t = T_C^+$ )

$$i_L = I_{pk}$$

$$V_C = V_{OUT}$$

Writing a loop equation for  $i_1$

$$V_f + L \frac{di_1}{dt} + V_C = 0$$

Substituting the conditions at  $t = T_C^+$  and assuming  $V_f$  of D1 is 0 V:

$$L \frac{di_1}{dt} = -V_{OUT}$$

∴ the current through the inductor for  $t > T_C$

$$i_L = I_{pk} - \frac{V_{OUT}}{L} (t - T_C)$$

The discharge time of the inductor then is that time required for  $i_L = 0$ . Therefore

$$t_D = \frac{I_{pk}}{V_{OUT}} L$$

Analyzing for a moment the currents at the inductor/capacitor/output node.

$$i_L = i_C + I_{load}$$

if  $I_{load}$  is considered constant.

$$\Delta i_C = \Delta i_L = I_{pk}$$

when  $i_L = I_{load}; i_C = 0$

when  $i_L = 0; i_C = -I_{load}$

Thus the inductor and capacitor current waveforms relate to each other as shown in Figure 8.

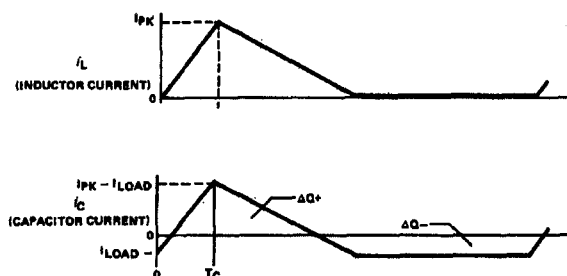

FIGURE 8. Inductor Current and Capacitor Current Waveforms

For the output voltage to remain constant, the net charge delivered to the filter capacitor must be zero. This means that the charge delivered to the capacitor from the inductor must be dissipated in the load. Since the charge developed in the inductor is fixed (constant on time), the time required for the load to dissipate that charge will vary with the load requirements. The actual operating frequency is therefore dependent on the load requirements. The actual frequency can be determined by studying the current waveform of the filter capacitor. The charge delivered to the capacitor and the charge dissipated by the load are equal to the areas under the capacitor current waveform above and below  $i_C = 0$  respectively, as shown in Figures 9 and 10.

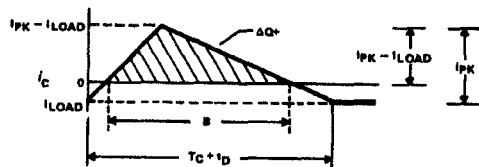

FIGURE 9. Capacitor Current Waveform ( $\Delta Q+$ )

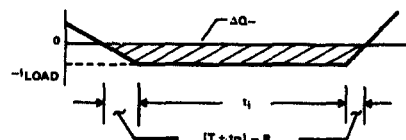

FIGURE 10. Capacitor Current Waveform ( $\Delta Q-$ )

$$B = \frac{I_{pk} - I_{load}}{I_{pk}} (T_C + t_D)$$

$$\Delta Q+ = \frac{1}{2} \frac{(I_{pk} - I_{load})^2}{I_{pk}} (T_C + t_D)$$

$$\Delta Q- = [I_{load} t_i] + \frac{1}{2} \left[ (T_C + t_D) - \frac{I_{pk} - I_{load}}{I_{pk}} (T_C + t_D) \right] I_{load}$$

Setting  $\Delta Q+$  equal to  $\Delta Q-$  and solving for  $t_i$

$$t_i = \frac{(I_{pk} - 2I_{load})(T_C + t_D)}{2I_{load}}$$

To determine the frequency of oscillation, total the durations of the previous portions of the regulator's cycle,  
 $T = T_C + t_D + t_i$

$$\therefore T = (T_C + t_D) \frac{1}{2} \frac{I_{pk}}{I_{load}}$$

Knowing the period

$$\text{frequency} = \frac{1}{T}$$

The  $\Delta Q$  calculations also yield the voltage change experienced by the output capacitor C.

$$V_C = \frac{1}{C} \int idt \text{ or } \frac{\Delta Q}{C}$$

$$\Delta V_C = \frac{1}{2C} \frac{(I_{pk} - I_{load})^2}{I_{pk}} \frac{T_C V_{IN}}{V_{OUT}}$$

Note this accounts for the ripple voltage contributed by the ripple current present in the switching regulator seen by an ideal capacitor. Realistically the capacitor will have an equivalent series resistance (ESR) which establishes the minimum ripple voltage achievable.



$$V_{\text{RIPPLE (MIN)}} = I_{\text{pk}} (\text{ESR})$$

When the filter capacitor size has been increased such that  $\Delta V_C \approx V_{\text{RIPPLE (MIN)}}$  additional increases in C will net insignificant reduction in  $V_{\text{RIPPLE}}$ . It is important therefore to employ a filter capacitor with minimal ESR. Note, however, due to its architecture some ripple voltage is required for proper operation of the regulation circuit.

### SUMMARY

The previous derivations have assumed that the regulator is operating in the discontinuous mode. This means the inductor current is discontinuous ( $I_L = 0$ ). When the load is continually increased, the idle time ( $t_i$  in Figure 10) decreases to the point where the regulator initiates a charge cycle at or before the complete discharge of the inductor. This condition is called the continuous mode of operation ( $I_L$  never equals 0,  $t_i = 0$ ). In this mode a dc idle current is passed through the inductor. The TL497A is not designed to operate in this mode without special considerations given to the circuit design. To determine the load current where the circuit transforms from the discontinuous mode to the continuous mode of operation, refer to Figure 8. The point of transition occurs, when the inductor starts charging as soon as it completes the previous discharge cycle ( $t_i = 0$ ). Under these conditions the capacitor current waveform is as shown in Figure 11. Setting  $t_i = 0$  and solving for  $I_{\text{OUT}}$ :

$$I_{\text{OUT}} = \frac{I_{\text{pk}}}{2}$$

Hence  $I_x = \frac{I_{\text{pk}}}{2}$

Where  $I_x$  is the load current at which the inductor current is continuous and the regulator enters the continuous mode.

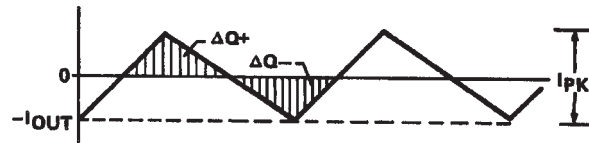

FIGURE 11. Capacitor Current Waveform (Continuous Mode)

Summarizing:

for the step-down switching regulator

$$I_{\text{pk}} > 2 I_{\text{load}} \quad (\text{for discontinuous operation})$$

$$L = \frac{V_{\text{IN}} - V_{\text{OUT}}}{I_{\text{pk}}} t_{\text{ON}}$$

$$f_0 = \frac{2 I_{\text{load}}}{I_{\text{pk}}} \cdot \frac{V_{\text{OUT}}}{t_{\text{ON}} V_{\text{IN}}}$$

where:  $t_{\text{D}} = \frac{I_{\text{pk}}}{V_{\text{OUT}}} L$

$$t_i = \frac{[I_{\text{pk}} - 2 I_{\text{load}}]}{2 I_{\text{load}}} \cdot \frac{t_{\text{ON}} V_{\text{IN}}}{V_{\text{OUT}}}$$

$$C = \frac{(I_{\text{pk}} - I_{\text{load}})^2}{V_{\text{RIPPLE}} 2 I_{\text{pk}}} \cdot \frac{t_{\text{ON}} V_{\text{IN}}}{V_{\text{OUT}}}$$





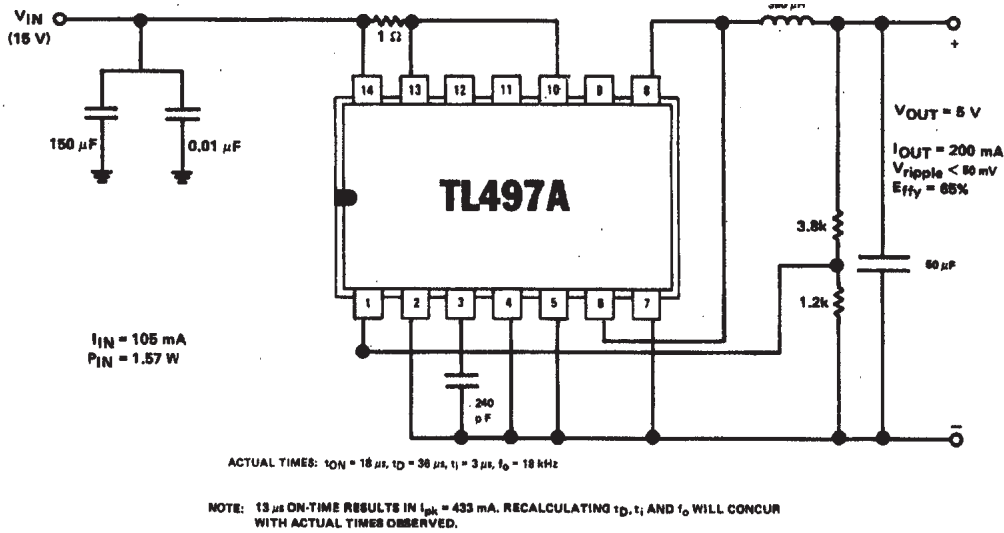

FIGURE 13. 15 Volt to 5 Volt Switching Regulator for Output Currents to 200 mA

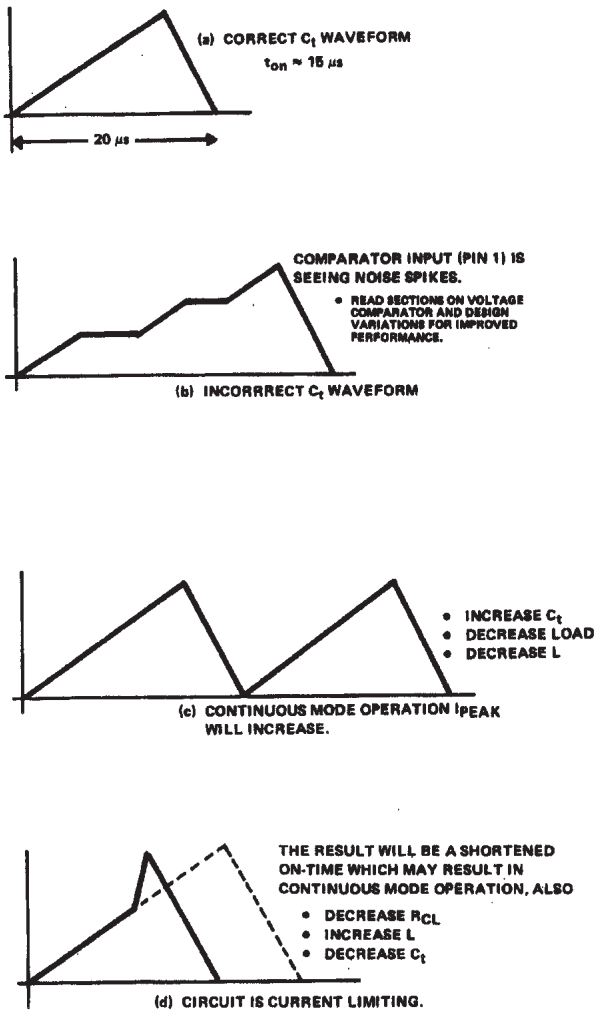

FIGURE 14. Circuit Performance Waveforms

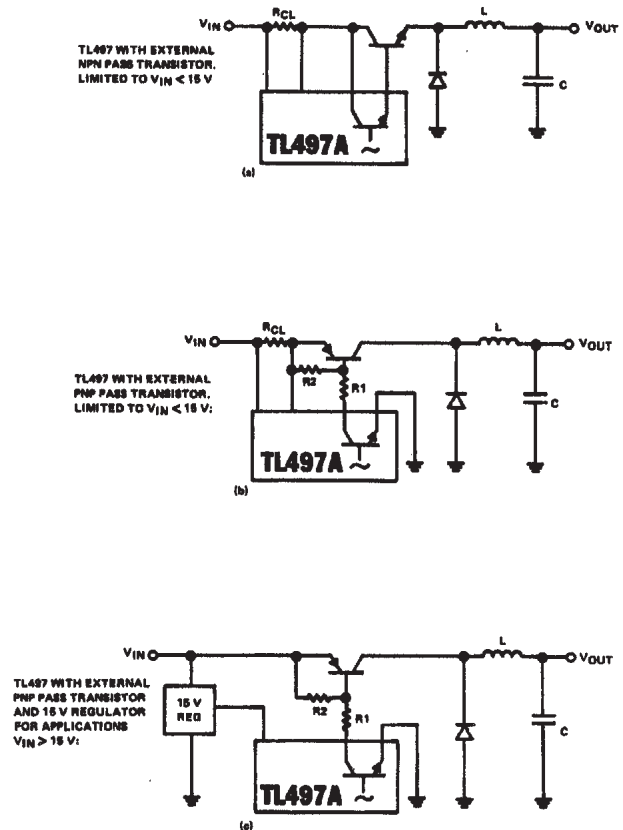
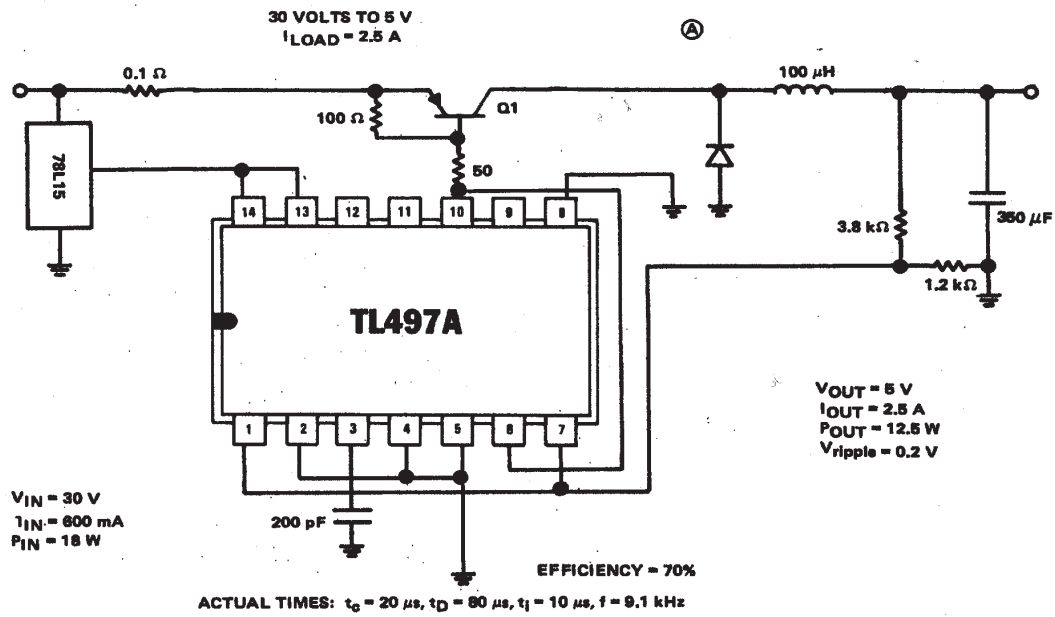

FIGURE 15. Techniques for Obtaining Peak Currents Greater Than 500 mA



Ⓐ THE USE OF THE INTERNAL DIODE (PINS 6 AND 7) TO CLAMP THE FEEDBACK AND PROTECT AGAINST NOISE IS DISCUSSED IN A LATER CHAPTER [DESIGN VARIATIONS FOR IMPROVED PERFORMANCE].

FIGURE 16. TL497A in High-Voltage–High-Current Applications

The advent of logic or gate array devices brings about the need of a good regulated low voltage power supply. These arrays may have up to 800 inverters or gates per array. Normally the power requirements are 20 volts at about 200 mA, per array. The input requirement is usually 5.0 volts. This circuits meets the above requirements at an overall efficiency of 72%.

Figure 18 is another step-down regulator. With an input of from 7V to 12V it has an output of 5 volts at 2.0 amps. The TIP34 is a plastic TO-220 PNP transistor of 10 amp capacity. The IN5187D is a 3.0 amp fast recovery diode.

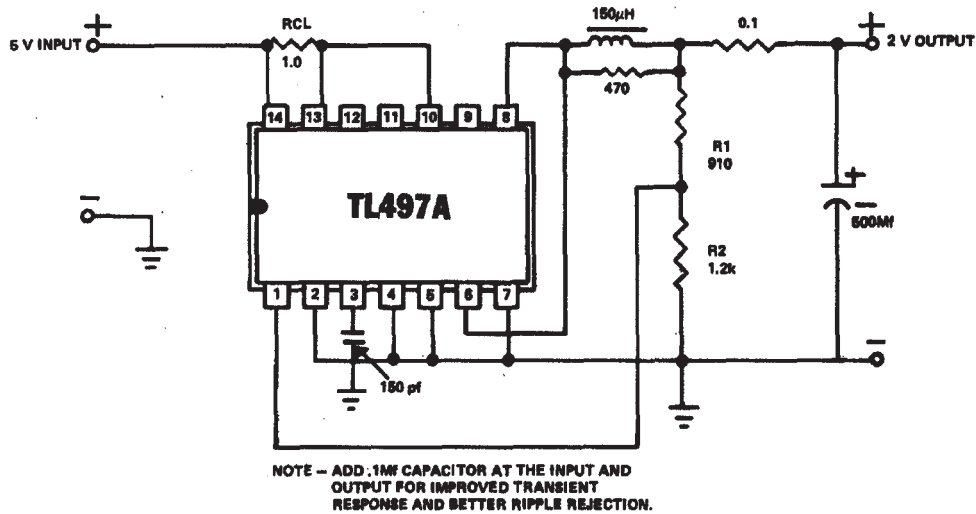

FIGURE 17. TL497A Logic Array Power Supply, Step-Down Circuit

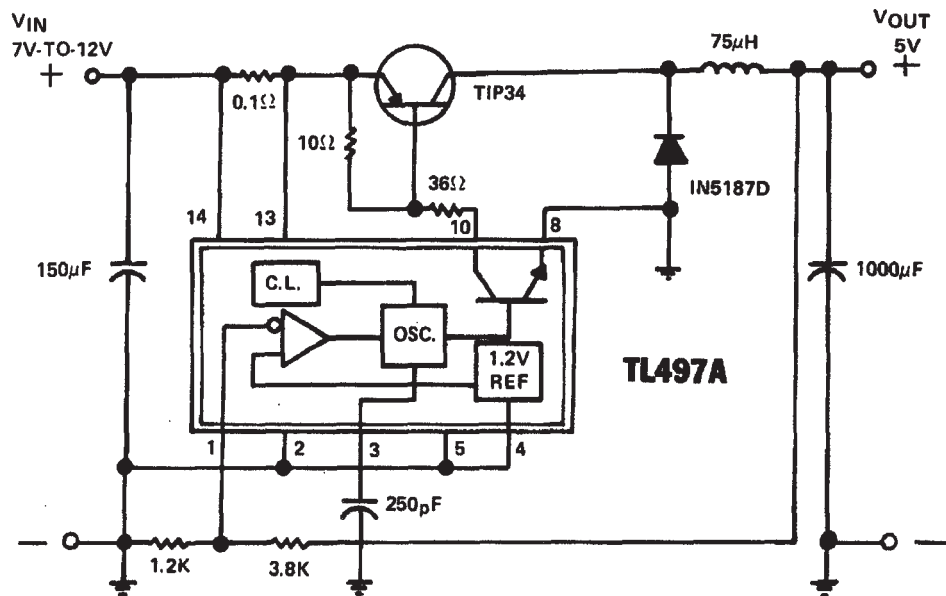

FIGURE 18. Step-Down Regulator

## DESIGN AND OPERATION of a STEP-UP SWITCHING VOLTAGE REGULATOR

In the step-up regulator, the formulae change slightly. Note the basic circuit configuration in Figure 19.

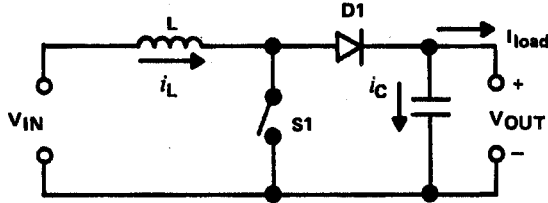

FIGURE 19. Basic Step-Up Regulator Circuit

During the charging cycle (S1 closed) the inductor (L) is charged directly by the input potential.

$$i_L = \frac{V_{IN}}{L} t_C$$

thus 
$$I_{pk} = \frac{V_{IN}}{L} t_{ON}$$

In the step-up application however, the peak current is not related to the load current as in the previous application. This is attributed to the fact that during the inductor charge cycle the blocking diode D1 is reverse biased and no charge is delivered to the load. The circuit in Figure 19 delivers power to the load only during the discharge cycle of the inductor (when S1 is open). The diode D1 is forward biased and the inductor discharges into the load capacitor. The potential across the inductor during this phase of the charge/discharge cycle is  $V_{OUT} - V_{IN}$ . The discharge time of the inductor then becomes:

$$t_D = \frac{I_{pk}}{V_{OUT} - V_{IN}} L$$

To determine the peak current relation to the load current, review the inductor and capacitor current waveforms shown in Figure 20.

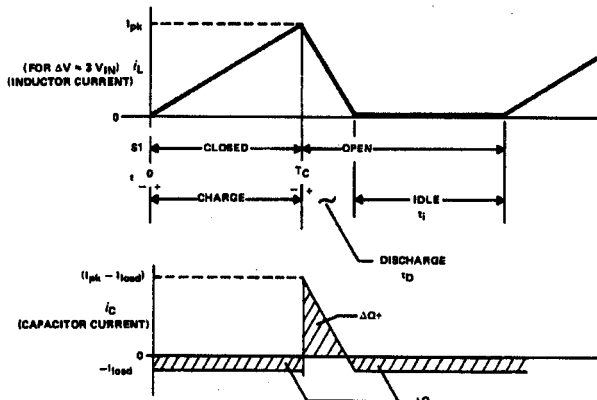

FIGURE 20. Inductor and Capacitor Current Step-Up Regulator

Studying the current waveforms ( $I_L$  and  $I_C$ ) and recalling  $\Delta Q+$  must equal  $\Delta Q-$  for the potential across the load capacitor to remain constant, the relation of peak current to load current can be determined. Approaching it as  $\Delta Q$  is the area under the respective curves, maximum load current for discontinuous operation ( $t_i = 0$ ) relates to the peak current as:

$$I_{load} = \frac{I_{pk} t_D}{2(t_D + t_C)}$$

Peak inductor current can be related to load current by:

$$I_{pk} = \frac{2 I_{load} (t_D + t_C)}{t_D}$$

To ease calculation of  $I_{pk}$  without prior calculation of  $t_D$ ,  $t_C$  and  $t_D$  may be substituted for by their voltage ratios. Equating the charge/discharge times ( $t_C/t_D$ ), it will be noted that the charge to discharge ratio is proportional to the ratio of the input/output differential to input voltage ratio.

$$\frac{t_D}{t_C} = \frac{V_{IN}}{V_{OUT} - V_{IN}}$$

$$t_D = t_C \frac{V_{IN}}{V_{OUT} - V_{IN}}$$

setting  $t_D = 1$

$$t_C = \frac{V_{OUT} - V_{IN}}{V_{IN}}$$

$$\therefore I_{pk} = 2 I_{load} \left[ 1 + \frac{V_{OUT} - V_{IN}}{V_{IN}} \right]$$

which reduces to:

$$I_{pk} = 2 I_{load} \frac{V_{OUT}}{V_{IN}}$$

From the capacitor current waveform of Figure 20, the remaining performance factors may be determined.

Setting  $\Delta Q^+$  equal to  $\Delta Q^-$  and solving for  $t_i$  where  $I_{load} < I_{load(max)}$  ( $t_i$  is not 0).

$$t_i = \frac{I_{pk} t_D}{2 I_{load}} - (t_D + t_C)$$

$$V_{ripple} = \frac{(I_{pk} - I_{load})^2}{2 C I_{pk}} T_D$$

Summarizing:

For the step-up voltage regulator

$$I_{pk} = 2 I_{load} \left[ \frac{V_{OUT}}{V_{IN}} \right]$$

$$L = \frac{V_{IN}}{I_{pk}} t_{ON}$$

$$f_0 = \frac{2 I_{load}}{I_{pk} t_D}$$

$$C = \frac{(I_{pk} - I_{load})^2}{V_{ripple} 2 I_{pk}} T_D$$

$$T_D = t_{ON} \left[ \frac{V_{IN}}{V_{OUT} - V_{IN}} \right]$$

## A STEP-UP SWITCHING REGULATOR DESIGN EXERCISE with TL497A

Figure 21 is the basic step-up regulator using the TL497A.

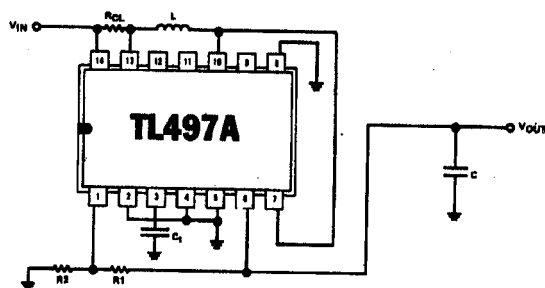

FIGURE 21. Basic Step-Up Regulator Using the TL497A

Conditions:

$$V_{IN} = 5 \text{ V}$$

$$V_{OUT} = 15 \text{ V}$$

$$I_{OUT} = 75 \text{ mA}$$

$$V_{ripple} < 1\%$$

Calculations:

$$I_{pk} > 2 I_{load} \left[ \frac{V_{OUT}}{V_{IN}} \right]$$

$$I_{pk} > 450 \text{ mA}$$

For design margin  $I_{pk} \rightarrow 500 \text{ mA}$

$$L = \frac{V_{IN}}{I_{pk}} t_{ON}$$

$$L = \frac{5}{500 \times 10^{-3}} t_{ON}$$

Recommended on-time is;  $19 \mu\text{s} < t_{ON} < 150 \mu\text{s}$ , thus the range of acceptable inductance is;  $190 \mu\text{H}$  to  $1.5 \text{ mH}$

choosing  $L = 200 \mu\text{H}$

$$t_{ON} = 20 \mu\text{s}$$

To program the TL497:

$$R_2 = 1.2 \text{ k}\Omega$$

$$R_1 = (15 - 1.2) \text{ k}\Omega = 13.8 \text{ k}\Omega$$

To set the current limiting:

$$R_{CL} = 0.5 / I_{limit}$$

$$R_{CL} = \frac{0.5}{500 \times 10^{-3}} = 1 \Omega$$

For on-time chosen above ( $20 \mu\text{s}$ )  $C_t$  can be estimated;

$$C_t (\text{pf}) \approx 12 t_{ON} (\mu\text{s})$$

$$C_t \approx 240 \text{ pF}$$

or it can be selected from Table II, page 5.

To determine  $C_{filter}$  for desired ripple voltage

$$C = \frac{(I_{pk} - I_{load})^2 T_D}{V_{ripple} 2 I_{pk}}$$

$$T_D = t_{ON} \left[ \frac{V_{IN}}{V_{OUT} - V_{IN}} \right] = 10 \mu s$$

$$C = 12.0 \mu F$$

The nominal operating frequency  $f_0$  is:

$$f_0 = \frac{1}{T} = \frac{2 I_{load}}{I_{pk} T_D}$$

$$f_0 = 30 \text{ kHz}$$

Applying these values to the TL497A results in a schematic as shown in Figure 22.

Figure 23 shows another step-up circuit which will supply 12 volts output at 80 mA with an input of 5 volts.

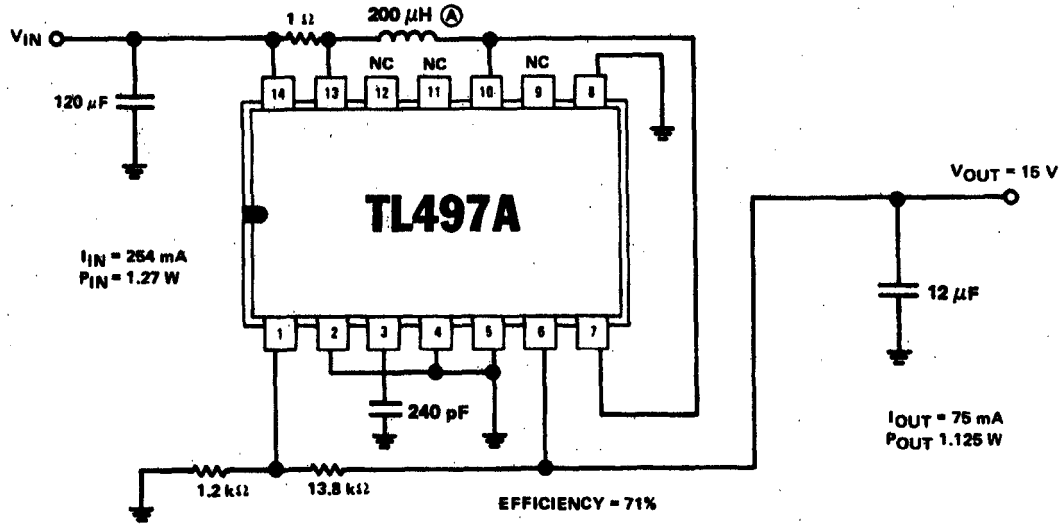

FIGURE 22. 5 Volt to 15 Volt Switching Regulator

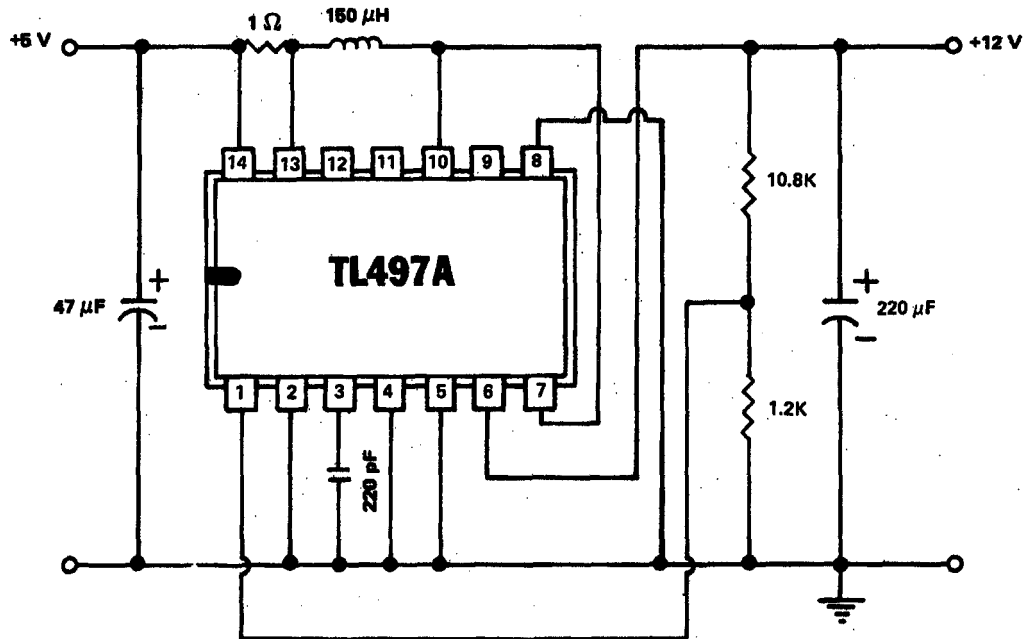

FIGURE 23. TL497A Step-Up Circuit, 5V Input to 12V @ 80mA Output



## DESIGN AND OPERATION OF SWITCHING VOLTAGE REGULATOR IN INVERTING CONFIGURATION

The inverting regulator is similar to the step-up regulator in that during the charging cycle of the inductor, the load is isolated from the input. The only difference is in the potential across the inductor during its discharge. This can best be demonstrated by a review of the basic inverting regulator circuit (Figure 24).

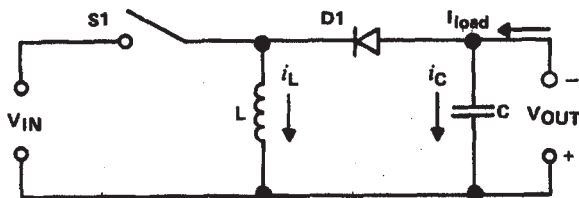

FIGURE 24. Basic Inverting Regulator Circuit

During the charging cycle (S1 closed) the inductor (L) is charged only by the input potential—similar to the step-up configuration.

$$I_{pk} = \frac{V_{IN}}{L} t_{ON}$$

Like the step-up configuration, in the inverting configuration (Figure 25) the input provides no contribution to the load current during the charging cycle and thus the maximum load current for discontinuous operation will be limited by the peak current, in accordance with that observed in the step-up configuration.

$$I_{L \text{ max (discontinuous)}} = \frac{I_{pk} t_D}{2(t_D + t_C)}$$

The discharge rate ( $t_D$ ) however differs due to the difference in the potential across the inductor during its discharge which is  $V_{OUT}$ .

$$\therefore t_D = \frac{I_{pk}}{|V_{OUT}|} L$$

To simplify calculation of  $I_{pk}$  from  $I_{load}$ :

$$I_{pk} = \frac{V_{IN}}{L} t_C = \frac{|V_{OUT}|}{L} t_D$$

$$\therefore \frac{t_D}{t_C} = \frac{V_{IN}}{V_{OUT}}$$

Substituting this into the expression for  $I_{L \text{ max}}$  and simplifying:

$$I_{pk} = 2 I_{load} \left( 1 + \frac{|V_{OUT}|}{V_{IN}} \right)$$

The current waveforms in the inverting configuration look identical to those demonstrated in the step-up configuration. The same formulae therefore apply for  $t_i$ ,  $I_{L \text{ max}}$  (discontinuous) and  $V_{ripple}$ .

Summarizing:

For the inverting regulator:

$$I_{pk} \geq 2 I_{load} \left( 1 + \frac{|V_{OUT}|}{V_{IN}} \right)$$

$$L = \frac{V_{IN}}{I_{pk}} t_{ON}$$

$$f_0 = \frac{2 I_{load}}{I_{pk} t_D}$$

$$C = \frac{(I_{pk} - I_{load})^2}{V_{ripple} 2 I_{pk}} \cdot t_D$$

where:

$$t_D = t_{ON} \frac{V_{IN}}{|V_{OUT}|}$$

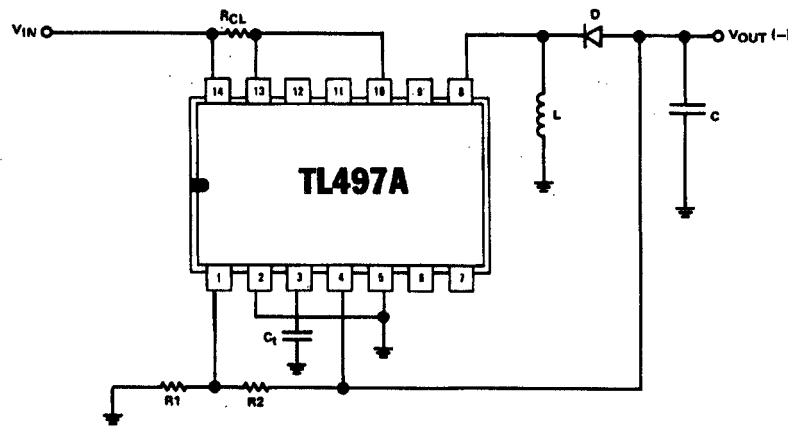

FIGURE 25. Basic Inverting Regulator

**AN INVERTING REGULATOR  
DESIGN EXERCISE  
with  
TL497A**

Conditions:

$$V_{IN} = 5 \text{ V}$$

$$V_{OUT} = -5 \text{ V}$$

$$I_{OUT} = 100 \text{ mA}$$

Calculations:

$$I_{pk} \geq 2 I_{load} \left( 1 + \frac{|V_{OUT}|}{V_{IN}} \right)$$

$$I_{pk} \geq 400 \text{ mA}$$

For design margin  $I_{pk} \rightarrow 500 \text{ mA}$

$$L = \frac{V_{IN}}{I_{pk}} t_{ON}$$

$$L = \frac{5}{500 \times 10^{-3}} t_{ON}$$

Recommended on-time:  $19 \mu\text{s} < t_{ON} < 150 \mu\text{s}$ , thus the range of acceptable inductance is;  $190 \mu\text{H}$  to  $1.5 \text{ MH}$

choosing  $L = 200 \mu\text{H}$

$$t_{ON} = 20 \mu\text{s}$$

To program the TL497:

$$R_2 = 1.2 \text{ k}\Omega$$

$$R_1 = (5 - 1.2) = 3.8 \text{ k}\Omega$$

To set the current limiting:

$$R_{CL} = 0.5 / I_{limit}$$

$$R_{CL} = \frac{0.5}{500 \times 10^{-3}} = 1 \Omega$$

For the  $t_{ON}$  chosen above ( $20 \mu\text{s}$ )  $C_t$  can be estimated;

$$C_t (\text{pf}) \approx 12 t_{ON} (\mu\text{s})$$

$$\therefore C_t = 240 \text{ pF}$$

or it can be selected from Table II, page 5.

To determine  $C_{filter}$  for desired ripple voltage:

$$C = \frac{(I_{pk} - I_{load})^2}{V_{ripple} 2 I_{pk}} \cdot T_D$$

$$t_D = t_{ON} \frac{V_{IN}}{V_{OUT}} = 20 \mu\text{s}$$

$$C_{filter} = 64 \mu\text{F}$$

The nominal operating frequency  $f_0$  is:

$$f_0 = \frac{2 I_{load}}{I_{pk} T_D}$$

$$f_0 = 20 \text{ kHz}$$

Applying these values to the TL497A will give results as shown in Figure 26.

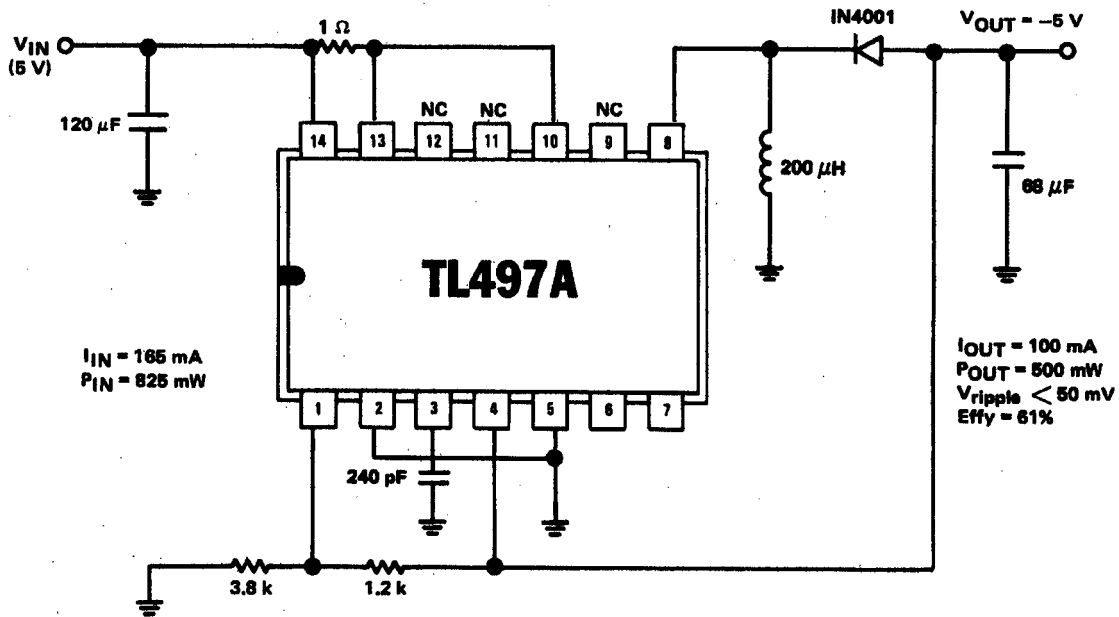

\*NOTE - DO NOT USE INTERNAL DIODE (PINS-6, 7) FOR CATCH DIODE ON AN INVERTING CIRCUIT.

FIGURE 26. +5 Volt to -5 Volt Switching Regulator

SPECIAL TL497A CIRCUITS

The following are several TL497A circuits that do not fall strictly in a step-up or step down category but rather a combination of both types.

Figure 27 is an automotive power supply built to supply 8.5 volts regulated to power a microprocessor board. During low voltage conditions (4 volts) it acts as a step-up circuit producing about 11 volts at the positive side of the 1000 µF capacitor. When a high voltage

condition exists (15 volts) it acts as a step-down circuit still giving about 11 volts to the capacitor. This 11 volts then is regulated to the desired 8.5 volts by a µA 7885 3-terminal regulator.

Figure 28 is a dual output circuit producing both a +12V and -12V from a +5 volt input to the supply. While not supplying a large amount of current it will put out about 12 mA of current of each voltage polarity.

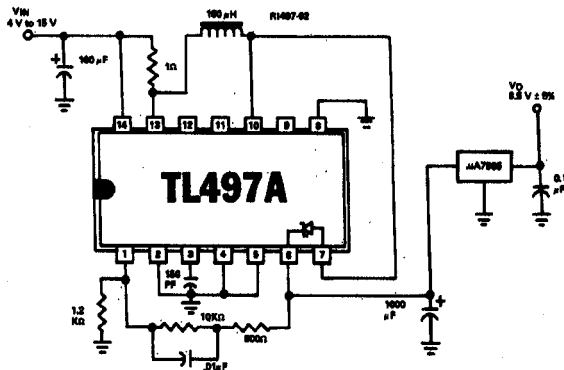

FIGURE 27. 12V To 8.5V Step-Up/Down Circuit

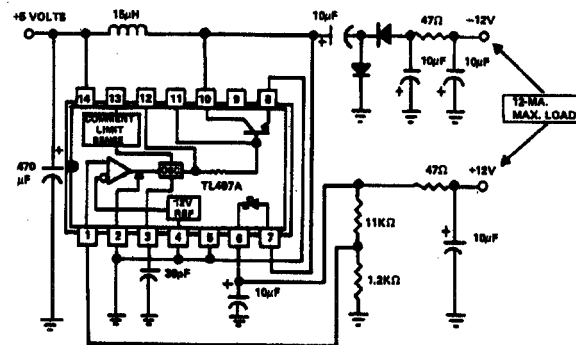

FIGURE 28. TL497A Dual Supply +12 Volts and -12 Volts From +5 Volts

### DESIGN VARIATIONS FOR IMPROVED PERFORMANCE

#### Improving Efficiency

The dominant contribution by the TL497A to the overall efficiency of the switching regulator is the  $V_{CE(SAT)}$  of the transistor switch. Recall, the previous sections have considered the switch to be ideal ( $V_{CE(SAT)} = 0V$ ), this is not the case in the real world. As the  $V_{CE(SAT)}$  increases the circuit efficiency decreases. Consider for a moment the basic architecture of the three applications presented herein (see Figure 29).

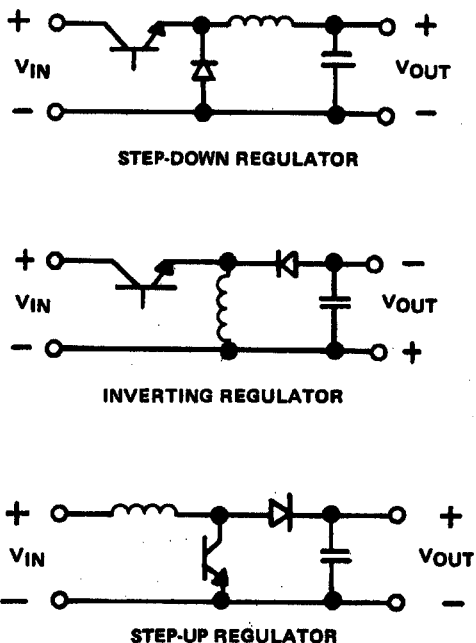

FIGURE 29. Basic Regulator Architectures

Note in all but the step-up regulator the switching transistor is applied to the positive input rail. In these configurations it is impossible to drive the NPN transistor switch into saturation since its base drive circuit resides at a potential lower than its collector potential. Improved performance can be achieved by using an external PNP transistor driven by the internal NPN. (See Figure 30(a, b).)

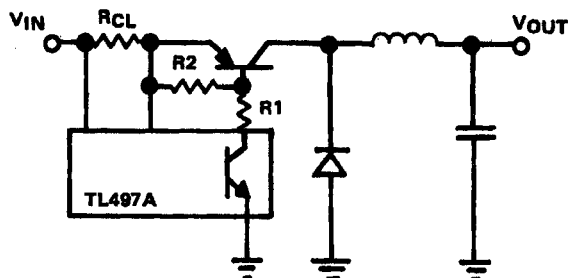
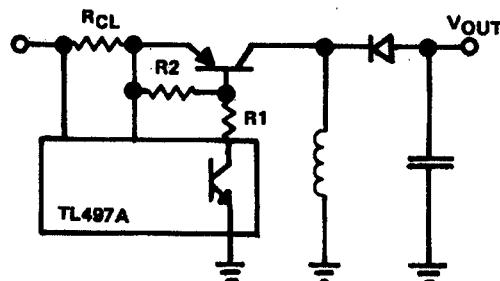

FIGURE 30(a). Step-Down Regulator



INVERTING REGULATOR

$$R1 = \frac{(V_{IN} - 1.5) h_{FE}}{I_{pk}} \quad R2 = \frac{10R1}{V_{IN} - 1.5}$$

FIGURE 30(b). TL497A With External PNP Switch For Improved Performance

#### Improving on Time Stability

The on time is determined by the timing capacitor ( $C_T$ ) and its associated circuitry. The on time cycle (charging of  $C_T$ ) is initiated when the voltage at the feedback input (pin 1) is less than 1.2 volts. During the on time as the timing capacitor is being charged to its internally prescribed peak voltage, the error comparator remains active. If during this period the feedback voltage is increased above 1.2 volts, the on-time cycle will be interrupted. This condition can be the result of a noise spike fed back when the switching transistor turns on. The resulting  $C_T$  waveform is as illustrated in Figure 31.



CORRECT WAVEFORM



INTERRUPTED WAVEFORM

FIGURE 31.  $C_T$  Waveforms

Note the appearance of the charging ramp of the  $C_T$  waveform. It can appear as a few easily defined steps or as numerous, almost undetectable, smaller steps. Another evident condition of the presence of this problem is a jittering on time. This severely degrades the efficiency of the converter circuit as power is lost during each transition of the switching transistor. Solution of this problem is quite simple, clamp the feedback node (pin 1) to less than 1.2 volts during the on-time cycle. Figure 32 shows how this can easily be accomplished with the addition of a single feedback diode.

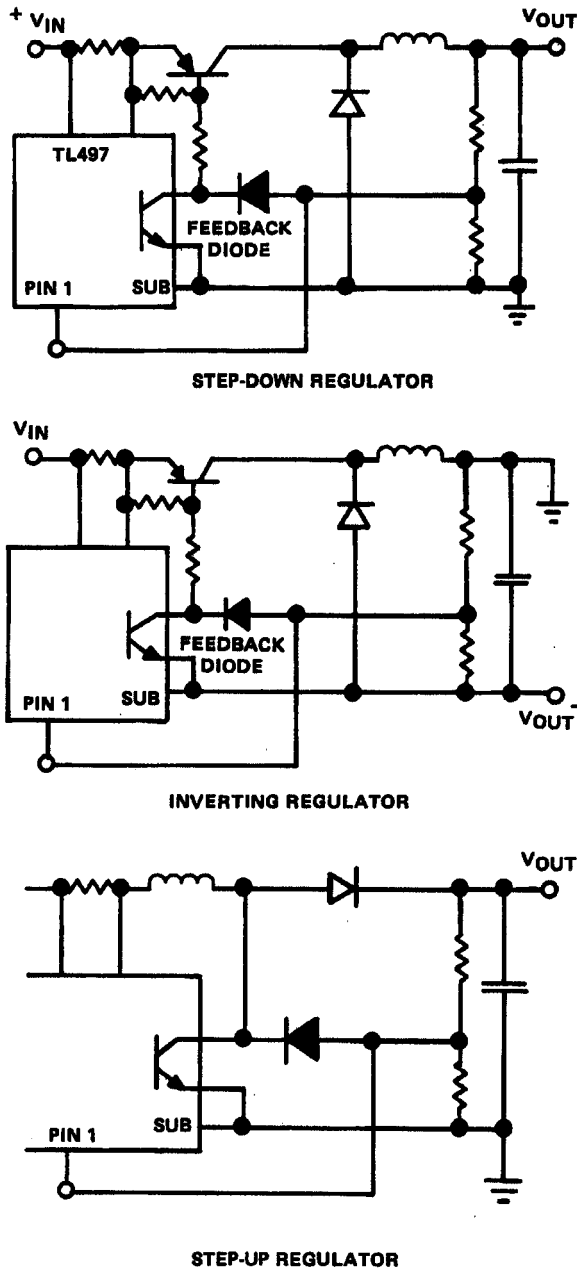

FIGURE 32. Basic Regulator with Feedback Diodes

The function of the feedback diode is simple. When the on-time cycle is initiated, the internal switching transistor turns on. Note that in all three configurations of Figure 32 the emitter of the internal switch is tied to the substrate pin [ground or  $V_{OUT} (-)$ ]. When the internal switch turns on, the feedback diode is forward biased and the feedback signal is clamped at approximately 0.8 volt ( $V_{CE (SAT)} \sim 0.3 \text{ V}$ ,  $V_F \sim 0.5 \text{ V}$ ), which is less than the 1.2 volts reference. Voltage spikes or noise appearing at the output will not be reflected at pin 1 as the diode clamp holds the feedback at 0.8 volt. Thus a clean on-cycle will result. At the conclusion of the on cycle, the internal switch turns off the diode reverse biases and the feedback voltage returns to its voltage prescribed by the resistor ladder and  $V_{OUT}$ . If not used as the flyback diode the internal diode is quite satisfactory for this application.

**Ringing**

An oscilloscope is a must when building a switching power supply with this or any other circuit. It is good to first obtain the correct waveform on the oscillator ramp (pin # 3). (See Figure 32 and Figure 14.) Next look at the switched waveform on the collector of switch (pin 10). See Figure 33. These must be correct or the circuit will not function properly. If ringing is noticed on the switched waveform (pin 10) it can be reduced by placing a 470 to 1000 ohm resistor directly across the inductor to more rapidly dump the coil current when the switch is off.

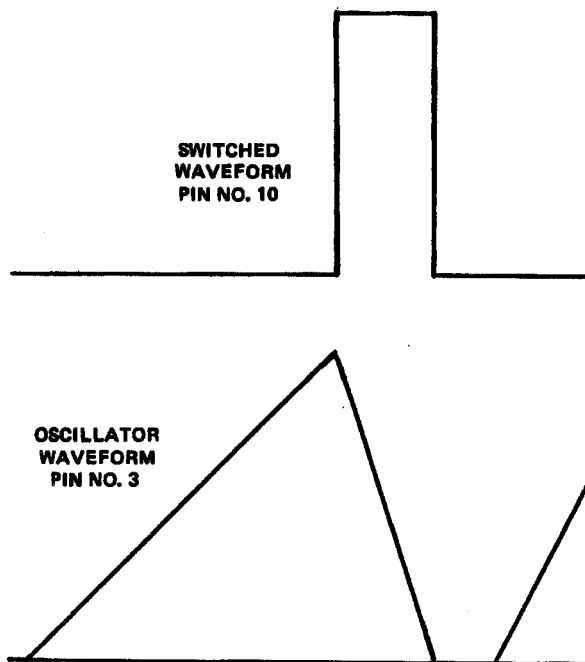

FIGURE 33.

## EXTENDED VOLTAGE OPERATION

It is sometimes desirable to operate the TL497A from a voltage higher than the maximum voltage rating of 15.0 volts as per the specification. This may be accomplished with few parts, chiefly a TL783 regulator and a diode as shown in Figure 34. The TL783 output voltage chosen should be lower than the output voltage of the supply. The TL783 will provide a reference voltage to the TL497A until the  $V_{OUT}$  comes up. DFB then forward biases, thus supplying the TL497A and shutting back the TL783 regulator. The residual power consumption is only about 5.0 mA in the TL783 circuit.

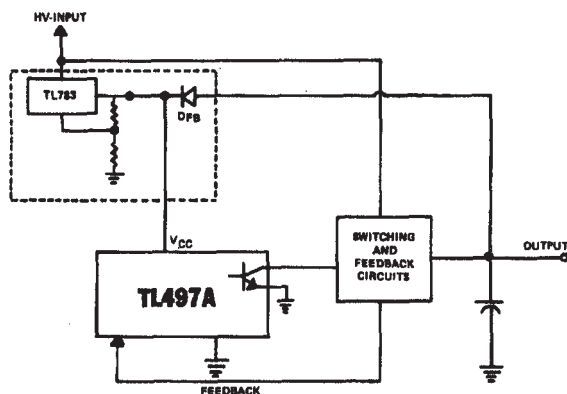
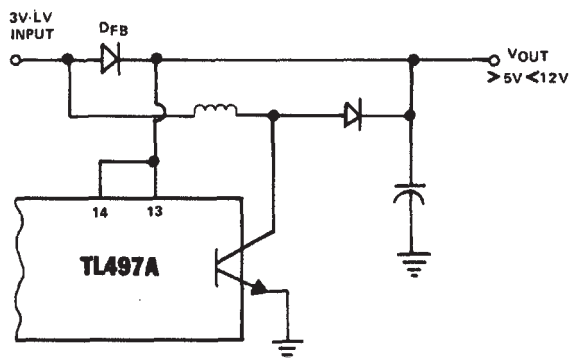

FIGURE 34.

## LOW VOLTAGE OPERATION

In some occasions there is a need to operate from a voltage lower than the minimum voltage rating of the TL497A which is 4.5 volts. Since the oscillator will run with less than 3 volts  $V_{CC}$ , regulation may be accomplished with a circuit similar to Figure 35. With the application of 3 volts, the diode DFB forward biases furnishing  $V_{CC}$  to the oscillator of the TL497A. This causes the switching transistor to operate and steps the voltage up to its designed output. (4.5 V – 15 V) Once  $V_{OUT}$  comes up higher than 3.0 volts, DFB is reversed biased and  $V_{CC}$  to the TL497A is now furnished by its own output voltage.



NOTE-1 - SINCE ONLY THE OSCILLATOR SECTION WILL FUNCTION ON A 3.0 VOLT SUPPLY, THE REMAINDER OF THE CHIP IS INOPERATIVE. THE COMPLETE CIRCUIT WILL FUNCTION WHEN  $V_{OUT}$  REACHES ABOUT 4.5 VOLTS.

FIGURE 35.

## SWITCHING REGULATOR DESIGN TIPS

The TL497A being a fixed on-time, variable frequency device does not need a "HI-Q" type of inductor.\* "HI-Q" coils are not desirable due to the TL497A's broad frequency range of operation. If the "Q" is too high, excessive ringing will occur on the output pulse. If when using a coil with a typical "Q" of greater than 10 ringing does occur, a shunt resistance may be placed across the coil to dampen the waveform.

While not necessary, it is highly desirable to use a toroid inductor as opposed to a cylindrical wound coil. The toroid type of winding helps to contain the flux closer to the core and reduce the possible radiation from the supply. A typical inductor of 150  $\mu$ H inductance and capable of handling 0.5 amperes of current would have a D.C. resistance of about 0.6  $\Omega$ . Below is a list of possible inductor sources.

Care should be used in placement of parts and routing of ground connections similar to practices used in constructing R.F. circuits. These techniques will help to prevent unwanted oscillations due to positive feedback or ground loops.

\*NOTE: See the next page for possible inductor sources.

**INDUCTOR SOURCES\***

Reliability, Inc.  
P.O. Box 218370  
Houston, TX 77218  
(713) 492-0550

Coil Craft  
1102 Silver Lake Rd.  
Cary, Ill 60013  
(312) 639-2361

Mini-Magnetics  
453 Ravendale Dr, Unite E  
Mountain View, CA 94043  
(408) 255-7160

Ferroxcube  
5083 Kings Highway  
Saugerties, N.Y. 12477  
(914) 246-2811

Pulse Engineering, Inc.  
P.O. Box 12235  
San Diego, CA 92112  
(714) 279-5900

TRW Inductive Products  
Mr. Austin Profeta  
150 Varick St.  
New York, N.Y.  
(212) 255-3500

West Coast Magnetics, Inc.  
140 San Lazaro  
Sunnyvale, CA 94086  
(408) 733-9853

Microtran Company, Inc.  
145 E. Mineola Avenue  
P.O. Box 236  
Valley Stream, N.Y. 11582  
(516) 561-6050

Cambion  
445 Concord Ave.  
Cambridge, MA 02138  
Telex: 92-1480  
(617) 491-5400

South Haven Coil, Inc.  
P.O. Box 409 Blue Star Highway  
South Haven, Michigan 49090  
AC 616 #637-5201

\*Texas Instruments does not endorse or warrant the  
suppliers referenced.



## APPENDIX

Tables 1 and 2 illustrate the operating range of the TL497A without the addition of an external power transistor. Standard inductor values have been used giving maximum operating frequencies (discontinuous mode) in the range 9 kHz – 103 kHz. Worst case figures for transistor on-state voltage,  $V_{CE(SAT)}$ , and diode forward voltage drop,  $V_f$ , have been assumed throughout giving a conservatively rated output current,  $I_O(max)$ , in the majority of cases.

| Input Voltage<br>$V_{in}$<br>(V) | Output Voltage<br>$V_o$<br>(V) | Output Current<br>$I_{max}$<br>(mA) | Power Transfer<br>$P_{max}$<br>(W) | Feedback Resistors<br>R1 R2 | Inductor<br>L ( $\mu$ H) | Timing Capacitor<br>Ct (pF) | Operating Frequency<br>$f_{max}$<br>(kHz) |
|----------------------------------|--------------------------------|-------------------------------------|------------------------------------|-----------------------------|--------------------------|-----------------------------|---|
| 5.0<br>4.75                      | 6                              | 152<br>143                          | 0.91                               | 4.8K 1.2K                   | 150                      | 220                         | 18.9                                      |
| 5.0<br>4.75                      | 12                             | 79<br>74                            | 0.96                               | 10.8K 1.2K                  | 150                      | 220                         | 33  |
| 5.0<br>4.75                      | 15                             | 64<br>60                            | 0.96                               | 13.8K 1.2K                  | 150                      | 220                         | 35.7                                      |
| 5.0<br>4.75                      | 18                             | 53<br>50                            | 0.96                               | 16.8K 1.2K                  | 150                      | 220                         | 38.5                                      |
| 5.0<br>4.75                      | 24                             | 40<br>38                            | 0.96                               | 22.8K 1.2K                  | 150                      | 220                         | 40  |
| 5.0<br>4.75                      | 30                             | 32<br>30                            | 0.96                               | 28.8K 1.2K                  | 150                      | 220                         | 41.7                                      |
| 5.0<br>4.75                      | -5                             | 98<br>90                            | 0.48                               | 3.8K 1.2K                   | 150                      | 220                         | 30  |
| 5.0<br>4.75                      | -12                            | 57<br>54                            | 0.68                               | 10.8K 1.2K                  | 150                      | 220                         | 37  |
| 5.0<br>4.75                      | -24                            | 34<br>32                            | 0.82                               | 22.8K 1.2K                  | 150                      | 220                         | 41.7                                      |

The following assumptions have been made:

1. Power switch operation at maximum peak current.
2. Worst case transistor and diode conduction losses.
3. Use of standard 150  $\mu$ H inductor and 220 pF timing capacitor.

Note: The 30V and -24V supplies will not give the full output in the worst case since the ratio  $t_c/t_c + t_d$  exceeds the maximum limit of 0.85 defined by the I.C.

*Table 1. TL497A Operation from a 5V Supply*

| Input Voltage<br>$V_{in}$<br>(V) | Output Voltage<br>$V_o$<br>(V) | Output Current<br>$I_{max}$<br>(mA) | Power Transfer<br>$P_{max}$<br>(W) | Feedback Resistors<br>R1 R2 | Inductor<br>L ( $\mu$ H) | Timing Capacitor<br>Ct (pF) | Operating Frequency<br>$f_{max}$<br>(kHz) |
|----------------------------------|--------------------------------|-------------------------------------|------------------------------------|-----------------------------|--------------------------|-----------------------------|---|
| 12                               | 5                              | 250                                 | 1.2                                | 3.8K 1.2K                   | 256                      | 220                         | 22.7                                      |
| 12                               | 10                             | 250                                 | 2.5                                | 8.8K 1.2K                   | 73                       | 220                         | 45.5                                      |
| 12                               | 15                             | 180                                 | 2.7                                | 13.8K 1.2K                  | 439                      | 220                         | 9.8                                       |
| 12                               | 18                             | 151                                 | 2.7                                | 16.8K 1.2K                  | 439                      | 220                         | 16.6                                      |
| 12                               | 24                             | 114                                 | 2.7                                | 22.8K 1.2K                  | 439                      | 220                         | 24.9                                      |
| 12                               | 30                             | 91                                  | 2.7                                | 28.8K 1.2K                  | 439                      | 220                         | 29.8                                      |
| 12                               | -5                             | 159                                 | 0.8                                | 3.8K 1.2K                   | 439                      | 220                         | 14.5                                      |
| 12                               | -12                            | 114                                 | 1.4                                | 10.8K 1.2K                  | 439                      | 220                         | 24.9                                      |
| 12                               | -24                            | 76                                  | 1.8                                | 22.8K 1.2K                  | 439                      | 220                         | 33.2                                      |

Note: Use a standard 220 pF timing capacitor. The assumptions of maximum peak current operation and worst case transistor and diode losses apply.

*Table 2. TL497A Operation from a 12V Supply.*

## IMPORTANT NOTICE

Texas Instruments Incorporated and its subsidiaries (TI) reserve the right to make corrections, modifications, enhancements, improvements, and other changes to its products and services at any time and to discontinue any product or service without notice. Customers should obtain the latest relevant information before placing orders and should verify that such information is current and complete. All products are sold subject to TI's terms and conditions of sale supplied at the time of order acknowledgment.

TI warrants performance of its hardware products to the specifications applicable at the time of sale in accordance with TI's standard warranty. Testing and other quality control techniques are used to the extent TI deems necessary to support this warranty. Except where mandated by government requirements, testing of all parameters of each product is not necessarily performed.

TI assumes no liability for applications assistance or customer product design. Customers are responsible for their products and applications using TI components. To minimize the risks associated with customer products and applications, customers should provide adequate design and operating safeguards.

TI does not warrant or represent that any license, either express or implied, is granted under any TI patent right, copyright, mask work right, or other TI intellectual property right relating to any combination, machine, or process in which TI products or services are used. Information published by TI regarding third-party products or services does not constitute a license from TI to use such products or services or a warranty or endorsement thereof. Use of such information may require a license from a third party under the patents or other intellectual property of the third party, or a license from TI under the patents or other intellectual property of TI.

Reproduction of information in TI data books or data sheets is permissible only if reproduction is without alteration and is accompanied by all associated warranties, conditions, limitations, and notices. Reproduction of this information with alteration is an unfair and deceptive business practice. TI is not responsible or liable for such altered documentation.

Resale of TI products or services with statements different from or beyond the parameters stated by TI for that product or service voids all express and any implied warranties for the associated TI product or service and is an unfair and deceptive business practice. TI is not responsible or liable for any such statements.

Following are URLs where you can obtain information on other Texas Instruments products and application solutions:

| <b>Products</b>  |  | <b>Applications</b> |  |
|------------------|--|---------------------|--|
| Amplifiers       | <a href="http://amplifier.ti.com">amplifier.ti.com</a>             | Audio               | <a href="http://www.ti.com/audio">www.ti.com/audio</a>                   |
| Data Converters  | <a href="http://dataconverter.ti.com">dataconverter.ti.com</a>     | Automotive          | <a href="http://www.ti.com/automotive">www.ti.com/automotive</a>         |
| DSP              | <a href="http://dsp.ti.com">dsp.ti.com</a>                         | Broadband           | <a href="http://www.ti.com/broadband">www.ti.com/broadband</a>           |
| Interface        | <a href="http://interface.ti.com">interface.ti.com</a>             | Digital Control     | <a href="http://www.ti.com/digitalcontrol">www.ti.com/digitalcontrol</a> |
| Logic            | <a href="http://logic.ti.com">logic.ti.com</a>                     | Military            | <a href="http://www.ti.com/military">www.ti.com/military</a>             |
| Power Mgmt       | <a href="http://power.ti.com">power.ti.com</a>                     | Optical Networking  | <a href="http://www.ti.com/opticalnetwork">www.ti.com/opticalnetwork</a> |
| Microcontrollers | <a href="http://microcontroller.ti.com">microcontroller.ti.com</a> | Security            | <a href="http://www.ti.com/security">www.ti.com/security</a>             |
|                  |  | Telephony           | <a href="http://www.ti.com/telephony">www.ti.com/telephony</a>           |
|                  |  | Video & Imaging     | <a href="http://www.ti.com/video">www.ti.com/video</a>                   |
|                  |  | Wireless            | <a href="http://www.ti.com/wireless">www.ti.com/wireless</a>             |

Mailing Address: Texas Instruments  
Post Office Box 655303 Dallas, Texas 75265

Copyright © 2003, Texas Instruments Incorporated