

# Powering OMAP-L132/L138, C6742/4/6, and AM18x with TPS65070

Christian Hoefling

Power Management Products

## ABSTRACT

This document details the design consideration of a power management unit (PMU) solution for the [OMAP-L132/-L138](#) low-power applications processors with a [TPS65070](#) five-channel power management device.

### Contents

1	OMAP-L132/L138 Power and Sequencing Requirements .....	2
1.1	Power Requirements .....	2
1.2	Power-Up Sequence .....	2
1.3	Power-Down Sequence .....	3
2	Sequencing with TPS65070 .....	3
3	Detailed Power Sequence .....	7
4	Test Results .....	7

### List of Figures

1	TPS65070 Power Solution Diagram.....	4
2	Power-Up Sequencing Timing Diagram (1.8-V I/O) .....	5
3	Power-Up Sequencing Timing Diagram (3.3-V I/O) .....	6
4	Startup of DC/DC Converters and LDO2 (DCDC2 = 1.8 V).....	7
5	Startup of LDO1 and LDO2 (DCDC2 = 1.8 V) .....	8
6	Startup of DC/DC Converters and LDO1 (DCDC2 = 3.3 V).....	8
7	Startup of LDO1 and LDO2 (DCDC2 = 3.3 V) .....	9

## 1 OMAP-L132/L138 Power and Sequencing Requirements

### 1.1 Power Requirements

Table 1 summarizes the power requirements for the OMAP-L132/L138 processor.

**Table 1. OMAP-L132/L138 Power Requirements<sup>(1)(2)(3)</sup>**

	Pin Name <sup>(4)</sup>	Voltage	I <sub>MAX</sub>	Tolerance	Sequencing Order	Timing Delay
I/O	RTC_CVDD	1.2 V	1 mA	-25%, +10%	1 <sup>(5)</sup>	n/a
Core	CVDD	1.0 V / 1.1 V / 1.2 V	600 mA	-9.75%, +10%	2	n/a
I/O	VDDARNWA., VDDARNW1, PLL0_VDDA, PLL1_VDDA, SATA_VDD, USB_CVDD, USB0_VDDA12	1.2 V	200 mA	-5%, +10%	3	n/a
I/O	USB0_VDDA18, USB1_VDDA18, DDR_DVDD18, SATA_VDDR, DVDD18	1.8 V	180 mA	±5%	4	n/a
I/O	USB0_VDDA33, USB1_VDDA33	3.3 V	24 mA	±5%	5	n/a
I/O	DVDD3318_A, DVDD3318_B, DVDD3318_C	1.8 V / 3.3 V	50 mA / 90 mA <sup>(6)</sup>	±5%	4 / 5	n/a

<sup>(1)</sup> If using CVDD at fixed 1.2 V, all 1.2-V rails may be combined.

<sup>(2)</sup> If 1.8-V LVCMOS is used, power rails up with the 1.8-V rails. If 3.3-V LVCMOS is used, power it up with the ANALOG33 rails (VDDA33\_USB0/1)

<sup>(3)</sup> There is no specific required voltage ramp rate for any of the supplies LVCMOS33 never exceeds STATIC18 by more than 2 V.

<sup>(4)</sup> SATA, USB1 not available on OMAP-L132.

<sup>(5)</sup> If RTC is not used/maintained on a separate supply, it can be included in the STATIC12 (fixed 1.2 V) group.

<sup>(6)</sup> If DVDD3318\_A, B, and C are powered independently, the maximum power for each rail will be 1/3 the max power shown in this table.

### 1.2 Power-Up Sequence

The power-up sequence is divided into groups of the same voltages.

Use the power-up sequence described in Table 2. DCDC3, DCDC2, LDO1, and LDO2 are part of the automatic power-up sequence.

**Table 2. OMAP-L132/L138 Power Groups**

Order	Group	Voltage
1	RTC12	1.2 V
2	STATIC12	1.2 V
3	STATIC18	1.8 V
4	STATIC33	3.3 V

DCDC1 is not part of the power-up sequence. DCDC1 is controlled by its ENABLE pin (EN\_DCDC1). EN\_DCDC1 is driven from a supervisor circuit (SVS) that monitors DVDD3318 (DCDC2). Once the output voltage of DCDC2 increases above the threshold set with R1 and R2, the SVS pulls tEN\_DCDC1 up to V<sub>SVS</sub>, thereby enabling DCDC1; see Figure 1.

If DVDD3318 (DCDC2) is configured for 1.8 V (DEFDCDC2 = low), LDO1 is isolated from the OMAP-L132/L138 with an external transistor, T2. T2 connects the output of LDO1 to the OMAP-L132/L138 delayed by an external circuit consisting of T1, T2, R3, and R4 to meet the correct power-up sequence requirements. If DVDD3318 (DCDC2) is configured for 3.3 V (DEFDCDC2 = high), this external delay circuit is not required. The LDO output can be directly connected to the OMAP-L132/L138.

### 1.3 Power-Down Sequence

The power supplies can be powered off in any order as long as LVCMOS supplies operated at 3.3 V (DVDD3318\_A, DVDD3318\_B, or DVDD3318\_C) never exceed static 1.8-V supplies by more than 2 V. There is no specific required voltage ramp-down rate for any of the supplies (except as required to meet the stated voltage condition). The power-down sequence of the TPS65070 is the reversed power-up sequence.

To meet the power-down requirements described here, an additional resistor divider R1 and R2 is required to disable DCDC1 fast enough to ensure that the voltage difference between DCDC2 and DCDC1 does not exceed 2.0 V. The TPS3805 does have a threshold voltage of 1.226 V at the SENSE input. Using an external resistor divider, with R1 = 100kΩ and R2 = 390kΩ, sets the trip voltage when DCDC1 is disabled to 1.55 V. This configuration should ensure the difference between DCDC1 and DCDC2 never exceeds 2.0 V.

## 2 Sequencing with TPS65070

The TPS65070 power management unit supports the power requirements of the OMAP-L132/L138; the single highly-integrated Power Management device provides the voltage settings and sequencing for the OMAP-L132/L138. [Table 3](#) lists the output rail configuration for the TPS65070.

**Table 3. TPS65070 Output Rail Configuration**

Rail <sup>(1)</sup>	Voltage	Converter	Sequencing Order
RTC_CVDD	1.2 V	External LDO	1
USB0_VDDA33, USB1_VDDA33	3.3 V	DCDC1	5
DVDD3318_A, DVDD3318_B, DVDD3318_C	3.3 V / 1.8 V	DCDC2	4 / 5 (part of automatic sequence)
CVDD	1.2 V	DCDC3	2 (part of automatic sequence)
VDDARNWA, VDDARNW1, PLL0_VDDA, PLL1_VDDA, SATA_VDD, USB_CVDD, USB0_VDDA12	1.2 V	LDO2	3 (part of automatic sequence)
USB0_VDDA18, USB1_VDDA18, DDR_DVDD18, SATA_VDDR, DVDD18	1.8 V	LDO1	4 <sup>(2)</sup>

<sup>(1)</sup> USB1, SATA are not available on OMAP-L132.

<sup>(2)</sup> If DVDD3318 is configured for 3.3 V, LDO1 and LDO2 can ramp up together.

Figure 1 shows a complete application diagram that details how to connect the TPS65070 to power an OMAP-L132/L138 application processor.

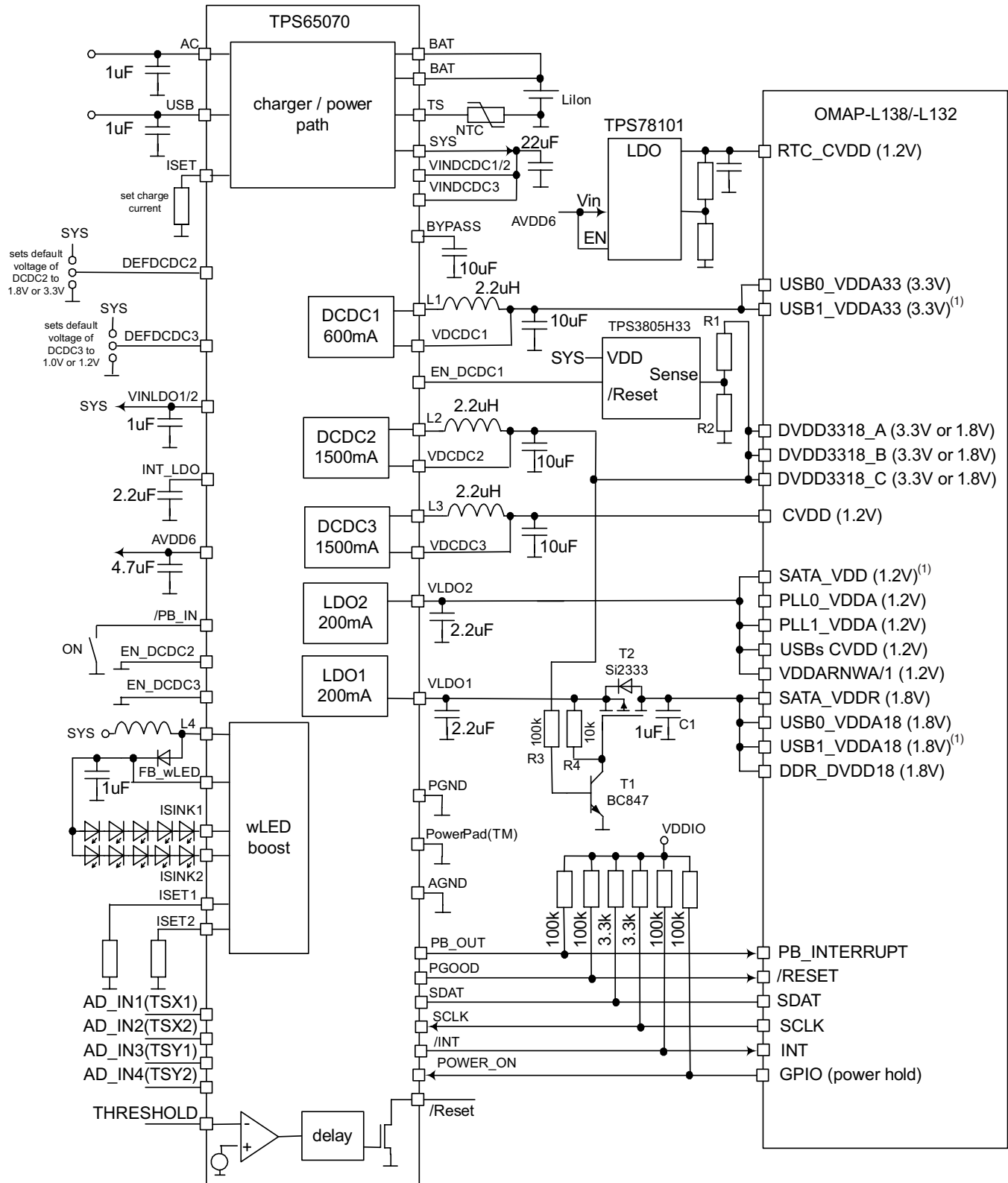

(1) Not available on OMAP-L132.

Figure 1. TPS65070 Power Solution Diagram

Figure 2 and Figure 3 illustrate the power-up sequencing timing for 1.8-V and 3.3-V I/O, respectively.

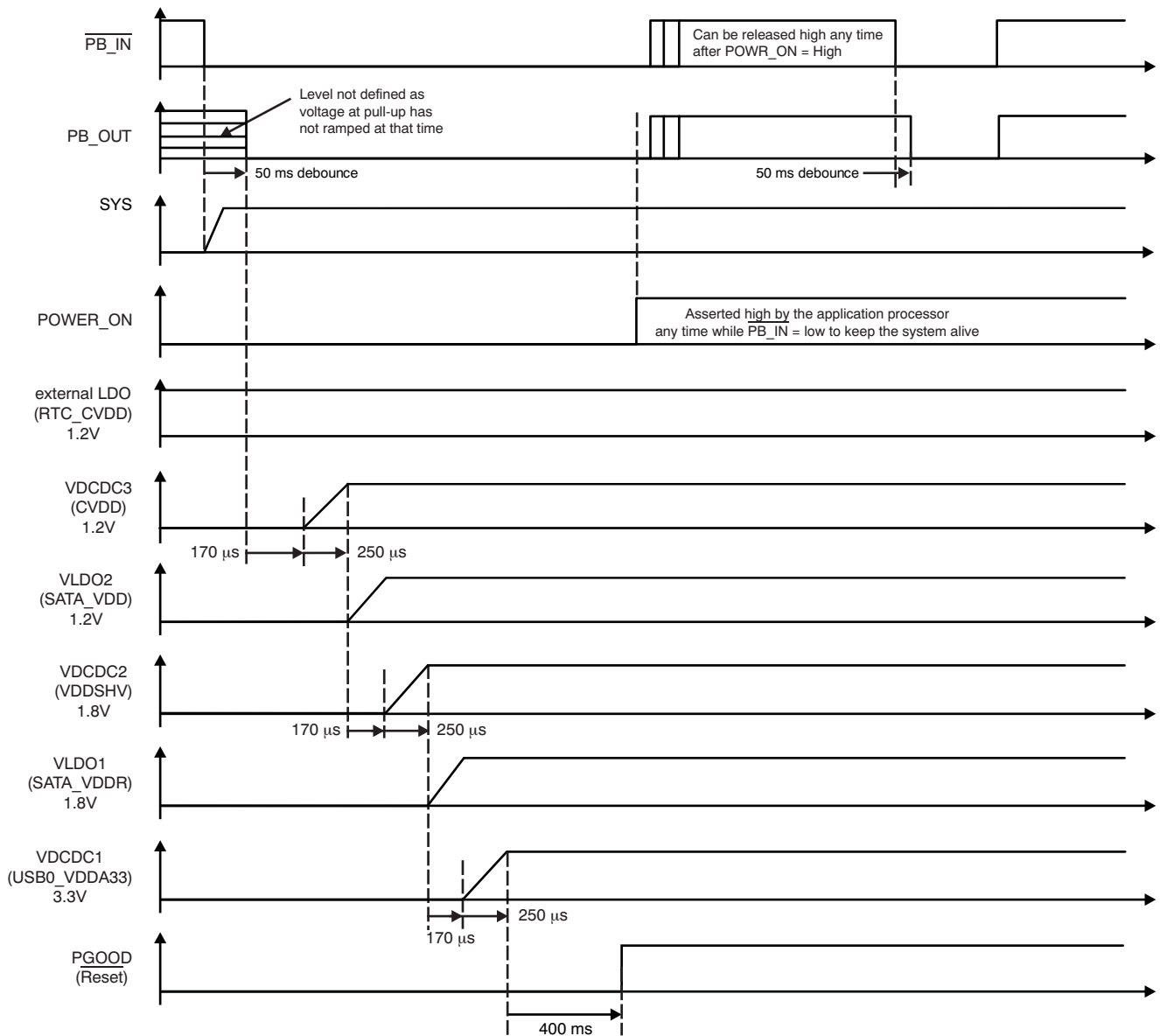

Figure 2. Power-Up Sequencing Timing Diagram (1.8-V I/O)

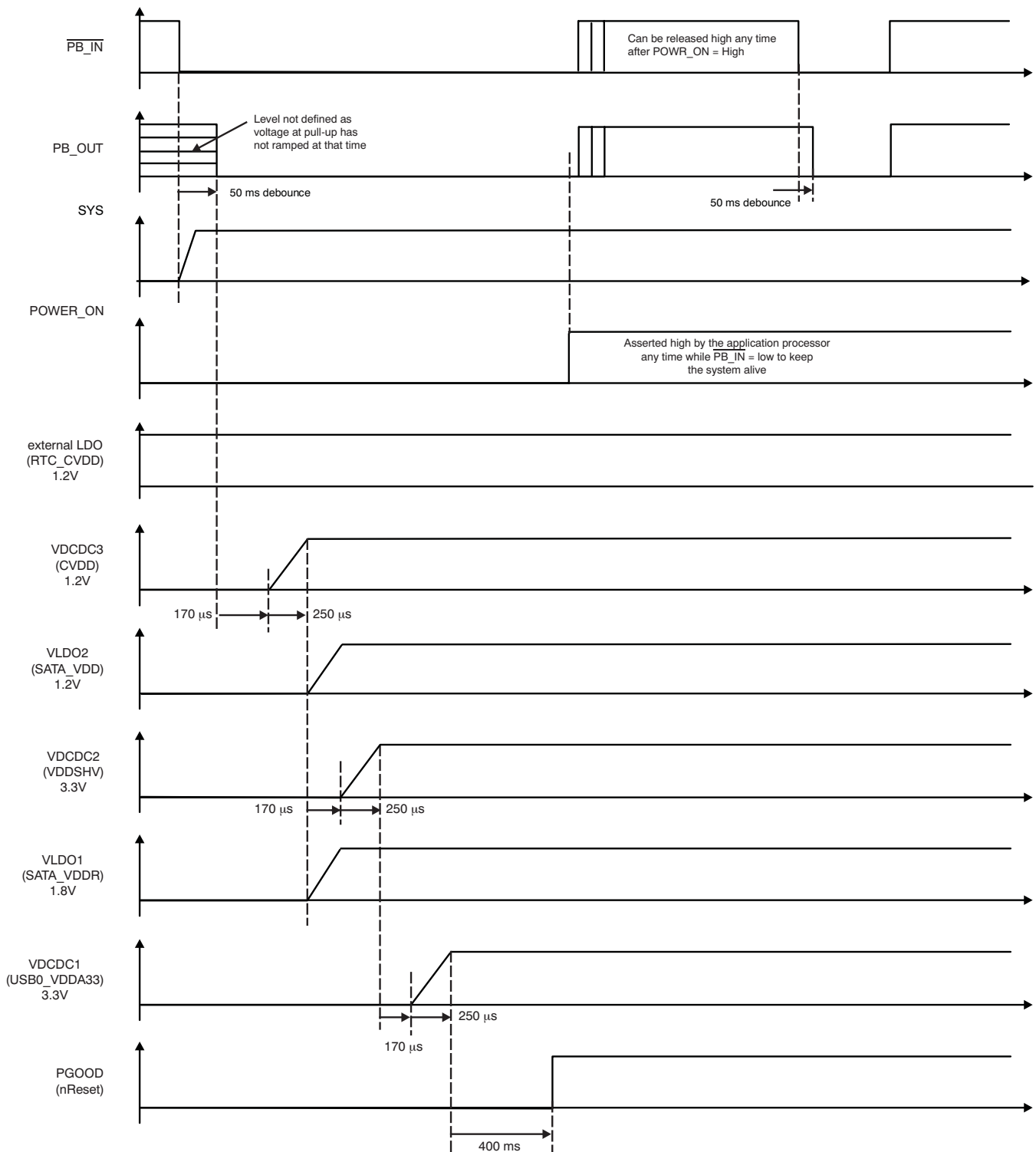

Figure 3. Power-Up Sequencing Timing Diagram (3.3-V I/O)

### 3 Detailed Power Sequence

1. The 1.2-V Real-Time Clock supply RTC\_CVDD is supplied by an external LDO that is powered and enabled by AVDD6. AVDD6 is an output of the TPS65070 that is always on. As soon as input power is applied to the TPS65070, the external LDO is supplied and starts up.
2. The sequencing begins when the pushbutton input PB\_IN is pulled low. When PB\_IN is pulled low, the TPS65070 begins with the automatic sequencing for dc-to-dc converters and low-dropout regulators (LDOs) defined in the registers CTRL\_1 and LDO\_CTRL.
3. DCDC Converter 3 is the first rail to start up in the automatic sequence.
4. After PGOOD goes high (400 ms after DCDC3 is within regulation), DCDC2, LDO1, and LDO2 become enabled. DCDC2 and LDO2 ramp up immediately. LDO1 will be connected by delay to the OMAP-L1x8 with an external transistor from DCDC2 in case the OMAP-L1x8 is working with 1.8-V I/O (with DCDC2 configured for 1.8 V). If OMAP-L1x8 is working with 3.3-V I/O (that is, with DCDC2 configured for 3.3 V), LDO1 can be directly connected to the OMAP-L1x8; there is no need for the external delay circuit T1, T2, R3, and R4.
5. DCDC1 will be enabled after DCDC2 ramps up. The EN\_DCDC1 pin is controlled from an external supply voltage supervisor (SVS) that pulls the enable pin to SYS after DCDC2 ramps up.
6. In order to keep the converters and LDOs of the TPS65070 enabled, the POWER\_ON input of the TPS65070 must be driven high before PB\_IN is released high. POWER\_ON is connected to a GPIO of the OMAP-L132/L138 that drives PWR\_ON high after the processor starts up.

### 4 Test Results

Figure 4 through Figure 7 illustrate the test results.

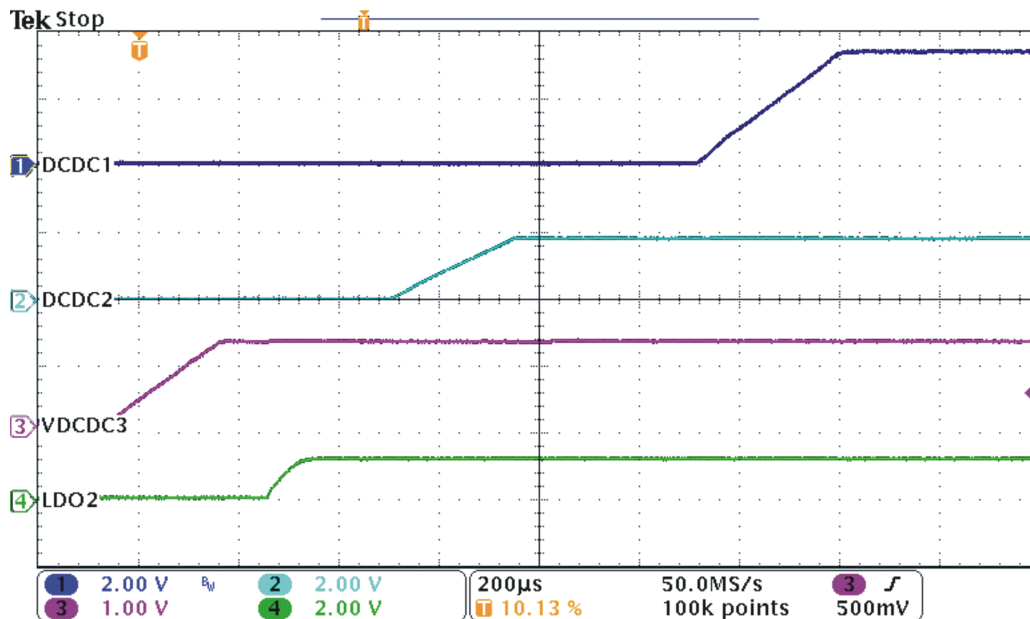

Figure 4. Startup of DC/DC Converters and LDO2 (DCDC2 = 1.8 V)

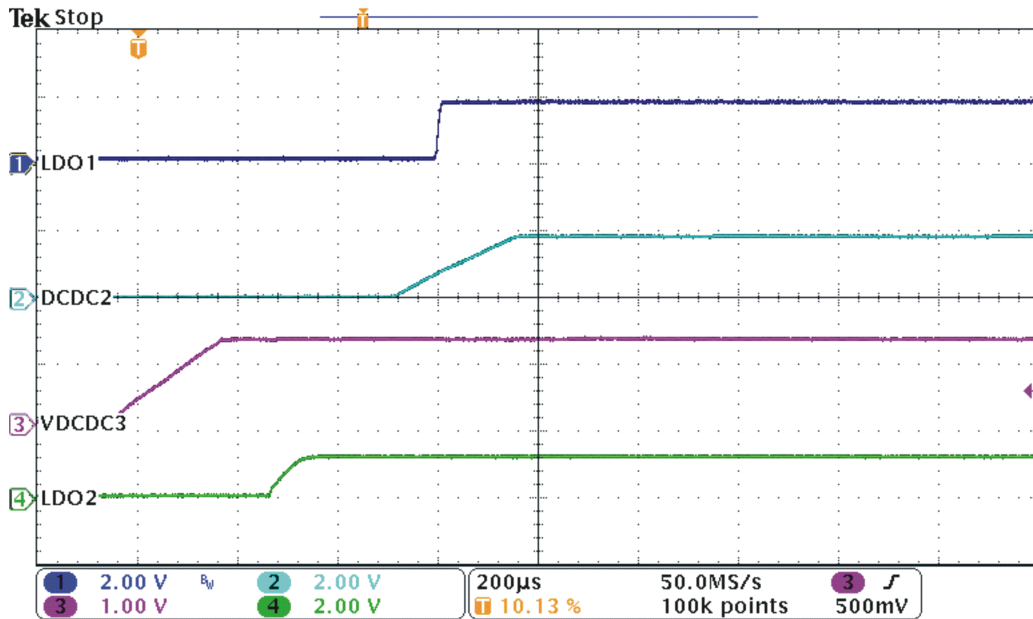

Figure 5. Startup of LDO1 and LDO2 (DCDC2 = 1.8 V)

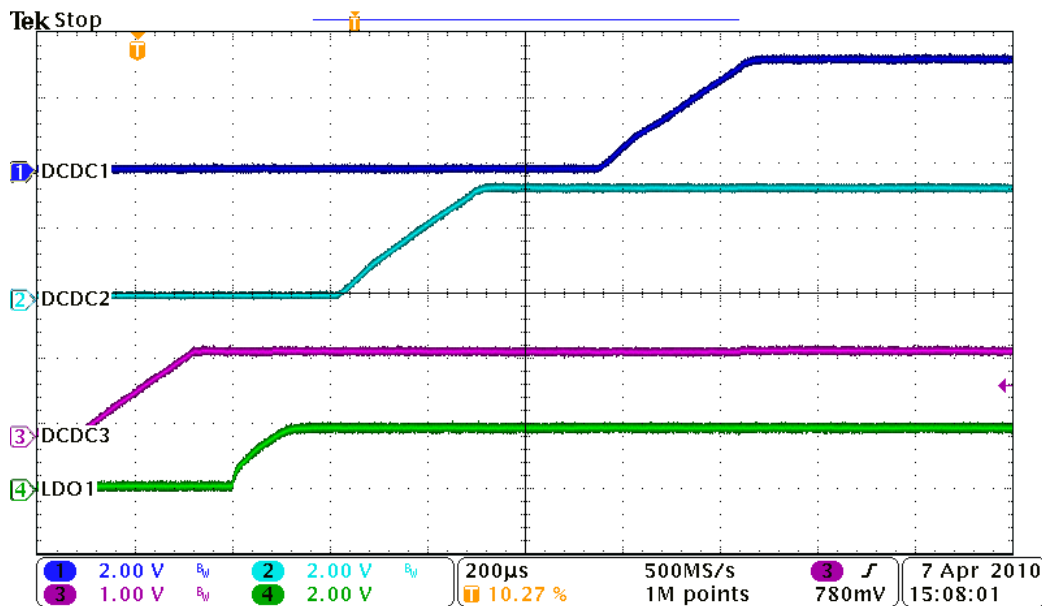

Figure 6. Startup of DC/DC Converters and LDO1 (DCDC2 = 3.3 V)



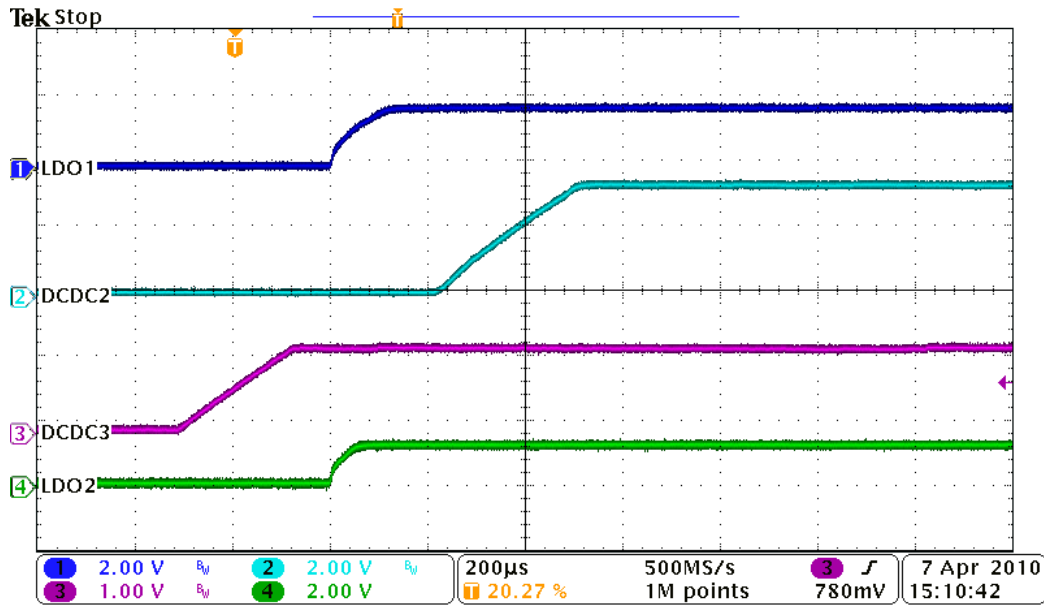

Figure 7. Startup of LDO1 and LDO2 (DCDC2 = 3.3 V)

---

## Revision History

Changes from A Revision (April, 2010) to B Revision	Page
• Changed document title to reflect relevant devices .....	1
• Updated references to <i>OMAP-L138</i> to include <i>OMAP-L132</i> devices .....	1
• Changed <a href="#">Figure 1</a> to show OMAP-L132 configuration; added footnote .....	4

---

NOTE: Page numbers for previous revisions may differ from page numbers in the current version.

## IMPORTANT NOTICE

Texas Instruments Incorporated and its subsidiaries (TI) reserve the right to make corrections, modifications, enhancements, improvements, and other changes to its products and services at any time and to discontinue any product or service without notice. Customers should obtain the latest relevant information before placing orders and should verify that such information is current and complete. All products are sold subject to TI's terms and conditions of sale supplied at the time of order acknowledgment.

TI warrants performance of its hardware products to the specifications applicable at the time of sale in accordance with TI's standard warranty. Testing and other quality control techniques are used to the extent TI deems necessary to support this warranty. Except where mandated by government requirements, testing of all parameters of each product is not necessarily performed.

TI assumes no liability for applications assistance or customer product design. Customers are responsible for their products and applications using TI components. To minimize the risks associated with customer products and applications, customers should provide adequate design and operating safeguards.

TI does not warrant or represent that any license, either express or implied, is granted under any TI patent right, copyright, mask work right, or other TI intellectual property right relating to any combination, machine, or process in which TI products or services are used. Information published by TI regarding third-party products or services does not constitute a license from TI to use such products or services or a warranty or endorsement thereof. Use of such information may require a license from a third party under the patents or other intellectual property of the third party, or a license from TI under the patents or other intellectual property of TI.

Reproduction of TI information in TI data books or data sheets is permissible only if reproduction is without alteration and is accompanied by all associated warranties, conditions, limitations, and notices. Reproduction of this information with alteration is an unfair and deceptive business practice. TI is not responsible or liable for such altered documentation. Information of third parties may be subject to additional restrictions.

Resale of TI products or services with statements different from or beyond the parameters stated by TI for that product or service voids all express and any implied warranties for the associated TI product or service and is an unfair and deceptive business practice. TI is not responsible or liable for any such statements.

TI products are not authorized for use in safety-critical applications (such as life support) where a failure of the TI product would reasonably be expected to cause severe personal injury or death, unless officers of the parties have executed an agreement specifically governing such use. Buyers represent that they have all necessary expertise in the safety and regulatory ramifications of their applications, and acknowledge and agree that they are solely responsible for all legal, regulatory and safety-related requirements concerning their products and any use of TI products in such safety-critical applications, notwithstanding any applications-related information or support that may be provided by TI. Further, Buyers must fully indemnify TI and its representatives against any damages arising out of the use of TI products in such safety-critical applications.

TI products are neither designed nor intended for use in military/aerospace applications or environments unless the TI products are specifically designated by TI as military-grade or "enhanced plastic." Only products designated by TI as military-grade meet military specifications. Buyers acknowledge and agree that any such use of TI products which TI has not designated as military-grade is solely at the Buyer's risk, and that they are solely responsible for compliance with all legal and regulatory requirements in connection with such use.

TI products are neither designed nor intended for use in automotive applications or environments unless the specific TI products are designated by TI as compliant with ISO/TS 16949 requirements. Buyers acknowledge and agree that, if they use any non-designated products in automotive applications, TI will not be responsible for any failure to meet such requirements.

Following are URLs where you can obtain information on other Texas Instruments products and application solutions:

### Products

Audio	<a href="http://www.ti.com/audio">www.ti.com/audio</a>
Amplifiers	<a href="http://amplifier.ti.com">amplifier.ti.com</a>
Data Converters	<a href="http://dataconverter.ti.com">dataconverter.ti.com</a>
DLP® Products	<a href="http://www.dlp.com">www.dlp.com</a>
DSP	<a href="http://dsp.ti.com">dsp.ti.com</a>
Clocks and Timers	<a href="http://www.ti.com/clocks">www.ti.com/clocks</a>
Interface	<a href="http://interface.ti.com">interface.ti.com</a>
Logic	<a href="http://logic.ti.com">logic.ti.com</a>
Power Mgmt	<a href="http://power.ti.com">power.ti.com</a>
Microcontrollers	<a href="http://microcontroller.ti.com">microcontroller.ti.com</a>
RFID	<a href="http://www.ti-rfid.com">www.ti-rfid.com</a>
OMAP Mobile Processors	<a href="http://www.ti.com/omap">www.ti.com/omap</a>
Wireless Connectivity	<a href="http://www.ti.com/wirelessconnectivity">www.ti.com/wirelessconnectivity</a>

### Applications

Communications and Telecom	<a href="http://www.ti.com/communications">www.ti.com/communications</a>
Computers and Peripherals	<a href="http://www.ti.com/computers">www.ti.com/computers</a>
Consumer Electronics	<a href="http://www.ti.com/consumer-apps">www.ti.com/consumer-apps</a>
Energy and Lighting	<a href="http://www.ti.com/energy">www.ti.com/energy</a>
Industrial	<a href="http://www.ti.com/industrial">www.ti.com/industrial</a>
Medical	<a href="http://www.ti.com/medical">www.ti.com/medical</a>
Security	<a href="http://www.ti.com/security">www.ti.com/security</a>
Space, Avionics and Defense	<a href="http://www.ti.com/space-avionics-defense">www.ti.com/space-avionics-defense</a>
Transportation and Automotive	<a href="http://www.ti.com/automotive">www.ti.com/automotive</a>
Video and Imaging	<a href="http://www.ti.com/video">www.ti.com/video</a>

TI E2E Community Home Page

[e2e.ti.com](http://e2e.ti.com)

Mailing Address: Texas Instruments, Post Office Box 655303, Dallas, Texas 75265  
Copyright © 2011, Texas Instruments Incorporated