

# TLE4275-Q1 Low Temperature Stability

MSA Applications

## ABSTRACT

Instability at low temperature may occur in linear power supply systems using electrolytic output capacitors. This application note provides a review of the symptoms, cause and prevention. References are also provided for deeper theoretical treatment of linear regulator control stability.

## Application Evaluation Circuit

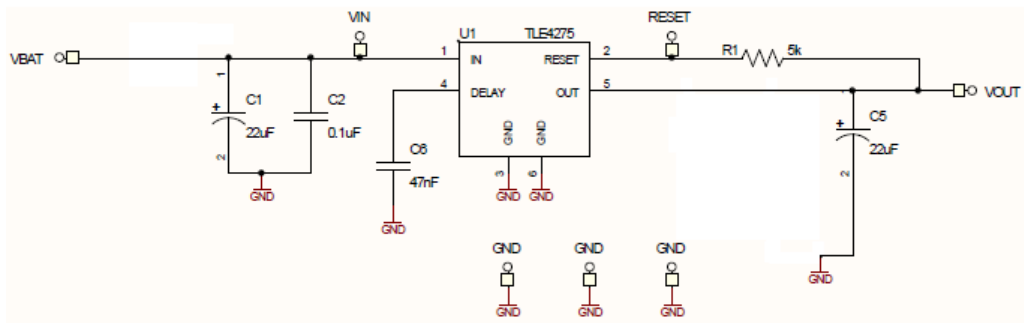

## Low Temperature Instability Symptoms

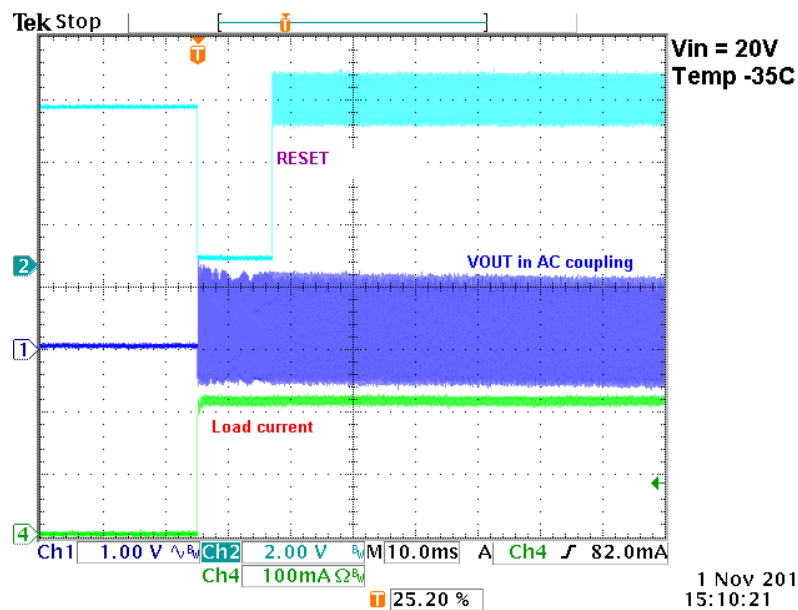

Oscilloscope trace 1 (blue) shows AC coupled output voltage  $V_{OUT}$ , trace 2 (aqua) reset pin voltage, trace 4 (green) load current. Note that voltage is not stable as device is enabled; there are large-amplitude, high-frequency oscillations.

Zoom View:

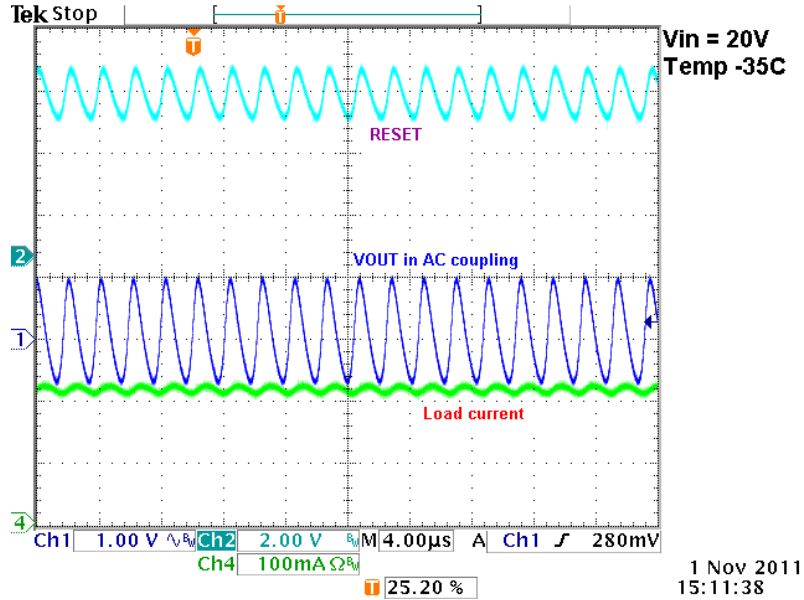

1 Nov 2011  
15:11:38

Clearly the voltage does not meet the requirements for stable, well regulated 5V output.

Oscilloscope plots are not shown, but note that at higher temperatures, the circuit does become stable, showing proper regulation and behavior as per specification.

### Low Temperature Instability Cause

A linear voltage regulator system can be viewed as a classic control loop, with transfer functions defining the forward and feedback paths. The equations are not solely determined by the regulator chip; the output capacitance and load play a major role and must be accounted for.

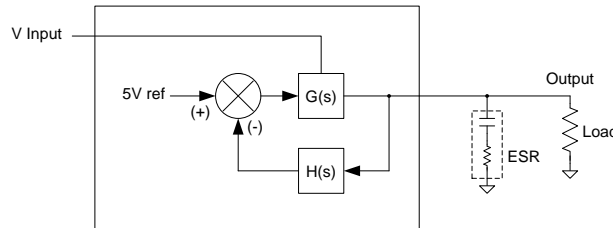

For the most common applications, an electrolytic output capacitor is used, and the low temperature stability issue can be traced to an increase in its equivalent series resistance (ESR) at low temperature. The additional resistance introduces changes in the system transfer function which are beyond the limits of stability.

Stability analysis techniques are well known for regulator devices similar to TLE4275-Q1 and are covered by the following Application Notes:

1. *Stability Analysis of Low-Dropout Linear Regulators with a PMOS Pass Element* (SLYT194)
2. *LDO Regulator Stability Using Ceramic Output Capacitors* (SNVA167)
3. *Linear Regulators: Theory of Operation and Compensation* (SNVA020)
4. *ESR, Stability, and the LDO Regulator* (SLVA115)

Additionally, classic textbooks such as Ogata's *Modern Control Engineering*, Sedra & Smith's *Microelectronic Circuits* and Voperian's *Fast Analytical Techniques for Electrical and Electronic Circuits* can provide an in-depth theoretical background.

## Low Temperature Instability Prevention

TLE4275-Q1 data sheet provides charts showing the load, capacitance and ESR limits for stable operation.



TLE4275-Q1

www.ti.com

SLV547E – AUGUST 2006 – REVISED MARCH 2011

### TYPICAL CHARACTERISTICS (continued)

ESR STABILITY  
vs  
LOAD CURRENT

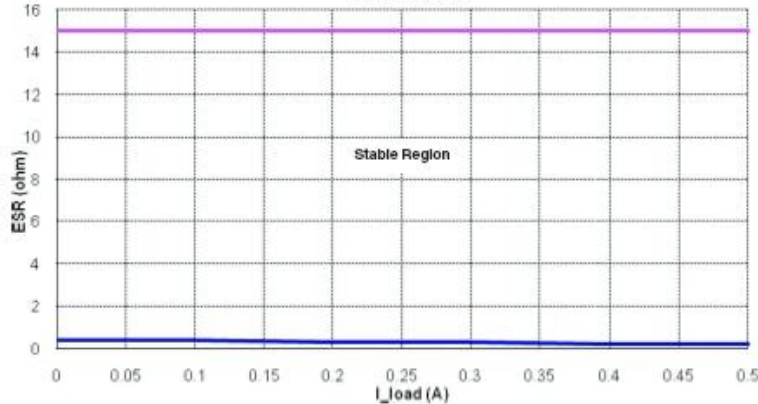

ESR STABILITY  
vs  
LOAD CAPACITANCE

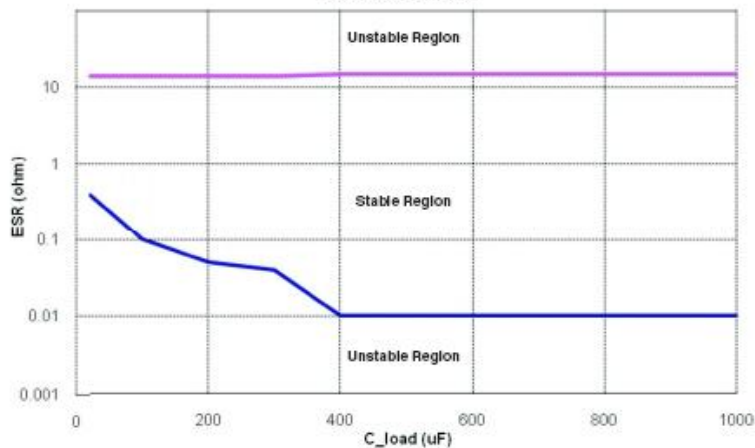

System designs must ensure their capacitor choice meets the published ESR limits for TLE4275 stability. When ceramic capacitors are used, a series resistor may be required to meet resistance minimum value. As an example, a 22  $\mu\text{F}$  ceramic capacitor with a .33- $\Omega$  series resistor will meet stability requirements over full temperature range.

When electrolytic capacitors are used, the most common issue is low temperature ESR rising above maximum limits. Unfortunately, obtaining detailed specifications on electrolytic capacitors at low temperature can be difficult. Systems designers often must rely on empirical testing and experience.

## Suggested Electrolytic Capacitor Selection

After testing a number of different capacitor types and values from several vendors, it is suggested to use at least a 68 $\mu$ F output filter capacitor or greater to ensure stability over the full device operating temperature range.

Below are scope shots of response to a pulsed load with system temperature set to -40°C. The first plot used 68  $\mu$ F, 16V Nichicon UD series electrolytic capacitor. The second used a 68  $\mu$ F, 16V Panasonic EEE-FT series electrolytic capacitor. Note the stable response to the load.

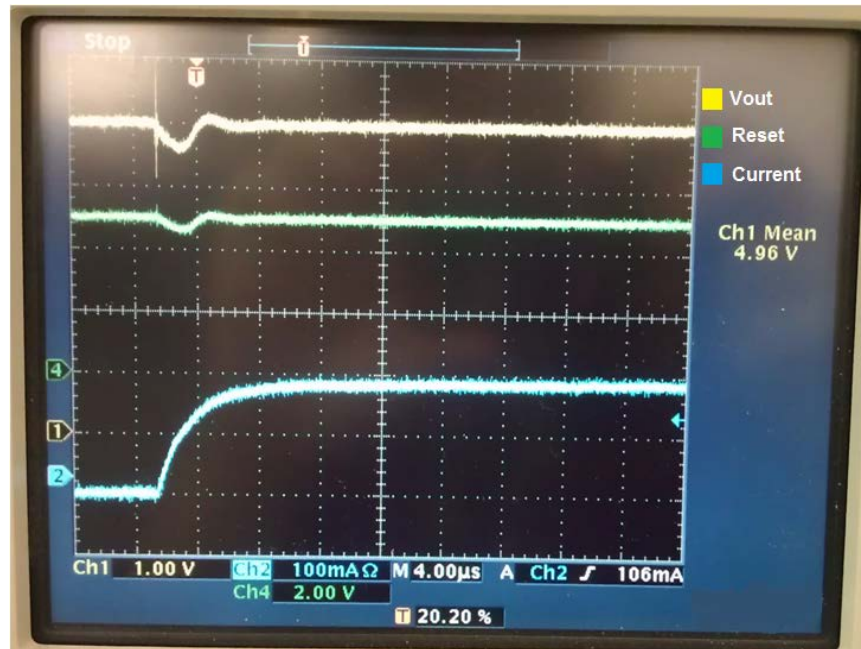

**Figure 1. 68 $\mu$ F/16V Nichicon UD Series Cap at  $V_{IN} = 20V$**

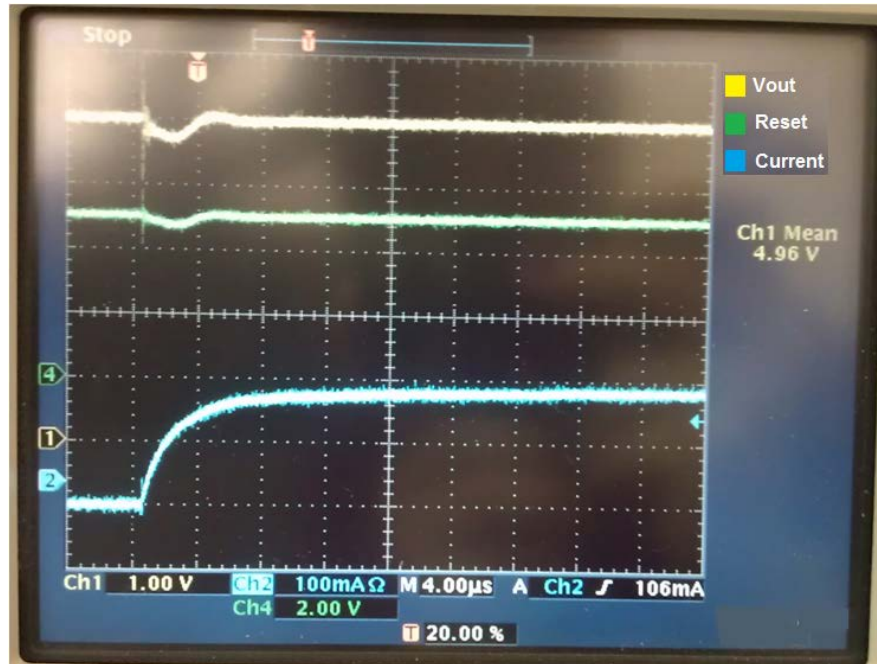

Figure 2. 68 $\mu$ F/16V Panasonic EEE-FT Series Cap at  $V_{IN} = 20V$

## IMPORTANT NOTICE

Texas Instruments Incorporated and its subsidiaries (TI) reserve the right to make corrections, modifications, enhancements, improvements, and other changes to its products and services at any time and to discontinue any product or service without notice. Customers should obtain the latest relevant information before placing orders and should verify that such information is current and complete. All products are sold subject to TI's terms and conditions of sale supplied at the time of order acknowledgment.

TI warrants performance of its hardware products to the specifications applicable at the time of sale in accordance with TI's standard warranty. Testing and other quality control techniques are used to the extent TI deems necessary to support this warranty. Except where mandated by government requirements, testing of all parameters of each product is not necessarily performed.

TI assumes no liability for applications assistance or customer product design. Customers are responsible for their products and applications using TI components. To minimize the risks associated with customer products and applications, customers should provide adequate design and operating safeguards.

TI does not warrant or represent that any license, either express or implied, is granted under any TI patent right, copyright, mask work right, or other TI intellectual property right relating to any combination, machine, or process in which TI products or services are used. Information published by TI regarding third-party products or services does not constitute a license from TI to use such products or services or a warranty or endorsement thereof. Use of such information may require a license from a third party under the patents or other intellectual property of the third party, or a license from TI under the patents or other intellectual property of TI.

Reproduction of TI information in TI data books or data sheets is permissible only if reproduction is without alteration and is accompanied by all associated warranties, conditions, limitations, and notices. Reproduction of this information with alteration is an unfair and deceptive business practice. TI is not responsible or liable for such altered documentation. Information of third parties may be subject to additional restrictions.

Resale of TI products or services with statements different from or beyond the parameters stated by TI for that product or service voids all express and any implied warranties for the associated TI product or service and is an unfair and deceptive business practice. TI is not responsible or liable for any such statements.

TI products are not authorized for use in safety-critical applications (such as life support) where a failure of the TI product would reasonably be expected to cause severe personal injury or death, unless officers of the parties have executed an agreement specifically governing such use. Buyers represent that they have all necessary expertise in the safety and regulatory ramifications of their applications, and acknowledge and agree that they are solely responsible for all legal, regulatory and safety-related requirements concerning their products and any use of TI products in such safety-critical applications, notwithstanding any applications-related information or support that may be provided by TI. Further, Buyers must fully indemnify TI and its representatives against any damages arising out of the use of TI products in such safety-critical applications.

TI products are neither designed nor intended for use in military/aerospace applications or environments unless the TI products are specifically designated by TI as military-grade or "enhanced plastic." Only products designated by TI as military-grade meet military specifications. Buyers acknowledge and agree that any such use of TI products which TI has not designated as military-grade is solely at the Buyer's risk, and that they are solely responsible for compliance with all legal and regulatory requirements in connection with such use.

TI products are neither designed nor intended for use in automotive applications or environments unless the specific TI products are designated by TI as compliant with ISO/TS 16949 requirements. Buyers acknowledge and agree that, if they use any non-designated products in automotive applications, TI will not be responsible for any failure to meet such requirements.

Following are URLs where you can obtain information on other Texas Instruments products and application solutions:

### Products

Audio	<a href="http://www.ti.com/audio">www.ti.com/audio</a>
Amplifiers	<a href="http://amplifier.ti.com">amplifier.ti.com</a>
Data Converters	<a href="http://dataconverter.ti.com">dataconverter.ti.com</a>
DLP® Products	<a href="http://www.dlp.com">www.dlp.com</a>
DSP	<a href="http://dsp.ti.com">dsp.ti.com</a>
Clocks and Timers	<a href="http://www.ti.com/clocks">www.ti.com/clocks</a>
Interface	<a href="http://interface.ti.com">interface.ti.com</a>
Logic	<a href="http://logic.ti.com">logic.ti.com</a>
Power Mgmt	<a href="http://power.ti.com">power.ti.com</a>
Microcontrollers	<a href="http://microcontroller.ti.com">microcontroller.ti.com</a>
RFID	<a href="http://www.ti-rfid.com">www.ti-rfid.com</a>
OMAP Mobile Processors	<a href="http://www.ti.com/omap">www.ti.com/omap</a>
Wireless Connectivity	<a href="http://www.ti.com/wirelessconnectivity">www.ti.com/wirelessconnectivity</a>

### Applications

Automotive and Transportation	<a href="http://www.ti.com/automotive">www.ti.com/automotive</a>
Communications and Telecom	<a href="http://www.ti.com/communications">www.ti.com/communications</a>
Computers and Peripherals	<a href="http://www.ti.com/computers">www.ti.com/computers</a>
Consumer Electronics	<a href="http://www.ti.com/consumer-apps">www.ti.com/consumer-apps</a>
Energy and Lighting	<a href="http://www.ti.com/energy">www.ti.com/energy</a>
Industrial	<a href="http://www.ti.com/industrial">www.ti.com/industrial</a>
Medical	<a href="http://www.ti.com/medical">www.ti.com/medical</a>
Security	<a href="http://www.ti.com/security">www.ti.com/security</a>
Space, Avionics and Defense	<a href="http://www.ti.com/space-avionics-defense">www.ti.com/space-avionics-defense</a>
Video and Imaging	<a href="http://www.ti.com/video">www.ti.com/video</a>

TI E2E Community Home Page

[e2e.ti.com](http://e2e.ti.com)

Mailing Address: Texas Instruments, Post Office Box 655303, Dallas, Texas 75265  
Copyright © 2012, Texas Instruments Incorporated