

Protecting the TPS25810 from High Voltage DFPs

Nick Smith

Power Interface

ABSTRACT

The TPS25810 is a USB Type-C Downstream Facing Port (DFP) controller that monitors the Type-C Configuration Channel (CC) lines to determine when a USB device is attached. If an Upstream Facing Port (UFP) device is attached, the TPS25810 applies power to VBUS. One concern in USB Type-C applications is that a non-compliant DFP device that disregards the USB Type-C specification can be connected to the port controlled by the TPS25810. Such a device may apply a voltage above the absolute maximum rating of the TPS25810 which could damage the part. This application note presents three design solutions which can be used to protect USB Type-C DFP systems against such scenarios.

Contents

1	Introduction and Related Material	2
2	High Voltage Protection with a PFET	3
3	High Voltage Protection with an NFET.....	5
4	High Voltage Protection with an OVP Switch	7
5	Conclusion	9
6	References	9

List of Figures

1	PFET Protection Scheme.....	3
2	Plug in of a Compliant USB Type-C UFP Device with PFET Solution in Place	4
3	Unplug of a Compliant USB Type-C UFP Device with PFET Solution in Place.....	4
4	Hot plug of Non-compliant DFP Device with PFET Solution in Place	4
5	Hot unplug of Non-compliant DFP Device with PFET Solution in Place	4
6	Hot Plug of Non-compliant DFP Device with TPS25810 Powered off and PFET Solution in Place	4
7	Hot Unplug of Non-compliant DFP Device with TPS25810 Powered off and PFET Solution in Place.....	4
8	NFET Protection Scheme.....	5
9	Plug in of Compliant USB Type-C UFP Device with NFET Solution in Place	6
10	Unplug of Compliant USB Type-C UFP Device with NFET Solution in Place	6
11	Hot plug of a Non-compliant DFP Device with NFET Solution in Place	6
12	Hot unplug of a Non-compliant DFP Device with NFET Solution in Place	6
13	Hot plug of Non-compliant DFP Device with TPS25810 Powered off and NFET Solution in Place	6
14	Hot Unplug of Non-compliant DFP Device with TPS25810 Powered off and NFET Solution in Place.....	6
15	OVP Switch Protection Scheme	7
16	Plug in of Compliant USB Type-C UFP Device with OVP Switch Solution in Place.....	8
17	Unplug of Compliant USB Type-C UFP Device with OVP Switch Solution in Place.....	8
18	Hot Plug of a Non-compliant DFP Device with OVP Switch Solution in Place	8
19	Hot Unplug of a Non-compliant DFP Device with OVP Switch Solution in Place	8
20	Hot Plug of Non-compliant DFP Device with TPS25810 Powered off and OVP Switch Solution in Place	8
21	Hot Unplug of Non-compliant DFP Device with TPS25810 Powered off and OVP Switch Solution in Place ...	8

1 Introduction and Related Material

The focus of this application note is to present design solutions for the TPS25810 to protect against the case of a non-compliant USB Type-C DFP adapter which ignores the USB Type-C power negotiation specification and puts a high voltage on the VBUS line by default. USB Type-C is capable of power delivery, so voltage levels from 5 V to 20 V are expected; however, there is a strict power negotiation protocol in order to achieve the delivery of these different voltage levels. Some non-compliant USB Type-C DFP adapters may ignore this negotiation and apply a high voltage on VBUS which is dangerous for a USB Type-C DFP system. The pins of the TPS25810, such as the OUT pin which connects to VBUS, are rated up to 7V, so being exposed to a high voltage would damage the TPS25810. There are simple, efficient solutions that can solve this problem, and the performance of three of these possible solutions is explored in this application note.

The first two solutions have similar architectures and use the \overline{UFP} pin of the TPS25810 to turn on and off an external blocking MOSFET. This FET must be rated at 30 V (VDS/VSD ABS MAX) in order to handle the high voltage of non-compliant devices. The external blocking MOSFET remains off by default and blocks any high voltage on VBUS in the event of a non-compliant DFP device. The MOSFET will only turn on, connecting the OUT pin of the TPS25810 to the VBUS pin of the Type-C connector, if the device is Type-C UFP compliant.

Note that the solutions presented in [Section 2](#) and [Section 3](#) using an external blocking FET are only viable if \overline{UFP} remains high when a DFP is plugged in. The third solution presented is a single chip solution using the TPD1S414, a USB OVP switch, and does not rely on the \overline{UFP} pin of the TPS25810. This is the simplest solution to implement and provides the most robust protection; however, the higher $R_{DS(ON)}$ and BOM cost may be a concern.

Throughout this application note, “compliant” and “non-compliant” are used to describe USB Type-C devices. A compliant UFP device is one that uses the CC line properly as defined in the Type-C and USB PD specification. A non-compliant DFP device is one that applies >5 V without going through the proper power negotiation as defined in the Type-C and USB PD specification.

The TPS2810 datasheet ([SLVSCR1](#)), the TPD1S414 datasheet ([SLLSEH9](#)), and the USB Type-C documentation (<http://www.usb.org/developers/usdtypec/>) are good resources to have a general understanding of before reading this application note

2 High Voltage Protection with a PFET

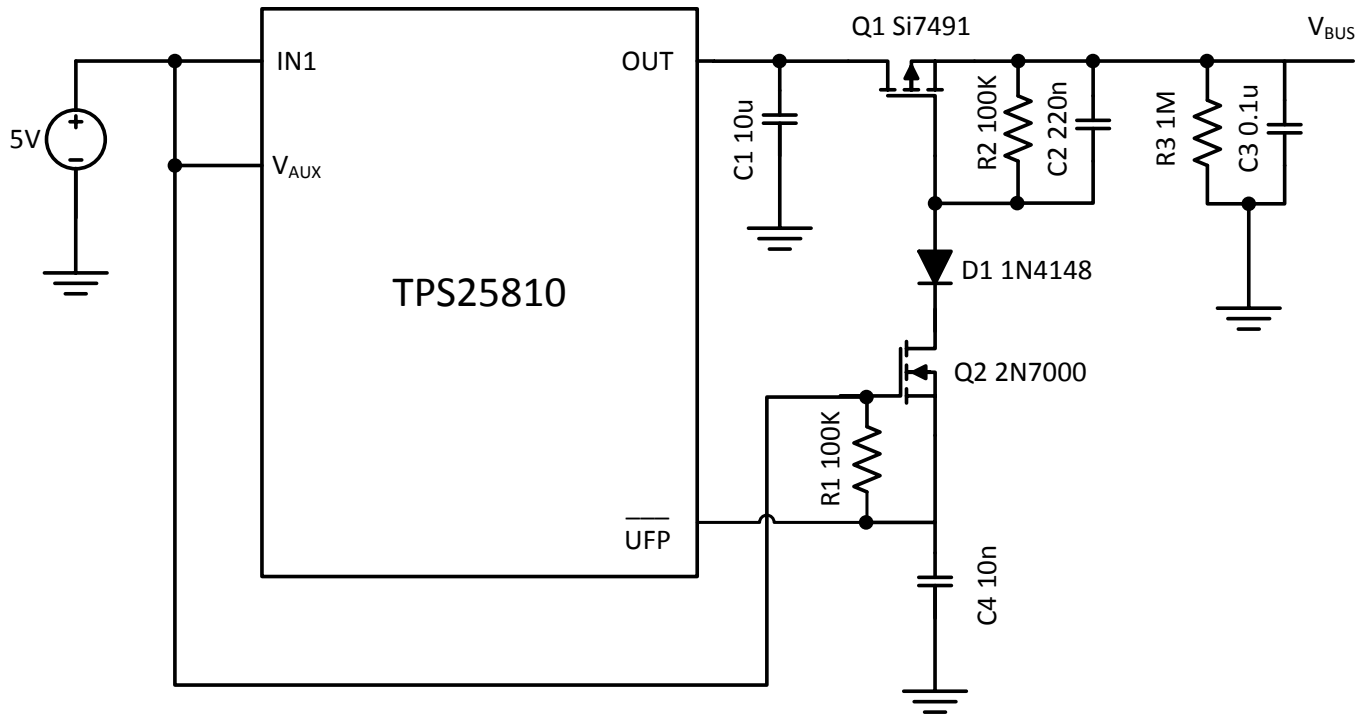

Figure 1. PFET Protection Scheme

2.1 Circuit Operation

The operation of the non-compliant DFP device blocking circuit presented in [Figure 1](#) depends on turning on and off the PFET (Q1) using the \overline{UFP} signal from the TPS25810. When a compliant UFP device is plugged in, the \overline{UFP} pin on the TPS25810 pulls low which turns on the PFET. However, if a non-compliant DFP device is plugged in that offers >5 V without first going through the proper power negotiation, \overline{UFP} stays high-z. Thus, the PFET does not get turned on and the high voltage on the VBUS is not transferred to the OUT pin of the TPS25810.

Q2 serves as a cascade device and protects the \overline{UFP} pin from going above 5 V. This is important because the gate of Q1 is 20 V when 20 V is applied to VBUS, and the absolute maximum of the TPS25810 pins is 7 V.

The 1N4148 diode, D1, is used to limit leakage current through Q2 that could result in unwanted voltage on VBUS or the OUT pin.

R3 is used to discharge the voltage on the VBUS line when a device is disconnected. This must be done in order to comply with the USB Type-C specification that the voltage must discharge to 0.8 V within 650 ms.

C2 is used to prevent the parasitic turn on of the PFET during a hot plug event.

C4 is used to suppress transients on the \overline{UFP} pin of the TPS25810.

2.2 Testing

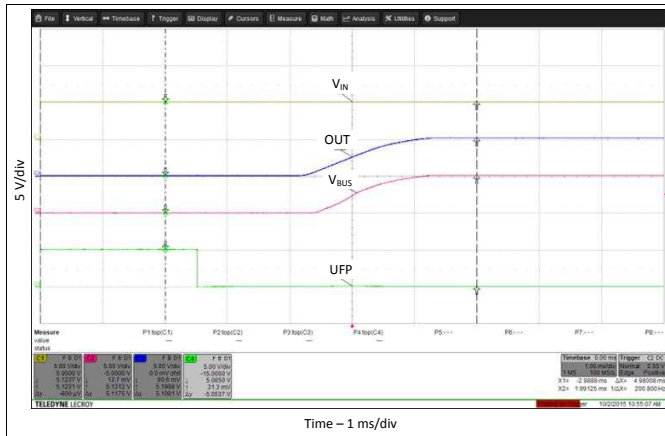

Figure 2. Plug in of a Compliant USB Type-C UFP Device with PFET Solution in Place

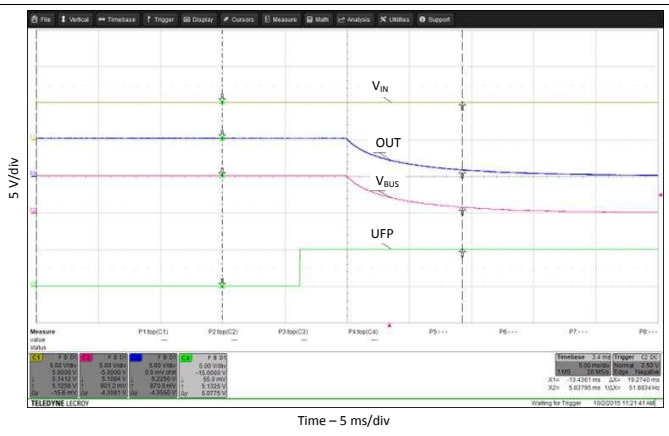

Figure 3. Unplug of a Compliant USB Type-C UFP Device with PFET Solution in Place

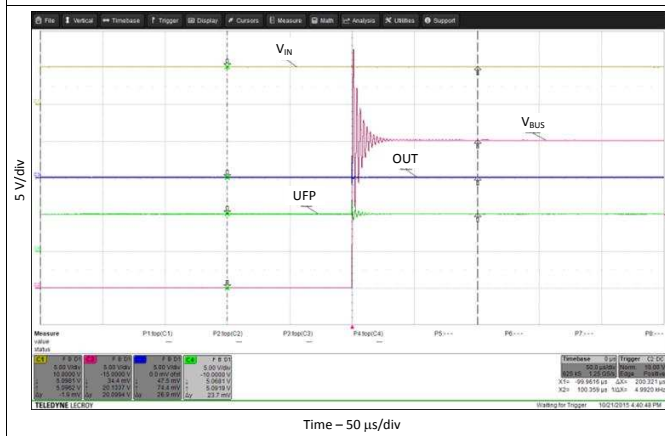

Figure 4. Hot plug of Non-compliant DFP Device with PFET Solution in Place

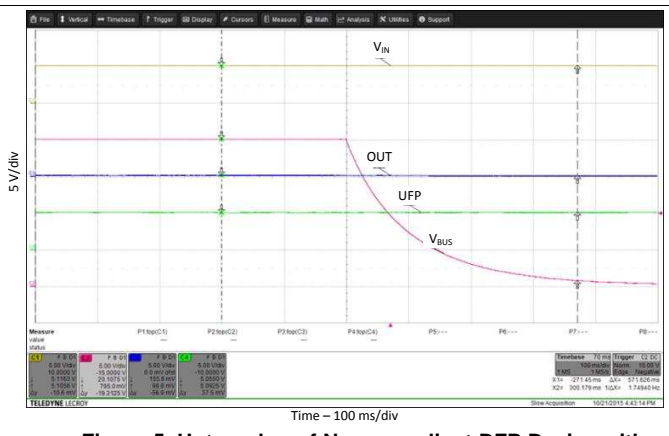

Figure 5. Hot unplug of Non-compliant DFP Device with PFET Solution in Place

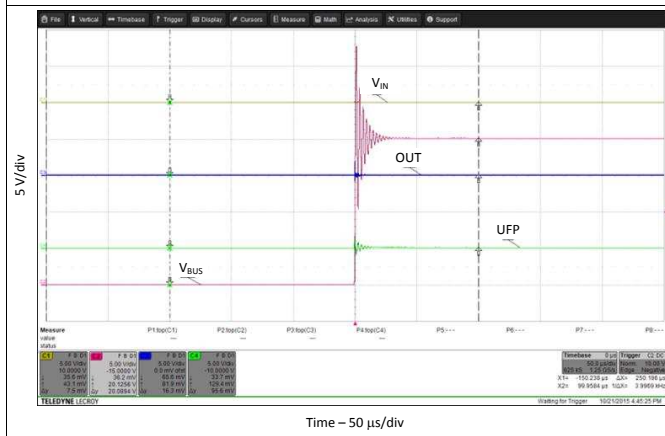

Figure 6. Hot Plug of Non-compliant DFP Device with TPS25810 Powered off and PFET Solution in Place

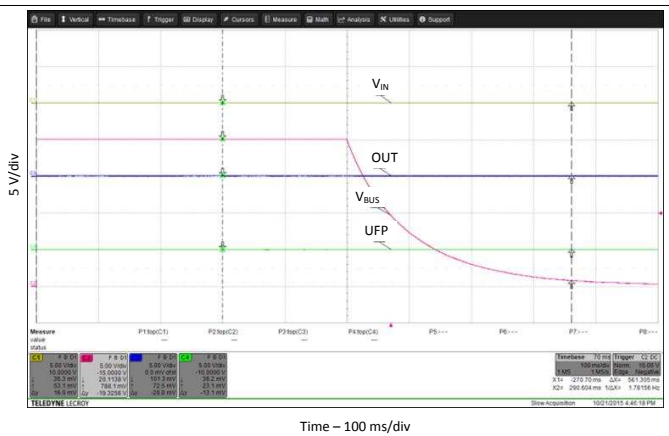

Figure 7. Hot Unplug of Non-compliant DFP Device with TPS25810 Powered off and PFET Solution in Place

3 High Voltage Protection with an NFET

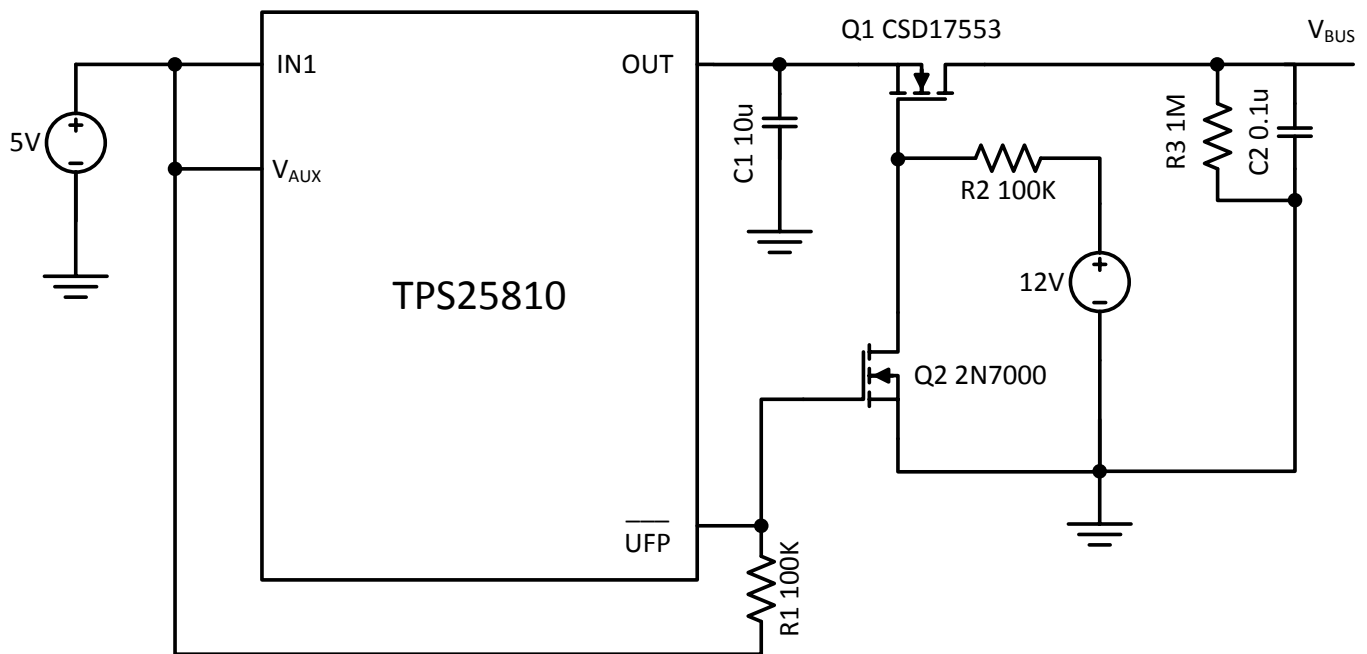

Figure 8. NFET Protection Scheme

3.1 Circuit Operation

The operation of the non-compliant DFP device blocking circuit presented in Figure 8 depends on turning on and off Q1 using the \overline{UFP} signal from the TPS25810. Because an NFET is used, an external 12 V rail is required for this solution in order to provide gate drive voltage above the 5 V output. When a compliant UFP is plugged in, the \overline{UFP} pin on the TPS25810 asserts low and the 12 V rail turns on Q1. However, if a non-compliant DFP device is plugged in that offers >5 V without first going through the proper power negotiation, \overline{UFP} stays high-z. Thus, Q1 does not get turned on, and the high voltage on the VBUS is not transferred to the OUT pin of the TPS25810.

The gate of Q2 is driven by the \overline{UFP} pin from the TPS25810. When the \overline{UFP} pin is pulled high, Q2 is on and pulls the gate of Q1 low. When the \overline{UFP} pin is asserted low Q2 is off and the 12 V rail turns on Q1.

R3 is used to discharge the voltage on the VBUS line when a device is disconnected in order to comply with the USB Type-C specification that the voltage must discharge to 0.8 V within 650 ms.

One very important consideration when implementing this circuit is that VIN must come up before the 12 V rail. If the 12 V rail comes up first, Q1 is turned on, and if a non-compliant DFP is plugged in, the TPS25810 pins are exposed to high voltage which damages the part.

3.2 Testing

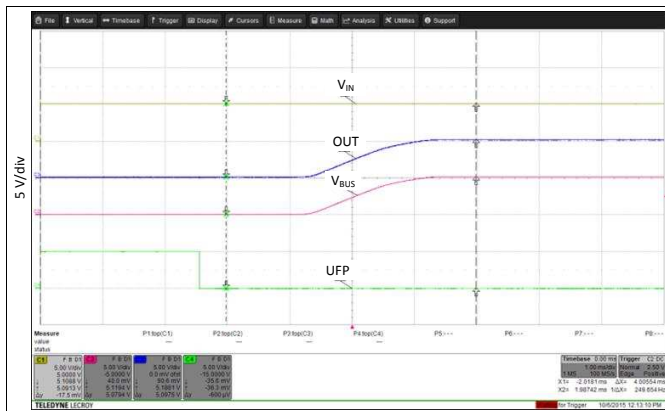

Time – 1 ms/div

Figure 9. Plug in of Compliant USB Type-C UFP Device with NFET Solution in Place

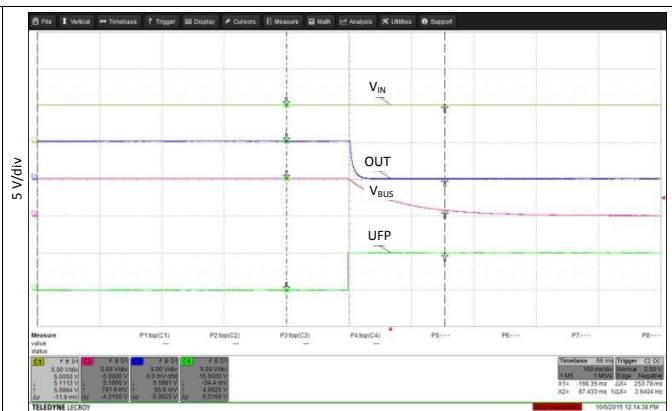

Time – 100 ms/div

Figure 10. Unplug of Compliant USB Type-C UFP Device with NFET Solution in Place

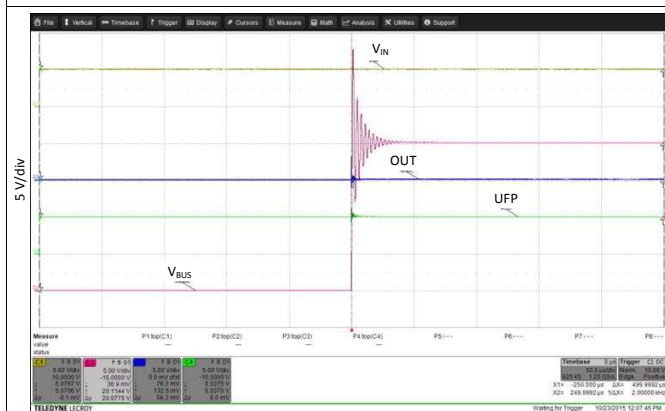

Time – 50 μs/div

Figure 11. Hot plug of a Non-compliant DFP Device with NFET Solution in Place

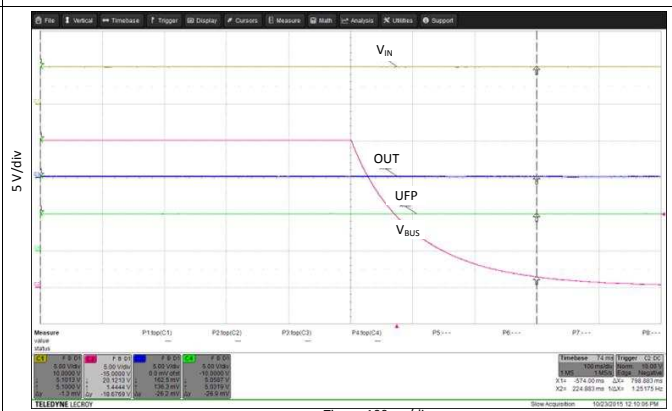

Time – 100 ms/div

Figure 12. Hot unplug of a Non-compliant DFP Device with NFET Solution in Place

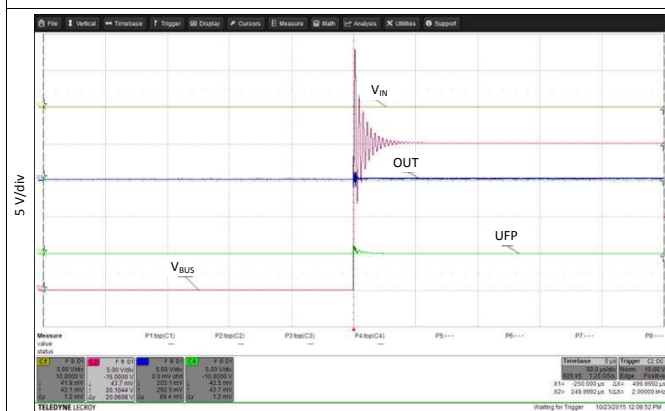

Time – 50 μs/div

Figure 13. Hot plug of Non-compliant DFP Device with TPS25810 Powered off and NFET Solution in Place

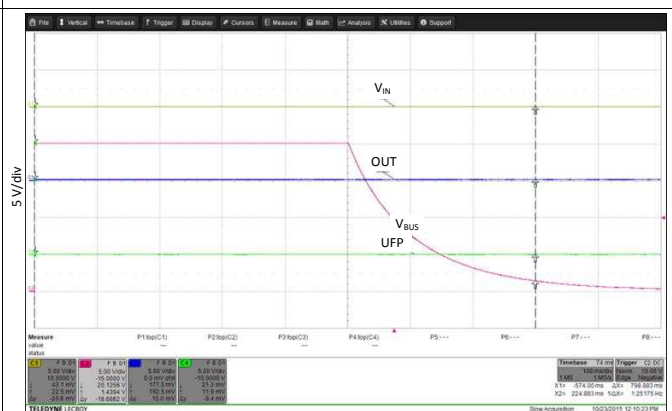

Time – 100 ms/div

Figure 14. Hot Unplug of Non-compliant DFP Device with TPS25810 Powered off and NFET Solution in Place

4 High Voltage Protection with an OVP Switch

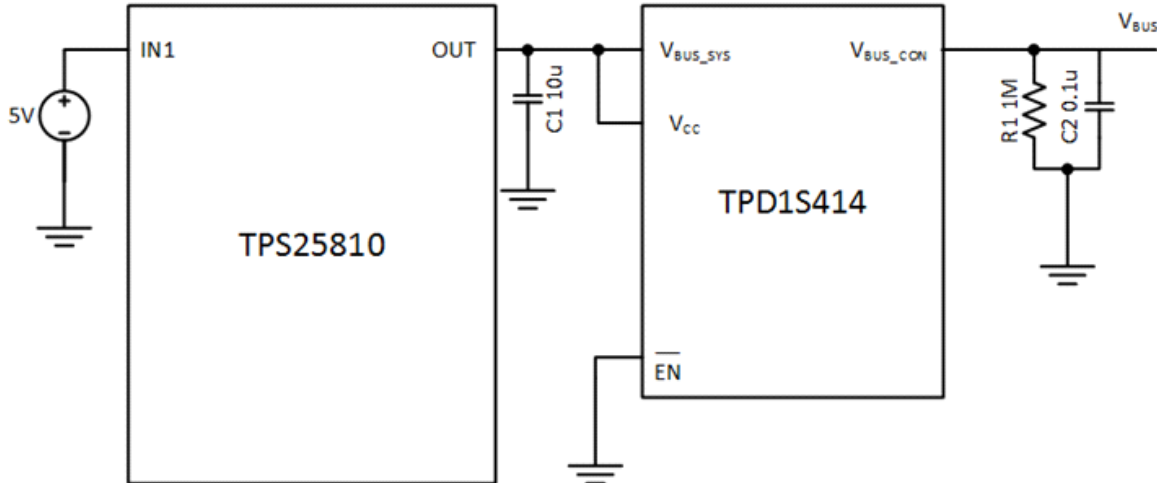

Figure 15. OVP Switch Protection Scheme

4.1 Circuit Operation

This solution uses the TPD1S414 USB Charger OVP Switch. The TPD1S414 is a single chip solution used to protect the VBUS line of a USB connector. The NFET switch internal to the TPD1S414 ensures safe current flow in host mode while protecting the internal system circuits from any overvoltage conditions at the VBUS_CON pin. This device can handle overvoltage protection up to 30 V.

The device protects the pins of the TPS25810 from being exposed to a voltage higher than 6.4 V as specified in the TPD1S414 datasheet ([SLLSEH9](#)). The enable pin of the TPD1S414 is tied low so that whenever the TPD1S414 is powered via VCC it will be enabled by default.

In the system shown in [Figure 15](#), the VCC of the TPD1S414 is tied to the OUT pin of the TPS25810 meaning that whenever a compliant UFP device is detected, the OUT pin of the TPS25810, which is at a voltage below 6.4 V, powers the TPD1S414 and the switch opens allowing the system to function normally. When the TPS25810 does not detect a device, the OUT pin is at 0 V and the TPD1S414 is off which saves system power.

If a non-compliant DFP applies a high voltage to the VBUS_CON pin of the TPD1S414, because the TPS25810 OUT pin is at 0 V and the TPD1S414 is off, the switch remains closed and the high voltage is blocked. With the TPD1S414 on, regardless of the state of the $\overline{\text{UFP}}$ pin on the TPS25810, if a high voltage is applied at VBUS the TPD1S414 detects the high voltage and the switch is turned off protecting the USB Type-C system.

4.2 Testing

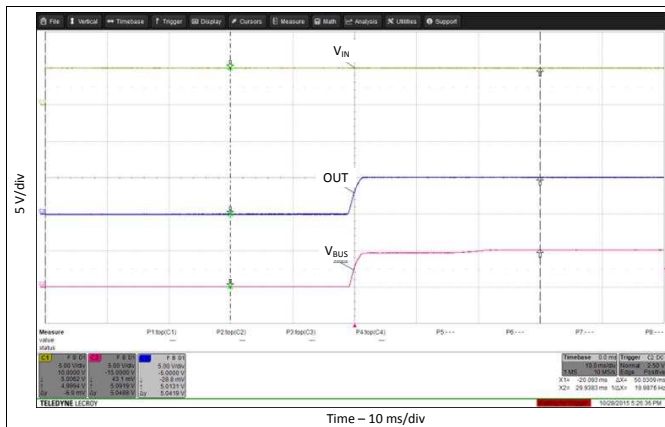

Time – 10 ms/div
Figure 16. Plug in of Compliant USB Type-C UFP Device with OVP Switch Solution in Place

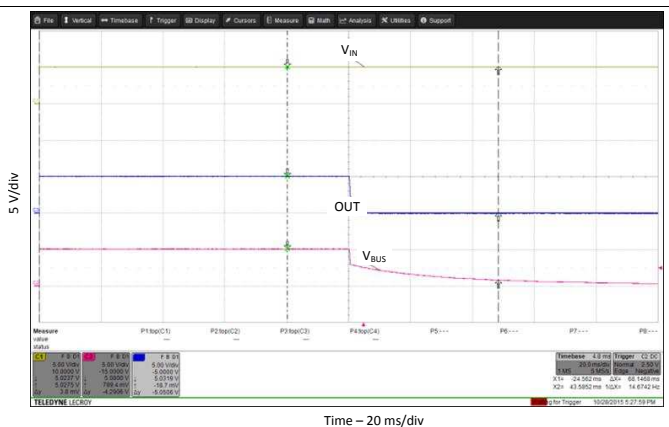

Time – 20 ms/div
Figure 17. Unplug of Compliant USB Type-C UFP Device with OVP Switch Solution in Place

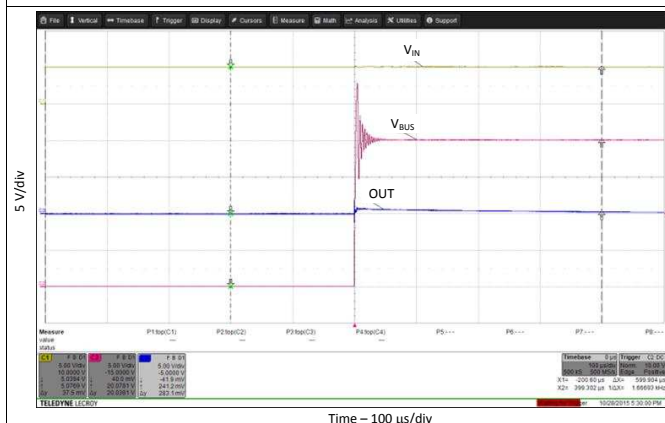

Time – 100 μs/div
Figure 18. Hot Plug of a Non-compliant DFP Device with OVP Switch Solution in Place

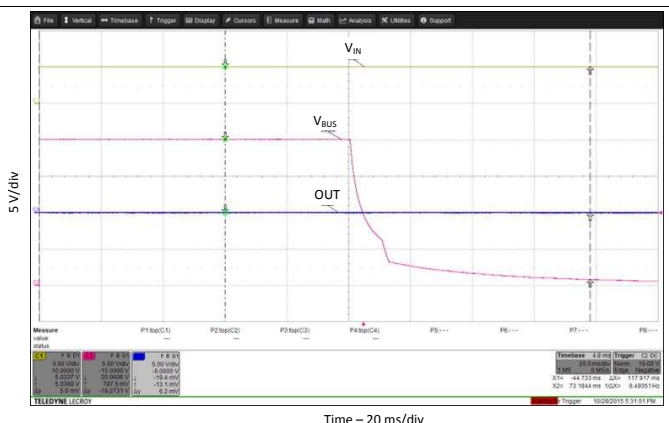

Time – 20 ms/div
Figure 19. Hot Unplug of a Non-compliant DFP Device with OVP Switch Solution in Place

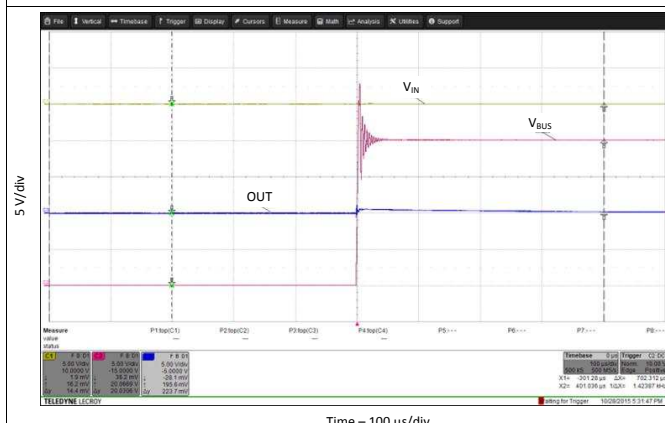

Time – 100 μs/div
Figure 20. Hot Plug of Non-compliant DFP Device with TPS25810 Powered off and OVP Switch Solution in Place

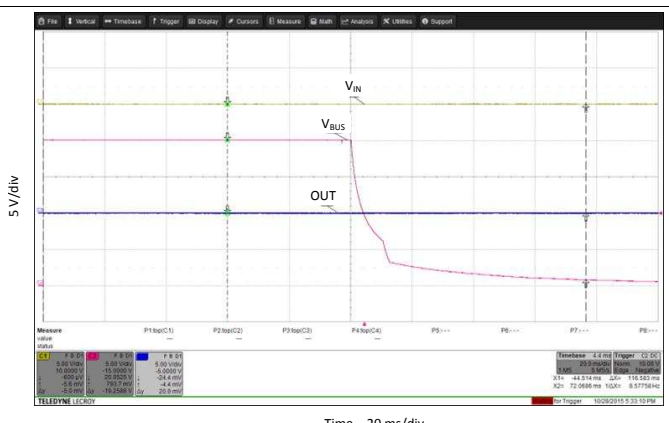

Time – 20 ms/div
Figure 21. Hot Unplug of Non-compliant DFP Device with TPS25810 Powered off and OVP Switch Solution in Place

5 Conclusion

There are many solutions to blocking non-compliant DFP adapters being used with USB Type-C systems that employ the TPS25810. This application note presented three tested solutions for protecting USB Type-C DFP systems from the negative effects of non-compliant DFP adapters.

6 References

- *USB Type-C DFP Controller and Power Switch with Load Detection*, [SLVSCR1](#)
- *USB Charger OVP Switch with ESD for VBUS_CON Pin*, [SLLSEH9](#)
- *USB Type-C Documentation*, <http://www.usb.org/developers/usbttypec/>

IMPORTANT NOTICE

Texas Instruments Incorporated and its subsidiaries (TI) reserve the right to make corrections, enhancements, improvements and other changes to its semiconductor products and services per JESD46, latest issue, and to discontinue any product or service per JESD48, latest issue. Buyers should obtain the latest relevant information before placing orders and should verify that such information is current and complete. All semiconductor products (also referred to herein as "components") are sold subject to TI's terms and conditions of sale supplied at the time of order acknowledgment.

TI warrants performance of its components to the specifications applicable at the time of sale, in accordance with the warranty in TI's terms and conditions of sale of semiconductor products. Testing and other quality control techniques are used to the extent TI deems necessary to support this warranty. Except where mandated by applicable law, testing of all parameters of each component is not necessarily performed.

TI assumes no liability for applications assistance or the design of Buyers' products. Buyers are responsible for their products and applications using TI components. To minimize the risks associated with Buyers' products and applications, Buyers should provide adequate design and operating safeguards.

TI does not warrant or represent that any license, either express or implied, is granted under any patent right, copyright, mask work right, or other intellectual property right relating to any combination, machine, or process in which TI components or services are used. Information published by TI regarding third-party products or services does not constitute a license to use such products or services or a warranty or endorsement thereof. Use of such information may require a license from a third party under the patents or other intellectual property of the third party, or a license from TI under the patents or other intellectual property of TI.

Reproduction of significant portions of TI information in TI data books or data sheets is permissible only if reproduction is without alteration and is accompanied by all associated warranties, conditions, limitations, and notices. TI is not responsible or liable for such altered documentation. Information of third parties may be subject to additional restrictions.

Resale of TI components or services with statements different from or beyond the parameters stated by TI for that component or service voids all express and any implied warranties for the associated TI component or service and is an unfair and deceptive business practice. TI is not responsible or liable for any such statements.

Buyer acknowledges and agrees that it is solely responsible for compliance with all legal, regulatory and safety-related requirements concerning its products, and any use of TI components in its applications, notwithstanding any applications-related information or support that may be provided by TI. Buyer represents and agrees that it has all the necessary expertise to create and implement safeguards which anticipate dangerous consequences of failures, monitor failures and their consequences, lessen the likelihood of failures that might cause harm and take appropriate remedial actions. Buyer will fully indemnify TI and its representatives against any damages arising out of the use of any TI components in safety-critical applications.

In some cases, TI components may be promoted specifically to facilitate safety-related applications. With such components, TI's goal is to help enable customers to design and create their own end-product solutions that meet applicable functional safety standards and requirements. Nonetheless, such components are subject to these terms.

No TI components are authorized for use in FDA Class III (or similar life-critical medical equipment) unless authorized officers of the parties have executed a special agreement specifically governing such use.

Only those TI components which TI has specifically designated as military grade or "enhanced plastic" are designed and intended for use in military/aerospace applications or environments. Buyer acknowledges and agrees that any military or aerospace use of TI components which have **not** been so designated is solely at the Buyer's risk, and that Buyer is solely responsible for compliance with all legal and regulatory requirements in connection with such use.

TI has specifically designated certain components as meeting ISO/TS16949 requirements, mainly for automotive use. In any case of use of non-designated products, TI will not be responsible for any failure to meet ISO/TS16949.

Products

Audio	www.ti.com/audio
Amplifiers	amplifier.ti.com
Data Converters	dataconverter.ti.com
DLP® Products	www.dlp.com
DSP	dsp.ti.com
Clocks and Timers	www.ti.com/clocks
Interface	interface.ti.com
Logic	logic.ti.com
Power Mgmt	power.ti.com
Microcontrollers	microcontroller.ti.com
RFID	www.ti-rfid.com
OMAP Applications Processors	www.ti.com/omap
Wireless Connectivity	www.ti.com/wirelessconnectivity

Applications

Automotive and Transportation	www.ti.com/automotive
Communications and Telecom	www.ti.com/communications
Computers and Peripherals	www.ti.com/computers
Consumer Electronics	www.ti.com/consumer-apps
Energy and Lighting	www.ti.com/energy
Industrial	www.ti.com/industrial
Medical	www.ti.com/medical
Security	www.ti.com/security
Space, Avionics and Defense	www.ti.com/space-avionics-defense
Video and Imaging	www.ti.com/video

TI E2E Community

e2e.ti.com