

Tricolor Control of TPS92314 Based LED Driver With Toggling of Main Light Switch

Harmeet Singh, Sanjay Dixit

ABSTRACT

LEDs are becoming the de facto light source in today’s world of ever expanding applications. They offer various advantages such as longer lifetime (average lifespan of greater than 100,000 hours), increased energy efficiency and better color properties than any other light source available today. But the LEDs cannot produce light on their own. The component called the LED driver comprises of power electronics circuit that converts the available 220 V /110 V AC source into DC power source for driving LEDs. The driver isolates the high line voltage source along with its fluctuations from the LEDs thereby regulating power supplied to them.

LED drivers are more adjustable and hence more adaptable. Apart from normal applications like bulbs, tube lights, down lighters, and street lights, LED drivers are showing a variety of new upcoming trends. The newer LED driver is available with value added features such as dimming, tunable or programmable, mixing or sequencing of colors, and remote control capabilities.

The application report describes an innovative circuit which can be added to any existing Flyback, Buck or Buck-Boost high PF single color LED Bulb or down lighter design based on TPS92314 to convert into Tricolor based design. The color of the LEDs is controlled by repeatedly switching the AC mains switch on and off. This application report will not cover the design details of the Flyback, buck or buck-boost for TPS92314. Refer to the TPS92314 based [Excel design calculator](#) for designing the Flyback or buck-boost LED driver. The TPS92314A evaluation module was used (TPS92314A19230VEVM) for integrating and testing the additional circuit. This application report discusses the step by step design for the innovative circuit.

Contents

1	TPS92314A19230EVM Electrical Performance Specifications	2
2	Step by Step Design Procedure	2
3	Bill of Materials	5
Appendix A	Experimental Results	6

List of Figures

1	TPS92314A19EVM Schematic	4
2	Schematic of the Additional Part.....	5
3	Q0, Q1, Q2 and CLK States of U1 During First Time Switch ON of AC Switch.....	6
4	Q0, Q1, Q2 and CLK States of U1 During First Time Switch OFF of AC Switch	7
5	Q0, Q1, Q2 and CLK States of U1 During Second Time Switch ON of AC Switch.....	8
6	Q0, Q1, Q2 and CLK States of U1 during Second Time Switch OFF of AC Switch	9
7	Q0, Q1, Q2 and CLK States of U1 during Third Time Switch ON of AC Switch.....	10
8	Q0, Q1, Q2 and CLK States of U1 during Third Time Switch OFF of AC Switch	11
9	Gate Drive of MOS1, MOS2 and CLK State of U1 during First Time Switch ON of AC Switch	12
10	Gate Drive of MOS1, MOS2 and CLK State of U1 during Second Time Switch ON of AC Switch	13
11	Gate Drive of MOS1, MOS2 and CLK State of U1 During Third Time Switch ON of AC Switch.....	14
12	+5 V and LED Output Voltage Turn On Waveform	15

List of Tables

1	TPS92314A19230EVM Electrical Performance Specifications	2
2	Bill of Materials	5

1 TPS92314A19230EVM Electrical Performance Specifications
Table 1. TPS92314A19230EVM Electrical Performance Specifications

PARAMETER	TEST CONDITIONS	MIN	TYP	MAX	UNIT
INPUT CHARACTERISTICS					
Voltage range		190	230	265	V
Maximum input current			38		mA
OUTPUT CHARACTERISTICS					
Output voltage, V_{OUT}		18	20	22	V
Output load current, I_{OUT}		330	350	370	mA
Output current ripple	$V_{IN} = 230 V_{AC}$		280		mApp
Output over voltage	Primary side bias		36		V
SYSTEMS CHARACTERISTICS					
Switching frequency			75		kHz
Full load efficiency	$V_{IN} = 230 V_{AC}$		85%		
Power factor			> 0.9		

2 Step by Step Design Procedure

Figure 1 shows the schematic of the TPS92314A19230EVM. Figure 2 is the schematic of the additional circuit. We will refer to Figures 1 and 2 when choosing the various components for the design. LED minimum voltage is 18 V and the LED maximum voltage is 22 V.

The LED testing configuration is 6 Cool LEDs in series and 6 Warm LEDs in series.

Additional circuit connections for the EVM are as follows:

- Wire connection from CN2 pin 1 on EVM is attached to LED+ point on additional circuit PCB.
- Wire connection from CN2 pin 2 on EVM is attached to LED- or Gnd point on additional circuit PCB.

2.1 Power Supply for Additional Circuit

Power supply +5 V for the additional circuit is made from the LED+ output derived from the TPS92314A EVM by using R3, Z1, D3 and C1. R3 is a biasing resistor for shunt Zener Z1. C1 acts as a storage capacitor for +5 V. D3 blocks the capacitor C1 from getting discharged through the EVM output circuit.

The voltage drop across D3 is 0.6 V. To generate +5 V, a zener with reverse breakdown of 5.6 V (5 V + 0.6 V), BZX79C5V6 has been chosen. R3 must be small enough that the current through Z1 remains in reverse breakdown. The value of this current is given in the data sheet for Z1. The BZX79C5V6 device, a 5.6 V 0.5 W Zener diode, has a recommended reverse current of 5 mA. Additionally, allowance must be made for any current through the external load, or the device current consumption. The biasing resistor R3 is thus given by the following equation:

$$R3 = \frac{LED_{MIN} - 5.6}{I_Z + I_{IC}} \quad (1)$$

Where

- I_Z is the recommended reverse current of Z1
- I_{IC} is the current consumption of SN74AHC1G14 and CD4022B

Substituting LED_{MIN} as 18 V, I_Z as 5 mA, and I_{IC} as 0.16 mA, R3 is 2.4 K so the standard value of 2.2 K is used.

The commonly available 1N4148 is used for D3 but any small signal diode with a voltage rating greater than 20 V can be used. C1 is empirically chosen as 47 μ F. A discharge time of 5 V should be at least 6-7 seconds when the AC main switch turns off. In this regard a small preload of R6, 200 K has been chosen.

2.2 Clock Circuit

The Clock circuit is made with the Schmitt inverter gate U2 along with components R4, R5, C3 and C4. The low cost Schmitt inverter gate 74AHC1G14 in the SOT-23 package provides a clock or sharp transition to the next stage counter once the main AC switch is turned off. In a steady state the output of gate pin 4 is low and once the AC main switch is turned off, the output LED voltage LED+ falls. Once the LED voltage reaches the negative going input threshold (VT-) of U2, the output goes from low to high thus acting as a clock for the next stage counter U1. C4, 0.1 μ F 16 V acts as a decoupling capacitor for U2. The resistor values are calculated using [Equation 2](#).

$$R4 = R5 \times \left(\frac{LED_{MIN}}{3.5} - 1 \right) \quad (2)$$

Where

- 3.5 is the VT+ positive threshold voltage for 74AHC1G14 at 5 V
- LED_{MIN} is the minimum LED voltage

Substituting LED_{MIN} as 18 V and R5 as 12 K, R4 equals 49.7 K. A standard value of 47 K is chosen. Ceramic Capacitor C3 ,1 nF 16 V is kept across R5 for noise immunity.

2.3 Counter along with Mosfet Control Circuit

As we need to light either cool LEDs or warm LEDs or both with 50% intensity we need a counter with at least four parts, one output each for reaching the required states and a fourth state for resetting the counter. Generally a four output counter is not available so the U1 CD4022B Octal Counter with 8 decoded states is used for this application.

C2, 0.1 μ F 16 V acts as a decoupling capacitor for U1.

The first output Q0 drives MOS1, meant for Cool LEDs through R1. As Q0 goes high the MOSFET MOS1 turns on and ground the LEDs. TPS92314AEVM set for 350 mA current flows through the Cool LEDs. Once the main AC switch is turned off, U2 generates a low to high transition which acts as a clock input for U1. Pin 14 thus increments the high state from Q0 to Q1. Once the AC switch is turned on, the high state of Q1 drives MOS2 which is meant for the Warm LEDs through R2.

When the AC switch is again turned off U2 generates a low to high transition for U1 clock input pin 14 thus incrementing the high state from Q1 to Q2. Once the AC switch is turned on again the high state of Q2 is maintained and drives MOS 1 and MOS 2 through diodes D1 and D2 respectively. The EVM is the constant current driver of 350 mA. Thus the current is divided equally through cool and warm LEDs. As Q0 and Q1 are in low state so R1 and R2 maintains Q3 in a high state.

When the AC switch is again turned off, U2 generates a clock signal transition of low to high for octal counter U1 thus incrementing the high state from Q2 to Q3. As Q3 output is shorted to the RST pin of U1, the counter is reset and enters the initial state. The whole process repeats if the AC switch is turned on and off.

The values of R1 and R2 are obtained by using [Equation 3](#).

$$R1 = R2 = (V_{oH} - V_d - V_{oL}) \times \frac{1000}{I_{o1}} \quad (3)$$

Where

- V_{oH} is the output high level maximum
- V_d is the diode drop
- V_{oL} is the output low level minimum
- I_{o1} is the minimum sink current ie 0.42 mA

Substituting V_{oH} as 5 V, V_d as 0.7 V, and V_{oL} as 0 V, R1 = R2 = 10.23 K so a standard value of 12 K is used.

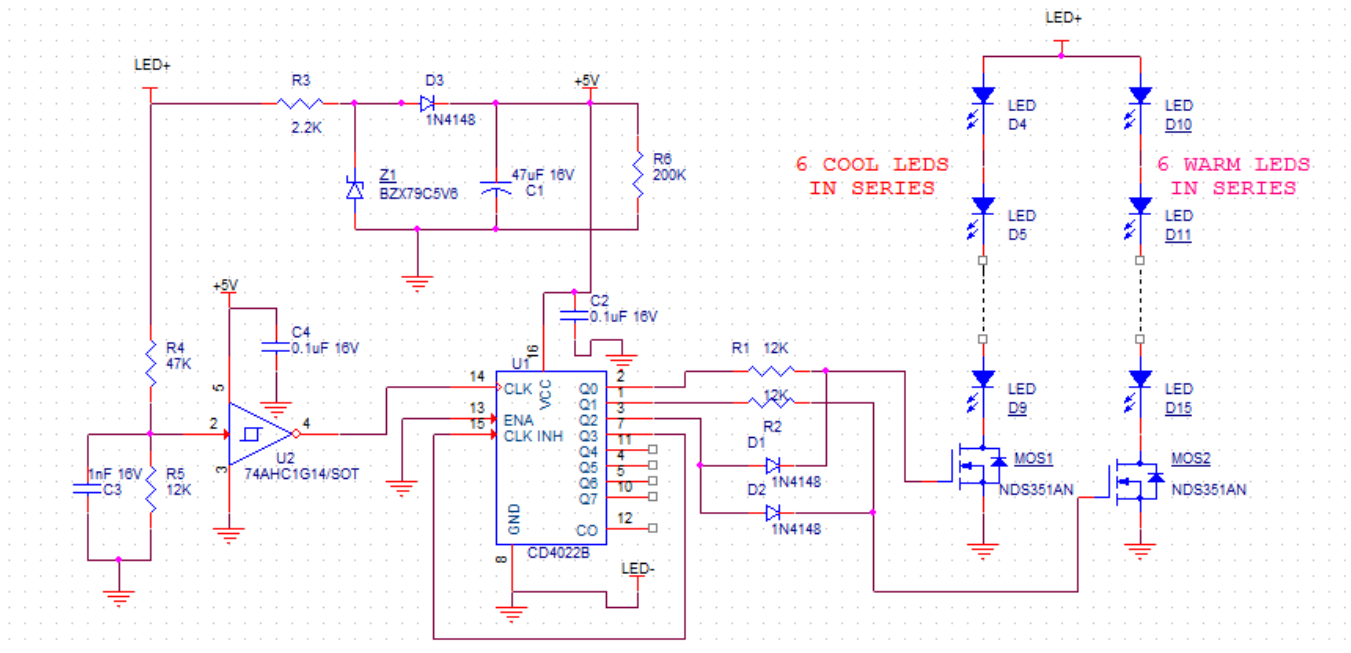

Figure 2. Schematic of the Additional Part

3 Bill of Materials

This section lists the bill of materials for the additional part schematic.

Table 2. Bill of Materials

Item	Qty	Reference	Value	Description	Part Number	Manufacturer	Size
1	2	C2, C4	0.1 μ F	Capacitor smd Ceramic 16 V, 0805 , X7R	Std	Std	805
2	1	C3	1 μ F	Capacitor smd Ceramic 16 V, 0805 , X7R	Std	Std	805
3	1	C1	47 μ F	Capacitor, Alum Electrolytic, 16 V, \pm 20%	Std	Std	-----
4	3	D1, D2, D3	1N4148	Diode Rectifier, 100 V, 150 mA	1N4148	Vishay	DO-35
5	1	MOS1, MOS2	NDS351AN	Trans, N-channel MOSFET , 1.4 A, 30 V	NDS351AN	Fairchild	SOT-23
6	3	R1, R2, R5	12 K	Resistor, Chip, 1/8 W, 1%	Std	Std	805
7	1	R4	47 K	Resistor, Chip, 1/8 W, 1%	Std	Std	805
8	1	R3	2.2 K	Resistor, Chip, 1/8 W, 1%	Std	Std	805
9	1	R6	200 K	Resistor, Chip, 1/8 W, 5%	Std	Std	0805
10	1	Z1	5.6 V	Zener Diode 5.6 V 500 mW	BZX79C5V6	NXP	DO-35
11	1	U1	CD4022B	CMOS Octal Counter with 8 Decoded Outputs	CD4022BPWR	TI	TSSOP-16
12	1	U2	74AHC1G14	Single Schmitt-Trigger Inverter Gate	74AHC1G14D BV	TI	SOT-23(5)

Experimental Results

A.1 Output Waveforms of Octal Counter U1

Q0, Q1, Q2 and CLK pins of U1 are observed each time the TPS92314A19230VEVM integrated with additional circuit is switched ON and OFF through the AC mains switch. The difference between switch off and the following switch on is approximately 1 second.

The settings of oscilloscope are as below:

- Green trace: Q0 of U1, 5 V/div
- Blue trace: Q1 of U1, 5 V/div
- Aqua trace: Q2 of U1, 5 V/div
- Violet trace: CLK of U1, 5 V/div

During the first switch on Q0 goes high and Q1, Q2, and CLK and Q3 remains low as shown in [Figure 3](#).

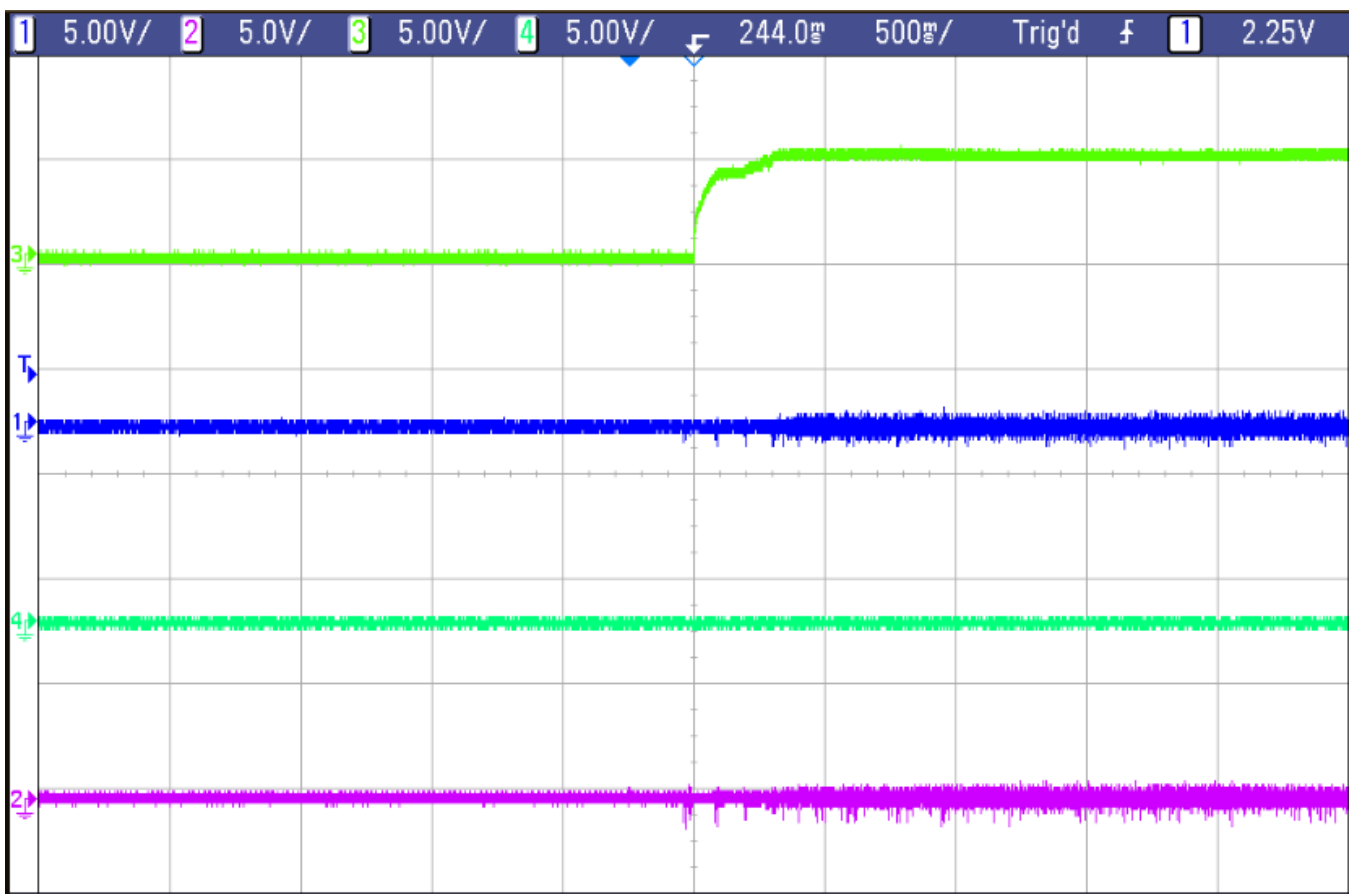

Figure 3. Q0, Q1, Q2 and CLK States of U1 During First Time Switch ON of AC Switch

When the AC switch is turned off for the first time, with CLK set to low-to-high transition, Q0 goes low and Q1 goes high as shown in Figure 4.

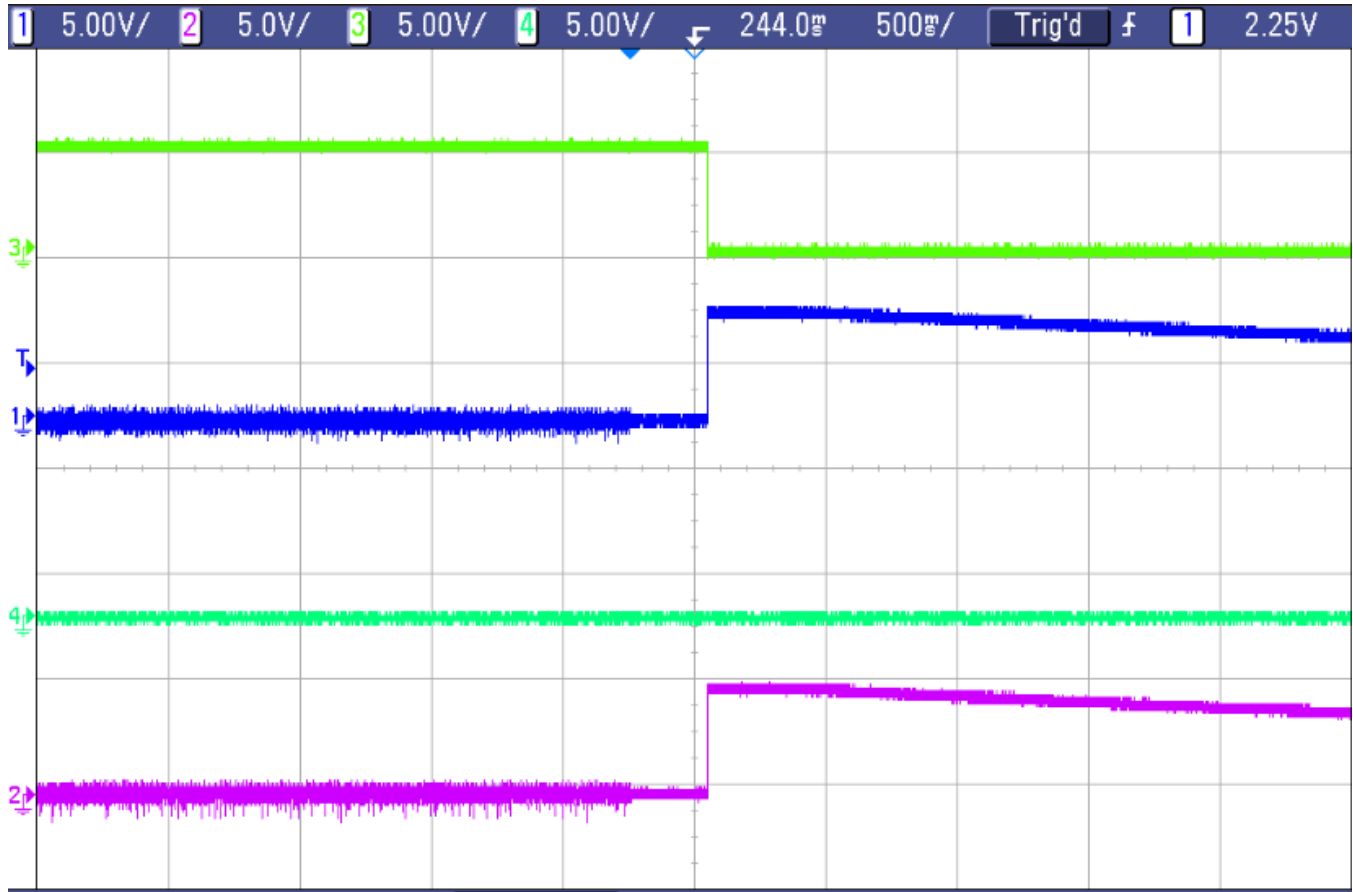

Figure 4. Q0, Q1, Q2 and CLK States of U1 During First Time Switch OFF of AC Switch

The second time the AC switch is turned on, Q1 goes high, Q0 and Q2 are low, and CLK is low.

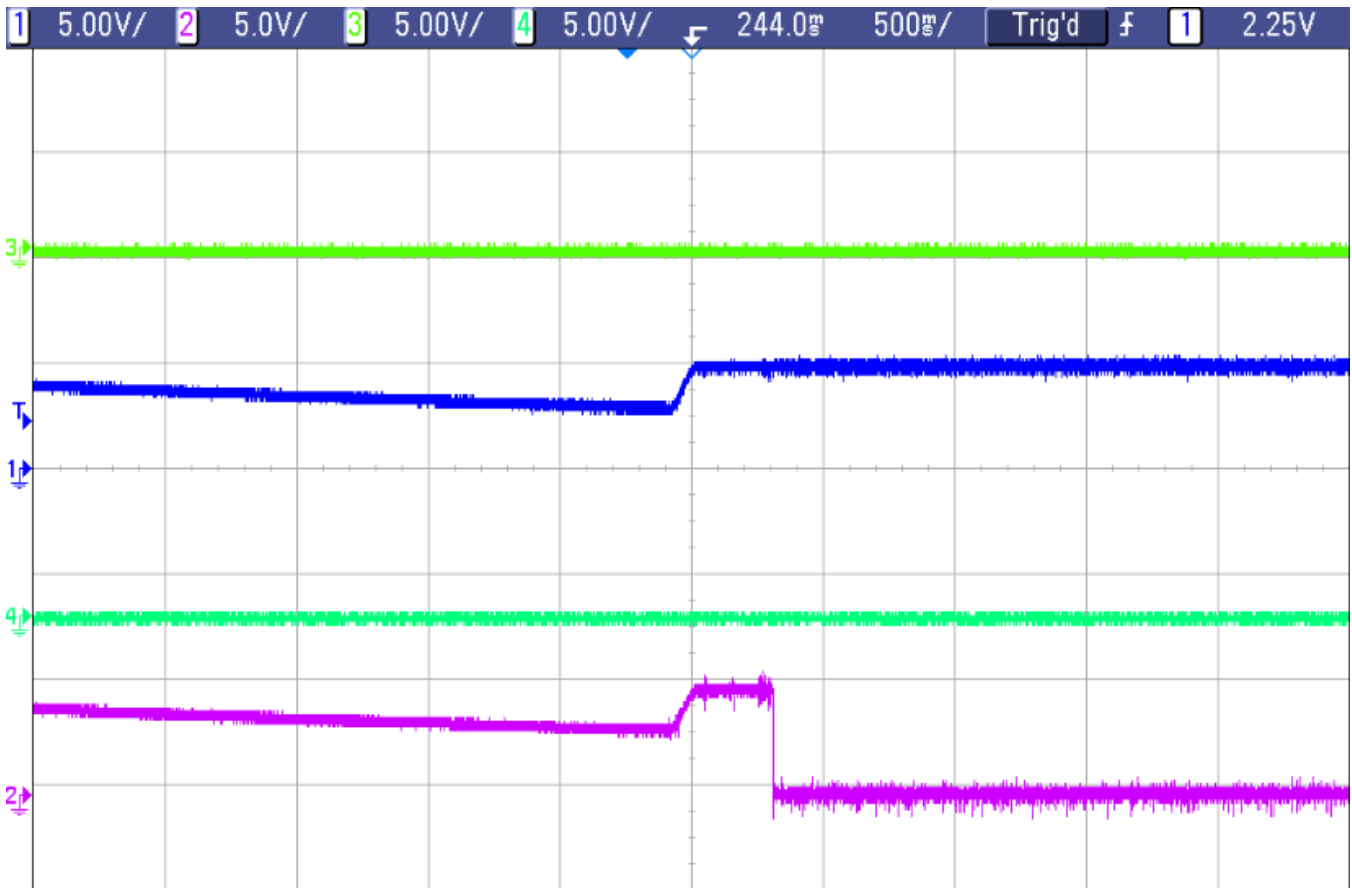

Figure 5. Q0, Q1, Q2 and CLK States of U1 During Second Time Switch ON of AC Switch

The second time the AC switch is turned off, with the CLK set to low-to-high transition, Q1 goes low and Q2 goes high.

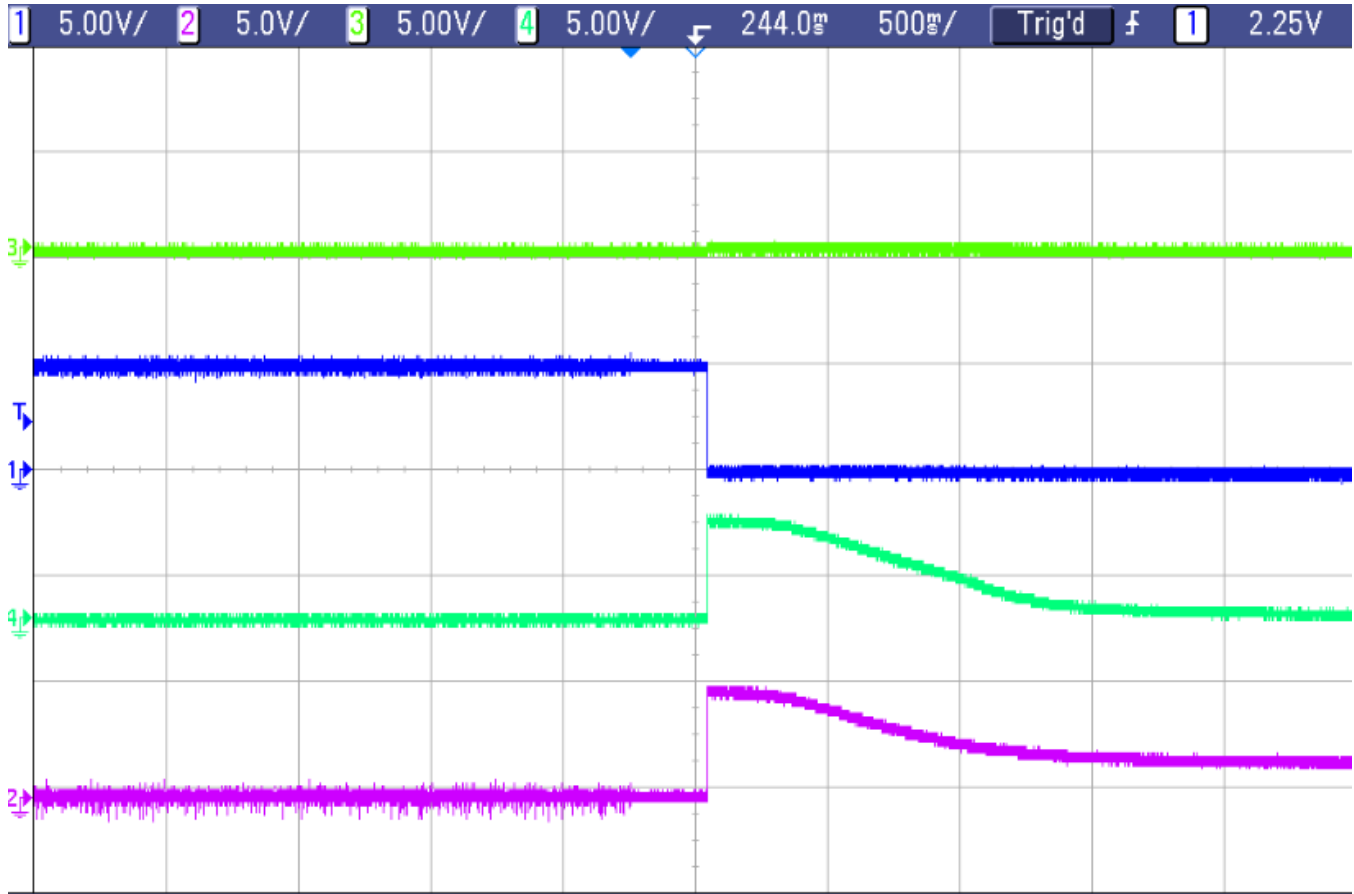

Figure 6. Q0, Q1, Q2 and CLK States of U1 during Second Time Switch OFF of AC Switch

The third time the AC switch is turned on, Q2 goes high while Q0, Q1, and CLK remains low as shown in Figure 7.

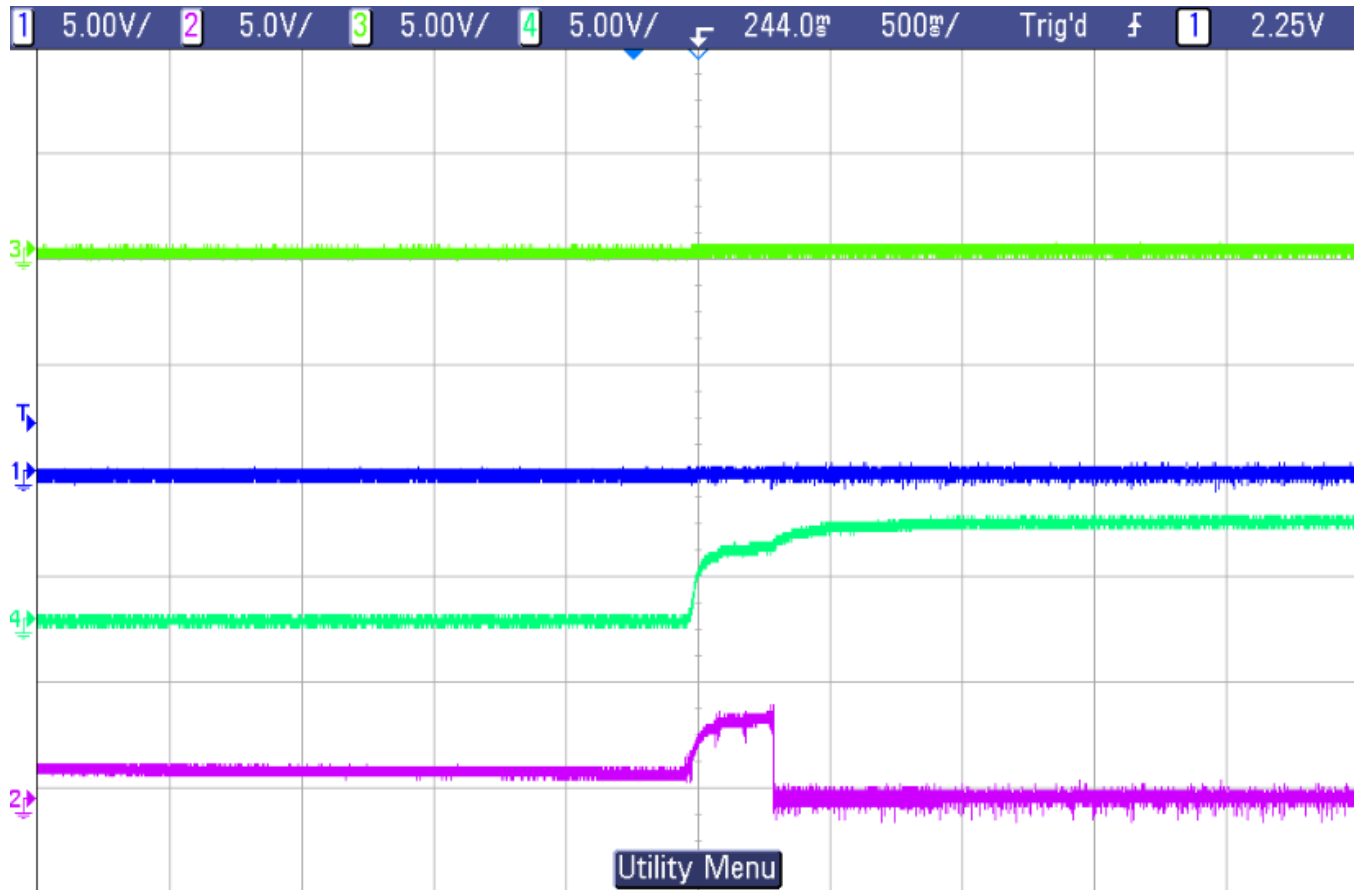

Figure 7. Q0, Q1, Q2 and CLK States of U1 during Third Time Switch ON of AC Switch

The third time the AC switch is turned off with CLK set to low-to-high transition, Q2 goes low and Q3 goes high which resets U1 thus making Q0 high as shown in Figure 8.

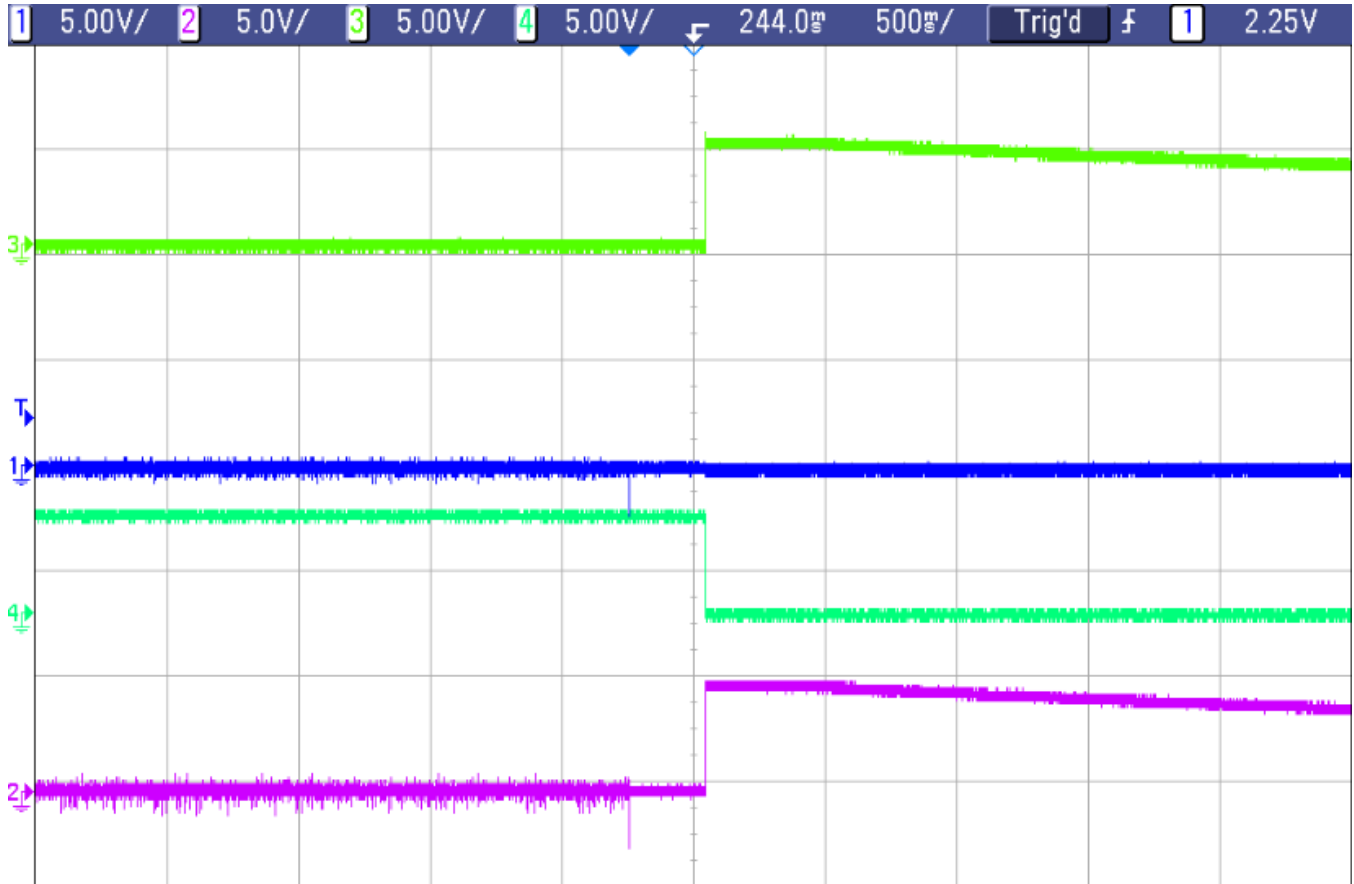

Figure 8. Q0, Q1, Q2 and CLK States of U1 during Third Time Switch OFF of AC Switch

A.2 MOS1 and MOS2 Gate Drive Waveforms

Gate Drive Waveforms of MOSFETs MOS1, MOS2 and CLK pin of U1 are observed each time the TPS92314A19230VEVM integrated with additional circuit is switched on and off through the AC mains switch. The difference between switch off and the next switch on is approximately 1 second.

The oscilloscope settings are:

- Green trace: Gate drive of MOS1, 5 V/div
- Blue trace: Gate drive of MOS2, 5 V/div
- Violet trace: CLK of U1, 5 V/div

The first time the AC switch is turned on the Gate of MOS1 goes high (5 V) as shown in the [Figure 9](#). As the gate goes high the MOS1 and the Cool LEDs turn on.

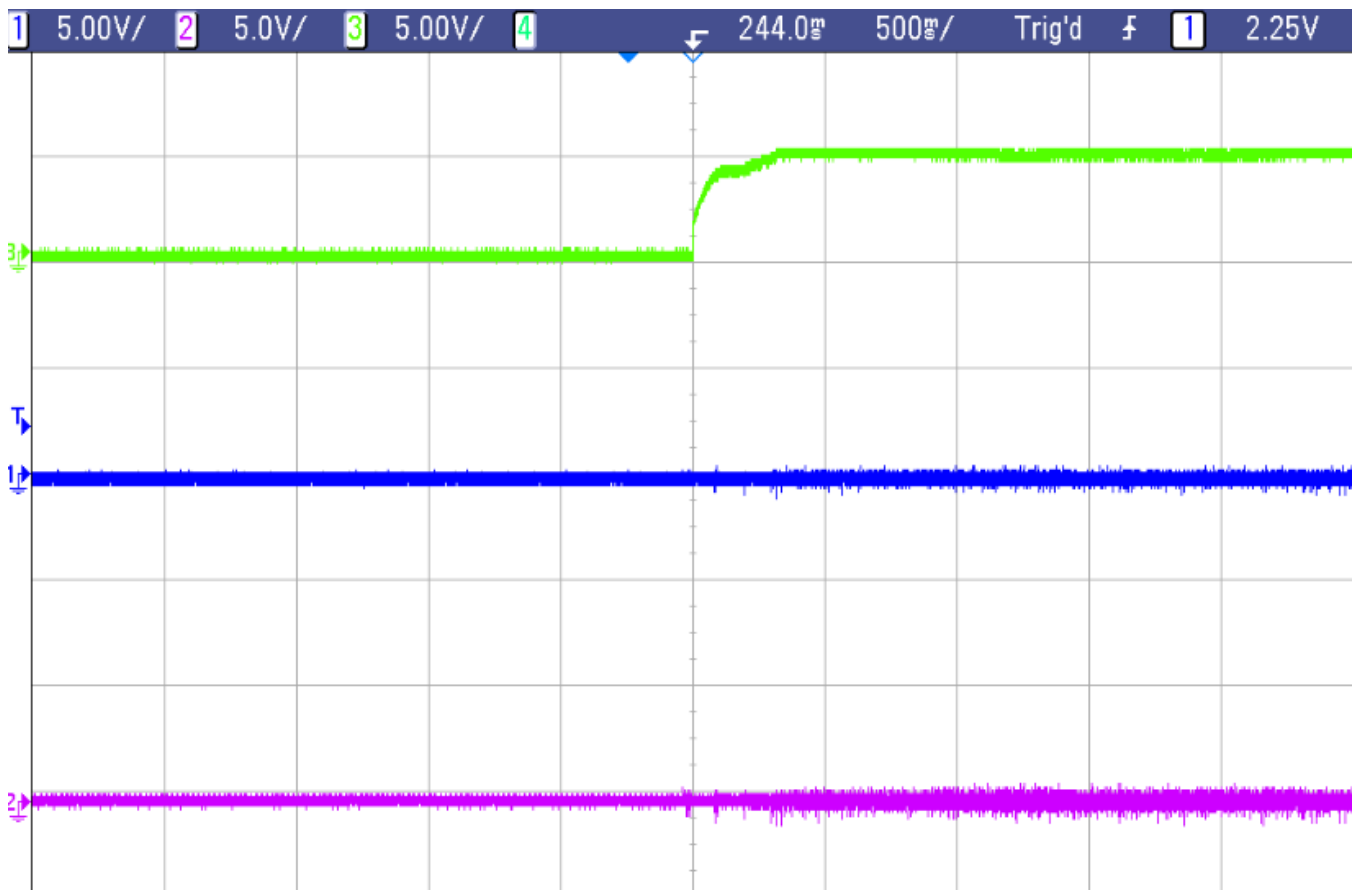

Figure 9. Gate Drive of MOS1, MOS2 and CLK State of U1 during First Time Switch ON of AC Switch

The second time the AC Switch turns on the Gate of MOS2 goes high (5 V). As the gate goes high the MOS2 and the Warm LEDs turn on as shown in Figure 10.

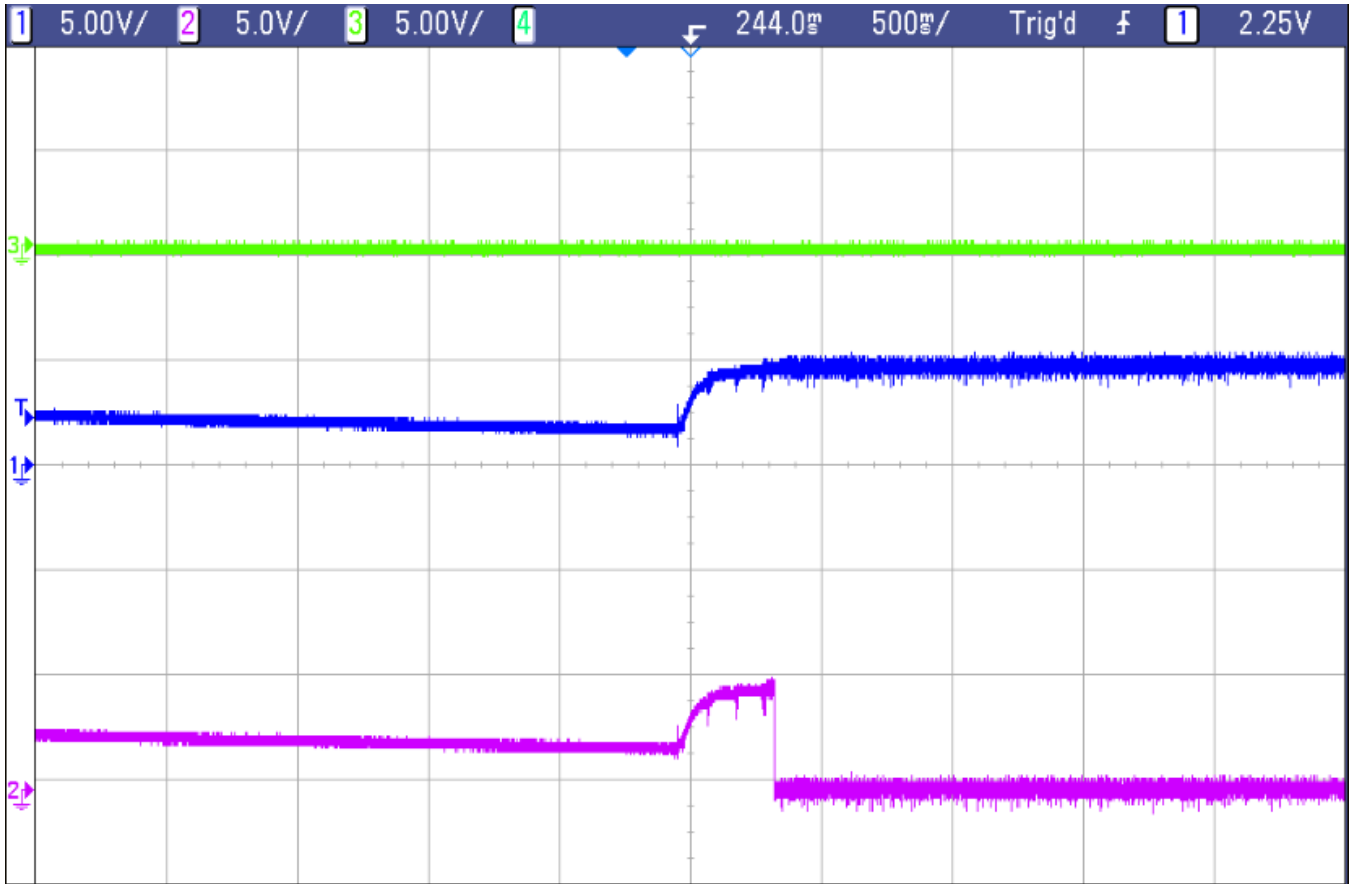

Figure 10. Gate Drive of MOS1, MOS2 and CLK State of U1 during Second Time Switch ON of AC Switch

The third time the AC Switch turns on the Gates MOS1 and MOS2 go high (5 V). As the gates go high the MOS1 and MOS2, the cool LEDs, and the warm LEDs turn on.

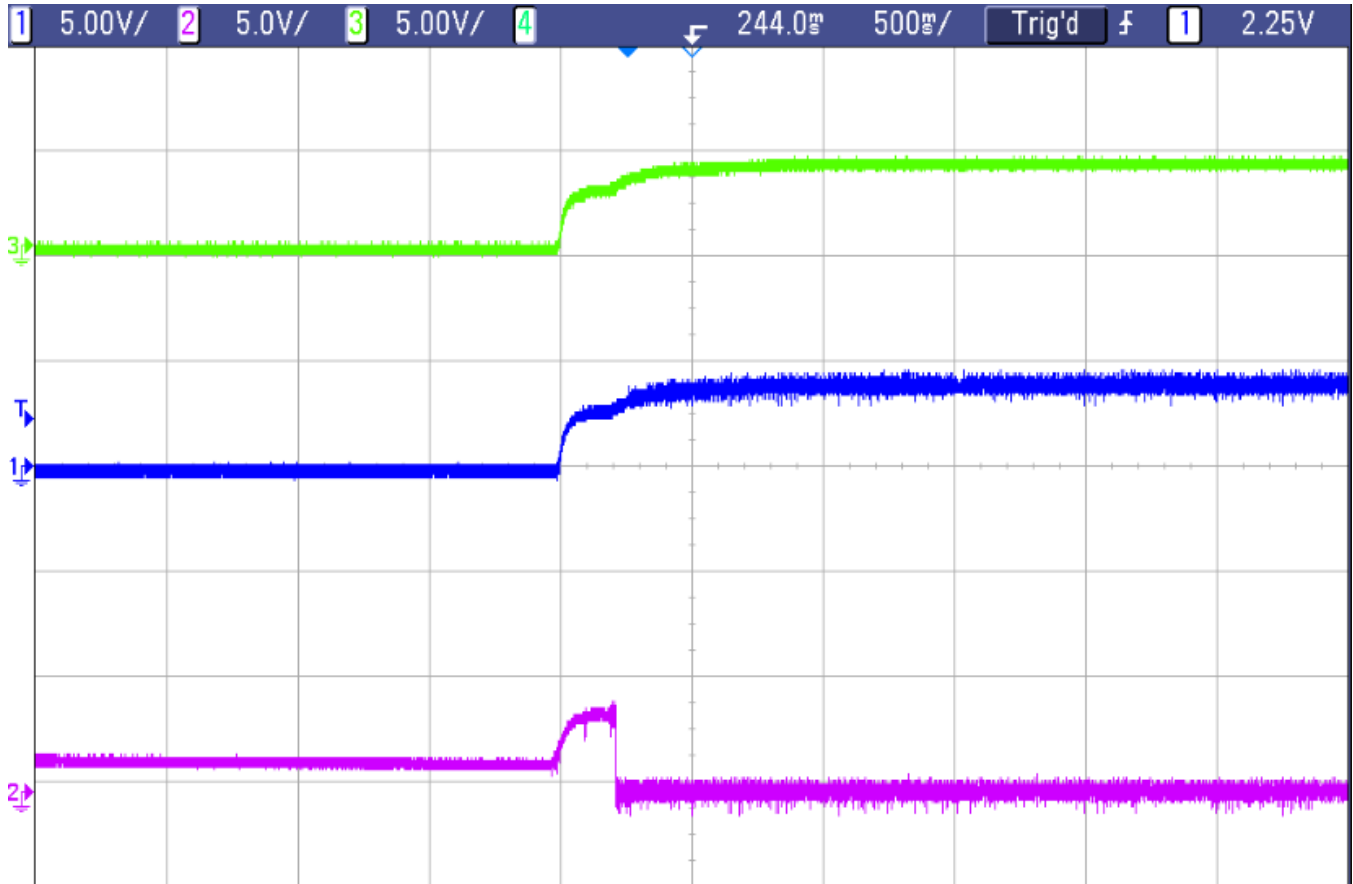

Figure 11. Gate Drive of MOS1, MOS2 and CLK State of U1 During Third Time Switch ON of AC Switch

A.1 Turn On Waveforms

The LED output voltage of TPS92314 EVM along with +5 V_{CC} voltage of U1 and U2 are observed during turn on.

The oscilloscope settings are as follows:

- Green trace: +5 V Output, 2 V/div
- Violet trace: LED Output Voltage LED+, 5 V/div

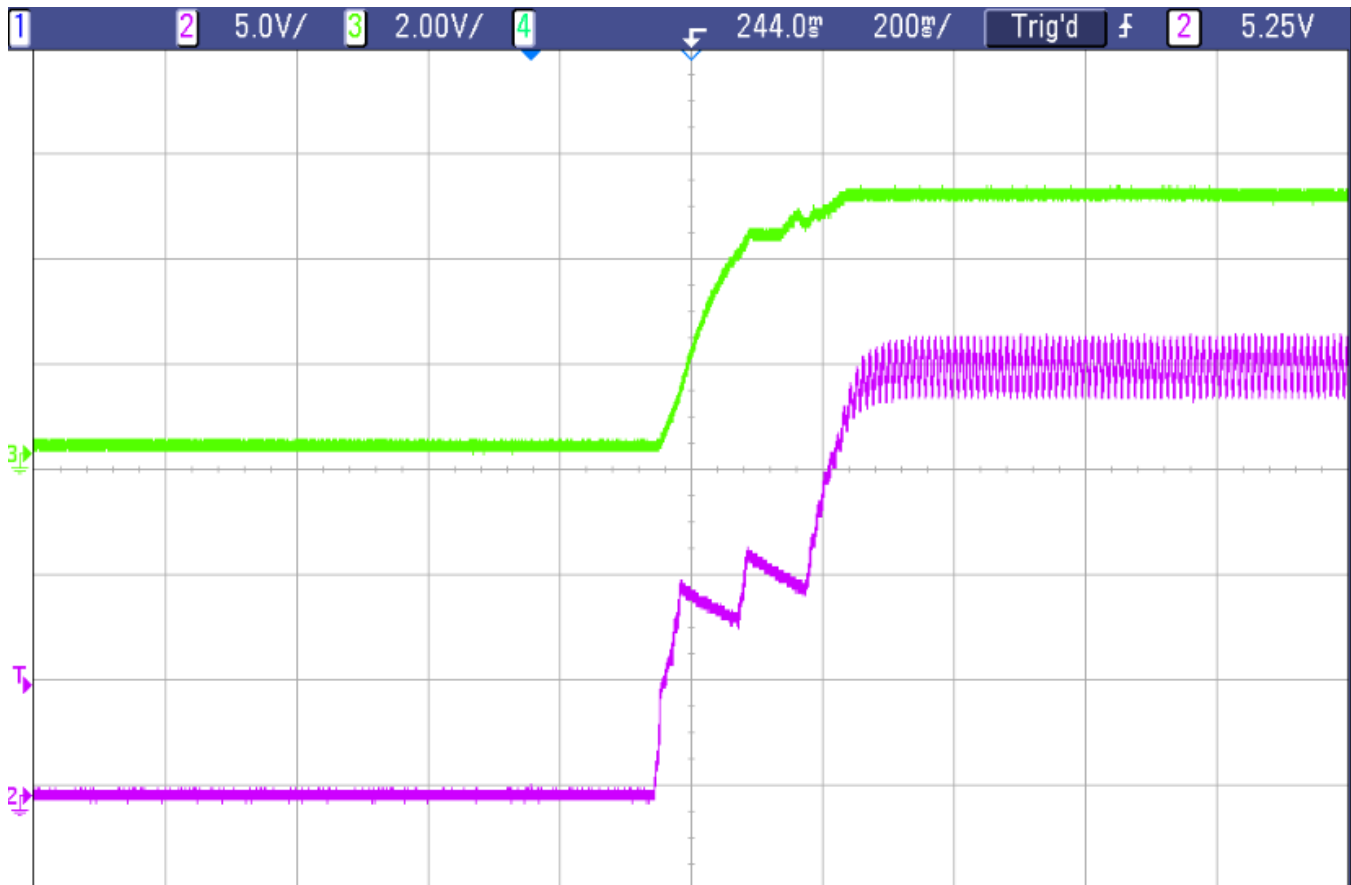

Figure 12. +5 V and LED Output Voltage Turn On Waveform

A.2 Conclusion

The novel circuit is fully explained, analyzed and tested in integration with the TPS92314A19230VEVM operating in flyback topology. The same schematic and design equations derived are applicable for non-isolated buck-boost or buck topology using the TPS92314.

A.3 References

- Using the TPS92314A19230VEVM User's Guide, Literature Number: SLUUA17A
- Datasheet- CMOS Octal Counter with 8 Decoded Outputs, CD4022B, Literature Number: SCHS0027C
- Datasheet -Single Schmitt-Trigger Inverter Gate, 74AHC1G14, Literature Number: SCLS321Q

IMPORTANT NOTICE

Texas Instruments Incorporated and its subsidiaries (TI) reserve the right to make corrections, enhancements, improvements and other changes to its semiconductor products and services per JESD46, latest issue, and to discontinue any product or service per JESD48, latest issue. Buyers should obtain the latest relevant information before placing orders and should verify that such information is current and complete. All semiconductor products (also referred to herein as "components") are sold subject to TI's terms and conditions of sale supplied at the time of order acknowledgment.

TI warrants performance of its components to the specifications applicable at the time of sale, in accordance with the warranty in TI's terms and conditions of sale of semiconductor products. Testing and other quality control techniques are used to the extent TI deems necessary to support this warranty. Except where mandated by applicable law, testing of all parameters of each component is not necessarily performed.

TI assumes no liability for applications assistance or the design of Buyers' products. Buyers are responsible for their products and applications using TI components. To minimize the risks associated with Buyers' products and applications, Buyers should provide adequate design and operating safeguards.

TI does not warrant or represent that any license, either express or implied, is granted under any patent right, copyright, mask work right, or other intellectual property right relating to any combination, machine, or process in which TI components or services are used. Information published by TI regarding third-party products or services does not constitute a license to use such products or services or a warranty or endorsement thereof. Use of such information may require a license from a third party under the patents or other intellectual property of the third party, or a license from TI under the patents or other intellectual property of TI.

Reproduction of significant portions of TI information in TI data books or data sheets is permissible only if reproduction is without alteration and is accompanied by all associated warranties, conditions, limitations, and notices. TI is not responsible or liable for such altered documentation. Information of third parties may be subject to additional restrictions.

Resale of TI components or services with statements different from or beyond the parameters stated by TI for that component or service voids all express and any implied warranties for the associated TI component or service and is an unfair and deceptive business practice. TI is not responsible or liable for any such statements.

Buyer acknowledges and agrees that it is solely responsible for compliance with all legal, regulatory and safety-related requirements concerning its products, and any use of TI components in its applications, notwithstanding any applications-related information or support that may be provided by TI. Buyer represents and agrees that it has all the necessary expertise to create and implement safeguards which anticipate dangerous consequences of failures, monitor failures and their consequences, lessen the likelihood of failures that might cause harm and take appropriate remedial actions. Buyer will fully indemnify TI and its representatives against any damages arising out of the use of any TI components in safety-critical applications.

In some cases, TI components may be promoted specifically to facilitate safety-related applications. With such components, TI's goal is to help enable customers to design and create their own end-product solutions that meet applicable functional safety standards and requirements. Nonetheless, such components are subject to these terms.

No TI components are authorized for use in FDA Class III (or similar life-critical medical equipment) unless authorized officers of the parties have executed a special agreement specifically governing such use.

Only those TI components which TI has specifically designated as military grade or "enhanced plastic" are designed and intended for use in military/aerospace applications or environments. Buyer acknowledges and agrees that any military or aerospace use of TI components which have **not** been so designated is solely at the Buyer's risk, and that Buyer is solely responsible for compliance with all legal and regulatory requirements in connection with such use.

TI has specifically designated certain components as meeting ISO/TS16949 requirements, mainly for automotive use. In any case of use of non-designated products, TI will not be responsible for any failure to meet ISO/TS16949.

Products

Audio	www.ti.com/audio
Amplifiers	amplifier.ti.com
Data Converters	dataconverter.ti.com
DLP® Products	www.dlp.com
DSP	dsp.ti.com
Clocks and Timers	www.ti.com/clocks
Interface	interface.ti.com
Logic	logic.ti.com
Power Mgmt	power.ti.com
Microcontrollers	microcontroller.ti.com
RFID	www.ti-rfid.com
OMAP Applications Processors	www.ti.com/omap
Wireless Connectivity	www.ti.com/wirelessconnectivity

Applications

Automotive and Transportation	www.ti.com/automotive
Communications and Telecom	www.ti.com/communications
Computers and Peripherals	www.ti.com/computers
Consumer Electronics	www.ti.com/consumer-apps
Energy and Lighting	www.ti.com/energy
Industrial	www.ti.com/industrial
Medical	www.ti.com/medical
Security	www.ti.com/security
Space, Avionics and Defense	www.ti.com/space-avionics-defense
Video and Imaging	www.ti.com/video

TI E2E Community

e2e.ti.com