

TPS25810 Charging Port Over USB Type-C™

Andrew Hung

Taiwan Field Application Engineer

ABSTRACT

The TPS25810 is a USB Type-C downstream facing port (DFP) controller that monitors the USB Type-C™ configuration channel (CC) lines to determine when a USB device is attached. When the upstream facing port (UFP) device Type C-to-B dongle is plugged in, the port supports connection of Type-B receptacle devices such as a mouse, smartphones, keyboards, external hard drives, and so forth. As these devices monitor the USB 2 data line (D+/D–), the TPS2544 USB charging port controller can be added to provide the electrical signatures on D+/D– to support BC1.2 and non-BC1.2 compliant charging schemes. This application note presents the design solution which offers fast charging of popular mobile phones, tablets, and media devices over the USB Type-C port.

Contents

1	Introduction	2
2	Implementation	3
3	Device Tests.....	4
4	Summary	12
5	References	12

List of Figures

1	TPS25810 Charging Port Over USB Type-C Circuit Utilizing TPS2544	3
2	TPS25810 and TPS2544 (CDP Mode) Test With iPhone6, With Type C-to-B Dongle Connected to Device, Then Plug in the Host	4
3	TPS25810 and TPS2544 (CDP Mode) Test With iPhone6, With Type C-to-B Dongle Connected to Host, Then Plug in the Device	5
4	TPS25810 and TPS2544 (CDP Mode) Test With Galaxy S6, With Type C-to-B Dongle Connected to Device Then Plug In Host	5
5	TPS25810 and TPS2544 (CDP Mode) Test With Galaxy S6, With Type C-to-B Dongle Connected to Host Then Plug In Device	6
6	TPS25810 and TPS2544 (DCP Auto Mode) Test With iPhone6, With Type C-to-B Dongle Connected to Device Then Plug In Host	7
7	TPS25810 and TPS2544 (DCP Auto Mode) Test With iPhone6, With Type C-to-B Dongle Connected TO Host Then Plug In Device	8
8	TPS25810 and TPS2544 (DCP Auto Mode) Test With Galaxy S6, With Type C-to-B Dongle Connected TO Device Then Plug In Host	8
9	TPS25810 and TPS2544 (DCP Auto Mode) Test With Galaxy S6, With Type C-to-B Dongle Connected to Host Then Plug In Device	9
10	TPS25810 and TPS2544 (DCP Auto Mode) Test With HTC Sense, With Type C-to-B Dongle Connected to Device Then Plug In Host	9
11	TPS25810 and TPS2544 (DCP Auto Mode) Test With HTC Sense, With Type C-to-B Dongle Connected to Host Then Plug In Device	10

Apple, iPhone are registered trademarks of Apple Inc.
 Samsung, Galaxy S are registered trademarks of Samsung Electronics Co., Ltd.
 USB Type-C is a trademark of USB Implementers Forum.
 All other trademarks are the property of their respective owners.

12	TPS25810 and TPS2544 (DCP Auto Mode) Test With Bold 9000, With Type C-to-B Dongle Connected to Device Then Plug In Host.....	10
13	TPS25810 and TPS2544 (DCP Auto Mode) Test With Bold 9000, With Type C-to-B Dongle Connected to Host Then Plug In Device.....	11

List of Tables

1	Maximum Current	12
---	-----------------------	----

1 Introduction

This application report presents the design solution for the TPS25810 to offer fast charging of popular mobile phones, tablets, and media devices over the USB Type-C port. Most existing USB devices such as a mouse, smartphones, keyboards, external hard drives, and so forth, utilize the Type-B receptacle. In order to support Type-B receptacle devices on the USB Type-C port, a Type C-to-B dongle must be connected in between. When the Type C-to-B dongle is plugged into the Type-C port, the TPS25810 broadcasts current capability over the CC lines. This current capability is not received by the Type-B receptacle device which monitors USB 2 data line (D+/D-), leading to the device drawing 500 mA maximum defined by USB 2 or 900 mA for USB 3. This current level has become insufficient for many handsets and personal media players that require a higher charging rate. By adding the USB charging port controller like the TPS2543, TPS2544, or TPS2546 that all provide the electrical signatures on D+/D- to support BC1.2 and non-BC1.2 compliant charging schemes, it allows host and client devices to acknowledge the protocol handshake and draw additional current beyond the 500 mA or 900 mA maximum defined by USB2 and USB3. The support of protocol handshakes charging downstream port (CDP) and dedicated charging port (DCP) are explored by using the TPS2544 as an example in this application note.

The first two solutions have similar architectures and use the \overline{UFP} pin of the TPS25810 to turn on and off an external blocking MOSFET. This FET must be rated at 30 V (VDS or VSD absolute maximum) in order to handle the high voltage of non-compliant devices. The external blocking MOSFET remains off, by default, and blocks any high voltage on VBUS in the event of a non-compliant DFP device. The MOSFET will only turn on, connecting the OUT pin of the TPS25810 to the VBUS pin of the Type-C connector, if the device is Type-C UFP compliant.

The CDP is a USB port that follows USB BC1.2 and supplies a minimum of 1.5 A per port while maintaining USB 2 data line (D+/D-) communication.

The DCP only provides power but does not support data connection to the UFP. The DCP is identified by the electrical characteristics of its data lines, and in the DCP auto state, the device charge detection state machine is activated to selectively implement charging schemes involved with the shorted, divider1, divider2, and 1.2-V modes.

The TPS2810 data sheet ([SLVSCR1](#)), TPS2544 data sheet ([SLVSBU8](#)), and the USB Type-C documentation (<http://www.usb.org/developers/usdtypec/>) are good resources to have a general understanding of before reading this application note.

2 Implementation

The operation of the charging over the Type-C port circuit presented in Figure 1 depends on the TPS2544 for providing the electrical signatures on D+/D– to support BC1.2 and non-BC1.2 compliant charging schemes. The internal switch of the TPS25810 is connected between the 5-V power source and the Type-C connector VBUS, while the TPS2544 internal switch is not connected.

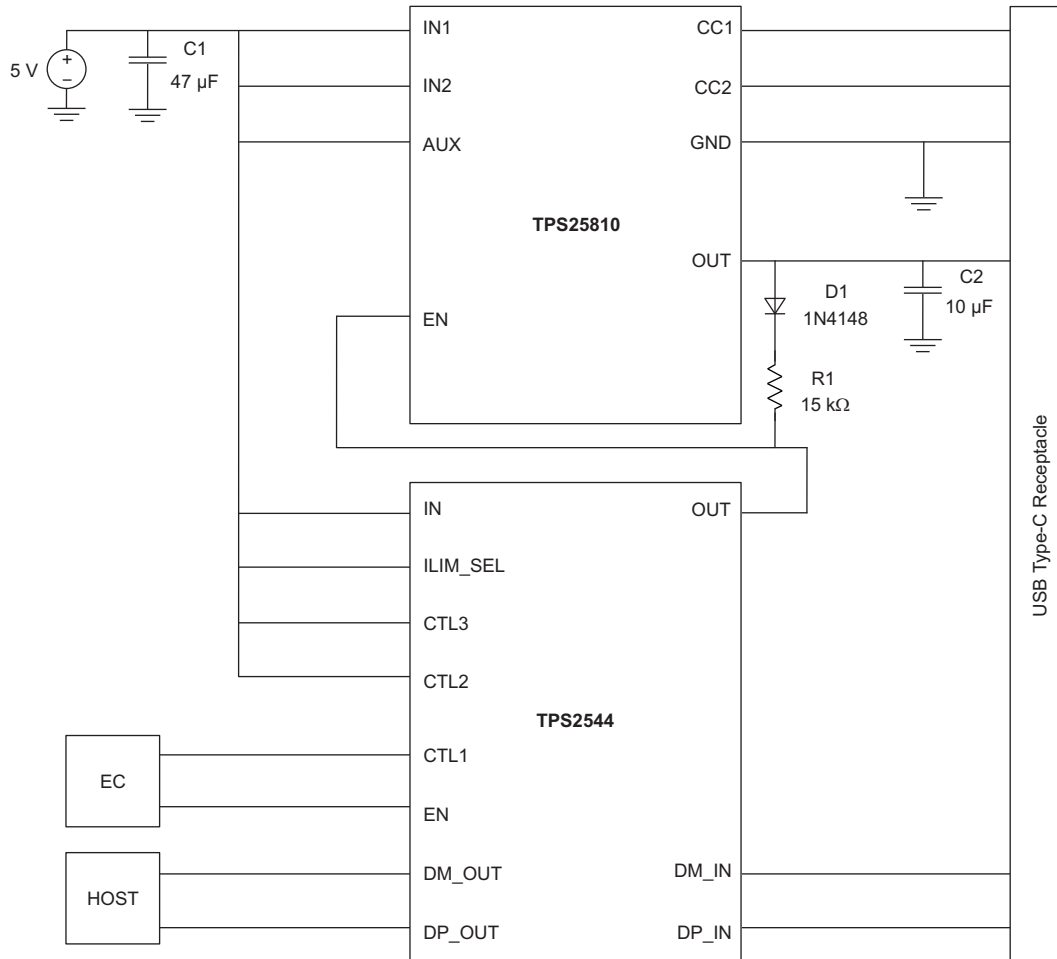

Figure 1. TPS25810 Charging Port Over USB Type-C Circuit Utilizing TPS2544

The TPS2544 OUT is connected to the TPS25810 EN to control the VBUS discharge for mode changes between:

1. **CDP and DCP** - When a human interface device (HID) such as a mouse or keyboard is detected, there is no output discharge since the TPS2544 overrides the specific CTL pin changes between the control pin (CTL1–CTL3) settings CDP (111) and DCP auto (011); therefore, keeping the D+/D– lines connected to the system to support the mouse and keyboard wake function. Details of the operation are described in the TPS2544 data sheet.
2. **DCP Auto** - This allows the TPS2544 to selectively implement charging schemes involved with the Shorted, Divider1, Divider2, and 1.2-V modes.

The TPS2544 internal switch is not connected in series with TPS25810 because the $R_{DS(on)}$ of both TPS25810 and TPS2544 are too large and violate the 4.75-V minimum specification when 3-A current is drawn. As no load current is drawn from the TPS2544 switch, there is a limitation of no Divider2 mode support as > 750 mA is required.

D1 and R1 assist the TPS25810 with discharge of the 10-µF capacitor.

Various popular smartphone devices were tested under CDP and DCP Auto condition. Taking into consideration that there are two plug in sequences, the following were tested:

1. Type C-to-B dongle connected to the host, then plug in the device.
2. Type C-to-B dongle connected to the device, then plug in the host.

With the former condition, the V_{OUT} 5 V is already established as TPS25810 detects UFP Type C-to-B dongle, while in the later condition the V_{OUT} 5 V is given after UFP attaches. The max charging current (I_{OUT}) consumed by the device is also measured in the scope shots.

3 Device Tests

3.1 Charging Dedicated Mode (CDP) Mode

A CDP is a USB port that follows USB BC1.2 and supplies a minimum of 1.5 A per port. It provides power and meets USB 2 requirements for device enumeration. USB 2 communication is supported, and the host controller must be active to allow charging. What separates a CDP from an SDP is the host-charge handshaking logic that identifies this port as a CDP. A CDP is identifiable by a compliant BC1.2 client device and allows for additional current draw by the client device.

For the following test scheme, the TPS2544 control pin (CTL1-CTL3) settings are programmed to 1111 for CDP mode. The tested devices which support CDP are Apple® iPhone® 6 and Samsung® Galaxy S® 6. The observed result is that both devices successfully detect CDP mode to draw over 500 mA.

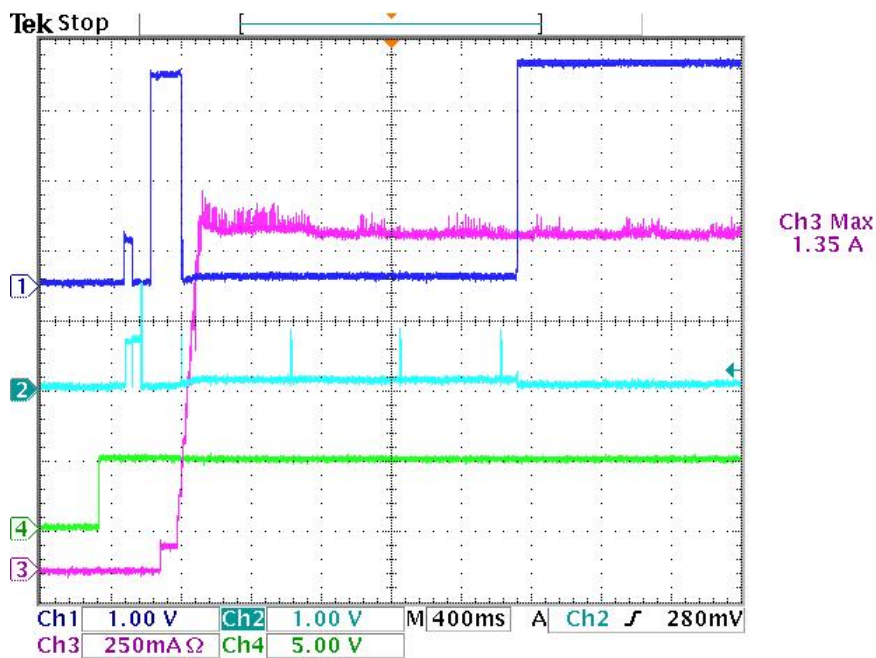

CH1: D+, CH2: D-, CH3: I_{OUT} , CH4: V_{OUT}

Figure 2. TPS25810 and TPS2544 (CDP Mode) Test With iPhone6, With Type C-to-B Dongle Connected to Device, Then Plug in the Host

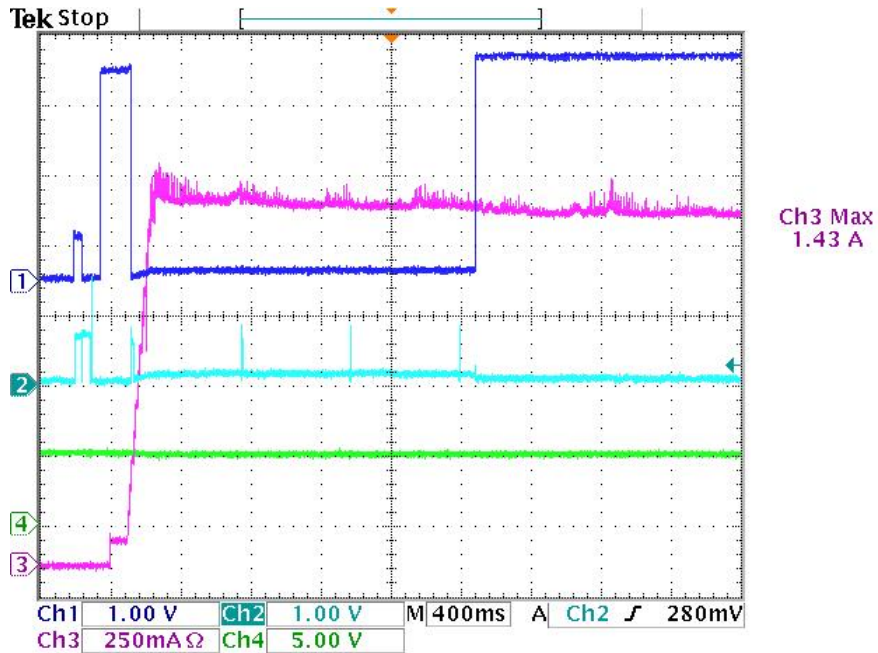

CH1: D+, CH2: D-, CH3: I_{OUT}, CH4: V_{OUT}

Figure 3. TPS25810 and TPS2544 (CDP Mode) Test With iPhone6, With Type C-to-B Dongle Connected to Host, Then Plug in the Device

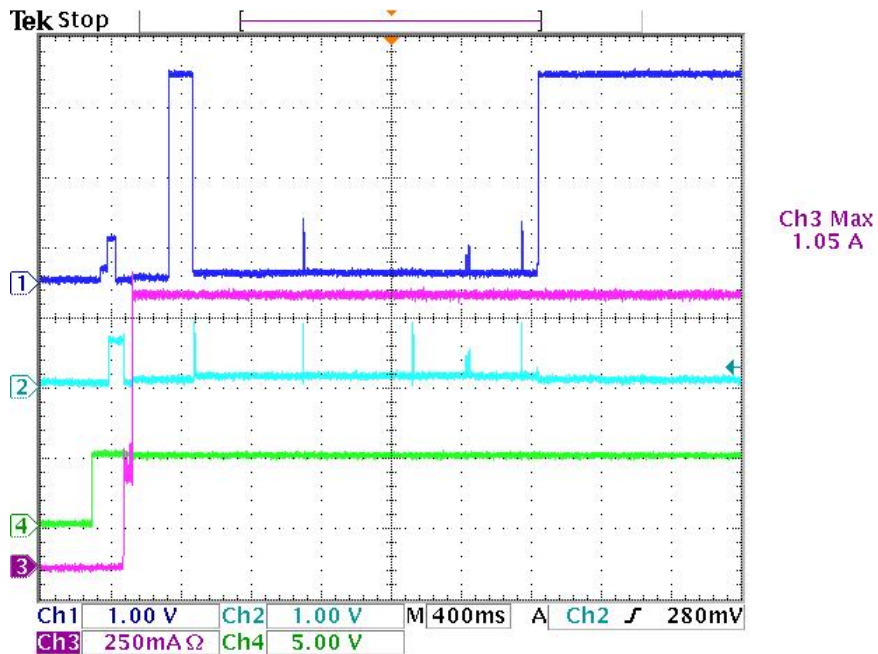

CH1: D+, CH2: D-, CH3: I_{OUT}, CH4: V_{OUT}

Figure 4. TPS25810 and TPS2544 (CDP Mode) Test With Galaxy S6, With Type C-to-B Dongle Connected to Device Then Plug in Host

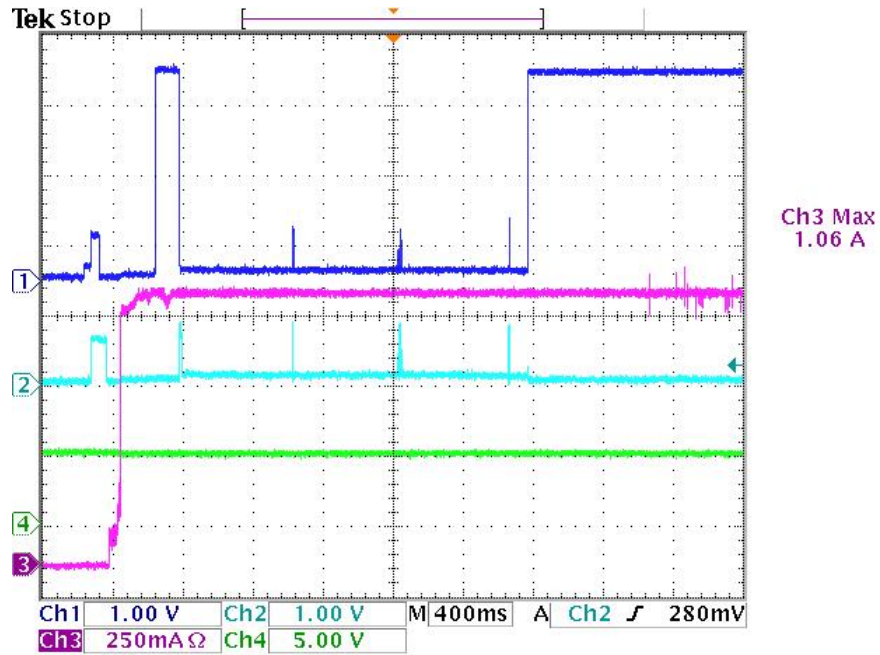

CH1: D+, CH2: D-, CH3: I_{OUT} , CH4: V_{OUT}

Figure 5. TPS25810 and TPS2544 (CDP Mode) Test With Galaxy S6, With Type C-to-B Dongle Connected to Host Then Plug In Device

3.2 Dedicated Charging Port (DCP) Auto Mode

A DCP only provides power but does not support data connection to an upstream port. In the TPS2544 DCP Auto state, the device charge detection state machine is activated to selectively implement charging schemes involved with the Shorted, Divider1, Divider2, and 1.2-V modes. Shorted DCP mode complies with BC1.2 and Chinese Telecommunications Industry Standard YD/T 1591-2009, while the Divider and 1.2V modes are employed to charge devices that do not comply with BC1.2 DCP standard.

For the following test scheme the TPS2544 control pin (CTL1-CTL3) settings are programmed to 0111 for DCP Auto mode. The tested devices are Apple iPhone6 (Divider1), Samsung Galaxy S6 (1.2-V mode), HTC Sense (DCP shorted) and Blackberry Bold 9000 (DCP shorted). The observed result is that both devices successfully detect CDP mode to draw over 500mA. As shown with the Blackberry device test waveform, the V_{OUT} 5V is discharged in order for the device to redetect the new DCP short setting from TPS2544.

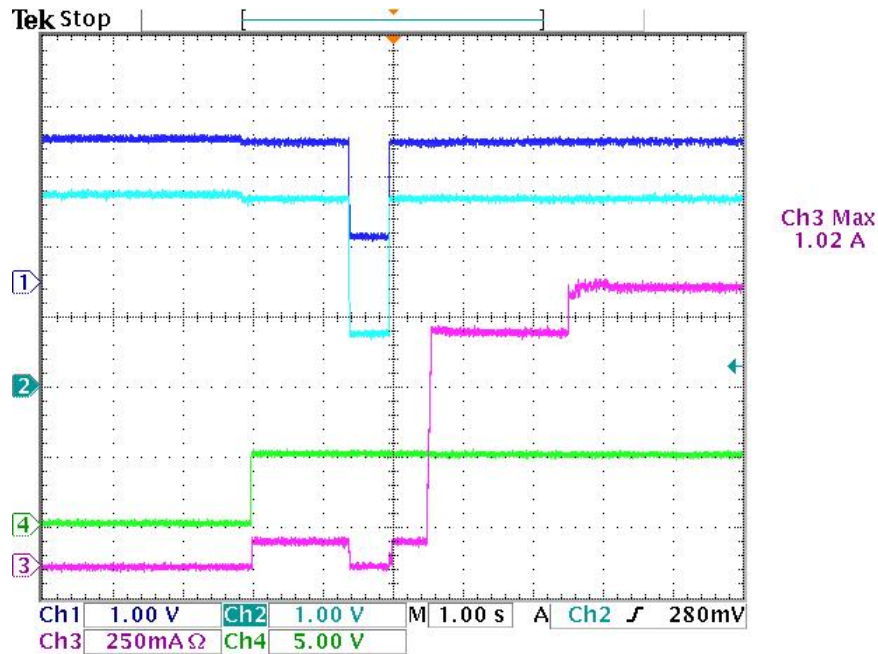

CH1: D+, CH2: D-, CH3: I_{OUT} , CH4: V_{OUT}

Figure 6. TPS25810 and TPS2544 (DCP Auto Mode) Test With iPhone6, With Type C-to-B Dongle Connected to Device Then Plug In Host

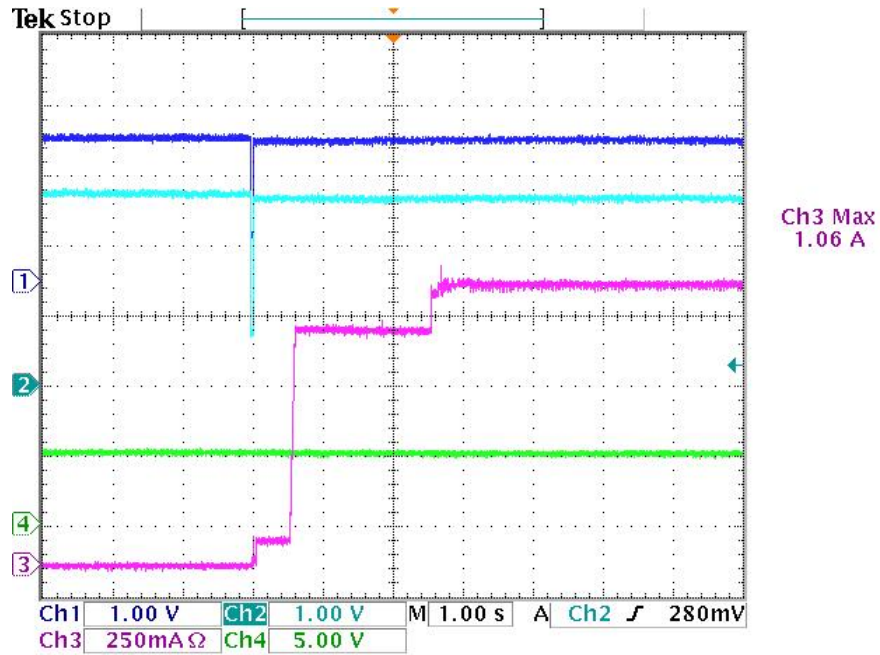

CH1: D+, CH2: D-, CH3: I_{OUT}, CH4: V_{OUT}

Figure 7. TPS25810 and TPS2544 (DCP Auto Mode) Test With iPhone6, With Type C-to-B Dongle Connected TO Host Then Plug In Device

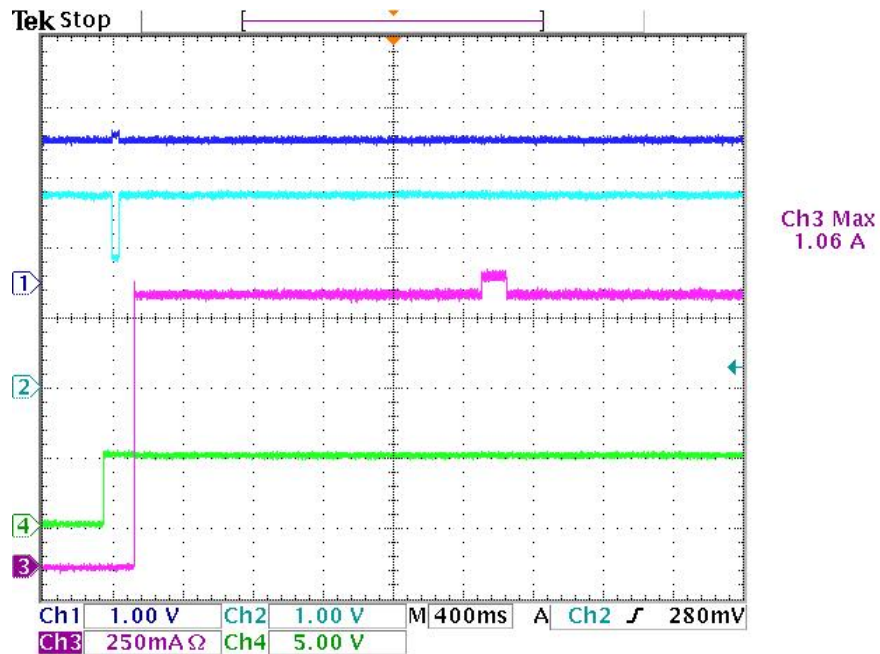

CH1: D+, CH2: D-, CH3: I_{OUT}, CH4: V_{OUT}

Figure 8. TPS25810 and TPS2544 (DCP Auto Mode) Test With Galaxy S6, With Type C-to-B Dongle Connected TO Device Then Plug In Host

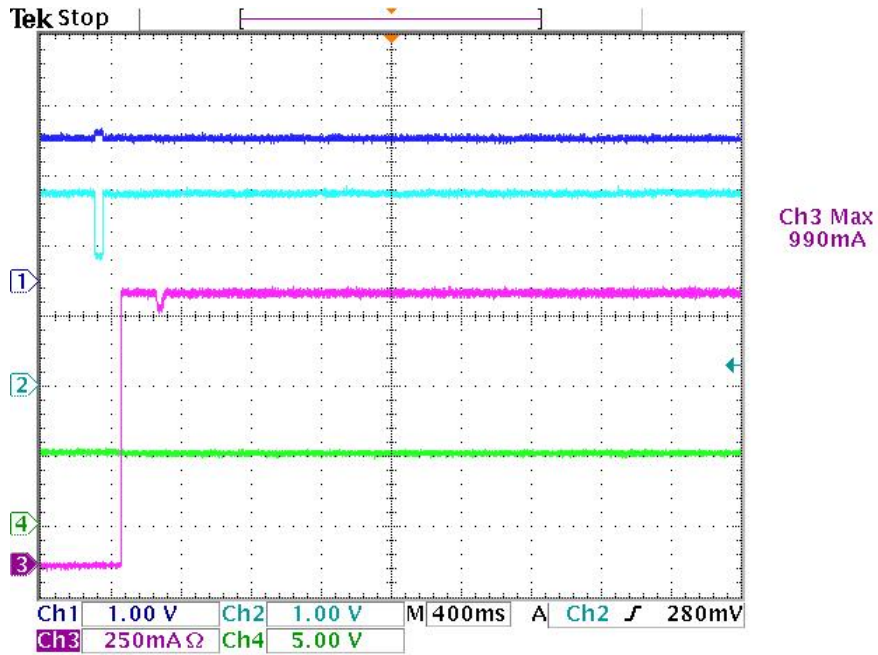

CH1: D+, CH2: D-, CH3: I_{OUT}, CH4: V_{OUT}
Figure 9. TPS25810 and TPS2544 (DCP Auto Mode) Test With Galaxy S6, With Type C-to-B Dongle Connected to Host Then Plug In Device

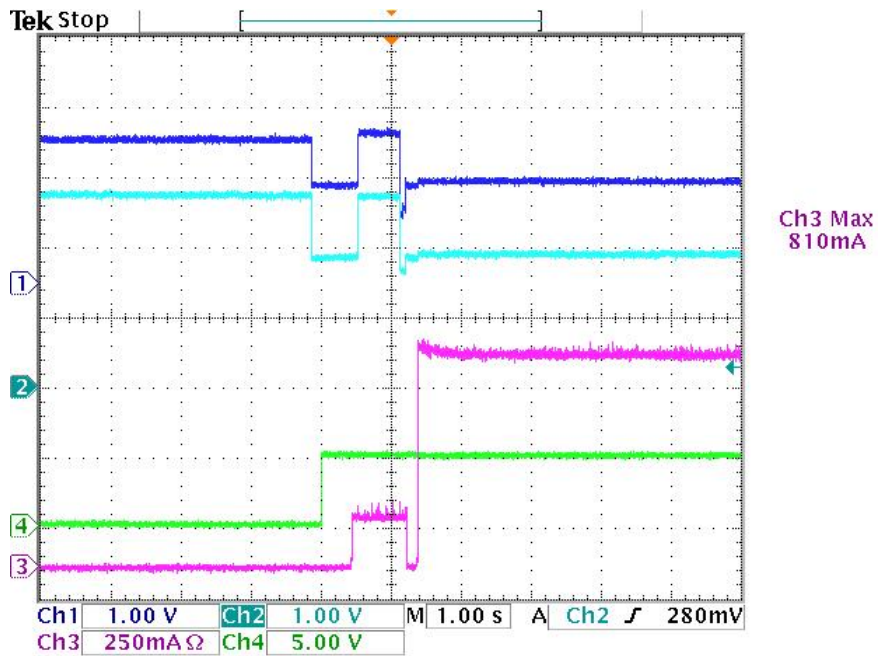

CH1: D+, CH2: D-, CH3: I_{OUT}, CH4: V_{OUT}
Figure 10. TPS25810 and TPS2544 (DCP Auto Mode) Test With HTC Sense, With Type C-to-B Dongle Connected to Device Then Plug In Host

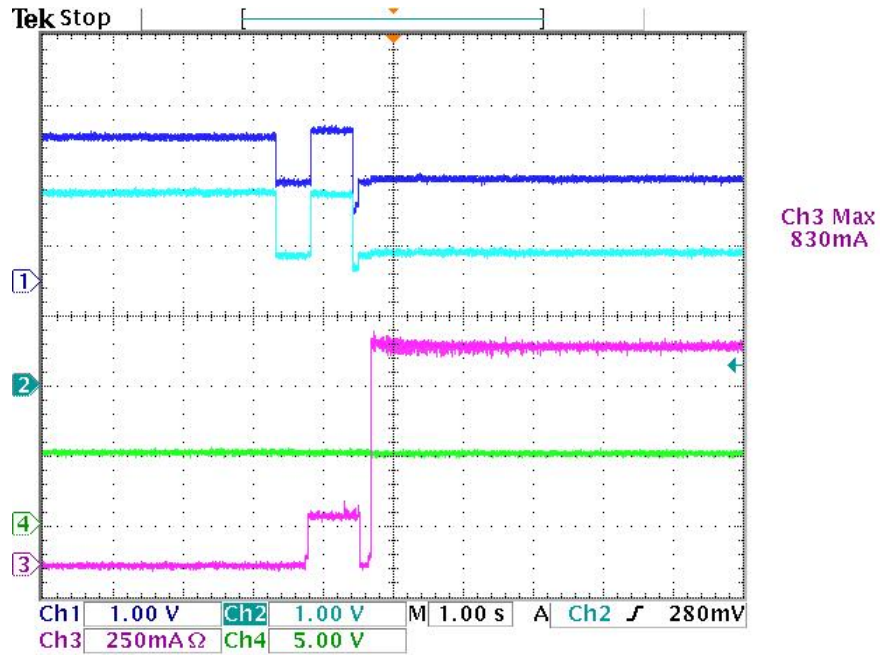

CH1: D+, CH2: D-, CH3: I_{OUT}, CH4: V_{OUT}

Figure 11. TPS25810 and TPS2544 (DCP Auto Mode) Test With HTC Sense, With Type C-to-B Dongle Connected to Host Then Plug In Device

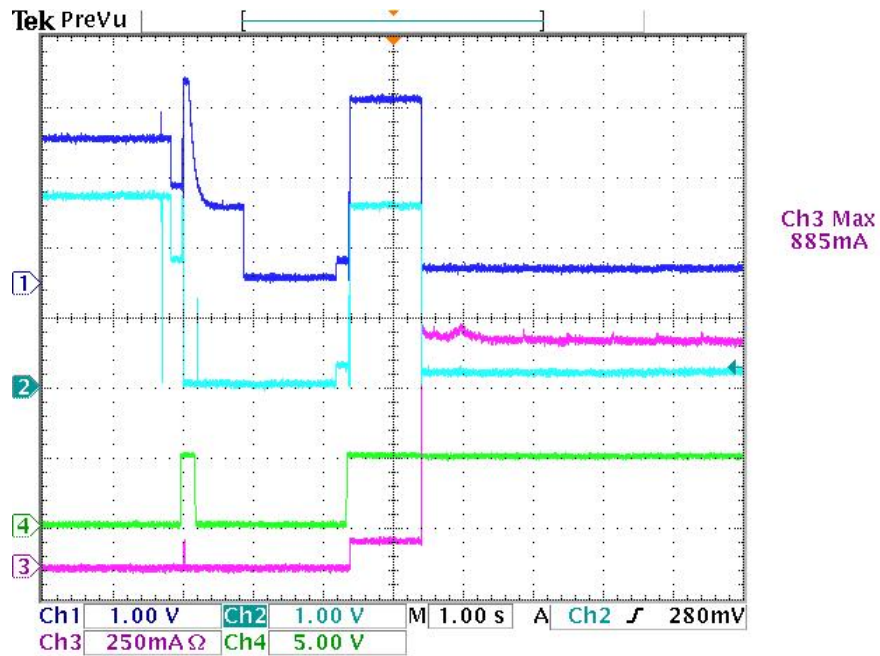

CH1: D+, CH2: D-, CH3: I_{OUT}, CH4: V_{OUT}

Figure 12. TPS25810 and TPS2544 (DCP Auto Mode) Test With Bold 9000, With Type C-to-B Dongle Connected to Device Then Plug In Host

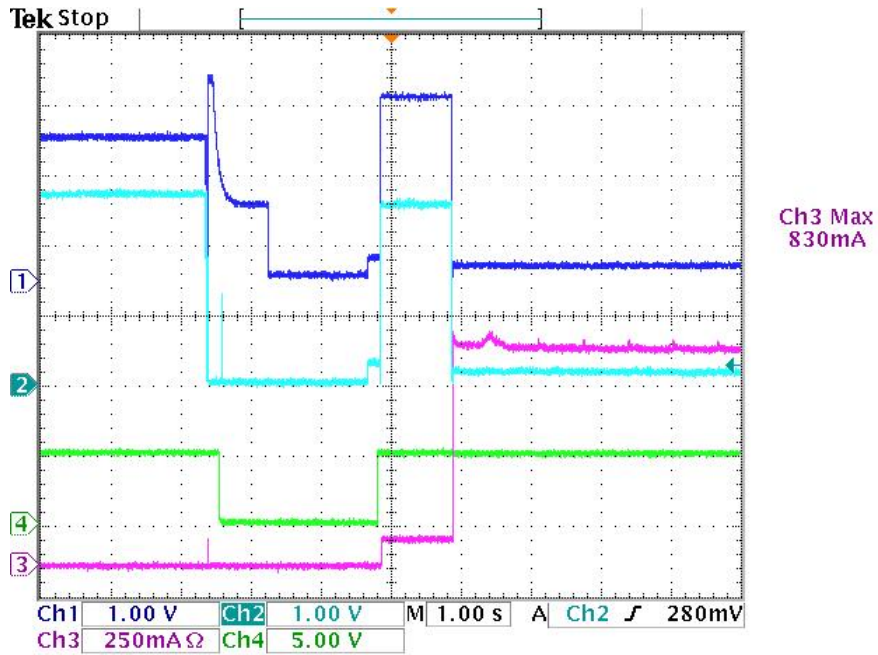

CH1: D+, CH2: D-, CH3: I_{OUT} , CH4: V_{OUT}

Figure 13. TPS25810 and TPS2544 (DCP Auto Mode) Test With Bold 9000, With Type C-to-B Dongle Connected to Host Then Plug In Device

4 Summary

The results are summarized in [Table 1](#) for each device, listing the maximum current drawn from each device. It is seen that by adding the TPS2544 to the TPS25810, large charging currents can be achieved on the USB Type-C port.

Table 1. Maximum Current

Mode	Samsung Galaxy S6	Apple iPhone6	HTC Sense	Blackberry Bold 9000
CDP	1.06 A	1.43 A	NA	NA
DCP Auto	1.06 A	1.06 A	0.83 A	0.88 A

5 References

- *TPS25810 USB Type-C DFP Controller and Power Switch with Load Detection* ([SLVSCR1](#))
- *TPD1S414 USB Charger OVP Switch with ESD for V_{BUS_CON} Pin* ([SLLSEH9](#))
- *USB Type-C Documentation*, <http://www.usb.org/developers/usbtpec/>

IMPORTANT NOTICE

Texas Instruments Incorporated and its subsidiaries (TI) reserve the right to make corrections, enhancements, improvements and other changes to its semiconductor products and services per JESD46, latest issue, and to discontinue any product or service per JESD48, latest issue. Buyers should obtain the latest relevant information before placing orders and should verify that such information is current and complete. All semiconductor products (also referred to herein as "components") are sold subject to TI's terms and conditions of sale supplied at the time of order acknowledgment.

TI warrants performance of its components to the specifications applicable at the time of sale, in accordance with the warranty in TI's terms and conditions of sale of semiconductor products. Testing and other quality control techniques are used to the extent TI deems necessary to support this warranty. Except where mandated by applicable law, testing of all parameters of each component is not necessarily performed.

TI assumes no liability for applications assistance or the design of Buyers' products. Buyers are responsible for their products and applications using TI components. To minimize the risks associated with Buyers' products and applications, Buyers should provide adequate design and operating safeguards.

TI does not warrant or represent that any license, either express or implied, is granted under any patent right, copyright, mask work right, or other intellectual property right relating to any combination, machine, or process in which TI components or services are used. Information published by TI regarding third-party products or services does not constitute a license to use such products or services or a warranty or endorsement thereof. Use of such information may require a license from a third party under the patents or other intellectual property of the third party, or a license from TI under the patents or other intellectual property of TI.

Reproduction of significant portions of TI information in TI data books or data sheets is permissible only if reproduction is without alteration and is accompanied by all associated warranties, conditions, limitations, and notices. TI is not responsible or liable for such altered documentation. Information of third parties may be subject to additional restrictions.

Resale of TI components or services with statements different from or beyond the parameters stated by TI for that component or service voids all express and any implied warranties for the associated TI component or service and is an unfair and deceptive business practice. TI is not responsible or liable for any such statements.

Buyer acknowledges and agrees that it is solely responsible for compliance with all legal, regulatory and safety-related requirements concerning its products, and any use of TI components in its applications, notwithstanding any applications-related information or support that may be provided by TI. Buyer represents and agrees that it has all the necessary expertise to create and implement safeguards which anticipate dangerous consequences of failures, monitor failures and their consequences, lessen the likelihood of failures that might cause harm and take appropriate remedial actions. Buyer will fully indemnify TI and its representatives against any damages arising out of the use of any TI components in safety-critical applications.

In some cases, TI components may be promoted specifically to facilitate safety-related applications. With such components, TI's goal is to help enable customers to design and create their own end-product solutions that meet applicable functional safety standards and requirements. Nonetheless, such components are subject to these terms.

No TI components are authorized for use in FDA Class III (or similar life-critical medical equipment) unless authorized officers of the parties have executed a special agreement specifically governing such use.

Only those TI components which TI has specifically designated as military grade or "enhanced plastic" are designed and intended for use in military/aerospace applications or environments. Buyer acknowledges and agrees that any military or aerospace use of TI components which have **not** been so designated is solely at the Buyer's risk, and that Buyer is solely responsible for compliance with all legal and regulatory requirements in connection with such use.

TI has specifically designated certain components as meeting ISO/TS16949 requirements, mainly for automotive use. In any case of use of non-designated products, TI will not be responsible for any failure to meet ISO/TS16949.

Products

Audio	www.ti.com/audio
Amplifiers	amplifier.ti.com
Data Converters	dataconverter.ti.com
DLP® Products	www.dlp.com
DSP	dsp.ti.com
Clocks and Timers	www.ti.com/clocks
Interface	interface.ti.com
Logic	logic.ti.com
Power Mgmt	power.ti.com
Microcontrollers	microcontroller.ti.com
RFID	www.ti-rfid.com
OMAP Applications Processors	www.ti.com/omap
Wireless Connectivity	www.ti.com/wirelessconnectivity

Applications

Automotive and Transportation	www.ti.com/automotive
Communications and Telecom	www.ti.com/communications
Computers and Peripherals	www.ti.com/computers
Consumer Electronics	www.ti.com/consumer-apps
Energy and Lighting	www.ti.com/energy
Industrial	www.ti.com/industrial
Medical	www.ti.com/medical
Security	www.ti.com/security
Space, Avionics and Defense	www.ti.com/space-avionics-defense
Video and Imaging	www.ti.com/video

TI E2E Community

e2e.ti.com