

Optimizing the Radiated EMI of TPS61178EVM

JasperLi

ABSTRACT

EMI is a common issue in a switching power converter because of the high di/dt and dv/dt during the MOSFETs switching on/off. Proper measures can solve the EMI issue without deteriorating the performance of the converter or increasing the cost. This application report introduces some simple methods to reduce the radiated EMI in the TPS61178 evaluation board (TPS61178EVM).

Contents

1	Introduction	1
2	Measurement and Optimization	2
3	Conclusion	5
4	References	5

List of Figures

1	TPS61178EVM Radiated Noise	2
2	Simplified Boost Converter and Operating Waveform	2
3	SW Waveform at $V_{IN} = 7.8\text{ V}$, $V_{OUT} = 16\text{ V}$, $I_{OUT} = 2\text{ A}$	3
4	SW Waveform With 820 pF	3
5	SW Waveform With RC Snubber	4
6	Radiated Noise With the RC Snubber	4
7	Characteristic of BLM18SG121TN1	4
8	Radiated Noise With Bead and RC Snubber	5

List of Tables

Trademarks

All trademarks are the property of their respective owners.

1 Introduction

The TPS61178x is a 20-V synchronous boost converter with the gate driver built-in for load disconnection. The TPS61178x integrates two 16-m Ω on-resistance power FETs and uses fixed-frequency peak-current mode control. These features make it suitable in the application of a Bluetooth speaker, motor driver, LCD display, and so forth. EMI is a concern for these application fields because the output power is higher than 30 W. Good PCB layout is the easiest and most effective method to reduce EMI noise⁽¹⁾. It is also critical for the normal operation of the TPS61178x. Decreasing the ringing in the switching node and increasing impedance of the noisy loop will further reduce the EMI noise. This application report first measures the radiated EMI noise of the TPS61178 evaluation board (TPS61178EVM), then optimizes the EMI using RC snubber and ferrite bead.

2 Measurement and Optimization

The radiated EMI noise of the TPS61178EVM in a 3-meter chamber is shown in [Figure 1](#) (test condition: 7.8-V input voltage, 16-V output voltage, and 2-A output current). [Figure 1](#) details peak noise level in both the horizontal and vertical direction. The red line is the EN55022 and CISPR22 Class B limitation. The noise is much larger in the horizontal direction, but can still pass the Class B limitation. The test result shows that the strongest noise lies in the bandwidth between 150 MHz and 400 MHz.

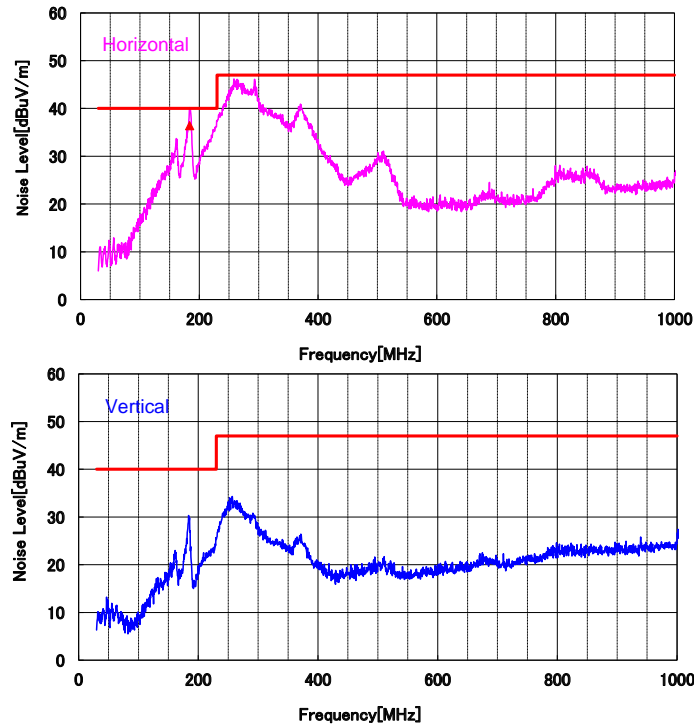

Figure 1. TPS61178EVM Radiated Noise

[Figure 2](#) shows the simplified schematic of a boost converter and the operating waveform. The main noise sources of the boost are the square-wave voltage in SW node and current flowing through the rectifier diode. Because of the parasitic inductors and capacitor (L_{pm} , L_{po} , L_{ps} , C_{ps}), the voltage in SW pin rings after the MOSFET switches on or off, and the high-frequency current flows into the cable between the output capacitor and the load. These two issues also contribute to the EMI noise.

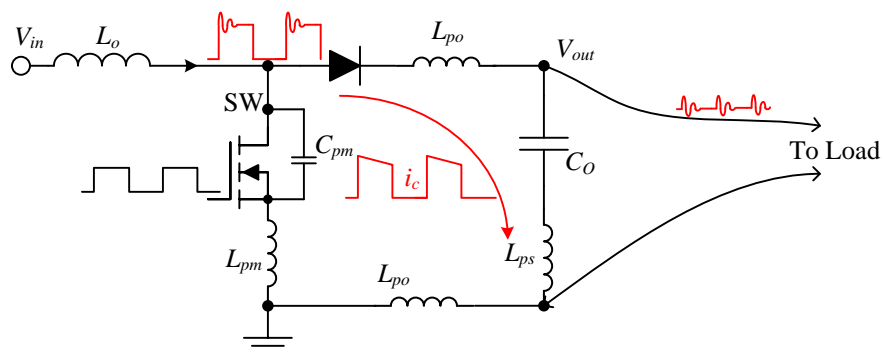

Figure 2. Simplified Boost Converter and Operating Waveform

Good PCB layout following the instruction in [Five Steps to a Good PCB Layout of a Boost Converter Application Report](#), can minimize the parasitic inductance, but cannot eliminate them. The SW node waveform of the TPS61178EVM is shown in [Figure 3](#). The ringing frequency in SW node is 294 MHz, which could be the root cause that the radiated noise is high in this frequency.

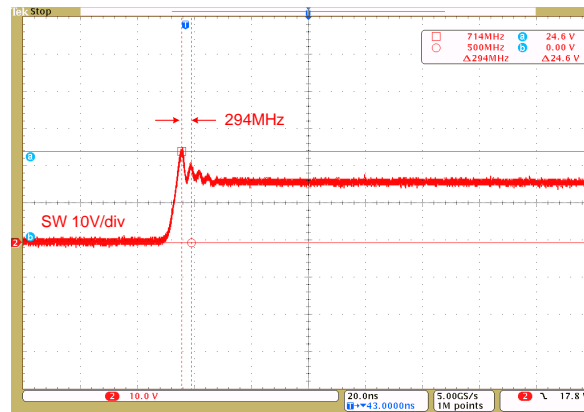

Figure 3. SW Waveform at $V_{IN} = 7.8\text{ V}$, $V_{OUT} = 16\text{ V}$, $I_{OUT} = 2\text{ A}$

RC snubber is a simple solution to eliminate the ringing. The method to select RC snubber value is introduced in [Minimizing Ringing at the Switch Node of a Boost Converter Application Report](#).

- Place a capacitor at SW node to reduce the ringing frequency to less than half of original frequency
- Calculate the parasitic inductor and capacitor
- Calculate the resistor value of the RC snubber

Placing a 820-pF capacitor between SW to ground, the SW waveform is shown in [Figure 4](#). The switching frequency reduces to 122 MHz. Thus, the parasitic capacitor can be calculated in [Equation 1](#)

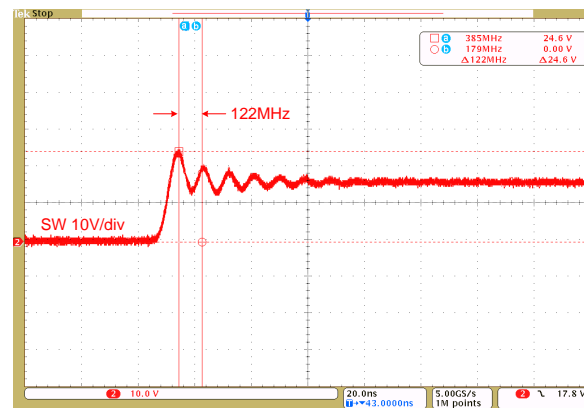

Figure 4. SW Waveform With 820 pF

$$C_p = 820\text{ pF} \times \frac{1}{\left(\frac{294\text{ MHz}}{122\text{ MHz}}\right)^2 - 1} = 170\text{ pF} \tag{1}$$

Calculate the parasitic inductor using [Equation 2](#):

$$L_p = \frac{1}{(2\pi)^2 \times 170\text{ pF} \times (294\text{ MHz})^2} = 1.7\text{ nH} \tag{2}$$

The snubber resistor is selected to avoid ringing using [Equation 3](#).

$$R_{\text{snubber}} = 2 \sqrt{\frac{1.7\text{ nH}}{820\text{ pF} + 170\text{ pF}}} = 2.6\ \Omega \tag{3}$$

Selecting a 2.5-Ω snubber resistor, the SW waveform is shown in [Figure 5](#). The ring in SW pin is eliminated by the snubber circuit.

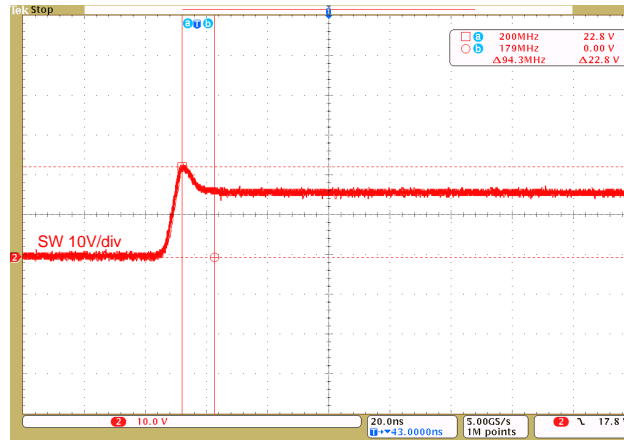

Figure 5. SW Waveform With RC Snubber

After adding the snubber circuit, the horizontal radiated noise is shown in Figure 6 (test condition: 7.8-V input voltage, 16-V output voltage, and 2-A output current). The noise between 150 MHz and 400 MHz greatly decreases, which proves the usefulness of the snubber circuit.

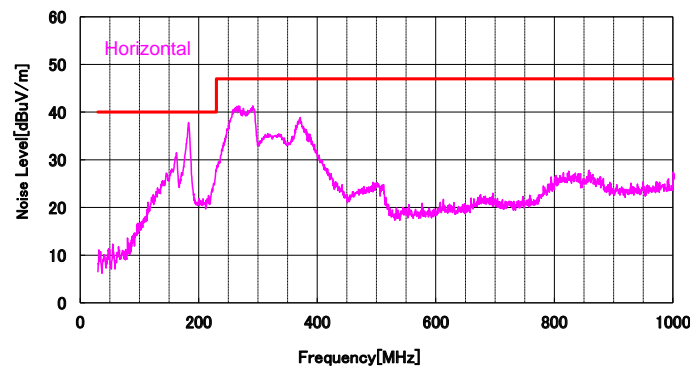

Figure 6. Radiated Noise With the RC Snubber

As shown in Figure 2, the high frequency current will flow through the cable between the converter output and the load which generates radiated noise. A ferrite bead can increase the high-frequency impedance to prevent this phenomenon. Considering the output current and radiated noise frequency, BLM18SG121TN1 is selected, which supports a 3-A DC current and has large impedance in the frequency from 150 MHz to 400 MHz as in Figure 7.

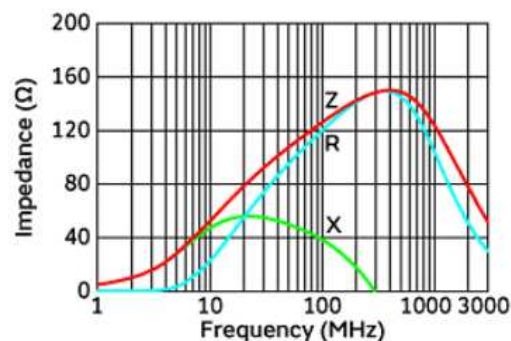

Figure 7. Characteristic of BLM18SG121TN1

To easily place the bead into the TPS61178EVM, remove the Q1 in the TPS61178EVM and replace it with the BLM18SG121TN1. The EMI test result with bead and RC snubber is shown in [Figure 8](#) (test condition: 7.8-V input voltage, 16-V output voltage, and 2-A output current). The noise level is greatly reduced by the bead.

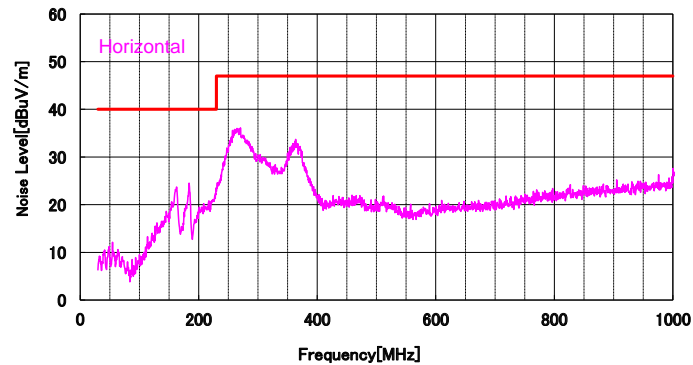

Figure 8. Radiated Noise With Bead and RC Snubber

3 Conclusion

This application report first measures the radiated EMI of the TPS61178EVM in a 3-m chamber. The test result passes the EN55022 and CISPR22 Class B limitation with a small margin. By analyzing the noise source and path, the RC snubber and bead are added to reduce the noise. Test results validate the effectiveness of the two methods.

4 References

1. Texas Instruments, [Reducing Radiated EMI in TPS61088 Boost Converter Application Report](#)
2. Texas Instruments, [Five Steps to a Good PCB Layout of a Boost Converter Application Report](#)
3. Texas Instruments, [Minimizing Ringing at the Switch Node of a Boost Converter Application Report](#)

IMPORTANT NOTICE FOR TI DESIGN INFORMATION AND RESOURCES

Texas Instruments Incorporated ("TI") technical, application or other design advice, services or information, including, but not limited to, reference designs and materials relating to evaluation modules, (collectively, "TI Resources") are intended to assist designers who are developing applications that incorporate TI products; by downloading, accessing or using any particular TI Resource in any way, you (individually or, if you are acting on behalf of a company, your company) agree to use it solely for this purpose and subject to the terms of this Notice.

TI's provision of TI Resources does not expand or otherwise alter TI's applicable published warranties or warranty disclaimers for TI products, and no additional obligations or liabilities arise from TI providing such TI Resources. TI reserves the right to make corrections, enhancements, improvements and other changes to its TI Resources.

You understand and agree that you remain responsible for using your independent analysis, evaluation and judgment in designing your applications and that you have full and exclusive responsibility to assure the safety of your applications and compliance of your applications (and of all TI products used in or for your applications) with all applicable regulations, laws and other applicable requirements. You represent that, with respect to your applications, you have all the necessary expertise to create and implement safeguards that (1) anticipate dangerous consequences of failures, (2) monitor failures and their consequences, and (3) lessen the likelihood of failures that might cause harm and take appropriate actions. You agree that prior to using or distributing any applications that include TI products, you will thoroughly test such applications and the functionality of such TI products as used in such applications. TI has not conducted any testing other than that specifically described in the published documentation for a particular TI Resource.

You are authorized to use, copy and modify any individual TI Resource only in connection with the development of applications that include the TI product(s) identified in such TI Resource. NO OTHER LICENSE, EXPRESS OR IMPLIED, BY ESTOPPEL OR OTHERWISE TO ANY OTHER TI INTELLECTUAL PROPERTY RIGHT, AND NO LICENSE TO ANY TECHNOLOGY OR INTELLECTUAL PROPERTY RIGHT OF TI OR ANY THIRD PARTY IS GRANTED HEREIN, including but not limited to any patent right, copyright, mask work right, or other intellectual property right relating to any combination, machine, or process in which TI products or services are used. Information regarding or referencing third-party products or services does not constitute a license to use such products or services, or a warranty or endorsement thereof. Use of TI Resources may require a license from a third party under the patents or other intellectual property of the third party, or a license from TI under the patents or other intellectual property of TI.

TI RESOURCES ARE PROVIDED "AS IS" AND WITH ALL FAULTS. TI DISCLAIMS ALL OTHER WARRANTIES OR REPRESENTATIONS, EXPRESS OR IMPLIED, REGARDING TI RESOURCES OR USE THEREOF, INCLUDING BUT NOT LIMITED TO ACCURACY OR COMPLETENESS, TITLE, ANY EPIDEMIC FAILURE WARRANTY AND ANY IMPLIED WARRANTIES OF MERCHANTABILITY, FITNESS FOR A PARTICULAR PURPOSE, AND NON-INFRINGEMENT OF ANY THIRD PARTY INTELLECTUAL PROPERTY RIGHTS.

TI SHALL NOT BE LIABLE FOR AND SHALL NOT DEFEND OR INDEMNIFY YOU AGAINST ANY CLAIM, INCLUDING BUT NOT LIMITED TO ANY INFRINGEMENT CLAIM THAT RELATES TO OR IS BASED ON ANY COMBINATION OF PRODUCTS EVEN IF DESCRIBED IN TI RESOURCES OR OTHERWISE. IN NO EVENT SHALL TI BE LIABLE FOR ANY ACTUAL, DIRECT, SPECIAL, COLLATERAL, INDIRECT, PUNITIVE, INCIDENTAL, CONSEQUENTIAL OR EXEMPLARY DAMAGES IN CONNECTION WITH OR ARISING OUT OF TI RESOURCES OR USE THEREOF, AND REGARDLESS OF WHETHER TI HAS BEEN ADVISED OF THE POSSIBILITY OF SUCH DAMAGES.

You agree to fully indemnify TI and its representatives against any damages, costs, losses, and/or liabilities arising out of your non-compliance with the terms and provisions of this Notice.

This Notice applies to TI Resources. Additional terms apply to the use and purchase of certain types of materials, TI products and services. These include; without limitation, TI's standard terms for semiconductor products (<http://www.ti.com/sc/docs/stdterms.htm>), [evaluation modules](#), and [samples](http://www.ti.com/sc/docs/sampterm.htm) (<http://www.ti.com/sc/docs/sampterm.htm>).

Mailing Address: Texas Instruments, Post Office Box 655303, Dallas, Texas 75265
Copyright © 2018, Texas Instruments Incorporated