



ABSTRACT

In some battery-powered applications that have metal contacts exposed, the short-circuit protection (SCP) function is critical to protection of the whole system from moisture invasion or short-circuit accident. Most low input-voltage boost converters (input voltage is limited to less than 5.5 V) integrates the short-circuit protection function have to use two high side MOSFET with a back-to-back body diode connection or use new MOSFET, which can switch the body direction with additional masks. Either way increase the device cost.

In this application, a simple circuit is demonstrated which achieves the short circuit protection by adding some external components. This works for any low voltage boost converters without short circuit protection function. The TI's new TPS613222A low quiescent current synchronous boost converter is used as the example.

Table of Contents

1 Device Overview	2
2 Short Circuit Protection Implementation	3
3 External Components Considerations	5
4 Multiple Implementation of Short-Circuit Protection	6
5 Summary	6
6 References	6
7 Revision History	6

List of Figures

Figure 2-1. Typical Application.....	3
Figure 2-2. $R_2 = 100 \Omega$	4
Figure 2-3. $R_2 = 1000 \Omega$	4
Figure 2-4. $R_2 = 10000 \Omega$	4
Figure 2-5. $R_2 = 100000 \Omega$	4
Figure 3-1. MMBT3904 I-V Curve See References no. 2	5
Figure 4-1. N-Type Implementation Without R_{sense}	6
Figure 4-2. N-Type Implementation With R_{sense}	6
Figure 4-3. P-Type Implementation Without R_{sense}	6
Figure 4-4. P-Type Implementation With R_{sense}	6

Trademarks

All trademarks are the property of their respective owners.

1 Device Overview

TPS613222A [See References no. 1](#) is a very compact boost converter with only 3 active pins. Only two external components (one inductor and one output capacitor) are needed when designing a 5-V fixed output power rail. The quiescent is 6.5 μ A typically and the total power loss is very small even though the boost converter is always in active state. This part reduces the system cost significantly and makes the system design quite simple. But it has no short circuit protection.

TPS613222A is a hysteretic current control boost converter. There is a current comparator inside turns on and off the power MOSFETs. During the off-phase, the high-side MOSFET is on and the low side MOSFET is off. As the output voltage is higher than the input voltage, the inductor current ramps down. When the inductor current triggers the target value set by the output of the error amplifier, the high-side MOSFET is turned off and the low-side MOSFET is turned on (dead time control is integrated). Then the inductor current starts ramping up. When the inductor current ramps up to the target value set by the hysteretic current comparator, the low-side MOSFET is turned off and high-side MOSFET is turned on again. The TPS613222A operates in this behavior back and forth. If the output load goes beyond the TPS613222A's capability, the peak switch current will be limited to 1.8A typically and the output voltage starts to drop. When the output voltage drops to the input voltage level, the inductor current is no longer controllable because even in off-phase, the inductor current ramps up not down and the boost converter may be damaged.

2 Short Circuit Protection Implementation

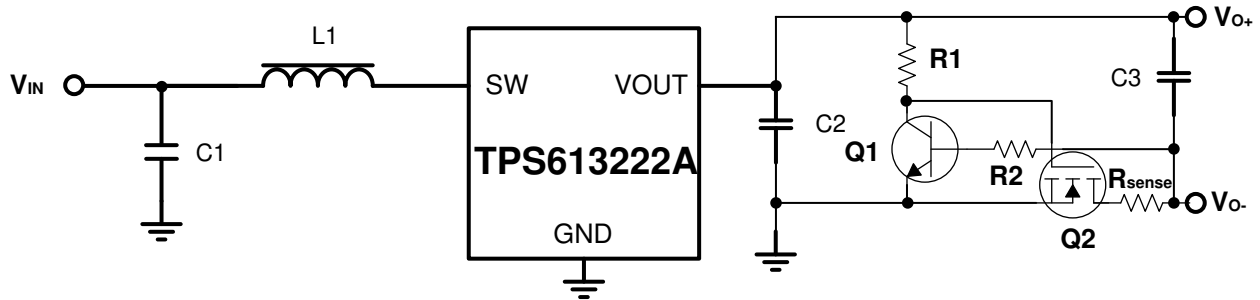

Figure 2-1. Typical Application

The technique used in this application note to achieve the short circuit protection adds two general purpose active switches and some passive components as shown in [Figure 2-1](#). The resistor R_{sense} together with the $R_{ds,on}$ of the Q2 monitors the output current of the sub-system. The V_{o-} voltage is fed to the base of the NPN signal switch Q1. The Q1 is general purpose bipolar switch, for example, MMBT3904. When the V_{o-} ramps to the V_{be} threshold of the Q1, which is 0.6 V typically, the collector current of Q1 increases significantly and pull the V_{gs} voltage of Q2 lower than the gate threshold voltage V_{th} . In this way, the current path is cut off immediately and both the power system and the sub-system is protected.

The short circuit current threshold I_{LIMIT} is set by the [Equation 1](#):

$$I_{LIMIT} = \frac{V_{be}}{R_{sense} + R_{ds,on}} \quad (1)$$

where

- R_{sense} is the resistance of the sense resistor
- $R_{ds,on}$ is the on-resistance of Q2
- V_{be} is the open threshold of the bipolar switch Q1

When the short circuit condition is removed, the V_{o-} voltage is pulled to GND slowly by the base-to-emitter current I_{be} of the Q1. The recovery time is related to the output capacitor C3, and the leakage current set by [Equation 2](#):

$$I_{LEAK} = \frac{5 - V_{be}}{R_2} \quad T_{recovery} = \frac{C_3 * V_{o-}}{I_{leak}} \quad (2)$$

where

- $T_{recovery}$ is the recovery time when an short-circuit accident is removed and the output voltage recovers to 5 V. (V_{o-} ramps down to 0 V).
- I_{leak} is the leakage current into the base of the Q1 switch, in other words I_{be} .
- C_3 is the output capacitance.
- V_{o-} is the voltage at the negative input side of the sub-system.

For example, the R_2 is 1000 Ω , and the output capacitor is 4.7 μ F. The I_{leak} is 4.4 mA, maximum. A simple 2.2-mA average leakage current can be used in the calculation. Then the recovery time is longer than 10 ms.

To accelerate the response time when SCP happens (or recovery time from SCP to normal mode), the resistor of R2 with smaller resistance can be used. The leakage current is inversely proportional to the R2 resistance according to the equation below. The recommended value for this resistor is between 100 Ω to 100 K Ω . It is a tradeoff between the recovery time/response time and the leakage current.

The following figures show the response time when a fast short-circuit accident happens. The R_{sense} is set to 0.5Ω to get a 1.1-A target short-circuit current threshold. The actual trigger point is 1.1 A when the R_2 is 100Ω while the trigger point shifts to higher than 2 A when the R_2 is higher than $10 \text{ k}\Omega$.

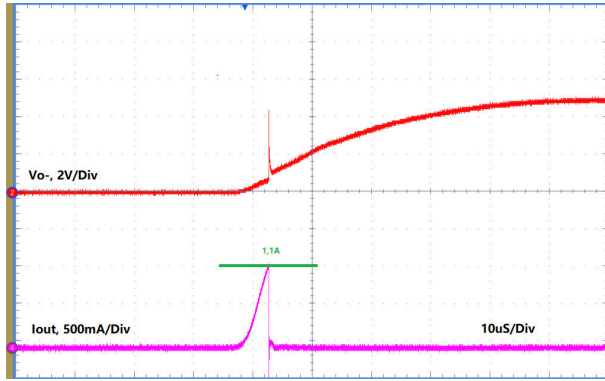

Figure 2-2. $R_2 = 100 \Omega$

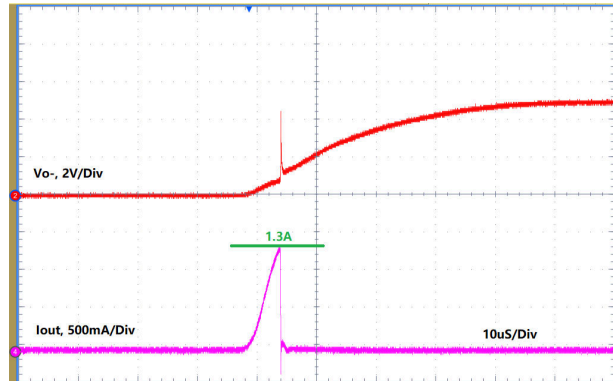

Figure 2-3. $R_2 = 1000 \Omega$

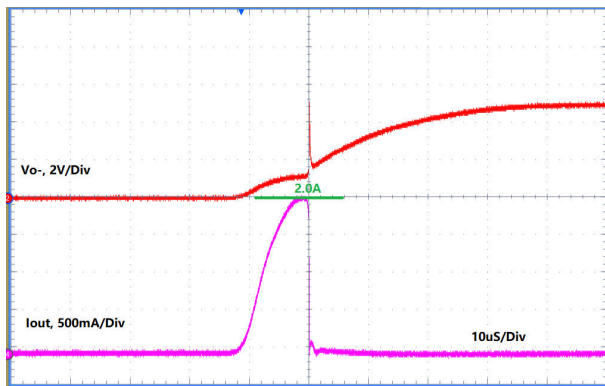

Figure 2-4. $R_2 = 10000 \Omega$

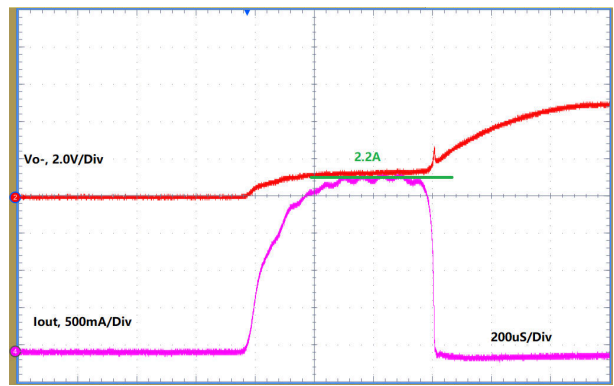

Figure 2-5. $R_2 = 100000 \Omega$

3 External Components Considerations

The following explains how to select external components in such applications is another important topic. Especially the two external active switches.

3.1 Power Switch Q2

Pay attentions to the following requirements:

- The maximum V_{ds} voltage of the switch must be higher than the TPS613222A output voltage.
- If no R_{sense} , the $R_{ds,on}$ should also be balanced with the total solution efficiency, 3% is good tradeoff under the maximum load for the whole system power consumption.
- The maximum V_{gs} specification should exceed the maximum output voltage of TPS613222A under the worst condition.
- The parasitic capacitance is also problem for Q2. When a short circuit accident happens, the high slew rate di/dt introduces high spike at the drain-source of Q2. The maximum spike should not exceed the maximum V limitation.

3.2 Signal Switch Q1

The switch Q1 is a general purpose NPN bipolar transistor to save cost. The V_{be} is sensitive to the temperature changes. TI recommends placing the Q1 a little away from the TPS613222A and Q2, which generates some heat during short-circuit protection. This switch can be replaced by a small signal NMOS FET.

The Q1 switch can be a NMOS FET as well. If the Q1 is NMOS, then the leakage current is negligible because of the high impedance from the gate to source. And the response time will be very short but the recovery time will be very long because of the small leakage current.

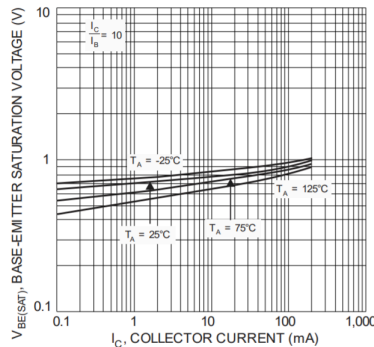

Figure 3-1. MMBT3904 I-V Curve See References no. 2

4 Multiple Implementation of Short-Circuit Protection

There are multiple implementations of short-circuit protection. The function can work with a PMOS and PNP transistor configuration as well. The N-type active switches (NMOS, NPN) are more common and often with lower cost than the P-type switches (PMOS, PNP)

The advantage of the PMOS is the ground path will not be cut down, which is very important for some ground sensitive sub-system, like sensors, ADC or DAC.

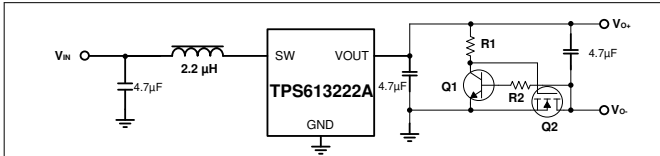

Figure 4-1. N-Type Implementation Without R_{sense}

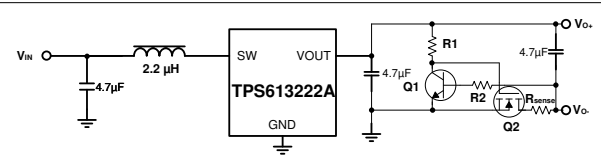

Figure 4-2. N-Type Implementation With R_{sense}

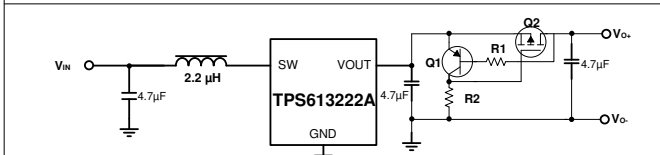

Figure 4-3. P-Type Implementation Without R_{sense}

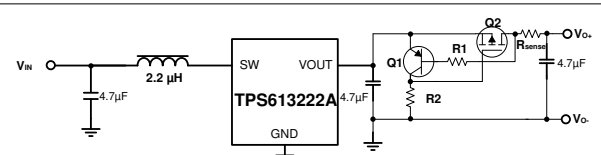

Figure 4-4. P-Type Implementation With R_{sense}

5 Summary

This design fits in the portable applications, such as the true wireless stereo (TWS). It helps reduce system cost and still keeps the whole system under short-circuit protection.

6 References

1. For more information on the low power boost converter TPS613222A, see the product folder on TI website - <http://www.ti.com/product/TPS61322>.
2. For MMBT3904 data sheet, see <https://www.diodes.com/assets/Datasheets/ds30036.pdf>

7 Revision History

NOTE: Page numbers for previous revisions may differ from page numbers in the current version.

Changes from Revision * (November 2018) to Revision A (July 2021)

Page

- Updated the numbering format for tables, figures and cross-references throughout the document.....2

IMPORTANT NOTICE AND DISCLAIMER

TI PROVIDES TECHNICAL AND RELIABILITY DATA (INCLUDING DATASHEETS), DESIGN RESOURCES (INCLUDING REFERENCE DESIGNS), APPLICATION OR OTHER DESIGN ADVICE, WEB TOOLS, SAFETY INFORMATION, AND OTHER RESOURCES "AS IS" AND WITH ALL FAULTS, AND DISCLAIMS ALL WARRANTIES, EXPRESS AND IMPLIED, INCLUDING WITHOUT LIMITATION ANY IMPLIED WARRANTIES OF MERCHANTABILITY, FITNESS FOR A PARTICULAR PURPOSE OR NON-INFRINGEMENT OF THIRD PARTY INTELLECTUAL PROPERTY RIGHTS.

These resources are intended for skilled developers designing with TI products. You are solely responsible for (1) selecting the appropriate TI products for your application, (2) designing, validating and testing your application, and (3) ensuring your application meets applicable standards, and any other safety, security, or other requirements. These resources are subject to change without notice. TI grants you permission to use these resources only for development of an application that uses the TI products described in the resource. Other reproduction and display of these resources is prohibited. No license is granted to any other TI intellectual property right or to any third party intellectual property right. TI disclaims responsibility for, and you will fully indemnify TI and its representatives against, any claims, damages, costs, losses, and liabilities arising out of your use of these resources.

TI's products are provided subject to TI's Terms of Sale (<https://www.ti.com/legal/termsofsale.html>) or other applicable terms available either on [ti.com](https://www.ti.com) or provided in conjunction with such TI products. TI's provision of these resources does not expand or otherwise alter TI's applicable warranties or warranty disclaimers for TI products.

Mailing Address: Texas Instruments, Post Office Box 655303, Dallas, Texas 75265
Copyright © 2021, Texas Instruments Incorporated