

# Advantages of using PMOS-type low-dropout linear regulators in battery applications

By Brian M. King

Applications Specialist

## Introduction

The proliferation of battery-powered equipment has increased the demand for low-dropout linear regulators (LDOs). LDOs are advantageous in these applications because they offer inexpensive, reliable solutions and require few components or little board area. The circuit model for a typical LDO consists of a pass element, sampling network, voltage reference, error amplifier, and externally connected capacitors at the input and output of the device. Figure 1 shows the circuit blocks of a typical linear regulator. The pass element is arguably the most important part of the LDO in battery applications. The technology used for the pass element can increase the useful life of the battery.

The pass element can be either a bipolar transistor or a MOSFET. The general difference between these is how the pass element is driven. A bipolar pass element is a current-driven device, whereas the MOSFET is a voltage-driven device. In addition, the pass element can be either an N-type (NPN or NMOS) or a P-type (PNP or PMOS) device. N-type devices require a positive drive signal with respect to the output, while P-type devices are driven from a negative signal with respect to the input. Generating a positive drive signal becomes difficult at low input voltages. As a result, LDOs that operate from low input voltages typically are implemented with P-type devices.

When an LDO is selected for a particular application, there are several factors that must be considered. These factors include the dropout voltage ( $V_{DO}$ ), ground current, noise, input voltage, and thermal response. In low-voltage battery applications, there are two basic factors that make

Figure 1. Components of a typical linear regulator

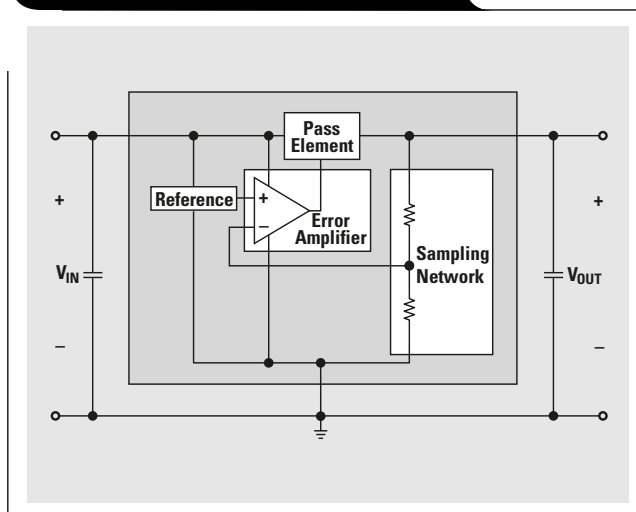

PMOS pass elements much more attractive than PNP pass elements. These two factors are the ground current and dropout voltage. The low ground current and low dropout voltage of PMOS devices can extend the useful life of a battery. Texas Instruments has a wide variety of LDOs containing PMOS pass elements.

## Dropout voltage

The *dropout voltage* is the minimum input-to-output differential voltage required to maintain output voltage regulation. In other words, the minimum allowable input voltage is equal to the sum of the output voltage and the dropout voltage.

The collector-to-emitter voltage drop ( $V_{CE}$ ) of the transistor determines the dropout voltage of an LDO that contains a PNP transistor as the pass element. The  $V_{CE}$  of any given PNP LDO is determined by the physical design of the transistor. In some PNP LDOs, the gain of the transistor is decreased to achieve a lower  $V_{CE}$ . However, decreasing the gain results in a higher base current and, consequently, a higher ground current. Thus, in order to achieve a lower dropout voltage in PNP LDOs, a higher ground current usually is compromised. The PNP collector-to-emitter voltage drop increases as the collector current increases. As a result, the dropout voltage of a PNP LDO is dependent on the load current.

As a PMOS LDO encounters a dropout condition, the PMOS pass element becomes linear. When a PMOS device is saturated, the pass element acts as a fixed, low-value resistor. This resistance is referred to as the drain-to-source

Figure 2. Comparison of typical PNP and PMOS LDO voltages

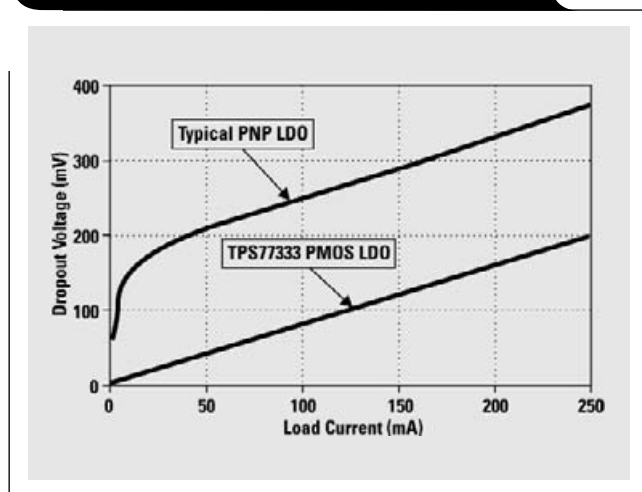

on resistance ( $R_{ds(on)}$ ). The  $R_{ds(on)}$  of a PMOS device is determined by the physical design of the MOSFET and the available gate drive. The dropout voltage for PMOS LDOs is equal to the output current times the  $R_{ds(on)}$  of the MOSFET. Thus, the dropout voltage of PMOS LDOs is also dependent on the output current.

In lower-current applications, PMOS LDOs typically have a lower  $V_{DO}$  than that of PNP LDOs. Figure 2 compares the dropout voltage of a PNP LDO with that of a PMOS LDO. The curve for the PNP LDO is typical of a fixed +3.3-V output, 250-mA device. The PMOS curve characterizes the dropout voltage of the Texas Instruments TPS77333, which also produces +3.3 V at 250 mA.

## Ground current

*Ground current* is the difference between the input and output currents and is returned to the input supply through the ground pin of the LDO. The ground current is actually the sum of all the internal bias currents of the LDO. These currents include the reference, sampling network, error amplifier, and pass-element drive currents. Figure 3 shows the locations of these currents. Since the ground current decreases the efficiency of the LDO, it is desirable to minimize this current. The current drawn by the reference, sampling network, and error amplifier is typically quite low, usually less than 100  $\mu$ A. The drive current for the pass element, however, varies substantially, depending on the type of pass element. In LDOs that contain a PNP transistor, the pass-element drive current makes up a majority of the ground current.

The *quiescent current* of an LDO is defined as the current drawn by the LDO with the output current set to zero. Some vendors, including Texas Instruments, use this term to describe the ground current. When LDO devices are compared, specific attention should be given to the terminology and test conditions used by the different vendors.

Figure 4 shows the curves for a typical PNP transistor in an LDO. The drive current for a PNP transistor is essentially equal to the base current ( $I_B$  in Figure 4), and the LDO output current is essentially equal to the collector current ( $I_C$ ). During normal operation of the LDO, the PNP transistor is operated in the active region shown in Figure 4. In this region, the drive current for a PNP is proportional to the output current by the current gain of the transistor,  $\beta$ . For an average bipolar pass-element transistor, the current gain is between 20 and 100. This means that the drive current is 20 to 100 times smaller than the required output current.

Figure 5 shows the curves for a typical PMOS transistor in an LDO. The LDO output current corresponds to the drain current ( $I_D$ ). As with a PNP LDO, a PMOS LDO operates in the active region during normal conditions. In this region, varying the gate-to-source voltage ( $V_{GS}$ ) controls the output current.

The drive current for a PMOS device is determined by the parasitic leakage of the device and is nearly unmeasurable. This results in a much lower ground current than that

Continued on next page

Figure 3. Typical LDO ground current

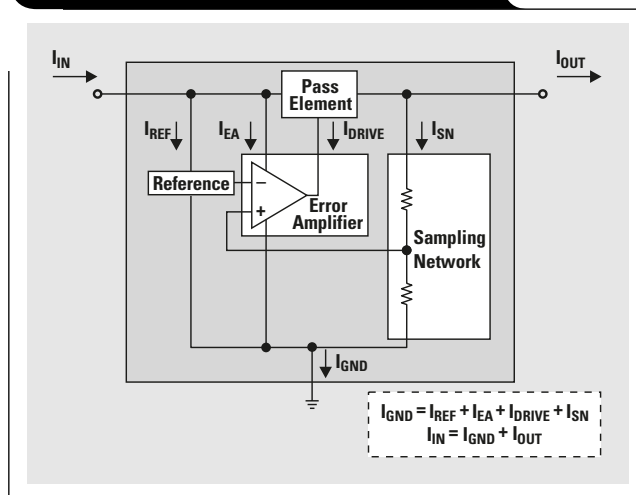

Figure 4. Typical PNP pass-element curves

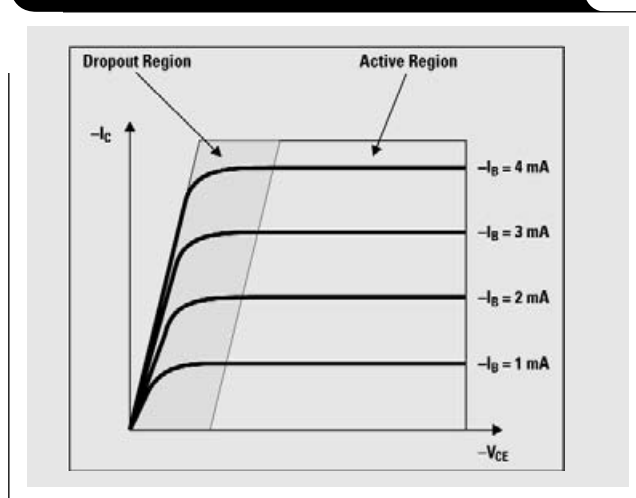
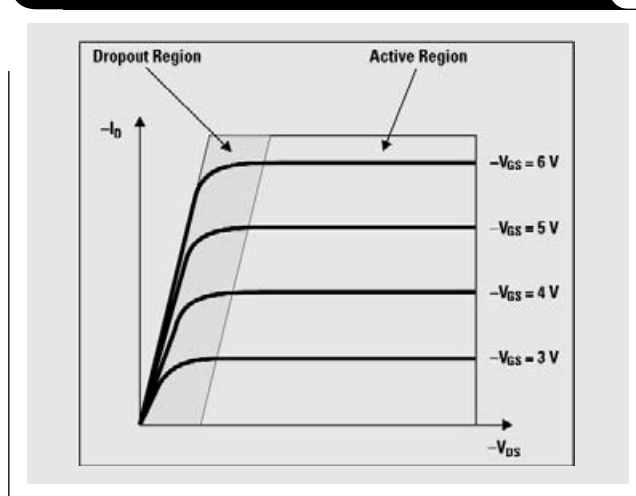

Figure 5. Typical PMOS pass-element curves



## Continued from previous page

of a PNP LDO. Figure 6 compares the ground current of a typical 3.3-V, 250-mA PNP LDO with that of the TPS77333. A 3.75-V input voltage is assumed in this figure. The dependency of the PNP ground current on the load current is evident in this plot, while the TPS77333 ground current remains constant over the entire load range.

In an LDO containing a PNP transistor, the input voltage will affect the ground current. As the voltage drop across the pass element decreases (i.e., as the input voltage approaches the output voltage), the PNP transistor will enter the dropout region shown in Figure 4. When this happens, the transistor requires more base current in order to sustain the output current; i.e., the current gain of the transistor decreases. When operated in a dropout condition, the current gain of a PNP LDO can decrease to a value of less than 1. As a result, the ground current of PNP LDOs increases when a dropout condition is encountered. By comparison, the leakage current of a PMOS device remains fairly constant as the LDO enters the dropout region.

## Noise

There are two main characteristics that are of concern when it comes to noise in LDOs. These are the internally generated noise and the power supply ripple rejection (PSRR).

Some designers avoid using a PMOS LDO under the perception that it generates more noise than a PNP LDO. In actuality, the reference and the amplifier are the primary sources of noise, not the pass element. Device manufacturers can reduce the amount of noise generated by an LDO by improving the design of the reference and amplifier.

The PSRR is a measure of how well an LDO attenuates input ripple across a band of frequencies (usually 10 Hz to 1 MHz.) The PSRR is determined by the output impedance of the pass element and the ability of the LDO amplifier to reject supply noise. PNP LDOs typically exhibit better PSRR characteristics than PMOS LDOs. However, the

**Figure 7. Battery-discharge characteristics at 100 mA**

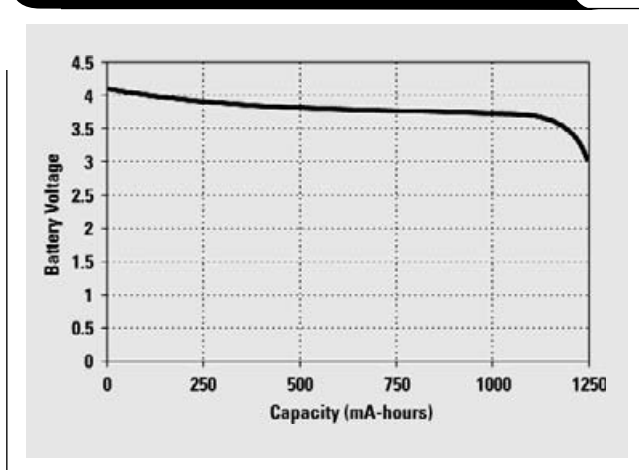

**Figure 6. Comparison of typical PNP and PMOS LDO ground currents**

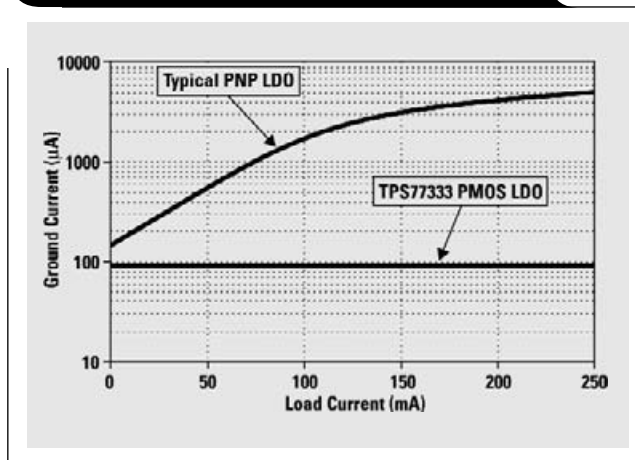

PSRR of an LDO can be improved by increasing the gain of the feedback path or decreasing the ESR of the output capacitor. Selecting an LDO with a well-designed amplifier and proper selection of the output capacitor are the keys to a good PSRR response.

## Low input voltage

As mentioned previously, a PMOS pass element is a voltage-driven device. The drive voltage for a PMOS LDO is derived from the input voltage. As a result, the maximum drive voltage is limited by the magnitude of the input voltage. All PMOS devices have a threshold voltage. When the drive voltage drops below the threshold voltage, the PMOS device turns off.

Similarly, even though a PNP transistor is a current-driven device, the emitter-to-base voltage ( $V_{EB}$ ) of a PNP pass element is derived from the input voltage. In order for a PNP pass element to conduct current, the input voltage must be greater than the  $V_{EB}$  of the transistor. However, since the transconductance of a PNP pass element is higher than that of a PMOS pass element, a PNP LDO can be designed to operate at a lower input voltage than a PMOS LDO. In applications where the input voltage may be less than 1.5 V, the use of a bipolar LDO should be considered.

## Effect on battery life

As mentioned previously, LDOs that contain PNP transistors as the pass element have a higher ground current than those that contain PMOS transistors. The input current to the LDO is equal to the sum of the ground current and output current. Over the life of a battery, the higher ground current of a PNP LDO will drain the charge more quickly than will a PMOS LDO.

Consider, for example, a 3.3-V application that draws a continuous current of 100 mA from a rechargeable lithium ion battery that has the discharge characteristics shown in Figure 7. If a PNP LDO with the ground current characteristics shown in Figure 6 were used, the ground current would be about 1.7 mA. Thus, the total input current to

the PNP LDO would be about 101.7 mA. By comparison, if a TPS77333 were used in this application, the ground current would be about 90  $\mu$ A, and the total input current would be about 100.09 mA. The discharge of the battery versus operating time for these examples is shown in Figure 8. As shown in Figure 8, the larger input current of the PNP LDO will discharge the battery faster than will the PMOS LDO.

The dropout voltage of the LDO affects how much operating time is available from the battery. As can be seen in Figure 2, the PNP LDO has a dropout voltage of about 250 mV at 100 mA, while the TPS77333 has a dropout voltage of around 80 mV at 100 mA. The LDOs encounter a dropout condition when the battery voltage decays to the output voltage (3.3 V) plus the dropout voltage of the LDO. Thus the PNP LDO starts to drop out at 3.55 V, while the PMOS LDO starts to drop out at 3.38 V. The points where the PNP LDO and TPS77333 drop out are shown in Figure 8. Because of the combined effects of the ground current and dropout voltage, the PNP LDO reaches a dropout condition after 11.6 hours, while the TPS77333 drops out after 12.2 hours. Thus, in this example, using a PMOS LDO would increase the operating time of the battery by over 5%.

### Operation in dropout

PNP-type LDOs can accelerate the decay of battery voltage at the end of battery life. Once the input voltage decreases to a dropout condition, the PNP transistor will saturate, requiring a larger amount of base current. This will increase the ground current and, in turn, increase the load demand on the battery at the end of its life. Consequently, the battery voltage will decrease more sharply after the LDO enters the dropout region. By comparison, since a PMOS transistor is voltage-driven, the drive current remains fairly constant as the battery voltage decays. This effect can become extremely important in applications where the LDO is designed to operate in the dropout region for a majority of the battery life.

### Thermal response

Another factor to consider is how the two types of LDOs respond to changes in temperature. The examples given assumed a junction temperature of 25°C. The dropout voltage of both PNP- and PMOS-type LDOs usually increases as the junction temperature increases. The  $R_{ds(on)}$  of a PMOS device is typically 1.7 times higher at 125°C than at 25°C. As a result, the dropout voltage of the TPS77333 increases by about 56 mV at 125°C. The dropout voltage of a PNP LDO at a given load current also increases proportionally to the junction temperature. From the previous example, the  $V_{DO}$  of a 3.3-V, 250-mA PNP LDO typically will be 100 mV higher at 125°C than at 25°C. At these current levels, PMOS LDOs exhibit a better dropout performance over this temperature range.

**Figure 8. Battery voltage versus operating time**

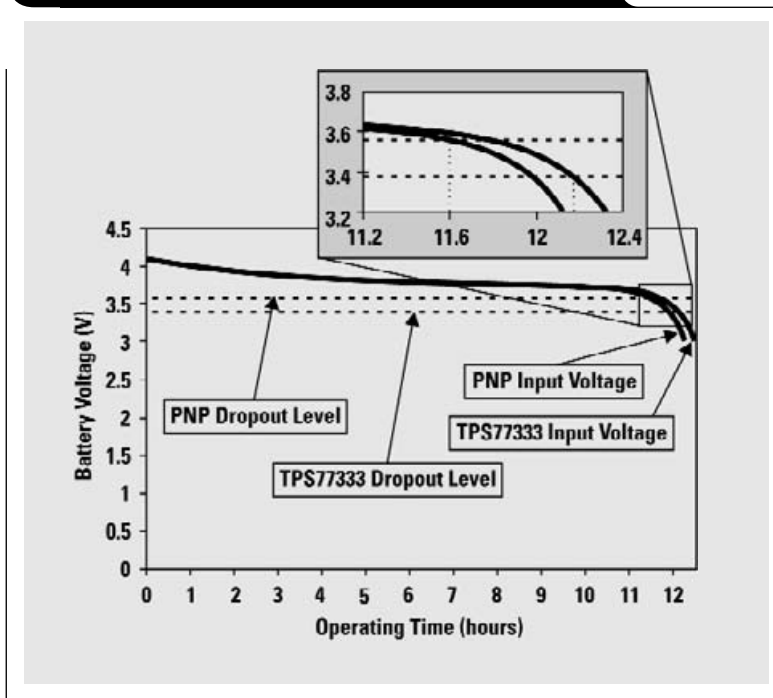

The ground currents of PMOS and PNP LDOs behave differently as the junction temperature changes. The current gain of a bipolar transistor typically increases as the junction temperature increases. As a result, the ground current of a PNP LDO may be 50% lower at 125°C than at 25°C. For the previous example, it would be reasonable to expect the ground current to be about 900  $\mu$ A at 125°C with a 100-mA load. Conversely, the ground current of a PMOS LDO usually remains fairly constant as the junction temperature changes. For example, the ground current of the TPS77333 may rise only from 90  $\mu$ A to 120  $\mu$ A at a junction temperature of 125°C. Even with an increase in junction temperature, the PMOS ground current is an order of magnitude lower than the PNP ground current.

### Summary

Because of the nature of the drive current, PMOS LDOs tend to have a significantly lower ground current than PNP LDOs. As a result, PNP LDOs tend to drain the battery voltage more quickly than PMOS LDOs. PMOS LDOs also tend to have a lower dropout voltage than most PNP LDOs. The lower dropout voltage allows the PMOS LDOs to operate from a lower input voltage, which also extends the useful life of the battery. Even over an extended temperature range, the choice of pass-element technology can impact greatly how efficiently a battery is utilized.

**Continued on next page**

Continued from previous page

### Texas Instruments LDO selection guide

TI's LDO product line contains a wide variety of MOSFET, bipolar, and dual LDOs targeted to different output voltages and load requirements. A comparison of the dropout voltages and ground currents of TI's MOSFET LDOs is shown in Table 1. All of these LDOs contain an enable pin that allows the designer to control the startup of the LDO. In addition, some TI MOSFET LDOs contain other features such as a Power Good signal and a RESET (SVS, Power On Reset) signal. The Power Good signal monitors the output voltage and can be used by the circuit designer to

generate an alarm or Power OK signal. The RESET signal incorporates a precision delay with the Power Good signal and can be used as a signal in processor applications.

Texas Instruments also offers some dual-output MOSFET LDOs, shown in Table 2. These LDOs are available in a variety of output voltage combinations. In addition, the TPS701 and TPS707 families offer a sequencing function that allows the designer to set the power-up sequence of the two outputs.

Table 3 provides a comparison of the dropout voltages and ground currents of TI's bipolar LDOs. The bipolar LDO family offers output voltages ranging from 1.5 V to 12 V, as well as some adjustable output devices.

Table 1. Texas Instruments MOSFET LDO linear regulators

PART NUMBER	OUTPUT VOLTAGE OPTIONS (V)													MAX. LOAD CURRENT (mA)	TYP. V <sub>DO</sub> (mV) AT MAX. LOAD	TYP I <sub>q</sub> (µA)	AUXILIARY FUNCTIONS			PACKAGING OPTIONS							
	-12	-5	1.224	1.25	1.5	1.6	1.8	2.5	2.7	2.8	3	3.3	3.8				4.85	5	ADJ.	ENABLE	POWER GOOD	RESET	SOT-23	SOIC	MSOP	TSSOP	PowerPAD™
TPS770xx			•		•		•	•	•	•	•				•	•	•		•								
TPS769xx			•		•		•	•	•	•	•				•	•	•		•								
TPS763xx						•	•	•	•	•	•		•		•	•	•		•								
TPS764xx								•	•	•	•				•	•	•		•								
TPS765xx					•		•	•	•	•	•				•	•	•		•			•					
TPS771xx							•	•	•	•	•				•	•	•		•			•					
TPS772xx							•	•	•	•	•				•	•	•		•			•					
TPS74xx					•		•	•			•	•			•	•	•		•			•					
UCCx86													•		•	•	•		•			•					
UCCx87														•	•	•	•		•			•					
UCCx88				•											•	•	•		•			•					
TPS72xx								•			•	•			•	•	•		•			•					
TPS766xx					•		•	•	•	•	•				•	•	•		•			•					
TPS773xx					•		•	•	•	•	•				•	•	•		•			•					
TPS774xx					•		•	•	•	•	•				•	•	•		•			•					
TPS779xx							•	•			•				•	•	•		•			•					
TPS71025								•							•	•	•		•			•					
TPS71Hxx												•			•	•	•		•			•				•	
TPS71xx												•			•	•	•		•			•				•	
TPS73xx								•			•	•			•	•	•		•			•				•	
TPS775xx					•		•	•			•				•	•	•		•			•				•	
TPS776xx					•		•	•			•				•	•	•		•			•				•	
UCCx84-x	•	•													•	•	•		•			•				•	
TPS777xx					•		•	•			•				•	•	•		•			•				•	
TPS778xx					•		•	•			•				•	•	•		•			•				•	
TPS767xx					•		•	•	•	•	•				•	•	•		•			•				•	
TPS768xx					•		•	•	•	•	•				•	•	•		•			•				•	
UCCx81-x											•				•	•	•		•			•				•	
TPS751xx					•		•	•			•				•	•	•		•			•				•	
TPS753xx					•		•	•			•				•	•	•		•			•				•	
TPS752xx					•		•	•			•				•	•	•		•			•				•	
TPS754xx					•		•	•			•				•	•	•		•			•				•	
UCCx83-x											•				•	•	•		•			•				•	•

**References**

For more information related to this article, you can download an Acrobat Reader file at [www-s.ti.com/sc/techlit/litnumber](http://www-s.ti.com/sc/techlit/litnumber) and replace "litnumber" with the **TI Lit. #** for the materials listed below.

Document Title	TI Lit. #
1. Tom Kugelstadt, "Fundamental Theory of PMOS Low-Dropout Voltage Regulators," Application Report . . . . .	.slva068
2. Bang S. Lee, "Technical Review of Low Dropout Voltage Regulator Operation and Performance," Application Report . . . . .	.slva072

3. Bang S. Lee, "Understanding the Terms and Definitions of LDO Voltage Regulators," Application Report . . . . .slva079
4. James Wong, "A Low-Noise Low Dropout Regulator for Portable Equipment," *Power Conversion and Intelligent Motion* (May 1990), pp. 38-43. —

**Related Web sites**

<http://power.ti.com>

**Table 2. Texas Instruments dual-output LDO linear regulators**

PART NUMBER	OUTPUT VOLTAGE OPTIONS (V)						MAX. LOAD CURRENT (mA)	TYP. V <sub>DO</sub> (mV) AT MAX. LOAD	TYP I <sub>q</sub> (µA) PER REGULATOR	AUXILIARY FUNCTIONS				PACKAGING OPTIONS	
	3.3 & 1.2	3.3 & 1.5	3.3 & 1.8	3.3 & 2.5	3.3 & ADJ.	ADJ. & ADJ.				ENABLE	POWER GOOD	RESET	SEQUENCING	20-PIN PowerPAD	28-PIN PowerPAD
TPS707xx	•	•	•	•		•	250/125	83	95	•	•	•	•	•	
TPS708xx	•	•	•	•		•	250/125	83	95	•	•	•		•	
TPS701xx	•	•	•	•		•	500/250	170	95	•	•	•	•	•	
TPS702xx	•	•	•	•		•	500/250	170	95	•	•			•	
TPS73HDxx			•	•	•		750/750	350	340	•		•			•
TPS767D3xx			•	•	•		1000/1000	350	85	•		•			•

**Table 3. Texas Instruments bipolar LDO linear regulators**

PART NUMBER	OUTPUT VOLTAGE OPTIONS (V)											MAX. LOAD CURRENT (mA)	TYP. V <sub>DO</sub> (mV) AT MAX. LOAD	TYP I <sub>q</sub> (mA) AT MAX. LOAD	ENABLE	PACKAGING OPTIONS					
	1.5	2.1	2.5	2.8	3	3.2	3.3	3.8	5	8	10					12	ADJ.	SOT-23	SOIC	TSSOP	PowerFLEX™
TPS760xx					•	•	•	•	•					•	•						
TPS761xx					•	•	•	•	•					•	•						
TL750Lxx									•	•	•	•								•	•
TL751Lxx									•	•	•	•									
TLV2217-33					•											•	•				•
TL750Mxx									•	•	•	•					•				•
TL751Mxx									•	•	•	•			•		•				•
TL3317			•	•					•				•				•				•
UCx82-x	•	•	•										•							•	•
UCx85-x	•	•	•										•							•	•

## IMPORTANT NOTICE

Texas Instruments Incorporated and its subsidiaries (TI) reserve the right to make corrections, modifications, enhancements, improvements, and other changes to its products and services at any time and to discontinue any product or service without notice. Customers should obtain the latest relevant information before placing orders and should verify that such information is current and complete. All products are sold subject to TI's terms and conditions of sale supplied at the time of order acknowledgment.

TI warrants performance of its hardware products to the specifications applicable at the time of sale in accordance with TI's standard warranty. Testing and other quality control techniques are used to the extent TI deems necessary to support this warranty. Except where mandated by government requirements, testing of all parameters of each product is not necessarily performed.

TI assumes no liability for applications assistance or customer product design. Customers are responsible for their products and applications using TI components. To minimize the risks associated with customer products and applications, customers should provide adequate design and operating safeguards.

TI does not warrant or represent that any license, either express or implied, is granted under any TI patent right, copyright, mask work right, or other TI intellectual property right relating to any combination, machine, or process in which TI products or services are used. Information published by TI regarding third-party products or services does not constitute a license from TI to use such products or services or a warranty or endorsement thereof. Use of such information may require a license from a third party under the patents or other intellectual property of the third party, or a license from TI under the patents or other intellectual property of TI.

Reproduction of information in TI data books or data sheets is permissible only if reproduction is without alteration and is accompanied by all associated warranties, conditions, limitations, and notices. Reproduction of this information with alteration is an unfair and deceptive business practice. TI is not responsible or liable for such altered documentation.

Resale of TI products or services with statements different from or beyond the parameters stated by TI for that product or service voids all express and any implied warranties for the associated TI product or service and is an unfair and deceptive business practice. TI is not responsible or liable for any such statements.

Following are URLs where you can obtain information on other Texas Instruments products and application solutions:

### Products

Amplifiers	<a href="http://amplifier.ti.com">amplifier.ti.com</a>
Data Converters	<a href="http://dataconverter.ti.com">dataconverter.ti.com</a>
DSP	<a href="http://dsp.ti.com">dsp.ti.com</a>
Interface	<a href="http://interface.ti.com">interface.ti.com</a>
Logic	<a href="http://logic.ti.com">logic.ti.com</a>
Power Mgmt	<a href="http://power.ti.com">power.ti.com</a>
Microcontrollers	<a href="http://microcontroller.ti.com">microcontroller.ti.com</a>

### Applications

Audio	<a href="http://www.ti.com/audio">www.ti.com/audio</a>
Automotive	<a href="http://www.ti.com/automotive">www.ti.com/automotive</a>
Broadband	<a href="http://www.ti.com/broadband">www.ti.com/broadband</a>
Digital control	<a href="http://www.ti.com/digitalcontrol">www.ti.com/digitalcontrol</a>
Military	<a href="http://www.ti.com/military">www.ti.com/military</a>
Optical Networking	<a href="http://www.ti.com/opticalnetwork">www.ti.com/opticalnetwork</a>
Security	<a href="http://www.ti.com/security">www.ti.com/security</a>
Telephony	<a href="http://www.ti.com/telephony">www.ti.com/telephony</a>
Video & Imaging	<a href="http://www.ti.com/video">www.ti.com/video</a>
Wireless	<a href="http://www.ti.com/wireless">www.ti.com/wireless</a>

## TI Worldwide Technical Support

### Internet

**TI Semiconductor Product Information Center Home Page**  
[support.ti.com](http://support.ti.com)

**TI Semiconductor KnowledgeBase Home Page**  
[support.ti.com/sc/knowledgebase](http://support.ti.com/sc/knowledgebase)

### Product Information Centers

#### Americas

Phone	+1(972) 644-5580	Fax	+1(972) 927-6377
Internet/Email	<a href="http://support.ti.com/sc/pic/americas.htm">support.ti.com/sc/pic/americas.htm</a>		

#### Europe, Middle East, and Africa

Phone			
Belgium (English)	+32 (0) 27 45 54 32	Netherlands (English)	+31 (0) 546 87 95 45
Finland (English)	+358 (0) 9 25173948	Russia	+7 (0) 95 7850415
France	+33 (0) 1 30 70 11 64	Spain	+34 902 35 40 28
Germany	+49 (0) 8161 80 33 11	Sweden (English)	+46 (0) 8587 555 22
Israel (English)	1800 949 0107	United Kingdom	+44 (0) 1604 66 33 99
Italy	800 79 11 37		
Fax	+(49) (0) 8161 80 2045		
Internet	<a href="http://support.ti.com/sc/pic/euro.htm">support.ti.com/sc/pic/euro.htm</a>		

#### Japan

Fax			
International	+81-3-3344-5317	Domestic	0120-81-0036
Internet/Email			
International	<a href="http://support.ti.com/sc/pic/japan.htm">support.ti.com/sc/pic/japan.htm</a>		
Domestic	<a href="http://www.tij.co.jp/pic">www.tij.co.jp/pic</a>		

#### Asia

Phone			
International	+886-2-23786800		
Domestic	Toll-Free Number		
Australia	1-800-999-084	New Zealand	0800-446-934
China	800-820-8682	Philippines	1-800-765-7404
Hong Kong	800-96-5941	Singapore	800-886-1028
Indonesia	001-803-8861-1006	Taiwan	0800-006800
Korea	080-551-2804	Thailand	001-800-886-0010
Malaysia	1-800-80-3973		
Fax	886-2-2378-6808	Email	<a href="mailto:tiasia@ti.com">tiasia@ti.com</a>
Internet	<a href="http://support.ti.com/sc/pic/asia.htm">support.ti.com/sc/pic/asia.htm</a>		<a href="mailto:ti-china@ti.com">ti-china@ti.com</a>

### C011905

**Safe Harbor Statement:** This publication may contain forward-looking statements that involve a number of risks and uncertainties. These "forward-looking statements" are intended to qualify for the safe harbor from liability established by the Private Securities Litigation Reform Act of 1995. These forward-looking statements generally can be identified by phrases such as "TI or its management believes," "expects," "anticipates," "foresees," "forecasts," "estimates" or other words or phrases of similar import. Similarly, such statements herein that describe the company's products, business strategy, outlook, objectives, plans, intentions or goals also are forward-looking statements. All such forward-looking statements are subject to certain risks and uncertainties that could cause actual results to differ materially from those in forward-looking statements. Please refer to TI's most recent Form 10-K for more information on the risks and uncertainties that could materially affect future results of operations. We disclaim any intention or obligation to update any forward-looking statements as a result of developments occurring after the date of this publication.

**Trademarks:** PowerFLEX and PowerPAD are trademarks of Texas Instruments. All other trademarks are the property of their respective owners.

Mailing Address: Texas Instruments  
Post Office Box 655303  
Dallas, Texas 75265

© 2005 Texas Instruments Incorporated