

# BAW Oscillator Solutions for Factory Automation



## BAW Resonator Technology

BAW is a micro-resonator technology that enables the integration of high-precision and ultra-low jitter clocks directly into packages that contain other circuits. In the BAW oscillator, the BAW is intergated with a co-located precision temperature sensor, a ultra-low jitter, low power fractional output divider (FOD), a single-ended LVCMOS and differential LVPECL, LVDS, and HCSL output driver, and a small power-reset-clock management system consisting of several low noise LDOs.

Figure 1 shows the structure of the the BAW resonator technology. The structure includes a thin layer of piezoelectric film sandwiched between metal films and other layers that confine the mechanical energy. The BAW utilizes this piezoelectric transduction to generate a vibration.

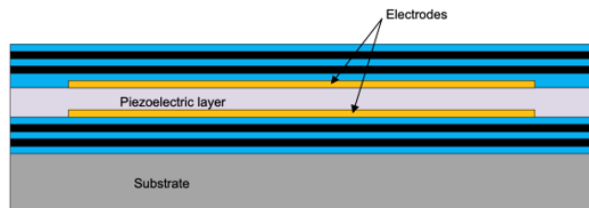


Figure 1. Basic structure of a Bulk Acoustic Wave (BAW) resonator

## BAW Oscillator in Factory Automation

The BAW oscillator can be used in factory automation applications to clock the Ethernet PHY, processor (SOC), Wifi, and USB controller as shown in Figure 2.

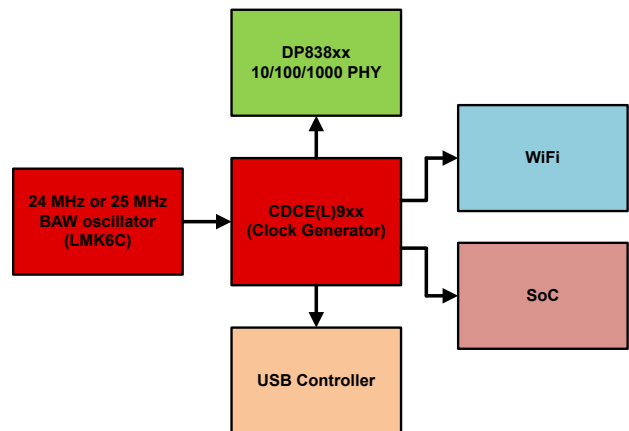


Figure 2. Typical Block Diagram of BAW Oscillator Used in Factory Automation

Devices	Type	Function	Key Features
LMK6C/D/P/H	Ultra-low jitter XO	Reference clock to Ethernet PHY, Wi-Fi®, SoC, and USB controller	1 MHz to 400 MHz, ± 25 ppm, 200 fs jitter
LMK1C1104	1:4 LVCMOS buffer	Fan out to clock Ethernet PHY, Wi-Fi, SoC, and USB controller in applications where all four require the same frequency	1.8 V - 3.3V supply, ultralow additive jitter of 20 fs
CDCE(L)9xx	Clock Generator	Supports four unique output frequencies	PCIe Gen 1-5, Automotive Grade

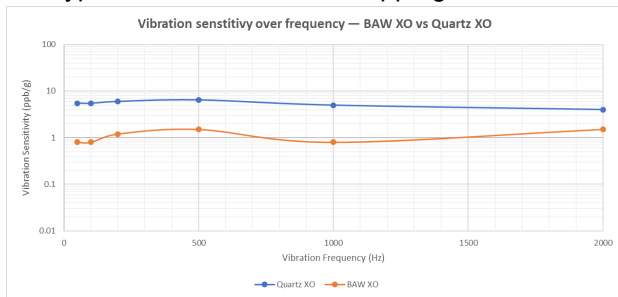
## Benefits of the BAW Oscillator

The BAW oscillator has three key benefits: high-grade reliability, superb performance, and operates as a flexible solution.

### High-Grade Reliability

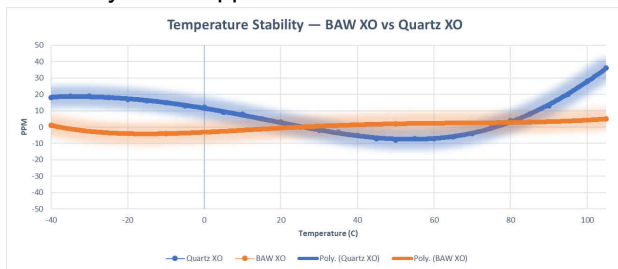
The BAW oscillator provides:

- A typical vibration metric of 1 ppb/g.



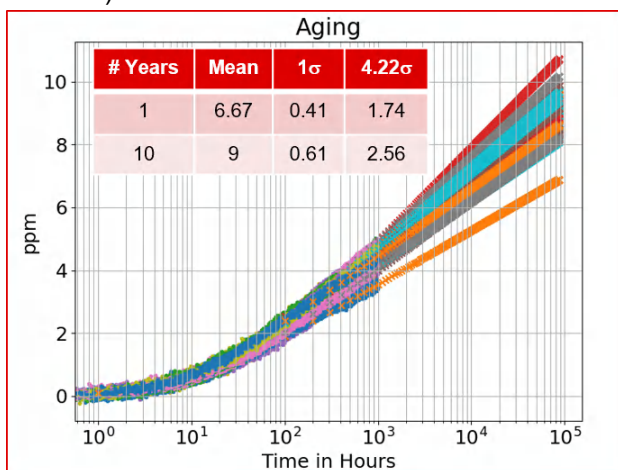
**Figure 3. BAW Oscillator Vibration Sensitivity**

- An all-inclusive frequency stability of  $\pm 25$  ppm (including 10 years aging) and a temperature stability of  $\pm 10$  ppm.

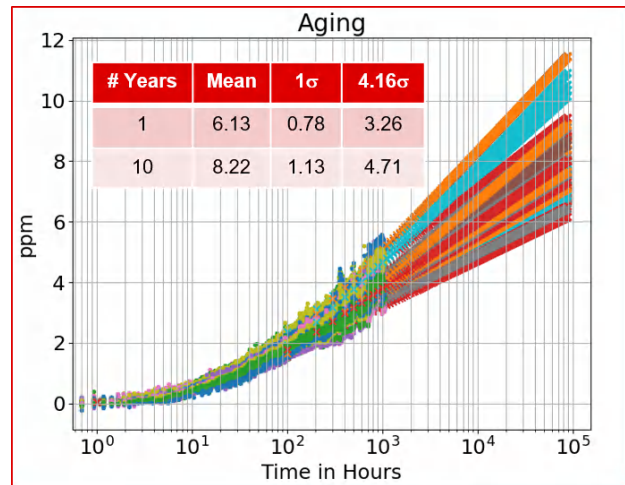


**Figure 4. Temperature Stability Comparison of BAW Oscillator and Quartz Oscillator**

- 20 - 30 times higher MTBF (mean time before failure)



**Figure 5. LMK6D/P/H Differential BAW Oscillator Aging**

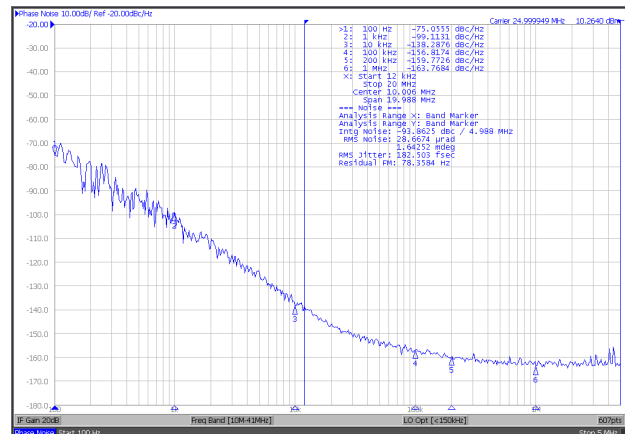


**Figure 6. LMK6C Single-ended BAW Oscillator Aging**

### Superb Performance

The BAW oscillator supports both differential and single-ended outputs. The differential BAW oscillators (LVPECL, LVDS, and HCSL) have a typical rms jitter of 100 fs and a maximum rms jitter of 125 fs over the integration bandwidth of 12 kHz to 20 MHz. The single-ended BAW oscillator (LVCMOS) has a typical rms jitter of 200 fs and a maximum rms jitter of 500 fs.

Figure 7 illustrates phase noise plots for the 25 MHz variant of the BAW oscillator, which is the most commonly used frequencies in factory automation applications.



**Figure 7. LMK6C BAW Oscillator 25 MHz Phase Noise Performance**

### Flexible Solution

The BAW oscillator can support any frequency from 1 MHz to 400 MHz, supports LVCMOS, LVDS, LVPECL, and HCSL output formats, comes in two package sizes (3.2 mm x 2.5 mm and 2.5 mm x 2.0 mm), and supports 1.8 V, 2.5 V, and 3.3 V supply voltages.

## IMPORTANT NOTICE AND DISCLAIMER

TI PROVIDES TECHNICAL AND RELIABILITY DATA (INCLUDING DATA SHEETS), DESIGN RESOURCES (INCLUDING REFERENCE DESIGNS), APPLICATION OR OTHER DESIGN ADVICE, WEB TOOLS, SAFETY INFORMATION, AND OTHER RESOURCES "AS IS" AND WITH ALL FAULTS, AND DISCLAIMS ALL WARRANTIES, EXPRESS AND IMPLIED, INCLUDING WITHOUT LIMITATION ANY IMPLIED WARRANTIES OF MERCHANTABILITY, FITNESS FOR A PARTICULAR PURPOSE OR NON-INFRINGEMENT OF THIRD PARTY INTELLECTUAL PROPERTY RIGHTS.

These resources are intended for skilled developers designing with TI products. You are solely responsible for (1) selecting the appropriate TI products for your application, (2) designing, validating and testing your application, and (3) ensuring your application meets applicable standards, and any other safety, security, regulatory or other requirements.

These resources are subject to change without notice. TI grants you permission to use these resources only for development of an application that uses the TI products described in the resource. Other reproduction and display of these resources is prohibited. No license is granted to any other TI intellectual property right or to any third party intellectual property right. TI disclaims responsibility for, and you will fully indemnify TI and its representatives against, any claims, damages, costs, losses, and liabilities arising out of your use of these resources.

TI's products are provided subject to [TI's Terms of Sale](#) or other applicable terms available either on [ti.com](http://ti.com) or provided in conjunction with such TI products. TI's provision of these resources does not expand or otherwise alter TI's applicable warranties or warranty disclaimers for TI products.

TI objects to and rejects any additional or different terms you may have proposed.

Mailing Address: Texas Instruments, Post Office Box 655303, Dallas, Texas 75265  
Copyright © 2022, Texas Instruments Incorporated