

A Practical Guide To Cable Selection



Literature Number: SNLA164

A Practical Guide To Cable Selection

National Semiconductor
Application Note 916
David Hess
John Goldie
October 1993



1.0 INTRODUCTION

This application note provides an overview of the various considerations necessary for selecting suitable copper multi-conductor or twisted pair cables for use with standard interface devices. It is important that a cable is well matched to the application; as well as, that the various cable selection trade-offs are considered for a cost effective system design. Cable types, constructions, and characteristics are covered and then related to the various device requirements.

2.0 TYPES OF CABLES

The two most basic cable categories are flat and round (see *Figure 1* and *Figure 2*). Both flat and round cables are available in multiconductor or twisted pair configurations and each with or without shielding. Shielding of various types is also available in both cases. Flat cables have carefully controlled conductor spacing making them suitable for mass termination. Round cables are suited for long cable runs or where flexibility and compactness are required.

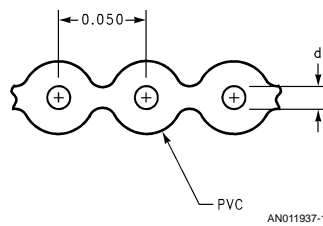

FIGURE 1. Drawing of Flat Cable, Cross-Section

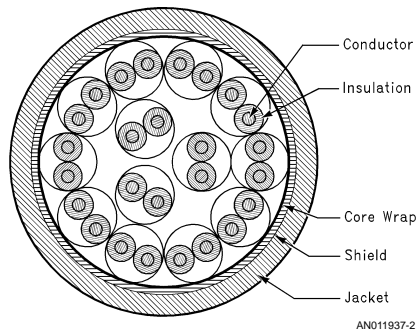

FIGURE 2. Drawing of Round Cable, Cross-Section

Multiconductor cables are available for basic single-ended, i.e., unbalanced applications. Twisted pair cables are available for differential, i.e., balanced applications (*Figure 3*). Note that a coaxial cable, a single insulated conductor with an overall shield; is, in this context, a "multiconductor" cable

with only one conductor (the shield serving the dual purpose of signal return path and signal containment). In a similar sense, a two conductor multiconductor cable, since it is twisted, is equivalent to a single twisted pair cable.

KYNAR® is a registered trademark of Elf Atochem.
Teflon® is a registered trademark of E.I. DuPont de Nemours Company.

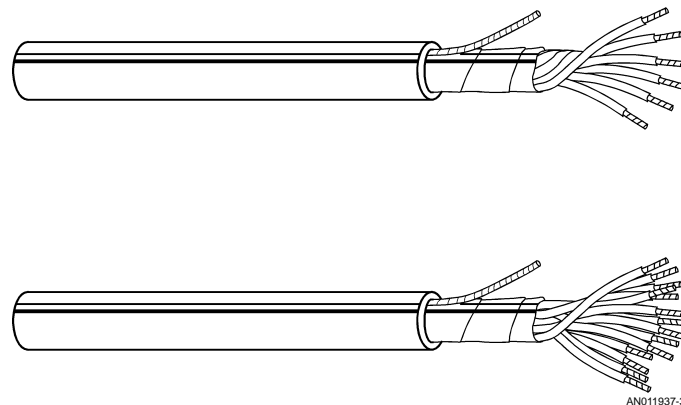

FIGURE 3. Drawing Comparison of Multiconductor Cable and Twisted Pair Cable

It is common and preferable to use a twisted pair cable for single-ended applications. Some higher speed or longer distance single-ended applications provide a separate return conductor for each data and timing circuit, helping to reduce crosstalk. Note that single-ended applications cannot fully utilize the special capability of a twisted pair. Multiconductor cable should not be used for differential applications where twisted pairs are essential.

It is important to recognize that a twisted pair serves a fundamental electrical purpose. A twisted pair maintains, along its length, the balance necessary for and thus the common mode rejection sought in differential applications. The degree of physical symmetry achieved in constructing a twisted pair of insulated conductors determines how well it is balanced electrically. The double helix configuration of the pair produces symmetrical parasitics for each conductor. Symmetrical parasitics assure that induced noise signals are equal, or "common", to both conductors. This is the primary means of reducing crosstalk between various circuits within a cable. Flat cables constructed with twisted pairs are also available to achieve improved crosstalk characteristics.

Advantages of Flat Cables

By providing a means for mass termination, flat cables are relatively inexpensive to terminate. Connectors are available in configurations with insulation displacement contacts aligned for flat cable termination. The contacts are simultaneously pressed through the insulation onto all of the conductors of a flat cable. The cable conductor to connector contact alignment is critical. The two industry standard conductor centerline spacings are 0.050 and 0.025 inches. Controlling this parameter is a primary concern in producing flat cable and somewhat limits the range of cables' electrical characteristics available.

Advantages of Round Cables

Round cable flexibility is not limited to a single plane, as in the case of flat cable. For long cable runs, especially installed in conduit or raceway, flat cable is impractical. The flexibility of round cables is the result of having the individual elements, single conductors or twisted pairs, "cabled"; that is, they are "laid" at a pitch angle relative to the axis of the cable, forming a helix. The greater the pitch angle the greater the degree of flexibility. Color coding is usually provided as the means of identifying the individual conductors

aiding the process of individually terminating each conductor. A round cable is simpler to manufacture with a shield. Capacitance can be reduced with thicker insulation walls, since there are no inherent conductor spacing requirements. Other than the case of simple, flat, strait, unshielded multiconductor cables; round cables have less cross-sectional area for a given number of conductors. More cross-sectional area is required for a shield or jacket on a flat cable.

3.0 CABLE CONSTRUCTION

Overall Construction

Conductors

Standard subminiature D-style connectors are designed to accept conductor sizes ranging typically from 22 AWG down to 26 AWG. Stranded tinned copper is normally used. Stranding provides a considerable improvement in flexibility and protection from conductor breaks due to repeated flexing, i.e., improved flex life. Tin coating on the strands improves environmental resistance by preventing corrosion of the conductor. The tin coating also makes the conductor more suitable for soldering. Standard connector pins are sized to accept the stranded conductor's increased diameter compared to solid conductor diameters.

Solid or non-tinned conductors are not recommended for use with some connectors. Some connector pins are crimped onto the end of the conductor where a small section of the insulation has been removed. This leaves a short section of exposed conductor susceptible to corrosion. Given the minimal space provided within the connector backshell, the added flexibility of stranded conductor makes the job of cramming the terminated conductors into the backshell a lot easier and more reliable. Conductor stranding also increases the overall cable flexibility, easing installation, and making the cable more likely to withstand the related abuses. If there will be even occasional flexing required in the cable application, stranded conductors are strongly recommended.

Nominal cost savings are gained by eliminating stranding or tin coating, but consideration should be given to the reduction in reliability. Stranding and tin coating have an effect on the signal loss of a transmission line, but these effects are insignificant below frequencies of about 10 MHz. These effects are essentially immeasurable at the frequencies associated

with current TIA data communication standards; furthermore, other far more predominant limiting factors arise at data rates greater than 1 Mbps.

For typical serial data links, the de-facto standard gauge size is 24 AWG. TIA/EIA interface standards' recommendations are based on 24 AWG. This is the appropriate size to use with common subminiature D-style connectors. For smaller conductors to be properly captured in crimped contacts, special sized contacts may be required. Overall cable size and weight reduction can be achieved using 26 AWG or smaller conductors at the expense of increased fragility. Note, there are National Electrical Code restrictions that prevent conductors smaller than 24 AWG from being used in premises communication applications. Smaller conductors are recommended for restricted applications, such as equipment cables or where overall cable size must be limited; say for wide parallel data links used in short distances, up to 10 or 20 meters.

Larger conductors cannot provide very much improvement in performance. The overwhelming performance limiting factor in serial data communication systems is noise. An attempt to increase data rate and/or distance by increasing conductor size and thus reducing attenuation, is likely to be offset by crosstalk and other noise limitations. Consider, for instance,

that EIA-422-A gives recommendations for transmission up to 1,200 meters (4000 feet) at data rates up to 90 kbps on 24 AWG cable. Typical data communication applications fall within the restrictions imposed by the voltage drop limitations of 24 AWG conductor. Special sized connector contacts may be required for larger conductors.

Copper conductors come in standard sizes according to the American Wire Gauge (AWG) system. A conductor gauge size is based on its cross-sectional area, and thus DC resistance. The overall diameter of the conductor depends on whether it is solid or stranded. Stranding is provided as a means of improving flexibility and flex-life, and the strand bundle is twisted similarly and for the same reasons mentioned above for the overall cable. The basic stranding configuration is 7 strands; 6 around 1. For a given gauge size; the more strands, the more flexible. Stranded conductors are considerably more expensive than solid conductors and the cost increases with greater numbers of finer strands. Stranded conductors utilize standard AWG size strands and numbers of strands. Their size is designated by the largest AWG size less than or equal to the sum cross-sectional area of the individual strands. Note, insulation displacement connector contacts are specifically designed for either solid or stranded conductors.

TABLE 1. Conductors Solid Stranded Tinned and Bare from 30 AWG to 20 AWG vs Diameter DCR Weight, etc.

AWG	Stranding	Diameter		Weight		D. C. Resistance @20°C			
		inches	mm	lbs./kft.	kg/km	Tin Coated		Bare or Silver Plated	
						ohms/kft.	ohms/km	ohms/kft.	ohms/km
40	solid	0.0031	0.079	0.0291	0.0433	1158	3799	1080	3540
38	solid	0.0040	0.102	0.0484	0.0720	696	2283	648	2130
36	solid	0.0050	0.127	0.0757	0.113	445	1461	415	1360
34	solid	0.0063	0.160	0.120	0.179	281	920	261	857
32	solid	0.0080	0.203	0.194	0.289	174	571	162	532
32	7/40	0.010	0.254	0.21	0.31	176	577	164	539
30	solid	0.0100	0.254	0.30	0.45	113	371	104	340
30	7/38	0.012	0.305	0.35	0.52	106	348	92.6	303
28	solid	0.0126	0.320	0.48	0.72	70.8	232	65.3	214
28	7/36	0.015	0.381	0.55	0.82	67.5	221	59.3	194
26	solid	0.0159	0.404	0.77	1.14	44.5	146	41.0	135
26	7/34	0.019	0.483	0.87	1.29	42.5	139	37.3	122
24	solid	0.0201	0.511	1.22	1.82	27.2	89.2	25.7	84.2
24	7/32	0.024	0.610	1.38	2.05	25.7	84.2	23.1	75.9
22	solid	0.0253	0.643	1.94	2.89	16.7	54.8	16.2	53.2
22	7/30	0.031	0.787	2.19	3.26	16.6	54.4	14.8	48.6
20	solid	0.0320	0.813	3.10	4.61	10.5	34.4	10.1	33.2
20	7/28	0.038	0.965	3.49	5.19	10.3	33.8	9.33	30.6

The conductor, or individual strands in the case of stranded conductors, can be coated or "bare". Tin is the most common coating. Diffusion of the tin coating into the surface of the copper causes the DC resistance to be somewhat higher than bare conductors, but this is a concern mainly at frequencies above 10 MHz. Tinning, although providing for superior soldering, mainly provides substantial corrosion resistance over bare copper. The very short section of exposed conductor, even inside a connector body, between the end of insulation and, say a crimped on contact pin, can be a point of failure in a cable assembly. Other coatings, silver used to

achieve improved soldering and corrosion resistance without the higher resistance penalty, and nickel used for high heat resistance with the higher resistance penalty; are used only in special applications.

INSULATIONS

In addition to providing basic insulating properties, the plastics used to coat the conductors have various signal altering characteristics. The two properties of insulating plastics that affect transmission are the dielectric constant and the dissipation factor.

pation factor. The dielectric constant is a function of the velocity at which energy travels through the dielectric (another name for insulation). The dissipation factor is a function of the rate at which energy is absorbed by the dielectric. Reducing either of these factors results in better signal transmission performance.

The plastic most commonly used for conductor insulation is polyvinylchloride (PVC). Its dielectric properties are good but, generally not good enough for any data communication application more demanding than basic low speed (<100 kbps), short distance (<50 m) links. PVC is normally used for power, control, instrumentation, and audio cables; applications that operate at relatively low frequencies. High performance serial data cables normally use a polyolefin insulation; either polyethylene or polypropylene, because their dielectric properties are far superior to PVC. Even though a data signal may be operating at a fairly low data rate the signal may be made up of pulses with fast rise times. The rise time of the pulse determines the frequency range covered by the signal. Typical data signals have power spectrums well into the 1 MHz to 10 MHz range. The polyolefins' dielectric constants and dissipation factors are low compared to PVC's and, unlike PVC, remain low well into the microwave region of the spectrum.

There is no great disadvantage to using polyolefins compared to PVC. The cost, at most, is only marginally higher. Some cable design precautions must be taken to meet flammability regulations. Polyolefins are far more flammable than PVC, but this can be overcome with a flame retardant outer cable jacket. As will be seen later, polyolefin insulation is essential for good performance with shielded cables.

The only exception to the choice of polyolefin insulation is the case of plenum cables used in premises wiring applications. Fluorinated ethylene/propylene copolymer (FEP),

available in Teflon®, is substituted to achieve low smoke and flame producing characteristics to meet special National Electrical Code (NFPA) requirements. The dielectric properties of FEP are slightly superior to polyolefins.

SHIELDS

One problem that arises with long distances is a transmission line's susceptibility to interfering signals. Electro-magnetic interference (EMI) is basically unavoidable and a long transmission line is very susceptible. Long wires make good antennas.

Most of the serial interface standards do not require shielding, although provisions are made for shields within the standard connectors and recommendations for grounding. The standards basically avoid the subject of shielding as one which is outside of their scopes. On the other hand, the primary caution given in the distance and data rate guidelines is that outside interference is not taken into consideration. Shielding can greatly reduce or eliminate the possibility that the system will fail after you have followed all the other guidelines. Regardless of the effects interference may have directly on the serial interface, shielded cable may be required due to the overall system's susceptibility or emissions passed through the enclosure via an interface port. Shielding should be considered for all but very short low speed data circuits; above 10 meters or 100 kbps.

Shields are additional conductors added to cables and are designed to isolate electro-magnetic fields surrounding conductors or pairs within the shield from those outside of the shield. Shields may be placed over individual conductors, twisted pairs, or may be placed over the entire bundle of cable elements or in both locations. Multiple shields within a cable may be electrically isolated from each other with additional insulating layers.

TABLE 2. Insulation Types vs Qualitative Performance Characteristics Electricals, etc.

Insulation Type	Specific Gravity	Dielectric Constant	Dissipation Factor	Volume Resistivity ohm-cm	Dielectric Strength Volts/Mil	Flammability	Temperature Range °C
PVC (Standard)	1.25–1.38	4–6	0.06–0.10	10 ¹¹	800–900	Good	–20 to 80
PVC (Premium)	1.38	3–5	0.080–0.085	10 ¹²	800–900	Good	–55 to 105
Polyethylene	0.92	2.27	0.0002	>10 ¹⁶	1200	Poor	–60 to 80
Polypropylene	0.90	2.24	0.0003	>10 ¹⁶	850	Poor	–60 to 80
Cellular Polyethylene	0.50	1.5	0.0002	—	500	Poor	–60 to 80
Flame Retardant Polyethylene	1.30	2.5	0.0015	>10 ¹⁶	1000	Fair	–60 to 80
FEP (or TFE)	2.15	2.1	0.0007	>10 ¹⁸	1200	Excellent	–70 to 200 (or 260)
Cellular FEP	1.2	1.4	0.0007	—	500	Good	–70 to 200

Typical cables use three basic kinds of shields; a tape shield, a braided or served wire shield, or a double shield consisting of a tape plus braided or served wires (see Figure 4 and Figure 5). The tape shield always includes an uninsulated "drain" wire in contact with the aluminum, used to terminate the shield. The double shield includes a braided or served layer of wires in contact with the conductive side of a tape

shield. Special shields are used for special applications such as corrugated rigid metal tapes used in telecommunications cables, solid tubes used on CATV cables, or woven or expanded metal screens used for flat cables.

The ideal shield is a seamless metallic tube as with the aluminum tubing utilized by the CATV industry on semi-rigid co-

axial cable trunk lines; the emphasis is on "semi-rigid". To achieve flexibility a shield is made up of braided or served layers of fine wires or helical wrapped tapes.

Braided shields are made up of groups of fine; 34, 36, or 38 AWG, depending on the overall cable size; usually tinned, copper strands; groups of these strands are woven May-pole

fashion, in opposite directions, around the cable. Served shields consist of a single layer of strands laid in a single direction around the cable. Served shields are very flexible and are used in applications such as microphone or mouse cables. The small gaps in single layer served shields make them unsuitable for high frequencies (>10 MHz).

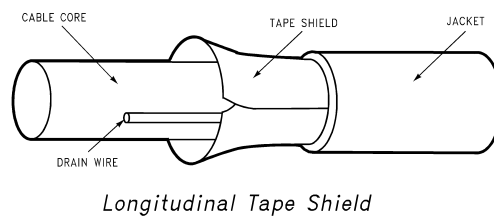
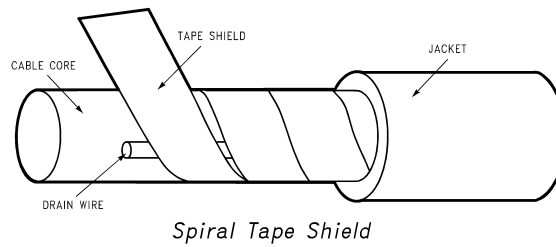
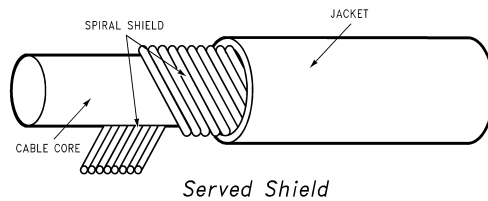
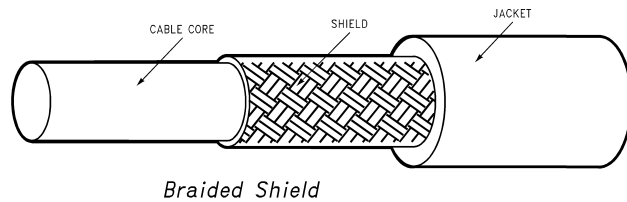

AN011937-7

FIGURE 4. Braid, Serve, Tape Shielding

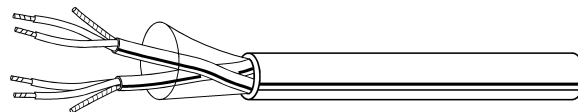

FIGURE 5. Individual Pair Shields

Tapes are a thin foil, usually aluminum, laminated to one or both sides of a plastic film, usually polyester or polypropy-

lene. Tapes come in various thicknesses. The aluminum can be 1/8 to 2 mils thick. The plastic film, typically polyester or

polypropylene, can be 1/8 to 2 mils thick. Thicknesses are selected by trading off flexibility with shielding effectiveness and signal attenuation in cases where the shield provides signal return path. Effective overlap of the tape is important for reliable performance. Uninsulated drain wires are normally of the same construction as the cable's conductors, but must be tinned to permit direct contact with the aluminum.

A simple model for shielding effectiveness is the shield's DC resistance. A shield is equally effective in both directions, in and out, and its effectiveness is proportional to its surface transfer impedance (which equals shield DCR at 0 Hz). Surface transfer impedance is the frequency dependent voltage/current ratio derived from a current driven on one side of the shield resulting in an induced voltage on the other side of the shield (see Figure 6). A detailed explanation of the surface transfer impedance model is outside of the scope of this application note.

Braids and serves have much lower resistances than tape shields. A typical double shield has about 1/5 the resistance of a tape shield, so it will be about 5 times more effective than a tape shield over the same distance. Another way of looking at it; a double shield extends the effectiveness of the tape shield to about 5 times the distance. A tape shield is effective for short cables. A double shield should be used on short distances in very noisy environments. A double shield should be used in any extended distance application, over 100 meters.

Braids are a trade-off between flexibility and ideal tubular conductors. The lower resistance of the braid results in good shielding effectiveness, but only up to a point. The small holes between the crossovers of the braid strands, become large at some frequency. Braids are specified by percent coverage as a means of determining the size of the holes. Closing up the holes, say by specifying 95% coverage, will be effective; two layers of braid can be specified for still greater effectiveness, but all at the expense of flexibility.

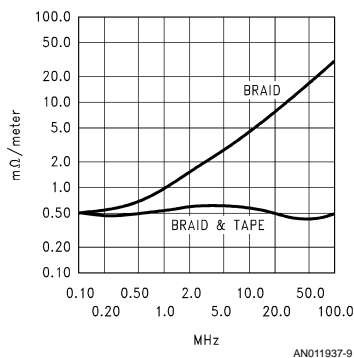

FIGURE 6. Comparison Graph of Transfer Impedances, Tape Shield vs Braid Shield

A very effective means of closing the holes and lowering the resistance is to use the combination of tape and braid. The double shield achieves low resistance through the additional cross-sectional area of the braid. The tape is overlapped to provide as near to a true tubular performance as possible.

Jackets

The most common cable jacket material is PVC, which has good environmental resistance and can be compounded to have good cold temperature flexibility and meet a range of flammability requirements.

Flammability Requirements

Equipment cables are generally required to meet some level of vertical flames test. The National Electrical Code (NEC) sets standards for the flammability ratings of cables to be installed in buildings. Cables must pass the vertical cable tray flame test to be suitable for general purpose locations. This is the same test generally required for industrial environments. Two special locations are identified by the NEC; riser and plenum, each having respectively greater degrees of flammability requirements. Plenum cable can be used in plenums, risers or general purpose locations, riser cable can only be used in risers and general purpose locations, and general purpose cables are restricted from risers and plenums. In the case of plenum cables, Polyvinylidene Fluoride (PVDF) copolymer, available as Kynar®, jackets may be used for their low smoke and flame producing characteristics.

4.0 CABLE CHARACTERISTICS

Resistance

A DC resistance requirement is the best way to assure that the wire is indeed the size it should be. It also has a specific relationship to the TIA standards. Some requirements include maximum voltage drop for the signals. The cable termination load resistance and the total cable loop resistance determine the maximum permissible cable length for given length for a given voltage drop limitation.

Capacitance

A stated cable capacitance can be one of a number of possible capacitance values that can be measured on any given cable. Depending on how the cable is actually terminated to the generator, these various capacitance values may need to be considered. The different termination possibilities derive from, for instance, unbalanced vs balanced operation. Normally the mutual capacitance of a pair is provided in cable specifications. Mutual capacitance provides a measure of the capacitance that the generators will "see" when terminated to the cable. Another specification, sometimes given, is the capacitance of one wire to all the other wires and shield connected together.

Shielded cables must use insulation with good dielectric properties (i.e., low dielectric constant) to assure that cable capacitances are kept low when a shield is added to the cable. The proximity of two conductors in a cable and the dielectric constant of the insulation between the conductors determine the capacitance measured between the conductors. The addition of a shield around the two conductors introduces two very significant "parasitic" capacitances; those between each conductor and the shield. The conductor to shield capacitances combine with the conductor to conductor capacitance to significantly increase the overall capacitance of the pair.

Impedance, Velocity of Propagation, Attenuation, Rise Time Degradation

These four parameters have a less direct bearing on data communications applications. Sometimes they are specified, but after the basic cable dimensions are given, these parameters essentially depend on the Capacitance and DC Resistance.

The various lumped circuit element parameters; capacitance, inductance, resistance, and conductance of a transmission line, are all interrelated in a single parameter known as the characteristic impedance of a transmission line. This is the impedance that if used to terminate a transmission line, no signal will be reflected back to the source. If there is a mismatch, the bigger it is, the bigger the reflections will be. Impedance matched conditions are sought for all system designs, particularly at high data rates, because the reflections affect the performance of the generators and prevent some of the signal from ever reaching the receiver. The generator and cable termination load of EIA-422-A and EIA-485 are specified in such a way as to closely match the impedance of typical "low capacitance" cables having about 12 to 16 pF/ft mutual capacitance.

Velocity of propagation, the speed at which a signal (an electromagnetic wave) will travel along a cable (a transmission line) is dependent on the properties of the insulation. The dielectric constant of a plastic is actually the inverse of the square root of the velocity of propagation; the speed that electromagnetic radiation will travel through a dielectric compared to the speed of light in a vacuum. The velocity of propagation is normally expressed as a fraction of the speed of light. The actual velocity of propagation is complicated somewhat by the fact that the signal normally travels through a combination of air and plastic, but the result is to make it a little faster than the theoretic speed derived from the insulation dielectric constant alone. The velocity of propagation determines the impedance relative to the capacitance.

The impedance and resistance determine the attenuation vs frequency. This parameter is normally expressed in dB/1000 ft at a given frequency. This is a measure of the amount of signal loss that occurs from the cable. More signal is lost at higher frequencies than at low frequencies. Remember that the rise time of the pulse, not the data rate, determines the frequency range covered by the signal.

Since there is more attenuation at higher frequencies than at lower frequencies, signal pulses are dispersed as they travel down the cable. This property is measured as rise time degradation. Rise time degradation is roughly proportional to cable length. System designers are constantly balancing rise time effects. On one hand, fast rise times produce more crosstalk, that will, if great enough, result in errors. On the other hand, slow rise times that get further degraded will cause receiver errors.

5.0 CABLE APPLICATIONS

Lowering capacitance improves the performance of cables used for both unbalanced and balanced transmission.

Unbalanced transmission is limited by near-end-crosstalk. The unbalanced lines interfere with each other primarily through capacitive coupling between the lines. Lowering any capacitance parameter of a multi-conductor or twisted pair cable will result in proportionally lowering all of the various capacitances within the cable. In the case of unbalanced lines, coupling capacitance, and therefore crosstalk, is lowered proportionally. The mutual capacitance of a paired cable used for unbalanced transmission does not directly indicate the coupling capacitance between lines, but comparing the mutual capacitance of two cables is generally a good indication of their relative crosstalk performance.

Balanced transmission is primarily limited by rise time degradation. The primary cable capacitance of concern, in this case, is the shunt capacitance across the signal generator's two output terminals. Keeping everything else equal, lowering capacitance results in a decrease in attenuation vs frequency proportional to the square root of the capacitance reduction. In the general domain of data rate and distance for current applications, the resulting change in rise time degradation is nearly proportional to the square of the change in attenuation vs frequency. This gives a relation, similar to the unbalanced case, where a comparison of the mutual capacitance of two cables is generally a good indication of their respective proportional rise time performances.

TABLE 3. Applications

Application	Multiconductor or Twisted Pair	Number of Conductors or Pairs	AWG Specified	Shielding Requirements	Transmission Characteristics Specified
EIA/TIA-232-E Section 2	Multiconductor	3 to 25	none specified	none required provisions included	2500 pF max total shunt capacitance
TIA/EIA-422-B	Twisted Pair	not specified	none specified guidelines use 24	none specified	none specified, 90-150Ω impedance recommended, guidelines use 100Ω impedance, 66% max. voltage drop
TIA/EIA-423-B	Multiconductor (Twisted Pair Better)	not specified	none specified guidelines use 24	none specified	none specified, guidelines use 100Ω impedance, 66% max. voltage drop

TABLE 3. Applications (Continued)

Application	Multiconductor or Twisted Pair	Number of Conductors or Pairs	AWG Specified	Shielding Requirements	Transmission Characteristics Specified
EIA-485	Twisted Pair	not specified	none specified	none specified	none specified, similar to TIA/EIA-422-B, guidelines use 120Ω impedance
EIA/TIA-562	Multiconductor	not specified	none specified	none specified	none specified
TIA/EIA-612 HSSI	Twisted Pair	not specified (companion spec TIA/EIA-613 requires 25)	none specified 28 recommended	shield required	110Ω impedance 4.5 dB max. total attenuation @50 MHz 79 ns max. total delay 2.0 ns/m max. total skew
X3T9.2 SCSI I	Multiconductor or Twisted Pair	50 conductor (flat) 25 pair (round)	28 AWG	required for external	100Ω impedance
X3T9.2 SCSI II	Twisted Pair	"A" Cable: 25 "B, P, Q" Cables: 34"L" Cable: 55	28 or 30 AWG	required for external	90–132Ω nominal impedance (122Ω typical), 0.095 dB/m max. attenuation @5 MHz 0.20 ns/m max. skew
X3T9.2 SCSI III	Twisted Pair	"P or Q" Cables: 34	30 minimum	required for external	122 (84)Ω nom. impedance differential (single-ended) 0.095 dB/m max. attenuation @5 MHz 5.4 ns/m max. delay 0.15 ns/m max. skew
X3T9.3 IPI (ISO 9318)	Multiconductor flat or Twisted Pair round	50 conductor (flat) 25 pair (round)	26 or 28 AWG	required for round	120Ω impedance 0.095 dB/m max. attenuation @5 MHz 5.4 ns/m max. delay 0.49 ns/m max. skew
X3T9.3 HIPPI	Twisted Pair	25	28 AWG	two shields required	108Ω impedance 0.28 dB/m max. attenuation @50 MHz 0.13 ns/m max. skew

6.0 SUMMARY

The range of cable types and basic options available for data communications applications is limited, making the basic cable design selection reasonably easy. The scope of the basic selection criteria is covered by the choices, flat or round, multiconductor or twisted pairs, and shielded or non-shielded. Basic attributes of the application; distance, environment, and flexibility requirements determine the basic cable type selected. Cable construction details, conductor size, stranding and coating, insulation type, shield options, and jacket types are determined by more specific application considerations; connector type, signal speeds, emissions and susceptibility, work and abuse, flammability, life expectancy and cost. Every cable has inherent electrical

characteristics, which can be expressed in several ways, but are interrelated and dependent upon a few simple parameters. A cable's electrical characteristics determine its suitability for use with particular interface components.

Author Biography:

David Hess, V.P. Technology, Berk-Tek, Inc., 132 White Oak Road, New Holland, Pennsylvania 17757, has worked for 17 years in product engineering and product development in the fields of copper and optical fiber data communication cables, participates in various data communications standards committees in TIA/EIA and ANSI X3T9, holds a B.S. degree in Mathematics from Pennsylvania State University and is a member of IEEE.

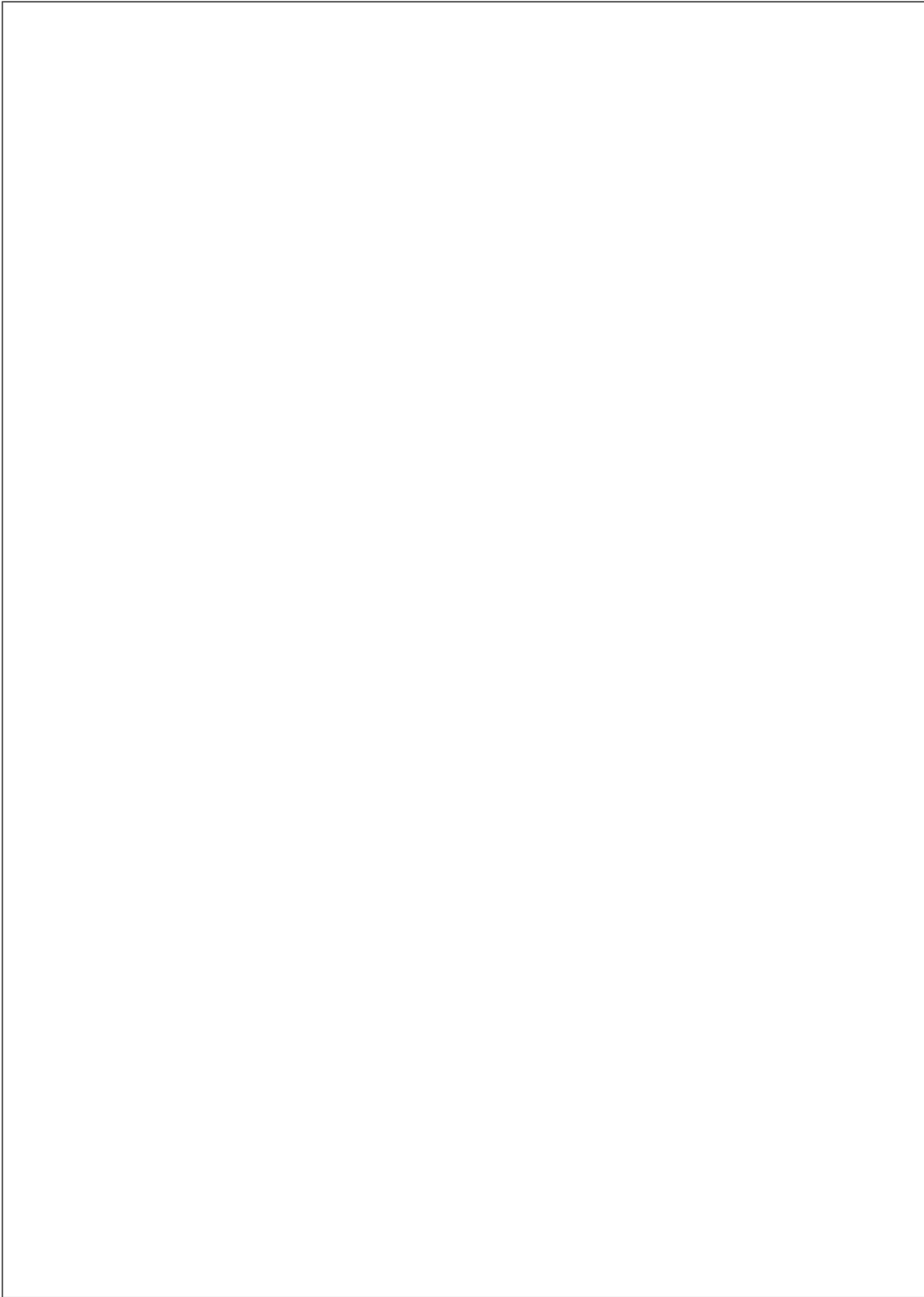

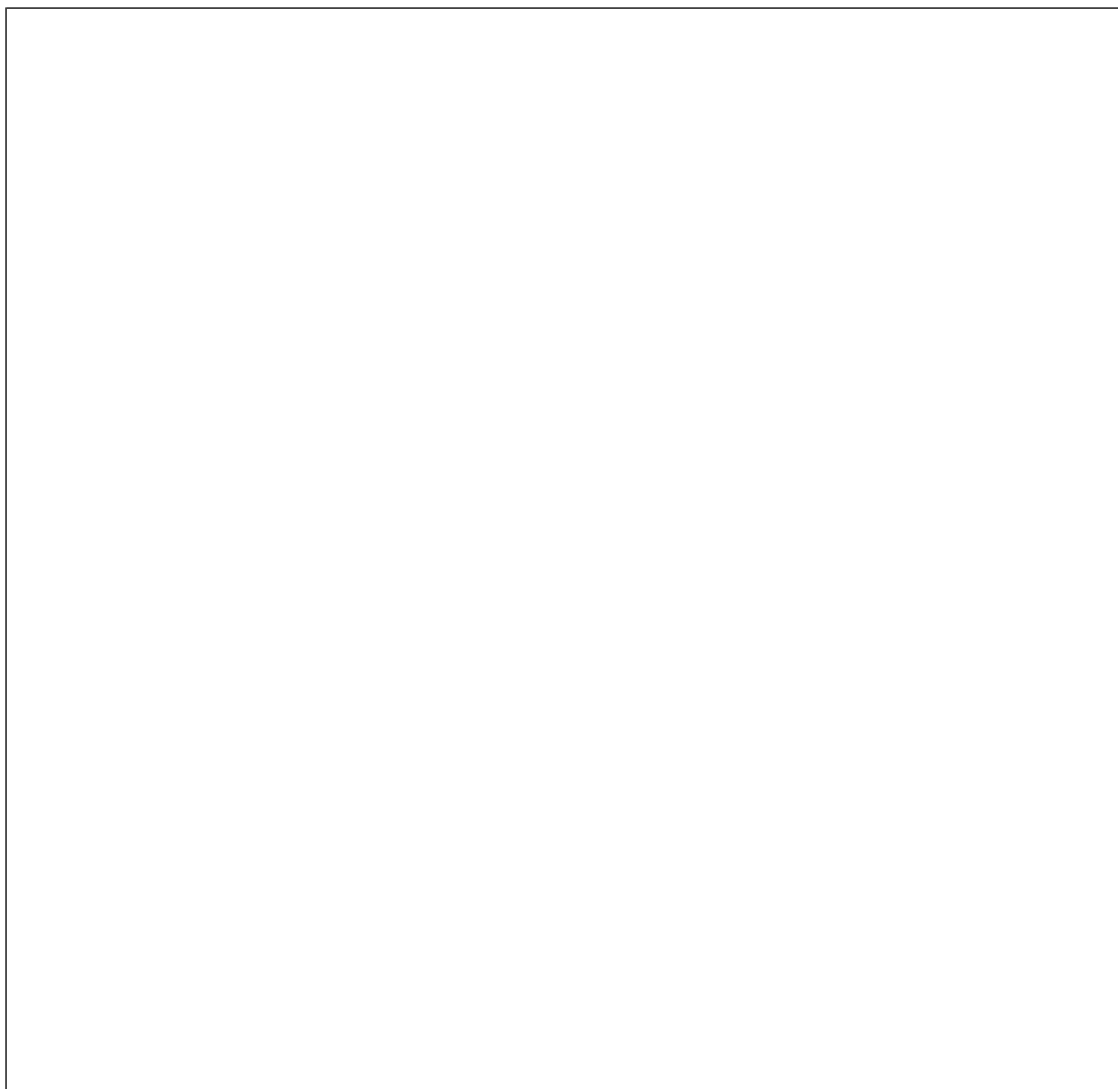

LIFE SUPPORT POLICY

NATIONAL'S PRODUCTS ARE NOT AUTHORIZED FOR USE AS CRITICAL COMPONENTS IN LIFE SUPPORT DEVICES OR SYSTEMS WITHOUT THE EXPRESS WRITTEN APPROVAL OF THE PRESIDENT OF NATIONAL SEMICONDUCTOR CORPORATION. As used herein:

- 1. Life support devices or systems are devices or systems which, (a) are intended for surgical implant into the body, or (b) support or sustain life, and whose failure to perform when properly used in accordance with instructions for use provided in the labeling, can be reasonably expected to result in a significant injury to the user.
- 2. A critical component in any component of a life support device or system whose failure to perform can be reasonably expected to cause the failure of the life support device or system, or to affect its safety or effectiveness.

 <p>National Semiconductor Corporation Americas Tel: 1-800-272-9959 Fax: 1-800-737-7018 Email: support@nsc.com</p>	<p>National Semiconductor Europe Fax: +49 (0) 1 80-530 85 86 Email: europe.support@nsc.com Deutsch Tel: +49 (0) 1 80-530 85 85 English Tel: +49 (0) 1 80-532 78 32 Français Tel: +49 (0) 1 80-532 93 58 Italiano Tel: +49 (0) 1 80-534 16 80</p>	<p>National Semiconductor Asia Pacific Customer Response Group Tel: 65-2544466 Fax: 65-2504466 Email: sea.support@nsc.com</p>	<p>National Semiconductor Japan Ltd. Tel: 81-3-5620-6175 Fax: 81-3-5620-6179</p>
--	---	--	---

www.national.com

IMPORTANT NOTICE

Texas Instruments Incorporated and its subsidiaries (TI) reserve the right to make corrections, modifications, enhancements, improvements, and other changes to its products and services at any time and to discontinue any product or service without notice. Customers should obtain the latest relevant information before placing orders and should verify that such information is current and complete. All products are sold subject to TI's terms and conditions of sale supplied at the time of order acknowledgment.

TI warrants performance of its hardware products to the specifications applicable at the time of sale in accordance with TI's standard warranty. Testing and other quality control techniques are used to the extent TI deems necessary to support this warranty. Except where mandated by government requirements, testing of all parameters of each product is not necessarily performed.

TI assumes no liability for applications assistance or customer product design. Customers are responsible for their products and applications using TI components. To minimize the risks associated with customer products and applications, customers should provide adequate design and operating safeguards.

TI does not warrant or represent that any license, either express or implied, is granted under any TI patent right, copyright, mask work right, or other TI intellectual property right relating to any combination, machine, or process in which TI products or services are used. Information published by TI regarding third-party products or services does not constitute a license from TI to use such products or services or a warranty or endorsement thereof. Use of such information may require a license from a third party under the patents or other intellectual property of the third party, or a license from TI under the patents or other intellectual property of TI.

Reproduction of TI information in TI data books or data sheets is permissible only if reproduction is without alteration and is accompanied by all associated warranties, conditions, limitations, and notices. Reproduction of this information with alteration is an unfair and deceptive business practice. TI is not responsible or liable for such altered documentation. Information of third parties may be subject to additional restrictions.

Resale of TI products or services with statements different from or beyond the parameters stated by TI for that product or service voids all express and any implied warranties for the associated TI product or service and is an unfair and deceptive business practice. TI is not responsible or liable for any such statements.

TI products are not authorized for use in safety-critical applications (such as life support) where a failure of the TI product would reasonably be expected to cause severe personal injury or death, unless officers of the parties have executed an agreement specifically governing such use. Buyers represent that they have all necessary expertise in the safety and regulatory ramifications of their applications, and acknowledge and agree that they are solely responsible for all legal, regulatory and safety-related requirements concerning their products and any use of TI products in such safety-critical applications, notwithstanding any applications-related information or support that may be provided by TI. Further, Buyers must fully indemnify TI and its representatives against any damages arising out of the use of TI products in such safety-critical applications.

TI products are neither designed nor intended for use in military/aerospace applications or environments unless the TI products are specifically designated by TI as military-grade or "enhanced plastic." Only products designated by TI as military-grade meet military specifications. Buyers acknowledge and agree that any such use of TI products which TI has not designated as military-grade is solely at the Buyer's risk, and that they are solely responsible for compliance with all legal and regulatory requirements in connection with such use.

TI products are neither designed nor intended for use in automotive applications or environments unless the specific TI products are designated by TI as compliant with ISO/TS 16949 requirements. Buyers acknowledge and agree that, if they use any non-designated products in automotive applications, TI will not be responsible for any failure to meet such requirements.

Following are URLs where you can obtain information on other Texas Instruments products and application solutions:

Products

Audio	www.ti.com/audio
Amplifiers	amplifier.ti.com
Data Converters	dataconverter.ti.com
DLP® Products	www.dlp.com
DSP	dsp.ti.com
Clocks and Timers	www.ti.com/clocks
Interface	interface.ti.com
Logic	logic.ti.com
Power Mgmt	power.ti.com
Microcontrollers	microcontroller.ti.com
RFID	www.ti-rfid.com
OMAP Mobile Processors	www.ti.com/omap
Wireless Connectivity	www.ti.com/wirelessconnectivity

Applications

Communications and Telecom	www.ti.com/communications
Computers and Peripherals	www.ti.com/computers
Consumer Electronics	www.ti.com/consumer-apps
Energy and Lighting	www.ti.com/energy
Industrial	www.ti.com/industrial
Medical	www.ti.com/medical
Security	www.ti.com/security
Space, Avionics and Defense	www.ti.com/space-avionics-defense
Transportation and Automotive	www.ti.com/automotive
Video and Imaging	www.ti.com/video

TI E2E Community Home Page

e2e.ti.com

Mailing Address: Texas Instruments, Post Office Box 655303, Dallas, Texas 75265
Copyright © 2011, Texas Instruments Incorporated