

Using CC2590 Front End with CC2541

By Abhishek Chattopadhyay

Keywords

- *Bluetooth*® low energy systems
- *Range Extender*
- *External PA*
- *External LNA*
- CC2540
- CC2541
- CC2590

1 Introduction

The CC2541 is TI's *Bluetooth*® low energy RF System-on-Chip (SoC) for the 2.4 GHz unlicensed ISM band. This chip enables consumer applications by offering state-of-the-art selectivity/co-existence, excellent link budget, and low voltage operation. The CC2540 is similar to the CC2541. It does not have the I2C like the CC2541, but has an USB interface instead. The CC2540 has the ability to output 4dBm during transmits; the CC2541 can only output 0dBm. However, unlike the CC2541 the CC2540 cannot be used in the proprietary mode.

CC2590 is a range extender for 2.4-GHz RF transceivers, transmitters and SoC products from Texas Instruments. CC2590 increases the link budget by providing a Power Amplifier (PA) for higher output power and a Low Noise Amplifier (LNA) for improved receiver sensitivity. CC2590 further contains RF switches, RF matching, and a balun for a seamless interface with the CC2541. This allows for

simple design of high performance wireless applications.

This application note talks about the use of range extenders, specifically the CC2590, with the CC2541. It further describes the expected performance from this combination as well as important factors to consider with respect to the layout and regulatory requirements. The combined CC2541 and CC2590 solution is suitable for systems targeting compliance with FCC CFR47 Part 15.

The RF front end of CC2541 is similar to that in the CC2540. Therefore similar performance from a combo board using a CC2540 instead of a CC2541 can be expected.

Texas Instruments *Bluetooth*® low energy SW solutions, BLE-Stack (www.ti.com/blestack) includes the necessary SW changes for using the CC2590.

Table of Contents

KEYWORDS	1
1 INTRODUCTION	1
2 ABBREVIATIONS	2
3 ABSOLUTE MAXIMUM RATINGS	3
4 ELECTRICAL SPECIFICATIONS	3
4.1 OPERATING CONDITIONS.....	3
4.2 CURRENT CONSUMPTION.....	3
4.3 RECEIVE PARAMETERS.....	4
4.4 RECEIVED SIGNAL STRENGTH INDICATOR (RSSI).....	4
4.5 TRANSMIT PARAMETERS.....	5
4.6 OUTPUT POWER PROGRAMMING.....	5
4.7 TYPICAL PERFORMANCE CURVES.....	6
5 APPLICATION CIRCUIT	10
5.1 POWER DECOUPLING AND RF LOADING.....	10
5.2 INPUT/ OUTPUT MATCHING AND FILTERING.....	10
5.3 BIAS RESISTOR.....	11
5.4 ANTENNA CONSIDERATIONS.....	11
6 PCB LAYOUT CONSIDERATIONS	12
6.1 THE GAIN OF THE CC2590.....	12
7 REGULATORY REQUIREMENTS	13
7.1 DUTY CYCLING WHEN COMPLYING WITH FCC.....	14
7.2 COMPLIANCE OF FCC PART 15.247 WHEN USING THE CC2541 WITH THE CC2590....	14
8 CONTROLLING THE CC2590	18
9 REFERENCES	19
10 GENERAL INFORMATION	19
10.1 DOCUMENT HISTORY.....	19

2 Abbreviations

SoC	System-on-Chip
DSSS	Direct Sequence Spread Spectrum
DUT	Device Under Test
EIRP	Equivalent Isotropically Radiated Power
EM	Evaluation Module
EVM	Error Vector Magnitude
HG	High Gain Mode of CC2541
ISM	Industrial, Scientific, Medical
FCC	Federal Communications Commission
FHSS	Frequency Hopping Spread Spectrum
LNA	Low Noise Amplifier
PA	Power Amplifier
PCB	Printed Circuit Board
PSD	Power Spectral Density
RF	Radio Frequency
RSSI	Receive Signal Strength Indicator
RX	Receive, Receive Mode
SG	Standard Gain Mode of CC2541
TX	Transmit, Transmit Mode
VSWR	Voltage Standing Wave Ratio

3 Absolute Maximum Ratings

The absolute maximum ratings and operating conditions listed in the CC2541 datasheet [1] and the CC2590 datasheet [4] must be followed at all times. Stress exceeding one or more of these limiting values may cause permanent damage to any of the devices.

4 Electrical Specifications

Note that these characteristics values are only valid when using the recommended register settings listed in the CC2541 user guide [3] and the ones presented in Section 4.6 and in Chapter 8.

4.1 Operating Conditions

Parameter	Min	Max	Unit
Operating Frequency	2400	2483.5	MHz
Operating Supply Voltage	2.0	3.6	V
Operating Temperature	-40	85	°C

Table 4.1 Operating Conditions

4.2 Current Consumption

$T_C = 25^\circ\text{C}$, $V_{DD} = 3.0\text{ V}$, $f = 2440\text{ MHz}$ if nothing else is stated. The CC2541 and CC2590 are both set to receive in High Gain mode. All parameters are measured on the CC2541 - CC2590EM reference design [9] with a $50\ \Omega$ load.

Parameter	Condition	Typical	Unit
Receive Current	Wait for sync, -90 dBm input level	21.6	mA
	Wait for sync, -50 dBm input level	21.6	
Transmit Current	TXPOWER = 0xF1	41.1	mA
	TXPOWER = 0xE1	36.6	
	TXPOWER = 0xD1	32.8	
	TXPOWER = 0xC1	30.5	
	TXPOWER = 0xB1	28.8	
	TXPOWER = 0xA1	27.5	
Power Down Current	PM2	1	uA

Table 4.2 Current Consumption

4.3 Receive Parameters

$T_C = 25^\circ\text{C}$, $V_{DD} = 3.0\text{ V}$, $f = 2440\text{ MHz}$ if nothing else is stated. The CC2590 is set to receive in its High Gain mode. All parameters are measured on the CC2541 - CC2590EM reference design with a $50\ \Omega$ load.

Parameter	Condition	Typical	Unit
Receive Sensitivity HG	1 % PER	-95	dBm
Receive Sensitivity SG	1 % PER	-92	dBm
Saturation		6.9	dBm

Table 4.3 Receive Parameters

4.4 Received Signal Strength Indicator (RSSI)

Due to the external LNA and the offset in CC2541 the RSSI readouts from CC2541 - CC2590 is different from RSSI offset values for a standalone CC2541 design. The offset values for the CC2541-CC2590EM [9] are shown in Table 4.4.

The CC2590 is set to receive in its High Gain mode. The BLE stack will have the CC2590 set such that it will always receive in its High Gain mode. The user shall have the ability to choose the Standard Gain or High Gain mode of the CC2541.

CC2541-CC2590EM LNA mode	RSSI offset ¹
High Gain	112.7
Standard Gain	103.3

Table 4.4 RSSI Compensation

¹ Real RSSI = Register value – RSSI offset

4.5 Transmit Parameters

$T_C = 25^\circ\text{C}$, $V_{DD} = 3.0\text{ V}$, $f = 2440\text{ MHz}$ if nothing else is stated. All parameters are measured on the CC2541 - CC2590EM reference design with a $50\ \Omega$ load. Radiated measurements are done with a Titanis 2.4GHz swivel antenna from Antenova [10].

Parameter	Condition	Typical	Unit
Radiated Emission with TXPOWER = 0xE1 Complies with FCC 15.247. See Chapter 7 for more details about regulatory requirements and compliance	Conducted 2-RF (FCC restricted band) ¹	-52.6	dBm
	Conducted 3-RF (FCC restricted band) ¹	-56.2	dBm
	Radiated 2-RF (FCC restricted band) ¹	-49.1	dBm

Table 4.5 Transmit Parameters

¹ The maximum allowed spurious emission signal level by FCC is -41.2 dBm

4.6 Output Power Programming

The RF output power of the CC2541 - CC2590EM is controlled by the 8-bit value in the CC2541 TXPOWER register. Table 4.6 shows the typical output power and current consumption for the recommended power settings. The results are given for $T_C = 25^\circ\text{C}$, $V_{DD} = 3.0\text{ V}$ and $f = 2440\text{ MHz}$, and are measured on the CC2541 - CC2590EM reference design with a $50\ \Omega$ load. For recommendations for the remaining CC2541 registers, see Chapter 8 or use the settings given by SmartRF Studio.

TXPOWER	Power [dBm]	Current [mA]
0xF1	10.4	41.1
0xE1	8.9	36.6
0xD1	7.3	32.8
0xC1	5.5	30.5
0xB1	3.1	28.8
0xA1	1.4	27.5

Table 4.6 Power Table

Note that the recommended power settings given in Table 4.6 are a subset of all the possible TXPOWER register settings. However, using other settings than those recommended might result in suboptimal performance in areas like current consumption and spurious emission.

When using the BLE stack, to change the settings the stack will have to be modified. The BLE stack will have the recommended settings incorporated in it.

4.7 Typical Performance Curves

$T_C = 25^\circ\text{C}$, $V_{DD} = 3.0\text{ V}$, $f = 2440\text{ MHz}$ if nothing else is stated. The CC2590 is set to receive in its High Gain mode. All parameters are measured on the CC2541 - CC2590EM reference design with a $50\ \Omega$ load.

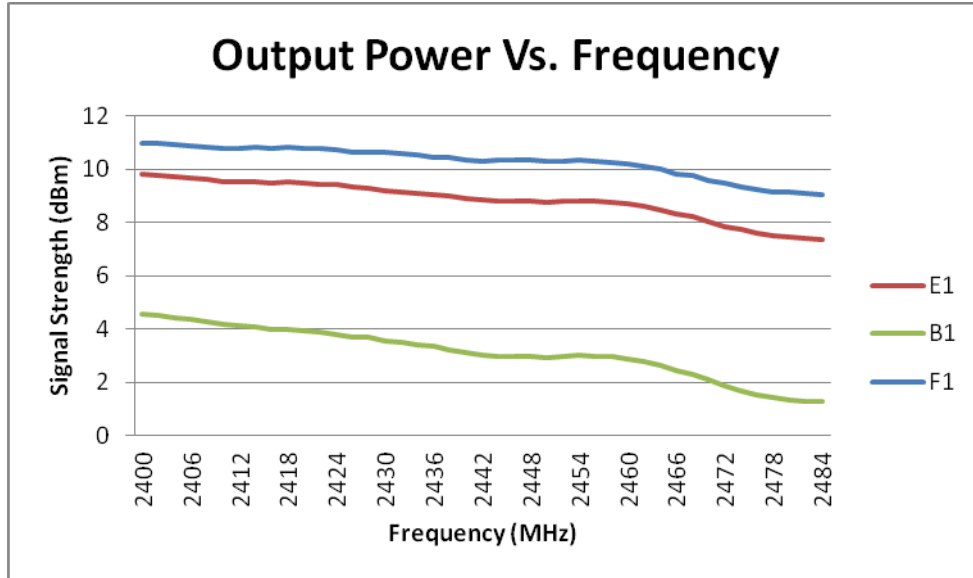

Figure 4.1 Output Power vs. Frequency, TXPOWER = 0xE1, 0xB1, 0xF1

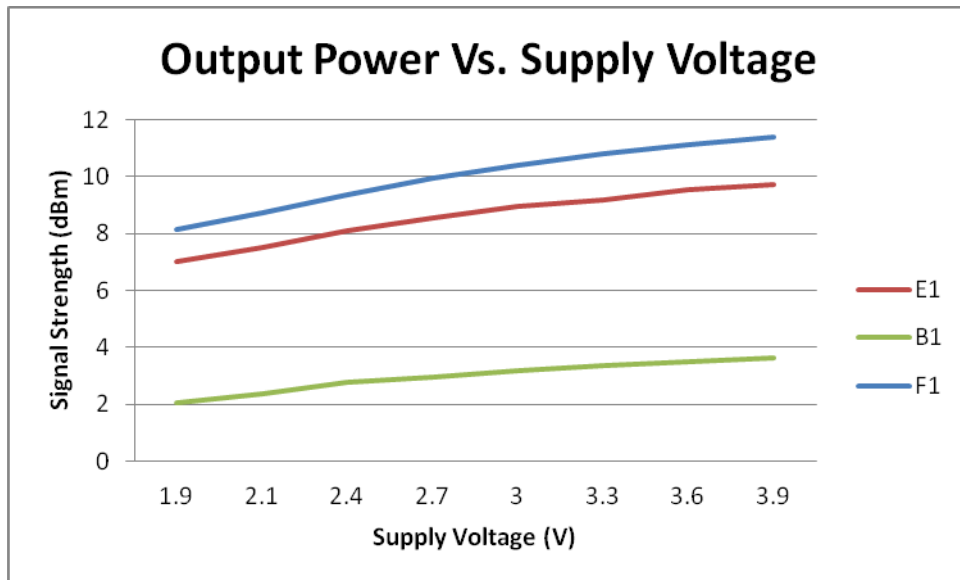

Figure 4.2 Output Power vs. Power Supply Voltage

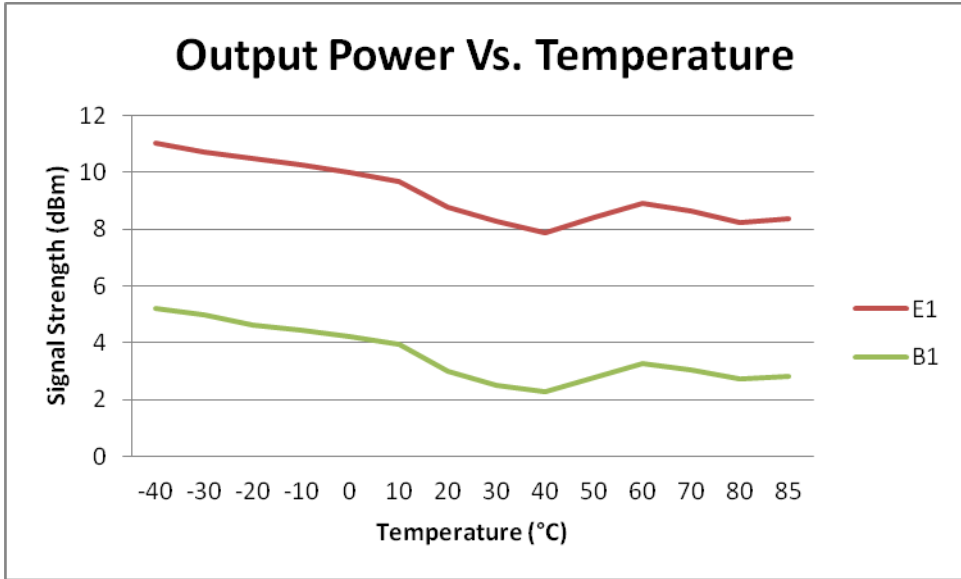

Figure 4.3 Output Power vs. Temperature

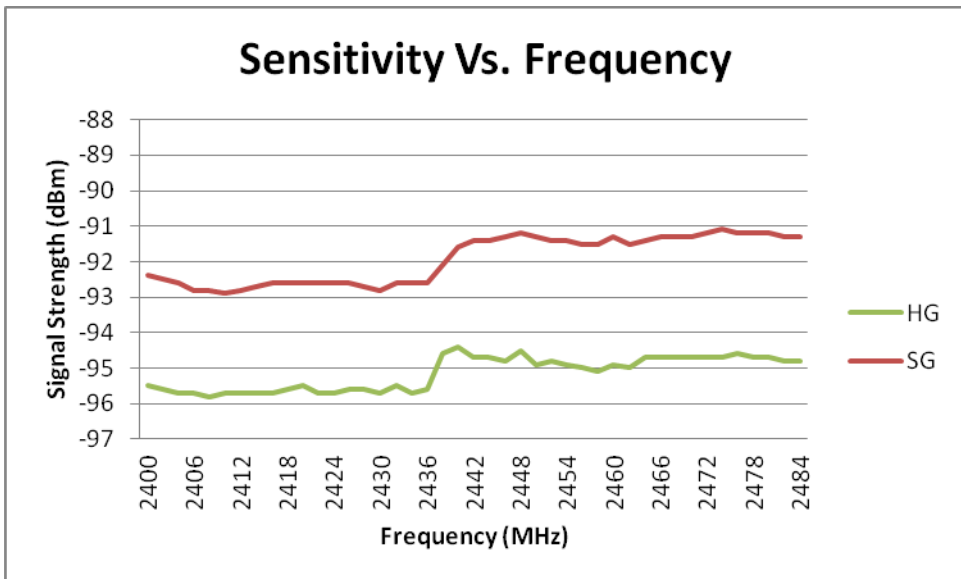

Figure 4.4 Sensitivity vs. Frequency

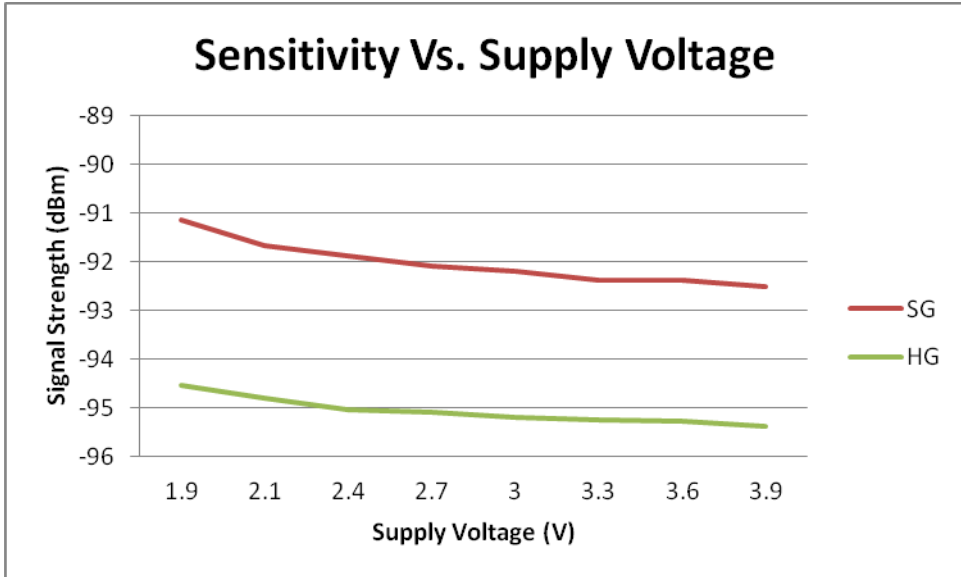

Figure 4.5 Sensitivity vs. Power Supply Voltage

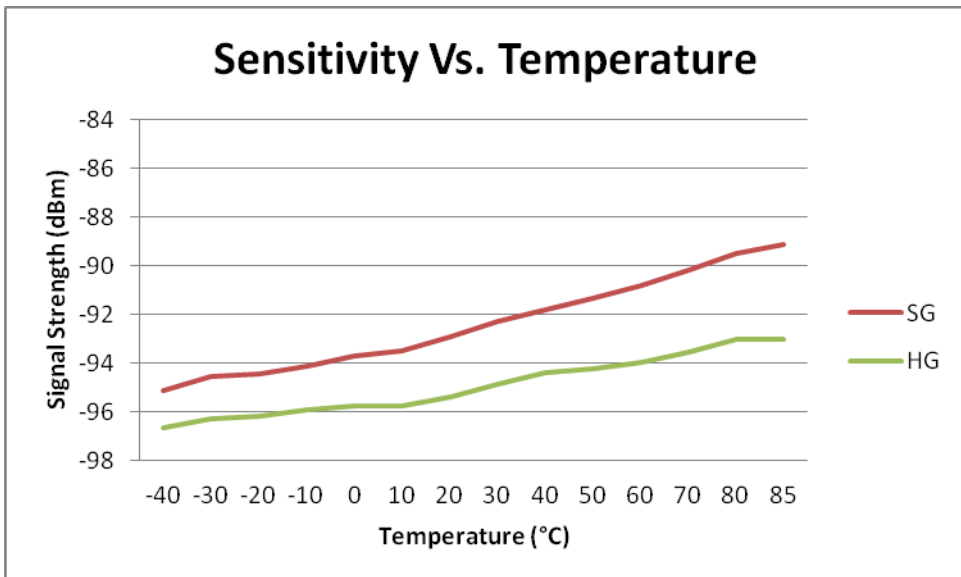

Figure 4.6 Sensitivity vs. Temperature

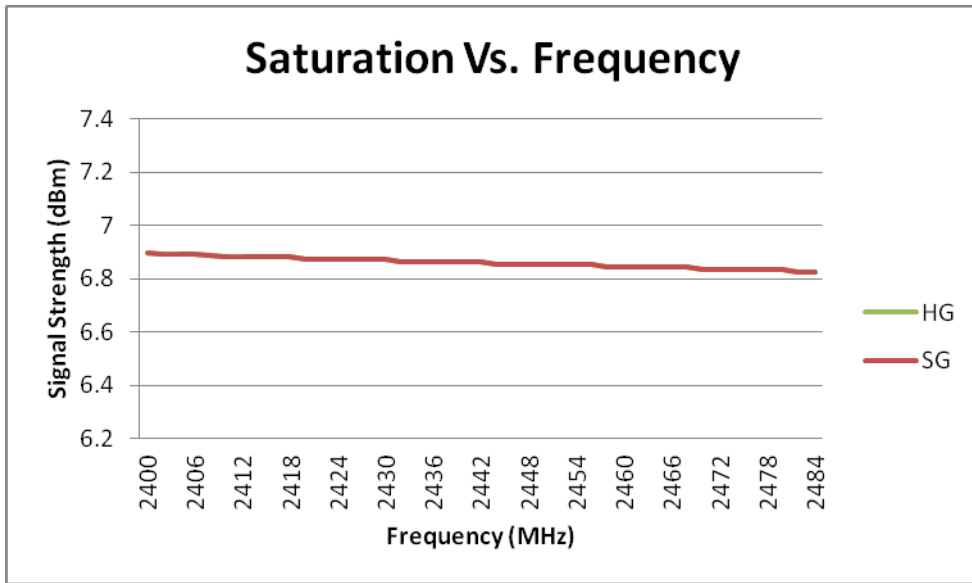

Figure 4.7 Saturation vs. Frequency

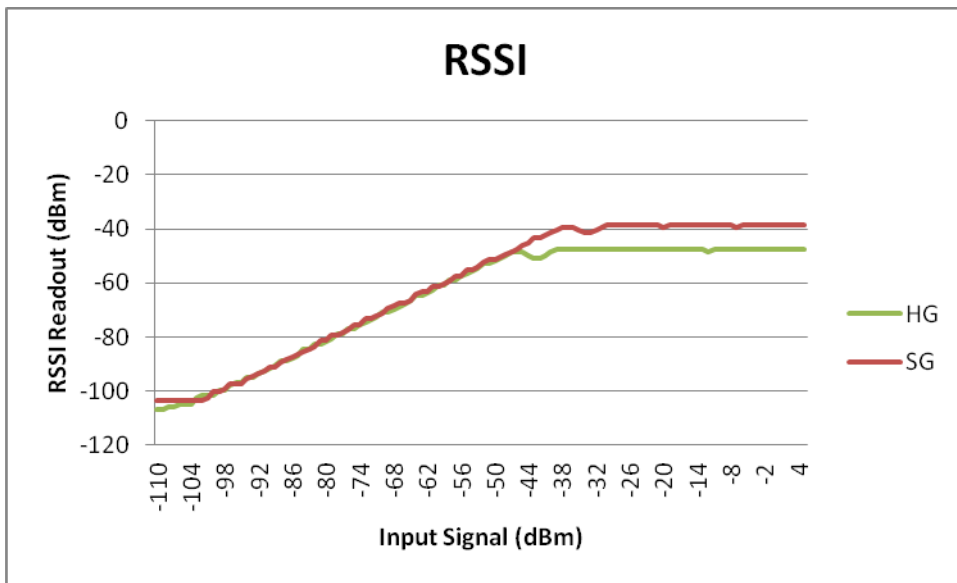

Figure 4.8 RSSI Readout vs. Input Power

5 Application Circuit

Only a few external components are required for the CC2541 - CC2590 reference design. A typical application circuit is shown below in Figure 5.1. Note that the application circuit figure does not show how the board layout should be done. The board layout will greatly influence the RF performance of the CC2541 - CC2590EM. TI provides a compact CC2541 - CC2590EM reference design[9]. It is highly recommended that the reference design provided be followed. The layout, stack-up and schematic for the CC2590 need to be copied exactly to obtain good performance. Note that the reference design also includes bill of materials with manufacturers and part numbers.

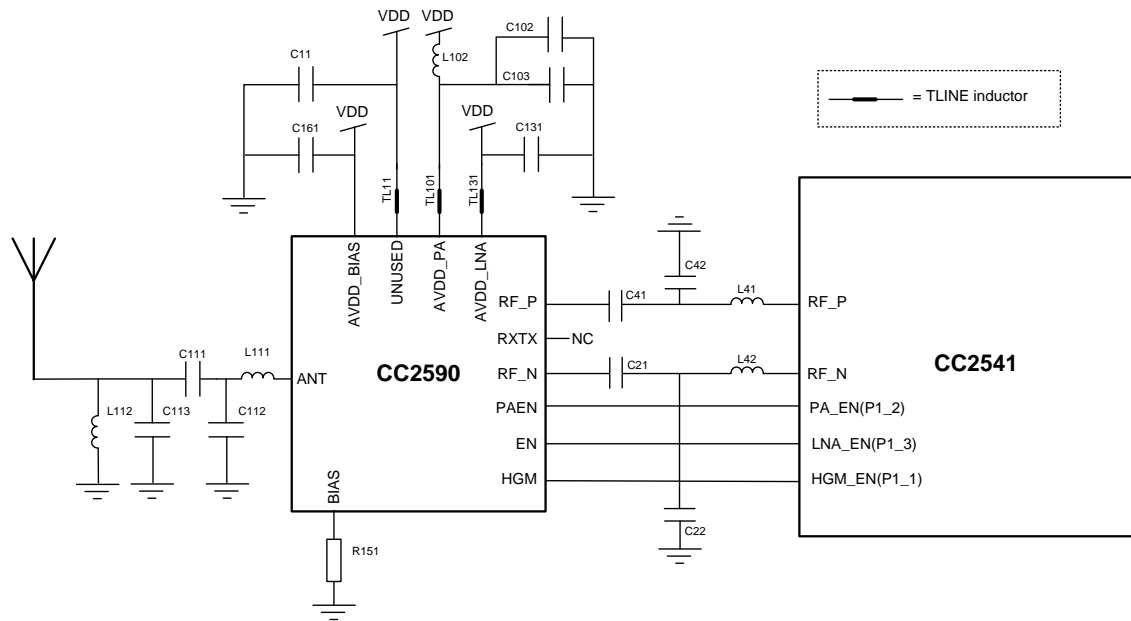

Figure 5.1 Application Circuit for the CC2541 with CC2590

5.1 Power Decoupling and RF Loading

Proper power supply decoupling must be used for optimum performance. In Figure 5.1, only the decoupling components for the CC2590 are shown. This is because, in addition to decoupling, the parallel capacitors C11, C101, C102, C103 and C131 together with, L102, TL11, TL101 and TL131 also work as RF loads. These therefore ensure the optimal performance from the CC2590. C161 decouples the AVDD_BIAS power.

The placement and size of the decoupling components, the power supply filtering and the PCB transmission lines are very important to achieve the best performance. Details about the importance of copying the CC2541 - CC2590EM reference design exactly and potential consequences of changes are explained in chapter 6.

5.2 Input/ Output Matching and Filtering

The RF input/output of CC2541 is differential complex impedance. The CC2590 includes a balun and a matching network in addition to the PA, LNA and RF switches which makes the interface to the CC2541 seamless. Only a few components between the CC2541 and CC2590 are necessary for RF matching.

Application Note AN120

Note that the PCB transmission lines that connect the two devices also are part of the RF matching. It is therefore important to copy the distance between the devices, the transmission lines and the stack-up of the PCB according to the reference design to ensure optimum performance.

The network between the CC2590 and the antenna (L111, L112, C112, C111 and C113) matches the CC2590 to a 50 Ω load and provides filtering to facilitate meeting regulatory requirements. C111 also works as a DC-block.

5.3 Bias resistor

R151 is a bias resistor. The bias resistor is used to set an accurate bias current for internal use in the CC2590.

5.4 Antenna Considerations

The TI reference design contains two antenna options. As default, the SMA connector is connected to the output of CC2590 through a 0 Ω resistor. This resistor can be desoldered and rotated 90° clockwise in order to connect to the PCB antenna, which is a planar inverted F antenna (PIFA). Note that all testing and characterization has been done using the SMA connector. The PCB antenna has only been functionally tested by establishing a link between two EMs. Please refer to the antenna selection guide [5] and the Inverted F antenna design note [6] for further details on the antenna solutions.

6 PCB Layout Considerations

The Texas Instruments reference design uses a 1.6 mm (0.062") 4-layer PCB solution. Note that the different layers have different thickness; it is important to follow the recommendation given in the CC2541 - CC2590EM reference design [9] to ensure optimum performance.

The top layer is used for components and signal routing, and the open areas are filled with metallization connected to ground using several vias. The areas under the two chips are used for grounding and must be well connected to the ground plane with multiple vias. Footprint recommendation for the CC2590 is given in the CC2590 datasheet [4].

Layer two is a complete ground plane and is not used for any routing. This is done to ensure short return current paths. The low impedance of the ground plane prevents any unwanted signal coupling between any of the nodes that are decoupled to it. Layer three is a power plane. The power plane ensures low impedance traces at radio frequencies and prevents unwanted radiation from power traces. Layer four is used for routing, and as with layer one, open areas are filled with metallization connected to ground using several vias.

6.1 The Gain of the CC2590

Changing the layout or the stack-up of the reference design [9] affects the gain of the CC2590. This is because the gain of the CC2590 can be viewed as a function of both the on-chip impedance and the external impedance contributions. Internal on-chip routing and capacitance, bond wires (often several in parallel), the PCB transmission lines, the thermal reliefs on the decoupling capacitors' ground nodes, capacitance and parasitics of the decoupling capacitors, the inductance of the vias to the ground plane and the soldering of the chip will therefore contribute to the actual performance of the CC2590. A simplified model of all of these contributions is shown in Figure 6.1.

Due to all the contributors to the CC2590 performance, several observations can be made on how changing layout and PCB stack-up affects the amplifier:

- Misplacing the decoupling capacitor or using an arbitrary capacitor will change the inductance, and hence move the resonance frequency of the amplifier, i.e. the frequency with maximum gain.
- Bad soldering of the ground paddle can reduce the gain significantly.
- Too few or too long vias will reduce the gain significantly. This is why a checkered pattern of vias/ solder paste and a 4-layer PCB with the ground plane close to the top layer has been chosen for the CC2541 - CC2590EM reference design.

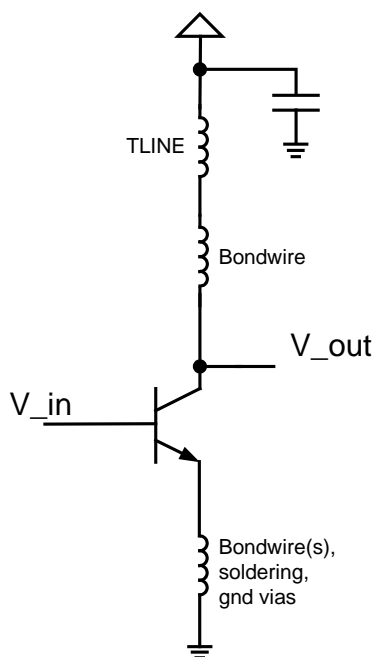

Figure 6.1 Simplified Model of the Impedance Contributors in the CC2590 Design

7 Regulatory Requirements

In the United States, the Federal Communications Commission (FCC) is responsible for the regulation of all RF devices. CFR 47, Part 15, regulates RF products intended for unlicensed operation. A product intended for unlicensed operation has to be subject to compliance testing. If the product is approved, the FCC will issue an identification number.

The specific frequency bands used for unlicensed radio equipment for the 2.4 GHz band are regulated by section 15.247 and 15.249. General rules for certification measurements are found in section 15.35. Restricted bands and general limits for spurious emissions are found in sections 15.205 and 15.209.

The CC2541 - CC2590EM reference design [9] has been tested for compliance with FCC Part 15.247. While it is not a formal certification, it does give a good representation of emissions with respect to compliance requirements. The FCC Part 15.247 compliance is generally a tougher requirement than ETSI compliance (EN 300 328) due to the restricted bands of operation. There are however requirements with regards to ETSI compliance (EN 300 328) that prevents operation at maximum output power. The clause 4.3.2.2 Maximum Power Spectral Density requirement of EN 300 328 requires maximum +10 dBm/ 1 MHz. The final output power level will depend on the antenna used.

BLE requires that the max power emitted by the DUT not exceed +10dBm EIRP

FCC Part 15.247 limits the output power to 1 W or +30 dBm when Direct Sequence Spread Spectrum (DSSS) modulation or Frequency Hopping Spread Spectrum (FHSS) with at least 75 hop channels is used. The spectral density of digital modulation systems (not including FHSS) shall not exceed 8 dBm/ 3 kHz. The minimum 6 dB bandwidth of such systems is 500 kHz. Since the CC2541 is a *Bluetooth*® low energy compliant transceiver, FCC classifies the system, as a digitally modulated system. The +30 dBm limit therefore applies to the CC2541 with the CC2590 combination.

When complying with Part 15.247, in any 100 kHz bandwidth outside the operating band, the power level shall be at least 20 dB below the level in the 100 kHz bandwidth with the highest power level in the operating band. Attenuation below limits given in 15.209 is not required. Emission that fall within restricted bands (15.205) must meet general limits given in 15.209. This is summarized in Table 7.1 below. More details about the 2.4 GHz FCC regulations are found in application note AN032 [7].

Standard	Relevant Frequency	Radiated Power (EIRP)	Conducted Power	Comment
FCC 15.247	2400 – 2483.5 MHz		+10 dBm ¹ (+30dBm) ²	Maximum 6 dBi antenna gain
	Restricted bands defined by 15.205, including the 2 nd , 3 rd and 5 th harmonics	-41.2 dBm		
	All frequencies not covered in above cells		-20 dBc	

Table 7.1 Summarized FCC 15.247 Regulations for the 2.4 GHz Band

¹ BLE limits the output power to +10dBm

² FCC Part 15.247 limits the output power to 1 W or +30 dBm

7.1 Duty Cycling when Complying with FCC

For frequencies above 1 GHz, the field strength limits are based on average limits. When using an averaging detector, a minimum bandwidth of 1 MHz shall be employed and the measurement time shall not exceed 100 ms.

Due to the averaging detector, pulsed transmissions are allowed higher peak fundamental, harmonic, and spurious power. This is a benefit for duty-cycled transmissions. The relaxation factor is $20 \log(\text{TX on-time}/100 \text{ ms})$ [dB]. A 50 % duty cycle will therefore allow for 6 dB higher peak emission than without duty cycling. Notice however that, even when an averaging detector is called for, there is still a limit on emissions measured using a peak detector function with a limit 20 dB above the average limit.

7.2 Compliance of FCC Part 15.247 when using the CC2541 with the CC2590

When using CC2541 with the CC2590, duty cycling or back-off is only needed for highest frequency (2.48GHz) to comply with FCC at maximum recommended output power (TXPOWER = 0xE1). Table 7.2 below shows the duty cycling or back-off needed to comply with the FCC Part 15.247 limits at typical conditions ($T_C = 25^\circ\text{C}$, $V_{DD} = 3.0 \text{ V}$, TXPOWER = 0xE1). *Bluetooth*® low energy systems are however typically low duty cycle systems. Note that the numbers in Table 7.2 are based on conducted emission measurements from the CC2541 - CC2590EM reference design [9]. The real required duty cycling or back-off may be different for applications with different antennas, plastic covers, or other factors that amplify/ attenuate the radiated power.

Figure 7.1 below shows the level of the conducted spurious emission and margins to the FCC Part 15.247 limits for the *Bluetooth*® low energy channels under typical conditions ($T_C = 25^\circ\text{C}$, $V_{DD} = 3.0 \text{ V}$) when transmitting at maximum recommended power (TXPOWER = 0xE1) using the CC2541 - CC2590EM [9]. Figure 7.2 and Figure 7.3 show the margins versus the FCC 15.247 for the lowest frequency channels at the lower band edge and for the upper frequency channels at the upper band edge respectively. At the band edge the FCC allows for a Marker-delta method measurement [8] to determine the amount of back off or duty cycle needed to comply with the FCC Part 15.247. With Marker-delta method the field strength of the in-band fundamental frequency is subtracted from the difference between the highest fundamental emission level measured with a lower reference bandwidth and the emission level at the band edge, as shown in Figure 7.3.

Application Note AN120

BLE Channel	Frequency [MHz]	Back-Off [dB]	Duty Cycle
37	2402	20	10%
0	2404	0	100%
1	2406	0	100%
2	2408	0	100%
3	2410	0	100%
4	2412	0	100%
5	2414	0	100%
6	2416	0	100%
7	2418	0	100%
8	2420	0	100%
9	2422	0	100%
10	2424	0	100%
38	2426	0	100%
11	2428	0	100%
12	2430	0	100%
13	2432	0	100%
14	2434	0	100%
15	2436	0	100%
16	2438	0	100%
17	2440	0	100%
18	2442	0	100%
19	2444	0	100%
20	2446	0	100%
21	2448	0	100%
22	2450	0	100%
23	2452	0	100%
24	2454	0	100%
25	2456	0	100%
26	2458	0	100%
27	2460	0	100%
28	2462	0	100%
29	2464	0	100%
30	2466	0	100%
31	2468	0	100%
32	2470	0	100%
33	2472	0	100%
34	2474	0	100%
35	2476	0	100%
36	2478	0	100%
39	2480	20	10%

Table 7.2 Duty-Cycle or Back-Off Requirement for FCC Part 15.247 Compliance under Typical Conditions

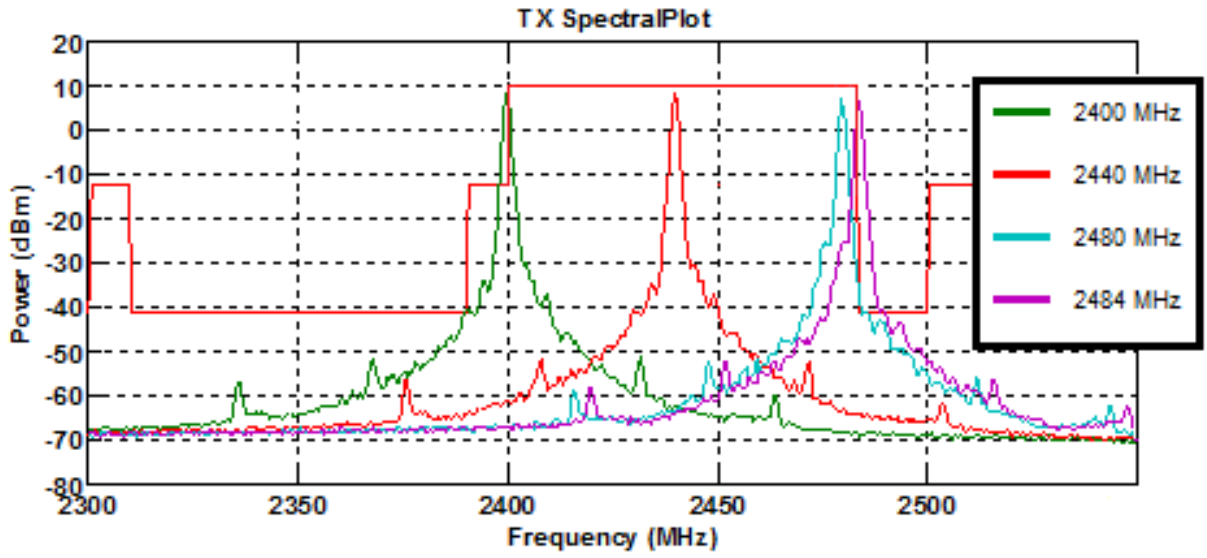

Figure 7.1 Conducted Spurious Emission vs. FCC Part 15.247 Limit
(TXPOWER = 0xE1, RBW = 1 MHz, VBW = 1 MHz)

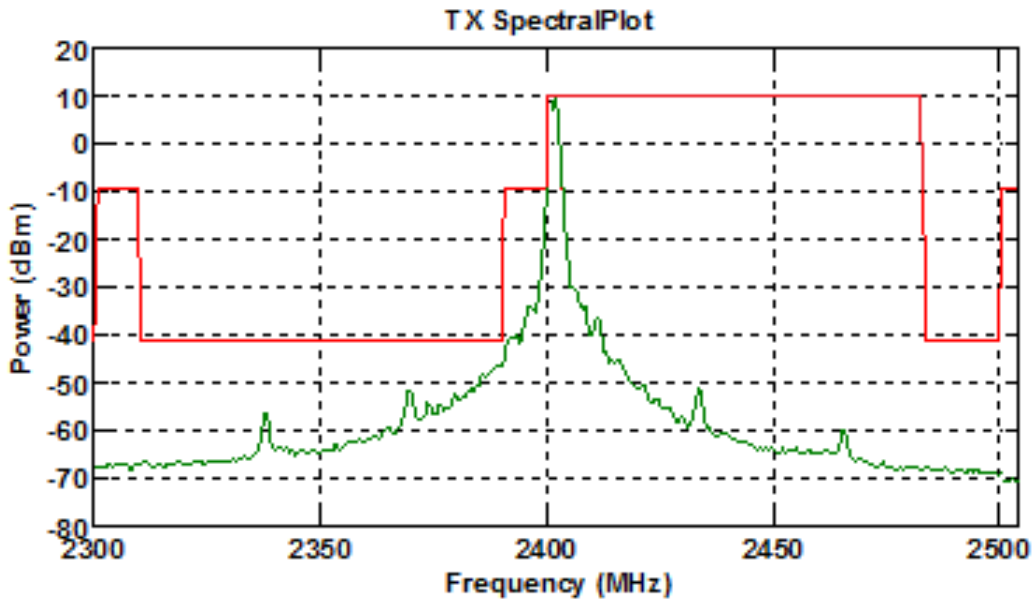

Figure 7.2 Conducted Spurious Emission, Lower Band Edge
(TXPOWER = 0xE1, RBW = 1 MHz, VBW = 1 MHz)

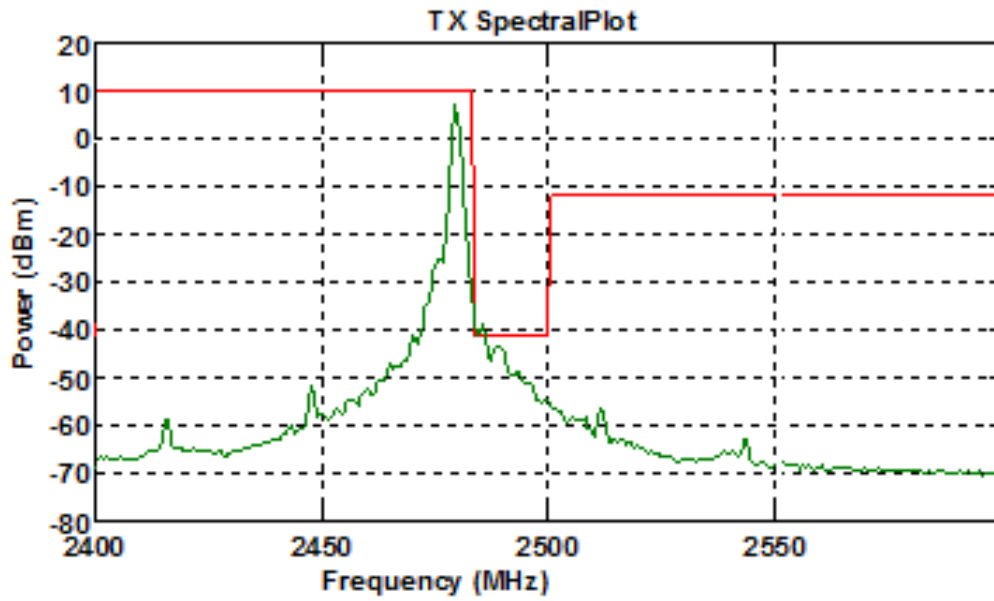

Figure 7.3 Conducted Spurious Emission, Upper Band Edge
(TXPOWER = 0xE1, RBW = 1 MHz, VBW = 1 MHz)

8 Controlling the CC2590

There are four digital control pins (PAEN, EN, HGM, and RXTX) on the CC2590 control the state the chip is in. Table 8.1 below shows the control logic when connecting the CC2590 to a CC2541 device.

PAEN	EN	RXTX	HGM	Mode of Operation
0	0	NC	X	Power Down
0	1	NC	0	RX LGM
0	1	NC	1	RX HGM
1	0	NC	X	TX
1	1	NC	X	Not allowed

Table 8.1 Control Logic for Connecting the CC2590 to a CC2541 Device

The CC2541 – CC2590EM reference design from TI uses three of the CC2541 GPIO pins on the CC2541 to control the CC2590. The I/O pins used is shown in Figure 8.1.

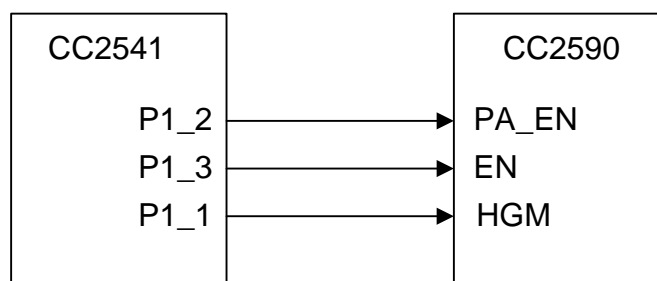

Figure 8.1 CC2541-CC2590 Interconnect

When using the configuration used in the CC2541 – CC2590EM reference design, the registers listed in Table 8.2 need to be changed from the recommended CC2541 settings to control the CC2590 and give optimum performance. The new recommended values are listed in Table 8.2.

CC2541 REGISTER	ADDRESS	RECOMMENDED VALUE
RFC_OBS_CTRL0	0x61EB	0x68
RFC_OBS_CTRL1	0x61EC	0x6A
TXPOWER	0x6186	See Table 4.6
OBSSEL1	0x6244	0xFB
OBSSEL3	0x6247	0xFC
P1DIR	0xFD	0x02

Table 8.2 New Recommended Register Settings for the CC2541 - CC2590 combination

The TI BLE software stack supports CC2590 and the automatic control is enabled by the use of **HCI_EXT_ExtendRFRangeCmd**. This command is used to configure the CC254x to automatically control the CC2590. Once this command is used, the configuration will not change unless the CC254x is reset. The software stack uses specific pins which cannot be modified. The I/O pins are shown in Figure 8.1.

For more information on the automatic control please refer to the *TI BLE HCI Vendor Specific HCI Guide*, which is included in the stack installer found at www.ti.com/ble-stack.

All the recommended register CC2541 settings when including the CC2590 are automatically implemented in SmartRF Studio when checking the Range Extender box. SmartRF Studio is available on the TI website www.ti.com.

9 References

- [1] CC2541 Datasheet (<http://www.ti.com/lit/pdf/SWRS110>)
- [2] CC2540 Datasheet (<http://www.ti.com/lit/pdf/SWRS084>)
- [3] CC253x/4x User Guide (<http://www.ti.com/lit/SWRU191>)
- [4] CC2590 Datasheet (<http://www.ti.com/lit/pdf/SWRS080>)
- [5] AN058 Antenna Selection Guide (<http://www.ti.com/lit/SWRA161>)
- [6] DN007 2.4 GHz Inverted F Antenna (<http://www.ti.com/lit/SWRU120>)
- [7] AN032 SRD Regulations for License-free Transceiver Operation in the 2.4 GHz Band (<http://www.ti.com/lit/SWRA060>)
- [8] DA 00-705
(http://www.fcc.gov/Bureaus/Engineering_Technology/Public_Notices/2000/da00705.doc)
- [9] CC2541 – CC2590EM Reference Design (<http://www.ti.com/lit/zip/SWRR116>)
- [10] Titanis 2.4GHz Antenna (<http://www.antenova.com/Product%20Specs/AE030054-I-Product-Specification-Titanis.pdf>)

10 General Information

10.1 Document History

Revision	Date	Description/Changes
SWRA422	2013.03.13	Initial release.

IMPORTANT NOTICE

Texas Instruments Incorporated and its subsidiaries (TI) reserve the right to make corrections, enhancements, improvements and other changes to its semiconductor products and services per JESD46, latest issue, and to discontinue any product or service per JESD48, latest issue. Buyers should obtain the latest relevant information before placing orders and should verify that such information is current and complete. All semiconductor products (also referred to herein as "components") are sold subject to TI's terms and conditions of sale supplied at the time of order acknowledgment.

TI warrants performance of its components to the specifications applicable at the time of sale, in accordance with the warranty in TI's terms and conditions of sale of semiconductor products. Testing and other quality control techniques are used to the extent TI deems necessary to support this warranty. Except where mandated by applicable law, testing of all parameters of each component is not necessarily performed.

TI assumes no liability for applications assistance or the design of Buyers' products. Buyers are responsible for their products and applications using TI components. To minimize the risks associated with Buyers' products and applications, Buyers should provide adequate design and operating safeguards.

TI does not warrant or represent that any license, either express or implied, is granted under any patent right, copyright, mask work right, or other intellectual property right relating to any combination, machine, or process in which TI components or services are used. Information published by TI regarding third-party products or services does not constitute a license to use such products or services or a warranty or endorsement thereof. Use of such information may require a license from a third party under the patents or other intellectual property of the third party, or a license from TI under the patents or other intellectual property of TI.

Reproduction of significant portions of TI information in TI data books or data sheets is permissible only if reproduction is without alteration and is accompanied by all associated warranties, conditions, limitations, and notices. TI is not responsible or liable for such altered documentation. Information of third parties may be subject to additional restrictions.

Resale of TI components or services with statements different from or beyond the parameters stated by TI for that component or service voids all express and any implied warranties for the associated TI component or service and is an unfair and deceptive business practice. TI is not responsible or liable for any such statements.

Buyer acknowledges and agrees that it is solely responsible for compliance with all legal, regulatory and safety-related requirements concerning its products, and any use of TI components in its applications, notwithstanding any applications-related information or support that may be provided by TI. Buyer represents and agrees that it has all the necessary expertise to create and implement safeguards which anticipate dangerous consequences of failures, monitor failures and their consequences, lessen the likelihood of failures that might cause harm and take appropriate remedial actions. Buyer will fully indemnify TI and its representatives against any damages arising out of the use of any TI components in safety-critical applications.

In some cases, TI components may be promoted specifically to facilitate safety-related applications. With such components, TI's goal is to help enable customers to design and create their own end-product solutions that meet applicable functional safety standards and requirements. Nonetheless, such components are subject to these terms.

No TI components are authorized for use in FDA Class III (or similar life-critical medical equipment) unless authorized officers of the parties have executed a special agreement specifically governing such use.

Only those TI components which TI has specifically designated as military grade or "enhanced plastic" are designed and intended for use in military/aerospace applications or environments. Buyer acknowledges and agrees that any military or aerospace use of TI components which have **not** been so designated is solely at the Buyer's risk, and that Buyer is solely responsible for compliance with all legal and regulatory requirements in connection with such use.

TI has specifically designated certain components as meeting ISO/TS16949 requirements, mainly for automotive use. In any case of use of non-designated products, TI will not be responsible for any failure to meet ISO/TS16949.

Products

Audio	www.ti.com/audio
Amplifiers	amplifier.ti.com
Data Converters	dataconverter.ti.com
DLP® Products	www.dlp.com
DSP	dsp.ti.com
Clocks and Timers	www.ti.com/clocks
Interface	interface.ti.com
Logic	logic.ti.com
Power Mgmt	power.ti.com
Microcontrollers	microcontroller.ti.com
RFID	www.ti-rfid.com
OMAP Applications Processors	www.ti.com/omap
Wireless Connectivity	www.ti.com/wirelessconnectivity

Applications

Automotive and Transportation	www.ti.com/automotive
Communications and Telecom	www.ti.com/communications
Computers and Peripherals	www.ti.com/computers
Consumer Electronics	www.ti.com/consumer-apps
Energy and Lighting	www.ti.com/energy
Industrial	www.ti.com/industrial
Medical	www.ti.com/medical
Security	www.ti.com/security
Space, Avionics and Defense	www.ti.com/space-avionics-defense
Video and Imaging	www.ti.com/video

TI E2E Community

e2e.ti.com