

## SINGLE-ENDED ANALOG-INPUT 16-BIT STEREO ANALOG-TO-DIGITAL CONVERTER

### FEATURES

- Dual 16-Bit Monolithic  $\Delta\Sigma$  ADC
- Single-Ended Voltage Input
- Antialiasing Filter Included
- **64× Oversampling Decimation Filter:**  
Pass-Band Ripple:  $\pm 0.05$  dB  
Stop-Band Attenuation:  $-65$  dB
- **Analog Performance:**  
THD+N:  $-88$  dB (typical)  
SNR: 93 dB (typical)  
Dynamic Range: 93 dB (typical)  
Internal High-Pass Filter
- **PCM Audio Interface:** Left-Justified,  $1^2S$
- **Sampling Rate:** 4 kHz to 48 kHz
- **System Clock:** 256  $f_s$ , 384  $f_s$ , or 512  $f_s$
- **Single 5-V Power Supply**
- **Small SO-14 Package**

### APPLICATIONS

- DVD Recorders
- DVD Receivers
- AV Amplifier Receivers
- Electric Musical Instruments

### DESCRIPTION

The PCM1801 is a low-cost, single-chip stereo analog-to-digital converter (ADC) with single-ended analog voltage inputs. The PCM1801 uses a delta-sigma modulator with 64 times oversampling, a digital decimation filter, and a serial interface that supports slave mode operation and two data formats. The PCM1801 is suitable for a wide variety of cost-sensitive consumer applications where good performance is required.

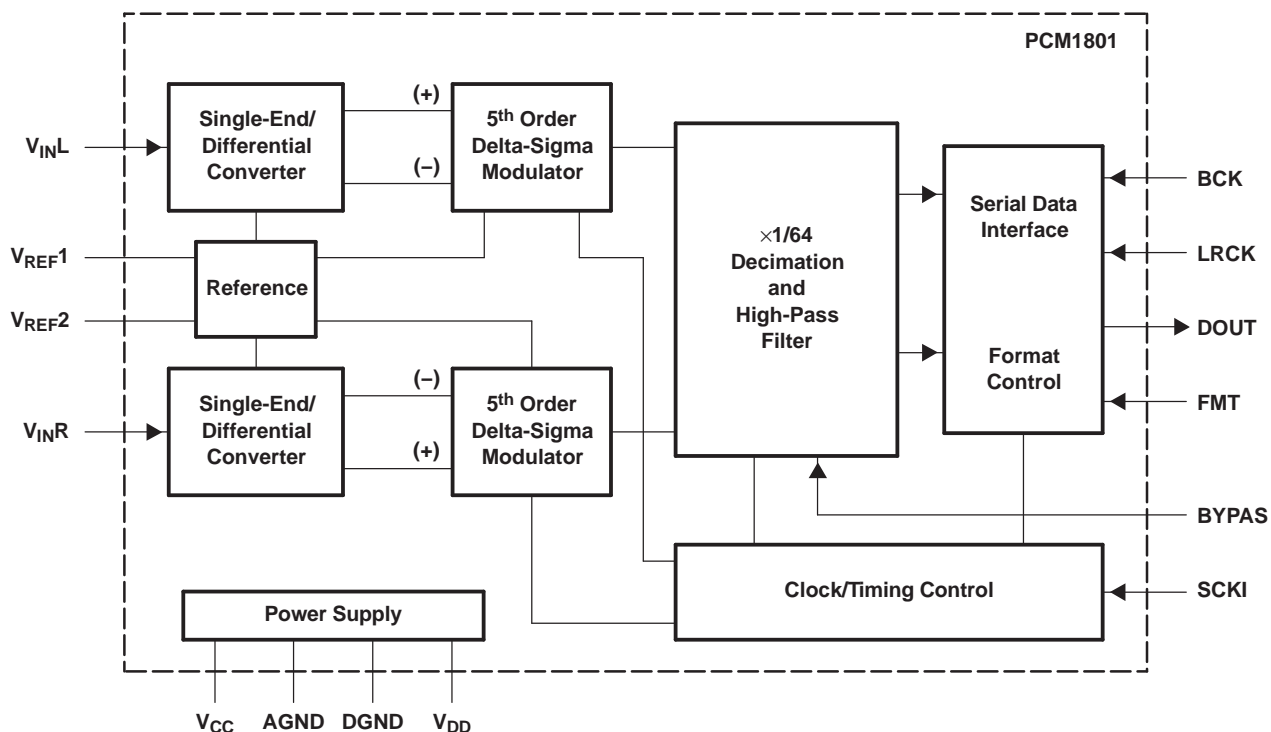

B0004-02



Please be aware that an important notice concerning availability, standard warranty, and use in critical applications of Texas Instruments semiconductor products and disclaimers thereto appears at the end of this data sheet.

System Two, Audio Precision are trademarks of Audio Precision, Inc.  
All other trademarks are the property of their respective owners.



This integrated circuit can be damaged by ESD. Texas Instruments recommends that all integrated circuits be handled with appropriate precautions. Failure to observe proper handling and installation procedures can cause damage.

ESD damage can range from subtle performance degradation to complete device failure. Precision integrated circuits may be more susceptible to damage because very small parametric changes could cause the device not to meet its published specifications.

### PACKAGE/ORDERING INFORMATION

PRODUCT	PACKAGE TYPE	PACKAGE CODE	PACKAGE MARKING	ORDERING NUMBER	TRANSPORT MEDIA	QUANTITY
PCM1801U	14-pin SOIC	D	PCM1801U	PCM1801U	Rails	56
				PCM1801U/2K	Tape and reel	2000

### ABSOLUTE MAXIMUM RATINGS

Supply voltage: $V_{DD}$ , $V_{CC}$	–0.3 V to 6.5 V
Supply voltage differences: $V_{DD}$ , $V_{CC}$	±0.1 V
GND voltage differences: AGND, DGND	±0.1 V
Digital input voltage	–0.3 V to ( $V_{DD} + 0.3$ V), < 6.5 V
Analog input voltage	–0.3 V to ( $V_{CC} + 0.3$ V), < 6.5 V
Input current (any pin except supplies)	±10 mA
Power dissipation	300 mW
Operating temperature range	–25°C to 85°C
Storage temperature	–55°C to 125°C
Lead temperature, soldering	260°C, 5 s
Package temperature (IR reflow, peak)	235°C

### RECOMMENDED OPERATING CONDITIONS

over operating free-air temperature range

		MIN	NOM	MAX	UNIT
Analog supply voltage, $V_{CC}$		4.5	5	5.5	V
Digital supply voltage, $V_{DD}$		4.5	5	5.5	V
Analog input voltage, full-scale (–0 dB)		2.828			Vp-p
Digital input logic family		TTL			
Digital input clock frequency	System clock	8.192	24.576		MHz
	Sampling clock	32	48		kHz
Digital output load capacitance		10			pF
Operating free-air temperature, $T_A$		–25	85		°C

**PIN CONFIGURATION**

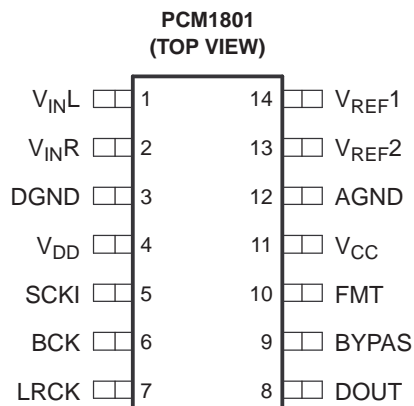

P0005-01

**Table 1. PIN ASSIGNMENTS**

NAME	PIN	I/O	DESCRIPTION
AGND	12	–	Analog ground
BCK	6	I	Bit clock input
BYPAS	9	I	HPF bypass control <sup>(1)</sup> L: HPF enabled H: HPF disabled
DGND	3	–	Digital ground
DOUT	8	O	Audio data output
FMT	10	I	Audio data format <sup>(1)</sup> L: MSB-first, left-justified H: MSB-first, I <sup>2</sup> S
LRCK	7	I	Sampling clock input
SCKI	5	I	System clock input; 256 f <sub>S</sub> , 384 f <sub>S</sub> , or 512 f <sub>S</sub>
V <sub>CC</sub>	11	–	Analog power supply
V <sub>DD</sub>	4	–	Digital power supply
V <sub>INL</sub>	1	I	Analog input, Lch
V <sub>INR</sub>	2	I	Analog input, Rch
V <sub>REF1</sub>	14	–	Reference 1 decoupling capacitor
V <sub>REF2</sub>	13	–	Reference 2 decoupling capacitor

(1) With 100-kΩ typical pulldown resistor

**ELECTRICAL CHARACTERISTICS**

All specifications at  $T_A = 25^\circ\text{C}$ ,  $V_{DD} = V_{CC} = 5\text{ V}$ ,  $f_S = 44.1\text{ kHz}$ , 16-bit data, and  $\text{SYSCLK} = 384 f_S$ , unless otherwise noted.

PARAMETER		TEST CONDITIONS	PCM1801U			UNITS
			MIN	TYP	MAX	
<b>RESOLUTION</b>			16			Bits
<b>DIGITAL INPUT/OUTPUT</b>						
$V_{IH}^{(1)}$	Input logic level		2			VDC
$V_{IL}^{(1)}$					0.8	
$I_{IN}^{(2)}$	Input logic current				$\pm 10$	$\mu\text{A}$
$I_{IN}^{(3)}$					100	
$V_{OH}^{(4)}$	Output logic level	$I_{OH} = -1.6\text{ mA}$	4.5			VDC
$V_{OL}^{(4)}$		$I_{OL} = 3.2\text{ mA}$			0.5	
$f_S$	Sampling frequency		4	44.1	48	kHz
	System clock frequency	$256 f_S$	1.024	11.2896	12.288	MHz
		$384 f_S$	1.536	16.9344	18.432	
		$512 f_S$	2.048	22.5792	24.576	
<b>DC ACCURACY</b>						
	Gain mismatch, channel-to-channel			$\pm 1$	$\pm 2.5$	% of FSR
	Gain error			$\pm 2$	$\pm 5$	% of FSR
	Gain drift			$\pm 20$		ppm of FSR/ $^\circ\text{C}$
	Bipolar zero error	High-pass filter bypassed		$\pm 2$		% of FSR
	Bipolar zero drift	High-pass filter bypassed		$\pm 20$		ppm of FSR/ $^\circ\text{C}$
<b>DYNAMIC PERFORMANCE<sup>(5)</sup></b>						
THD+N		FS ( $-0.5\text{ dB}$ )		$-88$	$-80$	dB
		$-60\text{ dB}$		$-90$		
Dynamic range		A-weighted	90	93		dB
Signal-to-noise ratio		A-weighted	90	93		dB
Channel separation			87	90		dB
<b>ANALOG INPUT</b>						
Input range		FS ( $V_{IN} = 0\text{ dB}$ )		2.828		Vp-p
Center voltage				2.1		V
Input impedance				30		k $\Omega$
Antialiasing filter frequency response		$-3\text{ dB}$		150		kHz
<b>DIGITAL FILTER PERFORMANCE</b>						
Pass band					$0.454 f_S$	Hz
Stop band			$0.583 f_S$			Hz
Pass-band ripple					$\pm 0.05$	dB
Stop-band attenuation			$-65$			dB
Delay time (latency)				$17.4/f_S$		s
High-pass frequency response		$-3\text{ dB}$		$0.019 f_S$		mHz

(1) Pins 5, 6, 7, 9, and 10 (SCKI, BCK, LRCK, BYPAS, and FMT)

(2) Pins 5, 6, 7 (SCKI, BCK, LRCK) Schmitt-trigger input

(3) Pins 9, 10 (BYPAS, FMT) Schmitt-trigger input with 100-k $\Omega$  typical pulldown resistor

(4) Pin 8 (DOUT)

(5)  $f_{IN} = 1\text{ kHz}$ , using the System Two™ audio measurement system by Audio Precision™ in rms mode with 20-kHz LPF and 400-Hz HPF in the performance calculation.

**ELECTRICAL CHARACTERISTICS (continued)**

All specifications at  $T_A = 25^\circ\text{C}$ ,  $V_{DD} = V_{CC} = 5\text{ V}$ ,  $f_S = 44.1\text{ kHz}$ , 16-bit data, and  $\text{SYSCLK} = 384 f_S$ , unless otherwise noted.

PARAMETER		TEST CONDITIONS	PCM1801U			UNITS
			MIN	TYP	MAX	
<b>POWER SUPPLY REQUIREMENTS</b>						
$V_{CC}$	Voltage range		4.5	5	5.5	VDC
$V_{DD}$			4.5	5	5.5	
	Supply current <sup>(6)</sup>	$V_{CC} = V_{DD} = 5\text{ V}$		18	24	mA
	Power dissipation	$V_{CC} = V_{DD} = 5\text{ V}$		90	120	mW
<b>TEMPERATURE RANGE</b>						
$T_A$	Operation		-25		85	$^\circ\text{C}$
$T_{stg}$	Storage		-55		125	$^\circ\text{C}$
$\theta_{JA}$	Thermal resistance			100		$^\circ\text{C/W}$

(6) No load on DOUT (pin 8)

**BLOCK DIAGRAM**

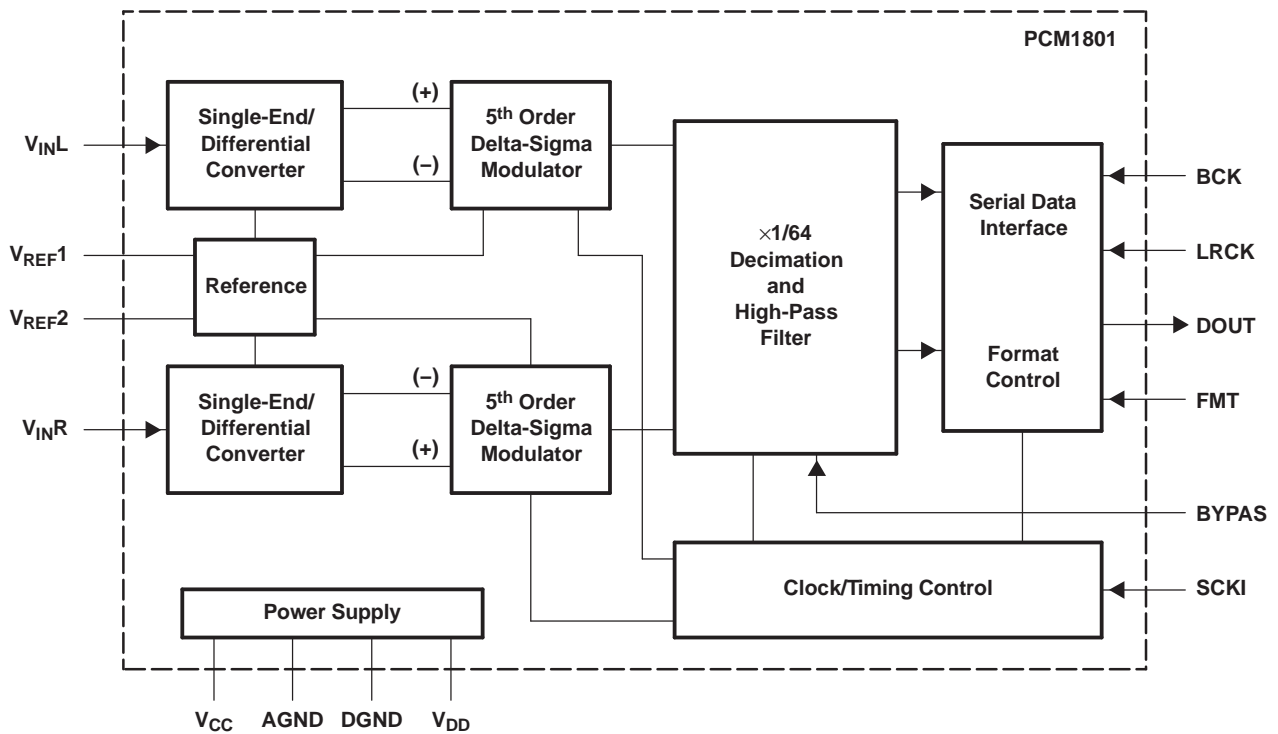

B0004-02

**ANALOG FRONT-END (Single Channel)**

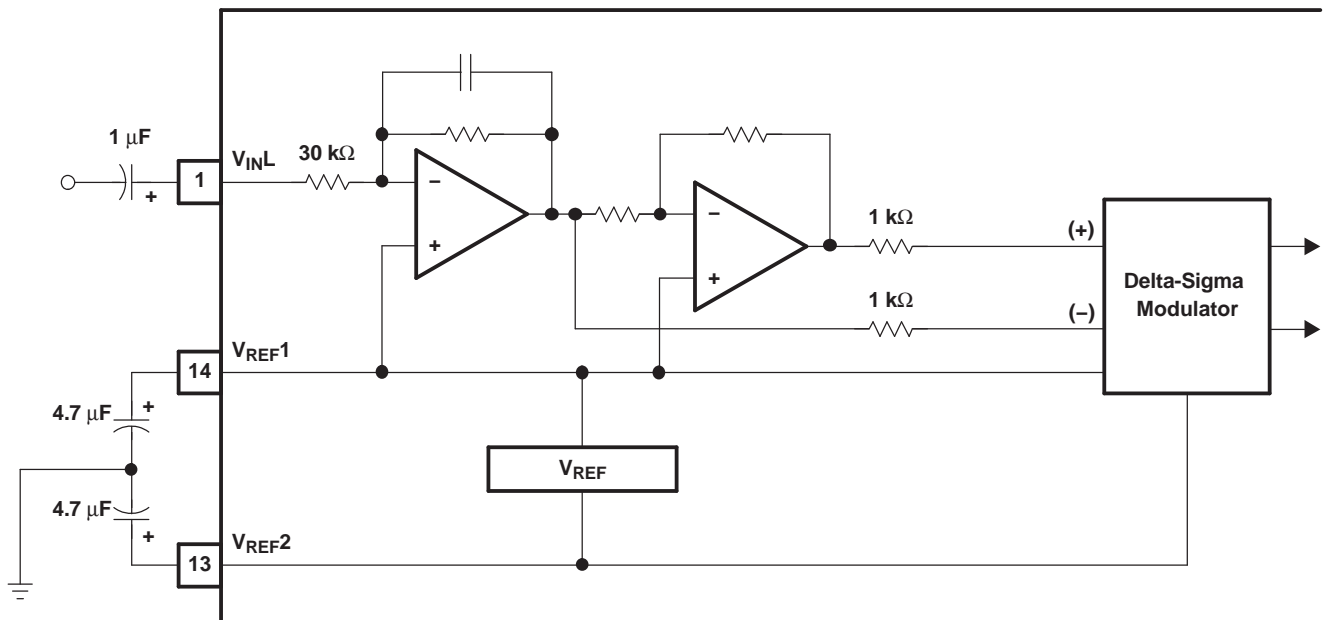

S0011-02

**TYPICAL PERFORMANCE CURVES**

All specifications at  $T_A = 25^\circ\text{C}$ ,  $V_{DD} = V_{CC} = 5\text{ V}$ ,  $f_S = 44.1\text{ kHz}$ , and  $\text{SYSCLK} = 384 f_S$ , unless otherwise noted

**ANALOG DYNAMIC PERFORMANCE**

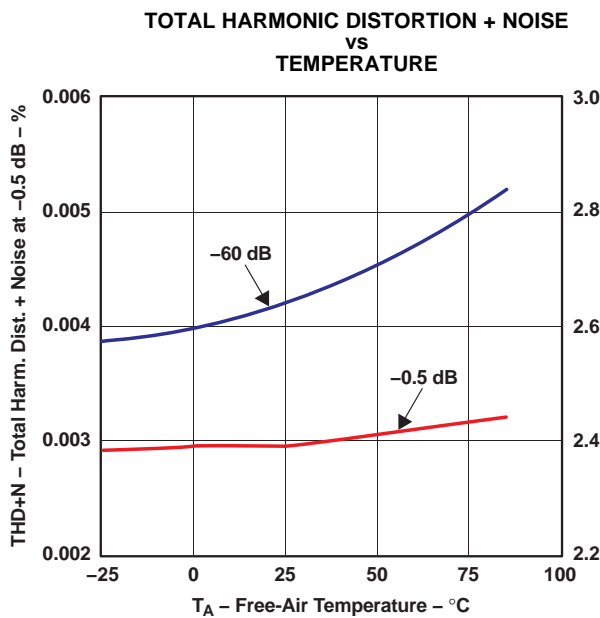

G001

Figure 1.

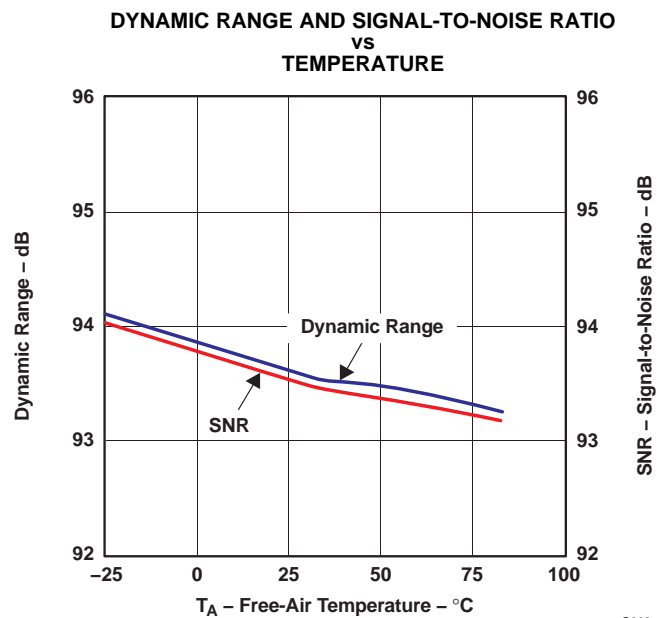

G002

Figure 2.

**TYPICAL PERFORMANCE CURVES (continued)**

All specifications at  $T_A = 25^\circ\text{C}$ ,  $V_{DD} = V_{CC} = 5\text{ V}$ ,  $f_S = 44.1\text{ kHz}$ , and  $\text{SYSCLK} = 384 f_S$ , unless otherwise noted

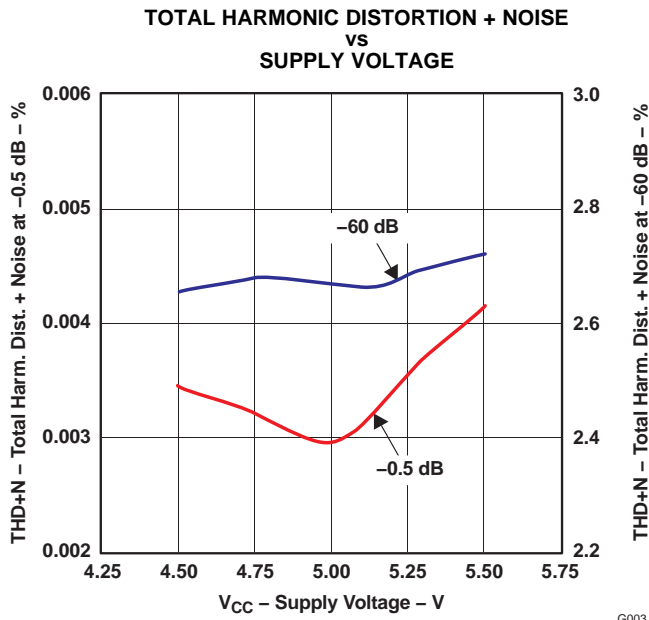

Figure 3.

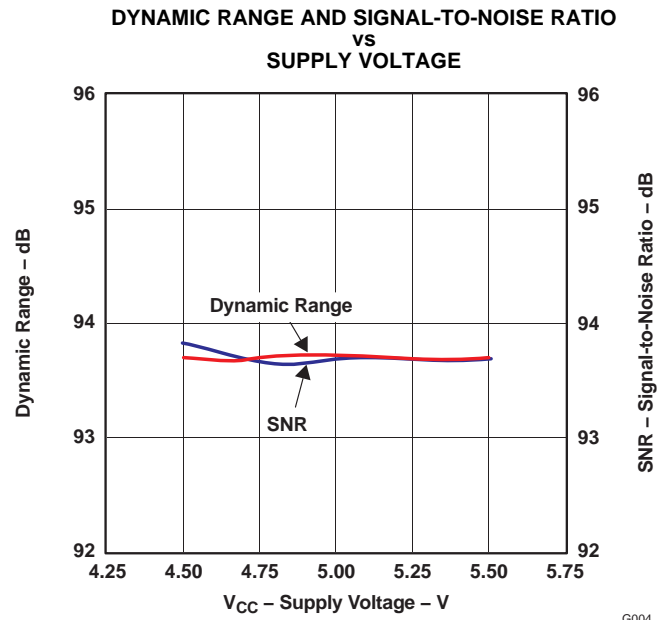

Figure 4.

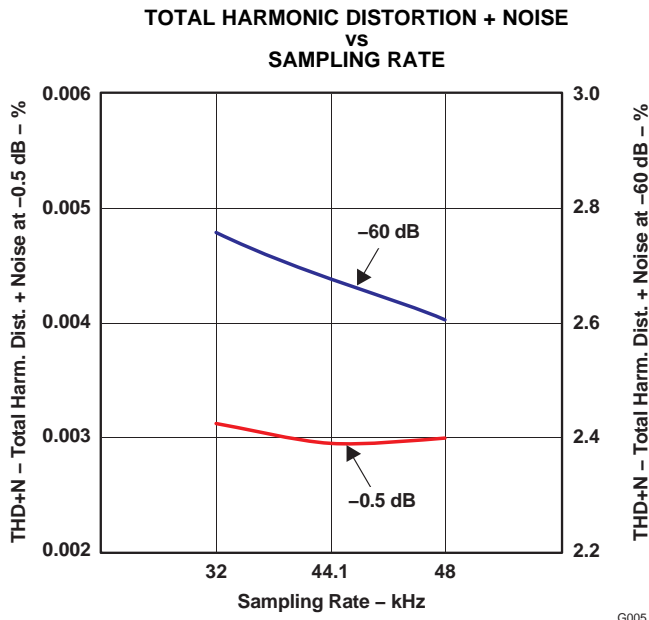

Figure 5.

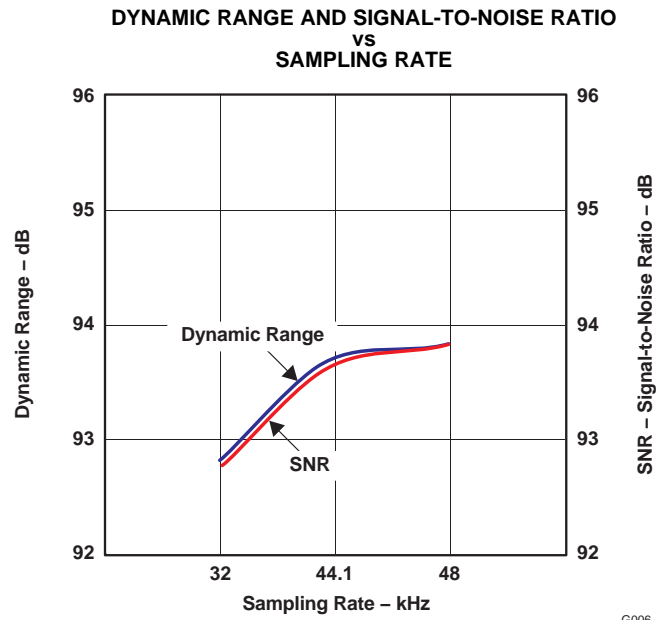

Figure 6.

**TYPICAL PERFORMANCE CURVES (continued)**

All specifications at  $T_A = 25^\circ\text{C}$ ,  $V_{DD} = V_{CC} = 5\text{ V}$ ,  $f_s = 44.1\text{ kHz}$ , and  $\text{SYSCLK} = 384\text{ f}_s$ , unless otherwise noted

**SUPPLY CURRENT**

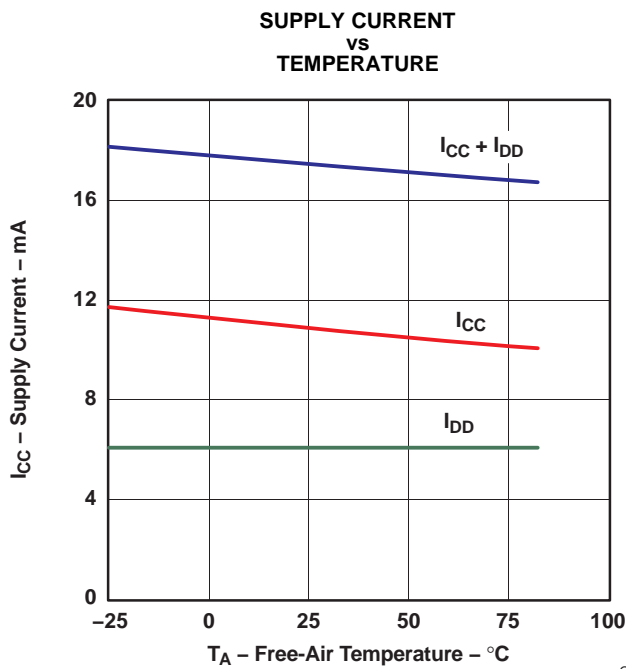

Figure 7.

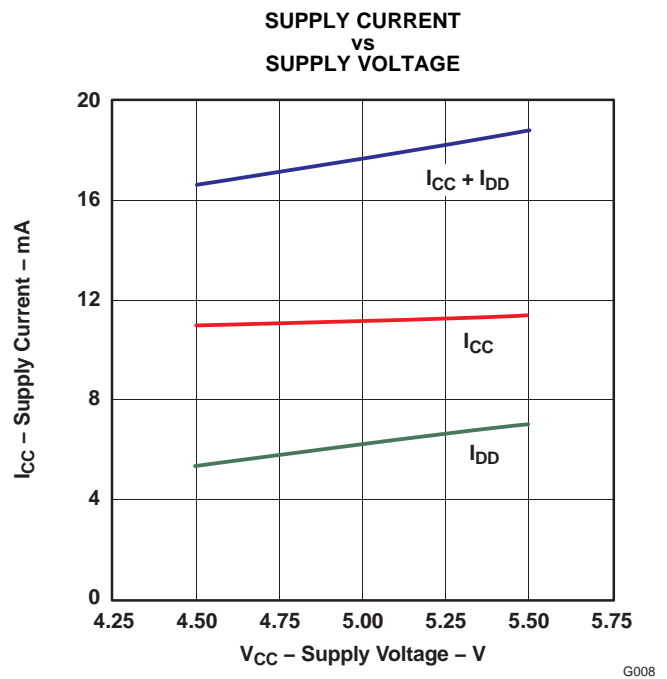

Figure 8.

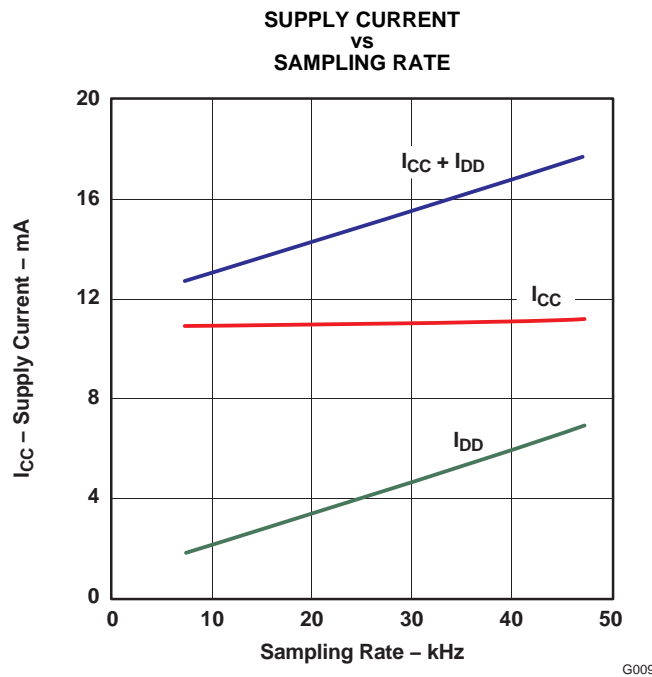

Figure 9.



**TYPICAL PERFORMANCE CURVES (continued)**

All specifications at  $T_A = 25^\circ\text{C}$ ,  $V_{DD} = V_{CC} = 5\text{ V}$ ,  $f_S = 44.1\text{ kHz}$ , and  $\text{SYSCLK} = 384 f_S$ , unless otherwise noted

**OUTPUT SPECTRUM**

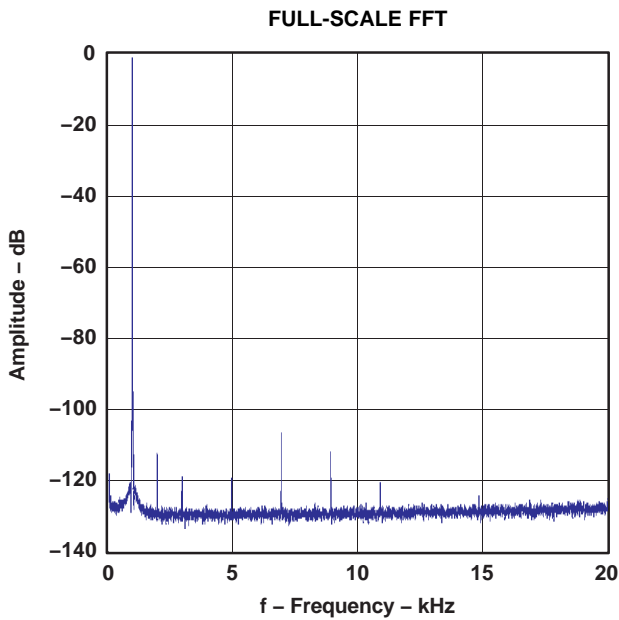

Figure 10.

G010

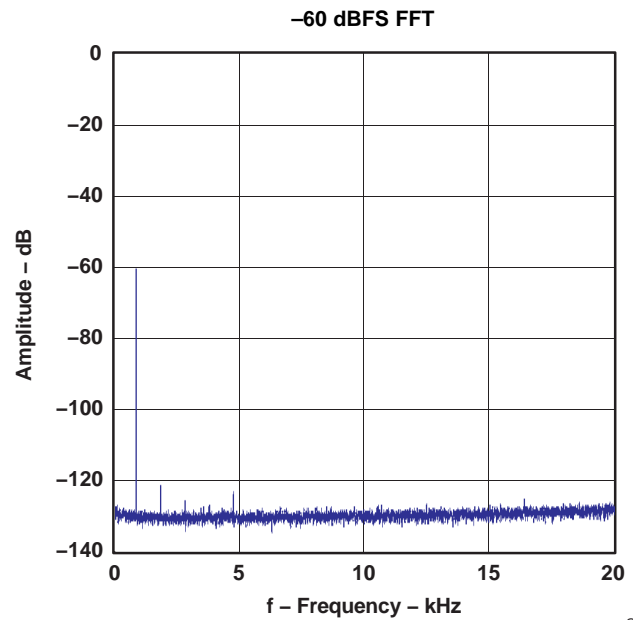

Figure 11.

G011

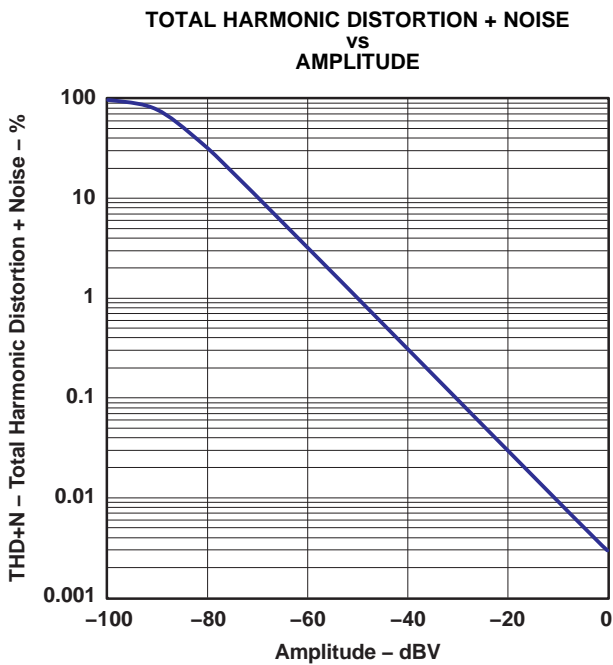

Figure 12.

G012

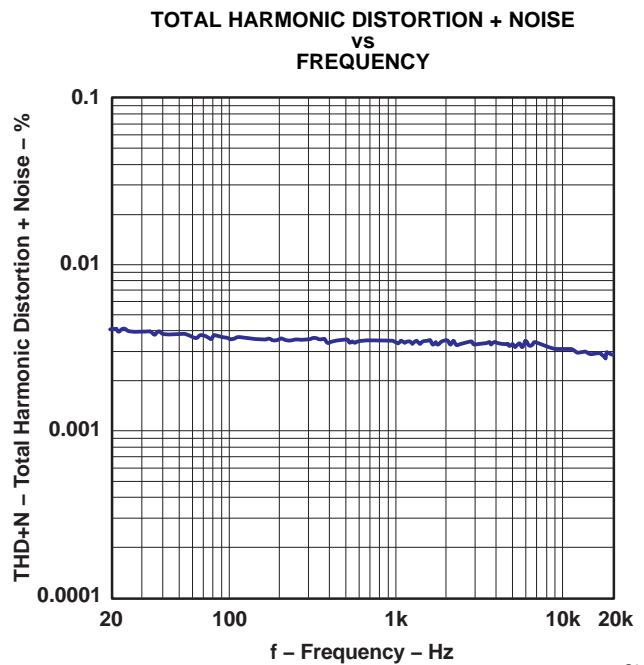

Figure 13.

G013

**TYPICAL PERFORMANCE CURVES (continued)**

All specifications at  $T_A = 25^\circ\text{C}$ ,  $V_{DD} = V_{CC} = 5\text{ V}$ ,  $f_S = 44.1\text{ kHz}$ , and  $\text{SYSCLK} = 384 f_S$ , unless otherwise noted

**DECIMATION FILTER**

**OVERALL CHARACTERISTICS**

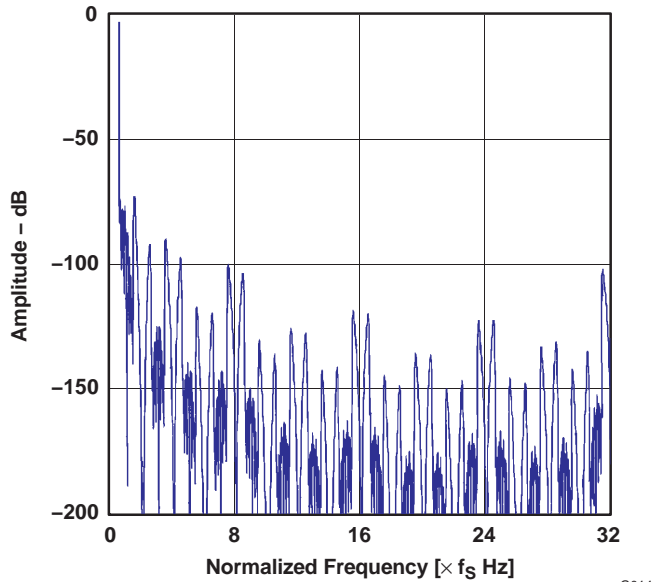

Figure 14.

**STOP-BAND ATTENUATION CHARACTERISTICS**

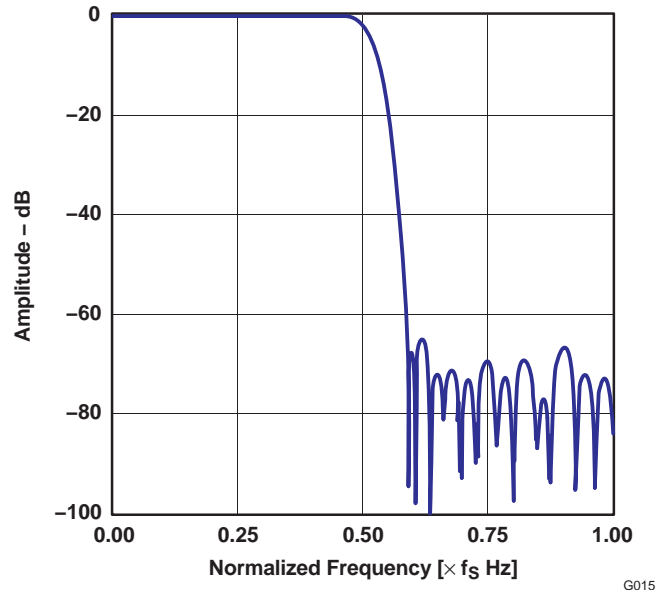

Figure 15.

**PASS-BAND RIPPLE CHARACTERISTICS**

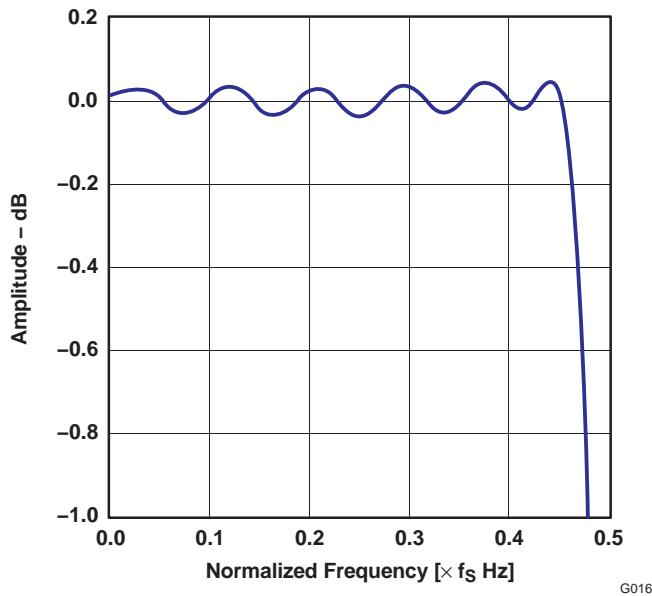

Figure 16.

**TRANSITION BAND CHARACTERISTICS**

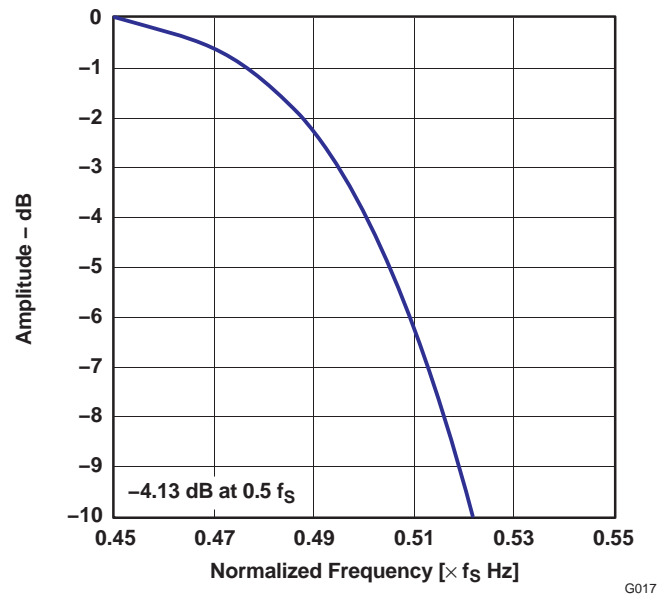

Figure 17.

**TYPICAL PERFORMANCE CURVES (continued)**

All specifications at  $T_A = 25^\circ\text{C}$ ,  $V_{DD} = V_{CC} = 5\text{ V}$ ,  $f_S = 44.1\text{ kHz}$ , and  $\text{SYSCLK} = 384 f_S$ , unless otherwise noted

**HIGH-PASS FILTER**

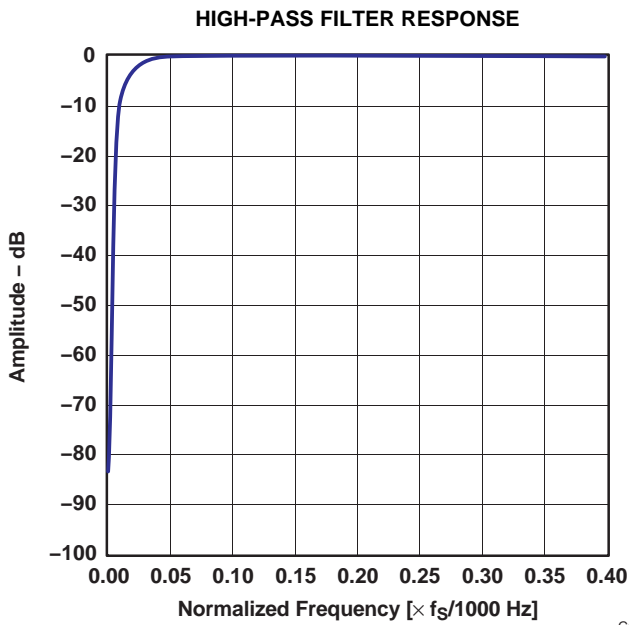

Figure 18.

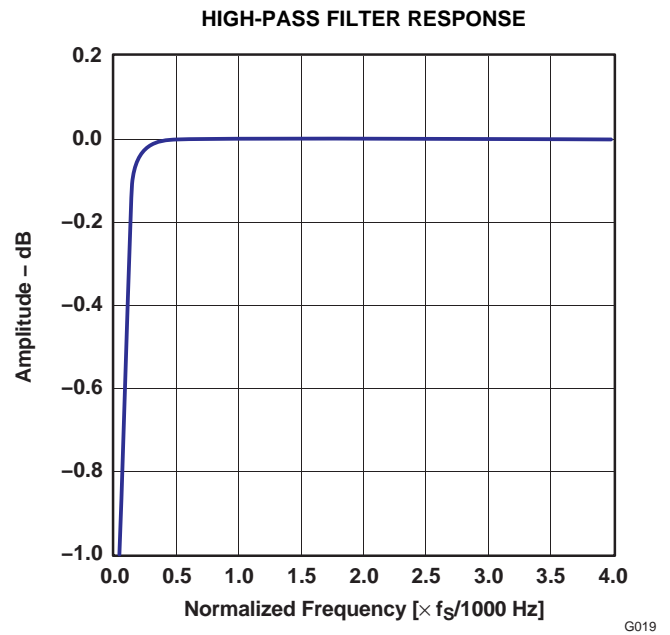

Figure 19.

**ANTI\_ALIASING FILTER**

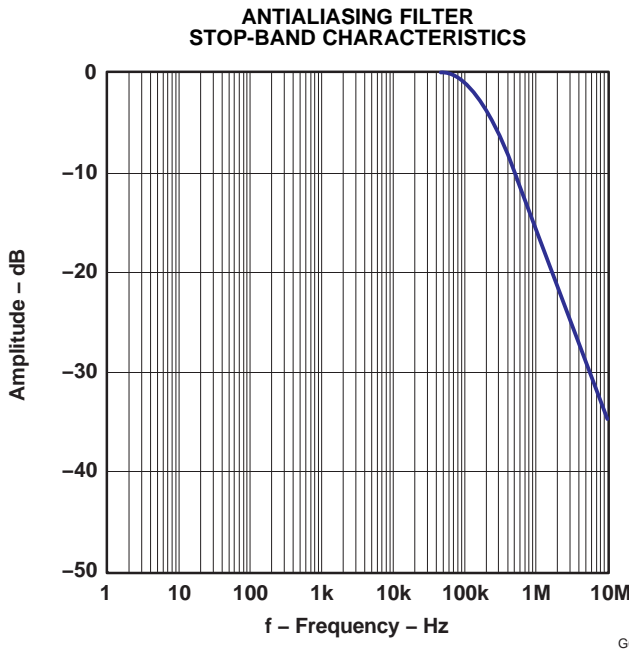

Figure 20.

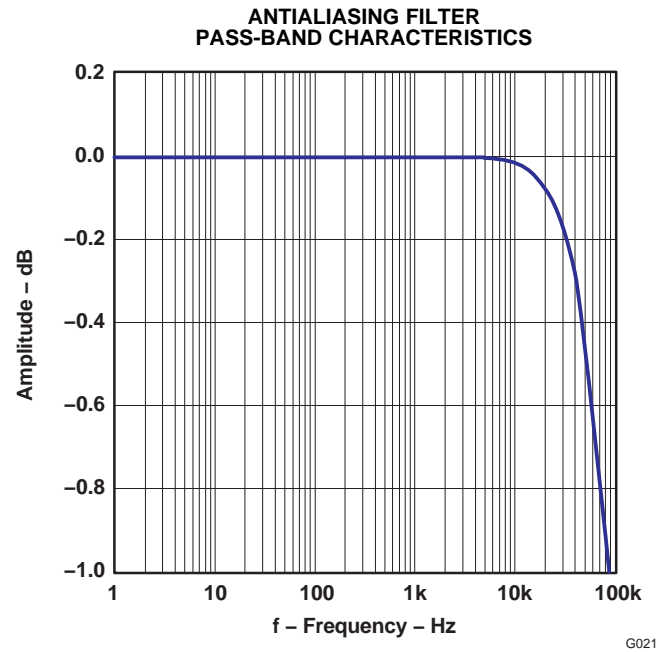

Figure 21.

## THEORY OF OPERATION

The PCM1801 consists of a band-gap reference, two channels of a single-to-differential converter, a fully differential 5th-order delta-sigma modulator, a decimation filter (including digital high-pass), and a serial interface circuit. The block diagram illustrates the total architecture of the PCM1801, and the analog front-end diagram illustrates the architecture of the single-to-differential converter and the antialiasing filter. Figure 22 illustrates the architecture of the 5th-order delta-sigma modulator and transfer functions.

An internal high-precision reference with two external capacitors provides all reference voltages which are required by the converter, and defines the full-scale voltage range of both channels. The internal single-ended to differential voltage converter saves the design, space, and extra parts needed for external circuitry required by many delta-sigma converters. The internal full-differential architecture provides a wide dynamic range and excellent power-supply rejection performance.

The input signal is sampled at a  $64\times$  oversampling rate, eliminating the need for a sample-and-hold circuit and simplifying antialias filtering requirements. The 5th-order delta-sigma noise shaper consists of five integrators which use a switched-capacitor topology, a comparator, and a feedback loop consisting of a 1-bit digital-to-analog converter (DAC). The delta-sigma modulator shapes the quantization noise, shifting it out of the audio band in the frequency domain. The high order of the modulator enables it to randomize the modulator outputs, reducing idle tone levels.

The  $64\text{-}f_s$ , 1-bit stream from the modulator is converted to  $1\text{-}f_s$ , 16-bit digital data by the decimation filter, which also acts as a low-pass filter to remove the shaped quantization noise. The dc components are removed by a digital high-pass filter, and the filtered output is converted to time-multiplexed serial signals through a serial interface which provides flexible serial formats.

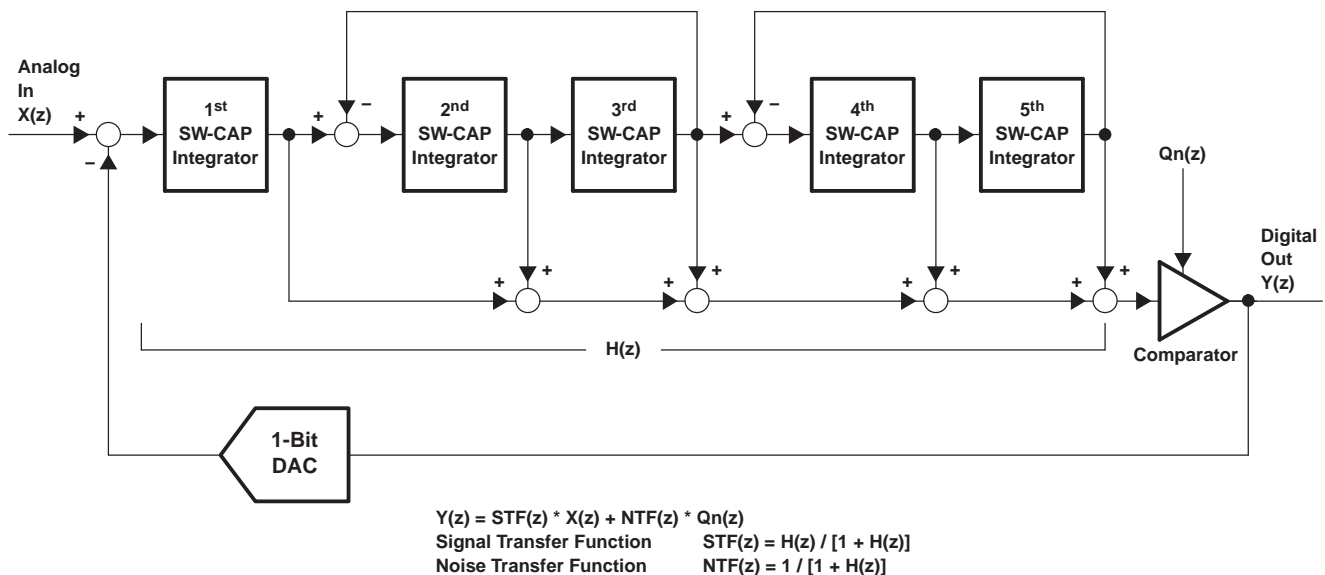

B0005-01

Figure 22. Simplified Diagram of the PCM1801 5th-Order Delta-Sigma Modulator

## SYSTEM CLOCK

The system clock for the PCM1801 must be either  $256 f_s$ ,  $384 f_s$ , or  $512 f_s$ , where  $f_s$  is the audio sampling frequency. The system clock must be supplied on SCK1 (pin 5).

The PCM1801 also has a system clock detection circuit that automatically senses if the system clock is operating at  $256 f_s$ ,  $384 f_s$ , or  $512 f_s$ .

When a  $384\text{-}f_s$  or  $512\text{-}f_s$  system clock is used, the PCM1801 automatically divides the clock down to  $256 f_s$  internally. This  $256\text{-}f_s$  clock is used to operate the digital filter and the modulator. Table 2 lists the relationship of typical sampling frequencies and system clock frequencies. Figure 23 illustrates the system clock timing.

Table 2. System Clock Frequencies

SAMPLING RATE FREQUENCY (kHz)	SYSTEM CLOCK FREQUENCY		
	256 $f_s$	384 $f_s$	512 $f_s$
32	8.1920	12.2880	16.3840
44.1	11.2896	16.9344	22.5792
48	12.2880	18.4320	24.5760

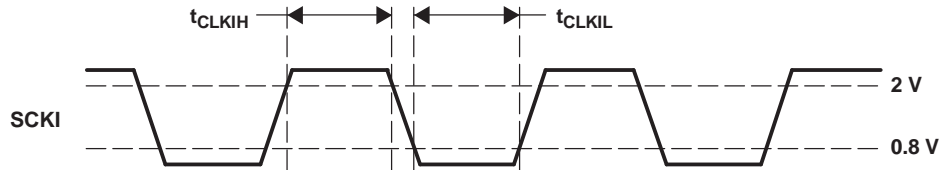

T0005-04

System clock pulse duration, HIGH	$t_{CLKIH}$	12 ns (min)
System clock pulse duration, LOW	$t_{CLKIL}$	12 ns (min)

Figure 23. System Clock Timing

## POWER-ON RESET

The PCM1801 has an internal power-on reset circuit, which initializes (resets) when the supply voltage ( $V_{CC}/V_{DD}$ ) exceeds 4 V (typical). Because the system clock is used as the clock signal for the reset circuit, the system clock must be supplied as soon as power is applied; more specifically, the device must receive at least three system clock cycles before  $V_{DD} > 4$  V. While  $V_{CC}/V_{DD} < 4$  V (typical) and for 1024 system clock cycles after  $V_{CC}/V_{DD} > 4$  V, the PCM1801 stays in the reset state and the digital output is forced to zero. The digital output is valid 18,436  $f_s$  periods after release from the reset state. Figure 24 illustrates the internal power-on reset timing and the digital output for power-on reset.

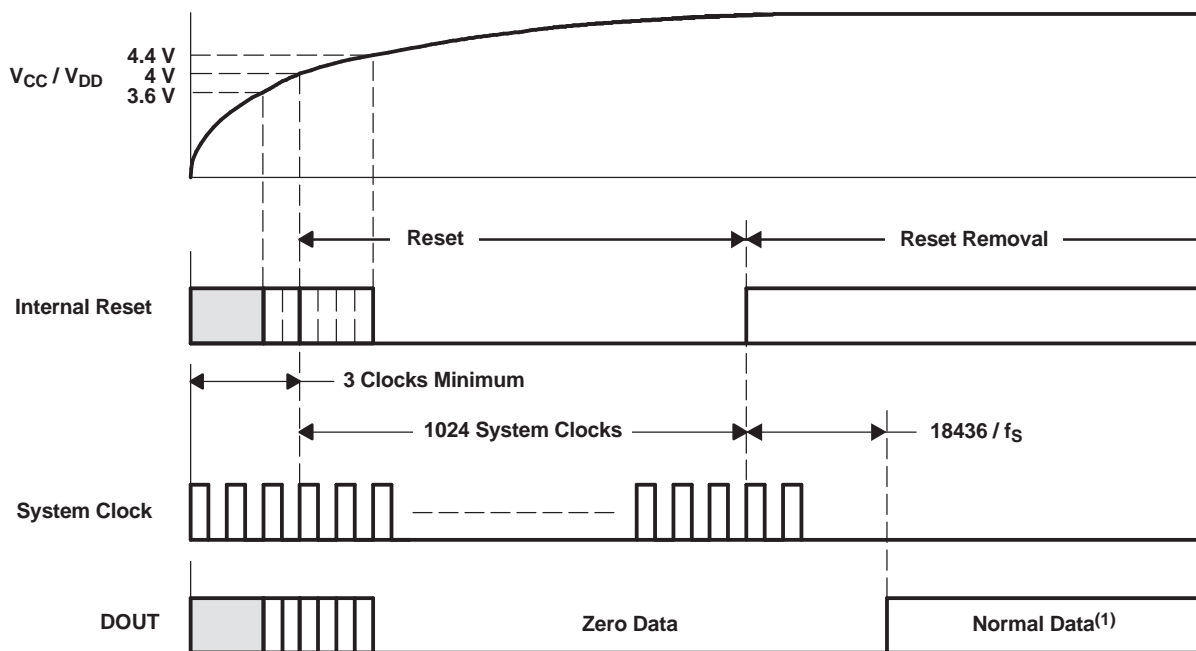

T0014-02

- (1) The transient response (exponentially attenuated signal from  $\pm 0.2\%$  dc of FSR with a 200-ms time constant) appears initially.

Figure 24. Internal Power-On Reset Timing

## SERIAL AUDIO DATA INTERFACE

The PCM1801 interfaces the audio system through BCK (pin 6), LRCK (pin 7), and DOUT (pin 8).

The PCM1801 accepts 64-BCK/LRCK, 48-BCK/LRCK (only for a 384- $f_s$  system clock) or 32-BCK/LRCK format for the left-justified format. And the PCM1801 accepts the 64-BCK/LRCK or 48-BCK/LRCK format (only for a 384- $f_s$  system clock) for I<sup>2</sup>S format.

### DATA FORMAT

The PCM1801 supports two audio data formats in slave mode, which are selected by the FMT control input (pin 10) as shown in Table 3. Figure 25 illustrates the data format. If the application system cannot ensure an effective system clock prior to power up of the PCM1801, the FMT pin must be held LOW until the power-on reset sequence is completed. In this case, if the I<sup>2</sup>S format (FMT = HIGH) is required in the application, FMT can be set HIGH after the power-on reset sequence is completed.

Table 3. Data Format

FMT	DATA FORMAT
0 (L)	16-bit, left-justified
1 (H)	16-bit, I <sup>2</sup> S

#### FMT = L

16-Bit, MSB-First, Left-Justified

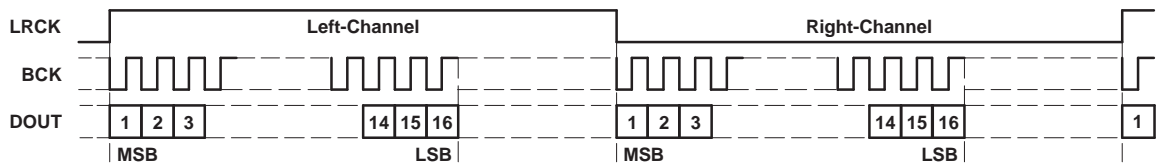

#### FMT = H

16-Bit, MSB-First, I<sup>2</sup>S

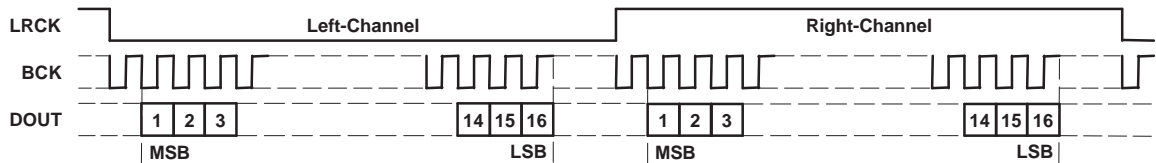

T0016-03

Figure 25. Audio Data Format

## INTERFACE TIMING

Figure 26 illustrates the interface timing.

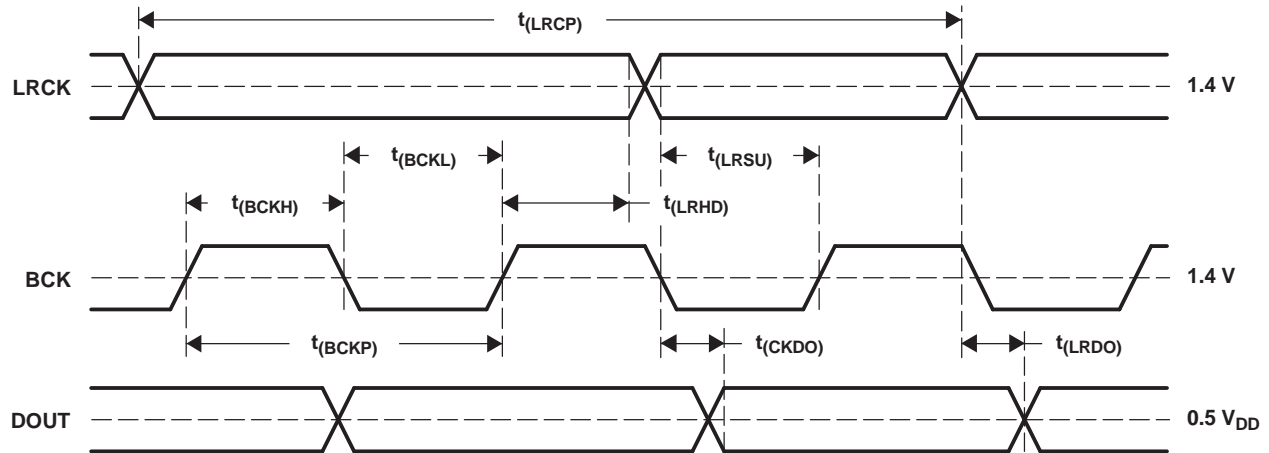

T0017-02

DESCRIPTION	SYMBOL	MIN	TYP	MAX	UNITS
BCK period	$t_{(BCKP)}$	300			ns
BCK pulse duration, HIGH	$t_{(BCKH)}$	120			ns
BCK pulse duration, LOW	$t_{(BCKL)}$	120			ns
LRCK setup time to BCK rising edge	$t_{(LRSU)}$	80			ns
LRCK hold time to BCK rising edge	$t_{(LRHD)}$	40			ns
LRCK period	$t_{(LRCP)}$	20			$\mu$ s
Delay time, BCK falling edge to DOUT valid	$t_{(CKDO)}$	-20		40	ns
Delay time, LRCK edge to DOUT valid	$t_{(LRDO)}$	-20		40	ns
Rising time of all signals	$t_{(RISE)}$			20	ns
Falling time of all signals	$t_{(FALL)}$			20	ns

NOTE: Timing measurement reference level is  $(V_{IH} + V_{IL})/2$ . Rising and falling time is measured from 10% to 90% of the I/O signal swing. Load capacitance of the DOUT signal is 20 pF.

Figure 26. Audio Data Interface Timing

## SYNCHRONIZATION WITH DIGITAL AUDIO SYSTEM

The PCM1801 operates with LRCK synchronized to the system clock (SCKI). The PCM1801 does not require a specific phase relationship between LRCK and SCKI, but does require the synchronization of LRCK and SCKI. If the relationship between LRCK and SCKI changes more than 6 bit clocks (BCK) during one sample period due to LRCK or SCKI jitter, internal operation of the ADC halts within  $1/f_s$  and the digital output is forced to BPZ until resynchronization between LRCK and SCKI is completed. In case of changes less than 5 bit clocks (BCK), resynchronization does not occur and the previously described digital output control and discontinuity do not occur. Figure 27 illustrates the ADC digital output for lost synchronization and resynchronization. During undefined data, some noise may be generated in the audio signal. Also, the transition of normal to undefined data and undefined or zero data to normal makes a discontinuity of data on the digital output and may generate some noise in the audio signal.

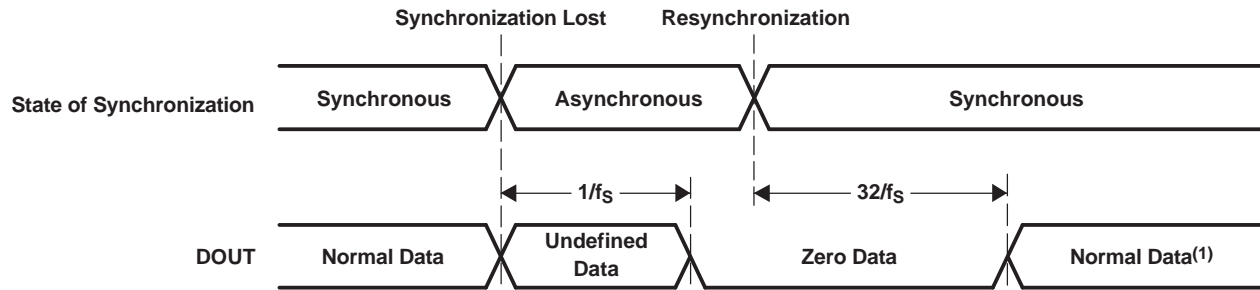

T0020-02

- (1) The transient response (exponentially attenuated signal from  $\pm 0.2\%$  dc of FSR with 200-ms time constant) appears initially.

**Figure 27. ADC Digital Output for Loss of Synchronization and Re-Synchronization**

### HPF Bypass Control

The built-in function for dc component rejection can be bypassed by BYPAS (pin 9) control (see [Table 4](#)). In bypass mode, the dc component of the input analog signal, the internal dc offset, etc., are also converted and output in the digital output data.

**Table 4. HPF Bypass Control**

BYPAS	HIGH-PASS FILTER (HPF) MODE
Low	Normal (dc cut) mode
High	Bypass (through) mode

## APPLICATION INFORMATION

### BOARD DESIGN AND LAYOUT CONSIDERATIONS

#### $V_{CC}$ , $V_{DD}$ PINS

The digital and analog power supply lines to the PCM1801 should be bypassed to the corresponding ground pins with both 0.1- $\mu\text{F}$  ceramic and 10- $\mu\text{F}$  tantalum capacitors as close to the pins as possible to maximize the dynamic performance of the ADC. Although the PCM1801 has two power lines to maximize the potential of dynamic performance, using one common power supply is recommended to avoid unexpected power supply problems, such as latch-up due to power supply sequencing.

#### AGND, DGND PINS

To maximize the dynamic performance of the PCM1801, the analog and digital grounds are not internally connected. These points should have low impedance to avoid digital noise feedback into the analog ground. They should be connected directly to each other under the PCM1801 package to reduce potential noise problems.

#### $V_{IN}$ PINS

A 1.0- $\mu\text{F}$  tantalum capacitor is recommended as an ac-coupling capacitor, which establishes a 5.3-Hz cutoff frequency. If a higher full-scale input voltage is required, the input voltage range can be increased by adding a series resistor to the  $V_{IN}$  pins.

#### $V_{REF}$ PINS

To ensure low source impedance, 4.7- $\mu\text{F}$  tantalum capacitors are recommended from  $V_{REF1}$  to AGND and from  $V_{REF2}$  to AGND. These capacitors should be located as close as possible to the  $V_{REF1}$  and  $V_{REF2}$  pins to reduce dynamic errors on the ADC references.



## APPLICATION INFORMATION (continued)

### DOUT PIN

The DOUT pin has a large load-drive capability, but locating a buffer near the PCM1801 and minimizing load capacitance is recommended in order to minimize the digital-analog crosstalk and maximize the dynamic performance of the ADC.

### FMT PIN

In general, the FMT pin is used for audio data format selection by tying up DGND or  $V_{DD}$  in accordance with interface requirements. If the application system cannot ensure an effective system clock prior to power up of the PCM1801 when I<sup>2</sup>S format is required, then the FMT pin must be set HIGH after the power-on reset sequence. This input control can be accomplished easily by connecting a C-R delay circuit with a delay time greater than 1 ms to the FMT pin.

### SYSTEM CLOCK

The quality of the system clock can influence dynamic performance in the PCM1801. The duty cycle, jitter, and threshold voltage at the system clock input pin must be carefully managed. When power is supplied to the part, the system clock, bit clock (BCK), and word clock (LRCK) should also be supplied simultaneously. Failure to supply the audio clocks results in a power dissipation increase of up to three times normal dissipation and may degrade long-term reliability if the maximum power dissipation limit is exceeded.

### TYPICAL CIRCUIT CONNECTION DIAGRAM

Figure 28 is a typical connection diagram illustrating a circuit for which the input HPF cutoff frequency is about 5 Hz.

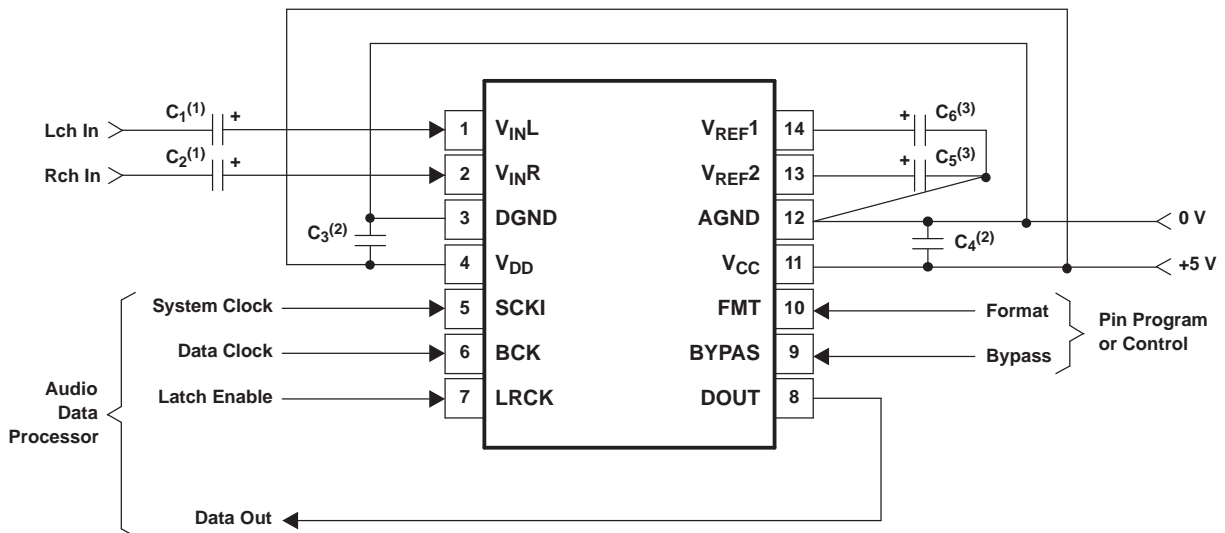

S0013-01

- (1) C1 and C2: A 1- $\mu$ F capacitor gives a 5.3-Hz ( $\tau = 1 \mu\text{F} * 30 \text{ k}\Omega$ ) cutoff frequency for the input HPF in normal operation and requires a power-on setting time of 30 ms at power up.
- (2) C3 and C4: Bypass capacitors, 0.1- $\mu$ F ceramic and 10- $\mu$ F tantalum or aluminum electrolytic, depending on layout and power supply
- (3) C5 and C6: 4.7- $\mu$ F tantalum or aluminum electrolytic capacitors

**Figure 28. Typical Circuit Connection**

**PACKAGING INFORMATION**

Orderable Device	Status (1)	Package Type	Package Drawing	Pins	Package Qty	Eco Plan (2)	Lead finish/ Ball material (6)	MSL Peak Temp (3)	Op Temp (°C)	Device Marking (4/5)	Samples
PCM1801U	ACTIVE	SOIC	D	14	50	RoHS & Green	NIPDAU	Level-1-260C-UNLIM		PCM1801U	<a href="#">Samples</a>
PCM1801U/2K	ACTIVE	SOIC	D	14	2000	RoHS & Green	NIPDAU	Level-1-260C-UNLIM		PCM1801U	<a href="#">Samples</a>
PCM1801U/2KG4	ACTIVE	SOIC	D	14	2000	RoHS & Green	NIPDAU	Level-1-260C-UNLIM		PCM1801U	<a href="#">Samples</a>
PCM1801UG4	ACTIVE	SOIC	D	14	50	RoHS & Green	NIPDAU	Level-1-260C-UNLIM		PCM1801U	<a href="#">Samples</a>

(1) The marketing status values are defined as follows:

**ACTIVE:** Product device recommended for new designs.

**LIFEBUY:** TI has announced that the device will be discontinued, and a lifetime-buy period is in effect.

**NRND:** Not recommended for new designs. Device is in production to support existing customers, but TI does not recommend using this part in a new design.

**PREVIEW:** Device has been announced but is not in production. Samples may or may not be available.

**OBSOLETE:** TI has discontinued the production of the device.

(2) **RoHS:** TI defines "RoHS" to mean semiconductor products that are compliant with the current EU RoHS requirements for all 10 RoHS substances, including the requirement that RoHS substance do not exceed 0.1% by weight in homogeneous materials. Where designed to be soldered at high temperatures, "RoHS" products are suitable for use in specified lead-free processes. TI may reference these types of products as "Pb-Free".

**RoHS Exempt:** TI defines "RoHS Exempt" to mean products that contain lead but are compliant with EU RoHS pursuant to a specific EU RoHS exemption.

**Green:** TI defines "Green" to mean the content of Chlorine (Cl) and Bromine (Br) based flame retardants meet JS709B low halogen requirements of <=1000ppm threshold. Antimony trioxide based flame retardants must also meet the <=1000ppm threshold requirement.

(3) MSL, Peak Temp. - The Moisture Sensitivity Level rating according to the JEDEC industry standard classifications, and peak solder temperature.

(4) There may be additional marking, which relates to the logo, the lot trace code information, or the environmental category on the device.

(5) Multiple Device Markings will be inside parentheses. Only one Device Marking contained in parentheses and separated by a "-" will appear on a device. If a line is indented then it is a continuation of the previous line and the two combined represent the entire Device Marking for that device.

(6) Lead finish/Ball material - Orderable Devices may have multiple material finish options. Finish options are separated by a vertical ruled line. Lead finish/Ball material values may wrap to two lines if the finish value exceeds the maximum column width.

**Important Information and Disclaimer:**The information provided on this page represents TI's knowledge and belief as of the date that it is provided. TI bases its knowledge and belief on information provided by third parties, and makes no representation or warranty as to the accuracy of such information. Efforts are underway to better integrate information from third parties. TI has taken and

continues to take reasonable steps to provide representative and accurate information but may not have conducted destructive testing or chemical analysis on incoming materials and chemicals. TI and TI suppliers consider certain information to be proprietary, and thus CAS numbers and other limited information may not be available for release.

In no event shall TI's liability arising out of such information exceed the total purchase price of the TI part(s) at issue in this document sold by TI to Customer on an annual basis.

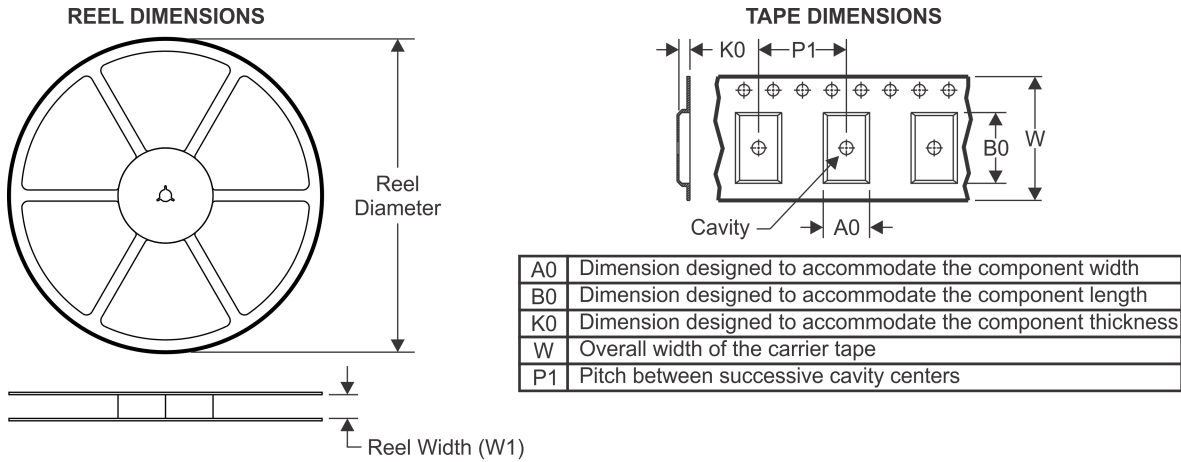
**TAPE AND REEL INFORMATION**

**QUADRANT ASSIGNMENTS FOR PIN 1 ORIENTATION IN TAPE**

\*All dimensions are nominal

Device	Package Type	Package Drawing	Pins	SPQ	Reel Diameter (mm)	Reel Width W1 (mm)	A0 (mm)	B0 (mm)	K0 (mm)	P1 (mm)	W (mm)	Pin1 Quadrant
PCM1801U/2K	SOIC	D	14	2000	330.0	16.4	6.5	9.0	2.1	8.0	16.0	Q1

TAPE AND REEL BOX DIMENSIONS





\*All dimensions are nominal

Device	Package Type	Package Drawing	Pins	SPQ	Length (mm)	Width (mm)	Height (mm)
PCM1801U/2K	SOIC	D	14	2000	853.0	449.0	35.0

D (R-PDSO-G14)

PLASTIC SMALL OUTLINE



- NOTES:
- A. All linear dimensions are in inches (millimeters).
  - B. This drawing is subject to change without notice.
  -  Body length does not include mold flash, protrusions, or gate burrs. Mold flash, protrusions, or gate burrs shall not exceed 0.006 (0,15) each side.
  -  Body width does not include interlead flash. Interlead flash shall not exceed 0.017 (0,43) each side.
  - E. Reference JEDEC MS-012 variation AB.

D (R-PDSO-G14)

PLASTIC SMALL OUTLINE



- NOTES:
- A. All linear dimensions are in millimeters.
  - B. This drawing is subject to change without notice.
  - C. Publication IPC-7351 is recommended for alternate designs.
  - D. Laser cutting apertures with trapezoidal walls and also rounding corners will offer better paste release. Customers should contact their board assembly site for stencil design recommendations. Refer to IPC-7525 for other stencil recommendations.
  - E. Customers should contact their board fabrication site for solder mask tolerances between and around signal pads.

## IMPORTANT NOTICE AND DISCLAIMER

TI PROVIDES TECHNICAL AND RELIABILITY DATA (INCLUDING DATASHEETS), DESIGN RESOURCES (INCLUDING REFERENCE DESIGNS), APPLICATION OR OTHER DESIGN ADVICE, WEB TOOLS, SAFETY INFORMATION, AND OTHER RESOURCES "AS IS" AND WITH ALL FAULTS, AND DISCLAIMS ALL WARRANTIES, EXPRESS AND IMPLIED, INCLUDING WITHOUT LIMITATION ANY IMPLIED WARRANTIES OF MERCHANTABILITY, FITNESS FOR A PARTICULAR PURPOSE OR NON-INFRINGEMENT OF THIRD PARTY INTELLECTUAL PROPERTY RIGHTS.

These resources are intended for skilled developers designing with TI products. You are solely responsible for (1) selecting the appropriate TI products for your application, (2) designing, validating and testing your application, and (3) ensuring your application meets applicable standards, and any other safety, security, or other requirements. These resources are subject to change without notice. TI grants you permission to use these resources only for development of an application that uses the TI products described in the resource. Other reproduction and display of these resources is prohibited. No license is granted to any other TI intellectual property right or to any third party intellectual property right. TI disclaims responsibility for, and you will fully indemnify TI and its representatives against, any claims, damages, costs, losses, and liabilities arising out of your use of these resources.

TI's products are provided subject to TI's Terms of Sale ([www.ti.com/legal/termsofsale.html](http://www.ti.com/legal/termsofsale.html)) or other applicable terms available either on [ti.com](http://ti.com) or provided in conjunction with such TI products. TI's provision of these resources does not expand or otherwise alter TI's applicable warranties or warranty disclaimers for TI products.

Mailing Address: Texas Instruments, Post Office Box 655303, Dallas, Texas 75265  
Copyright © 2020, Texas Instruments Incorporated