

## High-Speed CMOS Logic 4-Bit Binary Full Adder with Fast Carry

### Features

- Adds Two Binary Numbers
- Full Internal Lookahead
- Fast Ripple Carry for Economical Expansion
- Operates with Both Positive and Negative Logic
- Fanout (Over Temperature Range)
  - Standard Outputs . . . . . 10 LSTTL Loads
  - Bus Driver Outputs . . . . . 15 LSTTL Loads
- Wide Operating Temperature Range . . . -55°C to 125°C
- Balanced Propagation Delay and Transition Times
- Significant Power Reduction Compared to LSTTL Logic ICs
- HC Types
  - 2V to 6V Operation
  - High Noise Immunity:  $N_{IL} = 30\%$ ,  $N_{IH} = 30\%$  of  $V_{CC}$  at  $V_{CC} = 5V$
- HCT Types
  - 4.5V to 5.5V Operation
  - Direct LSTTL Input Logic Compatibility,  $V_{IL} = 0.8V$  (Max),  $V_{IH} = 2V$  (Min)
  - CMOS Input Compatibility,  $I_I \leq 1\mu A$  at  $V_{OL}$ ,  $V_{OH}$

### Description

The 'HC283 and 'HCT283 binary full adders add two 4-bit binary numbers and generate a carry-out bit if the sum exceeds 15.

Because of the symmetry of the add function, this device can be used with either all active-high operands (positive logic) or with all active-low operands (negative logic). When using positive logic the carry-in input must be tied low if there is no carry-in.

### Ordering Information

PART NUMBER	TEMP. RANGE (°C)	PACKAGE
CD54HC283F3A	-55 to 125	16 Ld CERDIP
CD54HCT283F3A	-55 to 125	16 Ld CERDIP
CD74HC283E	-55 to 125	16 Ld PDIP
CD74HC283M	-55 to 125	16 Ld SOIC
CD74HC283MT	-55 to 125	16 Ld SOIC
CD74HC283M96	-55 to 125	16 Ld SOIC
CD74HCT283E	-55 to 125	16 Ld PDIP
CD74HCT283M	-55 to 125	16 Ld SOIC
CD74HCT283MT	-55 to 125	16 Ld SOIC
CD74HCT283M96	-55 to 125	16 Ld SOIC

NOTE: When ordering, use the entire part number. The suffix 96 denotes tape and reel. The suffix T denotes a small-quantity reel of 250.

### Pinout

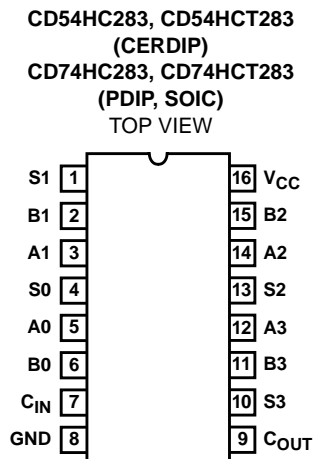

### Functional Diagram

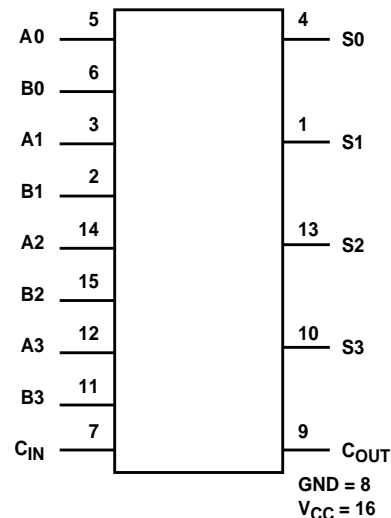

# CD54HC283, CD74HC283, CD54HCT283, CD74HCT283

## Absolute Maximum Ratings

DC Supply Voltage, $V_{CC}$ .....	-0.5V to 7V
DC Input Diode Current, $I_{IK}$	
For $V_I < -0.5V$ or $V_I > V_{CC} + 0.5V$ .....	$\pm 20mA$
DC Output Diode Current, $I_{OK}$	
For $V_O < -0.5V$ or $V_O > V_{CC} + 0.5V$ .....	$\pm 20mA$
DC Drain Current, per Output, $I_O$	
For $-0.5V < V_O < V_{CC} + 0.5V$ .....	$\pm 25mA$
DC Output Source or Sink Current per Output Pin, $I_O$	
For $V_O > -0.5V$ or $V_O < V_{CC} + 0.5V$ .....	$\pm 25mA$
DC $V_{CC}$ or Ground Current, $I_{CC}$ .....	$\pm 50mA$

## Thermal Information

Thermal Resistance (Typical, Note 1)	$\theta_{JA}$ ( $^{\circ}C/W$ )
E (PDIP) Package .....	67
M (SOIC) Package .....	73
Maximum Junction Temperature .....	$150^{\circ}C$
Maximum Storage Temperature Range .....	$-65^{\circ}C$ to $150^{\circ}C$
Maximum Lead Temperature (Soldering 10s) .....	$300^{\circ}C$ (SOIC - Lead Tips Only)

## Operating Conditions

Temperature Range, $T_A$ .....	$-55^{\circ}C$ to $125^{\circ}C$
Supply Voltage Range, $V_{CC}$	
HC Types .....	$.2V$ to $6V$
DC Input or Output Voltage, $V_I, V_O$ .....	$0V$ to $V_{CC}$
Input Rise and Fall Time	
2V .....	1000ns (Max)
4.5V .....	500ns (Max)
6V .....	400ns (Max)

*CAUTION: Stresses above those listed in "Absolute Maximum Ratings" may cause permanent damage to the device. This is a stress only rating and operation of the device at these or any other conditions above those indicated in the operational sections of this specification is not implied.*

### NOTE:

- The package thermal impedance is calculated in accordance with JESD 51-7.

## DC Electrical Specifications

PARAMETER	SYMBOL	TEST CONDITIONS		$V_{CC}$ (V)	25 $^{\circ}C$			-40 $^{\circ}C$ TO 85 $^{\circ}C$		-55 $^{\circ}C$ TO 125 $^{\circ}C$		UNITS	
		$V_I$ (V)	$I_O$ (mA)		MIN	TYP	MAX	MIN	MAX	MIN	MAX		
<b>HC TYPES</b>													
High Level Input Voltage	$V_{IH}$	-	-	2	1.5	-	-	1.5	-	1.5	-	V	
				4.5	3.15	-	-	3.15	-	3.15	-	V	
				6	4.2	-	-	4.2	-	4.2	-	V	
Low Level Input Voltage	$V_{IL}$	-	-	2	-	-	0.5	-	0.5	-	0.5	V	
				4.5	-	-	1.35	-	1.35	-	1.35	V	
				6	-	-	1.8	-	1.8	-	1.8	V	
High Level Output Voltage CMOS Loads	$V_{OH}$	$V_{IH}$ or $V_{IL}$	-0.02	-0.02	2	1.9	-	-	1.9	-	1.9	-	V
			-0.02	-0.02	4.5	4.4	-	-	4.4	-	4.4	-	V
			-0.02	-0.02	6	5.9	-	-	5.9	-	5.9	-	V
High Level Output Voltage TTL Loads	$V_{OH}$	$V_{IH}$ or $V_{IL}$	-	-	-	-	-	-	-	-	-	V	
			-4	-4	4.5	3.98	-	-	3.84	-	3.7	-	V
			-5.2	-5.2	6	5.48	-	-	5.34	-	5.2	-	V
Low Level Output Voltage CMOS Loads	$V_{OL}$	$V_{IH}$ or $V_{IL}$	0.02	0.02	2	-	-	0.1	-	0.1	-	0.1	V
			0.02	0.02	4.5	-	-	0.1	-	0.1	-	0.1	V
			0.02	0.02	6	-	-	0.1	-	0.1	-	0.1	V
Low Level Output Voltage TTL Loads	$V_{OL}$	$V_{IH}$ or $V_{IL}$	-	-	-	-	-	-	-	-	-	V	
			4	4	4.5	-	-	0.26	-	0.33	-	0.4	V
			5.2	5.2	6	-	-	0.26	-	0.33	-	0.4	V
Input Leakage Current	$I_I$	$V_{CC}$ or GND	-	6	-	-	$\pm 0.1$	-	$\pm 1$	-	$\pm 1$	$\mu A$	
Quiescent Device Current	$I_{CC}$	$V_{CC}$ or GND	0	6	-	-	8	-	80	-	160	$\mu A$	

**CD54HC283, CD74HC283, CD54HCT283, CD74HCT283**

**DC Electrical Specifications (Continued)**

PARAMETER	SYMBOL	TEST CONDITIONS		V <sub>CC</sub> (V)	25°C			-40°C TO 85°C		-55°C TO 125°C		UNITS
		V <sub>I</sub> (V)	I <sub>O</sub> (mA)		MIN	TYP	MAX	MIN	MAX	MIN	MAX	
HCT Types												
High Level Input Voltage	V <sub>IH</sub>	-	-	4.5 to 5.5	2	-	-	2	-	2	-	V
Low Level Input Voltage	V <sub>IL</sub>	-	-	4.5 to 5.5	-	-	0.8	-	0.8	-	0.8	V
High Level Output Voltage CMOS Loads	V <sub>OH</sub>	V <sub>IL</sub> or V <sub>IH</sub>	-0.02	4.5	4.4	-	-	4.4	-	4.4	-	V
High Level Output Voltage TTL Loads	V <sub>OH</sub>	V <sub>IL</sub> or V <sub>IH</sub>	-4	4.5	3.98	-	-	3.84	-	3.7	-	V
Low Level Output Voltage CMOS Loads	V <sub>OL</sub>	V <sub>IH</sub> or V <sub>IL</sub>	0.02	4.5	-	-	0.1	-	0.1	-	0.1	V
Low Level Output Voltage TTL Loads	V <sub>OL</sub>	V <sub>IH</sub> or V <sub>IL</sub>	4	4.5	-	-	0.26	-	0.33	-	0.4	V
Input Leakage Current	I <sub>I</sub>	V <sub>CC</sub> to GND	-	5.5	-	-	±0.1	-	±1	-	±1	μA
Quiescent Device Current	ICC	V <sub>CC</sub> or GND	-	5.5	-	-	8	-	80	-	160	μA
Additional Quiescent Device Current Per Input Pin: 1 Unit Load	ΔI <sub>CC</sub> (Note 2)	V <sub>CC</sub> - 2.1	-	4.5 to 5.5	-	100	360	-	450	-	490	μA

NOTE:

- For dual-supply systems theoretical worst case (V<sub>I</sub> = 2.4V, V<sub>CC</sub> = 5.5V) specification is 1.8mA.

**HCT Input Loading Table**

INPUT	UNIT LOADS
C <sub>IN</sub>	1.5
B1, A1, A0	1
B0	0.4
B3, A3, A2, B2	0.5

NOTE: Unit Load is ΔI<sub>CC</sub> limit specified in DC Electrical Specifications table, e.g., 360μA max at 25°C.

**Switching Specifications** Input t<sub>r</sub>, t<sub>f</sub> = 6ns

PARAMETER	SYMBOL	TEST CONDITIONS	V <sub>CC</sub> (V)	25°C			-40°C TO 85°C		-55°C TO 125°C		UNITS
				MIN	TYP	MAX	MIN	MAX	MIN	MAX	
<b>HC TYPES</b>											
Propagation Delay C <sub>IN</sub> to S0	t <sub>PLH</sub> , t <sub>PHL</sub>	C <sub>L</sub> = 50pF	2	-	-	160	-	200	-	240	ns
			4.5	-	-	32	-	40	-	48	ns
		C <sub>L</sub> = 15pF	5	-	13	-	-	-	-	-	ns
		C <sub>L</sub> = 50pF	6	-	-	27	-	34	-	41	ns

**CD54HC283, CD74HC283, CD54HCT283, CD74HCT283**

**Switching Specifications** Input  $t_r, t_f = 6\text{ns}$  (Continued)

PARAMETER	SYMBOL	TEST CONDITIONS	$V_{CC}$ (V)	25°C			-40°C TO 85°C		-55°C TO 125°C		UNITS
				MIN	TYP	MAX	MIN	MAX	MIN	MAX	
$C_{IN}$ to S1	$t_{PLH}, t_{PHL}$	$C_L = 50\text{pF}$	2	-	-	180	-	225	-	270	ns
			4.5	-	-	36	-	45	-	54	ns
		$C_L = 15\text{pF}$	5	-	15	-	-	-	-	-	ns
		$C_L = 50\text{pF}$	6	-	-	31	-	38	-	46	ns
$C_{IN}$ to S2, $C_{IN}$ to $C_{OUT}$	$t_{PLH}, t_{PHL}$	$C_L = 50\text{pF}$	2	-	-	195	-	245	-	295	ns
			4.5	-	-	39	-	49	-	59	ns
		$C_L = 15\text{pF}$	5	-	16	-	-	-	-	-	ns
		$C_L = 50\text{pF}$	6	-	-	33	-	42	-	50	ns
$C_{IN}$ to S3	$t_{PLH}, t_{PHL}$	$C_L = 50\text{pF}$	2	-	-	230	-	290	-	345	ns
			4.5	-	-	46	-	58	-	69	ns
		$C_L = 15\text{pF}$	5	-	19	-	-	-	-	-	ns
		$C_L = 50\text{pF}$	6	-	-	39	-	49	-	59	ns
An, Bn to $C_{OUT}$	$t_{PLH}, t_{PHL}$	$C_L = 50\text{pF}$	2	-	-	195	-	245	-	295	ns
			4.5	-	-	39	-	49	-	59	ns
		$C_L = 15\text{pF}$	5	-	16	-	-	-	-	-	ns
		$C_L = 50\text{pF}$	6	-	-	33	-	42	-	50	ns
An, Bn to Sn	$t_{PLH}, t_{PHL}$	$C_L = 50\text{pF}$	2	-	-	210	-	265	-	315	ns
			4.5	-	-	42	-	53	-	63	ns
		$C_L = 15\text{pF}$	5	-	18	-	-	-	-	-	ns
		$C_L = 50\text{pF}$	6	-	-	36	-	45	-	54	ns
Output Transition Time	$t_{TLH}, t_{THL}$	$C_L = 50\text{pF}$	2	-	-	75	-	95	-	110	ns
			4.5	-	-	15	-	19	-	22	ns
			6	-	-	13	-	16	-	19	ns
Input Capacitance	$C_{IN}$	$C_L = 50\text{pF}$	-	-	-	10	-	10	-	10	pF
Power Dissipation Capacitance, (Notes 3, 4)	$C_{PD}$	-	5	-	70	-	-	-	-	-	pF

**HCT TYPES**

Propagation Delay $C_{IN}$ to S0	$t_{PLH}, t_{PHL}$	$C_L = 15\text{pF}$	5	-	13	-	-	-	-	-	ns
		$C_L = 50\text{pF}$	4.5	-	-	31	-	39	-	47	ns
$C_{IN}$ to S1	$t_{PLH}, t_{PHL}$	$C_L = 15\text{pF}$	5	-	18	-	-	-	-	-	ns
		$C_L = 50\text{pF}$	4.5	-	-	43	-	54	-	65	ns
$C_{IN}$ to S2, $C_{IN}$ to $C_{OUT}$	$t_{PLH}, t_{PHL}$	$C_L = 15\text{pF}$	5	-	19	-	-	-	-	-	ns
		$C_L = 50\text{pF}$	4.5	-	-	46	-	58	-	69	ns
$C_{IN}$ to S3	$t_{PLH}, t_{PHL}$	$C_L = 15\text{pF}$	5	-	22	-	-	-	-	-	ns
		$C_L = 50\text{pF}$	4.5	-	-	53	-	66	-	80	ns
An, Bn to $C_{OUT}$	$t_{PLH}, t_{PHL}$	$C_L = 15\text{pF}$	5	-	20	-	-	-	-	-	ns
		$C_L = 50\text{pF}$	4.5	-	-	48	-	60	-	72	ns
An, Bn to Sn	$t_{PLH}, t_{PHL}$	$C_L = 15\text{pF}$	5	-	21	-	-	-	-	-	ns
		$C_L = 50\text{pF}$	4.5	-	-	49	-	61	-	74	ns
Output Transition Time	$t_{TLH}, t_{THL}$	$C_L = 50\text{pF}$	4.5	-	-	15	-	19	-	22	ns

**CD54HC283, CD74HC283, CD54HCT283, CD74HCT283**

**Switching Specifications** Input  $t_r$ ,  $t_f = 6\text{ ns}$  (Continued)

PARAMETER	SYMBOL	TEST CONDITIONS	$V_{CC}$ (V)	25°C			-40°C TO 85°C		-55°C TO 125°C		UNITS
				MIN	TYP	MAX	MIN	MAX	MIN	MAX	
Input Capacitance	$C_{IN}$	-	-	-	-	10	-	10	-	10	pF
Power Dissipation Capacitance, (Notes 3, 4)	$C_{PD}$	-	5	-	82	-	-	-	-	-	pF

NOTES:

- $C_{PD}$  is used to determine the dynamic power consumption, per package.
- $P_D = V_{CC}^2 f_i (C_{PD} + C_L)$  where:  $f_i$  = Input Frequency,  $C_L$  = Output Load Capacitance,  $V_{CC}$  = Supply Voltage.

**Test Circuits and Waveforms**

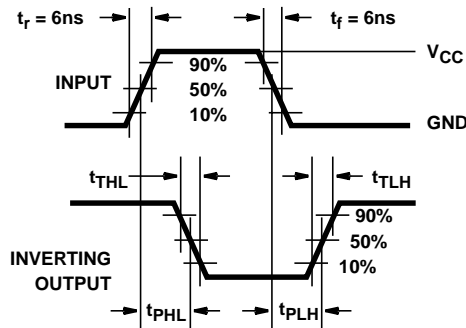

FIGURE 1. HC AND HCU TRANSITION TIMES AND PROPAGATION DELAY TIMES, COMBINATION LOGIC

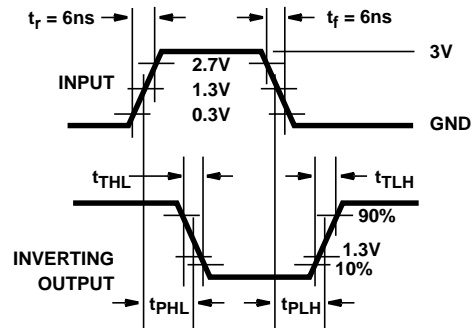

FIGURE 2. HCT TRANSITION TIMES AND PROPAGATION DELAY TIMES, COMBINATION LOGIC

**PACKAGING INFORMATION**

Orderable Device	Status (1)	Package Type	Package Drawing	Pins	Package Qty	Eco Plan (2)	Lead finish/ Ball material (6)	MSL Peak Temp (3)	Op Temp (°C)	Device Marking (4/5)	Samples
5962-8976501EA	ACTIVE	CDIP	J	16	1	Non-RoHS & Green	SNPB	N / A for Pkg Type	-55 to 125	5962-8976501EA CD54HC283F3A	<a href="#">Samples</a>
CD54HC283F3A	ACTIVE	CDIP	J	16	1	Non-RoHS & Green	SNPB	N / A for Pkg Type	-55 to 125	5962-8976501EA CD54HC283F3A	<a href="#">Samples</a>
CD54HCT283F3A	ACTIVE	CDIP	J	16	1	Non-RoHS & Green	SNPB	N / A for Pkg Type	-55 to 125	CD54HCT283F3A	<a href="#">Samples</a>
CD74HC283E	ACTIVE	PDIP	N	16	25	RoHS & Green	NIPDAU	N / A for Pkg Type	-55 to 125	CD74HC283E	<a href="#">Samples</a>
CD74HC283M	ACTIVE	SOIC	D	16	40	RoHS & Green	NIPDAU	Level-1-260C-UNLIM	-55 to 125	HC283M	<a href="#">Samples</a>
CD74HC283M96	ACTIVE	SOIC	D	16	2500	RoHS & Green	NIPDAU	Level-1-260C-UNLIM	-55 to 125	HC283M	<a href="#">Samples</a>
CD74HC283ME4	ACTIVE	SOIC	D	16	40	RoHS & Green	NIPDAU	Level-1-260C-UNLIM	-55 to 125	HC283M	<a href="#">Samples</a>
CD74HC283MT	ACTIVE	SOIC	D	16	250	RoHS & Green	NIPDAU	Level-1-260C-UNLIM	-55 to 125	HC283M	<a href="#">Samples</a>
CD74HCT283E	ACTIVE	PDIP	N	16	25	RoHS & Green	NIPDAU	N / A for Pkg Type	-55 to 125	CD74HCT283E	<a href="#">Samples</a>
CD74HCT283M	ACTIVE	SOIC	D	16	40	RoHS & Green	NIPDAU	Level-1-260C-UNLIM	-55 to 125	HCT283M	<a href="#">Samples</a>
CD74HCT283M96	ACTIVE	SOIC	D	16	2500	RoHS & Green	NIPDAU	Level-1-260C-UNLIM	-55 to 125	HCT283M	<a href="#">Samples</a>
CD74HCT283M96G4	ACTIVE	SOIC	D	16	2500	RoHS & Green	NIPDAU	Level-1-260C-UNLIM	-55 to 125	HCT283M	<a href="#">Samples</a>
CD74HCT283MG4	ACTIVE	SOIC	D	16	40	RoHS & Green	NIPDAU	Level-1-260C-UNLIM	-55 to 125	HCT283M	<a href="#">Samples</a>
CD74HCT283MT	ACTIVE	SOIC	D	16	250	RoHS & Green	NIPDAU	Level-1-260C-UNLIM	-55 to 125	HCT283M	<a href="#">Samples</a>

(1) The marketing status values are defined as follows:

**ACTIVE:** Product device recommended for new designs.

**LIFEBUY:** TI has announced that the device will be discontinued, and a lifetime-buy period is in effect.

**NRND:** Not recommended for new designs. Device is in production to support existing customers, but TI does not recommend using this part in a new design.

**PREVIEW:** Device has been announced but is not in production. Samples may or may not be available.

**OBSELETE:** TI has discontinued the production of the device.

(2) **RoHS:** TI defines "RoHS" to mean semiconductor products that are compliant with the current EU RoHS requirements for all 10 RoHS substances, including the requirement that RoHS substance do not exceed 0.1% by weight in homogeneous materials. Where designed to be soldered at high temperatures, "RoHS" products are suitable for use in specified lead-free processes. TI may reference these types of products as "Pb-Free".

**RoHS Exempt:** TI defines "RoHS Exempt" to mean products that contain lead but are compliant with EU RoHS pursuant to a specific EU RoHS exemption.

**Green:** TI defines "Green" to mean the content of Chlorine (Cl) and Bromine (Br) based flame retardants meet JS709B low halogen requirements of <=1000ppm threshold. Antimony trioxide based flame retardants must also meet the <=1000ppm threshold requirement.

(3) MSL, Peak Temp. - The Moisture Sensitivity Level rating according to the JEDEC industry standard classifications, and peak solder temperature.

(4) There may be additional marking, which relates to the logo, the lot trace code information, or the environmental category on the device.

(5) Multiple Device Markings will be inside parentheses. Only one Device Marking contained in parentheses and separated by a "~" will appear on a device. If a line is indented then it is a continuation of the previous line and the two combined represent the entire Device Marking for that device.

(6) Lead finish/Ball material - Orderable Devices may have multiple material finish options. Finish options are separated by a vertical ruled line. Lead finish/Ball material values may wrap to two lines if the finish value exceeds the maximum column width.

**Important Information and Disclaimer:**The information provided on this page represents TI's knowledge and belief as of the date that it is provided. TI bases its knowledge and belief on information provided by third parties, and makes no representation or warranty as to the accuracy of such information. Efforts are underway to better integrate information from third parties. TI has taken and continues to take reasonable steps to provide representative and accurate information but may not have conducted destructive testing or chemical analysis on incoming materials and chemicals. TI and TI suppliers consider certain information to be proprietary, and thus CAS numbers and other limited information may not be available for release.

In no event shall TI's liability arising out of such information exceed the total purchase price of the TI part(s) at issue in this document sold by TI to Customer on an annual basis.

**OTHER QUALIFIED VERSIONS OF CD54HC283, CD54HCT283, CD74HC283, CD74HCT283 :**

● Catalog : [CD74HC283](#), [CD74HCT283](#)

● Military : [CD54HC283](#), [CD54HCT283](#)

NOTE: Qualified Version Definitions:

- Catalog - TI's standard catalog product
- Military - QML certified for Military and Defense Applications

**TAPE AND REEL INFORMATION**

**QUADRANT ASSIGNMENTS FOR PIN 1 ORIENTATION IN TAPE**

\*All dimensions are nominal

Device	Package Type	Package Drawing	Pins	SPQ	Reel Diameter (mm)	Reel Width W1 (mm)	A0 (mm)	B0 (mm)	K0 (mm)	P1 (mm)	W (mm)	Pin1 Quadrant
CD74HC283M96	SOIC	D	16	2500	330.0	16.4	6.5	10.3	2.1	8.0	16.0	Q1
CD74HCT283M96	SOIC	D	16	2500	330.0	16.4	6.5	10.3	2.1	8.0	16.0	Q1



**TAPE AND REEL BOX DIMENSIONS**

\*All dimensions are nominal

Device	Package Type	Package Drawing	Pins	SPQ	Length (mm)	Width (mm)	Height (mm)
CD74HC283M96	SOIC	D	16	2500	340.5	336.1	32.0
CD74HCT283M96	SOIC	D	16	2500	340.5	336.1	32.0

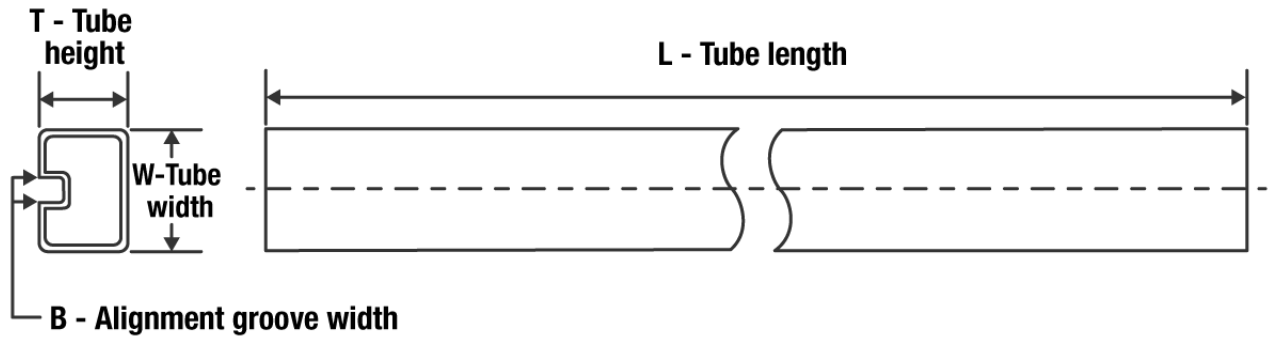
**TUBE**

\*All dimensions are nominal



Device	Package Name	Package Type	Pins	SPQ	L (mm)	W (mm)	T (μm)	B (mm)
CD74HC283E	N	PDIP	16	25	506	13.97	11230	4.32
CD74HC283E	N	PDIP	16	25	506	13.97	11230	4.32
CD74HC283M	D	SOIC	16	40	507	8	3940	4.32
CD74HC283ME4	D	SOIC	16	40	507	8	3940	4.32
CD74HCT283E	N	PDIP	16	25	506	13.97	11230	4.32
CD74HCT283E	N	PDIP	16	25	506	13.97	11230	4.32
CD74HCT283M	D	SOIC	16	40	507	8	3940	4.32
CD74HCT283MG4	D	SOIC	16	40	507	8	3940	4.32

D (R-PDSO-G16)

PLASTIC SMALL OUTLINE



4040047-6/M 06/11

- NOTES:
- A. All linear dimensions are in inches (millimeters).
  - B. This drawing is subject to change without notice.
  -  Body length does not include mold flash, protrusions, or gate burrs. Mold flash, protrusions, or gate burrs shall not exceed 0.006 (0,15) each side.
  -  Body width does not include interlead flash. Interlead flash shall not exceed 0.017 (0,43) each side.
  - E. Reference JEDEC MS-012 variation AC.

D (R-PDSO-G16)

PLASTIC SMALL OUTLINE



4211283-4/E 08/12

- NOTES:
- All linear dimensions are in millimeters.
  - This drawing is subject to change without notice.
  - Publication IPC-7351 is recommended for alternate designs.
  - Laser cutting apertures with trapezoidal walls and also rounding corners will offer better paste release. Customers should contact their board assembly site for stencil design recommendations. Refer to IPC-7525 for other stencil recommendations.
  - Customers should contact their board fabrication site for solder mask tolerances between and around signal pads.

J (R-GDIP-T\*\*)

14 LEADS SHOWN

CERAMIC DUAL IN-LINE PACKAGE



DIM \ PINS **	14	16	18	20
A	0.300 (7,62) BSC	0.300 (7,62) BSC	0.300 (7,62) BSC	0.300 (7,62) BSC
B MAX	0.785 (19,94)	.840 (21,34)	0.960 (24,38)	1.060 (26,92)
B MIN	—	—	—	—
C MAX	0.300 (7,62)	0.300 (7,62)	0.310 (7,87)	0.300 (7,62)
C MIN	0.245 (6,22)	0.245 (6,22)	0.220 (5,59)	0.245 (6,22)



4040083/F 03/03

- NOTES:
- A. All linear dimensions are in inches (millimeters).
  - B. This drawing is subject to change without notice.
  - C. This package is hermetically sealed with a ceramic lid using glass frit.
  - D. Index point is provided on cap for terminal identification only on press ceramic glass frit seal only.
  - E. Falls within MIL STD 1835 GDIP1-T14, GDIP1-T16, GDIP1-T18 and GDIP1-T20.

N (R-PDIP-T\*\*)

PLASTIC DUAL-IN-LINE PACKAGE

16 PINS SHOWN



- NOTES:
- A. All linear dimensions are in inches (millimeters).
  - B. This drawing is subject to change without notice.
  - C Falls within JEDEC MS-001, except 18 and 20 pin minimum body length (Dim A).
  - D The 20 pin end lead shoulder width is a vendor option, either half or full width.

4040049/E 12/2002

## IMPORTANT NOTICE AND DISCLAIMER

TI PROVIDES TECHNICAL AND RELIABILITY DATA (INCLUDING DATA SHEETS), DESIGN RESOURCES (INCLUDING REFERENCE DESIGNS), APPLICATION OR OTHER DESIGN ADVICE, WEB TOOLS, SAFETY INFORMATION, AND OTHER RESOURCES "AS IS" AND WITH ALL FAULTS, AND DISCLAIMS ALL WARRANTIES, EXPRESS AND IMPLIED, INCLUDING WITHOUT LIMITATION ANY IMPLIED WARRANTIES OF MERCHANTABILITY, FITNESS FOR A PARTICULAR PURPOSE OR NON-INFRINGEMENT OF THIRD PARTY INTELLECTUAL PROPERTY RIGHTS.

These resources are intended for skilled developers designing with TI products. You are solely responsible for (1) selecting the appropriate TI products for your application, (2) designing, validating and testing your application, and (3) ensuring your application meets applicable standards, and any other safety, security, regulatory or other requirements.

These resources are subject to change without notice. TI grants you permission to use these resources only for development of an application that uses the TI products described in the resource. Other reproduction and display of these resources is prohibited. No license is granted to any other TI intellectual property right or to any third party intellectual property right. TI disclaims responsibility for, and you will fully indemnify TI and its representatives against, any claims, damages, costs, losses, and liabilities arising out of your use of these resources.

TI's products are provided subject to [TI's Terms of Sale](#) or other applicable terms available either on [ti.com](http://ti.com) or provided in conjunction with such TI products. TI's provision of these resources does not expand or otherwise alter TI's applicable warranties or warranty disclaimers for TI products.

TI objects to and rejects any additional or different terms you may have proposed.

Mailing Address: Texas Instruments, Post Office Box 655303, Dallas, Texas 75265  
Copyright © 2022, Texas Instruments Incorporated