

TPS732-Q1 Automotive, Cap-Free, NMOS, 250mA, Low-Dropout Regulator With Reverse-Current Protection

1 Features

- AEC-Q100 qualified for automotive applications:
 - Temperature grade 0: -40°C to 150°C , T_A
 - Device HBM classification level 2
 - Device CDM classification level C4B
 - Device MM classification level M2
- Stable with no output capacitor or any value or type of capacitor
- Input voltage range: 1.7V to 5.5V
- Ultra-low dropout voltage: 40mV typical at 250mA
- Excellent load transient response—with or without optional output capacitor
- NMOS topology provides low reverse leakage current
- Low noise: $30\mu\text{V}_{\text{RMS}}$ typical (10kHz to 100kHz)
- Initial accuracy: 0.5%
- 1% overall accuracy (line, load, and temperature)
- Less than $1\mu\text{A}$ maximum I_Q in shutdown mode
- Thermal shutdown and specified minimum and maximum current limit protection
- Available in multiple output voltage versions:
 - Fixed outputs of 1.2V, 1.5V, 1.6V, 1.8V, 2.5V, 3V, 3.3V, and 5V
 - Adjustable outputs from 1.2V to 5.5V
 - Custom outputs available

2 Applications

- [Portable and battery-powered equipment](#)
- Post-regulation for switching supplies
- Noise-sensitive circuitry such as VCOs
- [Point of load regulation for DSPs, FPGAs, ASICs, and microprocessors](#)

3 Description

The TPS732-Q1 low-dropout (LDO) voltage regulator uses an NMOS topology consisting of an NMOS pass transistor in a voltage-follower configuration. This topology is stable using output capacitors with low ESR, and even allows operation without a capacitor. The topology also provides high reverse blockage (low reverse current) and ground pin current that is nearly constant over all values of output current.

The TPS732-Q1 uses an advanced BiCMOS process to yield high precision while delivering low dropout voltages and low ground pin current. Current consumption, when not enabled, is under $1\mu\text{A}$ and designed for portable applications. The extremely low output noise ($30\mu\text{V}_{\text{RMS}}$ with $0.1\mu\text{F}$ C_{NR}) is designed for powering VCOs. This device is protected by thermal shutdown and foldback current limit.

Package Information

| PART NUMBER | PACKAGE ⁽¹⁾ | PACKAGE SIZE ⁽²⁾ |
|-------------|------------------------|-----------------------------|
| TPS732-Q1 | DBV (SOT-23, 5) | 2.9mm × 2.8mm |
| | DCQ (SOT-223, 6) | 6.5mm × 7.06mm |
| | DRB (VSON, 8) | 3mm × 3mm |

(1) For more information, see the [Mechanical, Packaging, and Orderable Information](#).

(2) The package size (length × width) is a nominal value and includes pins, where applicable.

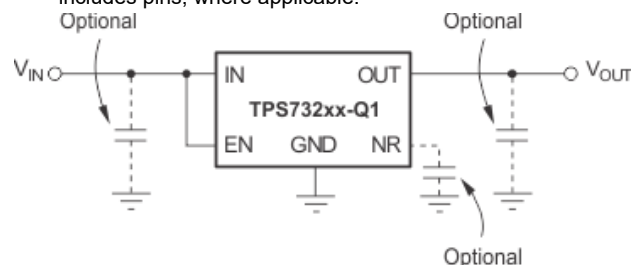

Copyright © 2016, Texas Instruments Incorporated

Typical Application Circuit for Fixed Voltage Versions



Table of Contents

| | | | |
|--|----|--|----|
| 1 Features | 1 | 6.4 Device Functional Modes..... | 18 |
| 2 Applications | 1 | 7 Application and Implementation | 19 |
| 3 Description | 1 | 7.1 Application Information..... | 19 |
| 4 Pin Configuration and Functions | 3 | 7.2 Typical Application..... | 19 |
| 5 Specifications | 4 | 7.3 Power Supply Recommendations..... | 22 |
| 5.1 Absolute Maximum Ratings..... | 4 | 7.4 Layout..... | 22 |
| 5.2 ESD Ratings..... | 4 | 8 Device and Documentation Support | 27 |
| 5.3 Recommended Operating Conditions..... | 4 | 8.1 Documentation Support..... | 27 |
| 5.4 Thermal Information..... | 4 | 8.2 Receiving Notification of Documentation Updates.... | 27 |
| 5.5 Thermal Information..... | 5 | 8.3 Support Resources..... | 27 |
| 5.6 Electrical Characteristics..... | 6 | 8.4 Trademarks..... | 27 |
| 5.7 Switching Characteristics..... | 6 | 8.5 Electrostatic Discharge Caution..... | 27 |
| 5.8 Typical Characteristics..... | 7 | 8.6 Glossary..... | 27 |
| 6 Detailed Description | 16 | 9 Revision History | 27 |
| 6.1 Overview..... | 16 | 10 Mechanical, Packaging, and Orderable Information | 28 |
| 6.2 Functional Block Diagram..... | 16 | | |
| 6.3 Feature Description..... | 16 | | |

4 Pin Configuration and Functions

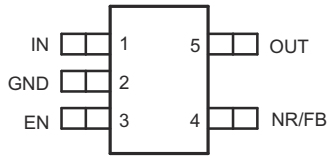

Figure 4-1. DBV Package 5-Pin SOT-23 Top View

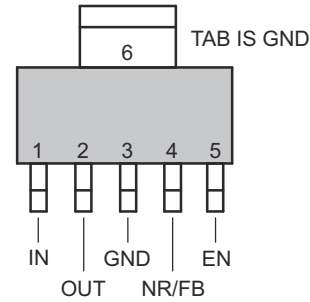
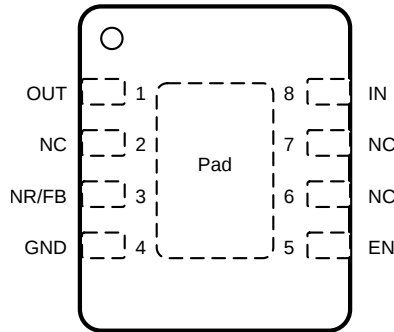

Figure 4-2. DCQ Package, 6-Pin SOT-223 (Top View)



NC: No internal connection

Figure 4-3. DRB Package 8-Pin VSON With Exposed Thermal Pad Top View

Table 4-1. Pin Functions

| NAME | PIN | | | TYPE (1) | DESCRIPTION |
|-------------------|------------|-------------|---------|-------------|--|
| | NO. | | | | |
| | SOT-2 3 | SOT-2 23 | VSON | | |
| EN | 3 | 5 | 5 | I | Driving the enable pin (EN) high turns on the regulator. Driving this pin low puts the regulator into shutdown mode. See Shutdown for more details. EN can be connected to IN if not used. |
| FB ⁽²⁾ | 4 | 4 | 3 | I | Input to the control loop error amplifier, and is used to set the output voltage of the device. |
| GND | 2 | 3, 6 | 4 | — | Ground |
| IN | 1 | 1 | 8 | I | Unregulated input supply |
| NR ⁽³⁾ | 4 | 4 | 3 | — | Connecting an external capacitor to this pin bypasses noise generated by the internal band gap. This allows output noise to be reduced to low levels. |
| OUT | 5 | 2 | 1 | O | Output of the regulator. There are no output capacitor requirements for stability. |
| Pad | — | — | Pad | — | Ground |
| NC | — | — | 2, 6, 7 | — | No internal connection |

(1) I = Input; O = Output.

(2) Adjustable voltage versions only.

(3) Fixed voltage versions only.

5 Specifications

5.1 Absolute Maximum Ratings

over operating junction temperature range (unless otherwise noted)⁽¹⁾

| | | MIN | MAX | UNIT |
|------------------------------------|---------------------------|--------------------------------|-----|------|
| Voltage | Input, V_{IN} | -0.3 | 6 | V |
| | Enable, V_{EN} | -0.3 | 6 | |
| | Output, V_{OUT} | -0.3 | 5.5 | |
| | V_{NR} , V_{FB} | -0.3 | 6 | |
| Current | Maximum output, I_{OUT} | Internally limited | | |
| Output short-circuit duration | | Indefinite | | |
| Continuous total power dissipation | P_{DISS} | See <i>Thermal Information</i> | | |
| Temperature | Operating junction, T_J | -55 | 150 | °C |
| | Storage, T_{stg} | -65 | 150 | |

- (1) Operation outside the *Absolute Maximum Ratings* may cause permanent device damage. *Absolute Maximum Ratings* do not imply functional operation of the device at these or any other conditions beyond those listed under *Recommended Operating Conditions*. If used outside the *Recommended Operating Conditions* but within the *Absolute Maximum Ratings*, the device may not be fully functional, and this may affect device reliability, functionality, performance, and shorten the device lifetime.

5.2 ESD Ratings

| | | | VALUE | UNIT |
|-------------|-------------------------|---|-------|------|
| $V_{(ESD)}$ | Electrostatic discharge | Human-body model (HBM), per AEC Q100-002 ⁽¹⁾ | ±4000 | V |
| | | Charged-device model (CDM), per AEC Q100-011 | ±1000 | |
| | | Machine model (MM) (legacy silicon only) | ±200 | |

- (1) AEC Q100-002 indicates that HBM stressing shall be in accordance with the ANSI/ESDA/JEDEC JS-001 specification.

5.3 Recommended Operating Conditions

over operating junction temperature range (unless otherwise noted)

| | | MIN | NOM | MAX | UNIT |
|-----------|--------------------------------|-----|-----|-----|------|
| V_{IN} | Input supply voltage | 1.7 | | 5.5 | V |
| I_{OUT} | Output current | 0 | | 250 | mA |
| T_J | Operating junction temperature | -40 | | 125 | °C |

5.4 Thermal Information

| THERMAL METRIC ⁽¹⁾ | | TPS732-Q1 New silicon | | UNIT |
|-------------------------------|--|-----------------------|---------------|------|
| | | DRB (VSON) | DCQ (SOT-223) | |
| | | 8 PINS | 6 PINS | |
| $R_{\theta JA}$ | Junction-to-ambient thermal resistance | 47.7 | 76 | °C/W |
| $R_{\theta JC(top)}$ | Junction-to-case (top) thermal resistance | 68.9 | 46.6 | °C/W |
| $R_{\theta JB}$ | Junction-to-board thermal resistance | 20.6 | 18.1 | °C/W |
| ψ_{JT} | Junction-to-top characterization parameter | 3.4 | 8.6 | °C/W |
| ψ_{JB} | Junction-to-board characterization parameter | 20.6 | 17.6 | °C/W |
| $R_{\theta JC(bot)}$ | Junction-to-case (bottom) thermal resistance | 3.5 | N/A | °C/W |

- (1) For more information about traditional and new thermal metrics, see the [Semiconductor and IC Package Thermal Metrics](#) application note.

5.5 Thermal Information

| THERMAL METRIC ⁽¹⁾ | | TPS732-Q1 Legacy silicon | | UNIT |
|-------------------------------|--|--------------------------|------------|------|
| | | DBV (SOT-23) | DRB (VSON) | |
| | | 5 PINS | 8 PINS | |
| R _{θJA} | Junction-to-ambient thermal resistance | 180 | 47.8 | °C/W |
| R _{θJC(top)} | Junction-to-case (top) thermal resistance | 64 | 83 | °C/W |
| R _{θJB} | Junction-to-board thermal resistance | 35 | – | °C/W |
| ψ _{JT} | Junction-to-top characterization parameter | – | 2.1 | °C/W |
| ψ _{JB} | Junction-to-board characterization parameter | – | 17.8 | °C/W |
| R _{θJC(bot)} | Junction-to-case (bottom) thermal resistance | – | 12.1 | °C/W |

- (1) For more information about traditional and new thermal metrics, see the [Semiconductor and IC Package Thermal Metrics](#) application note.

5.6 Electrical Characteristics

Over operating temperature range ($T_J = -40^\circ\text{C}$ to 125°C), $V_{IN} = V_{OUT(nom)} + 0.5V^{(1)}$, $I_{OUT} = 10\text{mA}$, $V_{EN} = 1.7\text{V}$, and $C_{OUT} = 0.1\mu\text{F}$ (unless otherwise noted). Typical values are at $T_J = 25^\circ\text{C}$

| PARAMETER | | TEST CONDITIONS | | MIN | TYP | MAX | UNIT |
|----------------------------------|--|--|---|-----------------|-----------|----------------|---------------------|
| V_{FB} | Internal reference (TPS73201-Q1) | $T_J = 25^\circ\text{C}$ | | 1.198 | 1.204 | 1.210 | V |
| V_{OUT} | Output voltage range (TPS73201-Q1) ⁽²⁾ | | | V_{FB} | | 5.5 - V_{DO} | V |
| | Accuracy ⁽¹⁾ | Nominal | $T_J = 25^\circ\text{C}$ | -0.5 | 0.5 | | % |
| | | V_{IN} , I_{OUT} , and T | $V_{OUT} + 0.5\text{V} \leq V_{IN} \leq 5.5\text{V}$; $10\text{mA} \leq I_{OUT} \leq 250\text{mA}$ | -1 | ± 0.5 | 1 | |
| $\Delta V_{OUT(\Delta V_{IN})}$ | Line regulation | $(V_{OUT(nom)} + 0.5\text{V}) \leq V_{IN} \leq 5.5\text{V}$ | $(V_{OUT(nom)} + 0.5\text{V}) \leq V_{IN} \leq 5.5\text{V}$ | 0.06 | | | %/V |
| $\Delta V_{OUT(\Delta I_{OUT})}$ | Load regulation | $1\text{mA} \leq I_{OUT} \leq 250\text{mA}$ | $1\text{mA} \leq I_{OUT} \leq 250\text{mA}$ | 0.002 | | | %/mA |
| $\Delta V_{OUT(\Delta I_{OUT})}$ | Load regulation | $10\text{mA} \leq I_{OUT} \leq 250\text{mA}$ | $10\text{mA} \leq I_{OUT} \leq 250\text{mA}$ | 0.0008 | | | %/mA |
| V_{DO} | Dropout voltage ⁽³⁾ ($V_{IN} = V_{OUT(NOM)} - 0.1\text{V}$) | $I_{OUT} = 250\text{mA}$ | | | 40 | 150 | mV |
| $Z_{O(DO)}$ | Output impedance in dropout | $1.7\text{V} \leq V_{IN} \leq V_{OUT} + V_{DO}$ | | 0.25 | | | Ω |
| I_{CL} | Output current limit | $V_{OUT} = 0.9 \times V_{OUT(nom)}$ | | 250 | 425 | 600 | mA |
| I_{SC} | Short-circuit current | $V_{OUT} = 0\text{V}$ | | 300 | | | mA |
| I_{REV} | Reverse leakage current ⁽⁴⁾ ($-I_{IN}$) | $V_{EN} \leq 0.5\text{V}$, $0\text{V} \leq V_{IN} \leq V_{OUT}$ | | 0.1 | | 10 | μA |
| I_{GND} | Ground pin current | $I_{OUT} = 10\text{mA}$ (I_Q) | | 400 | | 550 | μA |
| I_{GND} | Ground pin current | $I_{OUT} = 250\text{mA}$ | | 650 | | 950 | μA |
| I_{SHDN} | Shutdown current (I_{GND}) | $V_{EN} \leq 0.5\text{V}$, $V_{OUT} \leq V_{IN} \leq 5.5\text{V}$ | $V_{EN} \leq 0.5\text{V}$, $V_{OUT} \leq V_{IN} \leq 5.5\text{V}$ | 0.02 | | 1 | μA |
| I_{FB} | Feedback pin current (TPS73201) | | | 0.1 | | 0.45 | μA |
| PSRR | Power-supply rejection ratio (ripple rejection) | $f = 100\text{Hz}$, $I_{OUT} = 250\text{mA}$ | | 58 | | | dB |
| | | $f = 10\text{kHz}$, $I_{OUT} = 250\text{mA}$ | | 37 | | | |
| V_N | Output noise voltage, BW = 10Hz to 100kHz | $C_{OUT} = 10\mu\text{F}$, no C_{NR} | | 27 x V_{OUT} | | | μV_{RMS} |
| | | $C_{OUT} = 10\mu\text{F}$, $C_{NR} = 0.01\mu\text{F}$ | | 8.5 x V_{OUT} | | | |
| $V_{EN(high)}$ | EN pin high (enabled) | | | 1.7 | V_{IN} | | V |
| $V_{EN(low)}$ | EN pin low (shutdown) | | | 0 | 0.5 | | V |
| $I_{EN(high)}$ | Enable pin current (enabled) | $V_{EN} = 5.5\text{V}$ | | 0.02 | | 0.1 | μA |
| T_{SD} | Thermal shutdown temperature | Shutdown, temperature increasing | | 160 | | | $^\circ\text{C}$ |
| | | Reset, temperature decreasing | | 140 | | | |

(1) Minimum $V_{IN} = V_{OUT} + V_{DO}$ or 1.7V, whichever is greater.

(2) TPS73201-Q1 is tested at $V_{OUT} = 2.5\text{V}$.

(3) V_{DO} is not measured for output versions with $V_{OUT(nom)} < 1.8\text{V}$, because minimum $V_{IN} = 1.7\text{V}$.

(4) Fixed-voltage versions only; refer to *Application Information* section for more information.

5.7 Switching Characteristics

over operating free-air temperature range (unless otherwise noted)

| PARAMETER | | TEST CONDITIONS | MIN | TYP | MAX | UNIT |
|-----------|---------------|--|-----|-----|-----|---------------|
| t_{STR} | Start-up time | $V_{OUT} = 3\text{V}$, $R_L = 30\Omega$, $C_{OUT} = 1\mu\text{F}$, $C_{NR} = 0.01\mu\text{F}$ | | 600 | | μs |

5.8 Typical Characteristics

for all voltage versions at $T_J = 25^\circ\text{C}$, $V_{IN} = V_{OUT(nom)} + 0.5\text{ V}$, $I_{OUT} = 10\text{ mA}$, $V_{EN} = 1.7\text{ V}$, and $C_{OUT} = 0.1\text{ }\mu\text{F}$ (unless otherwise noted)

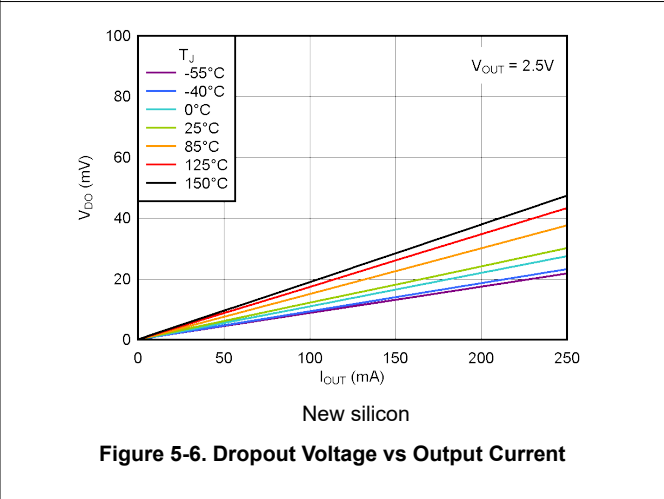
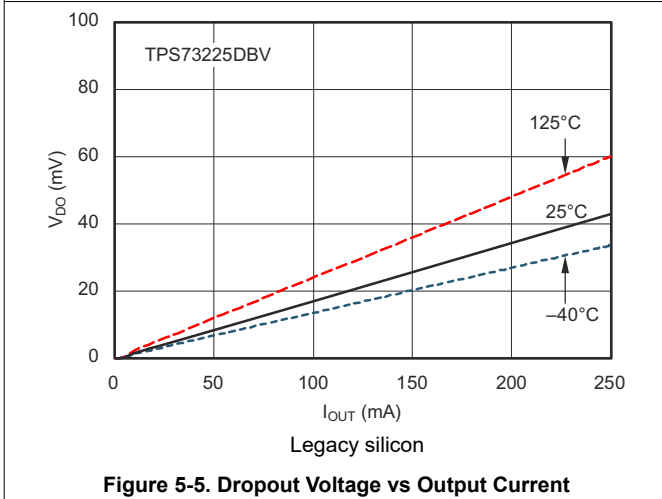
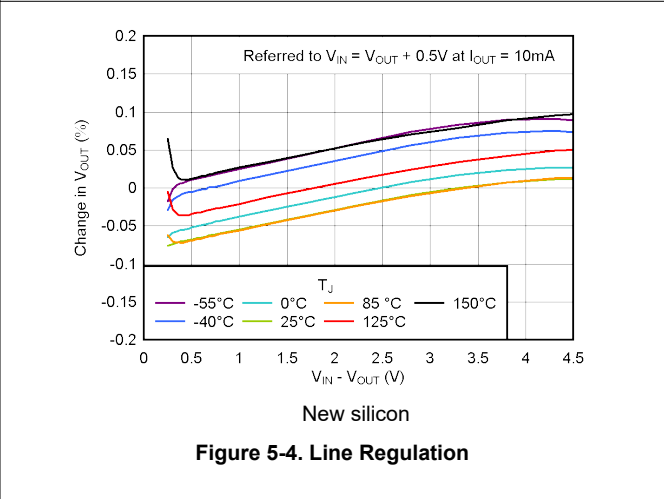
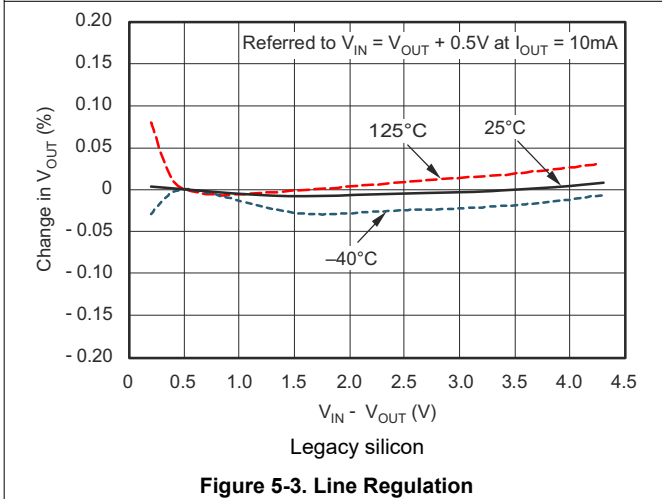
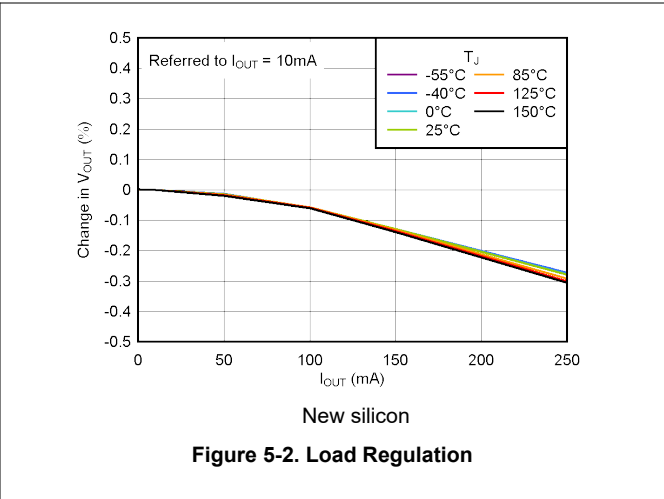
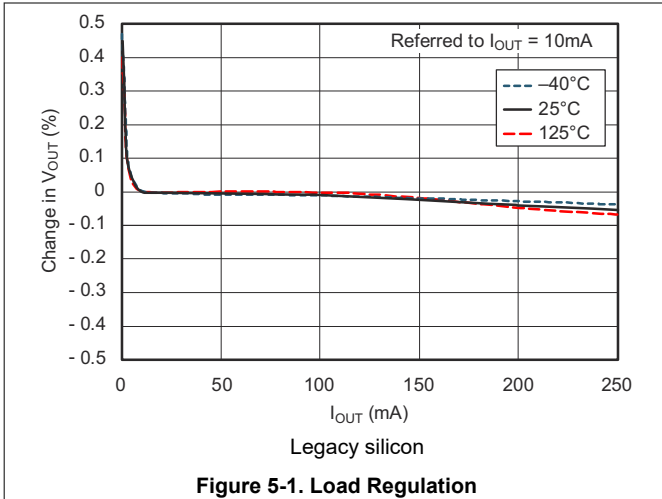

5.8 Typical Characteristics (continued)

for all voltage versions at $T_J = 25^\circ\text{C}$, $V_{IN} = V_{OUT(nom)} + 0.5\text{ V}$, $I_{OUT} = 10\text{ mA}$, $V_{EN} = 1.7\text{ V}$, and $C_{OUT} = 0.1\text{ }\mu\text{F}$ (unless otherwise noted)

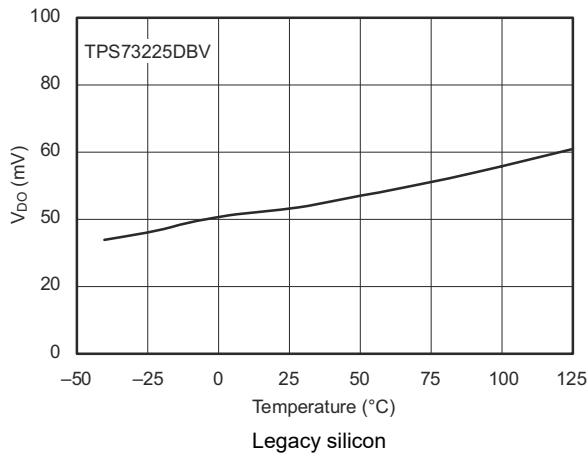

Figure 5-7. Dropout Voltage vs Temperature

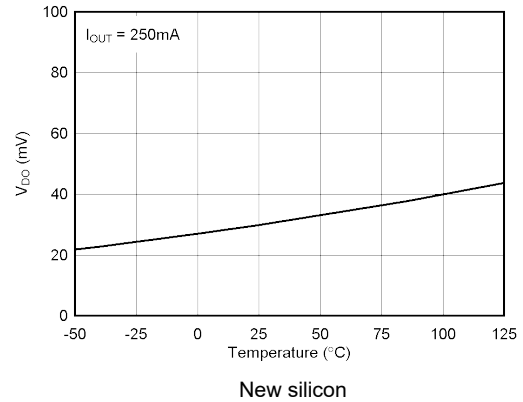

Figure 5-8. Dropout Voltage vs Temperature

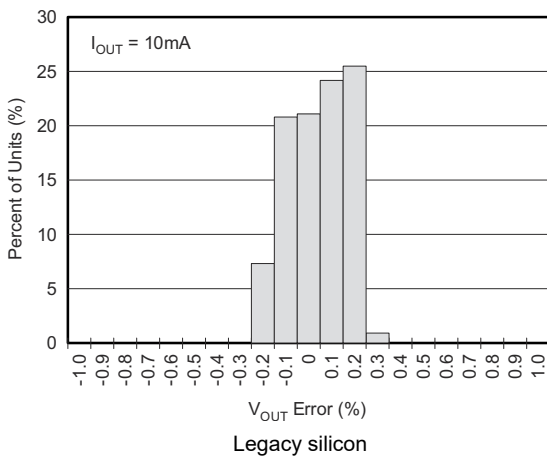

Figure 5-9. Output Voltage Accuracy Histogram

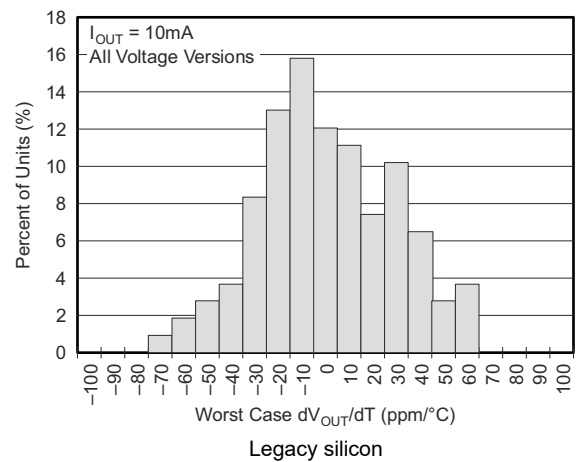

Figure 5-10. Output Voltage Drift Histogram

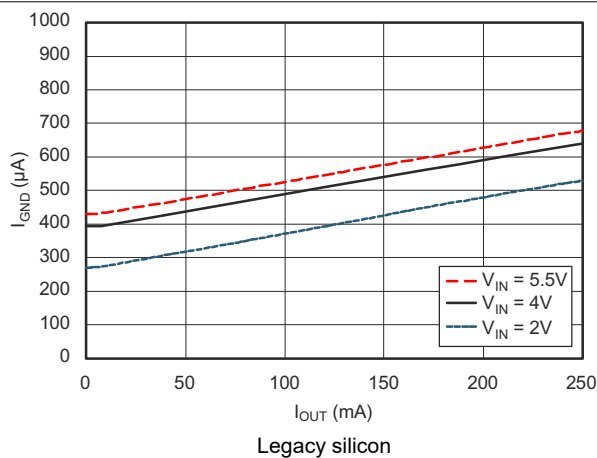

Figure 5-11. Ground Pin Current vs Output Current

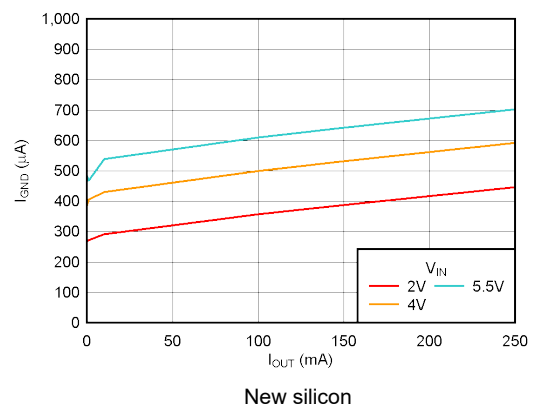

Figure 5-12. Ground Pin Current vs Output Current

5.8 Typical Characteristics (continued)

for all voltage versions at $T_J = 25^\circ\text{C}$, $V_{IN} = V_{OUT(nom)} + 0.5\text{ V}$, $I_{OUT} = 10\text{ mA}$, $V_{EN} = 1.7\text{ V}$, and $C_{OUT} = 0.1\text{ }\mu\text{F}$ (unless otherwise noted)

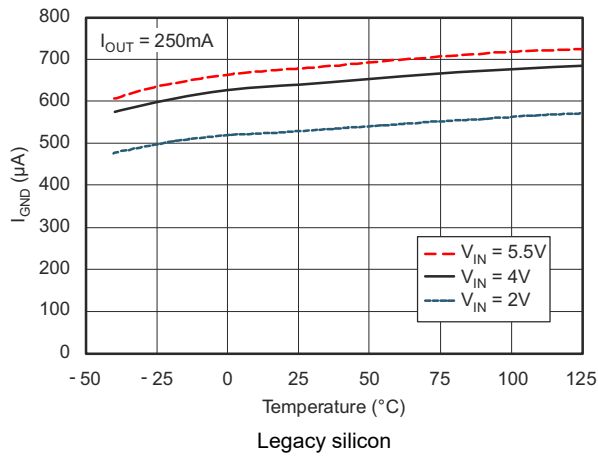

Figure 5-13. Ground Pin Current vs Temperature

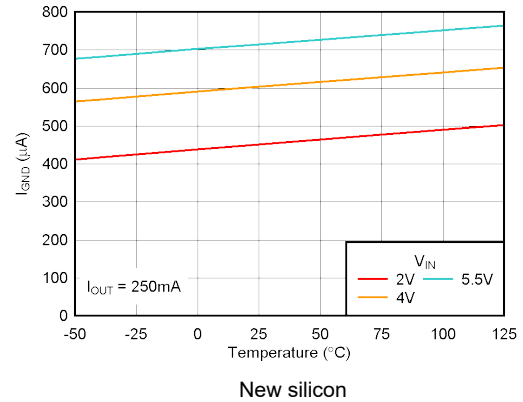

Figure 5-14. Ground Pin Current vs Temperature

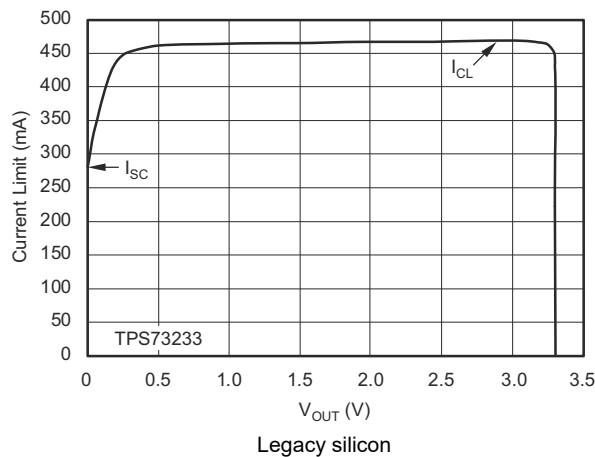

Figure 5-15. Current Limit vs V_{OUT} (FOLDBACK)

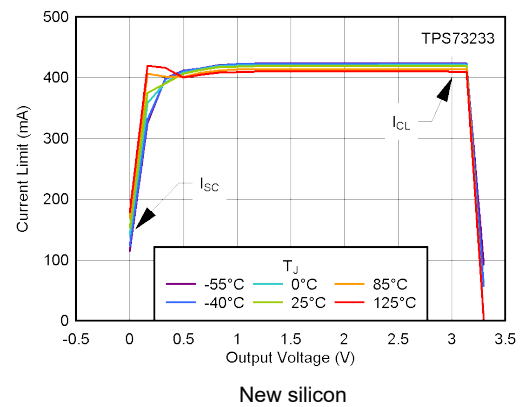

Figure 5-16. Current Limit vs V_{OUT} (Foldback)

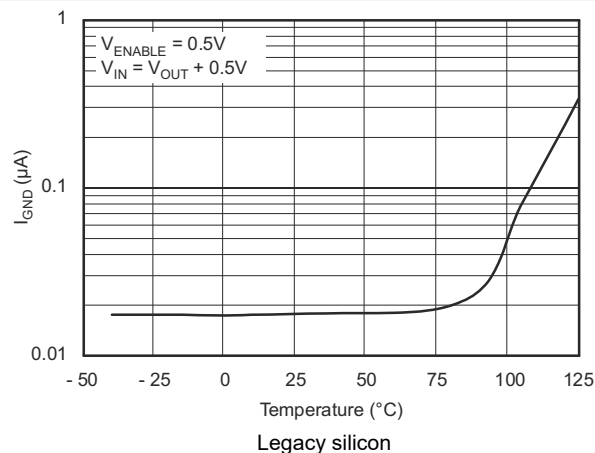

Figure 5-17. Ground Pin Current in Shutdown vs Temperature

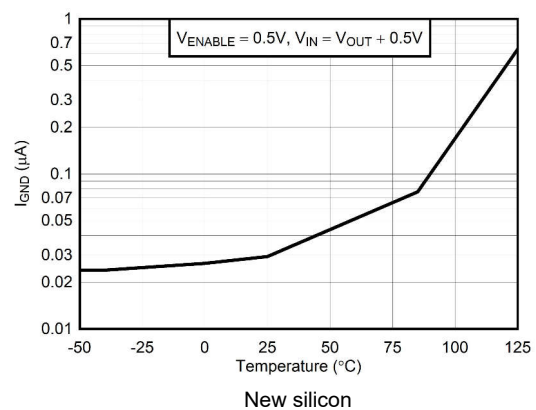
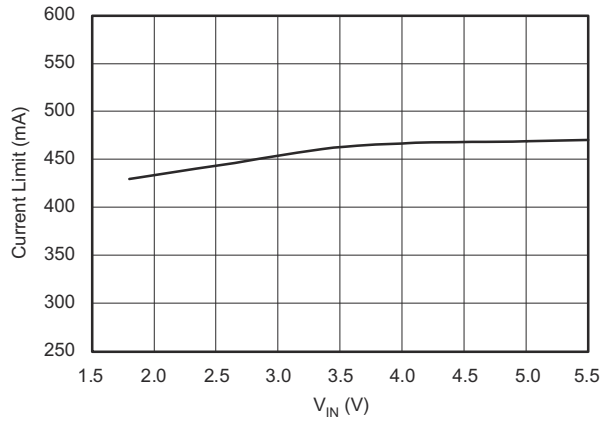

Figure 5-18. Ground Pin Current in Shutdown vs Temperature

5.8 Typical Characteristics (continued)

for all voltage versions at $T_J = 25^\circ\text{C}$, $V_{IN} = V_{OUT(nom)} + 0.5\text{ V}$, $I_{OUT} = 10\text{ mA}$, $V_{EN} = 1.7\text{ V}$, and $C_{OUT} = 0.1\text{ }\mu\text{F}$ (unless otherwise noted)



Legacy silicon
Figure 5-19. Current Limit vs V_{IN}

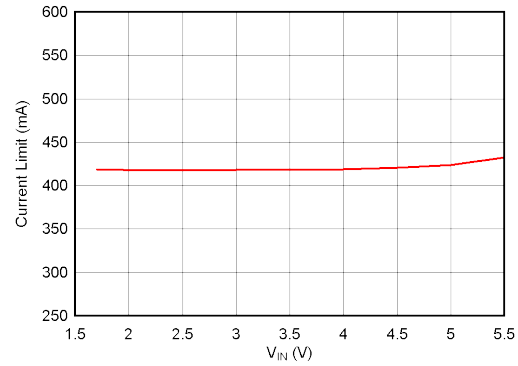

New silicon
Figure 5-20. Current Limit vs V_{IN}

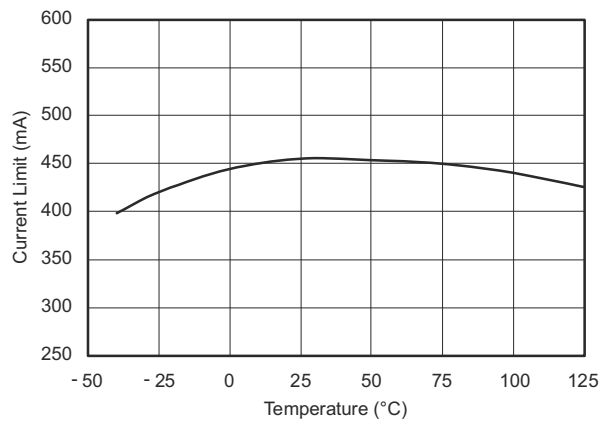

Legacy silicon
Figure 5-21. Current Limit vs Temperature

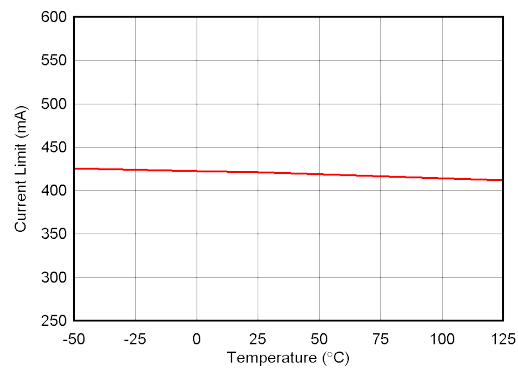

New silicon
Figure 5-22. Current Limit vs Temperature

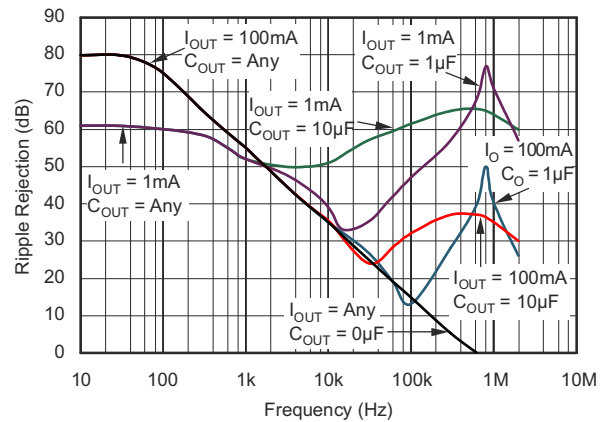

Legacy silicon
Figure 5-23. PSRR (Ripple Rejection) vs Frequency

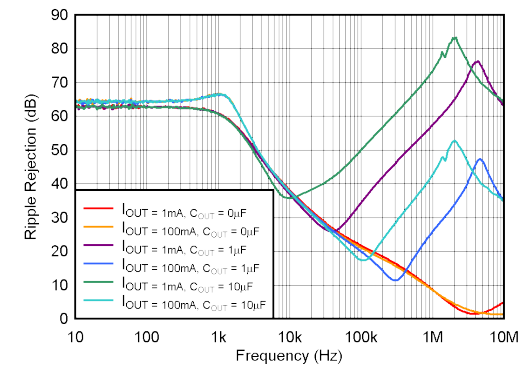

New silicon
Figure 5-24. PSRR (Ripple Rejection) vs Frequency

5.8 Typical Characteristics (continued)

for all voltage versions at $T_J = 25^\circ\text{C}$, $V_{IN} = V_{OUT(nom)} + 0.5\text{ V}$, $I_{OUT} = 10\text{ mA}$, $V_{EN} = 1.7\text{ V}$, and $C_{OUT} = 0.1\text{ }\mu\text{F}$ (unless otherwise noted)

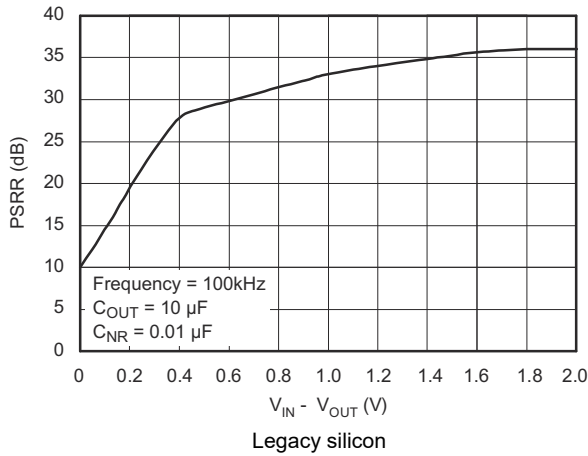

Figure 5-25. PSRR (Ripple Rejection) vs $V_{IN} - V_{OUT}$

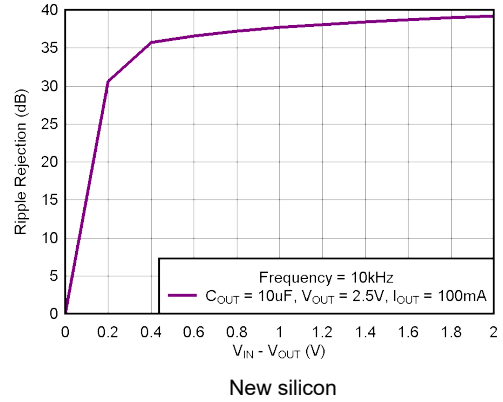

Figure 5-26. PSRR (Ripple Rejection) vs $V_{IN} - V_{OUT}$

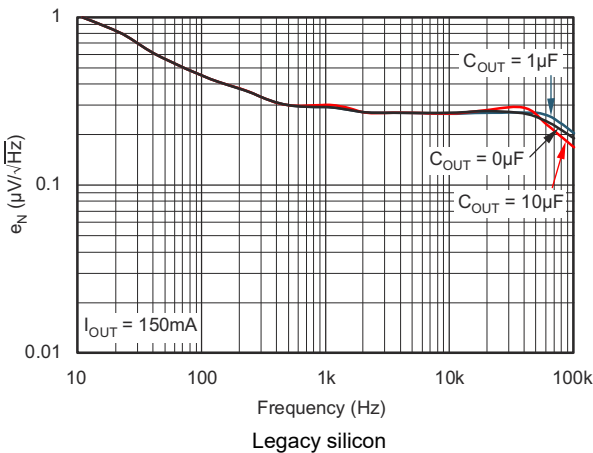

Figure 5-27. Noise Spectral Density vs $C_{NR} = 0\text{ }\mu\text{F}$

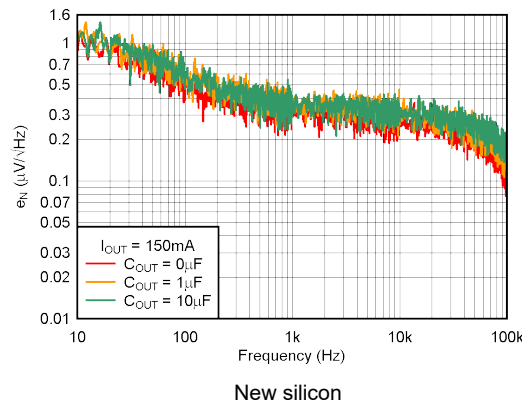

Figure 5-28. Noise Spectral Density $C_{NR} = 0\text{ }\mu\text{F}$

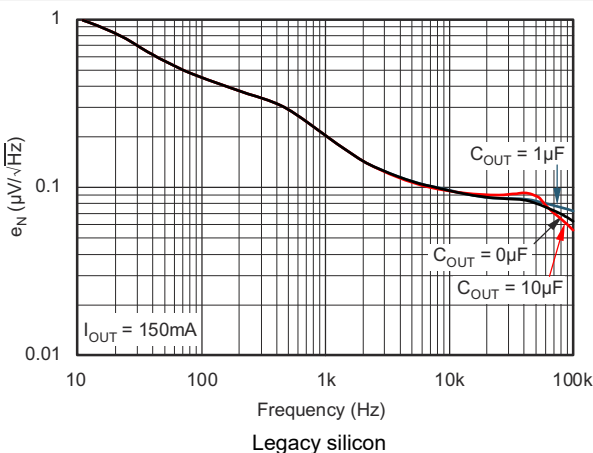

Figure 5-29. Noise Spectral Density vs $C_{NR} = 0.01\text{ }\mu\text{F}$

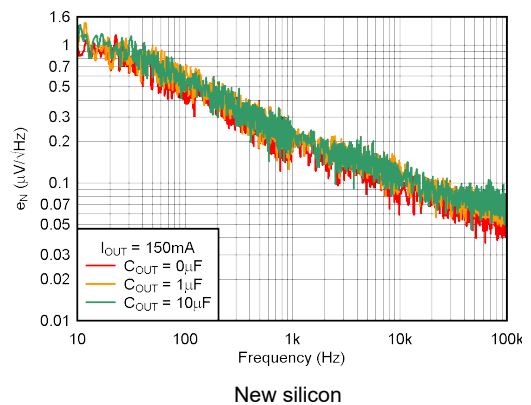

Figure 5-30. Noise Spectral Density $C_{NR} = 0.01\text{ }\mu\text{F}$

5.8 Typical Characteristics (continued)

for all voltage versions at $T_J = 25^\circ\text{C}$, $V_{IN} = V_{OUT(nom)} + 0.5\text{ V}$, $I_{OUT} = 10\text{ mA}$, $V_{EN} = 1.7\text{ V}$, and $C_{OUT} = 0.1\text{ }\mu\text{F}$ (unless otherwise noted)

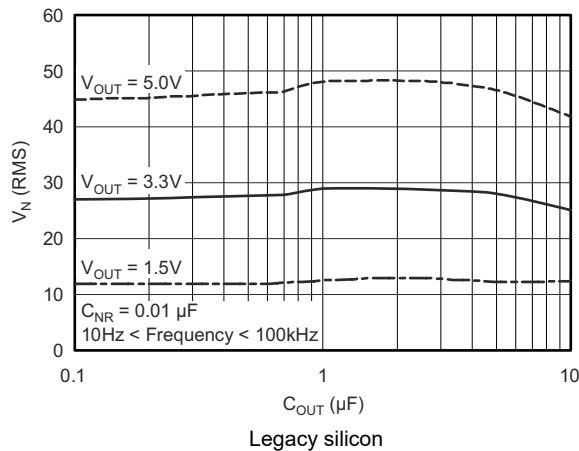

Figure 5-31. RMS Noise Voltage vs C_{OUT}

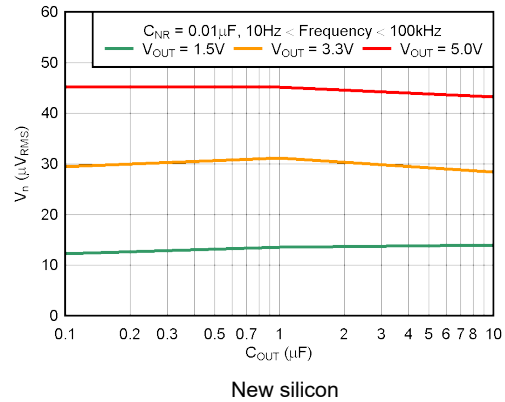

Figure 5-32. RMS Noise Voltage vs C_{OUT}

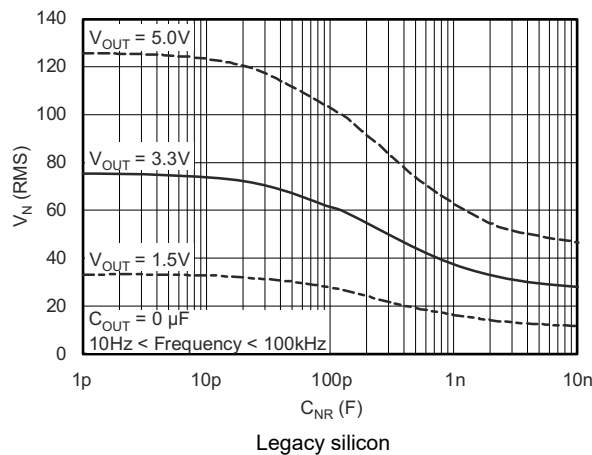

Figure 5-33. RMS Noise Voltage vs C_{NR}

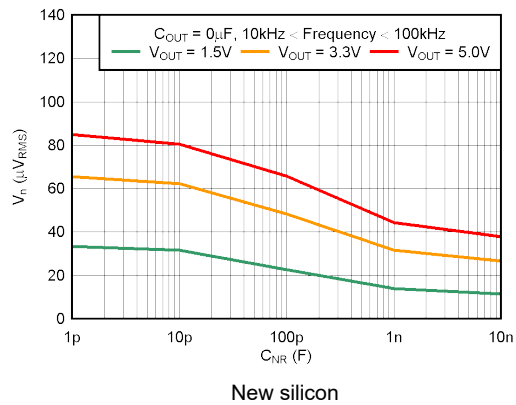

Figure 5-34. RMS Noise Voltage vs C_{NR}

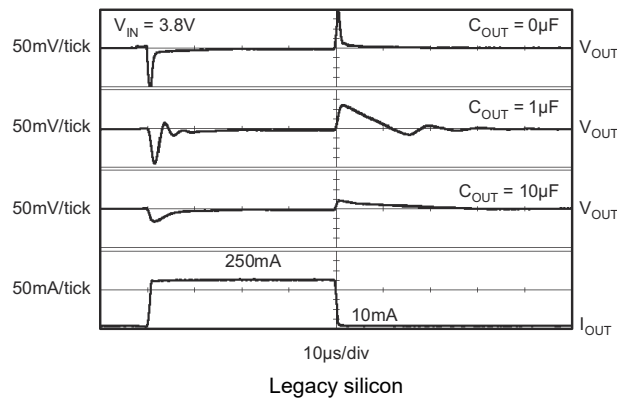

Figure 5-35. TPS73233-Q1 – Load Transient Response

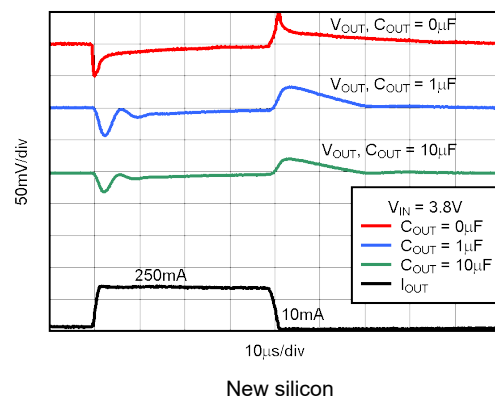

Figure 5-36. TPS73233-Q1 Load Transient Response

5.8 Typical Characteristics (continued)

for all voltage versions at $T_J = 25^\circ\text{C}$, $V_{IN} = V_{OUT(nom)} + 0.5\text{ V}$, $I_{OUT} = 10\text{ mA}$, $V_{EN} = 1.7\text{ V}$, and $C_{OUT} = 0.1\text{ }\mu\text{F}$ (unless otherwise noted)

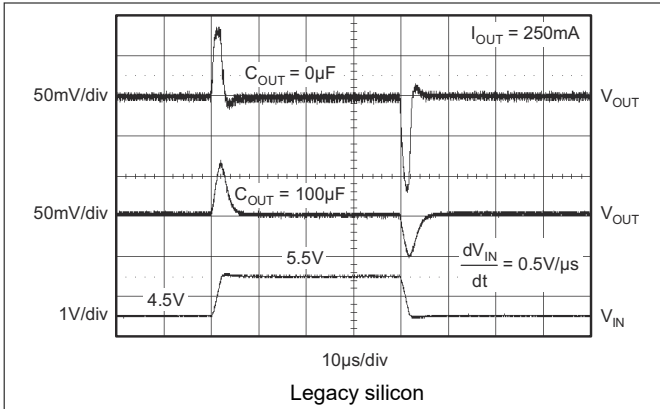

Figure 5-37. TPS73233-Q1 – Line Transient Response

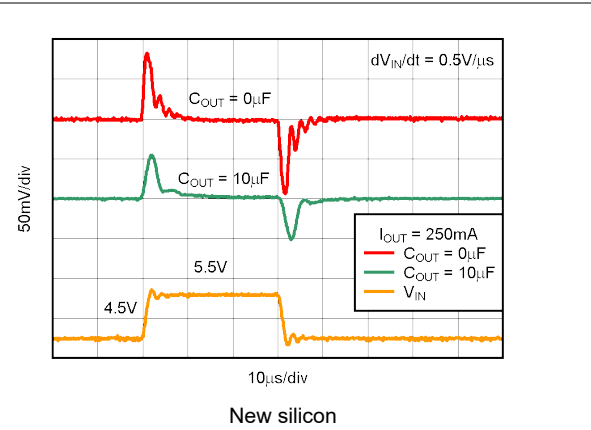

Figure 5-38. TPS73233-Q1 Line Transient Response

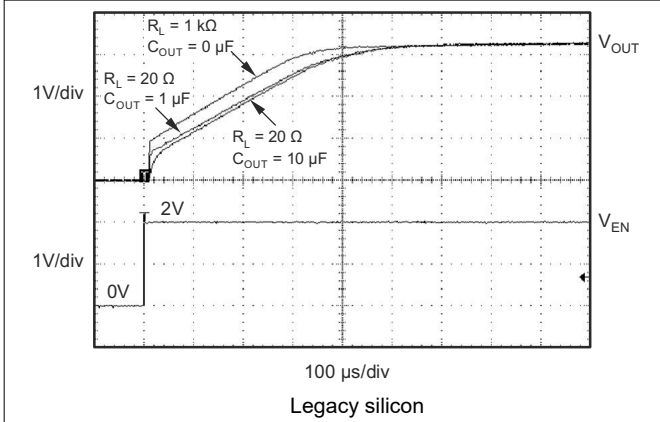

Figure 5-39. TPS73233-Q1 – Turnon Response

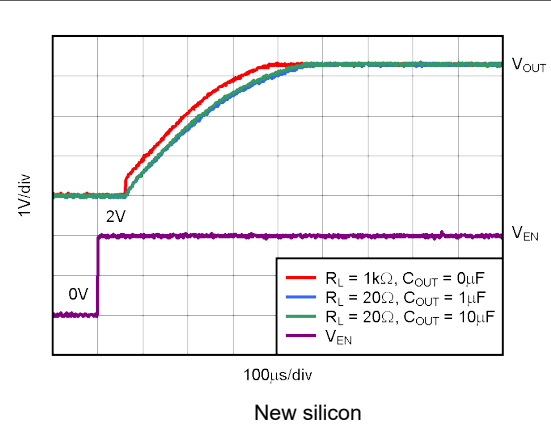

Figure 5-40. TPS73233-Q1 Turn-On Response

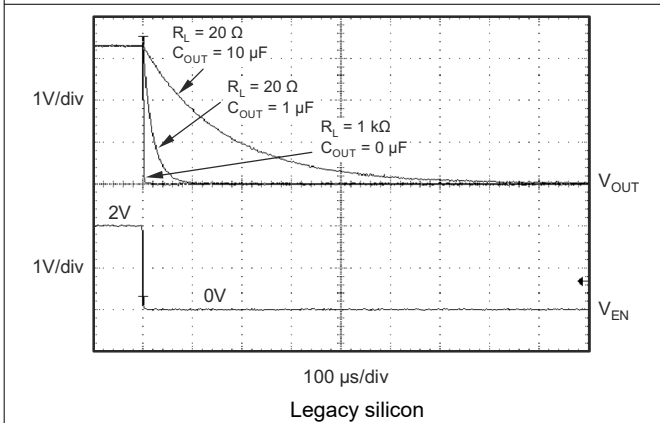

Figure 5-41. TPS73233-Q1 – Turnoff Response

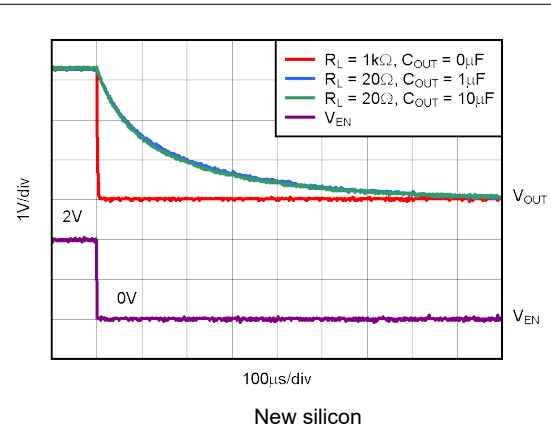

Figure 5-42. TPS73233-Q1 Turn-Off Response

TPS732-Q1

SGLS303G – MAY 2005 – REVISED DECEMBER 2024

5.8 Typical Characteristics (continued)

for all voltage versions at $T_J = 25^\circ\text{C}$, $V_{IN} = V_{OUT(nom)} + 0.5\text{ V}$, $I_{OUT} = 10\text{ mA}$, $V_{EN} = 1.7\text{ V}$, and $C_{OUT} = 0.1\text{ }\mu\text{F}$ (unless otherwise noted)

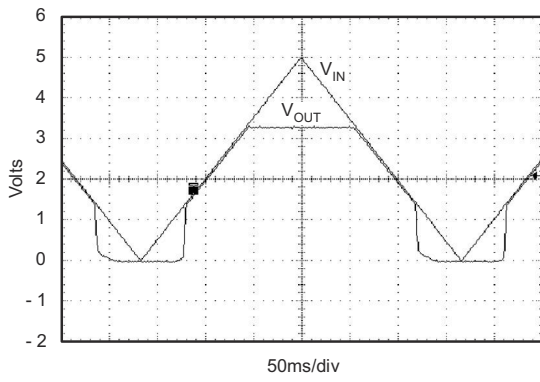

Legacy silicon
Figure 5-43. TPS73233-Q1 – Power Up and Power Down

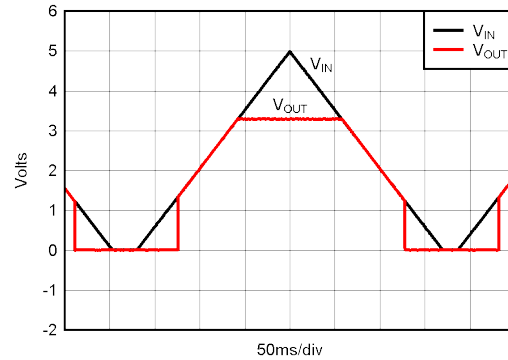

New silicon
Figure 5-44. TPS73233-Q1 Power-Up and Power-Down

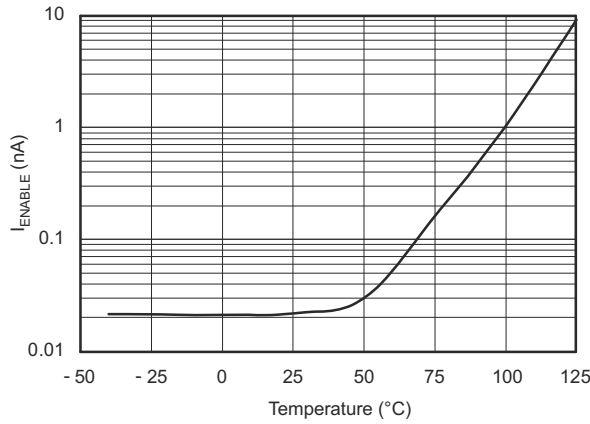

Legacy silicon
Figure 5-45. I_{ENABLE} vs Temperature

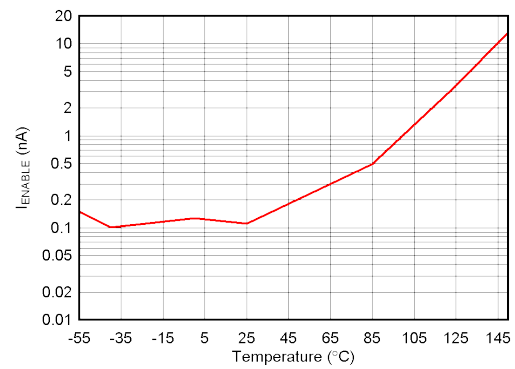

New silicon
Figure 5-46. I_{ENABLE} vs Temperature

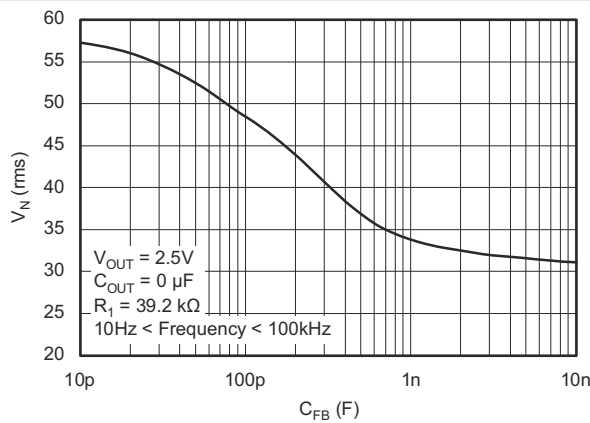

Legacy silicon
Figure 5-47. TPS73201-Q1 – RMS Noise Voltage vs C_{ADJ}

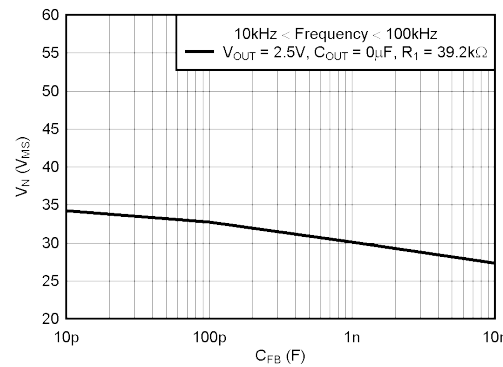

New silicon
Figure 5-48. TPS73201-Q1 RMS Noise Voltage vs C_{FB}

5.8 Typical Characteristics (continued)

for all voltage versions at $T_J = 25^\circ\text{C}$, $V_{IN} = V_{OUT(nom)} + 0.5\text{ V}$, $I_{OUT} = 10\text{ mA}$, $V_{EN} = 1.7\text{ V}$, and $C_{OUT} = 0.1\text{ }\mu\text{F}$ (unless otherwise noted)

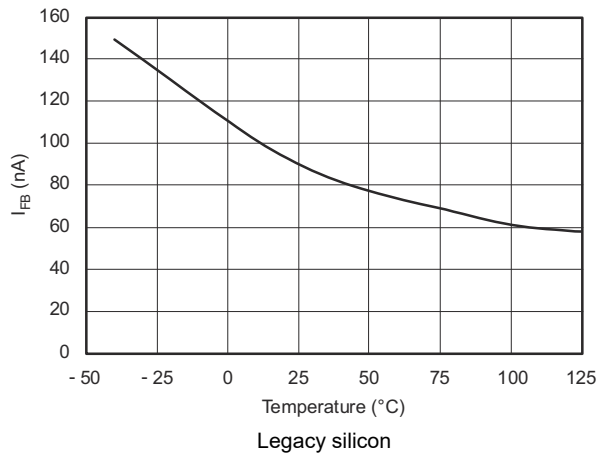

Figure 5-49. TPS73201-Q1 – I_{FB} vs Temperature

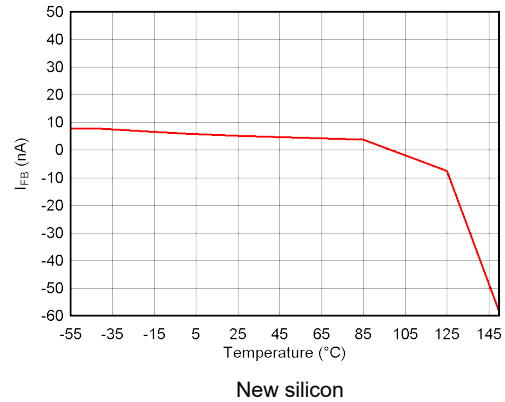

Figure 5-50. TPS73201-Q1 I_{FB} vs Temperature

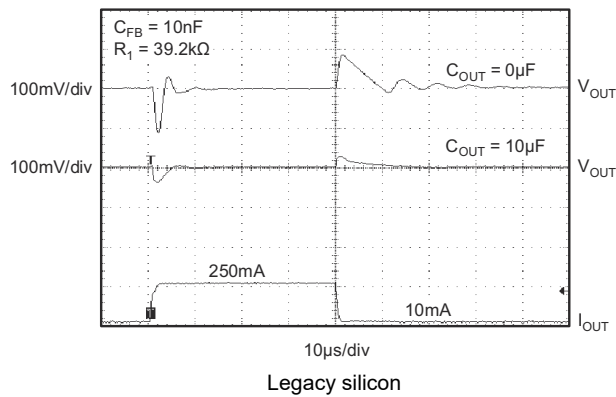

Figure 5-51. TPS73201-Q1 – Load Transient, Adjustable Version

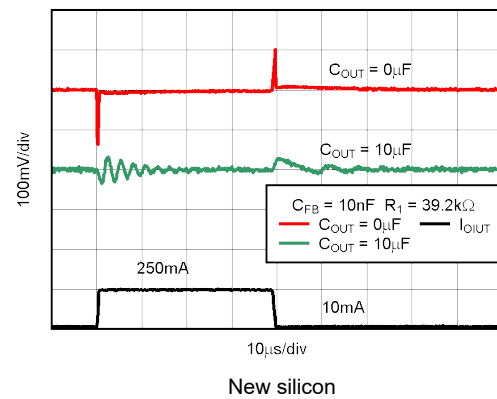

Figure 5-52. TPS73201-Q1 Load Transient, Adjustable Version

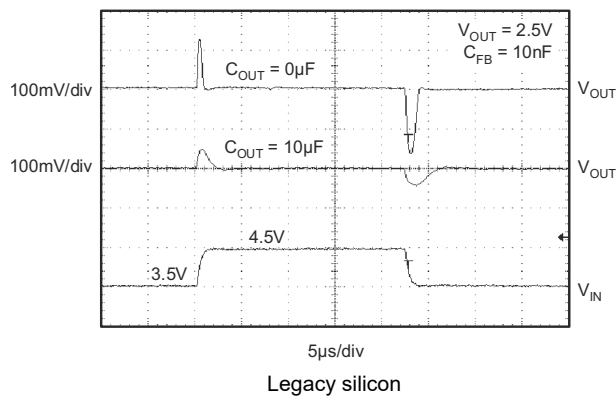

Figure 5-53. TPS73201-Q1 – Line Transient, Adjustable Version

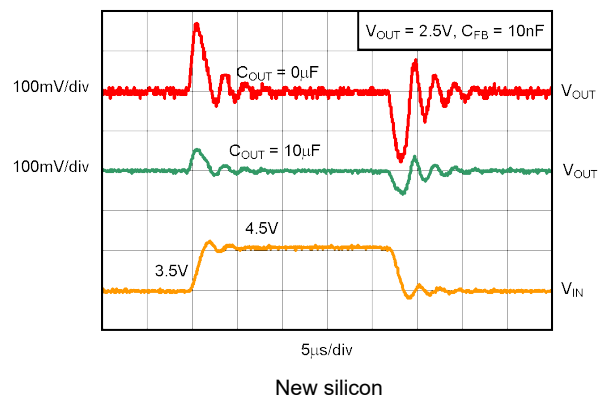

Figure 5-54. TPS73201-Q1 Line Transient, Adjustable Version

6 Detailed Description

6.1 Overview

The TPS732-Q1 low-dropout linear regulator devices operate with an input voltage down to 1.7 V and support output voltages down to 1.2 V while sourcing up to 250 mA of load current. These linear regulators use an NMOS pass element with an integrated 4-MHz charge pump to provide a dropout voltage of less than 150 mV at full load current. This unique architecture also permits stable regulation over a wide range of output capacitors. In fact, the TPS732-Q1 family of devices does not require any output capacitor for stability. The increased insensitivity to the output capacitor value and type makes this family of linear regulators an ideal choice when powering a load where the effective capacitance is unknown. The TPS732-Q1 family of devices also features a noise reduction (NR) pin that allows for additional reduction of the output noise. The low noise output featured by the TPS732-Q1 family makes the device well-suited for powering VCOs or any other noise-sensitive load.

6.2 Functional Block Diagram

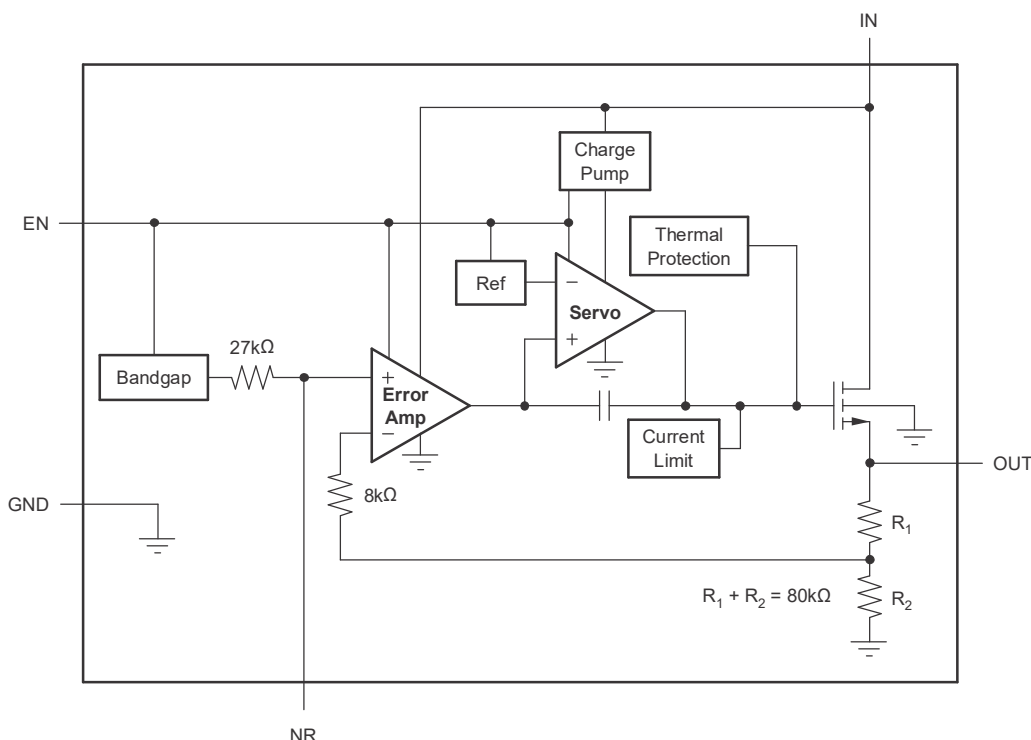

Fixed voltage version.

6.3 Feature Description

6.3.1 Internal Current Limit

The TPS732-Q1 internal current limit helps protect the regulator during fault conditions. Foldback helps to protect the regulator from damage during output short-circuit conditions by reducing current limit when V_{OUT} drops below 0.5 V. See [Figure 5-15](#).

6.3.2 Shutdown

The enable pin is active high and is compatible with standard TTL-CMOS levels. V_{EN} below 0.5 V (maximum) turns the regulator off and drops the ground pin current to approximately 10 nA. When shutdown capability is not required, the Enable pin can be connected to V_{IN} . When a pullup resistor is used, and operation down to 1.8 V is required, use pullup resistor values below 50 kΩ.

6.3.3 Dropout Voltage

The TPS732-Q1 family of devices uses an NMOS pass transistor to achieve extremely low dropout. When $(V_{IN} - V_{OUT})$ is less than the dropout voltage (V_{DO}), the NMOS pass device is in the linear region of operation and the input-to-output resistance is the R_{DS-ON} of the NMOS pass element.

For large step changes in load current, the TPS732-Q1 family of devices requires a larger voltage drop from V_{IN} to V_{OUT} to avoid degraded transient response. The boundary of this transient dropout region is approximately twice the dc dropout. Values of $V_{IN} - V_{OUT}$ above this line provide normal transient response.

Operating in the transient dropout region can cause an increase in recovery time. The time required to recover from a load transient is a function of the magnitude of the change in load current rate, the rate of change in load current, and the available headroom (V_{IN} to V_{OUT} voltage drop). Under worst-case conditions [full-scale instantaneous load change with $(V_{IN} - V_{OUT})$ close to dc dropout levels], the TPS732-Q1 family of devices can take a couple of hundred microseconds to return to the specified regulation accuracy.

6.3.4 Transient Response

The low open-loop output impedance provided by the NMOS pass element in a voltage follower configuration allows operation without an output capacitor for many applications. As with any regulator, the addition of a capacitor (nominal value 1 μ F) from the output pin to ground reduces undershoot magnitude but increase duration. In the adjustable version, the addition of a capacitor, C_{FB} , from the output to the adjust pin also improves the transient response.

The TPS732-Q1 family of devices does not have active pulldown when the output is over-voltage. This allows applications that connect higher voltage sources, such as alternate power supplies, to the output. This also results in an output overshoot of several percent if the load current quickly drops to zero when a capacitor is connected to the output. The duration of overshoot can be reduced by adding a load resistor. The overshoot decays at a rate determined by output capacitor C_{OUT} and the internal and external load resistance. The rate of decay is given by [Equation 1](#) and [Equation 2](#):

(Fixed voltage version)

$$dV / dt = \frac{V_{OUT}}{C_{OUT} \times 80 \text{ k}\Omega} \quad (1)$$

(Adjustable voltage version)

$$dV / dt = \frac{V_{OUT}}{C_{OUT} \times 80 \text{ k}\Omega \parallel (R_1 + R_2)} \quad (2)$$

6.3.5 Reverse Current

The NMOS pass element of the TPS732-Q1 family of devices provides inherent protection against current flow from the output of the regulator to the input when the gate of the pass device is pulled low. To ensure that all charge is removed from the gate of the pass element, the enable pin must be driven low before the input voltage is removed. If this is not done, the pass element can be left on due to stored charge on the gate.

After the enable pin is driven low, no bias voltage is needed on any pin for reverse current blocking. Note that reverse current is specified as the current flowing out of the IN pin due to voltage applied on the OUT pin. There is additional current flowing into the OUT pin due to the 80-k Ω internal resistor divider to ground (see the [Functional Block Diagram](#) and [Figure 7-3](#)).

For the TPS73201-Q1, reverse current can flow when V_{FB} is more than 1 V above V_{IN} .

6.3.6 Thermal Protection

Thermal protection disables the output when the junction temperature rises to approximately 160°C, allowing the device to cool. When the junction temperature cools to approximately 140°C, the output circuitry is again enabled. Depending on power dissipation, thermal resistance, and ambient temperature, the thermal protection circuit can cycle on and off. This limits the dissipation of the regulator, protecting the device from damage due to overheating.

Any tendency to activate the thermal protection circuit indicates excessive power dissipation or an inadequate heatsink. For reliable operation, junction temperature must be limited to 125°C maximum. To estimate the margin of safety in a complete design (including heatsink), increase the ambient temperature until the thermal protection is triggered; use worst-case loads and signal conditions. For good reliability, thermal protection must trigger at least 35°C above the maximum expected ambient condition of your application. This produces a worst-case junction temperature of 125°C at the highest expected ambient temperature and worst-case load.

The internal protection circuitry of the TPS732-Q1 family of devices is designed to protect against overload conditions. The protection circuitry is not intended to replace proper heatsinking. Continuously running the TPS732-Q1 family of devices into thermal shutdown degrades device reliability.

6.4 Device Functional Modes

6.4.1 Normal Operation

The TPS732-Q1 family of devices require an input voltage of at least 1.7V to function properly and attempt to maintain regulation.

When operating the device near 5.5V, take care to suppress any transient spikes that can exceed the 6V absolute maximum voltage rating. The device must never operate at a DC voltage greater than 5.5V.

7 Application and Implementation

Note

Information in the following applications sections is not part of the TI component specification, and TI does not warrant its accuracy or completeness. TI's customers are responsible for determining suitability of components for their purposes, as well as validating and testing their design implementation to confirm system functionality.

7.1 Application Information

The TPS732-Q1 belongs to a family of new generation LDO regulators that use an NMOS pass transistor to achieve ultra-low-dropout performance, reverse current blockage, and freedom from output capacitor constraints. These features, combined with low noise and an enable input, make the TPS732-Q1 family of devices ideal for portable applications. This regulator family offers a wide selection of fixed output voltage versions and an adjustable output version. All versions have thermal and overcurrent protection, including foldback current limit.

7.2 Typical Application

Figure 7-1 shows the basic circuit connections for the fixed voltage models. Figure 7-2 gives the connections for the adjustable output version (TPS73201-Q1).

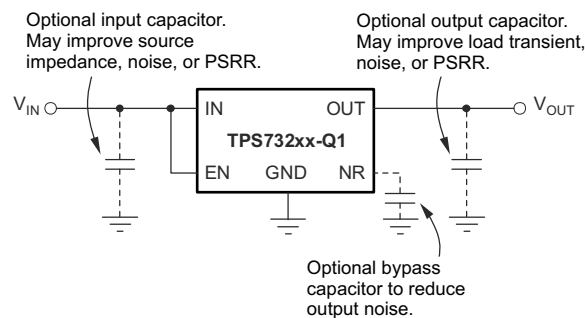

Copyright © 2016, Texas Instruments Incorporated

Figure 7-1. Typical Application Circuit for Fixed-Voltage Versions

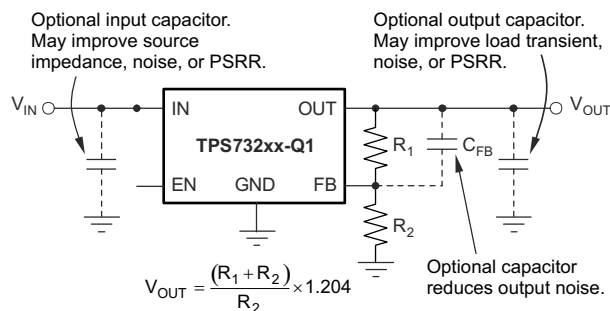

Copyright © 2016, Texas Instruments Incorporated

Figure 7-2. Typical Application Circuit for Adjustable-Voltage Versions

7.2.1 Design Requirements

R_1 and R_2 can be calculated for any output voltage using the formula shown in Figure 7-2. Sample resistor values for common output voltages are shown in Figure 7-3. For best accuracy, make the parallel combination of R_1 and R_2 approximately 19 k Ω .

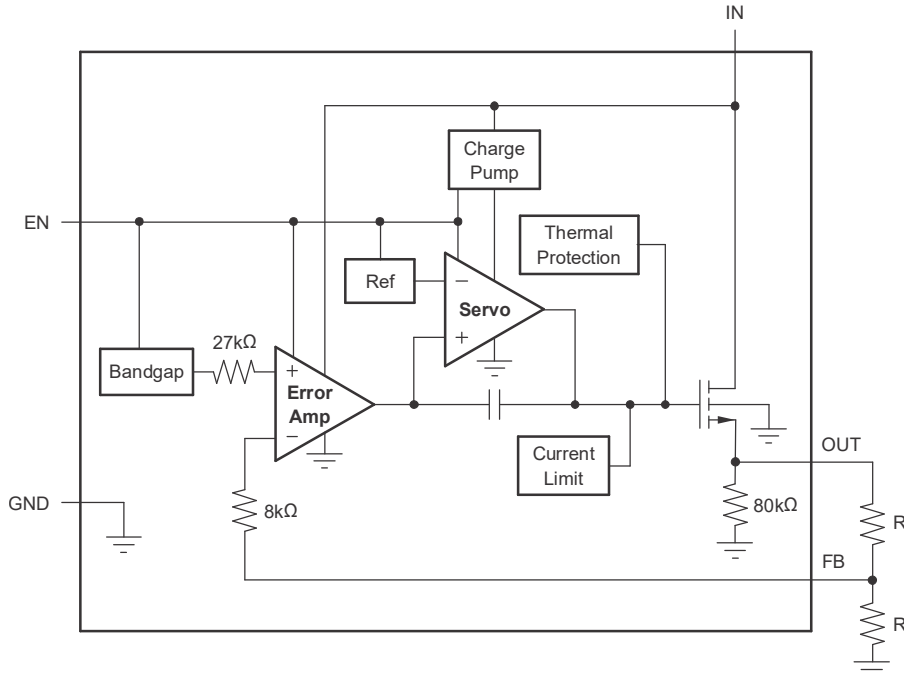

$$V_{OUT} = (R_1 + R_2) / R_2 \times 1.204$$

$$R_1 \parallel R_2 \cong 19 \text{ k}\Omega \text{ for best accuracy.}$$

Figure 7-3. Adjustable Voltage Version

Table 7-1. Standard 1% Resistor Values for Common Output Voltages

| V _{OUT} | R ₁ | R ₂ |
|------------------|-----------------|-----------------|
| 1.2 V | Short | Open |
| 1.5 V | 23.2 k Ω | 95.3 k Ω |
| 1.8 V | 28 k Ω | 56.2 k Ω |
| 2.5 V | 39.2 k Ω | 36.5 k Ω |
| 2.8 V | 44.2 k Ω | 33.2 k Ω |
| 3 V | 46.4 k Ω | 30.9 k Ω |
| 3.3 V | 52.3 k Ω | 30.1 k Ω |
| 5 V | 78.7 k Ω | 24.9 k Ω |

7.2.2 Detailed Design Procedure

7.2.2.1 Input and Output Capacitor Requirements

Although an input capacitor is not required for stability, good analog design practice is to connect a 0.1µF to 1µF low ESR capacitor across the input supply near the regulator. This counteracts reactive input sources and improves transient response, noise rejection, and ripple rejection. A higher-value capacitor can be necessary if large, fast rise-time load transients are anticipated or the device is located several inches from the power source.

The TPS732-Q1 family of devices does not require an output capacitor for stability and has maximum phase margin with no capacitor. The devices are designed to be stable for all available types and values of capacitors. In applications where $V_{IN} - V_{OUT} < 0.5V$ and multiple low ESR capacitors are in parallel, ringing can occur when the product of C_{OUT} and total ESR drops below $50nF \times \Omega$. Total ESR includes all parasitic resistances, including capacitor ESR and board, socket, and solder joint resistance. In most applications, the sum of capacitor ESR and trace resistance meets this requirement.

7.2.2.2 Output Noise

A precision band-gap reference is used to generate the internal reference voltage, V_{REF} . This reference is the dominant noise source within the TPS732-Q1 family of devices and generates approximately $32 \mu V_{RMS}$ (10 Hz to 100 kHz) at the reference output (NR). The regulator control loop gains up the reference noise with the same gain as the reference voltage, so that the noise voltage of the regulator is approximately given by:

$$V_N = 32 \mu V_{RMS} \times \frac{(R_1 + R_2)}{R_2} = 32 \mu V_{RMS} \times \frac{V_{OUT}}{V_{REF}} \quad (3)$$

Because the value of V_{REF} is 1.2 V, this relationship reduces to:

$$V_N(\mu V_{RMS}) = 27 \left(\frac{\mu V_{RMS}}{V} \right) \times V_{OUT}(V) \quad (4)$$

where

- C_{NR} does not exist

An internal 27-kΩ resistor in series with the noise reduction pin (NR) forms a low-pass filter for the voltage reference when an external noise reduction capacitor, C_{NR} , is connected from NR to ground. For $C_{NR} = 10$ nF, the total noise in the 10-Hz to 100-kHz bandwidth is reduced by a factor of approximately 3.2, giving the approximate relationship:

$$V_N(\mu V_{RMS}) = 8.5 \left(\frac{\mu V_{RMS}}{V} \right) \times V_{OUT}(V) \quad (5)$$

where

- $C_{NR} = 10$ nF

This noise reduction effect is shown as *RMS Noise Voltage vs C_{NR}* in [Typical Characteristics](#).

The TPS73201-Q1 adjustable version does not have the noise-reduction pin available. However, connecting a feedback capacitor, C_{FB} , from the output to the FB pin reduces output noise and improve load transient performance.

The TPS732-Q1 family of devices uses an internal charge pump to develop an internal supply voltage sufficient to drive the gate of the NMOS pass element above V_{OUT} . The charge pump generates approximately 250 µV of switching noise at approximately 2 MHz; however, charge-pump noise contribution is negligible at the output of the regulator for most values of I_{OUT} and C_{OUT} .

7.2.3 Application Curves

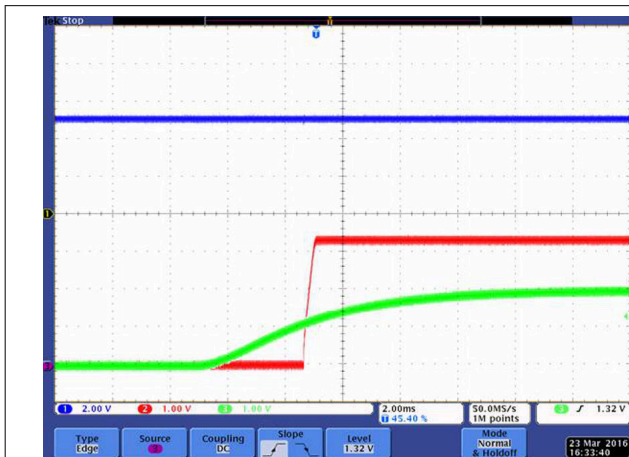

Legacy silicon

Figure 7-4. Start-Up

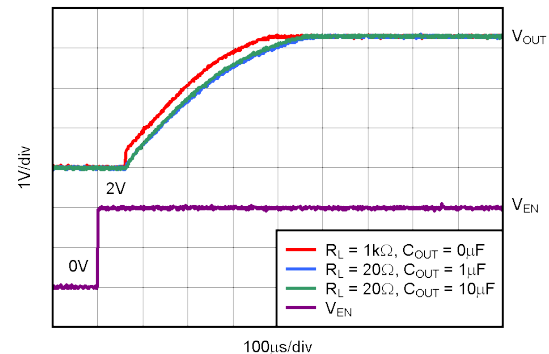

New silicon

Figure 7-5. Start-up

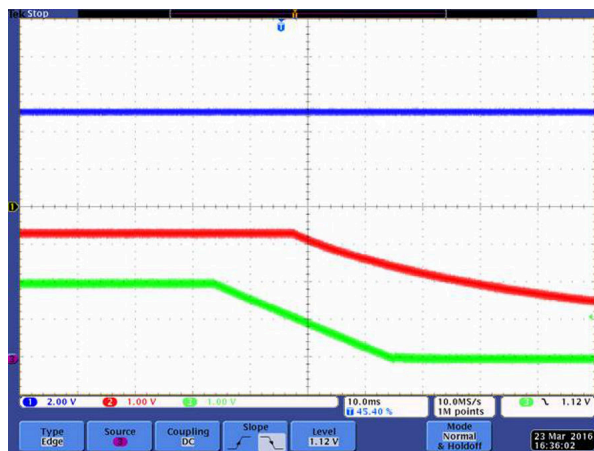

Legacy silicon

Figure 7-6. Shutdown

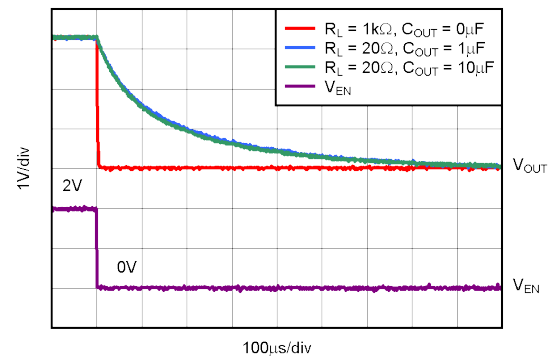

New silicon

Figure 7-7. Shutdown

7.3 Power Supply Recommendations

These devices are designed to operate from an input voltage supply range from 1.7 V to 5.5 V. The input voltage range provides adequate headroom for the device to have a regulated output. This input supply must be well regulated. If the input supply is noisy, additional input capacitors with low ESR can help improve the output noise performance.

7.4 Layout

7.4.1 Layout Guidelines

To improve ac performance such as PSRR, output noise, and transient response, design the PCB with ground plane connections for V_{IN} and V_{OUT} capacitors, and the ground plane connected at the GND pin of the device. In addition, the ground connection for the bypass capacitor must connect directly to the GND pin of the device.

7.4.2 Layout Example

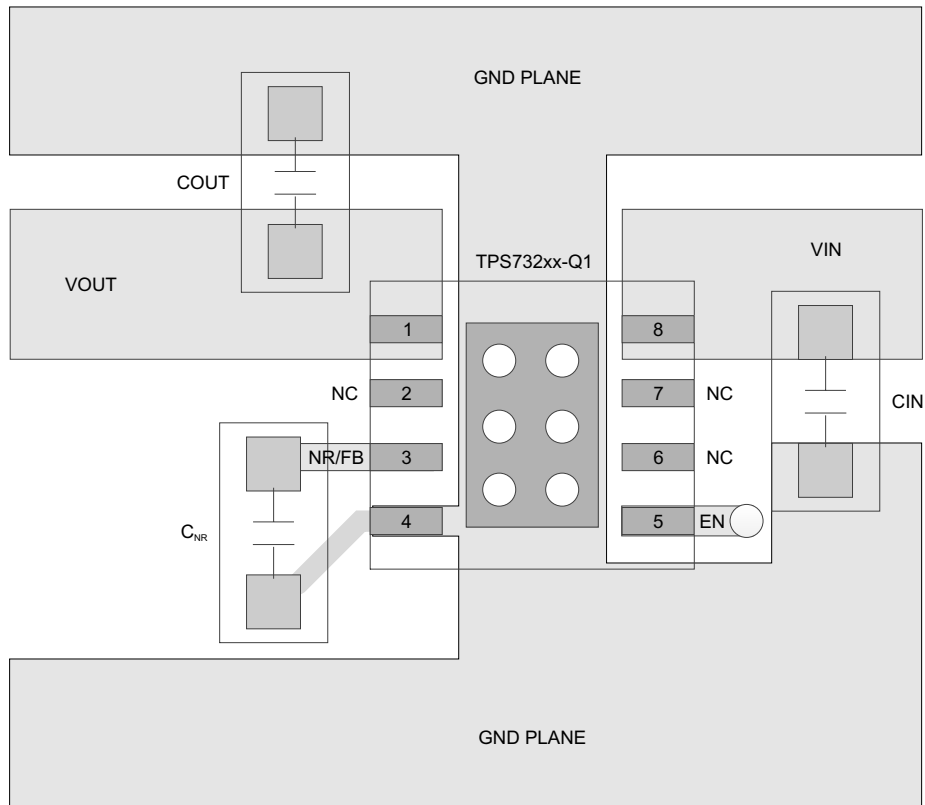

Copyright © 2016, Texas Instruments Incorporated

Figure 7-8. Fixed Output Voltage Option Layout (DRB Package)

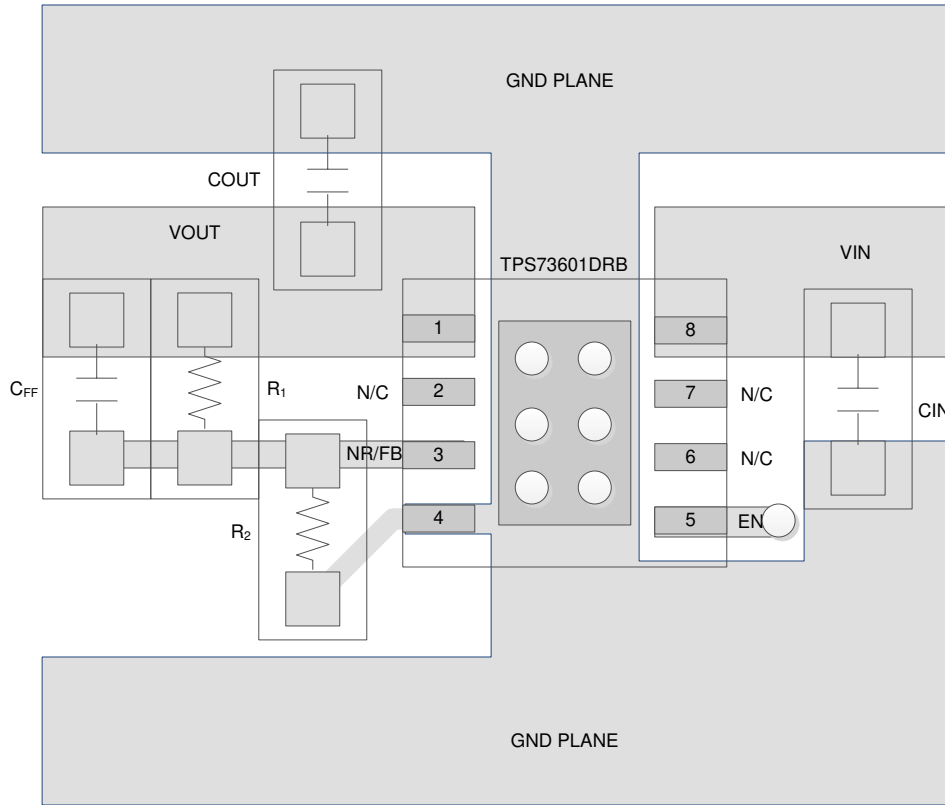

Figure 7-9. Adjustable Output Voltage Option Layout (DRB Package)

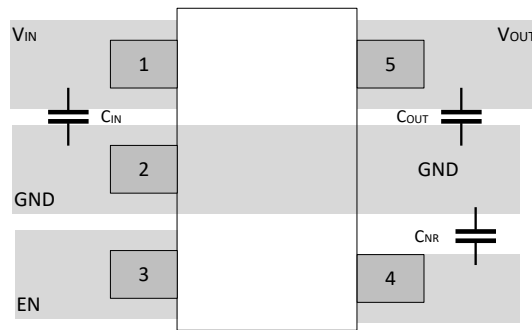

Figure 7-10. Layout Example for the DBV Package Fixed Version

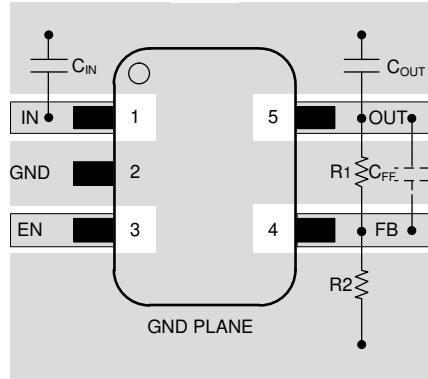

Figure 7-11. Layout Example for the DBV Package Adjustable Version

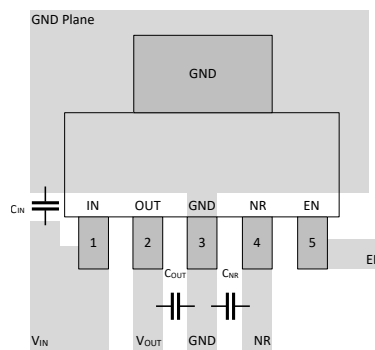

Figure 7-12. Layout Example for the DCQ Package Fixed Version

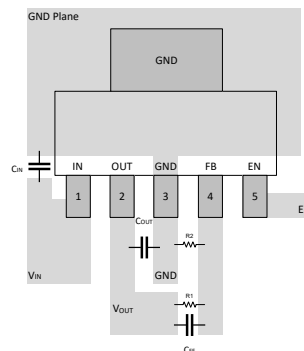

Figure 7-13. Layout Example for the DCQ Package Adjustable Version

7.4.3 Power Dissipation

The ability to remove heat from the die is different for each package type, presenting different considerations in the PCB layout. The PCB area around the device that is free of other components moves the heat from the device to the ambient air. Using heavier copper increases the effectiveness in removing heat from the device. The addition of plated through-holes to heat-dissipating layers also improve the heat-sink effectiveness.

Power dissipation depends on input voltage and load conditions. Power dissipation is equal to the product of the output current times the voltage drop across the output pass element (V_{IN} to V_{OUT}):

$$P_D = (V_{IN} - V_{OUT}) \times I_{OUT} \tag{6}$$

Power dissipation can be minimized by using the lowest possible input voltage necessary to provide the required output voltage.

7.4.4 Package Mounting

Solder pad footprint recommendations for the TPS732-Q1 family of devices are presented in the *Solder Pad Recommendations for Surface-Mount Devices* ([SBFA015](#)) application bulletin.

8 Device and Documentation Support

8.1 Documentation Support

8.1.1 Device Nomenclature

Table 8-1. Ordering Information

| PRODUCT | DESCRIPTION ⁽¹⁾ |
|---------------------|--|
| TPS732xxQyyyz(M3)Q1 | <p>xx is the nominal output voltage (for example, 25 = 2.5 V, 01 = Adjustable ⁽²⁾).</p> <p>Q indicates that the device is a grade-1 device in accordance with the AEC-Q100 standard.</p> <p>yyy is the package designator.</p> <p>z is the package quantity.</p> <p>M3 is a suffix designator for devices that only use the latest manufacturing flow (CSO: RFB). Devices without this suffix can ship with the <i>legacy silicon</i> (CSO: DLN) or the <i>new silicon</i> (CSO: RFB). The reel packaging label provides CSO information to distinguish which silicon is being used. Device performance for new and legacy silicon is denoted throughout the document.</p> <p>Q1 indicates that this device is an automotive grade (AEC-Q100) device.</p> |

(1) For the most current package and ordering information see the Package Option Addendum at the end of this document, or see the device product folder at www.ti.com.

(2) For fixed 1.20V operation, tie FB to OUT.

8.1.2 Related Documentation

For related documentation see the following:

Solder Pad Recommendations for Surface-Mount Devices, [SBFA015](#)

8.2 Receiving Notification of Documentation Updates

To receive notification of documentation updates, navigate to the device product folder on ti.com. Click on *Notifications* to register and receive a weekly digest of any product information that has changed. For change details, review the revision history included in any revised document.

8.3 Support Resources

[TI E2E™ support forums](#) are an engineer's go-to source for fast, verified answers and design help — straight from the experts. Search existing answers or ask your own question to get the quick design help you need.

Linked content is provided "AS IS" by the respective contributors. They do not constitute TI specifications and do not necessarily reflect TI's views; see TI's [Terms of Use](#).

8.4 Trademarks

TI E2E™ is a trademark of Texas Instruments.

All trademarks are the property of their respective owners.

8.5 Electrostatic Discharge Caution



This integrated circuit can be damaged by ESD. Texas Instruments recommends that all integrated circuits be handled with appropriate precautions. Failure to observe proper handling and installation procedures can cause damage.

ESD damage can range from subtle performance degradation to complete device failure. Precision integrated circuits may be more susceptible to damage because very small parametric changes could cause the device not to meet its published specifications.

8.6 Glossary

[TI Glossary](#) This glossary lists and explains terms, acronyms, and definitions.

9 Revision History

NOTE: Page numbers for previous revisions may differ from page numbers in the current version.

| Changes from Revision F (April 2016) to Revision G (December 2024) | Page |
|---|------|
| • Updated the numbering format for tables, figures, and cross-references throughout the document..... | 1 |

- Changed entire document to align with current family format..... 1
 - Added M3 devices to document..... 1
-

Changes from Revision E (August 2013) to Revision F (April 2016) Page

- Added *Device Information* table, *Table of Contents*, *Specifications* section, *ESD Ratings* table, *Recommended Operating Conditions* table, *Detailed Description* section, *Application and Implementation* section, *Power Supply Recommendations* section, *Layout* section, *Device and Documentation Support* section, and *Mechanical, Packaging, and Orderable Information* section 1
-

Changes from Revision D (March 2009) to Revision E (August 2013) Page

- Deleted TPS73215-Q1, TPS73216-Q1, TPS73218-Q1, TPS73230-Q1, TPS73233-Q1, and TPS73250-Q1 from the data sheet..... 1
-

10 Mechanical, Packaging, and Orderable Information

The following pages include mechanical, packaging, and orderable information. This information is the most current data available for the designated devices. This data is subject to change without notice and revision of this document. For browser-based versions of this data sheet, refer to the left-hand navigation.

PACKAGING INFORMATION

| Orderable part number | Status (1) | Material type (2) | Package Pins | Package qty Carrier | RoHS (3) | Lead finish/ Ball material (4) | MSL rating/ Peak reflow (5) | Op temp (°C) | Part marking (6) |
|-----------------------------------|---------------|----------------------|-------------------|-----------------------|-------------|--------------------------------------|-----------------------------------|--------------|---------------------|
| TPS73201QDBVRQ1 | Active | Production | SOT-23 (DBV) 5 | 3000 LARGE T&R | Yes | NIPDAU | Level-1-260C-UNLIM | -40 to 125 | PJOQ |
| TPS73201QDRBRQ1 | Active | Production | SON (DRB) 8 | 3000 LARGE T&R | Yes | NIPDAU | Level-3-260C-168 HR | -40 to 125 | PSAQ |
| TPS73218QDCQRM3Q1 | Active | Production | SOT-223 (DCQ) 6 | 2500 LARGE T&R | Yes | NIPDAU | Level-2-260C-1 YEAR | -40 to 125 | 73218Q |
| TPS73218QDCQRQ1 | Active | Production | SOT-223 (DCQ) 6 | 2500 LARGE T&R | Yes | NIPDAU | Level-3-260C-168 HR | -40 to 125 | 73218Q |
| TPS73250QDCQRQ1 | Active | Production | SOT-223 (DCQ) 6 | 2500 LARGE T&R | Yes | NIPDAU | Level-3-260C-168 HR | -40 to 125 | 73250Q |

⁽¹⁾ **Status:** For more details on status, see our [product life cycle](#).

⁽²⁾ **Material type:** When designated, preproduction parts are prototypes/experimental devices, and are not yet approved or released for full production. Testing and final process, including without limitation quality assurance, reliability performance testing, and/or process qualification, may not yet be complete, and this item is subject to further changes or possible discontinuation. If available for ordering, purchases will be subject to an additional waiver at checkout, and are intended for early internal evaluation purposes only. These items are sold without warranties of any kind.

⁽³⁾ **RoHS values:** Yes, No, RoHS Exempt. See the [TI RoHS Statement](#) for additional information and value definition.

⁽⁴⁾ **Lead finish/Ball material:** Parts may have multiple material finish options. Finish options are separated by a vertical ruled line. Lead finish/Ball material values may wrap to two lines if the finish value exceeds the maximum column width.

⁽⁵⁾ **MSL rating/Peak reflow:** The moisture sensitivity level ratings and peak solder (reflow) temperatures. In the event that a part has multiple moisture sensitivity ratings, only the lowest level per JEDEC standards is shown. Refer to the shipping label for the actual reflow temperature that will be used to mount the part to the printed circuit board.

⁽⁶⁾ **Part marking:** There may be an additional marking, which relates to the logo, the lot trace code information, or the environmental category of the part.

Multiple part markings will be inside parentheses. Only one part marking contained in parentheses and separated by a "-" will appear on a part. If a line is indented then it is a continuation of the previous line and the two combined represent the entire part marking for that device.

Important Information and Disclaimer: The information provided on this page represents TI's knowledge and belief as of the date that it is provided. TI bases its knowledge and belief on information provided by third parties, and makes no representation or warranty as to the accuracy of such information. Efforts are underway to better integrate information from third parties. TI has taken and continues to take reasonable steps to provide representative and accurate information but may not have conducted destructive testing or chemical analysis on incoming materials and chemicals. TI and TI suppliers consider certain information to be proprietary, and thus CAS numbers and other limited information may not be available for release.

In no event shall TI's liability arising out of such information exceed the total purchase price of the TI part(s) at issue in this document sold by TI to Customer on an annual basis.

OTHER QUALIFIED VERSIONS OF TPS732-Q1 :

- Catalog : [TPS732](#)

NOTE: Qualified Version Definitions:

- Catalog - TI's standard catalog product

TAPE AND REEL INFORMATION

QUADRANT ASSIGNMENTS FOR PIN 1 ORIENTATION IN TAPE

*All dimensions are nominal

| Device | Package Type | Package Drawing | Pins | SPQ | Reel Diameter (mm) | Reel Width W1 (mm) | A0 (mm) | B0 (mm) | K0 (mm) | P1 (mm) | W (mm) | Pin1 Quadrant |
|-----------------|--------------|-----------------|------|------|--------------------|--------------------|---------|---------|---------|---------|--------|---------------|
| TPS73201QDBVRQ1 | SOT-23 | DBV | 5 | 3000 | 179.0 | 8.4 | 3.2 | 3.2 | 1.4 | 4.0 | 8.0 | Q3 |
| TPS73201QDRBRQ1 | SON | DRB | 8 | 3000 | 330.0 | 12.4 | 3.3 | 3.3 | 1.1 | 8.0 | 12.0 | Q2 |
| TPS73218QDCQRQ1 | SOT-223 | DCQ | 6 | 2500 | 330.0 | 12.4 | 7.1 | 7.45 | 1.88 | 8.0 | 12.0 | Q3 |
| TPS73250QDCQRQ1 | SOT-223 | DCQ | 6 | 2500 | 330.0 | 12.4 | 7.1 | 7.45 | 1.88 | 8.0 | 12.0 | Q3 |

TAPE AND REEL BOX DIMENSIONS

*All dimensions are nominal

| Device | Package Type | Package Drawing | Pins | SPQ | Length (mm) | Width (mm) | Height (mm) |
|-----------------|--------------|-----------------|------|------|-------------|------------|-------------|
| TPS73201QDBVRQ1 | SOT-23 | DBV | 5 | 3000 | 200.0 | 183.0 | 25.0 |
| TPS73201QDRBRQ1 | SON | DRB | 8 | 3000 | 367.0 | 367.0 | 35.0 |
| TPS73218QDCQRQ1 | SOT-223 | DCQ | 6 | 2500 | 346.0 | 346.0 | 29.0 |
| TPS73250QDCQRQ1 | SOT-223 | DCQ | 6 | 2500 | 346.0 | 346.0 | 29.0 |

DBV0005A



PACKAGE OUTLINE

SOT-23 - 1.45 mm max height

SMALL OUTLINE TRANSISTOR



4214839/K 08/2024

NOTES:

1. All linear dimensions are in millimeters. Any dimensions in parenthesis are for reference only. Dimensioning and tolerancing per ASME Y14.5M.
2. This drawing is subject to change without notice.
3. Reference JEDEC MO-178.
4. Body dimensions do not include mold flash, protrusions, or gate burrs. Mold flash, protrusions, or gate burrs shall not exceed 0.25 mm per side.
5. Support pin may differ or may not be present.

EXAMPLE BOARD LAYOUT

DBV0005A

SOT-23 - 1.45 mm max height

SMALL OUTLINE TRANSISTOR

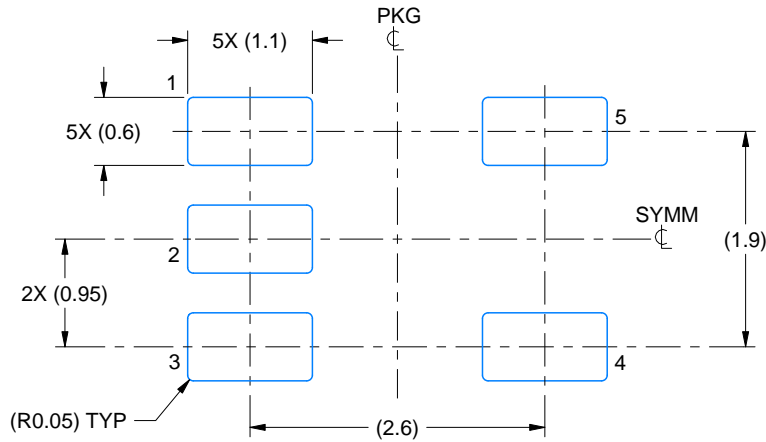

LAND PATTERN EXAMPLE
EXPOSED METAL SHOWN
SCALE:15X



SOLDER MASK DETAILS

4214839/K 08/2024

NOTES: (continued)

- 6. Publication IPC-7351 may have alternate designs.
- 7. Solder mask tolerances between and around signal pads can vary based on board fabrication site.

EXAMPLE STENCIL DESIGN

DBV0005A

SOT-23 - 1.45 mm max height

SMALL OUTLINE TRANSISTOR



SOLDER PASTE EXAMPLE
BASED ON 0.125 mm THICK STENCIL
SCALE:15X

4214839/K 08/2024

NOTES: (continued)

8. Laser cutting apertures with trapezoidal walls and rounded corners may offer better paste release. IPC-7525 may have alternate design recommendations.
9. Board assembly site may have different recommendations for stencil design.

DCQ0006A

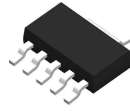

PACKAGE OUTLINE

SOT - 1.8 mm max height

PLASTIC SMALL OUTLINE

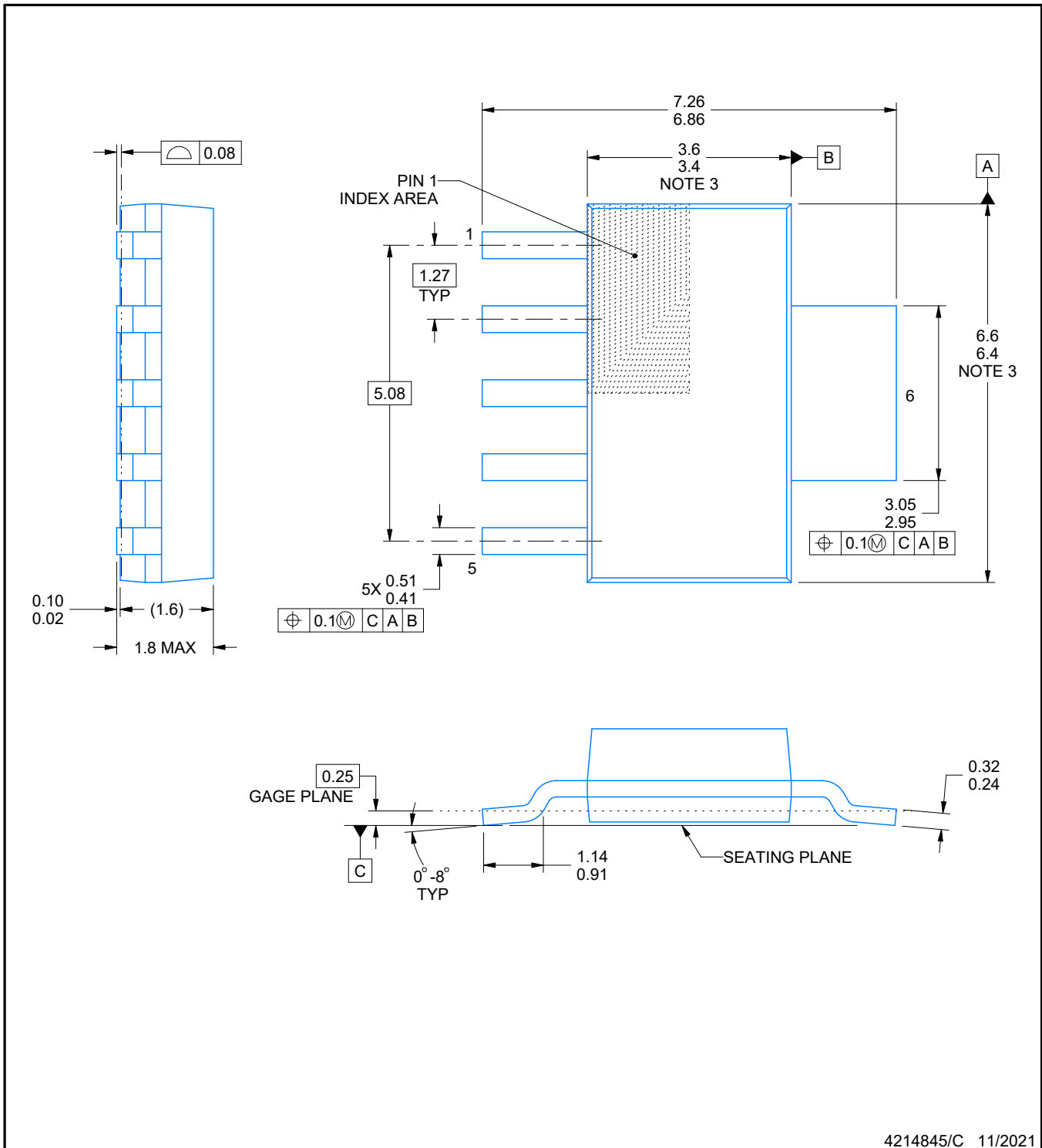

4214845/C 11/2021

NOTES:

1. All linear dimensions are in millimeters. Any dimensions in parenthesis are for reference only. Dimensioning and tolerancing per ASME Y14.5M.
2. This drawing is subject to change without notice.
3. This dimension does not include mold flash, protrusions, or gate burrs. Mold flash, protrusions, or gate burrs shall not exceed 0.15 mm per side.

EXAMPLE BOARD LAYOUT

DCQ0006A

SOT - 1.8 mm max height

PLASTIC SMALL OUTLINE

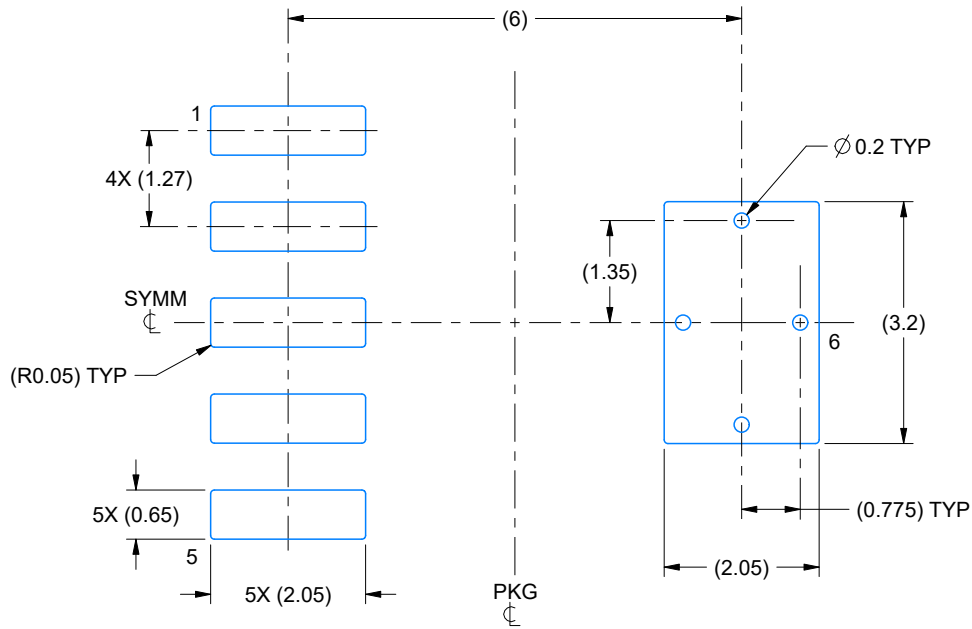

LAND PATTERN EXAMPLE
EXPOSED METAL SHOWN
SCALE: 10X

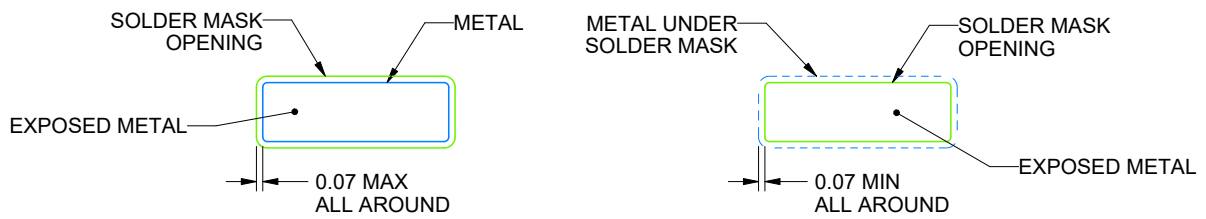

SOLDER MASK DETAILS

4214845/C 11/2021

NOTES: (continued)

4. Publication IPC-7351 may have alternate designs.
5. Solder mask tolerances between and around signal pads can vary based on board fabrication site.
6. Vias are optional depending on application, refer to device data sheet. If any vias are implemented, refer to their locations shown on this view. It is recommended that vias under paste be filled, plugged or tented.

EXAMPLE STENCIL DESIGN

DCQ0006A

SOT - 1.8 mm max height

PLASTIC SMALL OUTLINE

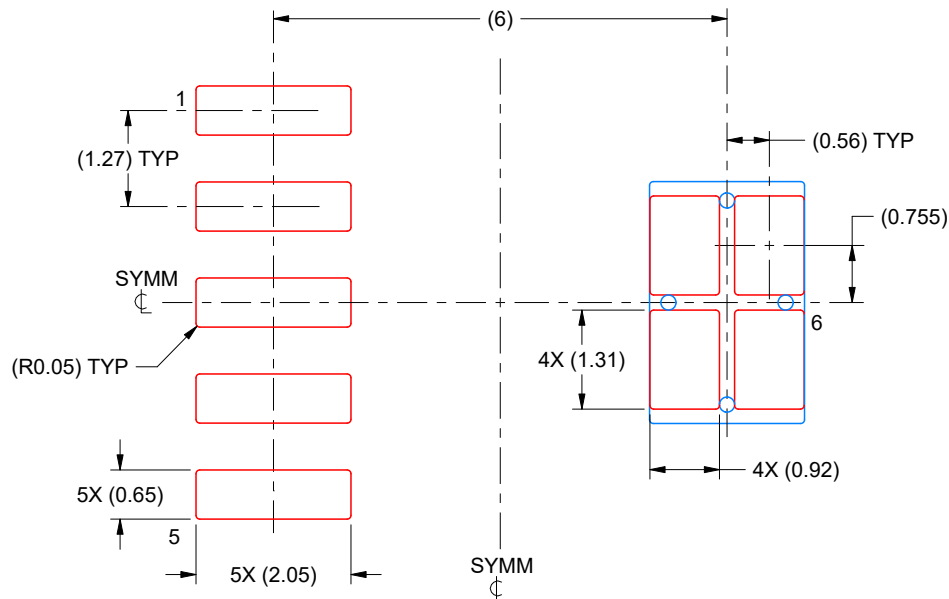

SOLDER PASTE EXAMPLE
BASED ON 0.125 mm THICK STENCIL
SCALE: 10X

4214845/C 11/2021

NOTES: (continued)

7. Laser cutting apertures with trapezoidal walls and rounded corners may offer better paste release. IPC-7525 may have alternate design recommendations.
8. Board assembly site may have different recommendations for stencil design.

DRB 8

GENERIC PACKAGE VIEW

VSON - 1 mm max height

PLASTIC SMALL OUTLINE - NO LEAD

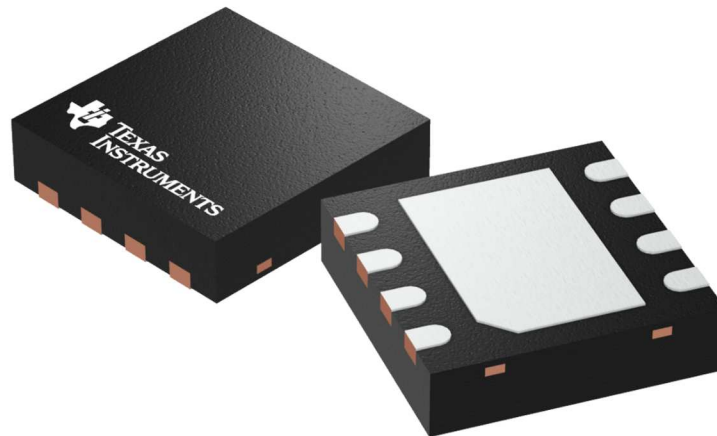

Images above are just a representation of the package family, actual package may vary.
Refer to the product data sheet for package details.

4203482/L

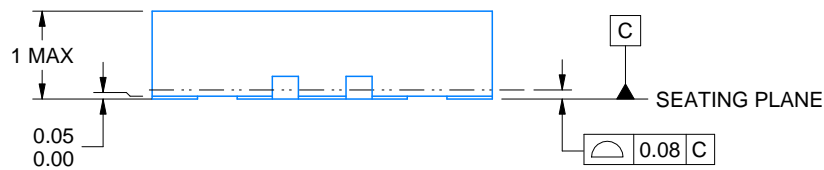
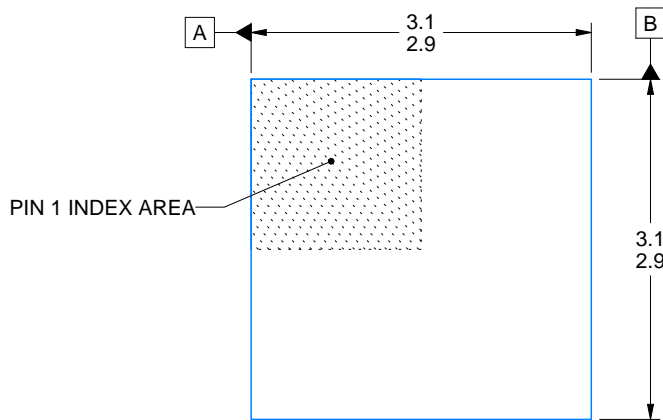

| DIM A | |
|-------|-------|
| OPT 1 | OPT 2 |
| (0.1) | (0.2) |

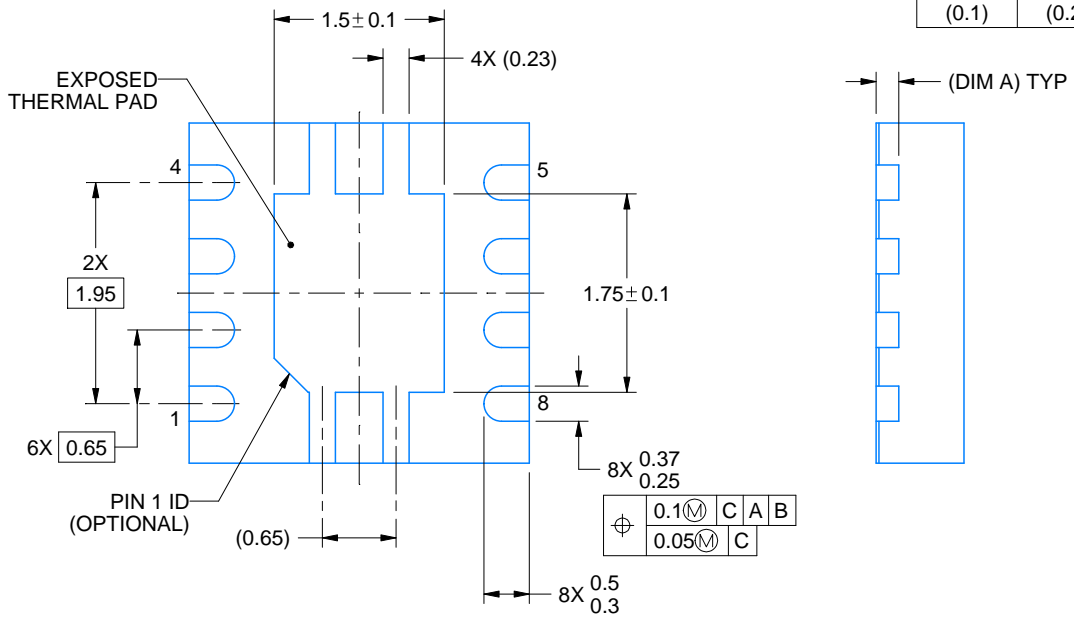

4218875/A 01/2018

NOTES:

1. All linear dimensions are in millimeters. Any dimensions in parenthesis are for reference only. Dimensioning and tolerancing per ASME Y14.5M.
2. This drawing is subject to change without notice.
3. The package thermal pad must be soldered to the printed circuit board for thermal and mechanical performance.

EXAMPLE BOARD LAYOUT

DRB0008A

VSON - 1 mm max height

PLASTIC SMALL OUTLINE - NO LEAD

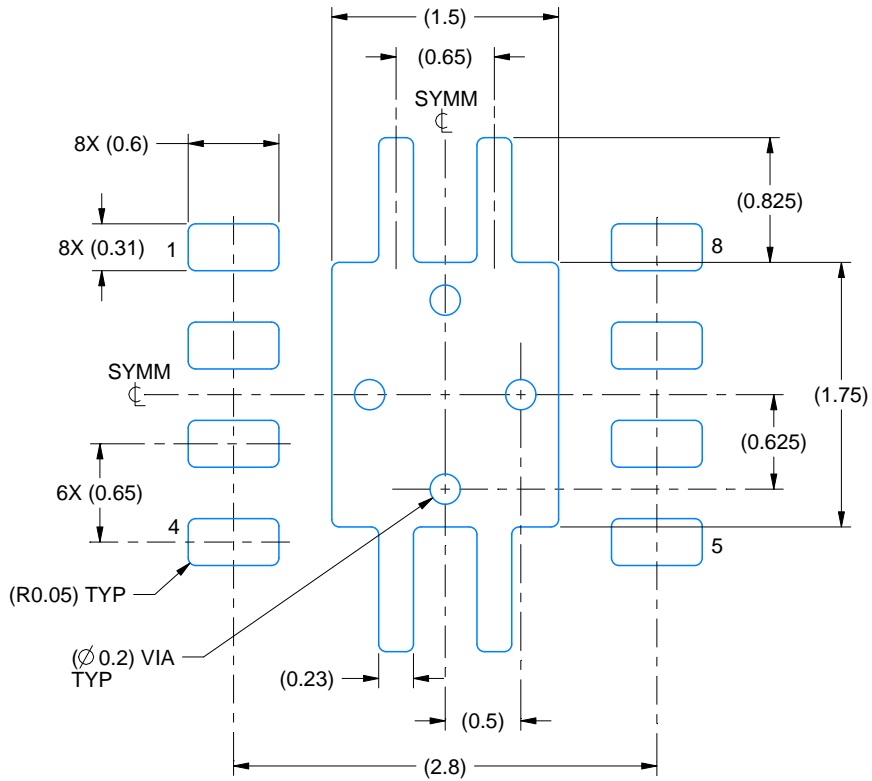

LAND PATTERN EXAMPLE
EXPOSED METAL SHOWN
SCALE:20X

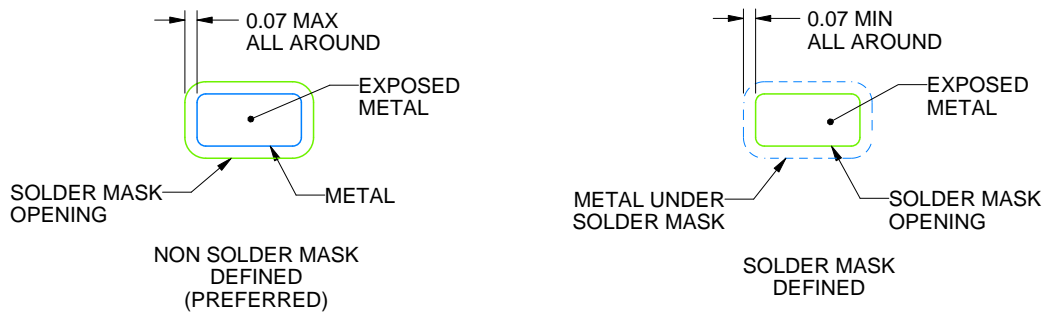

SOLDER MASK DETAILS

4218875/A 01/2018

NOTES: (continued)

- 4. This package is designed to be soldered to a thermal pad on the board. For more information, see Texas Instruments literature number SLUA271 (www.ti.com/lit/slue271).
- 5. Vias are optional depending on application, refer to device data sheet. If any vias are implemented, refer to their locations shown on this view. It is recommended that vias under paste be filled, plugged or tented.

EXAMPLE STENCIL DESIGN

DRB0008A

VSON - 1 mm max height

PLASTIC SMALL OUTLINE - NO LEAD

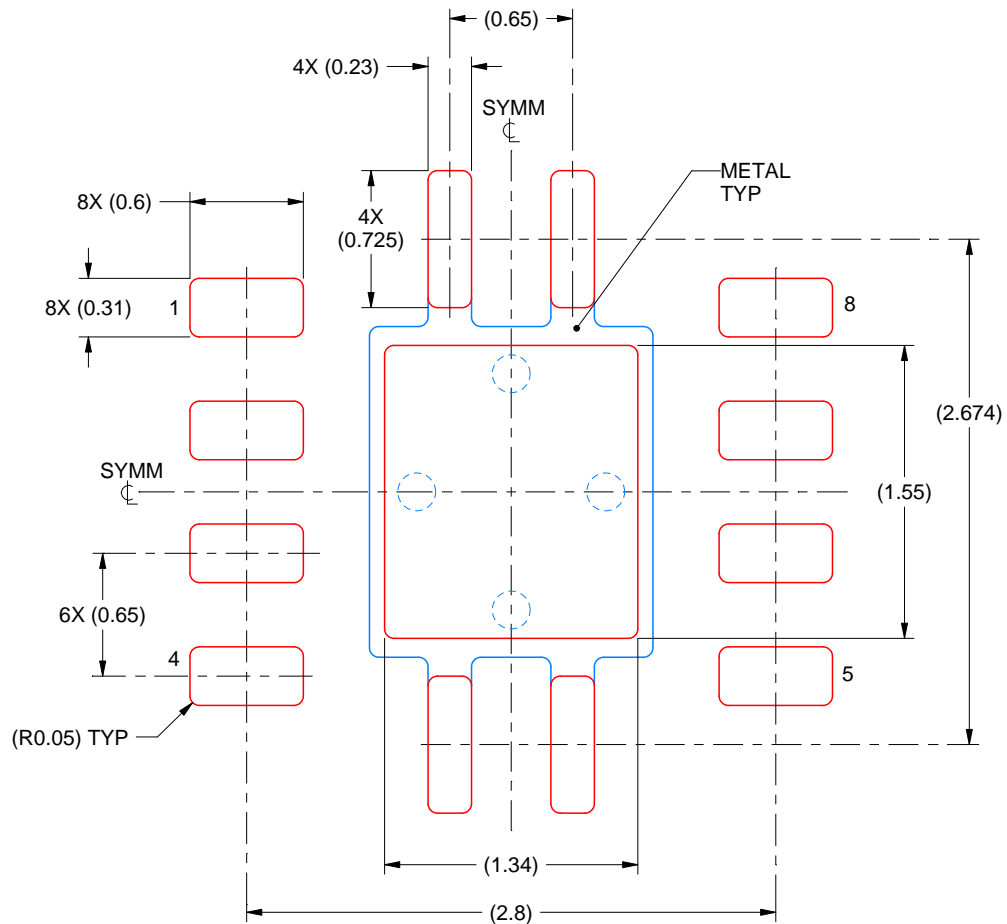

SOLDER PASTE EXAMPLE
BASED ON 0.125 mm THICK STENCIL

EXPOSED PAD
84% PRINTED SOLDER COVERAGE BY AREA
SCALE:25X

4218875/A 01/2018

NOTES: (continued)

6. Laser cutting apertures with trapezoidal walls and rounded corners may offer better paste release. IPC-7525 may have alternate design recommendations.

IMPORTANT NOTICE AND DISCLAIMER

TI PROVIDES TECHNICAL AND RELIABILITY DATA (INCLUDING DATA SHEETS), DESIGN RESOURCES (INCLUDING REFERENCE DESIGNS), APPLICATION OR OTHER DESIGN ADVICE, WEB TOOLS, SAFETY INFORMATION, AND OTHER RESOURCES "AS IS" AND WITH ALL FAULTS, AND DISCLAIMS ALL WARRANTIES, EXPRESS AND IMPLIED, INCLUDING WITHOUT LIMITATION ANY IMPLIED WARRANTIES OF MERCHANTABILITY, FITNESS FOR A PARTICULAR PURPOSE OR NON-INFRINGEMENT OF THIRD PARTY INTELLECTUAL PROPERTY RIGHTS.

These resources are intended for skilled developers designing with TI products. You are solely responsible for (1) selecting the appropriate TI products for your application, (2) designing, validating and testing your application, and (3) ensuring your application meets applicable standards, and any other safety, security, regulatory or other requirements.

These resources are subject to change without notice. TI grants you permission to use these resources only for development of an application that uses the TI products described in the resource. Other reproduction and display of these resources is prohibited. No license is granted to any other TI intellectual property right or to any third party intellectual property right. TI disclaims responsibility for, and you will fully indemnify TI and its representatives against, any claims, damages, costs, losses, and liabilities arising out of your use of these resources.

TI's products are provided subject to [TI's Terms of Sale](#) or other applicable terms available either on [ti.com](https://www.ti.com) or provided in conjunction with such TI products. TI's provision of these resources does not expand or otherwise alter TI's applicable warranties or warranty disclaimers for TI products.

TI objects to and rejects any additional or different terms you may have proposed.

Mailing Address: Texas Instruments, Post Office Box 655303, Dallas, Texas 75265

Copyright © 2025, Texas Instruments Incorporated