

# AFE7444 Quad-channel, RF-sampling AFE with 14-bit, 9-GSPS DACs and 14-bit, 3-GSPS ADCs

## 1 Features

- Four, 14-bit, 9-GSPS DACs
  - Up to 800-MHz signal bandwidth
  - 1 DSA per channel tunes output power
- Four, 14-bit, 3-GSPS ADCs
  - Up to 800-MHz signal bandwidth
  - NSD: –151 dBFS/Hz
  - AC performance at  $f_{IN} = 2.6$  GHz, –3 dBFS
    - SNR: 55 dBFS
    - SFDR: 73 dBc HD2 and HD3
    - SFDR: 91 dBc worst spur
  - 2 DSA per channel extends dynamic range
  - RF and digital power detectors
- RF frequency range: 10 MHz to 6 GHz
- Fast frequency hopping < 1  $\mu$ s
- Receive digital signal path:
  - dual DDC per ADC
  - 3-phase coherent 32-bit NCOs per DDC
  - Decimation ratio: 3x to 32x
- Transmit digital signal path:
  - Dual DUC per DAC with 32-bit NCOs
  - Interpolation ratio: 8x to 36x
  - Sin(x)/x correction and configurable delay
  - Power amplifier protection (PAP)
- JESD204B interface:
  - 8 transceivers at up to 15 Gbps
  - Subclass 1 multichip synchronization
- Clocks:
  - Internal PLL and VCO with bypass option
  - Clock output up to 3 GHz with clock divider
- DAC power dissipation: 1.7 W/ch at 9 GSPS
- ADC power dissipation: 1.8 W/ch at 3 GSPS
- Package: 17-mm x 17-mm FC BGA, 0.8-mm pitch

## 2 Applications

- Communications equipment and testers
- Wideband digitizers and waveform generators

## 3 Description

The AFE7444 is a quad-channel, wideband, RF-sampling analog front end (AFE) based on 14-bit, 9-GSPS DACs and 14-bit, 3-GSPS ADCs. With operation at an RF of up to 6 GHz, this device enables direct RF sampling into the C-band frequency range without the need for additional frequency conversions stages. This improvement in density and flexibility enables high-channel-count, multimission systems.

The DAC signal paths support interpolation and digital up conversion options that deliver up to 800 MHz of signal bandwidth. The differential output path includes a digital step attenuator (DSA), which enables tuning of output power.

Each ADC input path includes a dual DSA and RF and Digital power detectors. Flexible decimation options provide optimization of data bandwidth.

An 8-lane (8 TX + 8 RX) subclass-1 compliant JESD204B interface operates at up to 15 Gbps. A bypassable on-chip PLL simplifies clock operation with an optional clock output.

### Device Information<sup>(1)</sup>

PART NUMBER	PACKAGE	BODY SIZE (NOM)
AFE7444	FCBGA (400)	17.00 mm x 17.00 mm

(1) For all available packages, see the package option addendum at the end of the data sheet.

### Functional Block Diagram

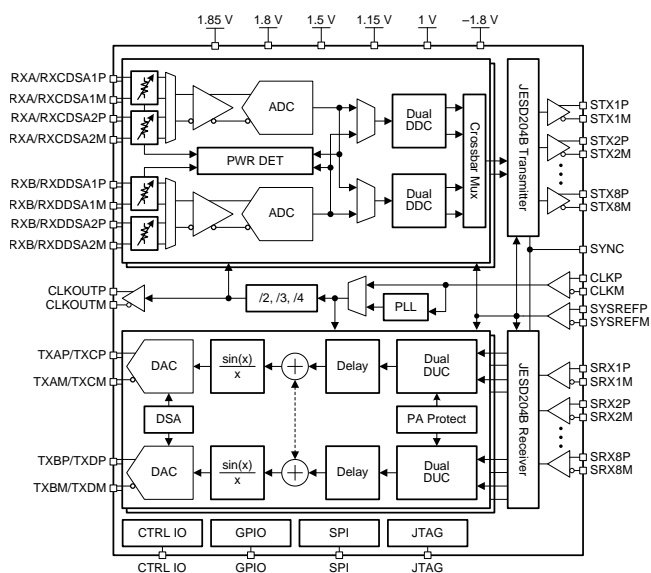

## 4 Revision History

NOTE: Page numbers for previous revisions may differ from page numbers in the current version.

<b>Changes from Original (October 2018) to Revision A</b>	<b>Page</b>
• Changed status from advance information to production data .....	<a href="#">1</a>

---

## 5 Device and Documentation Support

### 5.1 Receiving Notification of Documentation Updates

To receive notification of documentation updates, navigate to the device product folder on ti.com. In the upper right corner, click on *Alert me* to register and receive a weekly digest of any product information that has changed. For change details, review the revision history included in any revised document.

### 5.2 Community Resources

The following links connect to TI community resources. Linked contents are provided "AS IS" by the respective contributors. They do not constitute TI specifications and do not necessarily reflect TI's views; see TI's [Terms of Use](#).

**TI E2E™ Online Community** *TI's Engineer-to-Engineer (E2E) Community*. Created to foster collaboration among engineers. At e2e.ti.com, you can ask questions, share knowledge, explore ideas and help solve problems with fellow engineers.

**Design Support** *TI's Design Support* Quickly find helpful E2E forums along with design support tools and contact information for technical support.

### 5.3 Trademarks

E2E is a trademark of Texas Instruments.  
All other trademarks are the property of their respective owners.

### 5.4 Electrostatic Discharge Caution



This integrated circuit can be damaged by ESD. Texas Instruments recommends that all integrated circuits be handled with appropriate precautions. Failure to observe proper handling and installation procedures can cause damage.

ESD damage can range from subtle performance degradation to complete device failure. Precision integrated circuits may be more susceptible to damage because very small parametric changes could cause the device not to meet its published specifications.

### 5.5 Glossary

[SLYZ022](#) — *TI Glossary*.

This glossary lists and explains terms, acronyms, and definitions.

## 6 Mechanical, Packaging, and Orderable Information

The following pages include mechanical, packaging, and orderable information. This information is the most current data available for the designated devices. This data is subject to change without notice and revision of this document. For browser-based versions of this data sheet, refer to the left-hand navigation.

**PACKAGING INFORMATION**

Orderable Device	Status (1)	Package Type	Package Drawing	Pins	Package Qty	Eco Plan (2)	Lead/Ball Finish (6)	MSL Peak Temp (3)	Op Temp (°C)	Device Marking (4/5)	Samples
AFE7444IABJ	ACTIVE	FCBGA	ABJ	400	90	Green (RoHS & no Sb/Br)	SNAGCU	Level-3-260C-168 HR	-40 to 85	AFE7444I	<a href="#">Samples</a>
AFE7444IALK	ACTIVE	FCBGA	ALK	400	90	TBD	Call TI	Call TI	-40 to 85	AFE7444IZ	<a href="#">Samples</a>

(1) The marketing status values are defined as follows:

**ACTIVE:** Product device recommended for new designs.

**LIFEBUY:** TI has announced that the device will be discontinued, and a lifetime-buy period is in effect.

**NRND:** Not recommended for new designs. Device is in production to support existing customers, but TI does not recommend using this part in a new design.

**PREVIEW:** Device has been announced but is not in production. Samples may or may not be available.

**OBSOLETE:** TI has discontinued the production of the device.

(2) **RoHS:** TI defines "RoHS" to mean semiconductor products that are compliant with the current EU RoHS requirements for all 10 RoHS substances, including the requirement that RoHS substance do not exceed 0.1% by weight in homogeneous materials. Where designed to be soldered at high temperatures, "RoHS" products are suitable for use in specified lead-free processes. TI may reference these types of products as "Pb-Free".

**RoHS Exempt:** TI defines "RoHS Exempt" to mean products that contain lead but are compliant with EU RoHS pursuant to a specific EU RoHS exemption.

**Green:** TI defines "Green" to mean the content of Chlorine (Cl) and Bromine (Br) based flame retardants meet JS709B low halogen requirements of <=1000ppm threshold. Antimony trioxide based flame retardants must also meet the <=1000ppm threshold requirement.

(3) MSL, Peak Temp. - The Moisture Sensitivity Level rating according to the JEDEC industry standard classifications, and peak solder temperature.

(4) There may be additional marking, which relates to the logo, the lot trace code information, or the environmental category on the device.

(5) Multiple Device Markings will be inside parentheses. Only one Device Marking contained in parentheses and separated by a "~" will appear on a device. If a line is indented then it is a continuation of the previous line and the two combined represent the entire Device Marking for that device.

(6) Lead/Ball Finish - Orderable Devices may have multiple material finish options. Finish options are separated by a vertical ruled line. Lead/Ball Finish values may wrap to two lines if the finish value exceeds the maximum column width.

**Important Information and Disclaimer:**The information provided on this page represents TI's knowledge and belief as of the date that it is provided. TI bases its knowledge and belief on information provided by third parties, and makes no representation or warranty as to the accuracy of such information. Efforts are underway to better integrate information from third parties. TI has taken and continues to take reasonable steps to provide representative and accurate information but may not have conducted destructive testing or chemical analysis on incoming materials and chemicals. TI and TI suppliers consider certain information to be proprietary, and thus CAS numbers and other limited information may not be available for release.

In no event shall TI's liability arising out of such information exceed the total purchase price of the TI part(s) at issue in this document sold by TI to Customer on an annual basis.

# ABJ0400A

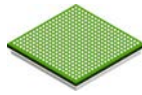

# PACKAGE OUTLINE

FCBGA - 2.65 mm max height

BALL GRID ARRAY

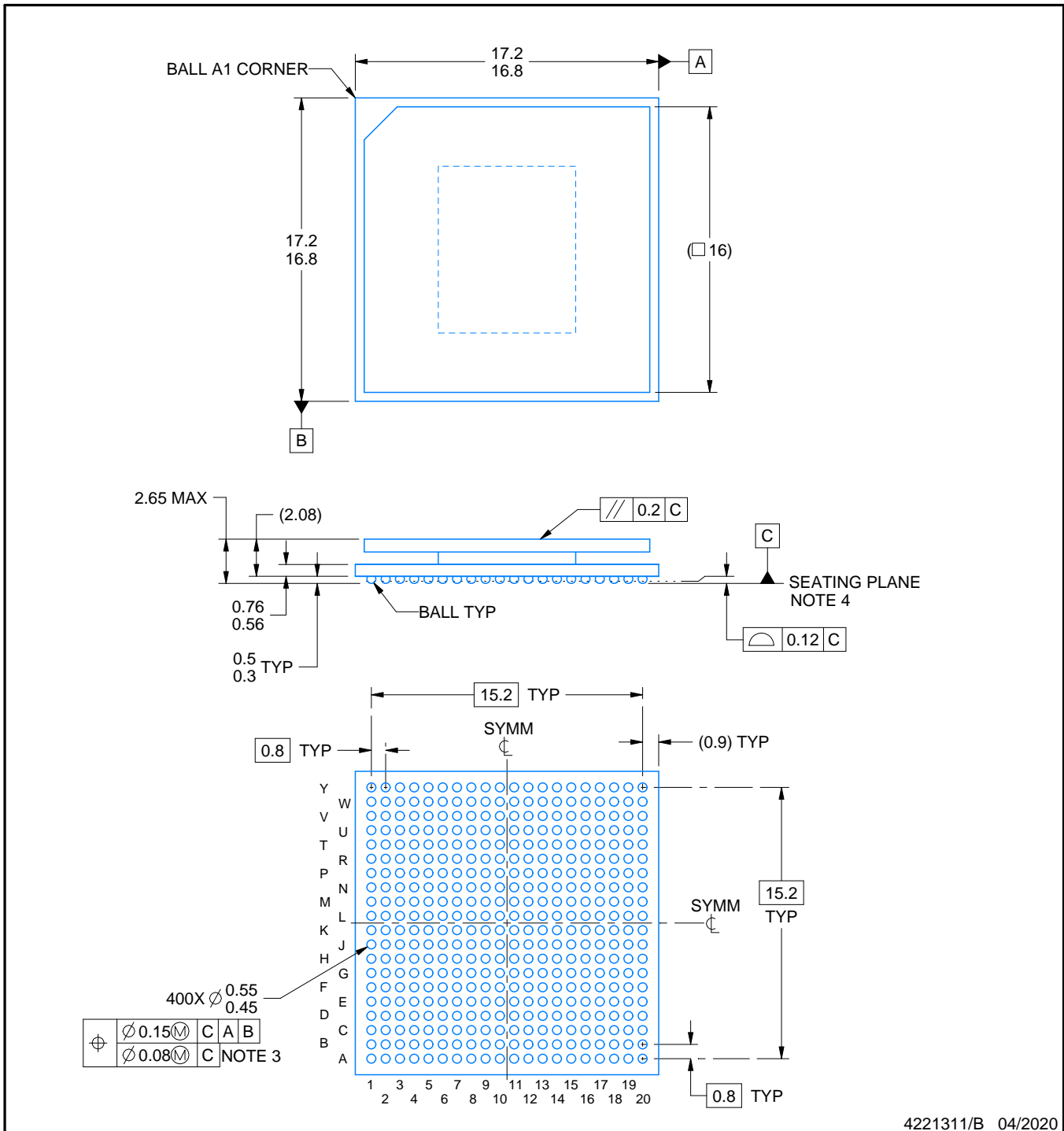

4221311/B 04/2020

## NOTES:

1. All linear dimensions are in millimeters. Any dimensions in parenthesis are for reference only. Dimensioning and tolerancing per ASME Y14.5M.
2. This drawing is subject to change without notice.
3. Dimension is measured at the maximum solder ball diameter, parallel to primary datum C.
4. Primary datum C and seating plane are defined by the spherical crowns of the solder balls.

# EXAMPLE BOARD LAYOUT

**ABJ0400A**

**FCBGA - 2.65 mm max height**

BALL GRID ARRAY

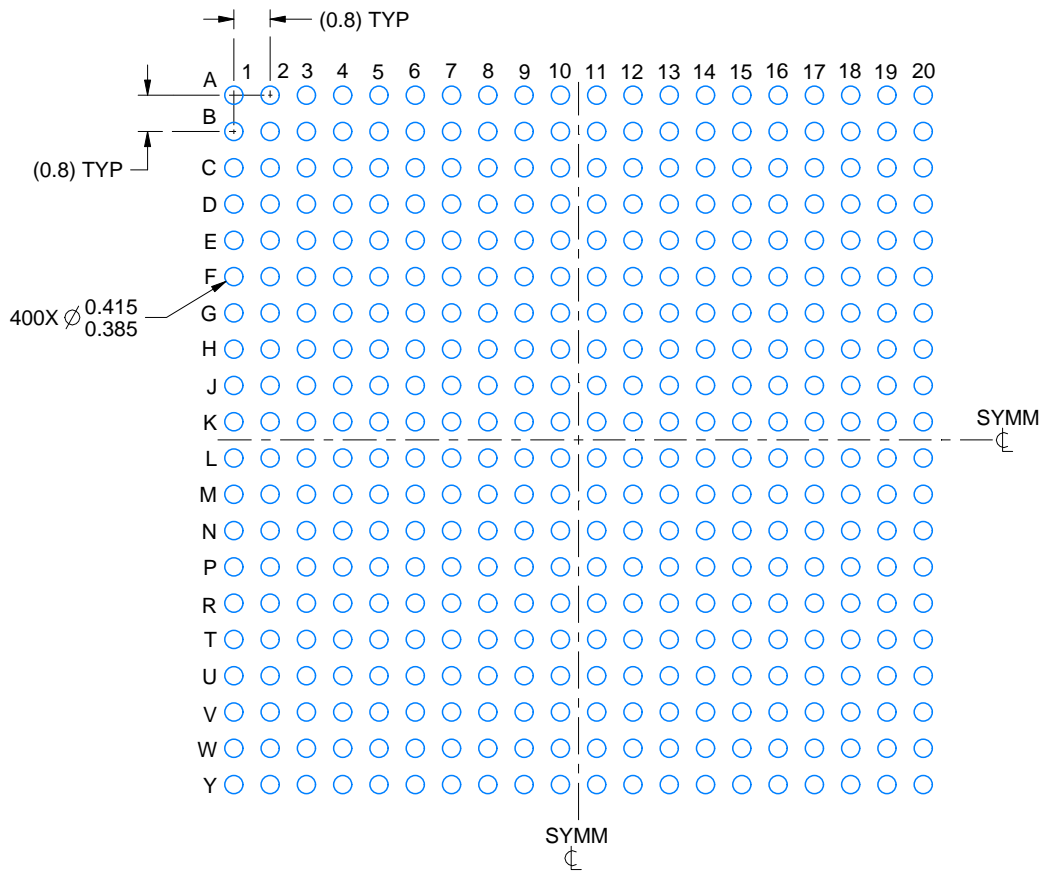

**LAND PATTERN EXAMPLE**  
EXPOSED METAL SHOWN  
SCALE:6X

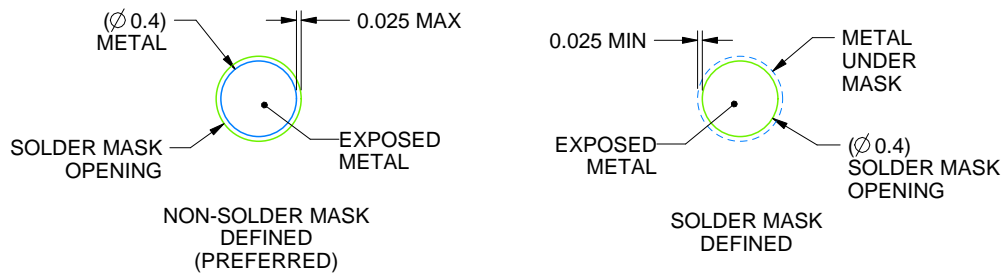

**SOLDER MASK DETAILS**  
NOT TO SCALE

4221311/B 04/2020

NOTES: (continued)

- Final dimensions may vary due to manufacturing tolerance considerations and also routing constraints. For more information, see Texas Instruments literature number SPRU811 ([www.ti.com/lit/spru811](http://www.ti.com/lit/spru811)).

# EXAMPLE STENCIL DESIGN

## ABJ0400A

### FCBGA - 2.65 mm max height

BALL GRID ARRAY

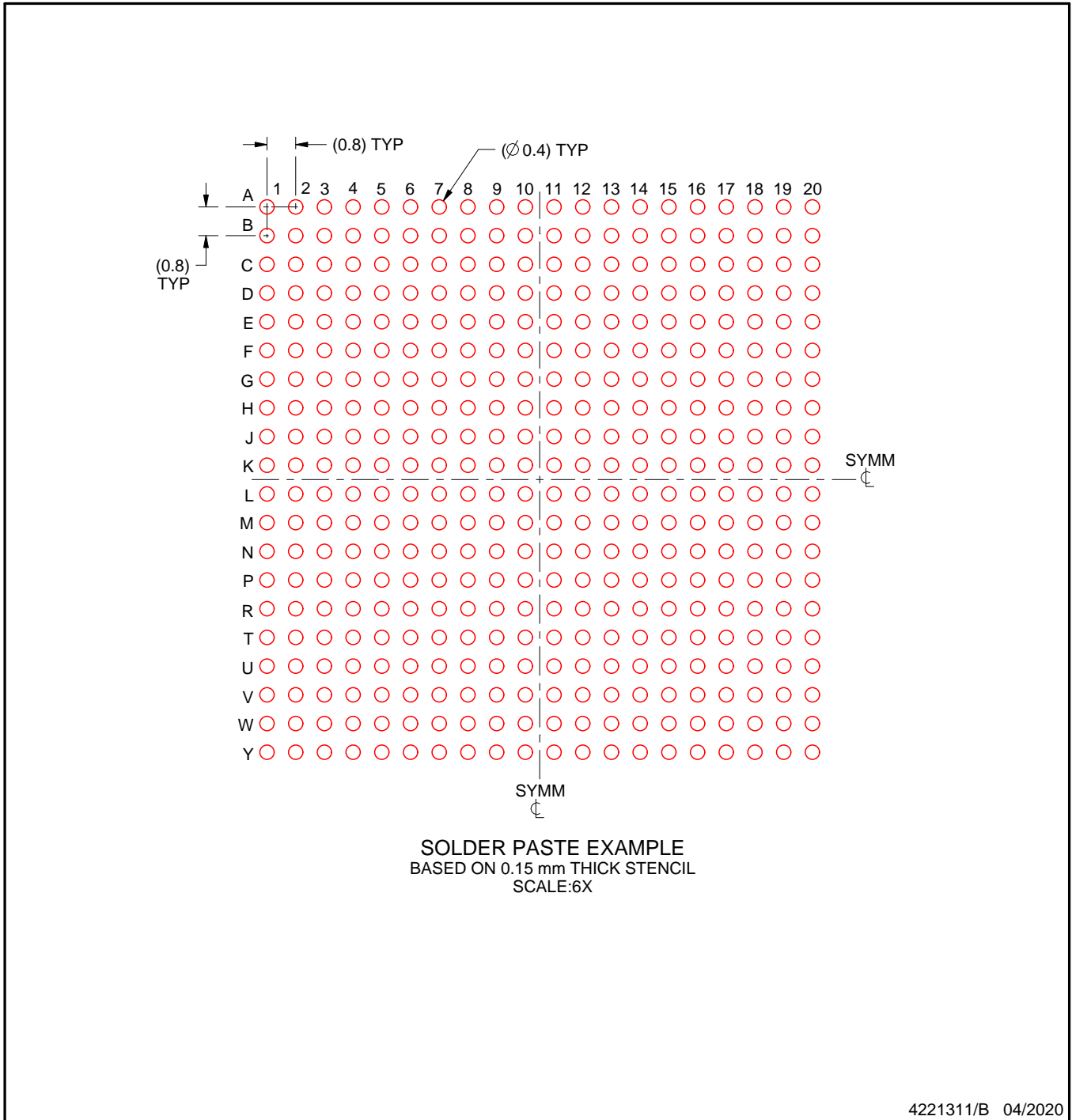

NOTES: (continued)

6. Laser cutting apertures with trapezoidal walls and rounded corners may offer better paste release.

# ALK0400A

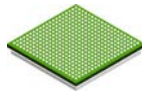

# PACKAGE OUTLINE

## FCBGA - 2.65 mm max height

BALL GRID ARRAY

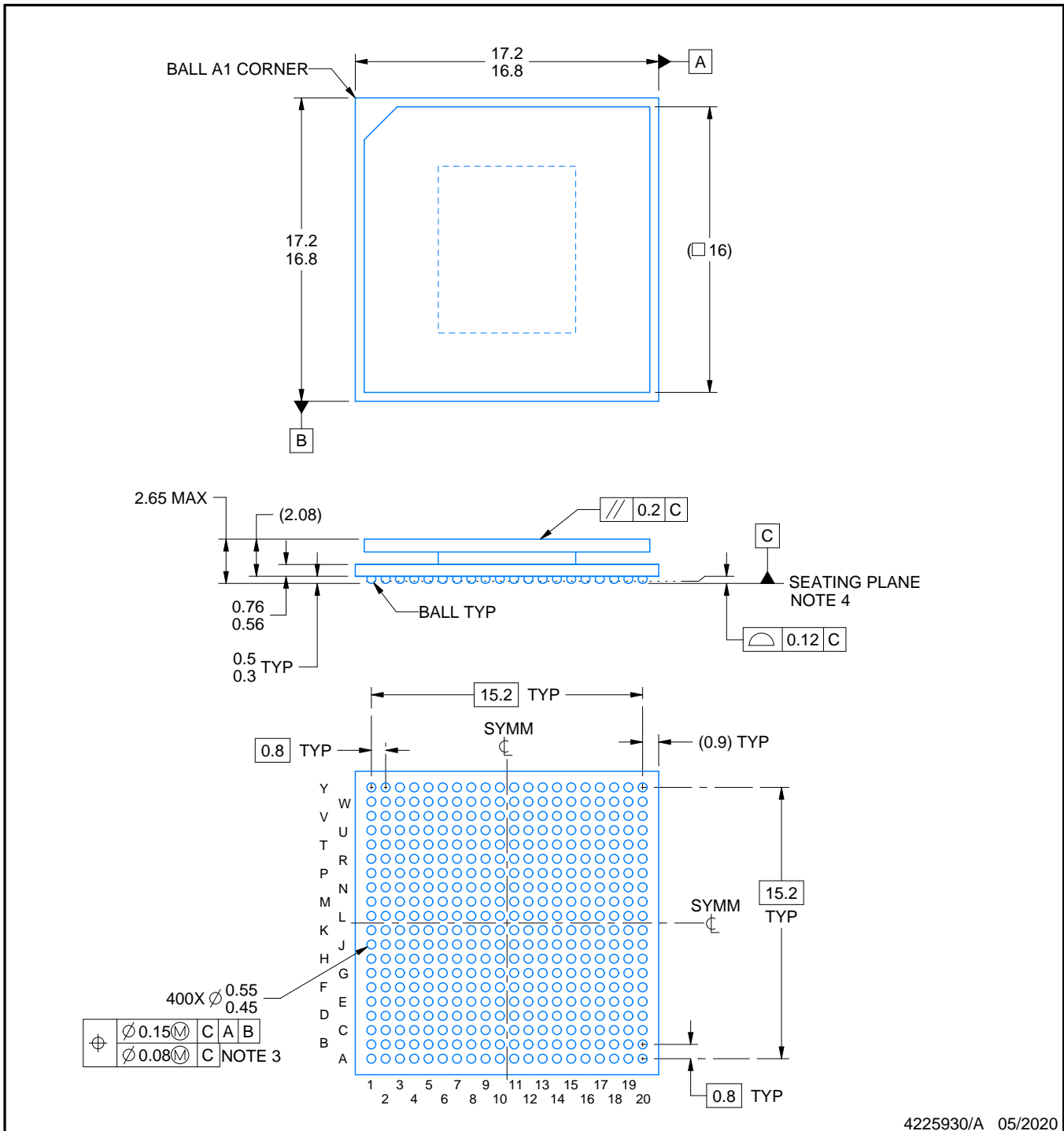

4225930/A 05/2020

### NOTES:

1. All linear dimensions are in millimeters. Any dimensions in parenthesis are for reference only. Dimensioning and tolerancing per ASME Y14.5M.
2. This drawing is subject to change without notice.
3. Dimension is measured at the maximum solder ball diameter, parallel to primary datum C.
4. Primary datum C and seating plane are defined by the spherical crowns of the solder balls.
5. Pb-Free die bump and SnPb solder ball.



# EXAMPLE BOARD LAYOUT

ALK0400A

FCBGA - 2.65 mm max height

BALL GRID ARRAY

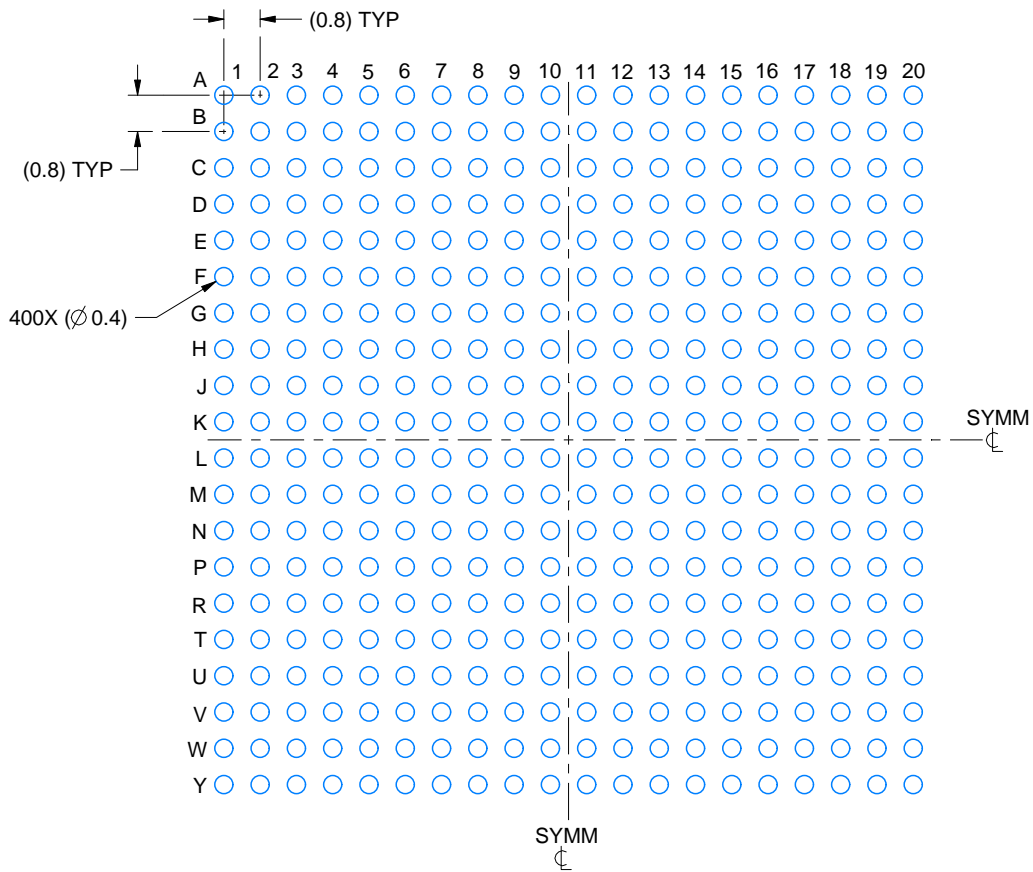

LAND PATTERN EXAMPLE  
EXPOSED METAL SHOWN  
SCALE:6X

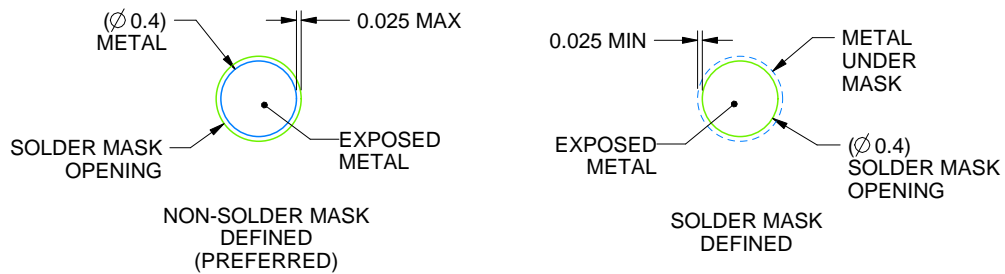

SOLDER MASK DETAILS  
NOT TO SCALE

4225930/A 05/2020

NOTES: (continued)

- Final dimensions may vary due to manufacturing tolerance considerations and also routing constraints. For more information, see Texas Instruments literature number SPRU811 ([www.ti.com/lit/spru811](http://www.ti.com/lit/spru811)).

# EXAMPLE STENCIL DESIGN

## ALK0400A

## FCBGA - 2.65 mm max height

BALL GRID ARRAY

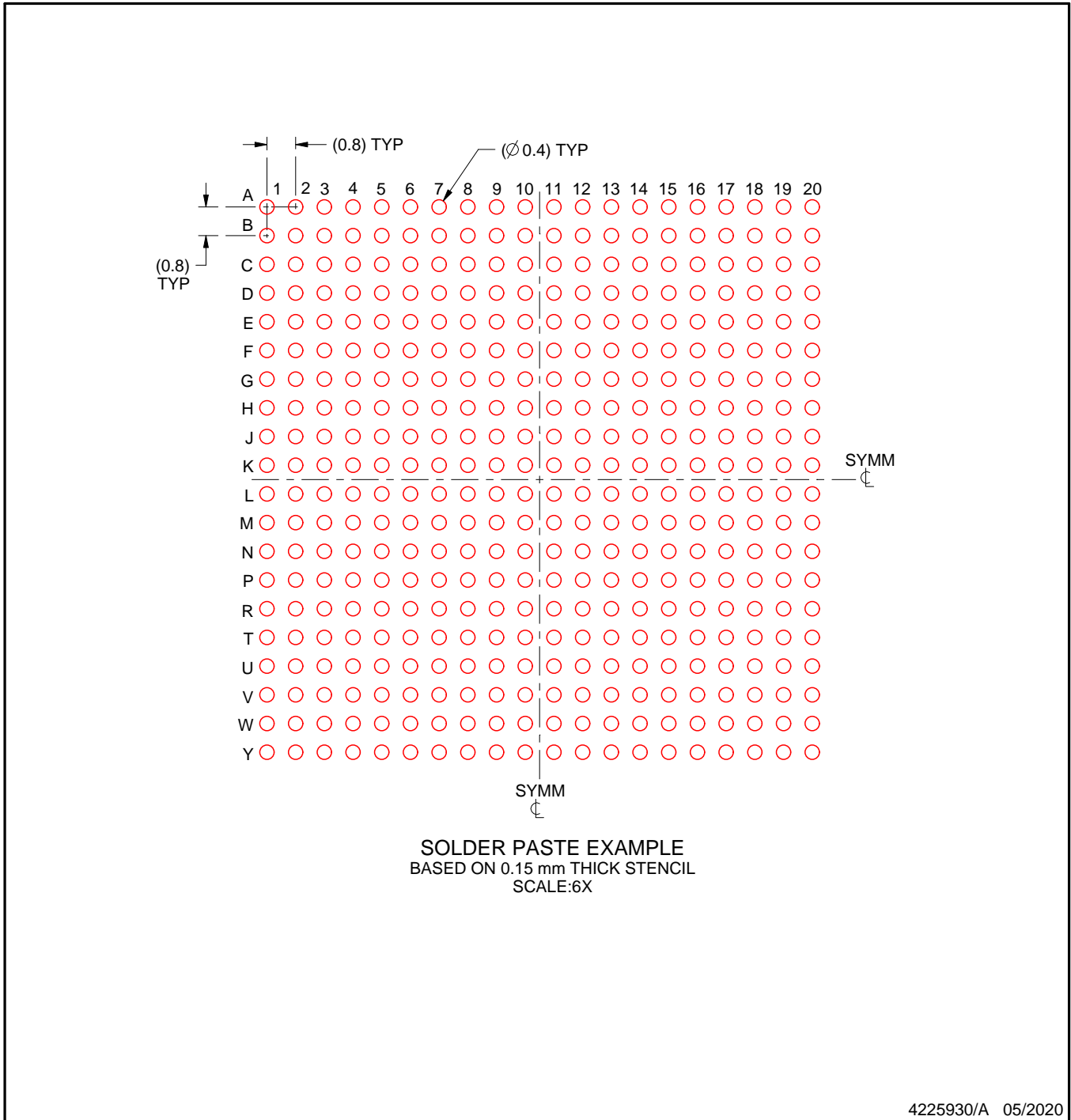

NOTES: (continued)

7. Laser cutting apertures with trapezoidal walls and rounded corners may offer better paste release.

## IMPORTANT NOTICE AND DISCLAIMER

TI PROVIDES TECHNICAL AND RELIABILITY DATA (INCLUDING DATASHEETS), DESIGN RESOURCES (INCLUDING REFERENCE DESIGNS), APPLICATION OR OTHER DESIGN ADVICE, WEB TOOLS, SAFETY INFORMATION, AND OTHER RESOURCES "AS IS" AND WITH ALL FAULTS, AND DISCLAIMS ALL WARRANTIES, EXPRESS AND IMPLIED, INCLUDING WITHOUT LIMITATION ANY IMPLIED WARRANTIES OF MERCHANTABILITY, FITNESS FOR A PARTICULAR PURPOSE OR NON-INFRINGEMENT OF THIRD PARTY INTELLECTUAL PROPERTY RIGHTS.

These resources are intended for skilled developers designing with TI products. You are solely responsible for (1) selecting the appropriate TI products for your application, (2) designing, validating and testing your application, and (3) ensuring your application meets applicable standards, and any other safety, security, or other requirements. These resources are subject to change without notice. TI grants you permission to use these resources only for development of an application that uses the TI products described in the resource. Other reproduction and display of these resources is prohibited. No license is granted to any other TI intellectual property right or to any third party intellectual property right. TI disclaims responsibility for, and you will fully indemnify TI and its representatives against, any claims, damages, costs, losses, and liabilities arising out of your use of these resources.

TI's products are provided subject to TI's Terms of Sale ([www.ti.com/legal/termsofsale.html](http://www.ti.com/legal/termsofsale.html)) or other applicable terms available either on [ti.com](http://ti.com) or provided in conjunction with such TI products. TI's provision of these resources does not expand or otherwise alter TI's applicable warranties or warranty disclaimers for TI products.

Mailing Address: Texas Instruments, Post Office Box 655303, Dallas, Texas 75265  
Copyright © 2020, Texas Instruments Incorporated