

THS3001 420MHz, High-Speed Current-Feedback Amplifier

1 Features

- High speed:
 - 420MHz bandwidth ($G = 1$, -3dB)
 - $6500\text{V}/\mu\text{s}$ slew rate
 - 40ns settling time (0.1%)
- High output drive: $I_O = 100\text{mA}$
- Excellent video performance
 - 115MHz bandwidth (0.1dB, $G = 2$)
 - 0.01% differential gain
 - 0.02° differential phase
- Low 3mV (max) input offset voltage
- Very low distortion:
 - THD = -96dBc at $f = 1\text{MHz}$
 - THD = -80dBc at $f = 10\text{MHz}$
- Wide range of power supplies:
 - $V_{CC} = \pm 4.5\text{V}$ to $\pm 16\text{V}$
- Evaluation module available

2 Applications

- Communication
- Imaging
- High-quality video

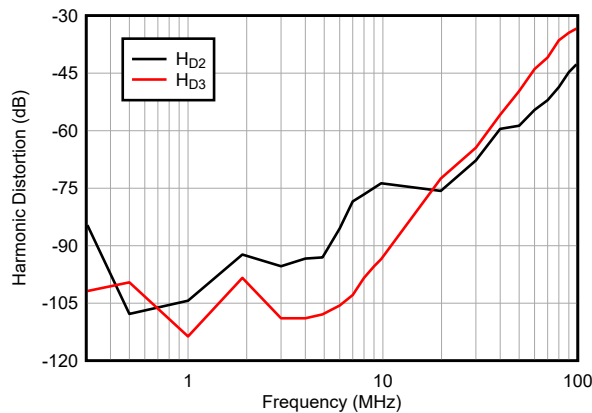

Harmonic Distortion vs Frequency

3 Description

The THS3001 is a high-speed, current-feedback operational amplifier, designed for communication, imaging, and high-quality video applications. This device offers a very fast $6500\text{V}/\mu\text{s}$ slew rate, a 420MHz bandwidth, and a 40ns settling time for large-signal applications requiring excellent transient response. In addition, the THS3001 operates with a very low distortion of -96dBc , making this device an excellent choice for applications such as wireless communication base stations or ultra-fast ADC or DAC buffers.

Package Information

PART NUMBER	PACKAGE ⁽¹⁾	PACKAGE SIZE ⁽²⁾
THS3001	D (SOIC, 8)	4.9mm × 6mm
	DGN (HVSSOP, 8)	3mm × 4.9mm

- (1) For more information, [Section 10](#).
- (2) The package size (length × width) is a nominal value and includes pins, where applicable.

Related Devices

THS4011 THS4012	290MHz VFB high-speed amplifier
THS6012	500mA CFB high-speed amplifier
THS6022	250mA CFB high-speed amplifier

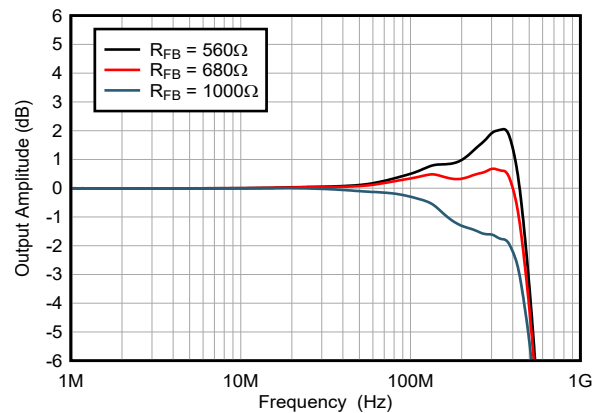

Output Amplitude vs Frequency



Table of Contents

1 Features	1	7 Application and Implementation	16
2 Applications	1	7.1 Application Information.....	16
3 Description	1	7.2 Typical Applications.....	19
4 Pin Configuration and Functions	3	7.3 Power Supply Recommendations.....	22
5 Specifications	4	7.4 Layout.....	22
5.1 Absolute Maximum Ratings.....	4	8 Device and Documentation Support	24
5.2 ESD Ratings.....	4	8.1 Device Support.....	24
5.3 Recommended Operating Conditions.....	4	8.2 Receiving Notification of Documentation Updates... 24	
5.4 Thermal Information.....	4	8.3 Support Resources.....	24
5.5 Electrical Characteristics.....	5	8.4 Trademarks.....	25
5.6 Typical Characteristics.....	7	8.5 Electrostatic Discharge Caution.....	25
6 Detailed Description	15	8.6 Glossary.....	25
6.1 Overview.....	15	9 Revision History	25
6.2 Functional Block Diagram.....	15	10 Mechanical, Packaging, and Orderable	
6.3 Device Functional Modes.....	15	Information	25

4 Pin Configuration and Functions

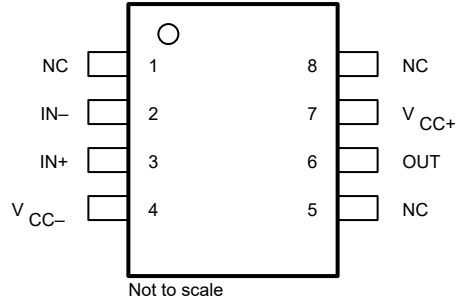

Figure 4-1. THS3001: D Package, 8-Pin SOIC, or DGN Package, 8-pin HVSSOP (Top View)

Table 4-1. Pin Functions

PIN		TYPE	DESCRIPTION
NO.	NAME		
1	NC	—	No internal connection
2	IN-	Input	Inverting input
3	IN+	Input	Noninverting input
4	V _{CC-}	Input	Negative power-supply connection
5	NC	—	No internal connection
6	OUT	Output	Amplifier output
7	V _{CC+}	Input	Positive power-supply connection
8	NC	—	No internal connection

5 Specifications

5.1 Absolute Maximum Ratings

over operating free-air temperature range (unless otherwise noted)⁽¹⁾

		MIN	MAX	UNITS
V _{CC}	Supply voltage, V _{CC+} to V _{CC-}		33	V
V _I	Input voltage	±V _{CC}	±V _{CC}	V
I _O	Output current		175	mA
V _{ID}	Differential input voltage		±6	V
T _J	Maximum junction temperature		150	°C
T _J	Maximum junction temperature, continuous operation, long term reliability ⁽²⁾		125	°C
T _A	Operating free-air temperature	–40	85	°C
T _{stg}	Storage temperature	–65	125	°C

- (1) Operation outside the *Absolute Maximum Ratings* can cause permanent device damage. *Absolute Maximum Ratings* do not imply functional operation of the device at these or any other conditions beyond those listed under *Recommended Operating Conditions*. If used outside the *Recommended Operating Conditions* but within the *Absolute Maximum Ratings*, the device may not be fully functional, and this may affect device reliability, functionality, performance, and shorten the device lifetime.
- (2) The maximum junction temperature for continuous operation is limited by package constraints. Operation greater than this temperature can result in reduced reliability and/or lifetime of the device.

5.2 ESD Ratings

			VALUE	UNIT
V _(ESD)	Electrostatic discharge	Human body model (HBM), per ANSI/ESDA/ JEDEC JS-001, all pins ⁽¹⁾	±2000	V
		Charged device model (CDM), per JEDEC specification JESD22-C101 ⁽²⁾	±1500	

- (1) JEDEC document JEP155 states that 500V HBM allows safe manufacturing with a standard ESD control process.
- (2) JEDEC document JEP157 states that 250V CDM allows safe manufacturing with a standard ESD control process.

5.3 Recommended Operating Conditions

over operating free-air temperature range (unless otherwise noted)

			MIN	NOM	MAX	UNIT
V _{CC}	Supply voltage	Dual-supply	±4.5	±15	±16	V
		Single-supply	9	30	32	
T _A	Operating free-air temperature		–40	25	85	°C

5.4 Thermal Information

THERMAL METRIC ⁽¹⁾		THS3001		UNIT
		D (SOIC)	DGN (HVSSOP)	
		8 PINS	8 PINS	
R _{θJA}	Junction-to-ambient thermal resistance	97.5	56.9	°C/W
R _{θJC(top)}	Junction-to-case (top) thermal resistance	38.3	78.2	°C/W
R _{θJB}	Junction-to-board thermal resistance	N/A	29.6	°C/W
Ψ _{JT}	Junction-to-top characterization parameter	N/A	4.7	°C/W
Ψ _{JB}	Junction-to-board characterization parameter	N/A	29.5	°C/W
R _{θJC(bot)}	Junction-to-case (bottom) thermal resistance	N/A	12.5	°C/W

- (1) For information about traditional and new thermal metrics, see the [Semiconductor and IC Package Thermal Metrics](#) application report.

5.5 Electrical Characteristics

at $T_A = 25^\circ\text{C}$, $R_L = 150\Omega$, and $R_F = 1\text{k}\Omega$ (unless otherwise noted)

PARAMETER		TEST CONDITIONS ⁽¹⁾		MIN	TYP	MAX	UNIT
DYNAMIC PERFORMANCE							
BW	Small-signal bandwidth (-3dB)	G = 1, $R_F = 1\text{k}\Omega$	$V_{CC} = \pm 5\text{V}$		330		MHz
			$V_{CC} = \pm 15\text{V}$		420		
		G = 2	$V_{CC} = \pm 5\text{V}$, $R_F = 750\Omega$		300		
			$V_{CC} = \pm 15\text{V}$, $R_F = 680\Omega$		385		
			$V_{CC} = \pm 15\text{V}$, $R_F = 560\Omega$		350		
		Bandwidth for 0.1dB flatness	G = 2	$V_{CC} = \pm 5\text{V}$, $R_F = 750\Omega$		65	
	$V_{CC} = \pm 15\text{V}$, $R_F = 680\Omega$				55		
	Full power bandwidth ⁽²⁾	$V_{CC} = \pm 5\text{V}$, $V_{O(PP)} = 4\text{V}$, $R_L = 500\Omega$	G = -5		65		
				G = 5		62	
$V_{CC} = \pm 15\text{V}$, $V_{O(PP)} = 20\text{V}$, $R_L = 500\Omega$			G = -5		32		
				G = 5		31	
SR	Slew rate ⁽¹⁾	$V_{CC} = \pm 5\text{V}$, $V_{O(PP)} = 4\text{V}$	G = -5		1700		V/ μs
			G = 5		1300		
		$V_{CC} = \pm 15\text{V}$, $V_{O(PP)} = 20\text{V}$	G = -5		6500		
			G = 5		6300		
t_s	Settling time to 0.1%	Gain = -1	$V_{CC} = \pm 15\text{V}$, 0V to 10V Step		40		ns
			$V_{CC} = \pm 5\text{V}$, 0V to 2V Step,		25		
NOISE AND DISTORTION PERFORMANCE							
THD	Total harmonic distortion	$V_{CC} = \pm 15\text{V}$, $V_{O(PP)} = 2\text{V}$, G = 2, $f_c = 10\text{MHz}$			-80		dBc
V_n	Input voltage noise	$V_{CC} = \pm 5\text{V}$ or $\pm 15\text{V}$ G = 2, f = 10kHz			1.6		nV/ $\sqrt{\text{Hz}}$
I_{np}	Noninverting input current noise	$V_{CC} = \pm 5\text{V}$ or $\pm 15\text{V}$, f = 10kHz, G = 2			13		pA/ $\sqrt{\text{Hz}}$
I_{nn}	Inverting input current noise	$V_{CC} = \pm 5\text{V}$ or $\pm 15\text{V}$, f = 10kHz, G = 2			16		pA/ $\sqrt{\text{Hz}}$

5.5 Electrical Characteristics (continued)

at $T_A = 25^\circ\text{C}$, $R_L = 150\Omega$, and $R_F = 1\text{k}\Omega$ (unless otherwise noted)

PARAMETER		TEST CONDITIONS ⁽¹⁾		MIN	TYP	MAX	UNIT
DC PERFORMANCE							
V_{IO}	Input offset voltage	$V_{CC} = \pm 5\text{V}$ or $\pm 15\text{V}$	$T_A = 25^\circ\text{C}$	1	3	4	mV
			$T_A = \text{full range}$				
	Input offset voltage drift	$V_{CC} = \pm 5\text{V}$ or $\pm 15\text{V}$		5			$\mu\text{V}/^\circ\text{C}$
Z_{OL}	Open loop transresistance	$V_{CC} = \pm 5\text{V}$, $V_O = \pm 2.5\text{V}$, $R_L = 1\text{k}\Omega$		1.3			M Ω
		$V_{CC} = \pm 15\text{V}$, $V_O = \pm 7.5\text{V}$, $R_L = 1\text{k}\Omega$		2.4			
I_{IB+}	Noninverting input bias current	$V_{CC} = \pm 5\text{V}$ or $\pm 15\text{V}$	$T_A = 25^\circ\text{C}$	2	10	15	μA
			$T_A = \text{full range}$				
I_{IB-}	Inverting input bias current	$V_{CC} = \pm 5\text{V}$ or $\pm 15\text{V}$	$T_A = 25^\circ\text{C}$	1	10	15	μA
			$T_A = \text{full range}$				
INPUT CHARACTERISTICS							
V_{ICR}	Common-mode input voltage range	$V_{CC} = \pm 5\text{V}$		± 3	± 3.2		V
		$V_{CC} = \pm 15\text{V}$		± 12.9	± 13.2		
CMRR	Common-mode rejection ratio	$V_{CC} = \pm 5\text{V}$, $V_{CM} = \pm 2.5\text{V}$		62	70		dB
		$V_{CC} = \pm 15\text{V}$, $V_{CM} = \pm 10\text{V}$		65	73		
R_{I+}	Noninverting input resistance			1.5			M Ω
R_{I-}	Inverting input resistance			15			Ω
C_i	Differential input capacitance			7.5			pF
OUTPUT CHARACTERISTICS							
V_O	Output voltage swing	$V_{CC} = \pm 5\text{V}$	$R_L = 150\Omega$	± 2.9	± 3.2	V	
			$R_L = 1\text{k}\Omega$	± 3	± 3.3		
		$V_{CC} = \pm 15\text{V}$	$R_L = 150\Omega$	± 12.1	± 12.8		
			$R_L = 1\text{k}\Omega$	± 12.8	± 13.1		
I_O	Output current ⁽²⁾	$V_{CC} = \pm 5\text{V}$, $R_L = 20\Omega$		100		mA	
		$V_{CC} = \pm 15\text{V}$, $R_L = 75\Omega$		85	120		
R_O	Output resistance	Open loop at 5MHz		10			Ω
POWER SUPPLY							
I_{CC}	Quiescent current	$V_{CC} = \pm 5\text{V}$	$T_A = 25^\circ\text{C}$	5.5	7.5	mA	
			$T_A = \text{full range}$		8.5		
		$V_{CC} = \pm 15\text{V}$	$T_A = 25^\circ\text{C}$	6.6	9		
			$T_A = \text{full range}$		10		
		$V_{CC} = \pm 18\text{V}$	$T_A = 25^\circ\text{C}$	6.9	9.5		
			$T_A = \text{full range}$		10.5		
PSRR	Power supply rejection ratio	$V_{CC} = \pm 5\text{V}$	$T_A = 25^\circ\text{C}$	65	76	dB	
			$T_A = \text{full range}$		63		
		$V_{CC} = \pm 15\text{V}$	$T_A = 25^\circ\text{C}$	69	76		
			$T_A = \text{full range}$		67		

(1) Full range = 0°C to 70°C for the THS3001C and -40°C to 85°C for the THS3001I.

(2) Observe power dissipation ratings to keep the junction temperature below absolute maximum when the output is heavily loaded or shorted. See [Section 7.4.1.2](#).

5.6 Typical Characteristics

Table 5-1. Table of Graphs

			FIGURE
$ V_{O} $	Output voltage swing	vs Free-air temperature	Figure 5-1
I_{CC}	Current supply	vs Free-air temperature	Figure 5-2
I_{IB}	Input bias current	vs Free-air temperature	Figure 5-3
V_{IO}	Input offset voltage	vs Free-air temperature	Figure 5-4
CMRR	Common-mode rejection ratio	vs Common-mode input voltage	Figure 5-5
		vs Common-mode input voltage	Figure 5-6
		vs Frequency	Figure 5-7
	Transresistance	vs Free-air temperature	Figure 5-8
	Closed-loop output impedance	vs Frequency	Figure 5-9
V_n	Voltage noise	vs Frequency	Figure 5-10
I_n	Current noise		
PSRR	Power supply rejection ratio	vs Frequency	Figure 5-11
		vs Free-air temperature	Figure 5-12
SR	Slew rate	vs Output step peak-to-peak	Figure 5-13, Figure 5-14
	Normalized slew rate	vs Gain	Figure 5-15
	Harmonic distortion	vs Peak-to-peak output voltage swing	Figure 5-16, Figure 5-17
		vs Frequency	Figure 5-18, Figure 5-19
	Output amplitude	vs Frequency	Figure 5-20 to Figure 5-24
	Normalized output response	vs Frequency	Figure 5-25 to Figure 5-28
	Small- and large-signal frequency response		Figure 5-29, Figure 5-30
	Small-signal pulse response		Figure 5-31, Figure 5-32
	Large-signal pulse response		Figure 5-33 to Figure 5-40

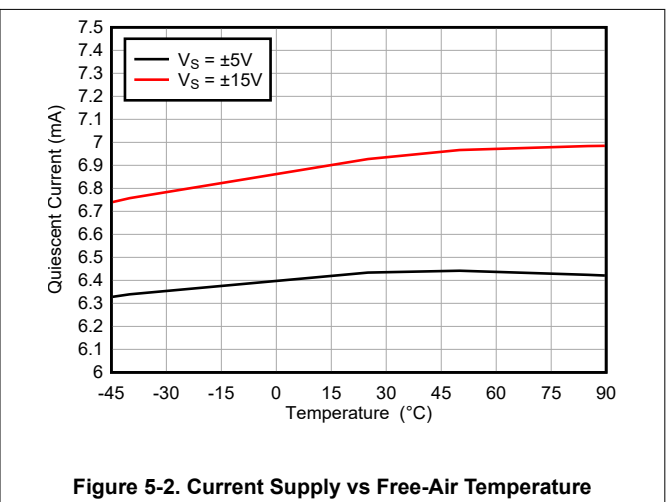
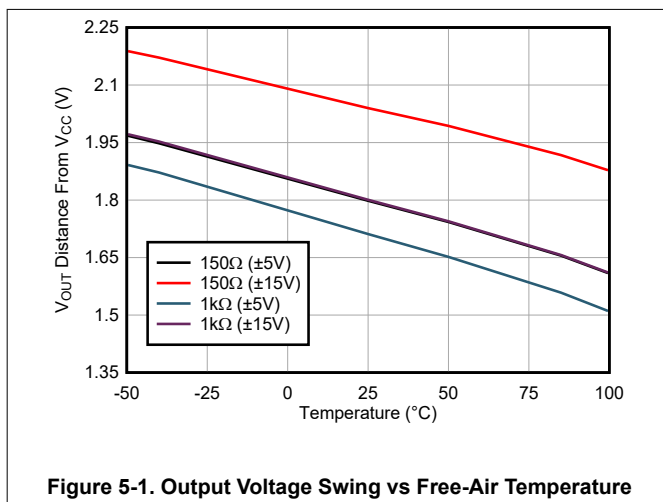

5.6 Typical Characteristics (continued)

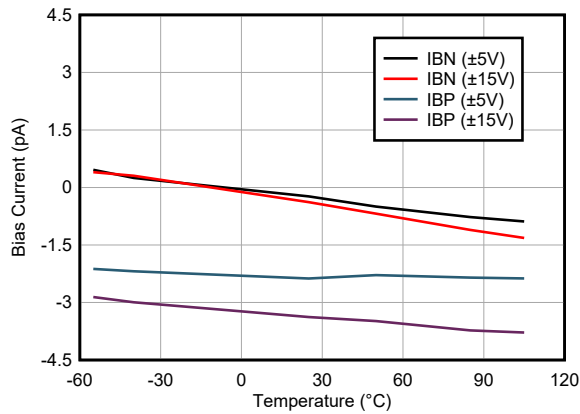

Figure 5-3. Input Bias Current vs Free-Air Temperature

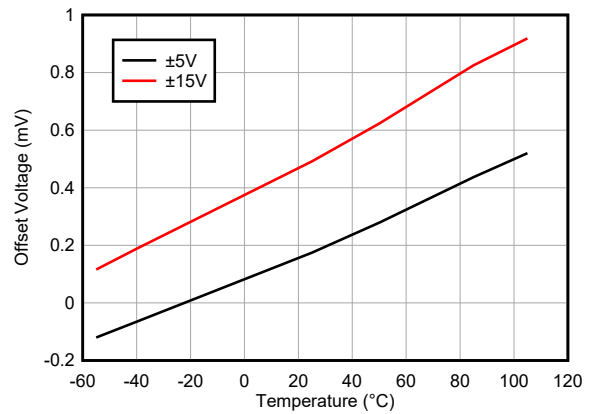

Figure 5-4. Input Offset Voltage vs Free-Air Temperature

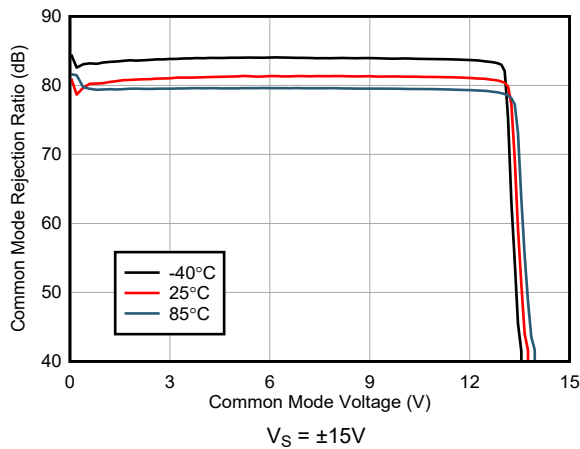

Figure 5-5. Common-Mode Rejection Ratio vs Common-Mode Input Voltage

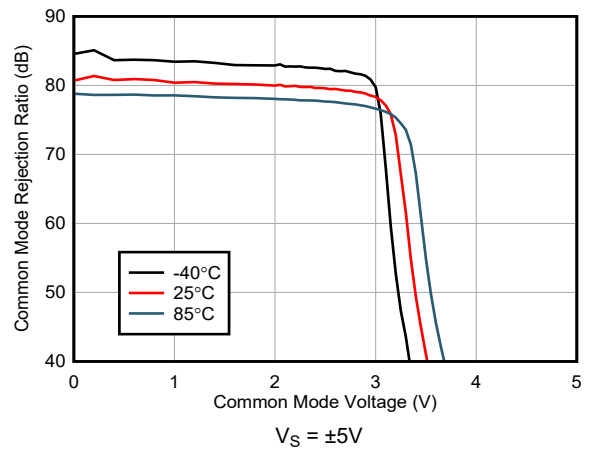

Figure 5-6. Common-Mode Rejection Ratio vs Common-Mode Input Voltage

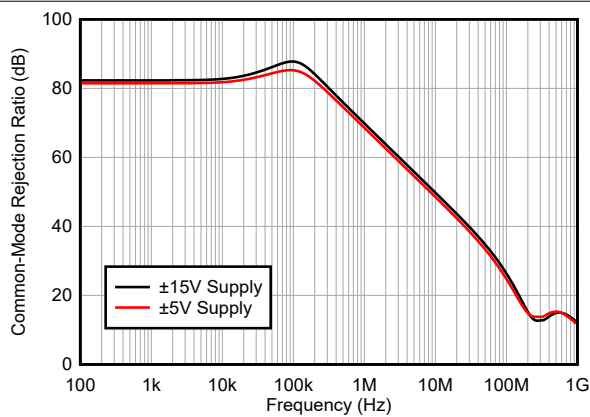

Figure 5-7. Common-Mode Rejection Ratio vs Frequency

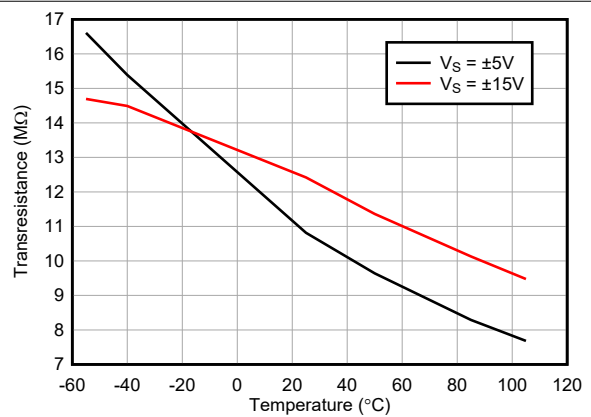

Figure 5-8. Transresistance vs Free-Air Temperature

5.6 Typical Characteristics (continued)

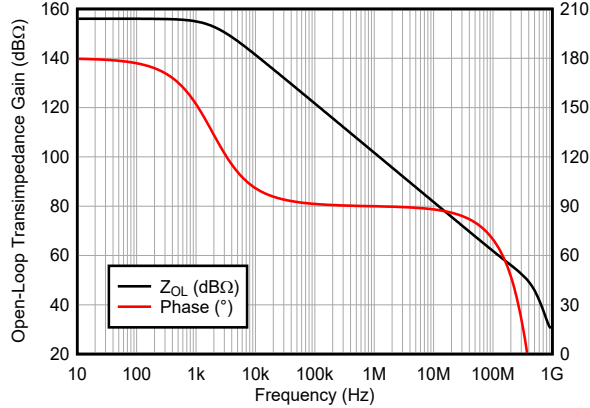

Figure 5-9. Closed-Loop Output Impedance vs Frequency

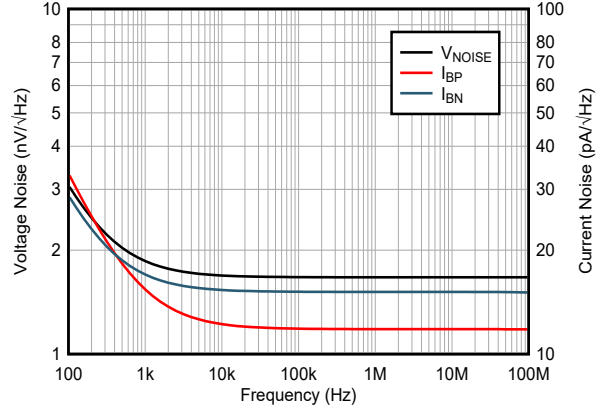

Figure 5-10. Voltage Noise and Current Noise vs Frequency

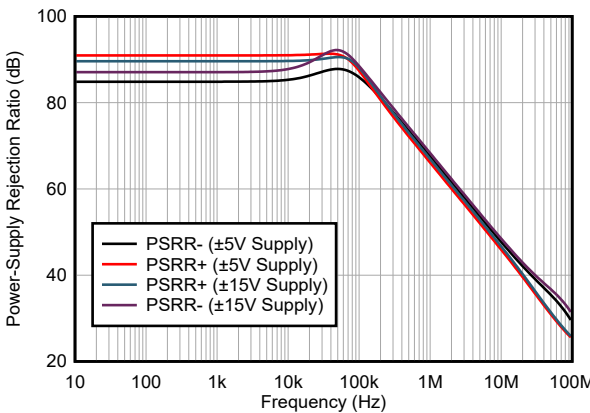

Figure 5-11. Power Supply Rejection Ratio vs Frequency

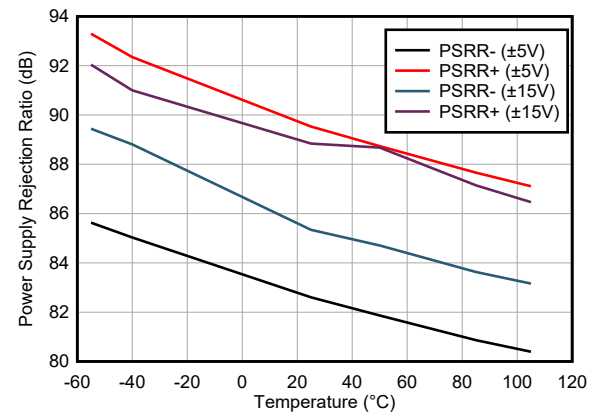
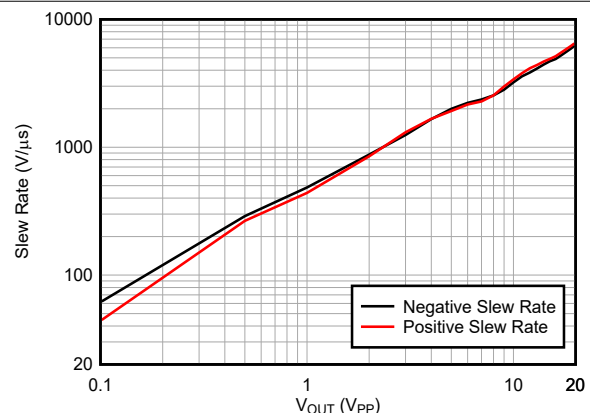
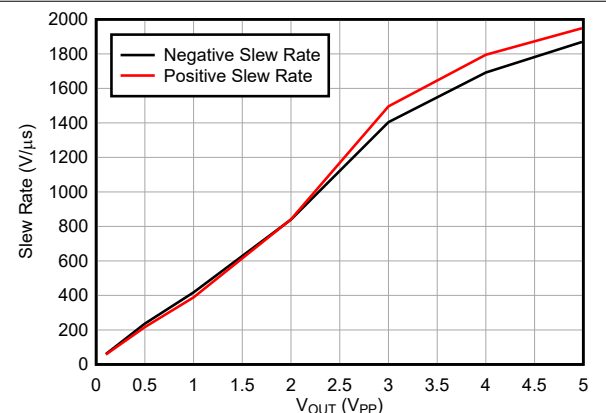

Figure 5-12. Power Supply Rejection Ratio vs Free-Air Temperature



$V_S = \pm 15V$, gain = +5, $R_L = 150\Omega$, $R_{FB} = 1k\Omega$,
 $t_{RISE/FALL} = 300ps$, $V_{OUT} = 4V_{PP}$

Figure 5-13. Slew Rate vs Output Step



$V_S = \pm 5V$, gain = +5, $R_L = 150\Omega$, $R_{FB} = 1k\Omega$,
 $t_{RISE/FALL} = 300ps$

Figure 5-14. Slew Rate vs Output Step

5.6 Typical Characteristics (continued)

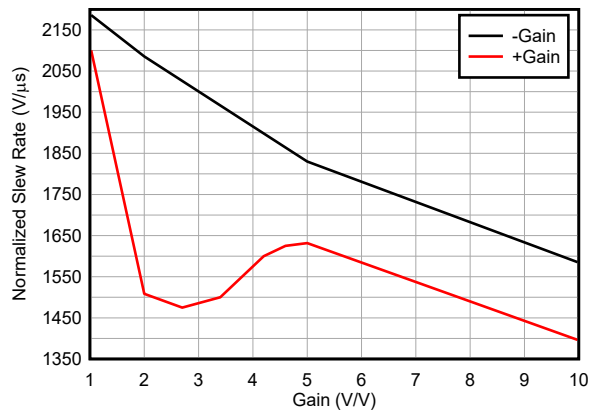

$V_S = \pm 5V$, $R_L = 150\Omega$, $R_{FB} = 1k\Omega$, $t_{RISE/FALL} = 300ps$,
 $V_{OUT} = 4V_{PP}$

Figure 5-15. Normalized Slew Rate vs Gain

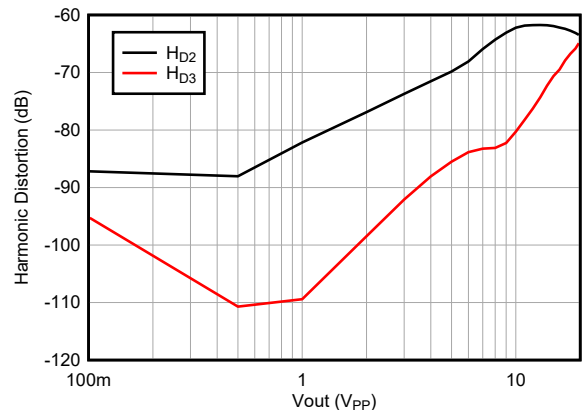

$V_S = \pm 15V$, gain = +2, $R_L = 150\Omega$, $R_{FB} = 680\Omega$, $f_{IN} = 8MHz$

Figure 5-16. Harmonic Distortion vs Peak-to-Peak Output Voltage Swing

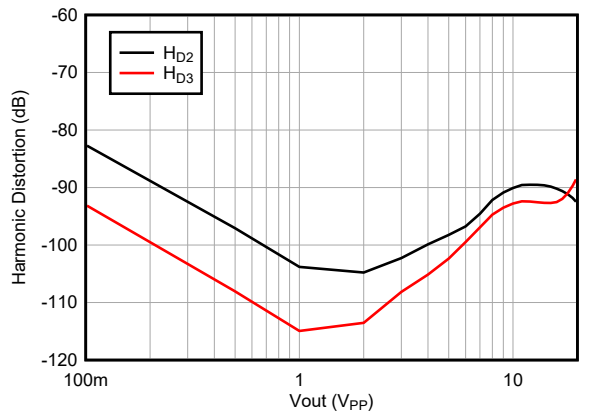

$V_S = \pm 15V$, gain = +2, $R_L = 150\Omega$, $R_{FB} = 680\Omega$, $f_{IN} = 1MHz$

Figure 5-17. Harmonic Distortion vs Peak-to-Peak Output Voltage Swing

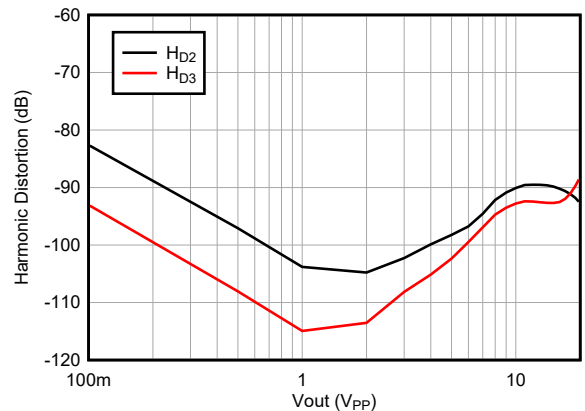

$V_S = \pm 15V$, gain = +2, $R_L = 150\Omega$, $R_{FB} = 680\Omega$, $V_{OUT} = 2V_{PP}$

Figure 5-18. Harmonic Distortion vs Frequency

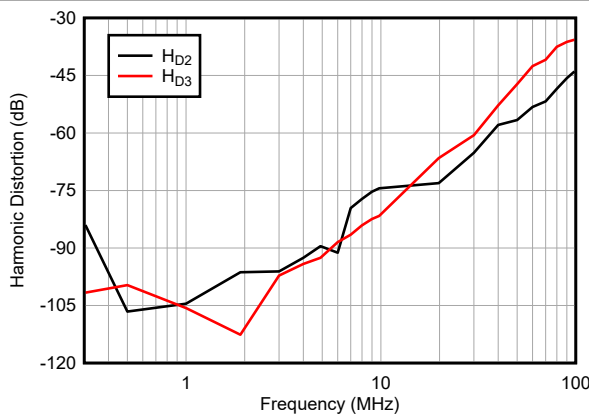

$V_S = \pm 5V$, gain = +2, $R_L = 150\Omega$, $R_{FB} = 680\Omega$, $V_{OUT} = 2V_{PP}$

Figure 5-19. Harmonic Distortion vs Frequency

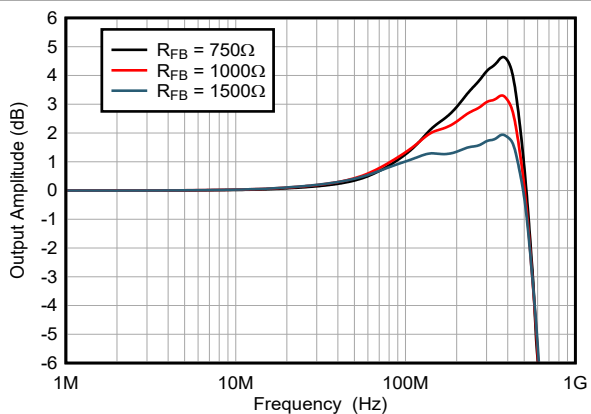

$V_S = \pm 15V$, gain = +1, $R_L = 150\Omega$, $V_{IN} = 200mV_{RMS}$

Figure 5-20. Output Amplitude vs Frequency

5.6 Typical Characteristics (continued)

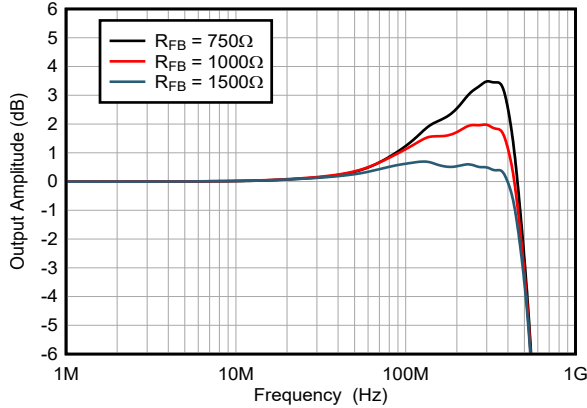

$V_S = \pm 5V$, gain = +1, $R_L = 150\Omega$, $V_{IN} = 200mV_{RMS}$

Figure 5-21. Output Amplitude vs Frequency

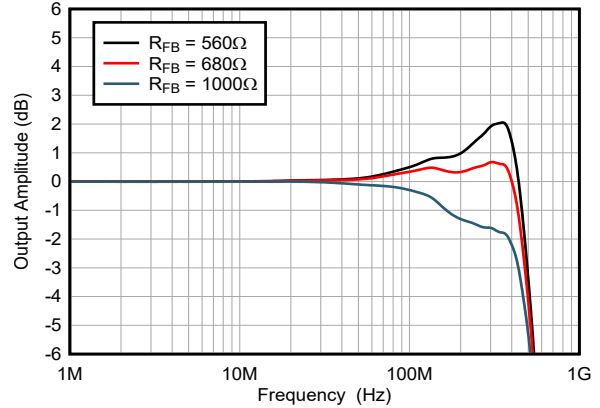

$V_S = \pm 15V$, gain = +2, $R_L = 150\Omega$, $V_{IN} = 200mV_{RMS}$

Figure 5-22. Output Amplitude vs Frequency

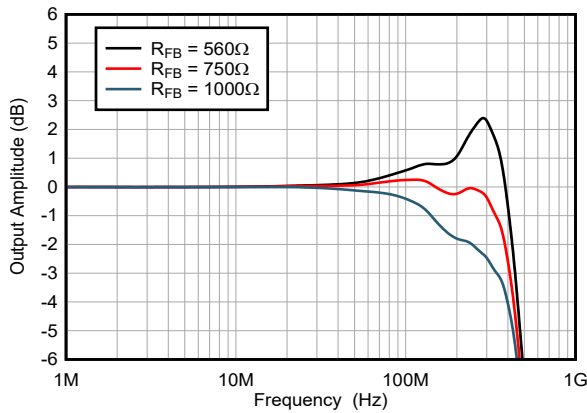

$V_S = \pm 5V$, gain = +2, $R_L = 150\Omega$, $V_{IN} = 200mV_{RMS}$

Figure 5-23. Output Amplitude vs Frequency

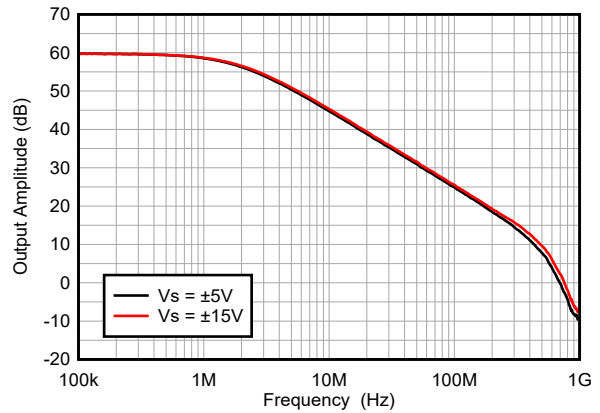

Gain = +1000, $R_L = 150\Omega$, $R_{FB} = 10k\Omega$, $V_{OUT} = 200mV_{RMS}$

Figure 5-24. Output Amplitude vs Frequency

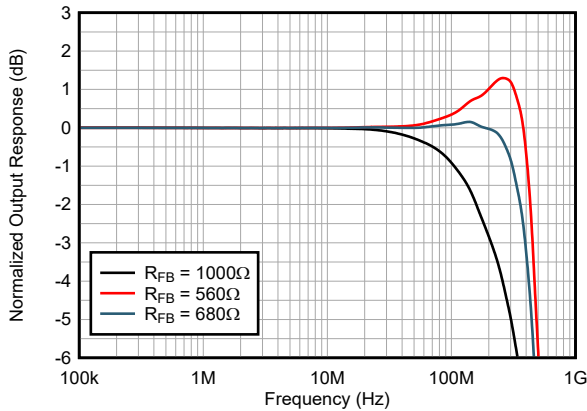

$V_S = \pm 15V$, gain = -1, $R_L = 150\Omega$, $V_{IN} = 200mV_{RMS}$

Figure 5-25. Normalized Output Response vs Frequency

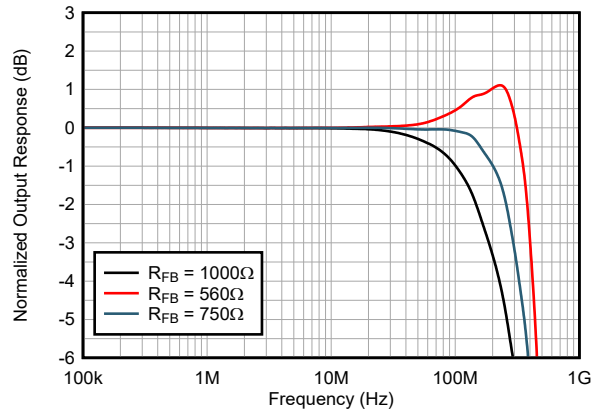

$V_S = \pm 5V$, gain = -1, $R_L = 150\Omega$, $V_{IN} = 200mV_{RMS}$

Figure 5-26. Normalized Output Response vs Frequency

5.6 Typical Characteristics (continued)

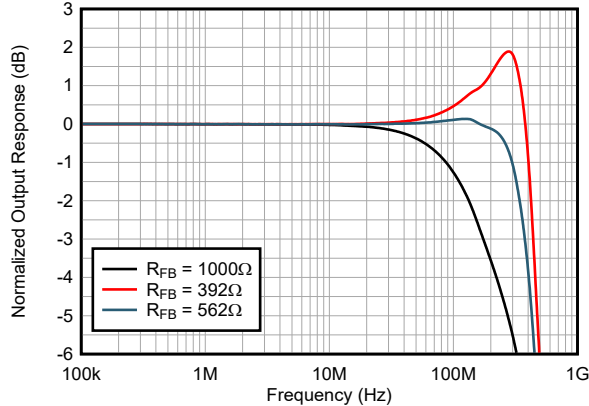

$V_S = \pm 15V$, gain = +5, $R_L = 150\Omega$, $V_{IN} = 200mV_{RMS}$

Figure 5-27. Normalized Output Response vs Frequency

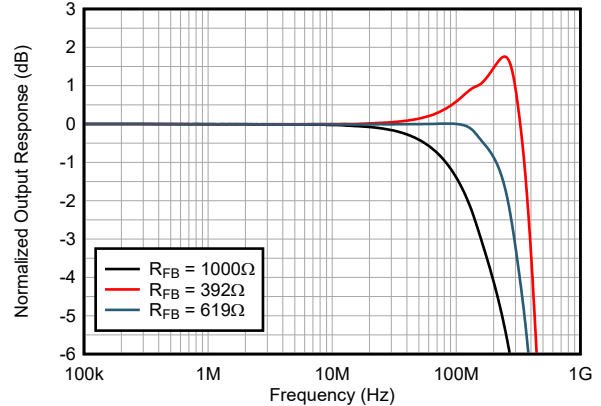

$V_S = \pm 5V$, gain = +5, $R_L = 150\Omega$, $V_{IN} = 200mV_{RMS}$

Figure 5-28. Normalized Output Response vs Frequency

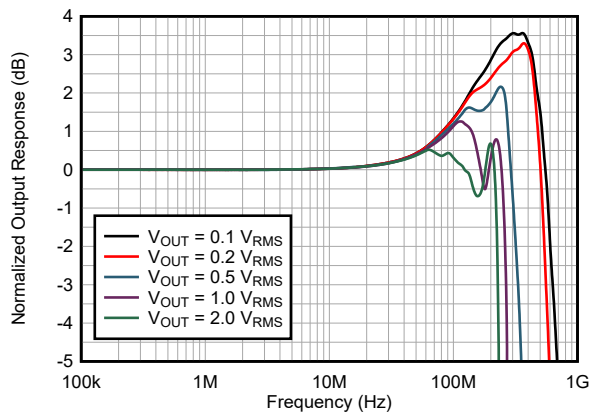

$V_S = \pm 15V$, gain = +1, $R_L = 150\Omega$, $R_{FB} = 1k\Omega$

Figure 5-29. Small- and Large-Signal Frequency Response

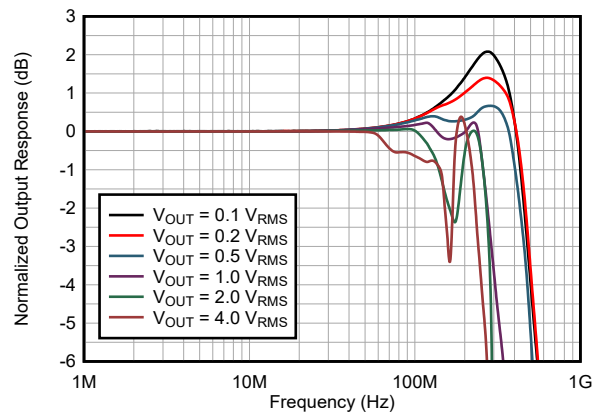

$V_S = \pm 15V$, gain = +2, $R_L = 150\Omega$, $R_{FB} = 680\Omega$

Figure 5-30. Small- and Large-Signal Frequency Response

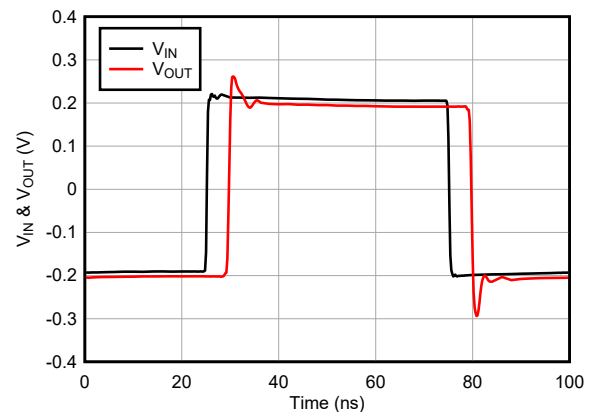

$V_S = \pm 5V$, gain = +1, $R_L = 150\Omega$, $R_{FB} = 1k\Omega$,
 $t_{RISE/FALL} = 300ps$

Figure 5-31. Small-Signal Pulse Response

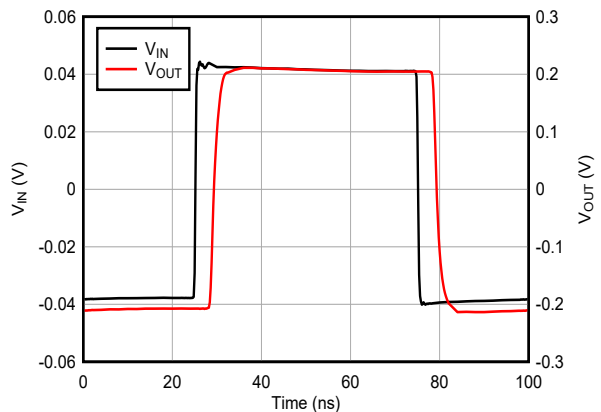

$V_S = \pm 5V$, gain = +5, $R_L = 150\Omega$, $R_{FB} = 1k\Omega$,
 $t_{RISE/FALL} = 300ps$

Figure 5-32. Small-Signal Pulse Response

5.6 Typical Characteristics (continued)

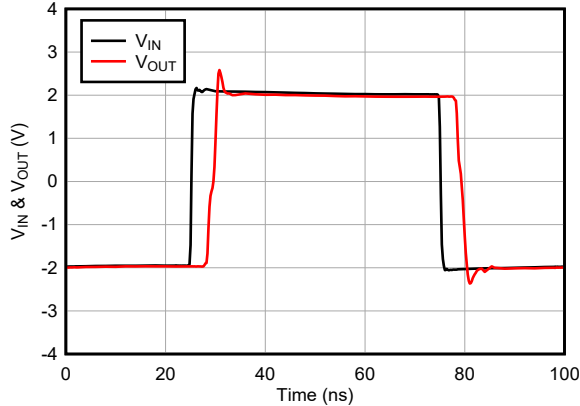

$V_S = \pm 15V$, gain = +1, $R_L = 150\Omega$, $R_{FB} = 1k\Omega$,
 $t_{RISE/FALL} = 300ps$

Figure 5-33. Large-Signal Pulse Response

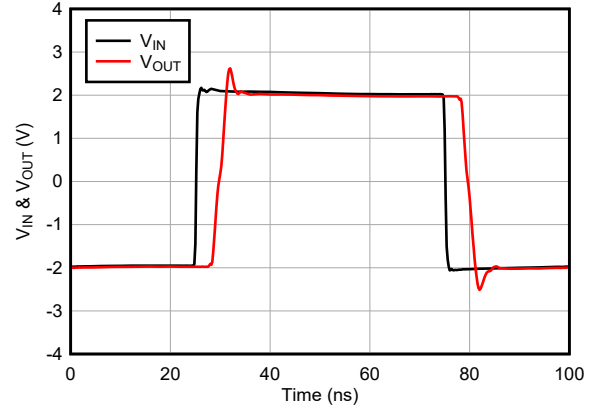

$V_S = \pm 5V$, gain = +1, $R_L = 150\Omega$, $R_{FB} = 1k\Omega$,
 $t_{RISE/FALL} = 300ps$

Figure 5-34. Large-Signal Pulse Response

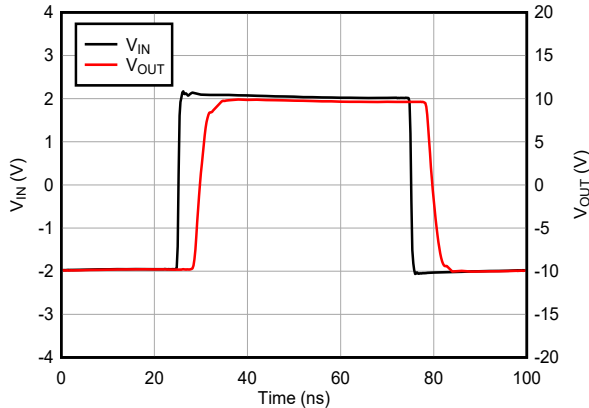

$V_S = \pm 15V$, gain = +5, $R_L = 150\Omega$, $R_{FB} = 1k\Omega$,
 $t_{RISE/FALL} = 300ps$

Figure 5-35. Large-Signal Pulse Response

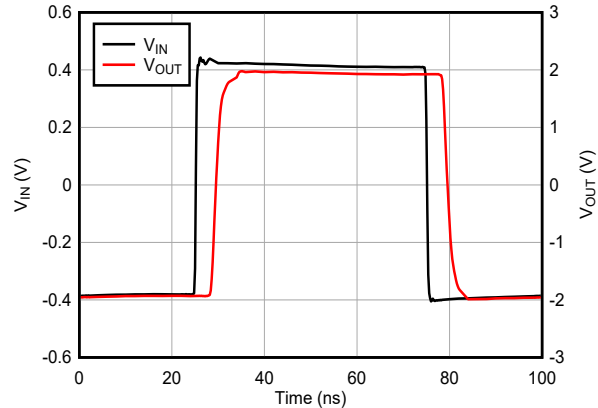

$V_S = \pm 5V$, gain = +5, $R_L = 150\Omega$, $R_{FB} = 1k\Omega$,
 $t_{RISE/FALL} = 300ps$

Figure 5-36. Large-Signal Pulse Response

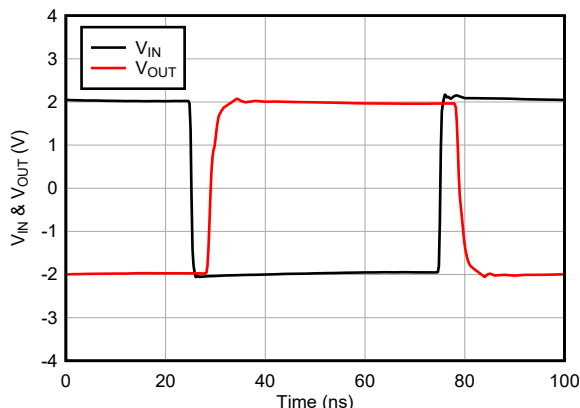

$V_S = \pm 15V$, gain = -1, $R_L = 150\Omega$, $R_{FB} = 1k\Omega$,
 $t_{RISE/FALL} = 300ps$

Figure 5-37. Large-Signal Pulse Response

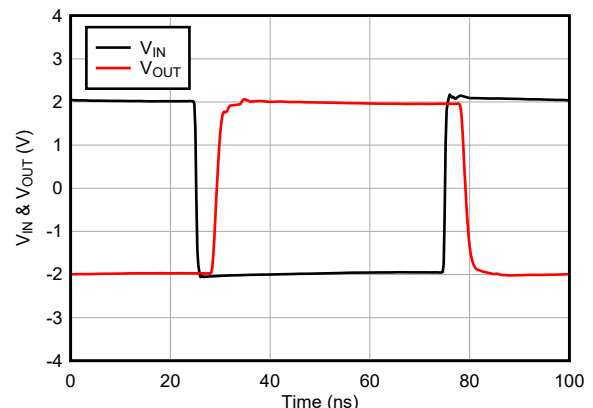

$V_S = \pm 5V$, gain = -1, $R_L = 150\Omega$, $R_{FB} = 1k\Omega$,
 $t_{RISE/FALL} = 300ps$

Figure 5-38. Large-Signal Pulse Response

5.6 Typical Characteristics (continued)

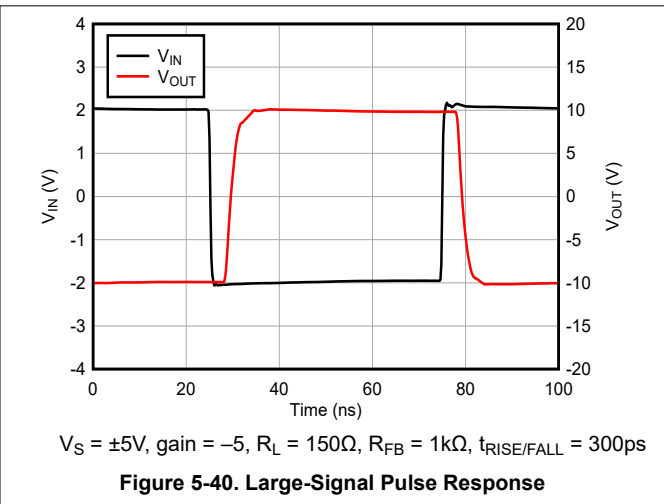
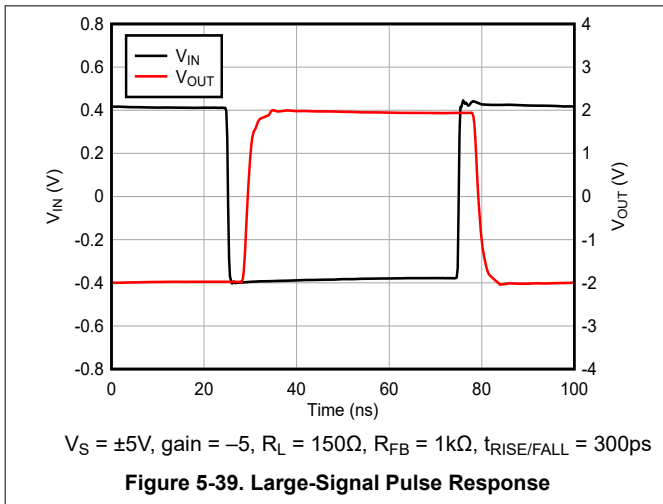

6 Detailed Description

6.1 Overview

The THS3001 is a high-speed operational amplifier configured in a current-feedback architecture. The device is built using a 30V, dielectrically isolated, complementary, bipolar process with NPN and PNP transistors possessing f_T s of several GHz. This configuration implements an exceptionally high-performance amplifier that has a wide bandwidth, high slew rate, fast settling time, and low distortion. Figure 6-1 shows a simplified schematic.

6.2 Functional Block Diagram

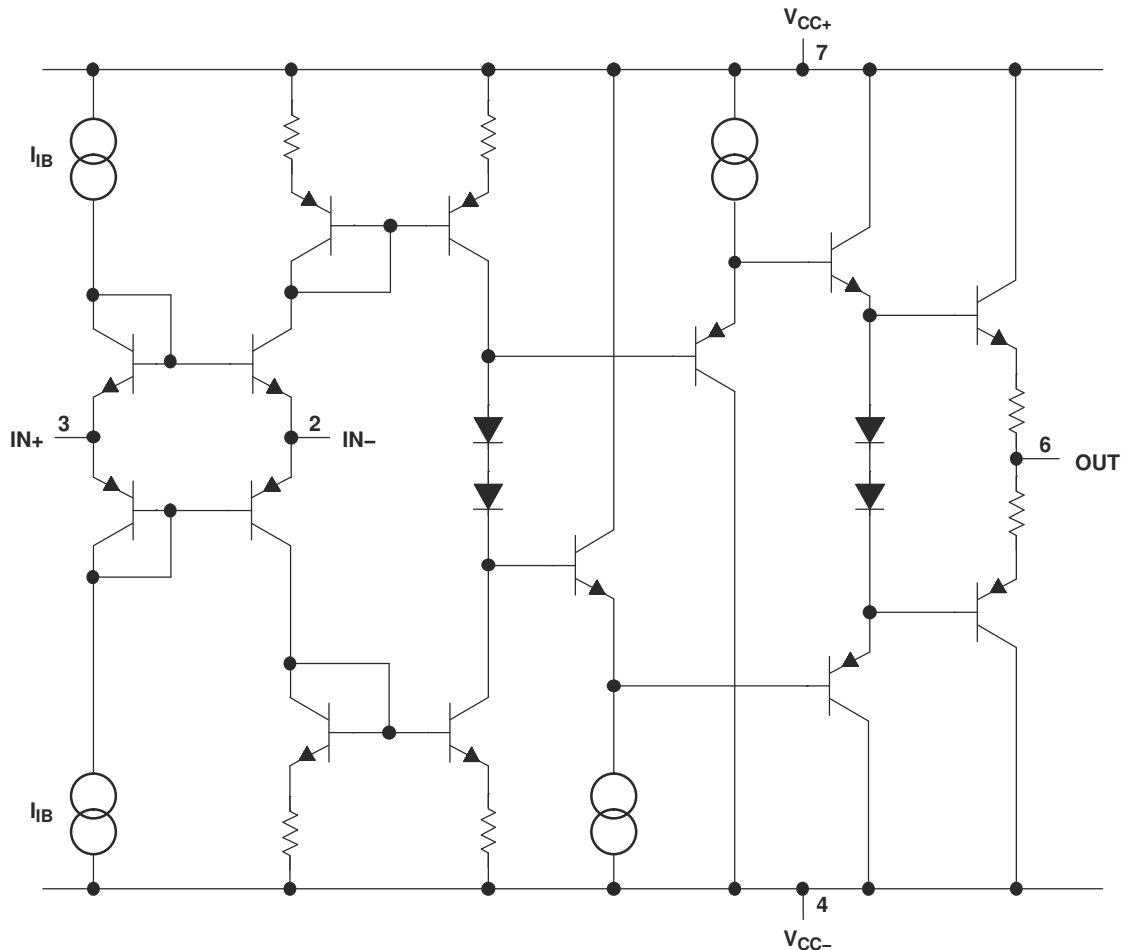

Figure 6-1. Simplified Schematic

6.3 Device Functional Modes

The THS3001 has a single functional mode and can be used with both single-supply or split power-supply configurations. The power-supply voltage must be greater than 9V ($\pm 4.5V$) and less than 32V ($\pm 16V$).

7 Application and Implementation

Note

Information in the following applications sections is not part of the TI component specification, and TI does not warrant its accuracy or completeness. TI's customers are responsible for determining suitability of components for their purposes, as well as validating and testing their design implementation to confirm system functionality.

7.1 Application Information

7.1.1 Recommended Feedback and Gain Resistor Values

The THS3001 is fabricated using Texas Instruments 30V complementary bipolar process, HVBiCOM. This process provides the excellent isolation and extremely high slew rates that result in excellent distortion characteristics.

As with all current-feedback amplifiers, the bandwidth of the THS3001 is an inversely proportional function of the value of the feedback resistor (see Figures 26 to 34). [Table 7-1](#) shows the recommended resistors for an optimized frequency response. Use these values as a starting point, and after optimized values are found, use a 1% tolerance resistors to maintain frequency response characteristics. For most applications, a feedback resistor value of 1k Ω is recommended, a good compromise between bandwidth and phase margin that yields a stable amplifier.

Table 7-1. Recommended Resistor Values for an Optimized Frequency Response

GAIN	R _F FOR V _{CC} = \pm 15V	R _F FOR V _{CC} = \pm 5V
1	1k Ω	1k Ω
2, -1	680 Ω	750 Ω
2	620 Ω	620 Ω
5	560 Ω	620 Ω

Consistent with current-feedback amplifiers, increasing the gain is best accomplished by changing the gain resistor, not the feedback resistor. The reason is because the bandwidth of the amplifier is dominated by the feedback resistor value and internal dominant-pole capacitor. The ability to control the amplifier gain independent of the bandwidth constitutes a major advantage of current-feedback amplifiers over conventional voltage-feedback amplifiers. Therefore, after a frequency response is found that is designed for a particular application, adjust the value of the gain resistor to increase or decrease the overall amplifier gain.

Finally, make sure to realize the effects of the feedback resistance on distortion. Increasing the resistance decreases the loop gain and increases the distortion. Knowing that decreasing load impedance increases total harmonic distortion (THD) is also important. Typically, the third-order harmonic distortion increases more than the second-order harmonic distortion.

7.1.2 Noise Calculations

Noise can cause errors on small signals. This problem is especially true for amplifying small signals coming over a transmission line or an antenna. The noise model for current-feedback (CFB) amplifiers is the same as for voltage-feedback (VFB) amplifiers. The only difference between CFB and VFB amplifiers is that CFB amplifiers generally specify different current-noise parameters for each input, whereas VFB amplifiers usually only specify one noise-current parameter. Figure 7-1 shows the noise model. This model includes all of the noise sources as follows:

- e_n = Amplifier internal voltage noise ($\text{nV}/\sqrt{\text{Hz}}$)
- $\text{IN}+$ = Noninverting current noise ($\text{pA}/\sqrt{\text{Hz}}$)
- $\text{IN}-$ = Inverting current noise ($\text{pA}/\sqrt{\text{Hz}}$)
- e_{R_x} = Thermal voltage noise associated with each resistor ($e_{R_x} = 4 \text{ kTR}_x$)

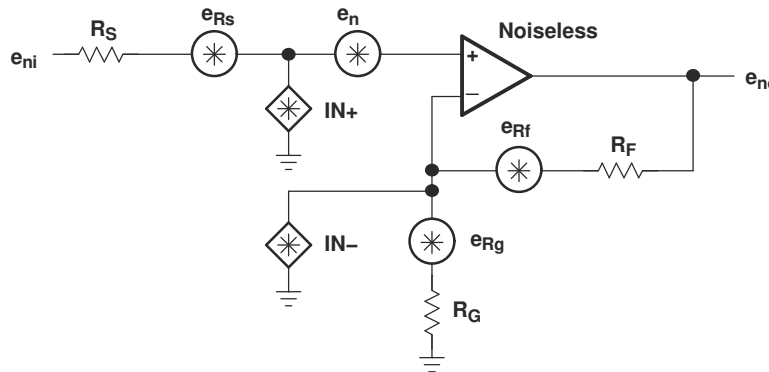

Figure 7-1. Noise Model

The total equivalent input noise density (e_{ni}) is calculated by using the following equation:

$$e_{ni} = \sqrt{(e_n)^2 + (\text{IN}+ \times R_S)^2 + (\text{IN}- \times (R_F \parallel R_G))^2 + 4 \text{ kTR}_S + 4 \text{ kT}(R_F \parallel R_G)}$$

Where:

k = Boltzmann's constant = 1.380658×10^{-23}

T = Temperature in degrees Kelvin ($273 + ^\circ\text{C}$)

$R_F \parallel R_G$ = Parallel resistance of R_F and R_G

(1)

To get the equivalent output noise of the amplifier, just multiply the equivalent input noise density (e_{ni}) by the overall amplifier gain (A_V).

$$e_{no} = e_{ni} A_V = e_{ni} \left(1 + \frac{R_F}{R_G} \right) \text{ (Noninverting Case)}$$

(2)

The previous equations show that to keep noise at a minimum, use small-value resistors. As the closed-loop gain is increased (by reducing R_G), the input noise is reduced considerably because of the parallel resistance term. This result leads to the general conclusion that the most dominant noise sources are the source resistor (R_S) and the internal amplifier noise voltage (e_n). Noise is summed in a root-mean-squares method; therefore, noise sources smaller than 25% of the largest noise source can be effectively ignored. This threshold can greatly simplify the formula and make noise calculations much easier.

7.1.3 Slew Rate

The slew rate performance of a current-feedback amplifier, like the THS3001, is affected by many different factors. Some of these factors are external to the device, such as amplifier configuration and PCB parasitics, and others are internal to the device, such as available currents and node capacitance. Understanding some of these factors can help the PCB designer arrive at a more optimum circuit with fewer problems.

Whether the THS3001 is used in an inverting amplifier configuration or a noninverting configuration can impact the output slew rate. As can be seen from the specification tables as well as some of the figures in this data sheet, slew-rate performance in the inverting configuration is faster than in the noninverting configuration. This is because in the inverting configuration the input terminals of the amplifier are at a virtual ground and do not significantly change voltage as the input changes. Consequently, the time to charge any capacitance on these input nodes is less than for the noninverting configuration, where the input nodes actually do change in voltage an amount equal to the size of the input step. In addition, any PCB parasitic capacitance on the input nodes degrades the slew rate further simply because there is more capacitance to charge. Also, if the supply voltage (V_{CC}) to the amplifier is reduced, slew rate decreases because there is less current available within the amplifier to charge the capacitance on the input nodes as well as other internal nodes.

Internally, the THS3001 has other factors that impact the slew rate. The amplifiers behavior during the slew-rate transition varies slightly depending upon the rise time of the input. This is because of the way the input stage handles faster and faster input edges. Slew rates (as measured at the amplifier output) of less than about $1500\text{V}/\mu\text{s}$ are processed by the input stage in a linear fashion. Consequently, the output waveform smoothly transitions between initial and final voltage levels. This is shown in Figure 7-2. For slew rates greater than $1500\text{V}/\mu\text{s}$, additional slew-enhancing transistors present in the input stage begin to turn on to support these faster signals. The result is an amplifier with extremely fast slew-rate capabilities. Figure 7-2 and Figure 7-3 show waveforms for these faster slew rates. The additional aberrations present in the output waveform with these faster-slewing input signals are due to the brief saturation of the internal current mirrors. This phenomenon, which typically lasts less than 20ns , is considered normal operation and is not detrimental to the device in any way. If for any reason this type of response is not desired, then increasing the feedback resistor or slowing down the input-signal slew rate reduces the effect.

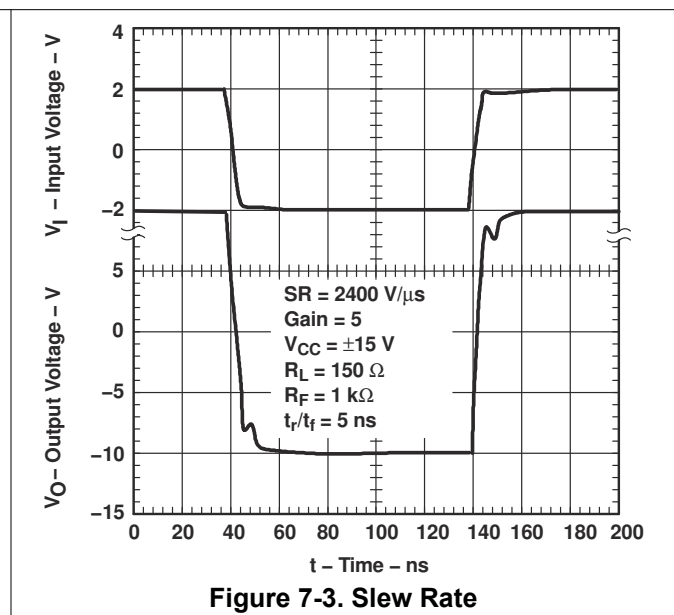
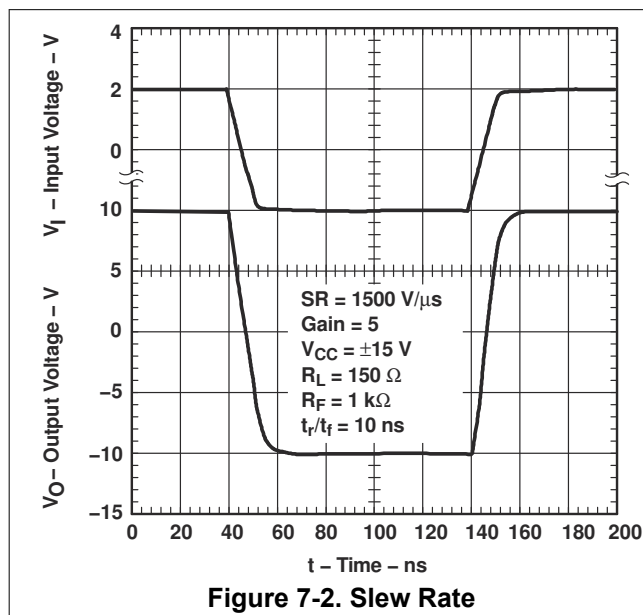

7.1.4 Offset Voltage

The output offset voltage, (V_{OO}) is the sum of the input offset voltage (V_{IO}) and both input bias currents (I_{IB}) times the corresponding gains. The following schematic and formula can be used to calculate the output offset voltage:

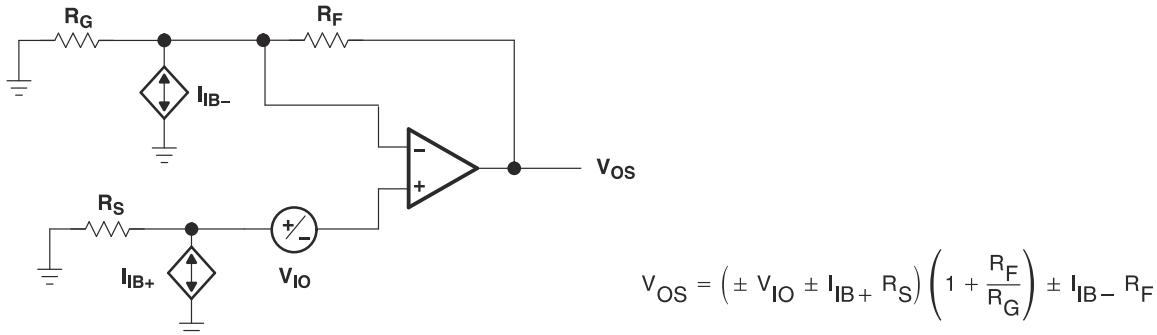

Figure 7-4. Output Offset Voltage Model

7.2 Typical Applications

7.2.1 General Configurations

A common error for the first-time CFB user is the creation of a unity gain buffer amplifier by shorting the output directly to the inverting input. A CFB amplifier in this configuration can oscillate and is *not* recommended. The THS3001, like all CFB amplifiers, *must* have a feedback resistor for stable operation. Additionally, placing capacitors directly from the output to the inverting input is not recommended. This is because, at high frequencies, a capacitor has a low impedance. This results in an unstable amplifier when using a current-feedback amplifier. Because of this, integrators and simple low-pass filters, which are easily implemented on a VFB amplifier, have to be designed slightly differently. If filtering is required, simply place an RC-filter at the noninverting terminal of the operational-amplifier (see Figure 7-5).

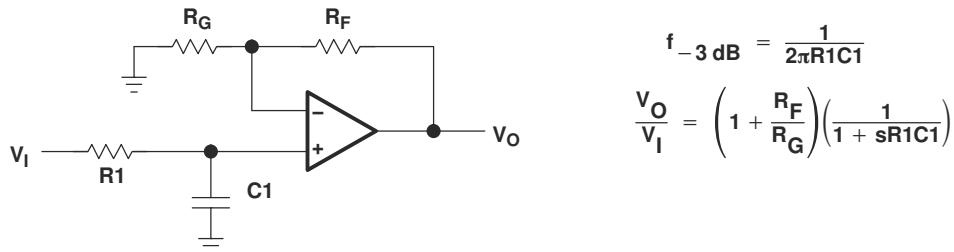

Figure 7-5. Single-Pole Low-Pass Filter

If a multiple-pole filter is required, the use of a Sallen-Key filter can work well with CFB amplifiers. This is because the filtering elements are not in the negative feedback loop and stability is not compromised. A CFB amplifier high slew rate and bandwidth can create accurate signals and help minimize distortion. An example is shown in Figure 7-6.

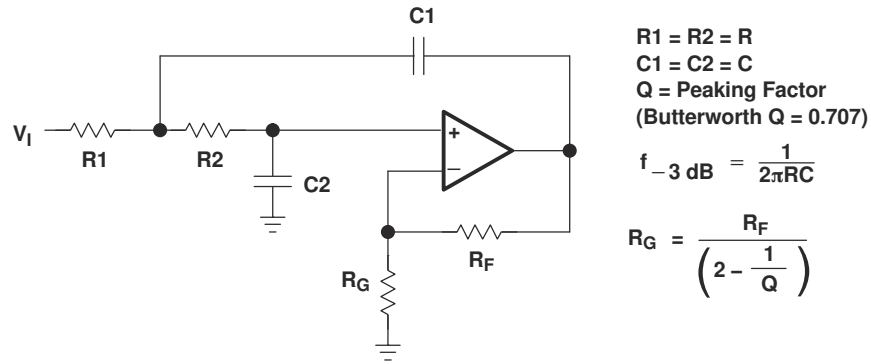

Figure 7-6. 2-Pole Low-Pass Sallen-Key Filter

There are two simple ways to create an integrator with a CFB amplifier. The first, shown in Figure 7-7, adds a resistor in series with the capacitor. This is acceptable because at high frequencies, the resistor is dominant and the feedback impedance never drops below the resistor value. The second, shown in Figure 7-8, uses positive feedback to create the integration. Caution is advised because oscillations can occur due to the positive feedback.

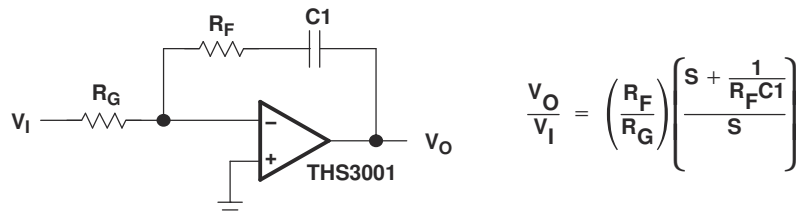

Figure 7-7. Inverting CFB Integrator

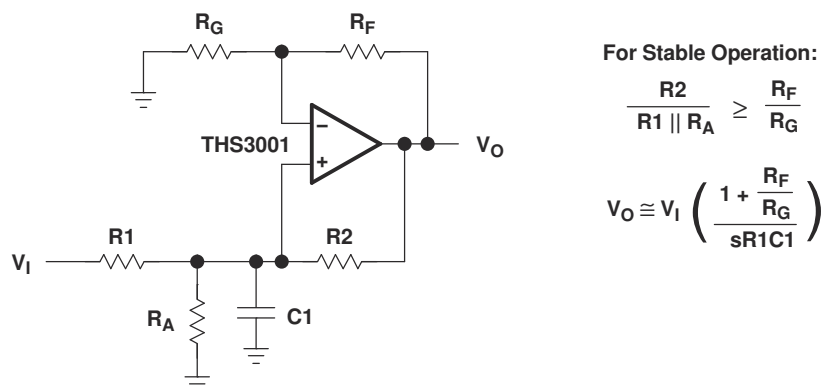

Figure 7-8. Noninverting CFB Integrator

The THS3001 can also be employed as a good video distribution amplifier. One characteristic of distribution amplifiers is the fact that the differential phase (DP) and the differential gain (DG) are compromised as the number of lines increases and the closed-loop gain increases (see Figures 22 to 25 for more information). Be sure to use termination resistors throughout the distribution system to minimize reflections and capacitive loading.

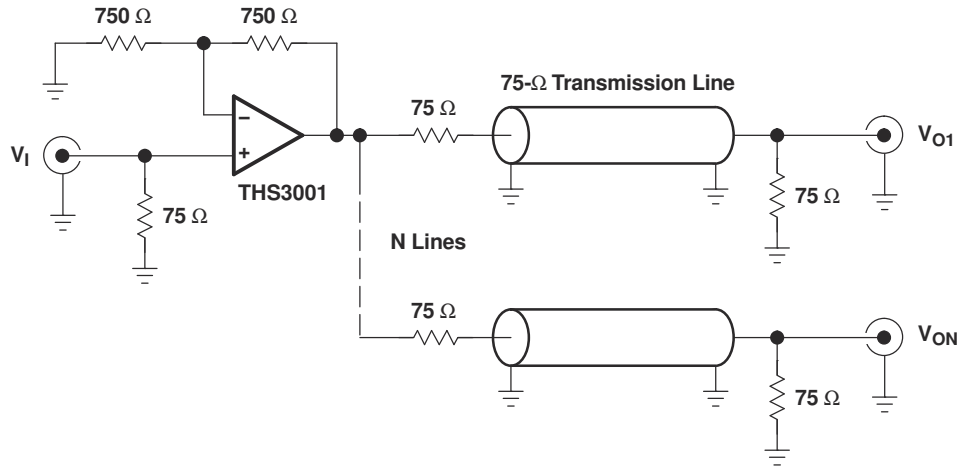

Figure 7-9. Video Distribution Amplifier Application

7.2.2 Driving a Capacitive Load

Driving capacitive loads with high-performance amplifiers is not a problem as long as certain precautions are taken. The first is to realize that the THS3001 has been internally compensated to maximize the bandwidth and slew-rate performance. When the amplifier is compensated in this manner, capacitive loading directly on the output decreases the device phase margin leading to high-frequency ringing or oscillations. Therefore, for capacitive loads of greater than 10pF, a resistor needs to be placed in series with the output of the amplifier, as shown in Figure 7-10. A minimum value of 20Ω can work adequately for most applications. For example, in 75Ω transmission systems, setting the series resistor value to 75Ω both isolates any capacitance loading and provides the proper line impedance matching at the source end.

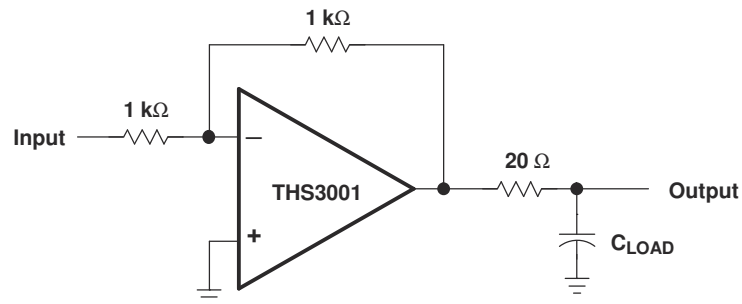

Figure 7-10. Driving a Capacitive Load

7.3 Power Supply Recommendations

The THS3001 family operates off a single supply or with dual supplies. Choose supplies that provide for the required headroom to supply rails as specified by the common-mode range (CMR). Operating from a single supply has numerous advantages. With the negative supply at ground, the dc errors due to the $-PSRR$ term are minimized. Decouple supplies with low inductance capacitors to ground as close to the amplifier as possible. When operating on a board with high-speed digital signals, provide isolation between digital signal noise and the analog input pins. When using a ground plane, remove the ground plane close to input sensitive pins to reduce stray parasitics that adversely impact device performance. For split-supply operation, an optional supply decoupling capacitor across the two power supplies improves second harmonic distortion performance.

7.4 Layout

7.4.1 Layout Guidelines

7.4.1.1 PCB Design Considerations

Proper PCB design techniques in two areas are important for best performance with the THS3001. These areas are high-speed layout techniques and thermal-management techniques. Because the THS3001 is a high-speed part, the following guidelines are recommended.

- Ground plane: The ground plane needs be used on the board to provide all components with a low inductive ground connection, but needs to be removed from below the output and negative input pins as noted below.
- The DGN package option includes a thermal pad for increased thermal performance. When using this package, the PCB designer needs to distribute the negative supply as a power plane, and tie the thermal pad to this supply with multiple vias for proper power dissipation. Do not tie the thermal pad to ground when using split supply ($\pm V$) as this can cause worse distortion performance than shown in this data sheet.
- Input stray capacitance: To minimize potential problems with amplifier oscillation, the capacitance at the inverting input of the amplifiers must be kept to a minimum. To do this, PCB trace runs to the inverting input must be as short as possible, the ground plane must be removed under any etch runs connected to the inverting input, and external components need to be placed as close as possible to the inverting input. This is especially true in the noninverting configuration. An example of this can be seen in [Figure 7-11](#), which shows what happens when a 1pF capacitor is added to the inverting input terminal. The bandwidth increases at the expense of peaking. This is because some of the error current is flowing through the stray capacitor instead of the inverting node of the amplifier. Although, while the device is in the inverting mode, stray capacitance at the inverting input has a minimal effect. This is because the inverting node is at a *virtual ground* and the voltage does not fluctuate nearly as much as in the noninverting configuration. This can be seen in [Figure 7-12](#), where a 10pF capacitor adds only 0.35dB of peaking. In general, as the gain of the system increases, the output peaking due to this capacitor decreases. While this can initially look like a faster and better system, overshoot and ringing are more likely to occur under fast transient conditions. So proper analysis of adding a capacitor to the inverting input node needs to be performed for stable operation.

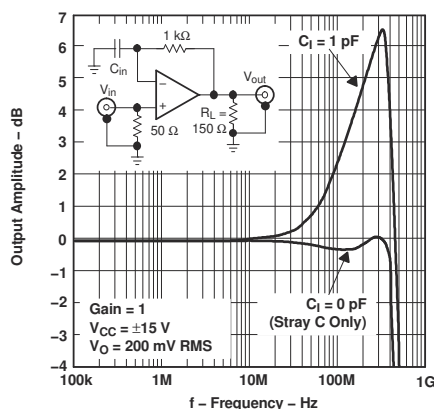

Figure 7-11. Output Amplitude vs Frequency

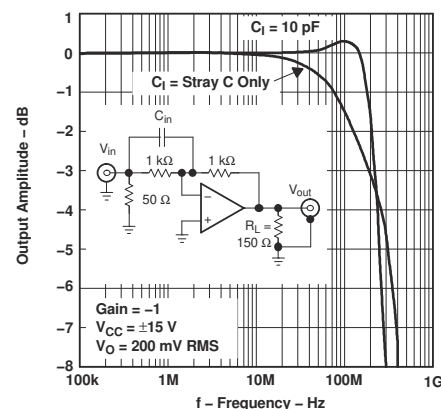

Figure 7-12. Output Amplitude vs Frequency

- Proper power-supply decoupling: Use a minimum 6.8µF tantalum capacitor in parallel with a 0.1µF ceramic capacitor on each supply terminal. The tantalum capacitor can be shared among several amplifiers depending on the application, but use a 0.1µF ceramic capacitor on the supply terminal of every amplifier. In addition, place the 0.1µF capacitor as close as possible to the supply terminal. As this distance increases, the inductance in the connecting etch makes the capacitor less effective. In addition, distances of less than 0.1 inch between the device power terminal and the ceramic capacitors are recommended.

7.4.1.2 Thermal Considerations

The THS3001 incorporates output-current-limiting protection. If the output is ever shorted to ground, the output current is automatically limited to the value given in the data sheet. While the output-current-limiting protects the output against excessive current, the device internal power dissipation increases due to the high current and large voltage drop across the output transistors.

CAUTION

Continuous output shorts are not recommended and can damage the device. Additionally, connection of the amplifier output to one of the supply rails (V_{CC} or V_{EE}) is not recommended and can result in device failure. In addition, the THS3001 does not incorporate thermal-shutdown protection. Because of this limitation, pay special attention to the device power dissipation, or failure can result.

The thermal coefficient θ_{JA} is approximately 169°C/W for the SOIC 8-pin D package. For a given θ_{JA} , the maximum power dissipation shown in Figure 7-13 is calculated by the following formula:

$$P_D = \left(\frac{T_{MAX} - T_A}{\theta_{JA}} \right)$$

Where:

- P_D = Maximum power dissipation of THS3001 (watts)
- T_{MAX} = Absolute maximum junction temperature (150°C)
- T_A = Free-ambient air temperature (°C)
- θ_{JA} = Thermal coefficient from die junction to ambient air (°C/W)

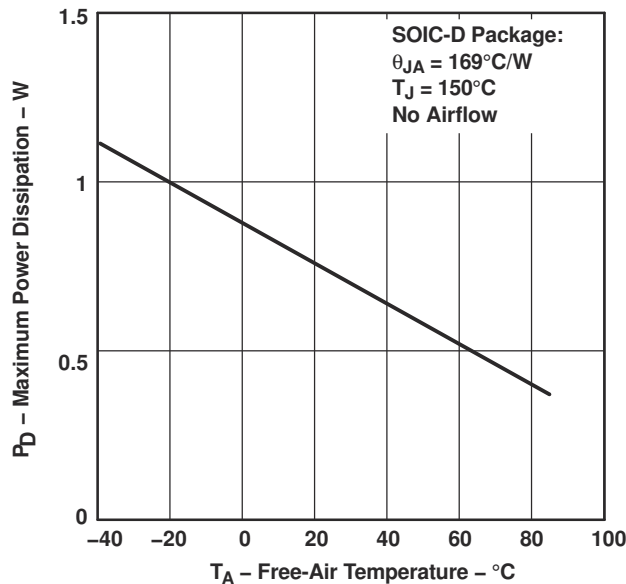

Figure 7-13. Maximum Power Dissipation vs Free-Air Temperature

8 Device and Documentation Support

TI offers an extensive line of development tools. Tools and software to evaluate the performance of the device, generate code, and develop solutions are listed below.

8.1 Device Support

8.1.1 Evaluation Board

An evaluation board is available for the THS3001 ([THS3001EVM](#)). The board has been configured for low parasitic capacitance to optimize for the full performance of the amplifier. A schematic of the evaluation board is shown in [Figure 8-1](#). The circuitry has been designed so that the amplifier can be used in either an inverting or noninverting configuration. For more detailed information, see the [THS3001 EVM User's Guide](#). Order the evaluation board online through the [TI web site](#), or through your local TI sales office or distributor.

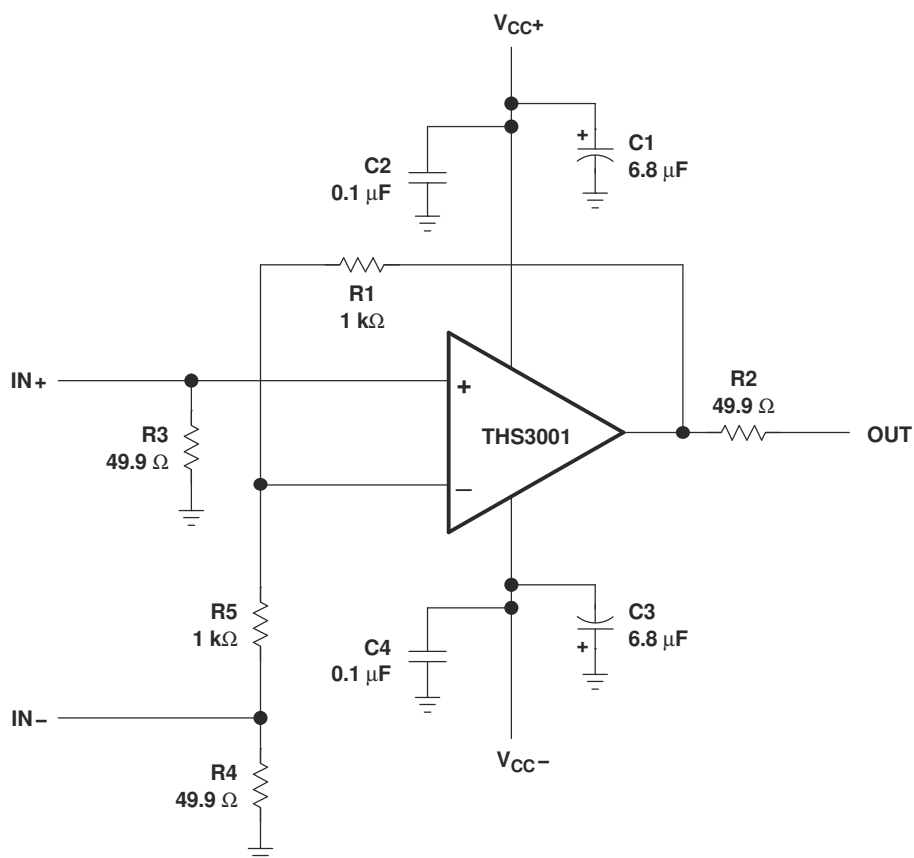

Figure 8-1. THS3001 Evaluation Board Schematic

8.2 Receiving Notification of Documentation Updates

To receive notification of documentation updates, navigate to the device product folder on [ti.com](#). Click on *Notifications* to register and receive a weekly digest of any product information that has changed. For change details, review the revision history included in any revised document.

8.3 Support Resources

[TI E2E™ support forums](#) are an engineer's go-to source for fast, verified answers and design help — straight from the experts. Search existing answers or ask your own question to get the quick design help you need.

Linked content is provided "AS IS" by the respective contributors. They do not constitute TI specifications and do not necessarily reflect TI's views; see TI's [Terms of Use](#).

8.4 Trademarks

TI E2E™ is a trademark of Texas Instruments.
All trademarks are the property of their respective owners.

8.5 Electrostatic Discharge Caution



This integrated circuit can be damaged by ESD. Texas Instruments recommends that all integrated circuits be handled with appropriate precautions. Failure to observe proper handling and installation procedures can cause damage.

ESD damage can range from subtle performance degradation to complete device failure. Precision integrated circuits may be more susceptible to damage because very small parametric changes could cause the device not to meet its published specifications.

8.6 Glossary

[TI Glossary](#) This glossary lists and explains terms, acronyms, and definitions.

9 Revision History

NOTE: Page numbers for previous revisions may differ from page numbers in the current version.

Changes from Revision H (September 2009) to Revision I (December 2024)	Page
• Updated the numbering format for tables, figures, and cross-references throughout the document.....	1
• Added the <i>Pin Configuration and Functions, Specifications, ESD Ratings, Recommended Operating Conditions, Thermal Information, Detailed Description, Overview, Functional Block Diagram, Device Functional Modes, Application and Implementation, Typical Applications, Power Supply Recommendations, Layout, Layout Guidelines, Thermal Considerations, Device and Documentation Support, and Mechanical, Packaging, and Orderable Information</i> sections.....	1
• Updated table note 1 on <i>Absolute Maximum Ratings</i> to add additional clarification.....	4
• Deleted THS3001HV from <i>Absolute Maximum Ratings</i>	4
• Deleted THS3001HV from <i>Recommended Operating Conditions</i>	4
• Updated <i>Recommended Operating Conditions</i> with nominal values.....	4
• Changed Vss to Vcc in <i>Recommended Operating Conditions</i> to maintain consistency with <i>Absolute Maximum Ratings</i>	4
• Moved <i>Operating Characteristics</i> to be included in <i>Electrical Characteristics</i>	5
• Changed bandwidth for 0.1dB flatness in <i>Electrical Characteristics</i> from 85MHz (5V) and 115MHz (15V) to 65MHz (5V) and 55MHz (15V).....	5
• Deleted differential gain and phase from <i>Electrical Characteristics</i>	5
• Deleted power supply operating range from <i>Electrical Characteristics</i>	5
• Deleted <i>Slew Rate vs Supply Voltage</i> from <i>Typical Characteristics</i>	7
• Deleted <i>Differential Gain and Phase Loading</i> from <i>Typical Characteristics</i>	7

Changes from Revision G (March 2008) to Revision H (September 2009)	Page
• Updated document format to current standards.....	1
• Updated information about THS3001EVM availability.....	24

10 Mechanical, Packaging, and Orderable Information

The following pages include mechanical, packaging, and orderable information. This information is the most current data available for the designated devices. This data is subject to change without notice and revision of this document. For browser-based versions of this data sheet, refer to the left-hand navigation.

PACKAGING INFORMATION

Orderable Device	Status (1)	Package Type	Package Drawing	Pins	Package Qty	Eco Plan (2)	Lead finish/ Ball material (6)	MSL Peak Temp (3)	Op Temp (°C)	Device Marking (4/5)	Samples
THS3001CD	OBSOLETE	SOIC	D	8		TBD	Call TI	Call TI	0 to 70	3001C	
THS3001CDGN	OBSOLETE	HVSSOP	DGN	8		TBD	Call TI	Call TI	0 to 70	ADP	
THS3001CDGNR	OBSOLETE	HVSSOP	DGN	8		TBD	Call TI	Call TI	0 to 70	ADP	
THS3001CDR	OBSOLETE	SOIC	D	8		TBD	Call TI	Call TI	0 to 70	3001C	
THS3001HVCDGN	OBSOLETE	HVSSOP	DGN	8		TBD	Call TI	Call TI	0 to 70	BNK	
THS3001HVIDGN	OBSOLETE	HVSSOP	DGN	8		TBD	Call TI	Call TI	-40 to 85	BNJ	
THS3001ID	OBSOLETE	SOIC	D	8		TBD	Call TI	Call TI		3001I	
THS3001IDGN	OBSOLETE	HVSSOP	DGN	8		TBD	Call TI	Call TI		ADQ	
THS3001IDGNR	ACTIVE	HVSSOP	DGN	8	2500	RoHS & Green	NIPDAU NIPDAUAG	Level-1-260C-UNLIM		ADQ	Samples
THS3001IDR	ACTIVE	SOIC	D	8	2500	RoHS & Green	NIPDAU	Level-1-260C-UNLIM		3001I	Samples

(1) The marketing status values are defined as follows:

ACTIVE: Product device recommended for new designs.

LIFEBUY: TI has announced that the device will be discontinued, and a lifetime-buy period is in effect.

NRND: Not recommended for new designs. Device is in production to support existing customers, but TI does not recommend using this part in a new design.

PREVIEW: Device has been announced but is not in production. Samples may or may not be available.

OBSOLETE: TI has discontinued the production of the device.

(2) **RoHS:** TI defines "RoHS" to mean semiconductor products that are compliant with the current EU RoHS requirements for all 10 RoHS substances, including the requirement that RoHS substance do not exceed 0.1% by weight in homogeneous materials. Where designed to be soldered at high temperatures, "RoHS" products are suitable for use in specified lead-free processes. TI may reference these types of products as "Pb-Free".

RoHS Exempt: TI defines "RoHS Exempt" to mean products that contain lead but are compliant with EU RoHS pursuant to a specific EU RoHS exemption.

Green: TI defines "Green" to mean the content of Chlorine (Cl) and Bromine (Br) based flame retardants meet JS709B low halogen requirements of <=1000ppm threshold. Antimony trioxide based flame retardants must also meet the <=1000ppm threshold requirement.

(3) MSL, Peak Temp. - The Moisture Sensitivity Level rating according to the JEDEC industry standard classifications, and peak solder temperature.

(4) There may be additional marking, which relates to the logo, the lot trace code information, or the environmental category on the device.

(5) Multiple Device Markings will be inside parentheses. Only one Device Marking contained in parentheses and separated by a "-" will appear on a device. If a line is indented then it is a continuation of the previous line and the two combined represent the entire Device Marking for that device.

⁽⁶⁾ Lead finish/Ball material - Orderable Devices may have multiple material finish options. Finish options are separated by a vertical ruled line. Lead finish/Ball material values may wrap to two lines if the finish value exceeds the maximum column width.

Important Information and Disclaimer:The information provided on this page represents TI's knowledge and belief as of the date that it is provided. TI bases its knowledge and belief on information provided by third parties, and makes no representation or warranty as to the accuracy of such information. Efforts are underway to better integrate information from third parties. TI has taken and continues to take reasonable steps to provide representative and accurate information but may not have conducted destructive testing or chemical analysis on incoming materials and chemicals. TI and TI suppliers consider certain information to be proprietary, and thus CAS numbers and other limited information may not be available for release.

In no event shall TI's liability arising out of such information exceed the total purchase price of the TI part(s) at issue in this document sold by TI to Customer on an annual basis.

TAPE AND REEL INFORMATION

QUADRANT ASSIGNMENTS FOR PIN 1 ORIENTATION IN TAPE

*All dimensions are nominal

Device	Package Type	Package Drawing	Pins	SPQ	Reel Diameter (mm)	Reel Width W1 (mm)	A0 (mm)	B0 (mm)	K0 (mm)	P1 (mm)	W (mm)	Pin1 Quadrant
THS3001IDGNR	HVSSOP	DGN	8	2500	330.0	12.4	5.3	3.4	1.4	8.0	12.0	Q1
THS3001IDGNR	HVSSOP	DGN	8	2500	330.0	12.4	5.3	3.4	1.4	8.0	12.0	Q1
THS3001IDR	SOIC	D	8	2500	330.0	12.4	6.4	5.2	2.1	8.0	12.0	Q1

TAPE AND REEL BOX DIMENSIONS



*All dimensions are nominal

Device	Package Type	Package Drawing	Pins	SPQ	Length (mm)	Width (mm)	Height (mm)
THS3001IDGNR	HVSSOP	DGN	8	2500	364.0	364.0	27.0
THS3001IDGNR	HVSSOP	DGN	8	2500	358.0	335.0	35.0
THS3001IDR	SOIC	D	8	2500	350.0	350.0	43.0

GENERIC PACKAGE VIEW

DGN 8

PowerPAD™ HVSSOP - 1.1 mm max height

3 x 3, 0.65 mm pitch

SMALL OUTLINE PACKAGE

This image is a representation of the package family, actual package may vary.
Refer to the product data sheet for package details.

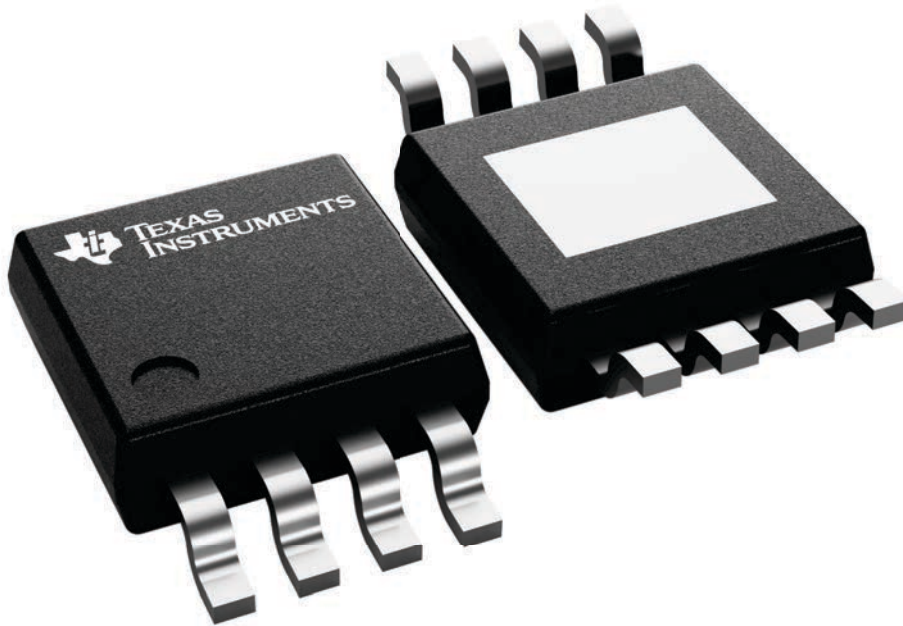

4225482/B



4225481/A 11/2019

PowerPAD is a trademark of Texas Instruments.

NOTES:

1. All linear dimensions are in millimeters. Any dimensions in parenthesis are for reference only. Dimensioning and tolerancing per ASME Y14.5M.
2. This drawing is subject to change without notice.
3. This dimension does not include mold flash, protrusions, or gate burrs. Mold flash, protrusions, or gate burrs shall not exceed 0.15 mm per side.
4. This dimension does not include interlead flash. Interlead flash shall not exceed 0.25 mm per side.
5. Reference JEDEC registration MO-187.

EXAMPLE BOARD LAYOUT

DGN0008D

PowerPAD™ VSSOP - 1.1 mm max height

SMALL OUTLINE PACKAGE



LAND PATTERN EXAMPLE
EXPOSED METAL SHOWN
SCALE: 15X



SOLDER MASK DETAILS

4225481/A 11/2019

NOTES: (continued)

6. Publication IPC-7351 may have alternate designs.
7. Solder mask tolerances between and around signal pads can vary based on board fabrication site.
8. Vias are optional depending on application, refer to device data sheet. If any vias are implemented, refer to their locations shown on this view. It is recommended that vias under paste be filled, plugged or tented.
9. Size of metal pad may vary due to creepage requirement.

EXAMPLE STENCIL DESIGN

DGN0008D

PowerPAD™ VSSOP - 1.1 mm max height

SMALL OUTLINE PACKAGE

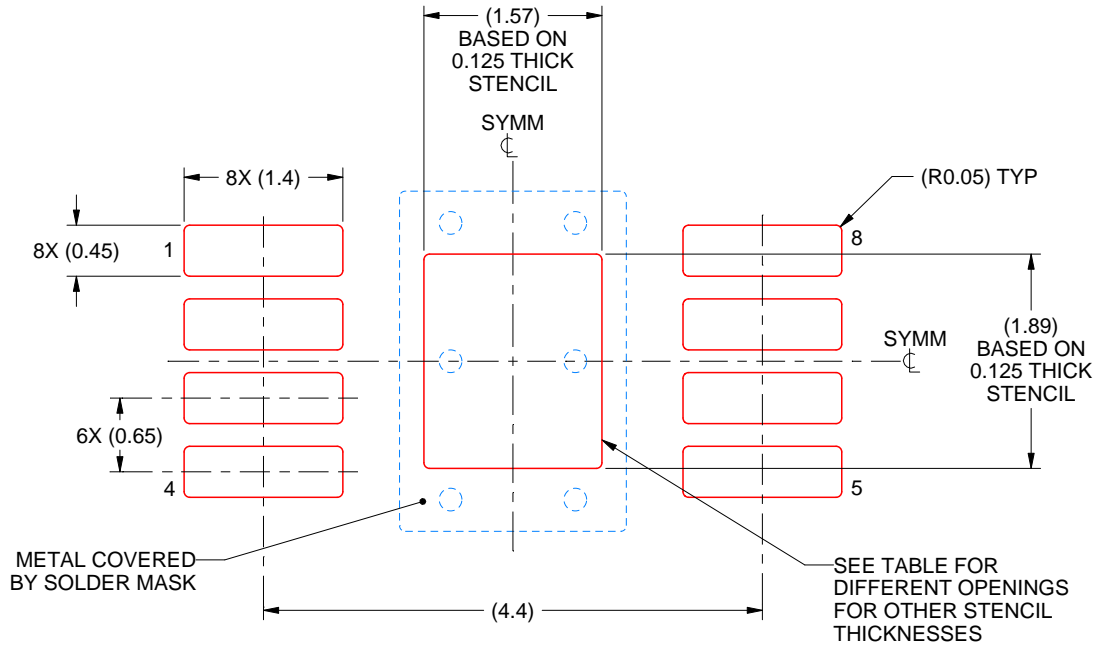

SOLDER PASTE EXAMPLE
EXPOSED PAD 9:
100% PRINTED SOLDER COVERAGE BY AREA
SCALE: 15X

STENCIL THICKNESS	SOLDER STENCIL OPENING
0.1	1.76 X 2.11
0.125	1.57 X 1.89 (SHOWN)
0.15	1.43 X 1.73
0.175	1.33 X 1.60

4225481/A 11/2019

NOTES: (continued)

10. Laser cutting apertures with trapezoidal walls and rounded corners may offer better paste release. IPC-7525 may have alternate design recommendations.
11. Board assembly site may have different recommendations for stencil design.

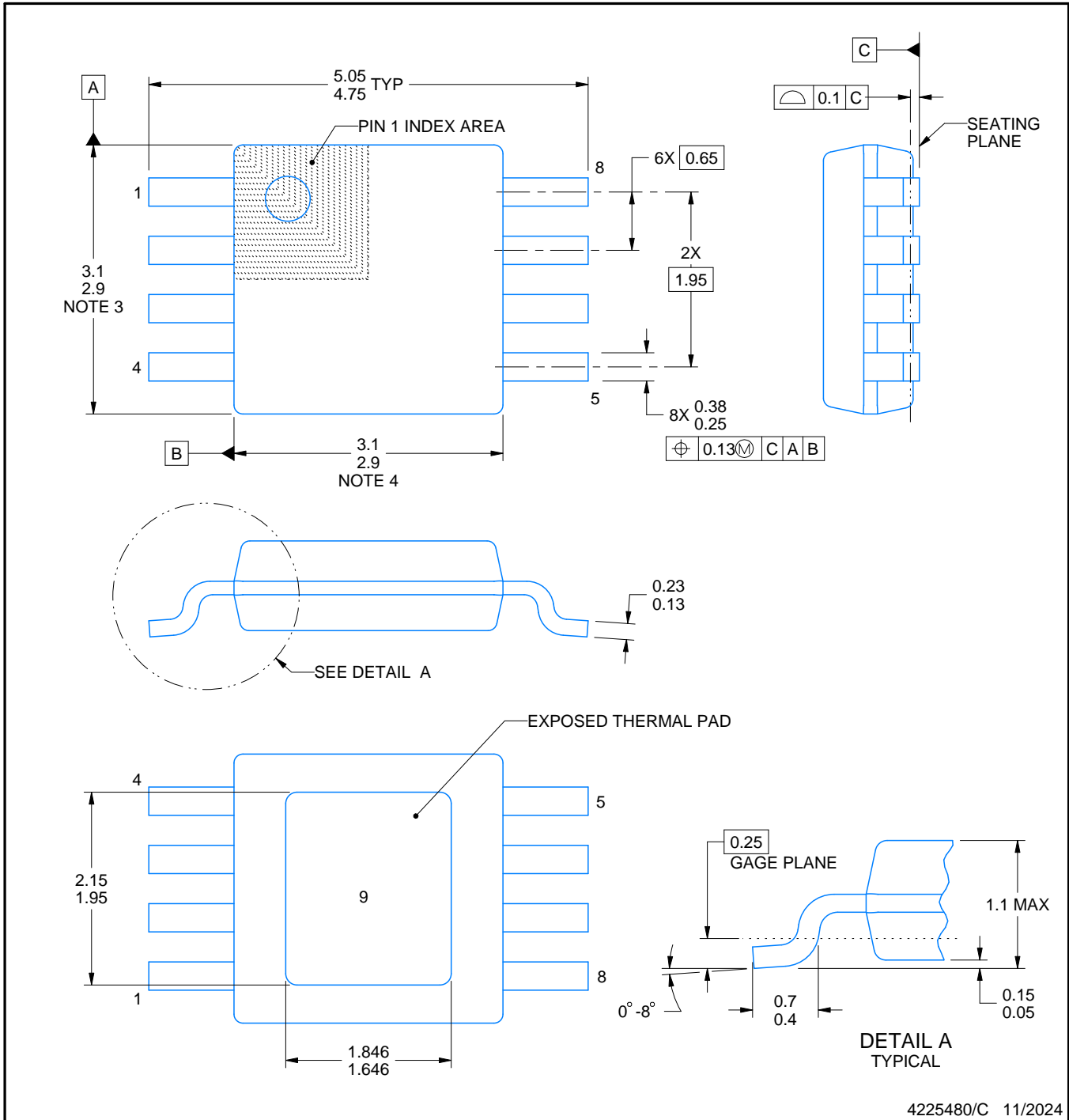

4225480/C 11/2024

NOTES:

PowerPAD is a trademark of Texas Instruments.

1. All linear dimensions are in millimeters. Any dimensions in parenthesis are for reference only. Dimensioning and tolerancing per ASME Y14.5M.
2. This drawing is subject to change without notice.
3. This dimension does not include mold flash, protrusions, or gate burrs. Mold flash, protrusions, or gate burrs shall not exceed 0.15 mm per side.
4. This dimension does not include interlead flash. Interlead flash shall not exceed 0.25 mm per side.
5. Reference JEDEC registration MO-187.

EXAMPLE BOARD LAYOUT

DGN0008G

PowerPAD™ HVSSOP - 1.1 mm max height

SMALL OUTLINE PACKAGE

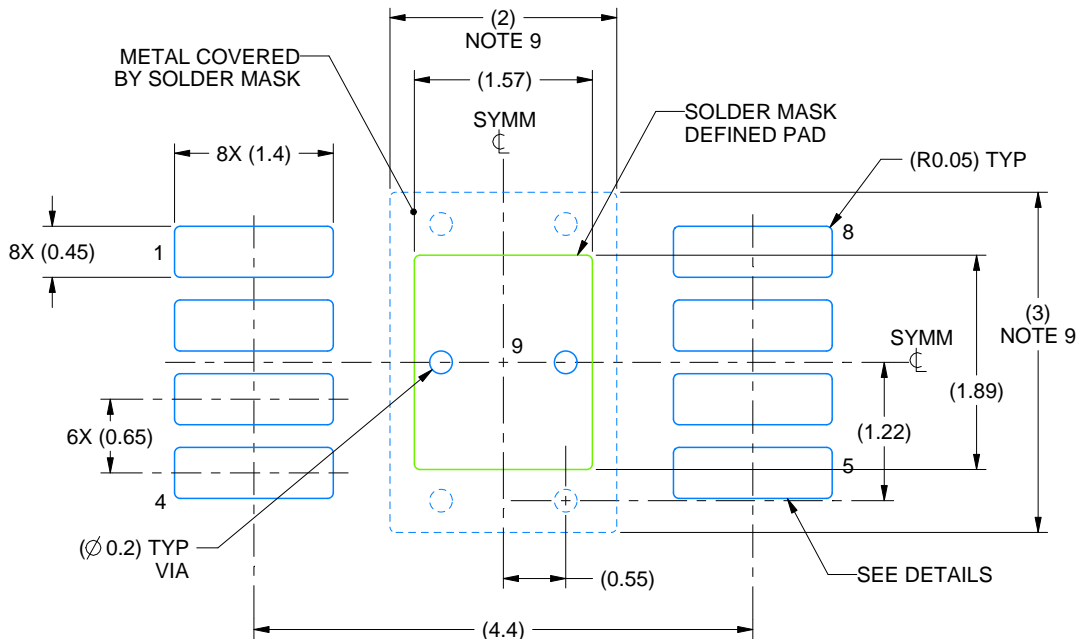

LAND PATTERN EXAMPLE
EXPOSED METAL SHOWN
SCALE: 15X

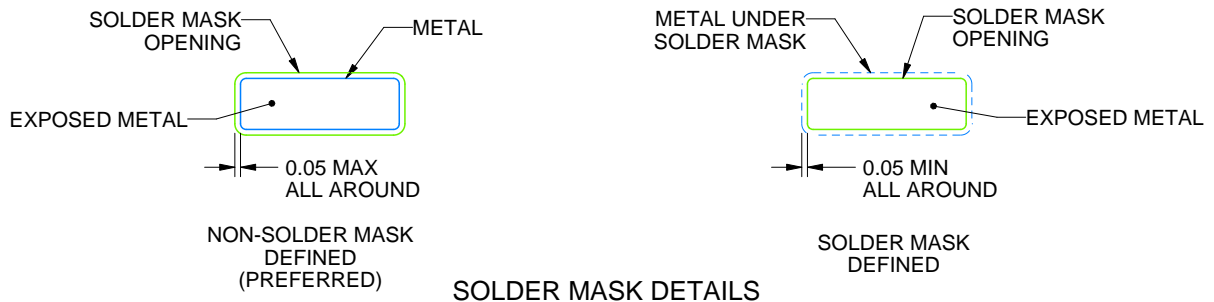

SOLDER MASK DETAILS

4225480/C 11/2024

NOTES: (continued)

6. Publication IPC-7351 may have alternate designs.
7. Solder mask tolerances between and around signal pads can vary based on board fabrication site.
8. Vias are optional depending on application, refer to device data sheet. If any vias are implemented, refer to their locations shown on this view. It is recommended that vias under paste be filled, plugged or tented.
9. Size of metal pad may vary due to creepage requirement.

EXAMPLE STENCIL DESIGN

DGN0008G

PowerPAD™ HVSSOP - 1.1 mm max height

SMALL OUTLINE PACKAGE

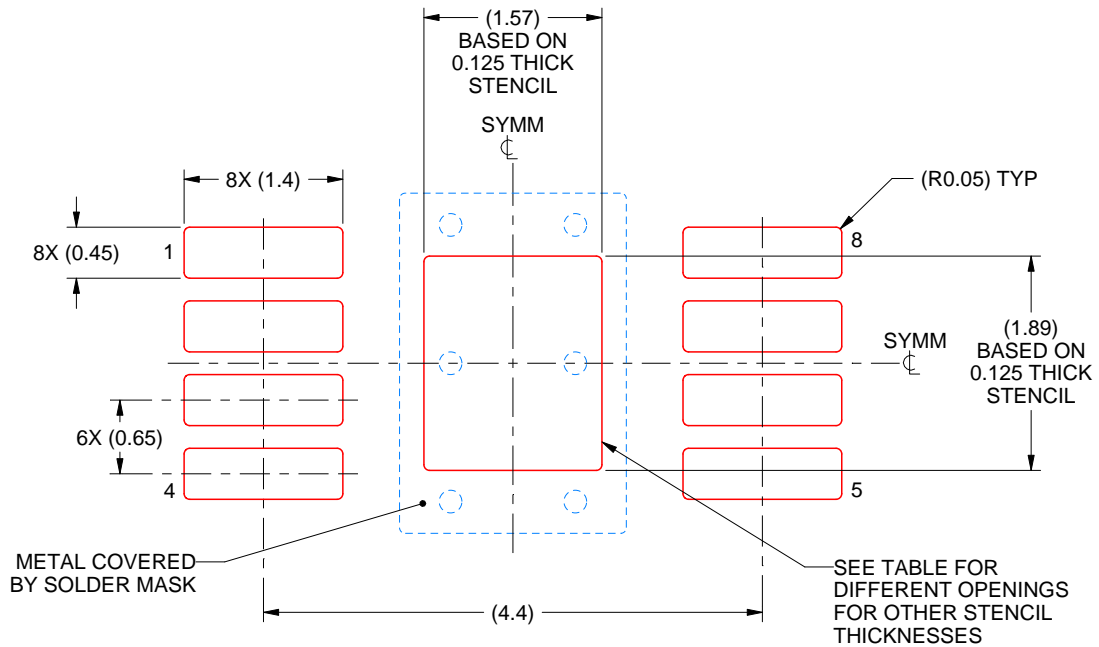

SOLDER PASTE EXAMPLE
EXPOSED PAD 9:
100% PRINTED SOLDER COVERAGE BY AREA
SCALE: 15X

STENCIL THICKNESS	SOLDER STENCIL OPENING
0.1	1.76 X 2.11
0.125	1.57 X 1.89 (SHOWN)
0.15	1.43 X 1.73
0.175	1.33 X 1.60

4225480/C 11/2024

NOTES: (continued)

10. Laser cutting apertures with trapezoidal walls and rounded corners may offer better paste release. IPC-7525 may have alternate design recommendations.
11. Board assembly site may have different recommendations for stencil design.



D0008A

PACKAGE OUTLINE

SOIC - 1.75 mm max height

SMALL OUTLINE INTEGRATED CIRCUIT



4214825/C 02/2019

NOTES:

1. Linear dimensions are in inches [millimeters]. Dimensions in parenthesis are for reference only. Controlling dimensions are in inches. Dimensioning and tolerancing per ASME Y14.5M.
2. This drawing is subject to change without notice.
3. This dimension does not include mold flash, protrusions, or gate burrs. Mold flash, protrusions, or gate burrs shall not exceed $.006$ [0.15] per side.
4. This dimension does not include interlead flash.
5. Reference JEDEC registration MS-012, variation AA.

EXAMPLE BOARD LAYOUT

D0008A

SOIC - 1.75 mm max height

SMALL OUTLINE INTEGRATED CIRCUIT



LAND PATTERN EXAMPLE
EXPOSED METAL SHOWN
SCALE:8X



SOLDER MASK DETAILS

4214825/C 02/2019

NOTES: (continued)

- 6. Publication IPC-7351 may have alternate designs.
- 7. Solder mask tolerances between and around signal pads can vary based on board fabrication site.

EXAMPLE STENCIL DESIGN

D0008A

SOIC - 1.75 mm max height

SMALL OUTLINE INTEGRATED CIRCUIT



SOLDER PASTE EXAMPLE
BASED ON .005 INCH [0.125 MM] THICK STENCIL
SCALE:8X

4214825/C 02/2019

NOTES: (continued)

8. Laser cutting apertures with trapezoidal walls and rounded corners may offer better paste release. IPC-7525 may have alternate design recommendations.
9. Board assembly site may have different recommendations for stencil design.

IMPORTANT NOTICE AND DISCLAIMER

TI PROVIDES TECHNICAL AND RELIABILITY DATA (INCLUDING DATA SHEETS), DESIGN RESOURCES (INCLUDING REFERENCE DESIGNS), APPLICATION OR OTHER DESIGN ADVICE, WEB TOOLS, SAFETY INFORMATION, AND OTHER RESOURCES "AS IS" AND WITH ALL FAULTS, AND DISCLAIMS ALL WARRANTIES, EXPRESS AND IMPLIED, INCLUDING WITHOUT LIMITATION ANY IMPLIED WARRANTIES OF MERCHANTABILITY, FITNESS FOR A PARTICULAR PURPOSE OR NON-INFRINGEMENT OF THIRD PARTY INTELLECTUAL PROPERTY RIGHTS.

These resources are intended for skilled developers designing with TI products. You are solely responsible for (1) selecting the appropriate TI products for your application, (2) designing, validating and testing your application, and (3) ensuring your application meets applicable standards, and any other safety, security, regulatory or other requirements.

These resources are subject to change without notice. TI grants you permission to use these resources only for development of an application that uses the TI products described in the resource. Other reproduction and display of these resources is prohibited. No license is granted to any other TI intellectual property right or to any third party intellectual property right. TI disclaims responsibility for, and you will fully indemnify TI and its representatives against, any claims, damages, costs, losses, and liabilities arising out of your use of these resources.

TI's products are provided subject to [TI's Terms of Sale](#) or other applicable terms available either on [ti.com](https://www.ti.com) or provided in conjunction with such TI products. TI's provision of these resources does not expand or otherwise alter TI's applicable warranties or warranty disclaimers for TI products.

TI objects to and rejects any additional or different terms you may have proposed.

Mailing Address: Texas Instruments, Post Office Box 655303, Dallas, Texas 75265

Copyright © 2025, Texas Instruments Incorporated