

UCC28722 Constant-Voltage, Constant-Current Controller With Primary-Side Regulation, BJT Drive

1 Features

- < 50-mW No-Load Power
- Primary-Side Regulation (PSR) Eliminates Opto-Coupler
- Dynamic BJT Drive
- $\pm 5\%$ Voltage and Current Regulation Across Line and Load
- 80-kHz Maximum Switching Frequency Enables High-Power Density Charger Designs
- Quasi-Resonant Valley-Switching Operation for Highest Overall Efficiency
- Wide VDD Range Allows Small Bias Capacitor
- Output Overvoltage, Low-Line, and Overcurrent Protection Functions
- Programmable Cable Compensation
- SOT23-6 Package

2 Applications

- USB-Compliant Adapters and Chargers for Consumer Electronics
 - Smart Phones
 - Tablet Computers
 - Cameras
- Standby Supply for TVs and Desktops
- White Goods

3 Description

The UCC28722 flyback power supply controller provides isolated-output constant-voltage (CV) and constant-current (CC) output regulation without the use of an optical coupler. The device processes information from the primary power switch and an auxiliary flyback winding for precise control of output voltage and current.

Dynamically-controlled operating states and a tailored modulation profile support high-efficiency operation at all load levels without sacrificing output transient response.

Control algorithms in the UCC28722 device allow operating efficiencies to meet or exceed applicable standards. The output drive interfaces to a bipolar transistor power switch, enabling lower-cost converter design. Discontinuous conduction mode (DCM) with valley switching reduces switching losses, while modulation of switching frequency and primary current peak amplitude (FM and AM) keeps the conversion efficiency high across the entire load and line ranges.

The controller has a maximum switching frequency of 80 kHz and always maintains control of the peak-primary current in the transformer. Output overvoltage and overcurrent as well as input undervoltage protection features help keep primary and secondary component stresses in check. The UCC28722 also allows compensation for voltage drop in the cable to be programmed with an external resistor.

Device Information⁽¹⁾

PART NUMBER	PACKAGE	BODY SIZE (NOM)
UCC28722	DBV (6)	2.90 mm x 1.60 mm

(1) For all available packages, see the orderable addendum at the end of the data sheet.

Simplified Application Diagram

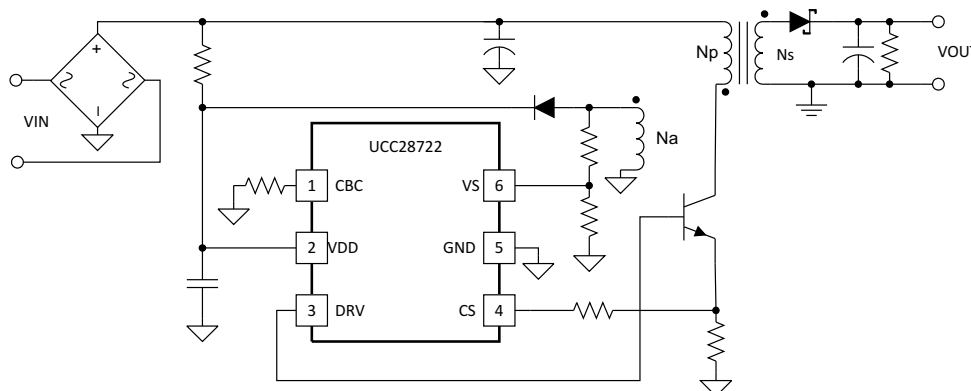

Table of Contents

1 Features	1	7.4 Device Functional Modes.....	11
2 Applications	1	8 Application and Implementation	16
3 Description	1	8.1 Application Information.....	16
4 Revision History	2	8.2 Typical Application	16
5 Pin Configuration and Functions	3	9 Power Supply Recommendations	22
6 Specifications	3	10 Layout	23
6.1 Absolute Maximum Ratings	3	10.1 Layout Guidelines	23
6.2 ESD Ratings	4	10.2 Layout Example	23
6.3 Recommended Operating Conditions.....	4	11 Device and Documentation Support	25
6.4 Thermal Information	4	11.1 Device Support	25
6.5 Electrical Characteristics.....	5	11.2 Documentation Support	26
6.6 Typical Characteristics.....	6	11.3 Community Resources.....	27
7 Detailed Description	8	11.4 Trademarks	27
7.1 Overview	8	11.5 Electrostatic Discharge Caution.....	27
7.2 Functional Block Diagram	8	11.6 Glossary	27
7.3 Feature Description.....	9	12 Mechanical, Packaging, and Orderable Information	27

4 Revision History

NOTE: Page numbers for previous revisions may differ from page numbers in the current version.

Changes from Revision A (January 2014) to Revision B	Page
<ul style="list-style-type: none"> Added ESD Rating table, Feature Description section, Device Functional Modes, Application and Implementation section, Power Supply Recommendations section, Layout section, Device and Documentation Support section, and Mechanical, Packaging, and Orderable Information section. 	1

Changes from Original (December 2013) to Revision A	Page
<ul style="list-style-type: none"> Changed Simplified Application Diagram. Changed Supply current, fault values from 95 μA and 170 μA to 2.00 mA and 2.65 mA..... Changed Bias Supply Current vs VDD Voltage image..... Changed Operating Current vs Junction Temperature image..... Changed Functional Block Diagram. Changed Simplified Flyback Convertor image. Changed C_{DD} equation. 	1 5 6 6 8 11 20

5 Pin Configuration and Functions

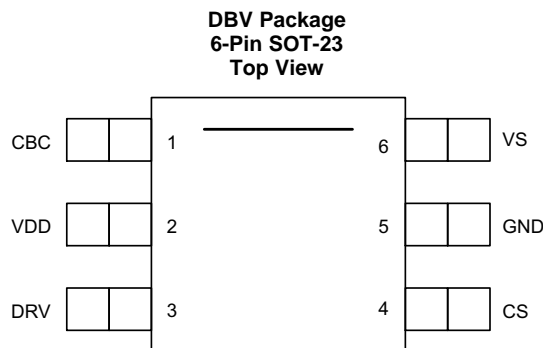

Pin Functions

PIN		I/O	DESCRIPTION
NAME	NO.		
CBC	1	I	Cable compensation is a programming pin for compensation of cable voltage drop. Cable compensation is programmed with a resistor to GND.
CS	4	I	Current sense input connects to a ground-referenced current-sense resistor in series with the power switch. The resulting voltage is used to monitor and control the peak primary current. A series resistor can be added to this pin to compensate the peak switch current levels as the AC-mains input varies.
DRV	3	O	Drive is an output used to drive the base of an external high voltage NPN transistor.
GND	5	—	The ground pin is both the reference pin for the controller and the low-side return for the drive output. Special care should be taken to return all AC decoupling capacitors as close as possible to this pin and avoid any common trace length with analog signal return paths.
VDD	2	I	VDD is the bias supply input pin to the controller. A carefully-placed bypass capacitor to GND is required on this pin.
VS	6	I	Voltage sense is an input used to provide voltage and timing feedback to the controller. This pin is connected to a voltage divider between an auxiliary winding and GND. The value of the upper resistor of this divider is used to program the AC-mains run and stop thresholds and line compensation at the CS pin.

6 Specifications

6.1 Absolute Maximum Ratings

over operating free-air temperature range (unless otherwise noted)⁽¹⁾

		MIN	MAX	UNIT
V _{VDD}	Bias supply voltage, VDD		38	V
I _{DRV}	Continuous base current sink		50	mA
I _{DRV}	Continuous base current source		Self-limiting	mA
I _{VS}	Peak current, VS		–1.2	mA
V _{DRV}	Base drive voltage at DRV	–0.5	Self-limiting	V
Voltage	VS	–0.75	7	V
	CS, CBC	–0.5	5	V
T _J	Operating junction temperature	–55	150	°C
	Lead temperature 0.6 mm from case for 10 seconds		260	°C
T _{stg}	Storage temperature	–65	150	°C

(1) Stresses beyond those listed under *Absolute Maximum Ratings* may cause permanent damage to the device. These are stress ratings only, which do not imply functional operation of the device at these or any other conditions beyond those indicated under *Recommended Operating Conditions*. Exposure to absolute-maximum-rated conditions for extended periods may affect device reliability.

6.2 ESD Ratings

		VALUE	UNIT	
V _(ESD)	Electrostatic discharge	Human-body model (HBM), per ANSI/ESDA/JEDEC JS-001 ⁽¹⁾	±2000	V
		Charged-device model (CDM), per JEDEC specification JESD22-C101 ⁽²⁾	±500	V

(1) JEDEC document JEP155 states that 500-V HBM allows safe manufacturing with a standard ESD control process.

(2) JEDEC document JEP157 states that 250-V CDM allows safe manufacturing with a standard ESD control process.

6.3 Recommended Operating Conditions

over operating free-air temperature range (unless otherwise noted)

		MIN	NOM	MAX	UNIT
VDD	Bias supply operating voltage	9		35	V
C _{VDD}	VDD bypass capacitor	1.0		10	μF
R _{CBC}	Cable-compensation resistance	10			kΩ
I _{VS}	VS pin current	-1			mA
T _J	Operating junction temperature	-40		125	°C

6.4 Thermal Information

THERMAL METRIC ⁽¹⁾		UCC28722	UNIT
		DBV (SOT-23)	
		6 PINS	
R _{θJA}	Junction-to-ambient thermal resistance	180.0	°C/W
R _{θJC(top)}	Junction-to-case (top) thermal resistance	72.2	°C/W
R _{θJB}	Junction-to-board thermal resistance	44.4	°C/W
ψ _{JT}	Junction-to-top characterization parameter	5.1	°C/W
ψ _{JB}	Junction-to-board characterization parameter	43.8	°C/W
R _{θJC(bot)}	Junction-to-case (bottom) thermal resistance	NA	°C/W

(1) For more information about traditional and new thermal metrics, see the *Semiconductor and IC Package Thermal Metrics* application report, [SPRA953](#).

6.5 Electrical Characteristics

over operating free-air temperature range, $V_{DD} = 25\text{ V}$, HV = open, $R_{CBC} = \text{open}$, $T_A = -40^\circ\text{C}$ to 125°C , $T_A = T_J$ (unless otherwise noted)

PARAMETER		TEST CONDITIONS	MIN	TYP	MAX	UNIT
BIAS SUPPLY INPUT						
I_{RUN}	Supply current, run	$I_{DRV} = 0$, run state		2.00	2.65	mA
I_{WAIT}	Supply current, wait	$I_{DRV} = 0$, wait state		95	170	μA
I_{START}	Supply current, start	$I_{DRV} = 0$, $V_{DD} = 18\text{ V}$, start state, $I_{HV} = 0$		1.0	1.5	μA
I_{FAULT}	Supply current, fault	$I_{DRV} = 0$, fault state		2.00	2.65	mA
UNDERVOLTAGE LOCKOUT						
$V_{DD(on)}$	VDD turnon threshold	V_{DD} low to high	19	21	23	V
$V_{DD(off)}$	VDD turnoff threshold	V_{DD} high to low	7.2	7.7	8.3	V
VS INPUT						
V_{VSR}	Regulating level	Measured at no-load condition, $T_J = 25^\circ\text{C}^{(1)}$	3.99	4.05	4.11	V
V_{VSN}	Negative clamp level	$I_{VS} = -300\ \mu\text{A}$, volts below ground	190	250	325	mV
I_{VSB}	Input bias current	$V_{VS} = 4\text{ V}$	-0.25	0	0.25	μA
CS INPUT						
$V_{CST(max)}$	Max CS threshold voltage	$V_{VS} = 3.7\text{ V}$	730	780	820	mV
$V_{CST(min)}$	Min CS threshold voltage	$V_{VS} = 4.35\text{ V}$	170	190	220	mV
K_{AM}	AM control ratio	$V_{CST(max)} / V_{CST(min)}$	3.6	4.0	4.4	V/V
V_{CCR}	Constant current regulating level	CC regulation constant	314	330	347	mV
K_{LC}	Line compensation current ratio	$I_{VSL} = -300\ \mu\text{A}$, $I_{VSL} / \text{current out of CS pin}$	24.0	25.0	28.6	A/A
T_{CSLEB}	Leading-edge blanking time	DRV output duration, $V_{CS} = 1\text{ V}$	230	290	355	ns
DRIVER						
$I_{DRS(max)}$	Maximum DRV source current	$V_{DRV} = 2\text{ V}$, $V_{DD} = 9\text{ V}$, $V_{VS} = 3.85\text{ V}$	31	37	42	mA
$I_{DRS(min)}$	Minimum DRV source current	$V_{DRV} = 2\text{ V}$, $V_{DD} = 9\text{ V}$, $V_{VS} = 4.30\text{ V}$	15	19	23	mA
R_{DRVLS}	DRV low-side drive resistance	$I_{DRV} = 10\text{ mA}$		1	2.4	Ω
V_{DRCL}	DRV clamp voltage	$V_{DD} = 35\text{ V}$		5.9	7	V
R_{DRVSS}	DRV pulldown in start state			20	25	k Ω
TIMING						
$f_{SW(max)}$	Maximum switching frequency	$V_{VS} = 3.7\text{ V}$	72	80	89	kHz
$f_{SW(min)}$	Minimum switching frequency	$V_{VS} = 4.35\text{ V}$	570	650	750	Hz
t_{ZTO}	Zero-crossing timeout delay		2.4	3.1	3.7	μs
PROTECTION						
V_{OVP}	Overvoltage threshold	At VS input, $T_J = 25^\circ\text{C}^{(1)}$	4.49	4.60	4.75	V
V_{OCP}	Overcurrent threshold	At CS input	1.4	1.5	1.6	V
$I_{VSL(run)}$	VS line-sense run current	Current out of VS pin increasing	188	225	277	μA
$I_{VSL(stop)}$	VS line-sense stop current	Current out of VS pin decreasing	70	80	100	μA
K_{VSL}	VS line sense ratio	$I_{VSL(run)} / I_{VSL(stop)}$	2.45	2.80	3.05	A/A
$T_{J(stop)}$	Thermal shutdown temperature	Internal junction temperature		165		$^\circ\text{C}$
CABLE COMPENSATION						
$V_{CBC(max)}$	Cable compensation maximum voltage	Voltage at CBC at full load	2.9	3.1	3.5	V
$V_{CVS(min)}$	Minimum compensation at VS	$V_{CBC} = \text{open}$, change in VS regulating level at full load	-55	-15	25	mV
$V_{CVS(max)}$	Maximum compensation at VS	$V_{CBC} = 0\text{ V}$, change in VS regulating level at full load	270	320	385	mV

(1) The regulating level and over voltage at VS decreases with temperature by $0.8\text{ mV}/^\circ\text{C}$. This compensation is included to reduce the power supply output voltage variance over temperature.

6.6 Typical Characteristics

VDD = 25 V, unless otherwise noted.

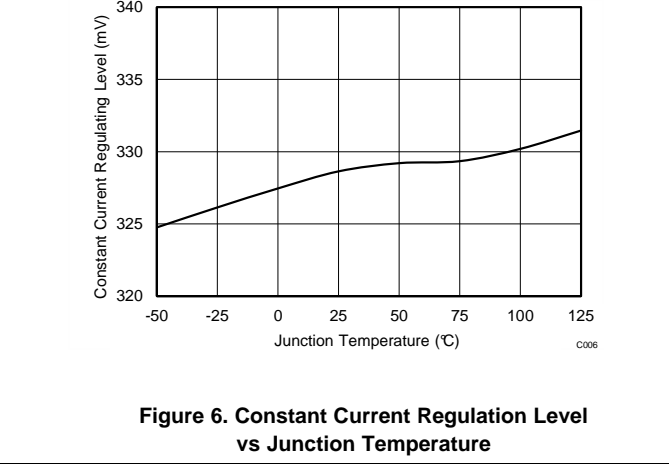
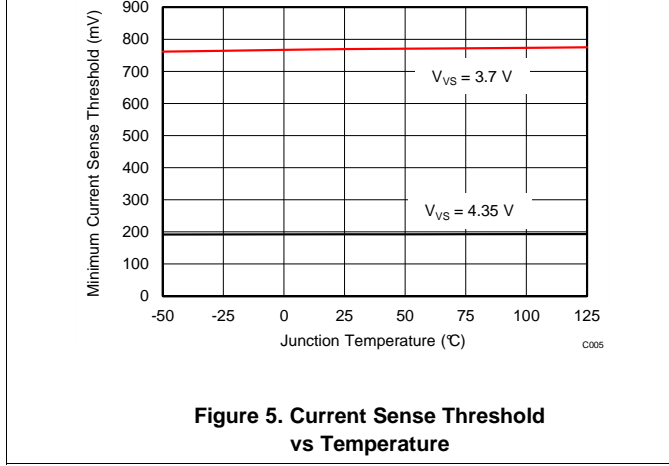
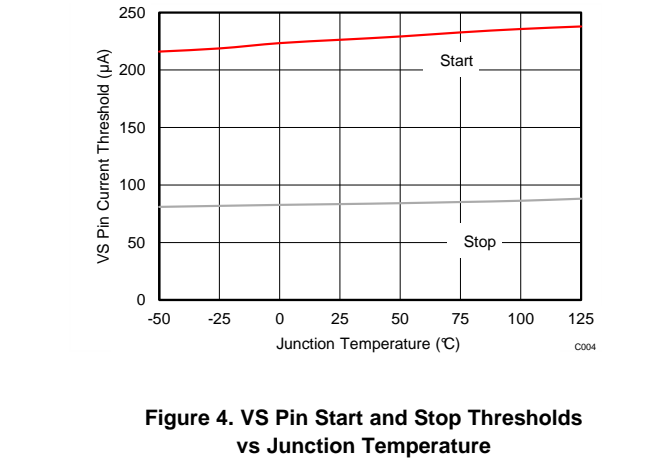
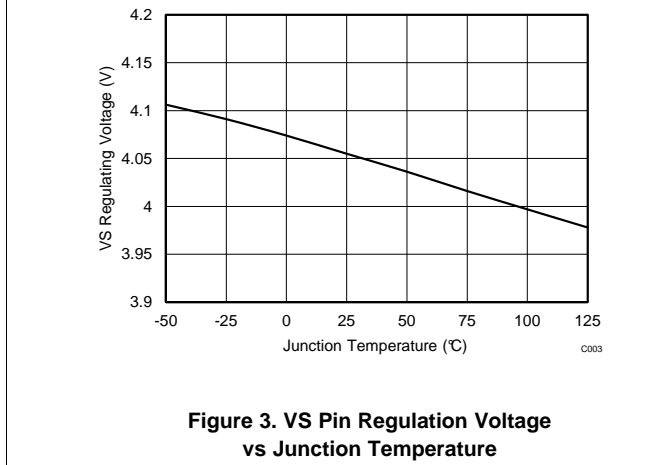
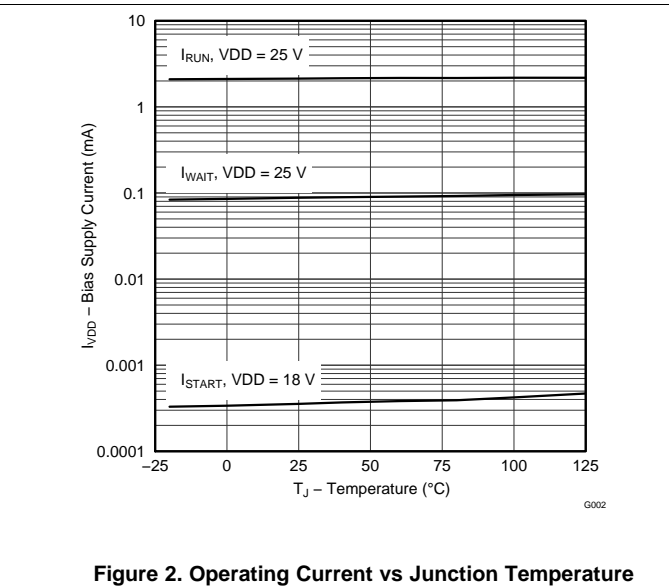
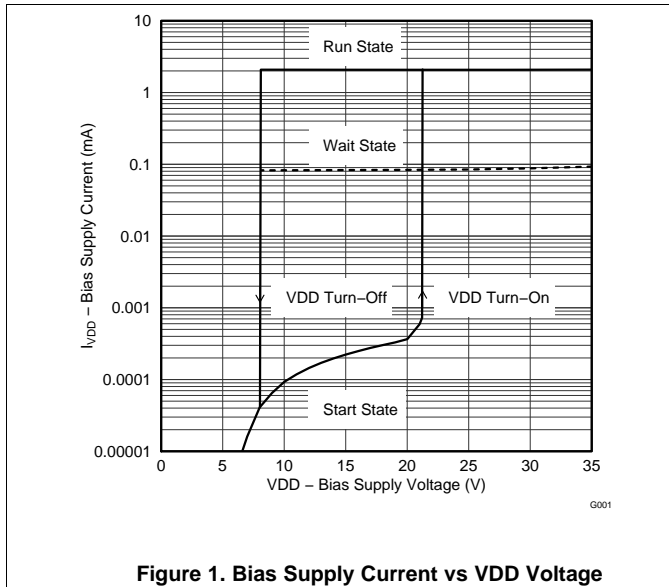

Typical Characteristics (continued)

VDD = 25 V, unless otherwise noted.

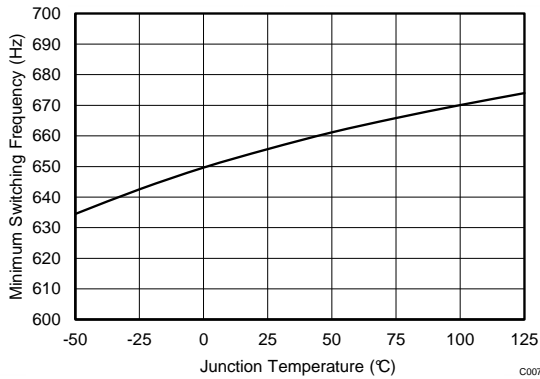

Figure 7. Minimum Switching Frequency vs Junction Temperature

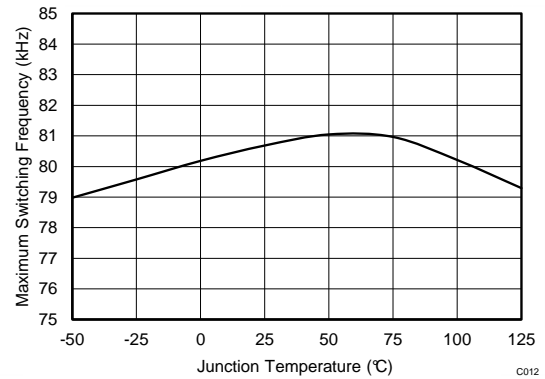

Figure 8. Maximum Switching Frequency vs Junction Temperature

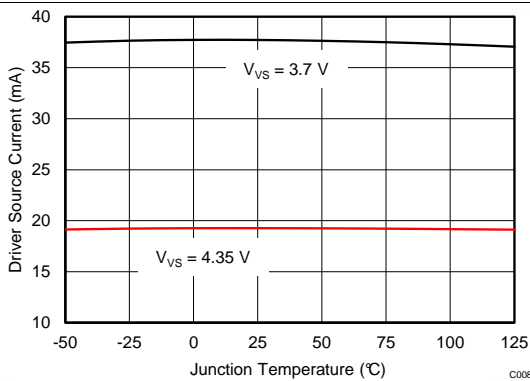

Figure 9. Driver Output Source Current vs Junction Temperature

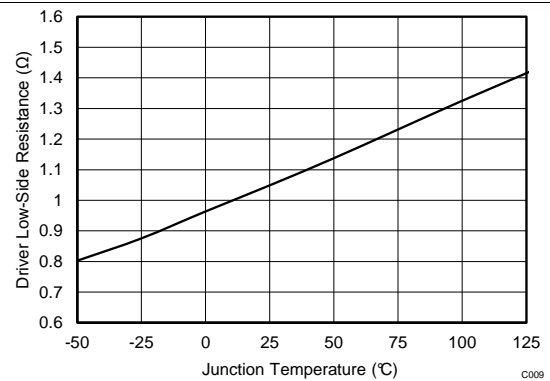

Figure 10. Driver Pull Down Resistance vs Junction Temperature

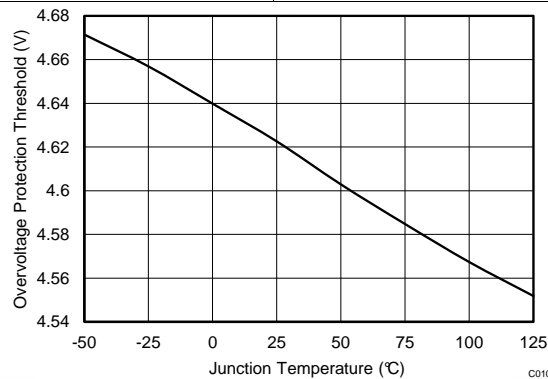

Figure 11. Over Voltage Protection Threshold vs Junction Temperature

7 Detailed Description

7.1 Overview

The UCC28722 is a flyback power supply controller that provides accurate voltage and constant current regulation with primary-side feedback, eliminating the need for opto-coupler feedback circuits. The controller operates in discontinuous conduction mode with valley-switching to minimize switching losses. The modulation scheme is a combination of frequency and primary peak current modulation to provide high conversion efficiency across the load range. The control law provides a wide-dynamic operating range of output power, which allows the power designer to achieve less than 75-mW of stand-by power.

During low-power operating ranges, the device has power-management features to reduce the device operating current at operating frequencies below 28 kHz. Accurate voltage and constant current regulation, fast dynamic response, and fault protection are achieved with primary-side control. A complete charger solution can be realized with a straightforward design process, low cost and low component count.

7.2 Functional Block Diagram

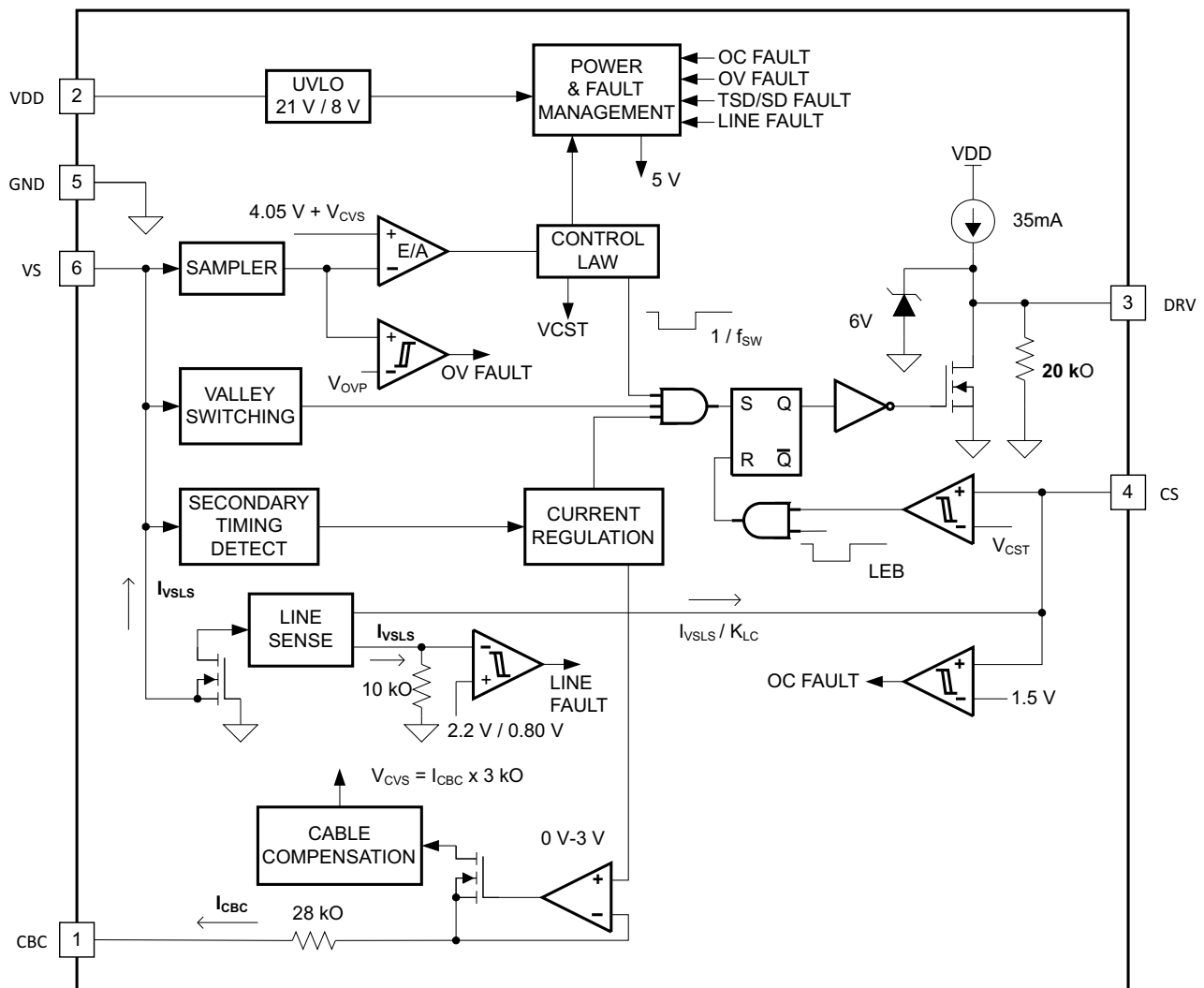

7.3 Feature Description

7.3.1 Device Bias Voltage Supply (VDD)

The VDD pin is connected to a bypass capacitor to ground. The VDD turnon UVLO threshold is 21 V and turnoff UVLO threshold is 7.7 V, with an available operating range up to 35 V on VDD. The USB charging specification requires the output current to operate in constant-current mode from 5 V to a minimum of 2 V, which is easily achieved with a nominal VDD of approximately 22 V. The additional VDD headroom (up to 35 V) allows for VDD to rise due to the leakage energy delivered to the VDD capacitor in high-load conditions.

NOTE

It is possible for the start-up resistor to supply more current to the VDD node than the IC will consume at higher bulk input voltages. A Zener diode clamp is required on the VDD pin to keep the VDD pin voltage within limits if this is the case.

7.3.2 Ground (GND)

There is one ground reference external to the device for the base drive current and analog signal reference. TI recommends placing the VDD bypass capacitor close to GND and VDD with short traces to minimize noise on the VS and CS signal pins.

7.3.3 Voltage-Sense (VS)

The VS pin is connected to a resistor divider from the auxiliary winding to ground. The output-voltage feedback information is sampled at the end of the transformer secondary current demagnetization time to provide an accurate representation of the output voltage. Timing information for achieving valley-switching and to control the duty cycle of the secondary transformer current is determined by the waveform on the VS pin. Avoid placing a filter capacitor on this input because it would interfere with accurate sensing of this waveform.

The VS pin also senses the bulk capacitor voltage to provide for AC-input run and stop thresholds, and to compensate the current-sense threshold across the AC-input range. During the transistor on-time, the VS pin is clamped to approximately 250 mV below GND and the current out of the VS pin is sensed. For the AC-input run and stop function, the run threshold on VS is 225 μ A and the stop threshold is 80 μ A. The values for the auxiliary voltage divider upper-resistor (R_{S1}) and lower-resistor (R_{S2}) can be determined by [Equation 1](#) and [Equation 2](#).

$$R_{S1} = \frac{V_{IN(run)} \times \sqrt{2}}{N_{PA} \times I_{VSL(run)}}$$

where

- N_{PA} is the transformer primary-to-auxiliary turns ratio.
- $V_{IN(run)}$ is the AC RMS voltage to enable turnon of the controller (run).
- $I_{VSL(run)}$ is the run-threshold for the current pulled out of the VS pin during the switch on-time (see [Electrical Characteristics](#)). (1)

$$R_{S2} = \frac{R_{S1} \times V_{VSR}}{N_{AS} \times (V_{OCV} + V_F) - V_{VSR}}$$

where

- V_{OCV} is the converter regulated output voltage.
- V_F is the output rectifier forward drop at near-zero current.
- N_{AS} is the transformer auxiliary to secondary turns ratio.
- R_{S1} is the VS divider high-side resistance.
- V_{VSR} is the CV regulating level at the VS input (see [Electrical Characteristics](#)). (2)

Feature Description (continued)

7.3.4 Base Drive (DRV)

The DRV pin is connected to the NPN transistor base pin. The driver provides a base drive signal limited to 7 V. The turn-on characteristic of the driver is a 19-mA to 37-mA current source that is scaled with the current sense threshold dictated by the operating point in the control scheme. When the minimum current sense threshold is being used, the base drive current is also at its minimum value. As the current sense threshold is increased to the maximum, the base drive current scales linearly to its maximum of 35-mA typical. The turn-off current is determined by the low-side driver $R_{DS(on)}$.

7.3.5 Current Sense (CS)

The current-sense pin is connected through a series resistor (R_{LC}) to the current-sense resistor (R_{CS}). The current-sense threshold is 0.78 V for $I_{PP(max)}$ and 0.19 V for $I_{PP(min)}$. The series resistor R_{LC} provides the function of feedforward line compensation to eliminate change in I_{PP} due to change in di/dt and the propagation delay of the internal comparator and NPN transistor turn-off time. There is an internal leading-edge blanking time of approximately 300 ns to eliminate sensitivity to the turnon current spike. It should not be necessary to place a bypass capacitor on the CS pin. The value of R_{CS} is determined by the target output current in constant current (CC) regulation. The values of R_{CS} and R_{LC} can be determined by [Equation 3](#) and [Equation 4](#). The term η_{XFMR} is intended to account for the energy stored in the transformer but not delivered to the secondary, which includes transformer resistance and core loss, bias power, and primary-to-secondary leakage ratio.

7.3.5.1 Example

With a transformer core and winding loss of 5%, primary-to-secondary leakage inductance of 3.5%, and bias power-to-output power ratio of 1.5%, the η_{XFMR} value is approximately: $1 - 0.05 - 0.035 - 0.015 = 0.9$.

$$R_{CS} = \frac{V_{CCR} \times N_{PS}}{2I_{OCC}} \times \sqrt{\eta_{XFMR}}$$

where

- V_{CCR} is a current regulation constant (see [Electrical Characteristics](#)).
- N_{PS} is the transformer primary-to-secondary turns ratio (a ratio of 13 to 15 is recommended for 5-V output).
- I_{OCC} is the target output current in constant-current regulation.
- η_{XFMR} is the transformer efficiency. (3)

$$R_{LC} = \frac{K_{LC} \times R_{S1} \times R_{CS} \times t_D \times N_{PA}}{L_P}$$

where

- R_{S1} is the VS pin high-side resistor value.
- R_{CS} is the current-sense resistor value.
- t_D is the current-sense delay including NPN transistor turn-off delay, add approximately 50 ns to transistor delay.
- N_{PA} is the transformer primary-to-auxiliary turns ratio.
- L_P is the transformer primary inductance.
- K_{LC} is a current-scaling constant (see [Electrical Characteristics](#)). (4)

Feature Description (continued)

7.3.6 Cable Compensation (CBC)

The cable compensation pin is connected to a resistor to ground to program the amount of output voltage compensation to offset cable resistance. The cable compensation block provides a 0-V to 3-V voltage level on the CBC pin corresponding to $I_{OCC(max)}$ output current. Connecting a resistance from CBC to GND programs a current that is summed into the VS feedback divider, increasing the regulation voltage as I_{OUT} increases. There is an internal series resistance of 28 k Ω to the CBC pin that sets a maximum cable compensation of a 5-V output to 400 mV when CBC is shorted to ground. The CBC resistance value can be determined by [Equation 5](#).

$$R_{CBC} = \frac{V_{CBC(max)} \times 3 \text{ k}\Omega \times (V_{OCV} + V_F)}{V_{VSR} \times V_{OCBC}} - 28 \text{ k}\Omega$$

where

- V_{OCV} is the regulated output voltage.
- V_F is the diode forward voltage in V.
- V_{OCBC} is the target cable compensation voltage at the output terminals.
- $V_{CBC(max)}$ is the maximum voltage at the cable compensation pin at the maximum converter output current (see [Electrical Characteristics](#)).
- V_{VSR} is the CV regulating level at the VS input (see [Electrical Characteristics](#)).

(5)

7.4 Device Functional Modes

7.4.1 Primary-Side Voltage Regulation

[Figure 12](#) illustrates a simplified flyback converter with the main voltage regulation blocks of the device shown. The power train operation is the same as any DCM flyback circuit but accurate output voltage and current sensing is the key to primary-side control.

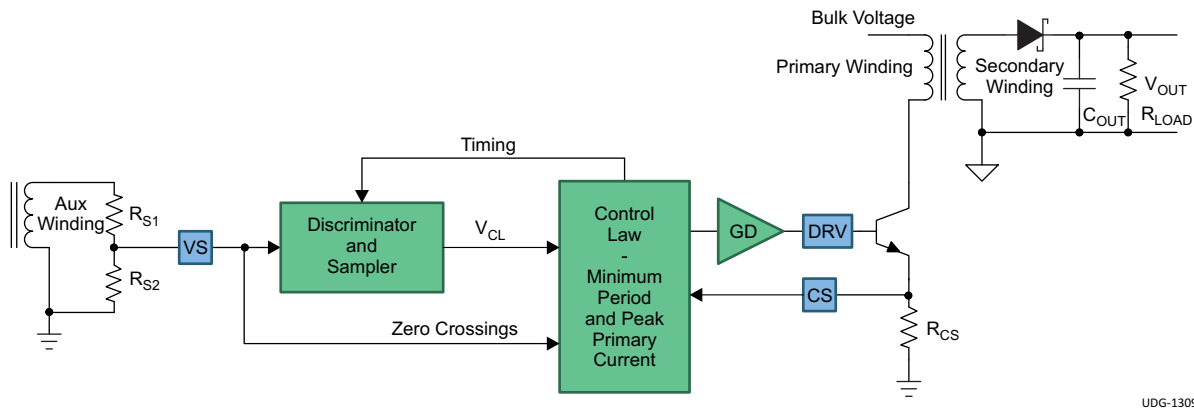

The main voltage regulation blocks are shown.

Figure 12. Simplified Flyback Converter

In primary-side control, the output voltage is sensed on the auxiliary winding during the transfer of transformer energy to the secondary. As shown in [Figure 13](#), it is clear there is a down slope representing a decreasing total rectifier (V_F) and resistance voltage drop ($I_S R_S$) as the secondary current decreases to zero. To achieve an accurate representation of the secondary output voltage on the auxiliary winding, ensure that the discriminator:

- Reliably recognizes the leakage inductance reset, ringing, and ignores
- Continuously samples the auxiliary voltage during the down slope after the ringing is diminished
- Captures the error signal at the time the secondary winding reaches zero current

The internal reference on VS is 4.05 V. Temperature compensation on the VS reference voltage of $-0.8\text{mV}/^\circ\text{C}$ offsets the change in the output rectifier forward voltage with temperature. The resistor divider is selected as outlined in the VS pin description.

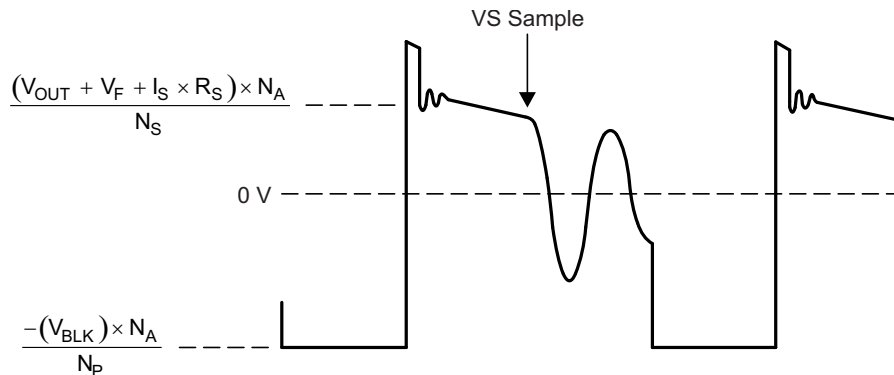
Device Functional Modes (continued)

Figure 13. Auxiliary Winding Voltage

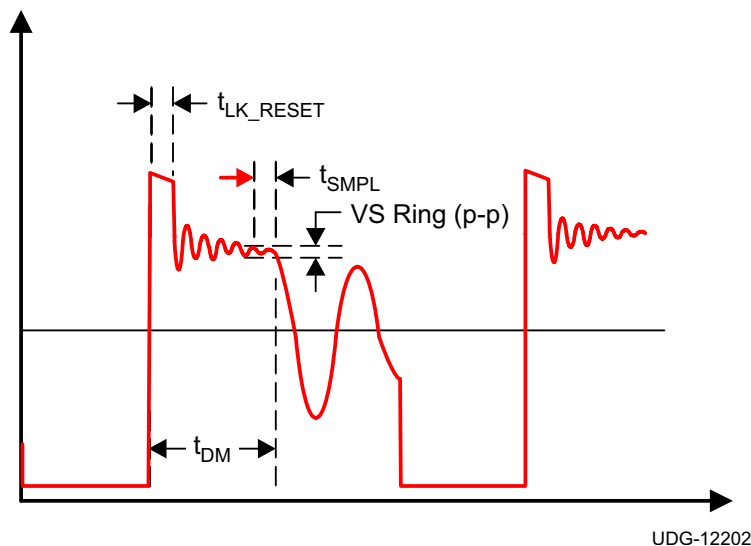
The UCC28722 includes a VS signal sampler that uses discrimination methods to ensure an accurate sample of the output voltage from the auxiliary winding. There are some conditions that must be met on the auxiliary winding signal to ensure reliable operation. These conditions are the reset time of the leakage inductance and the duration of any subsequent leakage inductance ring. Refer to [Figure 14](#) for a detailed illustration of waveform criteria to ensure a reliable sample on the VS pin. The first detail to examine is the duration of the leakage inductance reset pedestal, t_{LK_RESET} in [Figure 14](#). Because this can mimic the waveform of the secondary current decay followed by a sharp downslope, it is important to keep the leakage reset time less than 600 ns for I_{PRI} minimum, and less than 2.2 μ s for I_{PRI} maximum. The second detail is the amplitude of ringing on the V_{AUX} waveform following t_{LK_RESET} . The peak-to-peak voltage at the VS pin should be less than approximately 100 mV_{p-p} at least 200 ns before the end of the demagnetization time, t_{DM} . If there is a concern with excessive ringing, it usually occurs during light or no-load conditions, when t_{DM} is at the minimum. The tolerable ripple on VS scales up when measured at the auxiliary winding by R_{S1} and R_{S2} , and is equal to $100 \text{ mV} \times (R_{S1} + R_{S2}) / R_{S2}$ when measured directly at the auxiliary winding.

Figure 14. Auxiliary Waveform Details

During voltage regulation, the controller operates in frequency modulation mode and amplitude modulation mode as illustrated in [Figure 15](#). The internal operating frequency limits of the device are 80 kHz, $f_{SW(max)}$ and 650 Hz, $f_{SW(min)}$. The transformer primary inductance and primary peak current chosen sets the maximum operating frequency of the converter. The output preload resistor and efficiency at low power determines the converter minimum operating frequency. There is no stability compensation required for the UCC28722.

Device Functional Modes (continued)

Control Law Profile in Constant Voltage (CV) Mode

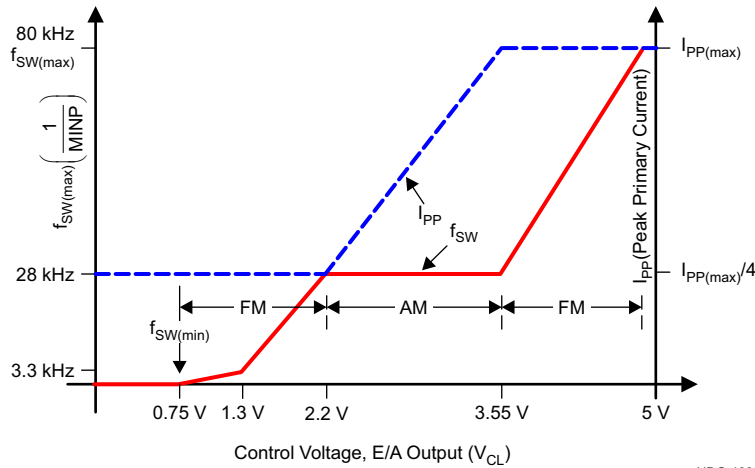

UDG-13095

Figure 15. Frequency and Amplitude Modulation Modes During Voltage Regulation

7.4.2 Primary-Side Current Regulation

Timing information at the VS pin and current information at the CS pin allow accurate regulation of the secondary average current. The control law dictates that as power is increased in CV regulation and approaching CC regulation the primary-peak current is at $I_{PP(max)}$. Referring to Figure 16, the primary-peak current, turns ratio, secondary demagnetization time (t_{DM}), and switching period (t_{SW}) determine the secondary average output current. Ignoring leakage inductance effects, the average output current is given by Equation 6. When the average output current reaches the regulation reference in the current control block, the controller operates in frequency modulation mode to control the output current at any output voltage at or below the voltage regulation target as long as the auxiliary winding can keep VDD above the UVLO turnoff threshold.

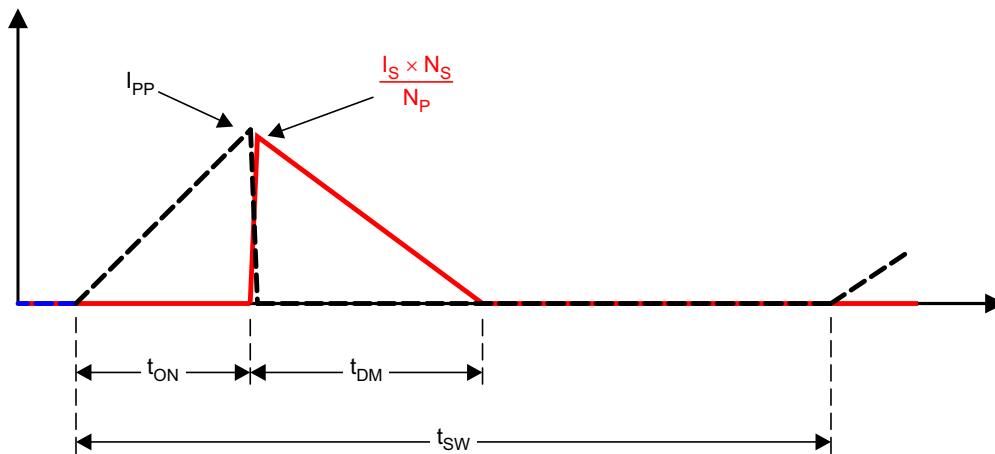

UDG-12203

Figure 16. Transformer Currents

$$I_{OUT} = \frac{I_{PP}}{2} \times \frac{N_P}{N_S} \times \frac{t_{DM}}{t_{SW}} \tag{6}$$

Device Functional Modes (continued)

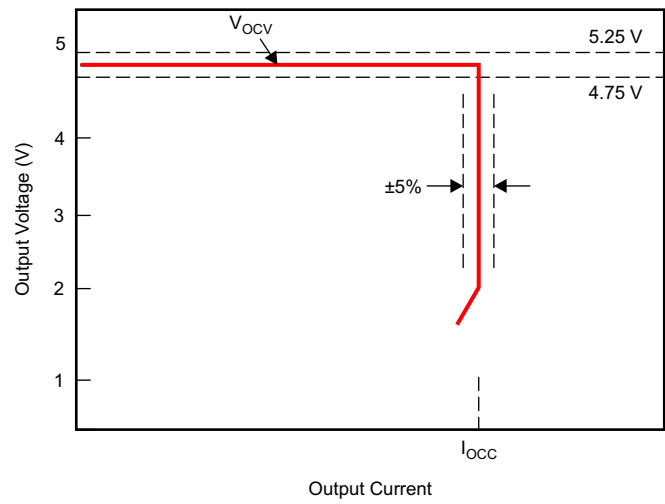

UDG-12201

Figure 17. Typical Target Output V-I Characteristic

7.4.3 Valley Switching

The UCC28722 utilizes valley switching to reduce switching losses in the transistor, to reduce induced-EMI, and to minimize the turnon current spike at the sense resistor. The controller operates in valley-switching in all load conditions unless the collector voltage (V_C) ringing has subsided.

Referring to Figure 18, the UCC28722 operates in a valley-skipping mode in most load conditions to maintain an accurate voltage or current regulation point and still switch on the lowest available V_C .

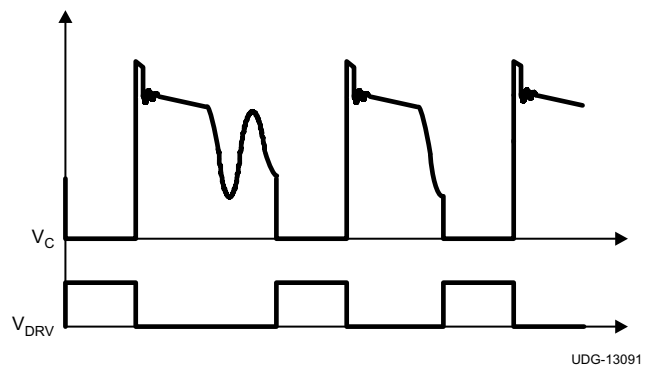

UDG-13091

Figure 18. Valley-Skipping Mode

7.4.4 Start-Up Operation

An external resistor connected from the bulk capacitor voltage (V_{BLK}) to the VDD pin charges the VDD capacitor. The amount of startup current that is available to charge the VDD capacitor is dependent on the value of this external startup resistor. Larger values supply less current and increase startup time but at the expense of increasing standby power and decreasing efficiency at high input voltage and light loading. When VDD reaches the 21-V UVLO turnon threshold, the controller is enabled, the converter starts switching. The initial three cycles are limited to $I_{PP(min)}$. After the initial three cycles at minimum $I_{PP(min)}$, the controller responds to the condition dictated by the control law. The converter will remain in discontinuous mode during charging of the output capacitors, maintaining a constant output current until the output voltage is in regulation.

Device Functional Modes (continued)

NOTE

It is possible for the startup resistor to supply more current to the VDD node than the IC will consume at higher bulk input voltages. A Zener diode clamp will be required on the VDD pin to keep the VDD pin voltage within limits if this is the case.

7.4.5 Fault Protection

The UCC28722 provides comprehensive fault protection. Protection functions include the following:

- Output over-voltage fault
- Input under-voltage fault
- Internal over-temperature fault
- Primary over-current fault
- CS pin fault
- VS pin fault

A UVLO reset and restart sequence applies for all fault protection events.

The output over-voltage function is determined by the voltage feedback on the VS pin. If the voltage sample on VS exceeds 115% of the nominal V_{OUT} , the device stops switching and the internal current consumption is I_{FAULT} which discharges the VDD capacitor to the UVLO turnoff threshold. After that, the device returns to the start state and a start-up sequence ensues.

The UCC28722 always operates with cycle-by-cycle primary peak current control. The normal operating range of the CS pin is 0.78 V to 0.195 V. There is additional protection if the CS pin reaches 1.5 V. This results in a UVLO reset and restart sequence.

The line input run and stop thresholds are determined by current information at the VS pin during the transistor on-time. While the VS pin is clamped close to GND during the transistor on-time, the current through R_{S1} is monitored to determine a sample of the bulk capacitor voltage. A wide separation of run and stop thresholds allows clean start-up and shut-down of the power supply with the line voltage. The run current threshold is 225 μ A and the stop current threshold is 80 μ A.

The internal over-temperature protection threshold is 165°C. If the junction temperature reaches this threshold the device initiates a UVLO reset cycle. If the temperature is still high at the end of the UVLO cycle, the protection cycle repeats.

Protection is included in the event of component failures on the VS pin. If complete loss of feedback information on the VS pin occurs, the controller stops switching and restarts.

8 Application and Implementation

NOTE

Information in the following applications sections is not part of the TI component specification, and TI does not warrant its accuracy or completeness. TI's customers are responsible for determining suitability of components for their purposes. Customers should validate and test their design implementation to confirm system functionality.

8.1 Application Information

The UCC28722 flyback power supply controller provides constant voltage (CV) and constant current (CC) output regulation to help meet USB-compliant adaptors and charger requirements. This device uses the information obtained from auxiliary winding sensing (VS) to control the output voltage and does not require optocoupler or TL431 feedback circuitry. Not requiring optocoupler feedback reduces the component count and makes the design more cost effective and efficient.

8.2 Typical Application

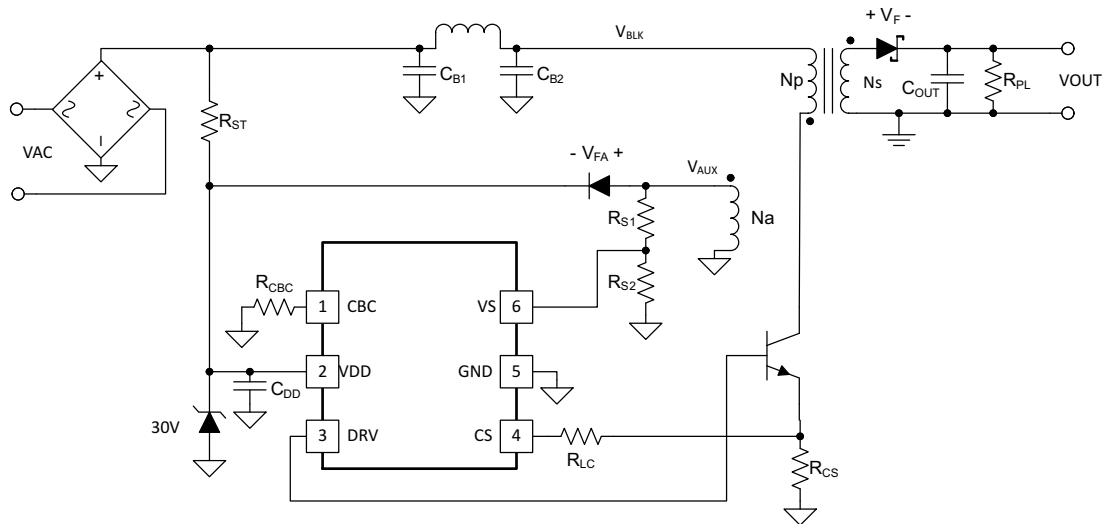

Figure 19. Design Procedure Application Example

Typical Application (continued)

8.2.1 Design Requirements

The design parameters are listed in [Table 1](#).

Table 1. Design Parameters

PARAMETER		TEST CONDITIONS	MIN	NOM	MAX	UNIT
INPUT CHARACTERISTICS						
V _{IN}	RMS Input Voltage		100 (V _{IN(MIN)})	115/230	240	V
f _{LINE}	Line Frequency		47	50/60	64	Hz
V _{IN(RUN)}	Brownout Voltage	I _{OUT} = Nom		70		V
OUTPUT CHARACTERISTICS						
V _{OCV}	Output Voltage	V _{IN} = Nom, I _{OUT} = NOM	4.75	5	5.25	V
V _{RIPPLE}	Output Voltage Ripple	V _{IN} = Nom, I _O = Max			0.15	V
I _{OUT}	Output Current	V _{IN} = Min to Max		1	1.05	A
	Output OVP	I _{OUT} = Min to Max		5.75		V
	Transient Response					
	Load Step (I _{TRAN} = 0.6 A)	(0.1 to 0.6 A) or (0.6 to 0.1 A) V _{OD} = 0.9 V for Calculations	4.1	5	6	V
SYSTEMS CHARACTERISTICS						
f _{MAX}	Switching Frequency			70		kHz
η	Full Load Efficiency (115/230 V RMS input)	I _{OUT} = 1 A	75%			

8.2.2 Detailed Design Procedure

This procedure outlines the steps to design a constant-voltage, constant-current flyback converter using the UCC28722 controller. Refer to [Figure 19](#) for component names and network locations. The design procedure equations use terms that are defined in [Stand-by Power Estimate](#) through [Startup Resistance and Startup Time](#).

8.2.2.1 Stand-by Power Estimate

Assuming no-load stand-by power is a critical design parameter, determine estimated no-load power based on target converter maximum switching frequency and output power rating.

The following [Equation 7](#) estimates the stand-by power of the converter.

$$P_{SB_CONV} = \frac{P_{OUT} \times f_{MIN}}{\eta_{SB} \times K_{AM}^2 \times f_{MAX}} \quad (7)$$

For a typical USB charger application, the bias power during no-load is approximately 2.5 mW. This is based on 25-V V_{DD} and 100-μA bias current. The output preload resistor can be estimated by V_{OCV} and the difference in the converter stand-by power and the bias power. [Equation 8](#) shows output preload resistance accounts for bias power estimated at 2.5 mW.

$$R_{PL} = \frac{V_{OCV}^2}{P_{SB_CONV} - 2.5 \text{ mW}} \quad (8)$$

Typical startup resistance values for R_{STR} range from 1 MΩ to 5MΩ to achieve 2 s startup time. The capacitor bulk voltage for the loss estimation is the highest voltage for the stand-by power measurement, typically 325 V_{DC}, see [Equation 9](#).

$$P_{RSTR} = \frac{V_{BLK}^2}{R_{STR}} \quad (9)$$

For the total stand-by power estimation add an estimated 2.5 mW for snubber loss to the converter stand-by power loss, see [Equation 10](#) and [Equation 11](#).

$$P_{SB} = P_{SB_CONV} + 2.5 \text{ mW} \quad (10)$$

$$P_{SB} = P_{SB_CONV} + P_{RSTR} + 2.5 \text{ mW} \quad (11)$$

8.2.2.2 Input Bulk Capacitance and Minimum Bulk Voltage

Determine the minimum voltage on the input capacitance, C_{B1} and C_{B2} total, in order to determine the maximum N_p to N_s turns ratio of the transformer. The input power of the converter based on target full-load efficiency, minimum input RMS voltage, and minimum AC input frequency are used to determine the input capacitance requirement.

Maximum input power is determined based on V_{OCV} , I_{OCC} , and the full-load efficiency target, see [Equation 12](#).

$$P_{IN} = \frac{V_{OCV} \times I_{OCC}}{\eta} \quad (12)$$

[Equation 13](#) provides an accurate solution for input capacitance based on a target minimum bulk capacitor voltage. To target a given input capacitance value, iterate the minimum capacitor voltage to achieve the target capacitance.

$$C_{BULK} = \frac{2P_{IN} \times \left(0.25 + \frac{1}{2\pi} \times \arcsin \left(\frac{V_{BULK(min)}}{\sqrt{2} \times V_{IN(min)}} \right) \right)}{\left(2V_{IN(min)}^2 - V_{BULK(min)}^2 \right) \times f_{LINE}} \quad (13)$$

8.2.2.3 Transformer Turns Ratio, Inductance, Primary-Peak Current

The maximum primary-to-secondary turns ratio can be determined by the target maximum switching frequency at full load, the minimum input capacitor bulk voltage, and the estimated DCM quasi-resonant time.

Initially determine the maximum available total duty cycle of the on time and secondary conduction time based on target switching frequency and DCM resonant time. For DCM resonant time, assume 500 kHz if you do not have an estimate from previous designs. For the transition mode operation limit, the period required from the end of secondary current conduction to the first valley of the V_{CE} voltage is 1/2 of the DCM resonant period, or 1 μ s assuming 500-kHz resonant frequency. D_{MAX} can be determined using [Equation 14](#).

$$D_{MAX} = 1 - \left(\frac{t_R}{2} \times f_{MAX} \right) - D_{MAGCC} \quad (14)$$

Once D_{MAX} is known, the maximum turns ratio of the primary to secondary can be determined with the equation below. D_{MAGCC} is defined as the secondary diode conduction duty cycle during constant-current, CC, operation. It is set internally by the UCC28722 at 0.425. The total voltage on the secondary winding needs to be determined; which is the sum of V_{OCV} , the secondary rectifier V_F , and the cable compensation voltage (V_{OCBC}). For the 5-V USB charger applications, a turns ratio range of 13 to 15 is typically used, see [Equation 15](#).

$$N_{PS(max)} = \frac{D_{MAX} \times V_{BULK(min)}}{D_{MAGCC} \times (V_{OCV} + V_F + V_{OCBC})} \quad (15)$$

Once an optimum turns ratio is determined from a detailed transformer design, use this ratio for the following parameters.

The UCC28722 constant-current regulation is achieved by maintaining a maximum D_{MAG} duty cycle of 0.425 at the maximum primary current setting. The transformer turns ratio and constant-current regulating voltage determine the current sense resistor for a target constant current.

Since not all of the energy stored in the transformer is transferred to the secondary, a transformer efficiency term is included in [Equation 16](#). This efficiency number includes the core and winding losses, leakage inductance ratio, and bias power ratio to rated output power. For a 5-V, 1-A charger example, bias power of 1.5% is a good estimate. An overall transformer efficiency of 0.9 is a good estimate to include 3.5% leakage inductance, 5% core and winding loss, and 1.5% bias power.

$$R_{CS} = \frac{V_{CCR} \times N_{PS}}{2I_{OCC}} \times \sqrt{\eta_{XFMR}} \quad (16)$$

The primary transformer inductance can be calculated using the standard energy storage equation for flyback transformers. Primary current, maximum switching frequency and output and transformer power losses are included in [Equation 17](#) and [Equation 18](#). Initially determine transformer primary current.

Primary current is simply the maximum current sense threshold divided by the current sense resistance.

$$I_{PP(max)} = \frac{V_{CST(max)}}{R_{CS}} \quad (17)$$

$$L_P = \frac{2(V_{OCV} + V_F + V_{OCBC}) \times I_{OCC}}{\eta_{XFMR} \times I_{PP(max)}^2 \times f_{MAX}} \quad (18)$$

The secondary winding to auxiliary winding transformer turns ratio (N_{AS}) is determined by the lowest target operating output voltage in constant-current regulation and the VDD UVLO of the UCC28722. There is additional energy supplied to VDD from the transformer leakage inductance energy which allows a lower turns ratio to be used in many designs [Equation 19](#)

$$N_{AS} = \frac{V_{DD(off)} + V_{FA}}{V_{OCC} + V_F} \quad (19)$$

8.2.2.4 Transformer Parameter Verification

The transformer turns ratio selected affects the transistor V_C and secondary rectifier reverse voltage so these should be reviewed. The UCC28722 does require a minimum on time of the transistor (t_{ON}) and minimum D_{MAG} time (t_{DMAG}) of the secondary rectifier in the high line, minimum load condition. The selection of f_{MAX} , L_P and R_{CS} affects the minimum t_{ON} and t_{DMAG} .

The secondary rectifier and transistor voltage stress can be determined by [Equation 20](#).

$$V_{REV} = \frac{V_{IN(max)} \times \sqrt{2}}{N_{PS}} + V_{OCV} + V_{OCBC} \quad (20)$$

For the transistor V_C voltage stress, [Equation 21](#), an estimated leakage inductance voltage spike (V_{LK}) needs to be included.

$$V_{CPK} = (V_{IN(max)} \times \sqrt{2}) + (V_{OCV} + V_F + V_{OCBC}) \times N_{PS} + V_{LK} \quad (21)$$

[Equation 22](#) and [Equation 23](#) are used to determine if the minimum t_{ON} target of 300 ns and minimum t_{DMAG} target of 1.2 μ s is achieved.

$$t_{ON(min)} = \frac{L_P}{V_{IN(max)} \times \sqrt{2}} \times \frac{I_{PP(max)} \times V_{CST(min)}}{V_{CST(max)}} \quad (22)$$

$$t_{DMAG(min)} = \frac{t_{ON} \times V_{IN(max)} \times \sqrt{2}}{N_{PS} \times (V_{OCV} + V_F)} \quad (23)$$

8.2.2.5 Output Capacitance

The output capacitance value is typically determined by the transient response requirement from no-load. For example, in some USB charger applications there is a requirement to maintain a minimum V_O of 4.1 V with a load-step transient of 0 mA to 500 mA. [Equation 24](#) assumes that the switching frequency can be at the UCC28722 minimum of $f_{SW(min)}$.

$$C_{OUT} = \frac{I_{TRAN} \left(\frac{1}{f_{SW(min)}} + 150 \mu s \right)}{V_{O\Delta}} \quad (24)$$

Another consideration of the output capacitor is the ripple voltage requirement which is reviewed based on secondary peak current and ESR. A margin of 20% is added to the capacitor ESR requirement in [Equation 25](#).

$$R_{ESR} = \frac{V_{RIPPLE} \times 0.8}{I_{PP(max)} \times N_{PS}} \quad (25)$$

8.2.2.6 VDD Capacitance, C_{DD}

The capacitance on VDD needs to supply the device operating current until the output of the converter reaches the target minimum operating voltage in constant-current regulation. At this time, the auxiliary winding can sustain the voltage to the UCC28722. The total output current available to the load and to charge the output capacitors is the constant-current regulation target, I_{OCC} . Equation 26 assumes all the output current of the flyback is available to charge the output capacitance from 0 V to V_{OCC} . If the converter is going to be loaded during the time the output is ramping from 0 V to V_{OCC} , that load current must be subtracted for the available output current limit value, I_{OCC} . There is 1 V of margin added to VDD in the calculation.

$$C_{DD} = \frac{\left(I_{RUN} + I_{DRS(max)} \times (1 - D_{magcc}) \right) \times \frac{C_{OUT} \times V_{OCC}}{I_{OCC}}}{(V_{DD(on)} - V_{DD(off)}) - 1 \text{ V}} \quad (26)$$

NOTE

The typical ceramic capacitor of sufficient ratings for use here varies considerably in effective capacitance as the voltage across the capacitor changes. As the capacitor voltage increases beyond 25% of its rated voltage, the effective capacitance can become significantly less than the nominal capacitance at zero bias. This equation calculated the effective capacitance needed over the 8V to 21V range, not the nominal zero bias capacitance required. Evaluation of the particular capacitor chosen for this function is strongly recommended to ensure adequate capacitance over the 8V to 21V range.

8.2.2.7 VS Resistor Divider, Line Compensation, and Cable Compensation

The VS divider resistors determine the output voltage regulation point of the flyback converter, also the high-side divider resistor (R_{S1}) determines the line voltage at which the controller enables continuous DRV operation. R_{S1} is initially determined based on transformer auxiliary to primary turns ratio and desired input voltage operating threshold in Equation 27.

$$R_{S1} = \frac{V_{IN(run)} \times \sqrt{2}}{N_{PA} \times I_{VSL(run)}} \quad (27)$$

The low-side VS pin resistor is selected based on desired V_O regulation voltage in Equation 28.

$$R_{S2} = \frac{R_{S1} \times V_{VSR}}{N_{AS} \times (V_{OCV} + V_F) - V_{VSR}} \quad (28)$$

The UCC28722 can maintain tight constant-current regulation over input line by utilizing the line compensation feature. The line compensation resistor (R_{LC}) value is determined by current flowing in R_{S1} and expected base drive and transistor turnoff delay in Equation 29. Assume a 50-ns internal delay in the UCC28722.

$$R_{LC} = \frac{K_{LC} \times R_{S1} \times R_{CS} \times t_D \times N_{PA}}{L_P} \quad (29)$$

The UCC28722 has adjustable cable drop compensation. The resistance for the desired compensation level at the output terminals can be determined using Equation 30.

$$R_{CBC} = \frac{V_{CBC(max)} \times 3 \text{ k}\Omega \times (V_{OCV} + V_F)}{V_{VSR} \times V_{OCBC}} - 28 \text{ k}\Omega \quad (30)$$

8.2.2.8 Startup Resistance and Startup Time

When the VDD capacitor is known, there is a tradeoff to be made between startup time and overall standby input power to the converter. Faster startup time requires a smaller startup resistance, which results in higher standby input power in Equation 31.

$$R_{STR} = \frac{\sqrt{2} \times V_{IN(min)}}{I_{START} + \frac{V_{DD(on)} \times C_{DD}}{T_{STR}}} \tag{31}$$

8.2.3 Application Curves

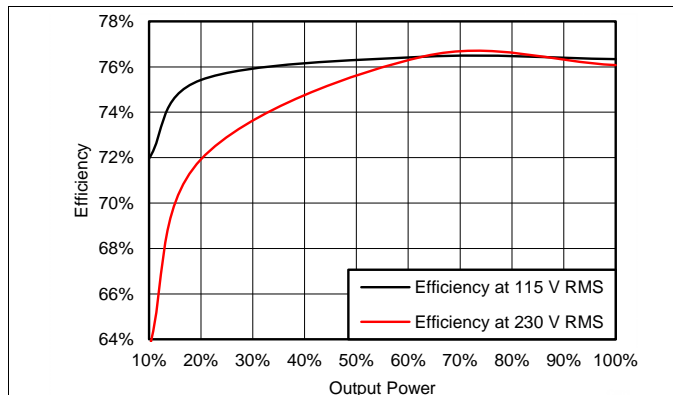

Figure 20. Efficiency

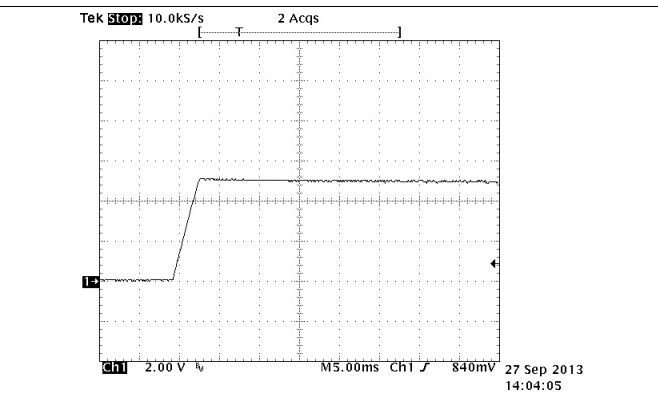

Figure 21. Output at Startup 115-V RMS, No Load

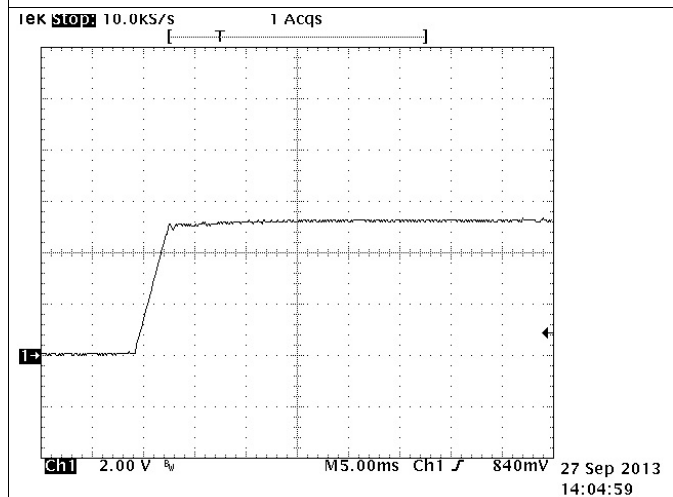

Figure 22. Output at Startup 115-V RMS, 5-Ω Load

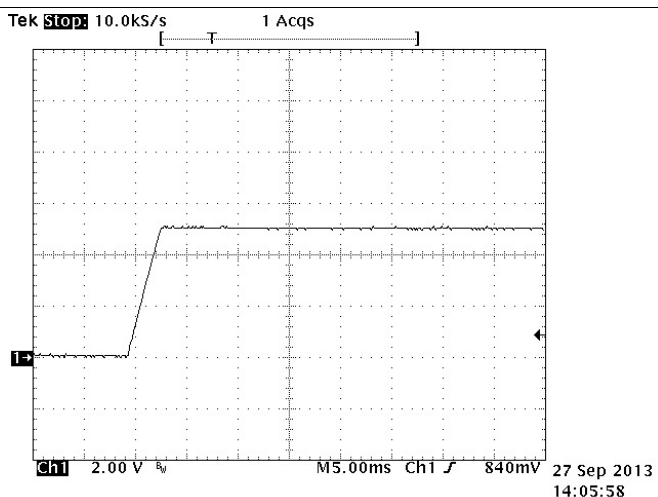
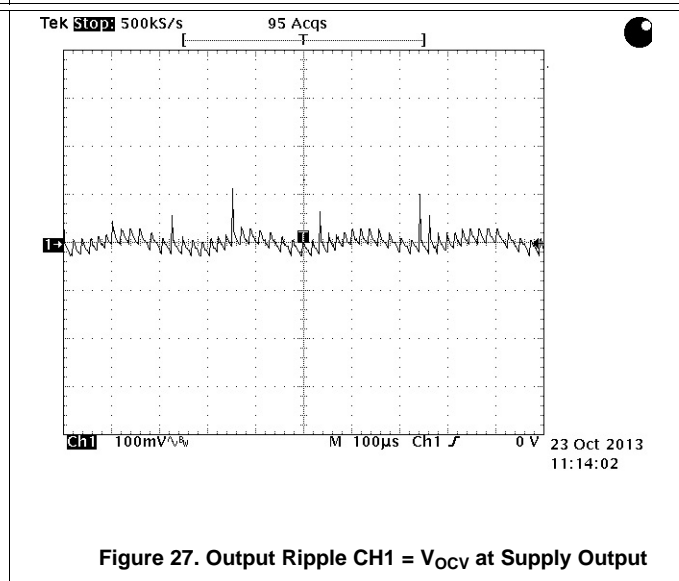
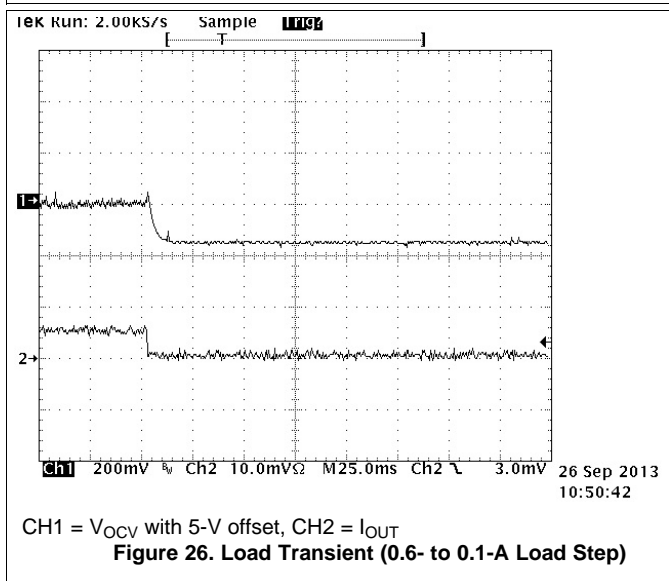
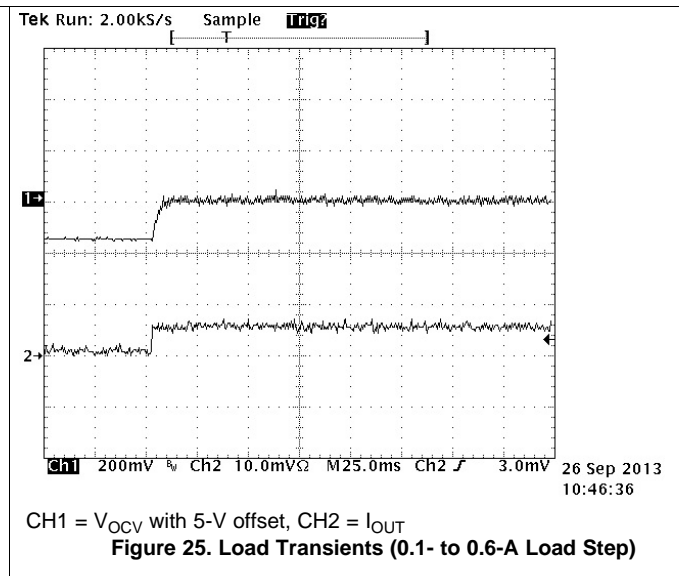
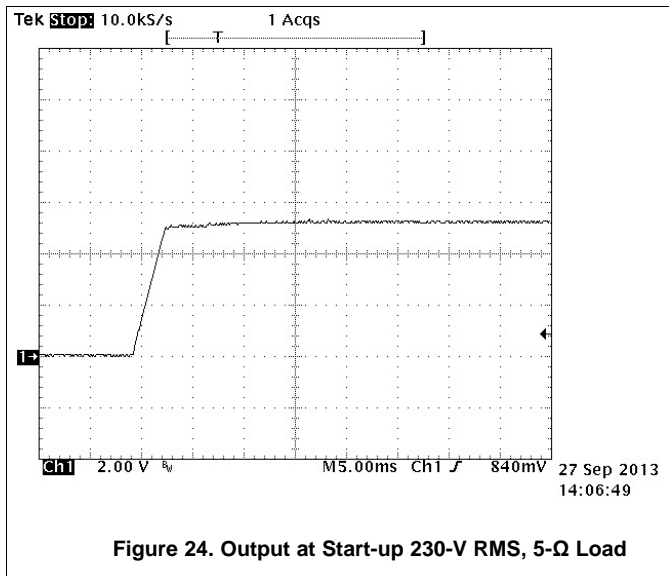

Figure 23. Output at Startup 230-V RMS, No Load



9 Power Supply Recommendations

The UCC28722 is intended for AC/DC adapters and chargers with input voltage range of 85 VAC_(rms) to 265 VAC_(rms) using Flyback topology. This device can be used in other applications and converter topologies with different input voltages. Ensure that all voltages and currents are within the *Recommended Operating Conditions* and *Absolute Maximum Ratings* of the device. To maintain output current regulation over the entire input voltage range, design the converter to operate close to f_{MAX} when in full-load conditions. To improve thermal performance, increase the copper area connected to GND pins.

10 Layout

10.1 Layout Guidelines

- High frequency bypass Capacitor C7 should be placed across Pin 2 and 5 as close as you can get it to the pins.
- Resistor R15 and C7 form a low pass filter and the connection of R15 and C7 should be as close to the VDD pin as possible.
- C9 should be put as close to CS pin and R10 as possible. This forms a low pass filter with R10.
- The connection for C9 and R10 should be as close to the CS pin as possible.
- C9 may not be required in all designs. However, it is wise to put a place holder for it in your design.
- The VS pin controls the output voltage through the transformer turns ratio and the voltage divider of R7 and R9. The trace with between the R7, R9 and VS pin should be as short as possible to reduce and eliminate possible EMI coupling.
- The IC ground and power ground should meet at the return of the bulk capacitors (C4 and C5). Ensure that high frequency and high current from the power stage does not go through the signal ground
 - The high frequency and high current path that you need to be cautious of on the primary is C4, C5 +, T1(P1,P2), Q1e, Q1c, R13 to the return of C4 and C5.
- Keep all high current loops as short as possible.
- Keep all high current and high frequency traces away from or perpendicular to other traces in the design.
- Traces on the voltage clamp formed by D1, R1, D4 and C4 as short as possible.
- C4 return needs to be as close to the bulk capacitor supply as possible. This reduces the magnitude of dv/dt caused by large di/dt .
- Avoid mounting semiconductors under magnetics.

10.2 Layout Example

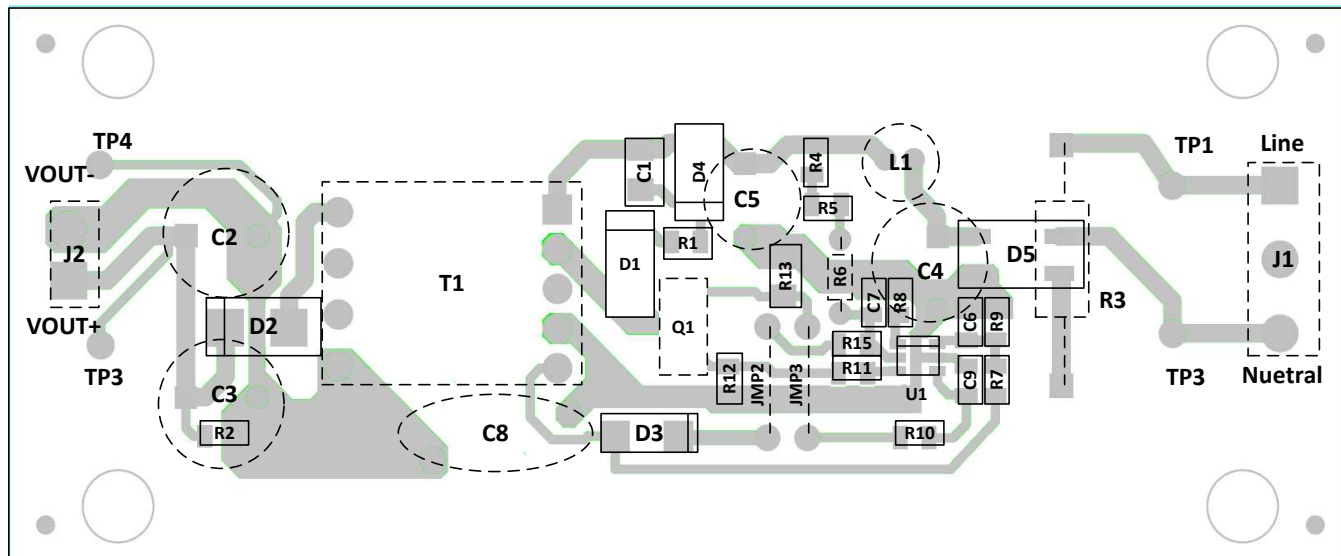

Figure 28. PCB Layout Example

11 Device and Documentation Support

11.1 Device Support

11.1.1 Device Nomenclature

11.1.1.1 Definition of Terms

11.1.1.1.1 Capacitance Terms in Farads

- C_{BULK} : total input capacitance of C_{B1} and C_{B2} .
- C_{DD} : minimum required capacitance on the VDD pin.
- C_{OUT} : minimum output capacitance required.

11.1.1.1.2 Duty Cycle Terms

- D_{MAGCC} : secondary diode conduction duty cycle in CC, 0.425.
- D_{MAX} : transistor on-time duty cycle.

11.1.1.1.3 Frequency Terms in Hertz

- f_{LINE} : minimum line frequency.
- f_{MAX} : target full-load maximum switching frequency of the converter.
- f_{MIN} : minimum switching frequency of the converter, add 15% margin over the $f_{SW(min)}$ limit of the device.
- $f_{SW(min)}$: minimum switching frequency (see [Electrical Characteristics](#)).

11.1.1.1.4 Current Terms in Amperes

- I_{OCC} : converter output constant-current target.
- $I_{PP(max)}$: maximum transformer primary current.
- I_{START} : start-up bias supply current (see [Electrical Characteristics](#)).
- I_{TRAN} : required positive load-step current.
- $I_{VSL(run)}$: VS pin run current (see [Electrical Characteristics](#)).
- I_{DRS} : Driver source current (see [Electrical Characteristics](#)).

11.1.1.1.5 Current and Voltage Scaling Terms

- K_{AM} : maximum-to-minimum peak primary current ratio (see [Electrical Characteristics](#)).
- K_{LC} : current-scaling constant (see [Electrical Characteristics](#)).

11.1.1.1.6 Transformer Terms

- L_P : transformer primary inductance.
- N_{AS} : transformer auxiliary-to-secondary turns ratio.
- N_{PA} : transformer primary-to-auxiliary turns ratio.
- N_{PS} : transformer primary-to-secondary turns ratio.

11.1.1.1.7 Power Terms in Watts

- P_{IN} : converter maximum input power.
- P_{OUT} : full-load output power of the converter.
- P_{RSTR} : VDD start-up resistor power dissipation.
- P_{SB} : total stand-by power.
- P_{SB_CONV} : P_{SB} minus start-up resistor and snubber losses.

11.1.1.1.8 Resistance Terms in Ω

- R_{CS} : primary current programming resistance.
- R_{ESR} : total ESR of the output capacitor(s).
- R_{PL} : preload resistance on the output of the converter.
- R_{S1} : high-side VS pin resistance.

Device Support (continued)

- R_{S2} : low-side VS pin resistance.
- R_{STR} : startup resistance.

11.1.1.1.9 Timing Terms in Seconds

- t_D : current-sense delay including transistor turnoff delay; add 50 ns to transistor delay.
- $t_{DMAG(min)}$: minimum secondary rectifier conduction time.
- $t_{ON(min)}$: minimum transistor on time.
- t_R : resonant frequency during the DCM (discontinuous conduction mode) time.
- t_{ST} : startup time

11.1.1.1.10 Voltage Terms in Volts

- V_{BLK} : highest bulk capacitor voltage for stand-by power measurement.
- $V_{BULK(min)}$: minimum voltage on C_{B1} and C_{B2} at full power.
- V_{OCBC} : target cable compensation voltage at the output terminals.
- $V_{CBC(max)}$: maximum voltage at the CBC pin at the maximum converter output current (see [Electrical Characteristics](#)).
- V_{CCR} : constant-current regulating voltage (see [Electrical Characteristics](#)).
- $V_{CST(max)}$: CS pin maximum current-sense threshold (see [Electrical Characteristics](#)).
- $V_{CST(min)}$: CS pin minimum current-sense threshold (see [Electrical Characteristics](#)).
- $V_{DD(off)}$: UVLO turnoff voltage (see [Electrical Characteristics](#)).
- $V_{DD(on)}$: UVLO turnon voltage (see [Electrical Characteristics](#)).
- $V_{OΔ}$: output voltage drop allowed during the load-step transient.
- V_{CPK} : peak transistor collector to emitter voltage at high line.
- V_F : secondary rectifier forward voltage drop at near-zero current.
- V_{FA} : auxiliary rectifier forward voltage drop.
- V_{LK} : estimated leakage inductance energy reset voltage.
- V_{OCV} : regulated output voltage of the converter.
- V_{OCC} : target lowest converter output voltage in constant-current regulation.
- V_{REV} : peak reverse voltage on the secondary rectifier.
- V_{RIPPLE} : output peak-to-peak ripple voltage at full-load.
- V_{VSR} : CV regulating level at the VS input (see [Electrical Characteristics](#)).

11.1.1.1.11 AC Voltage Terms in V_{RMS}

- $V_{IN(max)}$: maximum input voltage to the converter.
- $V_{IN(min)}$: minimum input voltage to the converter.
- $V_{IN(run)}$: converter input start-up (run) voltage.

11.1.1.1.12 Efficiency Terms

- η_{SB} : estimated efficiency of the converter at no-load condition, not including start-up resistance or bias losses.
For a 5-V USB charger application, 60% to 65% is a good initial estimate.
- η : converter overall efficiency.
- η_{XFMR} : transformer primary-to-secondary power transfer efficiency.

11.2 Documentation Support

11.2.1 Related Documentation

See the following: [UCC28722/UCC28720 5W USB BJT Flyback Design Example](#), [SLUA700](#)

11.3 Community Resources

The following links connect to TI community resources. Linked contents are provided "AS IS" by the respective contributors. They do not constitute TI specifications and do not necessarily reflect TI's views; see TI's [Terms of Use](#).

TI E2E™ Online Community *TI's Engineer-to-Engineer (E2E) Community*. Created to foster collaboration among engineers. At e2e.ti.com, you can ask questions, share knowledge, explore ideas and help solve problems with fellow engineers.

Design Support *TI's Design Support* Quickly find helpful E2E forums along with design support tools and contact information for technical support.

11.4 Trademarks

E2E is a trademark of Texas Instruments.
All other trademarks are the property of their respective owners.

11.5 Electrostatic Discharge Caution



These devices have limited built-in ESD protection. The leads should be shorted together or the device placed in conductive foam during storage or handling to prevent electrostatic damage to the MOS gates.

11.6 Glossary

[SLYZ022](#) — *TI Glossary*.

This glossary lists and explains terms, acronyms, and definitions.

12 Mechanical, Packaging, and Orderable Information

The following pages include mechanical, packaging, and orderable information. This information is the most current data available for the designated devices. This data is subject to change without notice and revision of this document. For browser-based versions of this data sheet, refer to the left-hand navigation.

PACKAGING INFORMATION

Orderable Device	Status (1)	Package Type	Package Drawing	Pins	Package Qty	Eco Plan (2)	Lead finish/ Ball material (6)	MSL Peak Temp (3)	Op Temp (°C)	Device Marking (4/5)	Samples
UCC28722DBVR	ACTIVE	SOT-23	DBV	6	3000	RoHS & Green	NIPDAU	Level-1-260C-UNLIM	-40 to 125	U722	Samples
UCC28722DBVT	ACTIVE	SOT-23	DBV	6	250	RoHS & Green	NIPDAU	Level-1-260C-UNLIM	-40 to 125	U722	Samples

(1) The marketing status values are defined as follows:

ACTIVE: Product device recommended for new designs.

LIFEBUY: TI has announced that the device will be discontinued, and a lifetime-buy period is in effect.

NRND: Not recommended for new designs. Device is in production to support existing customers, but TI does not recommend using this part in a new design.

PREVIEW: Device has been announced but is not in production. Samples may or may not be available.

OBsolete: TI has discontinued the production of the device.

(2) **RoHS:** TI defines "RoHS" to mean semiconductor products that are compliant with the current EU RoHS requirements for all 10 RoHS substances, including the requirement that RoHS substance do not exceed 0.1% by weight in homogeneous materials. Where designed to be soldered at high temperatures, "RoHS" products are suitable for use in specified lead-free processes. TI may reference these types of products as "Pb-Free".

RoHS Exempt: TI defines "RoHS Exempt" to mean products that contain lead but are compliant with EU RoHS pursuant to a specific EU RoHS exemption.

Green: TI defines "Green" to mean the content of Chlorine (Cl) and Bromine (Br) based flame retardants meet JS709B low halogen requirements of <=1000ppm threshold. Antimony trioxide based flame retardants must also meet the <=1000ppm threshold requirement.

(3) MSL, Peak Temp. - The Moisture Sensitivity Level rating according to the JEDEC industry standard classifications, and peak solder temperature.

(4) There may be additional marking, which relates to the logo, the lot trace code information, or the environmental category on the device.

(5) Multiple Device Markings will be inside parentheses. Only one Device Marking contained in parentheses and separated by a "~" will appear on a device. If a line is indented then it is a continuation of the previous line and the two combined represent the entire Device Marking for that device.

(6) Lead finish/Ball material - Orderable Devices may have multiple material finish options. Finish options are separated by a vertical ruled line. Lead finish/Ball material values may wrap to two lines if the finish value exceeds the maximum column width.

Important Information and Disclaimer:The information provided on this page represents TI's knowledge and belief as of the date that it is provided. TI bases its knowledge and belief on information provided by third parties, and makes no representation or warranty as to the accuracy of such information. Efforts are underway to better integrate information from third parties. TI has taken and continues to take reasonable steps to provide representative and accurate information but may not have conducted destructive testing or chemical analysis on incoming materials and chemicals. TI and TI suppliers consider certain information to be proprietary, and thus CAS numbers and other limited information may not be available for release.

In no event shall TI's liability arising out of such information exceed the total purchase price of the TI part(s) at issue in this document sold by TI to Customer on an annual basis.

TAPE AND REEL INFORMATION



QUADRANT ASSIGNMENTS FOR PIN 1 ORIENTATION IN TAPE



*All dimensions are nominal

Device	Package Type	Package Drawing	Pins	SPQ	Reel Diameter (mm)	Reel Width W1 (mm)	A0 (mm)	B0 (mm)	K0 (mm)	P1 (mm)	W (mm)	Pin1 Quadrant
UCC28722DBVR	SOT-23	DBV	6	3000	178.0	9.0	3.23	3.17	1.37	4.0	8.0	Q3
UCC28722DBVT	SOT-23	DBV	6	250	178.0	9.0	3.23	3.17	1.37	4.0	8.0	Q3

TAPE AND REEL BOX DIMENSIONS

*All dimensions are nominal

Device	Package Type	Package Drawing	Pins	SPQ	Length (mm)	Width (mm)	Height (mm)
UCC28722DBVR	SOT-23	DBV	6	3000	180.0	180.0	18.0
UCC28722DBVT	SOT-23	DBV	6	250	180.0	180.0	18.0

EXAMPLE BOARD LAYOUT

DBV0006A

SOT-23 - 1.45 mm max height

SMALL OUTLINE TRANSISTOR



LAND PATTERN EXAMPLE
EXPOSED METAL SHOWN
SCALE:15X

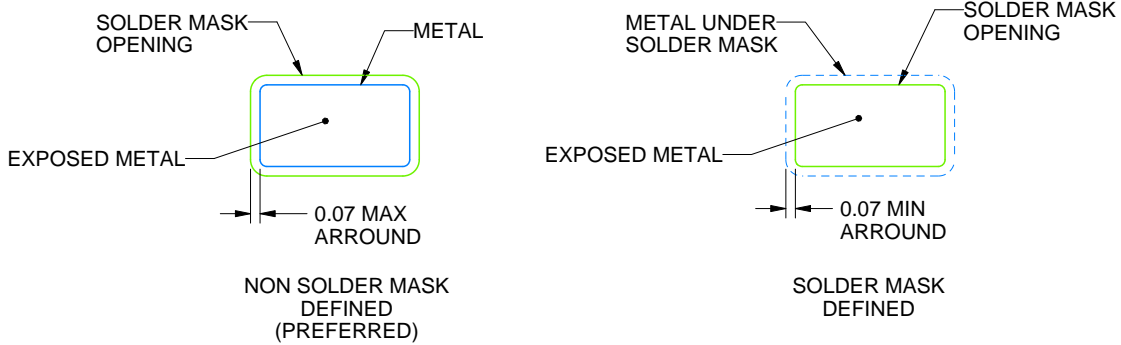

SOLDER MASK DETAILS

4214840/E 02/2024

NOTES: (continued)

6. Publication IPC-7351 may have alternate designs.

7. Solder mask tolerances between and around signal pads can vary based on board fabrication site.

EXAMPLE STENCIL DESIGN

DBV0006A

SOT-23 - 1.45 mm max height

SMALL OUTLINE TRANSISTOR



SOLDER PASTE EXAMPLE
BASED ON 0.125 mm THICK STENCIL
SCALE:15X

4214840/E 02/2024

NOTES: (continued)

8. Laser cutting apertures with trapezoidal walls and rounded corners may offer better paste release. IPC-7525 may have alternate design recommendations.
9. Board assembly site may have different recommendations for stencil design.

IMPORTANT NOTICE AND DISCLAIMER

TI PROVIDES TECHNICAL AND RELIABILITY DATA (INCLUDING DATA SHEETS), DESIGN RESOURCES (INCLUDING REFERENCE DESIGNS), APPLICATION OR OTHER DESIGN ADVICE, WEB TOOLS, SAFETY INFORMATION, AND OTHER RESOURCES "AS IS" AND WITH ALL FAULTS, AND DISCLAIMS ALL WARRANTIES, EXPRESS AND IMPLIED, INCLUDING WITHOUT LIMITATION ANY IMPLIED WARRANTIES OF MERCHANTABILITY, FITNESS FOR A PARTICULAR PURPOSE OR NON-INFRINGEMENT OF THIRD PARTY INTELLECTUAL PROPERTY RIGHTS.

These resources are intended for skilled developers designing with TI products. You are solely responsible for (1) selecting the appropriate TI products for your application, (2) designing, validating and testing your application, and (3) ensuring your application meets applicable standards, and any other safety, security, regulatory or other requirements.

These resources are subject to change without notice. TI grants you permission to use these resources only for development of an application that uses the TI products described in the resource. Other reproduction and display of these resources is prohibited. No license is granted to any other TI intellectual property right or to any third party intellectual property right. TI disclaims responsibility for, and you will fully indemnify TI and its representatives against, any claims, damages, costs, losses, and liabilities arising out of your use of these resources.

TI's products are provided subject to [TI's Terms of Sale](#) or other applicable terms available either on [ti.com](https://www.ti.com) or provided in conjunction with such TI products. TI's provision of these resources does not expand or otherwise alter TI's applicable warranties or warranty disclaimers for TI products.

TI objects to and rejects any additional or different terms you may have proposed.

Mailing Address: Texas Instruments, Post Office Box 655303, Dallas, Texas 75265
Copyright © 2024, Texas Instruments Incorporated