

TPS54310 3-V to 6-V Input, 3-A Output Synchronous-Buck PWM Switcher With Integrated FETs

1 Features

- 60-mΩ MOSFET switches for high efficiency at 3-A continuous output source or sink current
- Adjustable output voltage down to 0.9 V With 1% accuracy
- Externally compensated for design flexibility
- Fast transient response
- Wide PWM frequency: fixed 350 kHz, 550 kHz, or adjustable 280 kHz to 700 kHz
- Load protected by peak current limit and thermal shutdown
- Integrated solution reduces board area and total cost

2 Applications

- Low-voltage, high-density systems with power distributed at 5 V or 3.3 V
- Point-of-load regulation for high performance DSPs, FPGAs, ASICs, and microprocessors
- Broadband, networking and optical communications infrastructure
- Portable computing/notebook PCs

3 Description

As a member of one of TI's families of dc/dc regulators, the TPS54310 low-input-voltage high-output-current synchronous-buck PWM converter integrates all required active components. Included on the substrate with the listed features are a true, high performance, voltage error amplifier that provides high performance under transient conditions; an undervoltage-lockout circuit to prevent start-up until the input voltage reaches 3 V; an internally and externally set slow-start circuit to limit in-rush currents; and a power good output useful for processor/logic reset, fault signaling, and supply sequencing.

The TPS54310 device is available in a thermally enhanced 20-pin HTSSOP (PWP) PowerPAD™ package, which eliminates bulky heatsinks. TI provides evaluation modules to aid in quickly achieving high-performance power supply designs to meet aggressive equipment development cycles.

Device Information⁽¹⁾

PART NUMBER	PACKAGE	BODY SIZE (NOM)
TPS54310	HTSSOP PowerPAD (20)	6.40 mm × 6.30 mm

(1) For all available packages, see the orderable addendum at the end of the data sheet.

Simplified Schematic

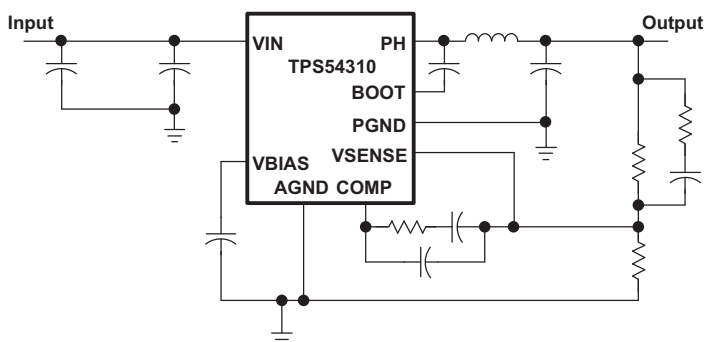

Efficiency vs Load Current

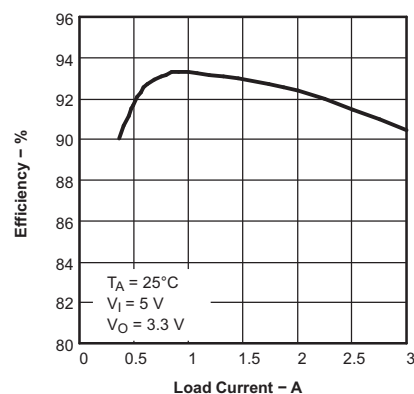

Table of Contents

1 Features	1	8.3 Feature Description	9
2 Applications	1	8.4 Device Functional Modes	12
3 Description	1	9 Application and Implementation	13
4 Revision History	2	9.1 Application Information	13
5 Device Comparison Table	3	9.2 Typical Application	13
6 Pin Configuration and Functions	3	10 Power Supply Recommendations	18
7 Specifications	4	11 Layout	18
7.1 Absolute Maximum Ratings	4	11.1 Layout Guidelines	18
7.2 ESD Ratings	4	11.2 Layout Example	19
7.3 Recommended Operating Conditions	4	12 Device and Documentation Support	20
7.4 Thermal Information	4	12.1 Related DC/DC Products	20
7.5 Dissipation Ratings	5	12.2 Receiving Notification of Documentation Updates	20
7.6 Electrical Characteristics	5	12.3 Community Resources	20
7.7 Typical Characteristics	7	12.4 Trademarks	20
8 Detailed Description	9	12.5 Electrostatic Discharge Caution	20
8.1 Overview	9	12.6 Glossary	20
8.2 Functional Block Diagram	9	13 Mechanical, Packaging, and Orderable Information	20

4 Revision History

Changes from Revision E (November 2014) to Revision F Page

- Editorial updates only; no technical changes

Changes from Revision D (February 2007) to Revision E Page

- Added *Pin Configuration and Functions* section, *ESD Ratings* table, *Feature Description* section, *Device Functional Modes*, *Application and Implementation* section, *Power Supply Recommendations* section, *Layout* section, *Device and Documentation Support* section, and *Mechanical, Packaging, and Orderable Information* section

5 Device Comparison Table

DEVICE	OUTPUT VOLTAGE	DEVICE	OUTPUT VOLTAGE	DEVICE	OUTPUT VOLTAGE
TPS54311	0.9 V	TPS54314	1.8 V	TPS54372	DDR/Adjustable
TPS54312	1.2 V	TPS54315	2.5 V	TPS54373	Prebias/Adjustable
TPS54313	1.5 V	TPS54316	3.3 V	TPS54380	Sequencing/Adjustable

6 Pin Configuration and Functions

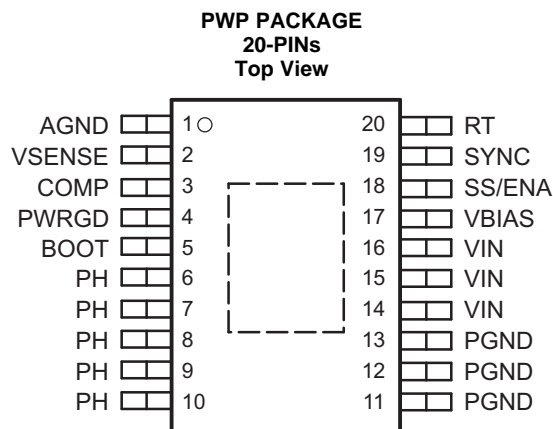

Pin Functions

PIN		DESCRIPTION
NAME	NO.	
AGND	1	Analog ground. Return for compensation network/output divider, slow-start capacitor, VBIAS capacitor, RT resistor and SYNC pin. Make PowerPAD connection to AGND.
BOOT	5	Bootstrap input. 0.022- μ F to 0.1- μ F low-ESR capacitor connected from BOOT to PH generates floating drive for the high-side FET driver.
COMP	3	Error amplifier output. Connect compensation network from COMP to VSENSE.
PGND	11–13	Power ground. High current return for the low-side driver and power MOSFET. Connect PGND with large copper areas to the input and output supply returns, and negative terminals of the input and output capacitors.
PH	6–10	Phase input/output. Junction of the internal high and low-side power MOSFETs, and output inductor.
PWRGD	4	Power good open drain output. High when VSENSE \geq 90% V_{ref} , otherwise PWRGD is low. Note that output is low when SS/ENA is low or internal shutdown signal active.
RT	20	Frequency setting resistor input. Connect a resistor from RT to AGND to set the switching frequency, f_s .
SS/ENA	18	Slow-start/enable input/output. Dual function pin which provides logic input to enable/disable device operation and capacitor input to externally set the start-up time.
SYNC	19	Synchronization input. Dual function pin which provides logic input to synchronize to an external oscillator or pin select between two internally set switching frequencies. When used to synchronize to an external signal, a resistor must be connected to the RT pin.
VBIAS	17	Internal bias regulator output. Supplies regulated voltage to internal circuitry. Bypass VBIAS pin to AGND pin with a high quality, low ESR 0.1- μ F to 1.0- μ F ceramic capacitor.
VIN	14–16	Input supply for the power MOSFET switches and internal bias regulator. Bypass VIN pins to PGND pins close to device package with a high quality, low ESR 1- μ F to 10- μ F ceramic capacitor.
VSENSE	2	Error amplifier inverting input.

7 Specifications

7.1 Absolute Maximum Ratings

over operating free-air temperature range (unless otherwise noted)⁽¹⁾

		MIN	MAX	UNIT
V _I Input voltage	VIN, SS/ENA, SYNC	-0.3	7	V
	RT	-0.3	6	V
	VSENSE	-0.3	4	V
	BOOT	-0.3	17	V
V _O Output voltage	VBIAS, PWRGD, COMP	-0.3	7	V
	PH	-0.6	10	V
I _O Output current	PH	Internally Limited		
	COMP, VBIAS		6	mA
Sink current	PH		6	A
	COMP		6	mA
	SS/ENA, PWRGD		10	mA
Voltage differential	AGND to PGND	-0.3	0.3	V
Continuous power dissipation		See Dissipation Ratings		
T _J Operating virtual junction temperature		-40	150	°C
T _{stg} Storage temperature		-65	150	°C

(1) Stresses beyond those listed under [Absolute Maximum Ratings](#) may cause permanent damage to the device. These are stress ratings only, and functional operation of the device at these or any other conditions beyond those indicated under [Recommended Operating Conditions](#) is not implied. Exposure to absolute-maximum-rated conditions for extended periods may affect device reliability.

7.2 ESD Ratings

		VALUE	UNIT
V _(ESD) Electrostatic discharge	Human-body model (HBM), per ANSI/ESDA/JEDEC JS-001 ⁽¹⁾	±2000	V
	Charged-device model (CDM), per JEDEC specification JESD22-C101 ⁽²⁾	±1500	

(1) JEDEC document JEP155 states that 500-V HBM allows safe manufacturing with a standard ESD control process.

(2) JEDEC document JEP157 states that 250-V CDM allows safe manufacturing with a standard ESD control process.

7.3 Recommended Operating Conditions

		MIN	MAX	UNIT
V _I Input voltage range		3	6	V
T _J Operating junction temperature		-40	125	°C

7.4 Thermal Information⁽¹⁾

THERMAL METRIC ⁽²⁾		TPS54310	UNIT
		PWP	
		20 PINS	
R _{θJA}	Junction-to-ambient thermal resistance	26	°C/W
R _{θJA}	Junction-to-ambient thermal resistance (without solder coverage on PowerPad)	57.5	°C/W

(1) Test board conditions:

- (a) 3 inch × 3 inch, 2 layers, Thickness: 0.062 inch
- (b) 1.5 oz copper traces located on the top of the PCB
- (c) 1.5 oz copper ground plane on the bottom of the PCB
- (d) Ten thermal vias (see recommended land pattern in application section of this data sheet)

(2) For more information about traditional and new thermal metrics, see the *IC Package Thermal Metrics* application report, [SPRA953](#).

7.5 Dissipation Ratings

over operating free-air temperature range (unless otherwise noted)^{(1) (2)}

PACKAGE	T _A = 25°C POWER RATING	T _A = 70°C POWER RATING	T _A = 85°C POWER RATING
20-Pin PWP with solder	3.85 W ⁽³⁾	2.12 W	1.54 W
20-Pin PWP without solder	1.73 W	0.96 W	0.69 W

- (1) For more information on the PWP package, refer to TI technical brief, literature number SLMA002.
- (2) Test board conditions:
 - (a) 3 inch × 3 inch, 2 layers, Thickness: 0.062 inch
 - (b) 1.5 oz copper traces located on the top of the PCB
 - (c) 1.5 oz copper ground plane on the bottom of the PCB
 - (d) Ten thermal vias (see recommended land pattern in application section of this data sheet)
- (3) Maximum power dissipation may be limited by overcurrent protection.

7.6 Electrical Characteristics

T_J = –40°C to 125°C, V_{IN} = 3 V to 6 V (unless otherwise noted)

PARAMETER		TEST CONDITIONS	MIN	TYP	MAX	UNIT
SUPPLY VOLTAGE, V_{IN}						
V _{IN} input voltage range			3		6	V
Quiescent current		f _s = 350 kHz, SYNC = 0.8 V, RT open		6.2	9.6	mA
		f _s = 550 kHz, SYNC ≥ 2.5 V, RT open, phase pin open		8.4	12.8	
		Shutdown, SS/ENA = 0 V		1	1.4	
UNDERVOLTAGE LOCK OUT						
Start threshold voltage, UVLO				2.95	3	V
Stop threshold voltage, UVLO			2.70	2.80		
Hysteresis voltage, UVLO			0.14	0.16		V
Rising and falling edge deglitch, UVLO ⁽¹⁾				2.5		μs
BIAS VOLTAGE						
V _O	Output voltage, VBIAS	I _(VBIAS) = 0	2.70	2.80	2.90	V
	Output current, VBIAS ⁽²⁾				100	μA
CUMULATIVE REFERENCE						
V _{ref}	Accuracy		0.882	0.891	0.900	V
REGULATION						
Line regulation ^{(1) (3)}		I _L = 1.5 A, f _s = 350 kHz, T _J = 85°C			0.07	%V
		I _L = 1.5 A, f _s = 550 kHz, T _J = 85°C			0.07	
Load regulation ^{(1) (3)}		I _L = 0 A to 3 A, f _s = 350 kHz, T _J = 85°C			0.03	%A
		I _L = 0 A to 3 A, f _s = 550 kHz, T _J = 85°C			0.03	
OSCILLATOR						
Internally set free-running frequency range		SYNC ≤ 0.8 V, RT open	280	350	420	kHz
		SYNC ≥ 2.5 V, RT open	440	550	660	
Externally set free-running frequency range		RT = 180 kΩ (1% resistor to AGND) ⁽¹⁾	252	280	308	kHz
		RT = 100 kΩ (1% resistor to AGND)	460	500	540	
		RT = 68 kΩ (1% resistor to AGND) ⁽¹⁾	663	700	762	
High-level threshold voltage, SYNC			2.5			V
Low-level threshold voltage, SYNC					0.8	V
Pulse duration, SYNC ⁽¹⁾			50			
Frequency range, SYNC ⁽¹⁾			330		700	kHz
Ramp valley ⁽¹⁾				0.75		V

- (1) Specified by the circuit used in [Figure 10](#).
- (2) Static resistive loads only
- (3) Specified by design

Electrical Characteristics (continued)
 $T_J = -40^{\circ}\text{C}$ to 125°C , $V_{IN} = 3\text{ V}$ to 6 V (unless otherwise noted)

PARAMETER	TEST CONDITIONS	MIN	TYP	MAX	UNIT
Ramp amplitude (peak-to-peak) ⁽¹⁾			1		V
Minimum controllable on time ⁽¹⁾				200	ns
Maximum duty cycle		90%			
ERROR AMPLIFIER					
Error amplifier open loop voltage gain	1 k Ω COMP to AGND ⁽¹⁾	90	110		dB
Error amplifier unity gain bandwidth	Parallel 10 k Ω , 160 pF COMP to AGND ⁽¹⁾	3	5		MHz
Error amplifier common-mode input voltage range	Powered by internal LDO ⁽¹⁾	0		VBIAS	V
I_{IB} Input bias current, VSENSE	VSENSE = V_{ref}		60	250	nA
V_O Output voltage slew rate (symmetric), COMP		1	1.4		V/ μ s
PWM COMPARATOR					
PWM comparator propagation delay time, PWM comparator input to PH pin (excluding dead time)	10 mV overdrive ⁽¹⁾		70	85	ns
SLOW-START/ENABLE					
Enable threshold voltage, SS/ENA		0.82	1.20	1.40	V
Enable hysteresis voltage, SS/ENA ⁽¹⁾			0.03		V
Falling edge deglitch, SS/ENA ⁽¹⁾			2.5		μ s
Internal slow-start time		2.6	3.35	4.1	ms
Charge current, SS/ENA	SS/ENA = 0 V	3	5	8	μ A
Discharge current, SS/ENA	SS/ENA = 0.2 V, $V_I = 2.7\text{ V}$	1.5	2.3	4	mA
POWER GOOD					
Power good threshold voltage	VSENSE falling		90		% V_{ref}
Power good hysteresis voltage ⁽⁴⁾			3		% V_{ref}
Power good falling edge deglitch ⁽⁴⁾			35		μ s
Output saturation voltage, PWRGD	$I_{(sink)} = 2.5\text{ mA}$		0.18	0.30	V
Leakage current, PWRGD	$V_I = 5.5\text{ V}$			1	μ A
CURRENT LIMIT					
Current limit trip point	$V_I = 3\text{ V}$, output shorted ⁽⁴⁾	4	6.5		A
	$V_I = 6\text{ V}$, output shorted ⁽⁴⁾	4.5	7.5		
Current limit leading edge blanking time ⁽⁴⁾			100		ns
Current limit total response time ⁽⁴⁾			200		ns
THERMAL SHUTDOWN					
Thermal shutdown trip point ⁽⁴⁾		135	150	165	$^{\circ}\text{C}$
Thermal shutdown hysteresis ⁽⁴⁾			10		$^{\circ}\text{C}$
OUTPUT POWER MOSFETS					
$r_{DS(on)}$ Power MOSFET switches	$I_O = 3\text{ A}$, $V_I = 6\text{ V}$ ⁽⁴⁾		59	88	m Ω
	$I_O = 3\text{ A}$, $V_I = 3\text{ V}$ ⁽⁵⁾		85	136	

(4) Matched MOSFETs, low side $r_{DS(on)}$ production tested, high side $r_{DS(on)}$ specified by design.

(5) Matched MOSFETs, low side $r_{DS(on)}$ production tested, high side $r_{DS(on)}$ specified by design.

7.7 Typical Characteristics

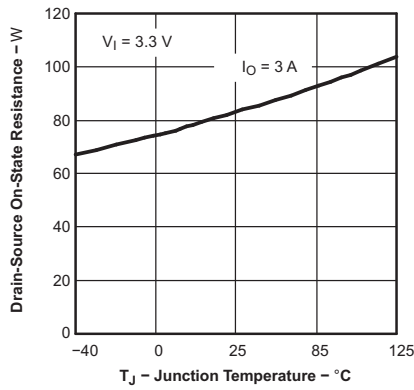

Figure 1. Drain-Source On-State Resistance vs Junction Temperature

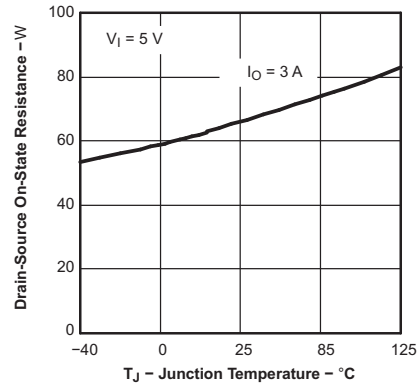

Figure 2. Drain-Source On-State Resistance vs Junction Temperature

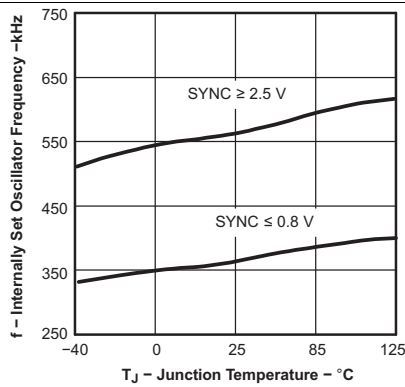

Figure 3. Internally Set Oscillator Frequency vs Junction Temperature

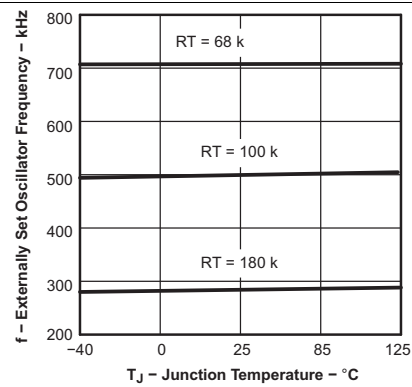

Figure 4. Externally Set Oscillator Frequency vs Junction Temperature

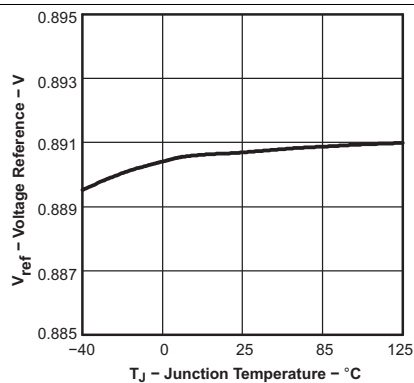

Figure 5. Voltage Reference vs Junction Temperature

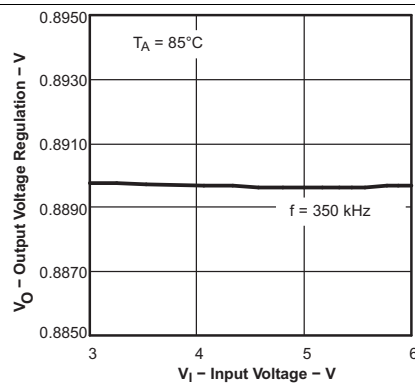

Figure 6. Output Voltage Regulation vs Input Voltage

Typical Characteristics (continued)

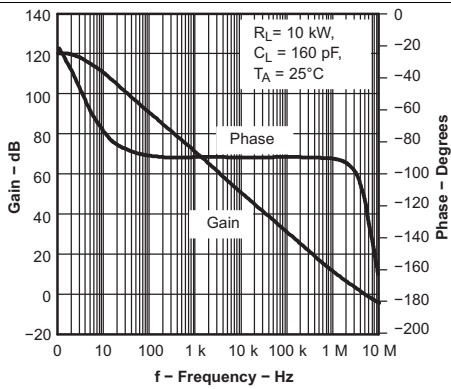

Figure 7. Error Amplifier Open Loop Response

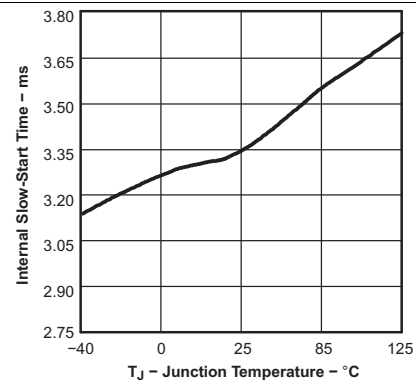

Figure 8. Internal Slow-Start Time vs Junction Temperature

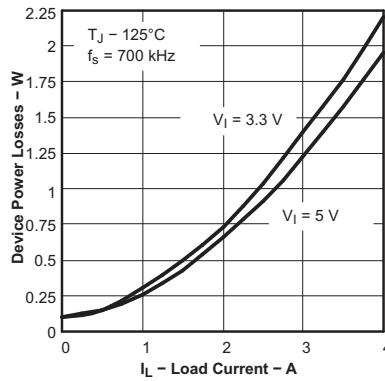

Figure 9. Device Power Losses vs Load Current

8 Detailed Description

8.1 Overview

The TPS54310 low-input-voltage high- output-current synchronous-buck PWM converter integrates all required active components. Included on the substrate with the listed features are a true, high performance, voltage error amplifier that provides high performance under transient conditions; an undervoltage-lockout circuit to prevent start-up until the input voltage reaches 3 V; an internally and externally set slow-start circuit to limit in-rush currents; and a power good output useful for processor/logic reset, fault signaling, and supply sequencing.

8.2 Functional Block Diagram

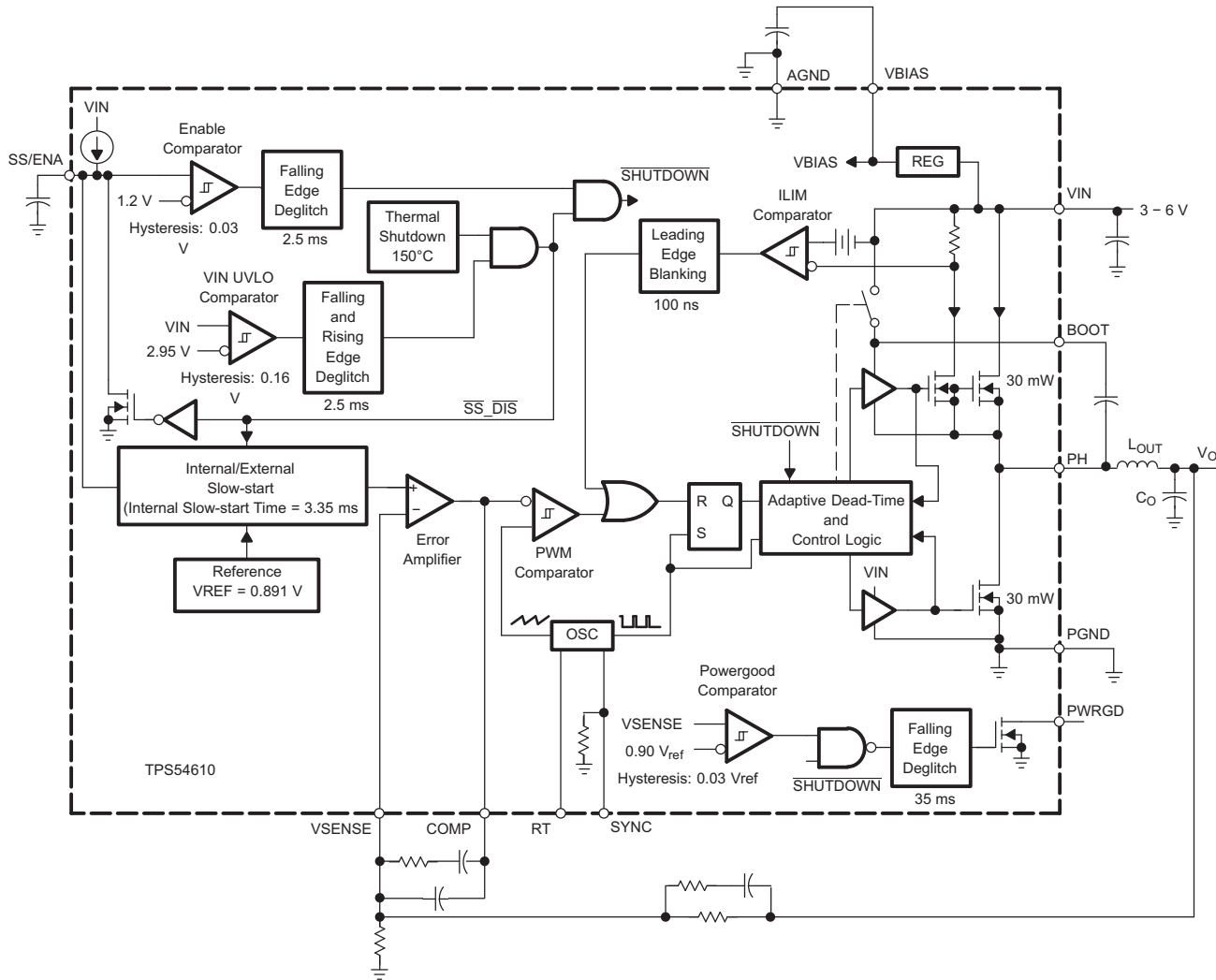

8.3 Feature Description

8.3.1 Undervoltage Lockout (UVLO)

The TPS54310 incorporates an undervoltage lockout circuit to keep the device disabled when the input voltage (V_{IN}) is insufficient. During power up, internal circuits are held inactive until V_{IN} exceeds the nominal UVLO threshold voltage of 2.95 V. Once the UVLO start threshold is reached, device start-up begins. The device operates until V_{IN} falls below the nominal UVLO stop threshold of 2.8 V. Hysteresis in the UVLO comparator, and a 2.5- μ s rising and falling edge deglitch circuit reduce the likelihood of shutting the device down due to noise on V_{IN} .

Feature Description (continued)

8.3.2 Slow Start and Enable (SS/ENA)

The slow-start and enable pin provide two functions; first, the pin act as an enable (shutdown) control by keeping the device turned off until the voltage exceeds the start threshold voltage of approximately 1.2 V. When SS/ENA exceeds the enable threshold, device start-up begins. The reference voltage fed to the error amplifier is linearly ramped up from 0 V to 0.891 V in 3.35 ms. Similarly, the converter output voltage reaches regulation in approximately 3.35 ms. Voltage hysteresis and a 2.5- μ s falling edge deglitch circuit reduce the likelihood of triggering the enable due to noise.

The second function of the SS/ENA pin provides an external means of extending the slow-start time with a low-value capacitor connected between SS/ENA and AGND. Adding a capacitor to the SS/ENA pin has two effects on start-up. First, a delay occurs between release of the SS/ENA pin and start up of the output. The delay is proportional to the slow-start capacitor value and lasts until the SS/ENA pin reaches the enable threshold. The start-up delay is approximately:

$$t_d = C_{(SS)} \times \frac{1.2 \text{ V}}{5 \mu\text{A}} \quad (1)$$

Second, as the output becomes active, a brief ramp-up at the internal slow-start rate may be observed before the externally set slow-start rate takes control and the output rises at a rate proportional to the slow-start capacitor. The slow-start time set by the capacitor is approximately:

$$t_{(SS)} = C_{(SS)} \times \frac{0.7 \text{ V}}{5 \mu\text{A}} \quad (2)$$

The actual slow-start is likely to be less than the above approximation due to the brief ramp-up at the internal rate.

8.3.3 VBIAS Regulator (VBIAS)

The VBIAS regulator provides internal analog and digital blocks with a stable supply voltage over variations in junction temperature and input voltage. A high quality, low-ESR, ceramic bypass capacitor is required on the VBIAS pin. X7R or X5R grade dielectrics are recommended because their values are more stable over temperature. The bypass capacitor should be placed close to the BVIAS pin and returned to AGND. External loading on VBIAS is allowed, with the caution that internal circuits require a minimum BVIAS of 2.7 V, and external loads on VBIAS with ac or digital switching noise may degrade performance. The VBIAS pin may be useful as a reference voltage for external circuits.

8.3.4 Voltage Reference

The voltage reference system produces a precise V_{ref} signal by scaling the output of a temperature stable bandgap circuit. During manufacture, the bandgap and scaling circuits are trimmed to produce 0.891 V at the output of the error amplifier, with the amplifier connected as a voltage follower. The trim procedure adds to the high precision regulation of the TPS54310, because it cancels offset errors in the scale and error amplifier circuits

8.3.5 Oscillator and PWM Ramp

The oscillator frequency can be set to internally fixed values of 350 kHz or 550 kHz using the SYNC pin as a static digital input. If a different frequency of operation is required for the application, the oscillator frequency can be externally adjusted from 280 kHz to 700 kHz by connecting a resistor to the RT pin to ground and floating the SYNC pin. The switching frequency is approximated by the following equation, where R is the resistance from RT to AGND:

$$\text{SWITCHING FREQUENCY} = \frac{100 \text{ k}\Omega}{R} \times 500 \text{ kHz} \quad (3)$$

External synchronization of the PWM ramp is possible over the frequency range of 330 kHz to 700 kHz by driving a synchronization signal into SYNC and connecting a resistor from RT to AGND. Choose an RT resistor that sets the free-running frequency to 80% of the synchronization signal. [Table 1](#) summarizes the frequency selection configurations.

Feature Description (continued)

Table 1. Summary of the Frequency Selection Configurations

SWITCHING FREQUENCY	SYNC PIN	RT PIN
350 kHz, internally set	Float or AGND	Float
550 kHz, internally set	≥ 2.5 V	Float
Externally set 280 kHz to 700 kHz	Float	R = 68 k to 180 k
Externally synchronized frequency	Synchronization signal	R = RT value for 80% of external synchronization frequency

8.3.6 Error Amplifier

The high performance, wide bandwidth, voltage error amplifier sets the TPS54310 apart from most dc/dc converters. The user is given the flexibility to use a wide range of output L and C filter components to suit the particular needs of the application. Type 2 or type 3 compensation can be employed using external compensation components.

8.3.7 PWM Control

Signals from the error amplifier output, oscillator, and current limit circuit are processed by the PWM control logic. Referring to the internal block diagram, the control logic includes the PWM comparator, OR gate, PWM latch, and portions of the adaptive dead-time and control logic block. During steady-state operation below the current limit threshold, the PWM comparator output and oscillator pulse train alternately reset and set the PWM latch. Once the PWM latch is set, the low-side FET remains on for a minimum duration set by the oscillator pulse duration. During this period, the PWM ramp discharges rapidly to its valley voltage. When the ramp begins to charge back up, the low-side FET turns off and high-side FET turns on. As the PWM ramp voltage exceeds the error amplifier output voltage, the PWM comparator resets the latch, thus turning off the high-side FET and turning on the low-side FET. The low-side FET remains on until the next oscillator pulse discharges the PWM ramp.

During transient conditions, the error amplifier output could be below the PWM ramp valley voltage or above the PWM peak voltage. If the error amplifier is high, the PWM latch is never reset and the high-side FET remains on until the oscillator pulse signals the control logic to turn the high-side FET off and the low-side FET on. The device operates at its maximum duty cycle until the output voltage rises to the regulation set-point, setting VSENSE to approximately the same voltage as V_{ref} . If the error amplifier output is low, the PWM latch is continually reset and the high-side FET does not turn on. The low-side FET remains on until the VSENSE voltage decreases to a range that allows the PWM comparator to change states. The TPS54310 is capable of sinking current continuously until the output reaches the regulation set-point.

If the current limit comparator trips for longer than 100 ns, the PWM latch resets before the PWM ramp exceeds the error amplifier output. The high-side FET turns off and low-side FET turns on to decrease the energy in the output inductor and consequently the output current. This process is repeated each cycle in which the current limit comparator is tripped.

8.3.8 Dead-Time Control and MOSFET Drivers

Adaptive dead-time control prevents shoot-through current from flowing in both N-channel power MOSFETs during the switching transitions by actively controlling the turn-on times of the MOSFET drivers. The high-side driver does not turn on until the gate drive voltage to the low-side FET is below 2 V. The low-side driver does not turn on until the voltage at the gate of the high-side MOSFETs is below 2 V. The high-side and low-side drivers are designed with 300-mA source and sink capability to quickly drive the power MOSFETs gates. The low-side driver is supplied from VIN, while the high-side drive is supplied from the BOOT pin. A bootstrap circuit uses an external BOOT capacitor and an internal 2.5- Ω bootstrap switch connected between the VIN and BOOT pins. The integrated bootstrap switch improves drive efficiency and reduces external component count.

8.3.9 Overcurrent Protection

The cycle by cycle current limiting is achieved by sensing the current flowing through the high-side MOSFET and differential amplifier and comparing it to the preset overcurrent threshold. The high-side MOSFET is turned off within 200 ns of reaching the current limit threshold. A 100-ns leading edge blanking circuit prevents false tripping of the current limit. Current limit detection occurs only when current flows from VIN to PH when sourcing current to the output filter. Load protection during current sink operation is provided by thermal shutdown.

8.3.10 Thermal Shutdown

The device uses the thermal shutdown to turn off the power MOSFETs and disable the controller if the junction temperature exceeds 150°C. The device is released from shutdown when the junction temperature decreases to 10°C below the thermal shutdown trip point and starts up under control of the slow-start circuit. Thermal shutdown provides protection when an overload condition is sustained for several milliseconds. With a persistent fault condition, the device cycles continuously; starting up by control of the soft-start circuit, heating up due to the fault, and then shutting down upon reaching the thermal shutdown point.

8.3.11 Powergood (PWRGD)

The powergood circuit monitors for undervoltage conditions on VSENSE. If the voltage on VSENSE is 10% below the reference voltage, the open-drain PWRGD output is pulled low. PWRGD is also pulled low if VIN is less than the UVLO threshold, or SS/ENA is low, or thermal shutdown is asserted. When VIN = UVLO threshold, SS/ENA = enable threshold, and VSENSE > 90% of V_{ref}, the open-drain output of the PWRGD pin is high. A hysteresis voltage equal to 3% of V_{ref} and a 35-μs falling edge deglitch circuit prevent tripping of the powergood comparator due to high-frequency noise.

8.4 Device Functional Modes

8.4.1 Continuous Conduction Mode

The TPS54310 operates in continuous conduction mode, that is, the low-side MOSFET runs fully complimentary to the high-side MOSFET regardless of output current.

8.4.2 Switching Frequency Configuration

Depending on the configuration of the RT and SYNC pins, the TPS54310 can be configured to switch at 350 kHz, or 550 kHz without external components, or any frequency between 280 kHz and 700 kHz as configured by a resistor from the RT pin to ground. The TPS54310 can also be synchronized to an external clock using the SYNC pin. See [Table 1](#) for more information.

9 Application and Implementation

NOTE

Information in the following applications sections is not part of the TI component specification, and TI does not warrant its accuracy or completeness. TI's customers are responsible for determining suitability of components for their purposes. Customers should validate and test their design implementation to confirm system functionality.

9.1 Application Information

The TPS54310 is a 3-V to 6-V integrated FET synchronous buck converter. It is used to convert a DC input voltage on the VIN pins to a lower output voltage at 3 A maximum output current.

9.2 Typical Application

Figure 10 shows the schematic diagram for a typical TPS54310 application. The TPS54310 (U1) can provide up to 3 A of output current at a nominal output voltage of 3.3 V. For proper thermal performance, the power pad underneath the TPS54310 integrated circuit needs to be soldered well to the printed-circuit board.

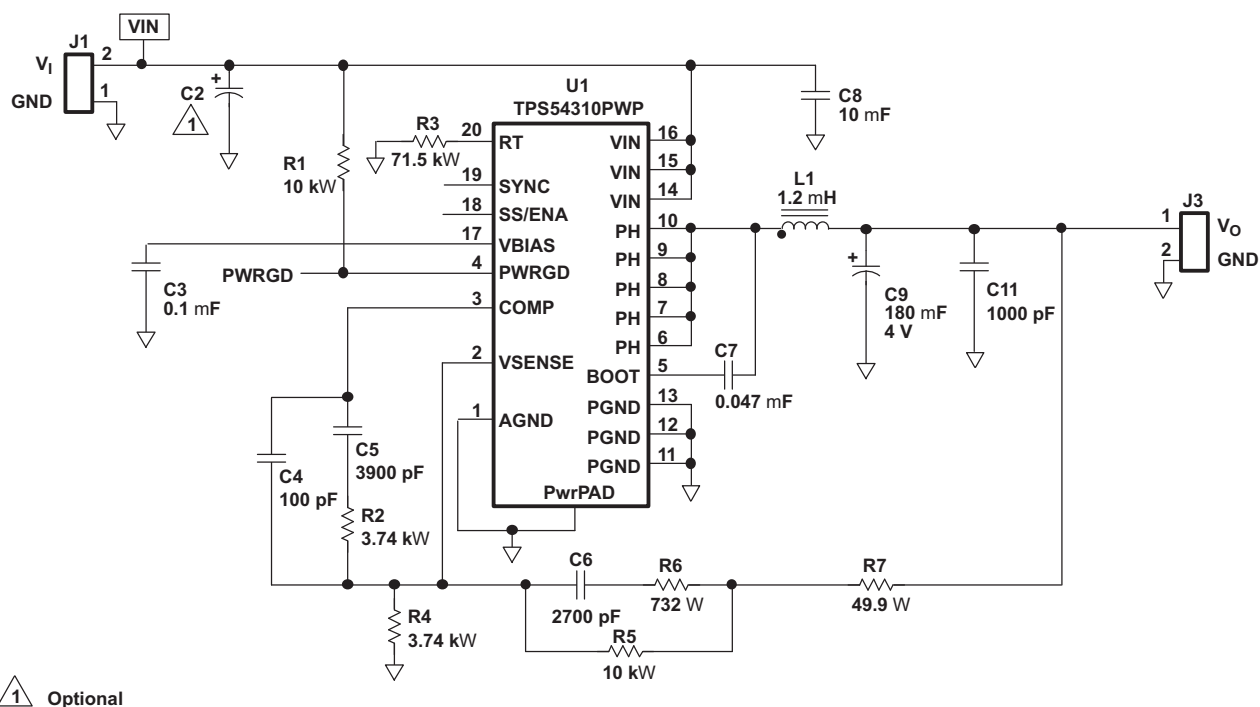

Figure 10. TPS54310 Schematic

9.2.1 Design Requirements

Design requirements for this example are as follows:

- DC input voltage: 3 V – 6 V
- DC output current: 0 A – 3 A
- Load regulation: $\pm 0.5\%$
- Output voltage ripple: 30 mV
- Input voltage ripple: 150 mV

Typical Application (continued)

9.2.2 Detailed Design Procedure

9.2.2.1 Input Voltage

The input to the circuit is a nominal 5 VDC, applied at J1. The optional input filter (C2) is a 220- μ F POSCAP capacitor, with a maximum allowable ripple current of 3 A. C8 is the decoupling capacitor for the TPS54310 and must be located as close to the device as possible.

9.2.2.2 Feedback Circuit

The resistor divider network of R5 and R4 sets the output voltage for the circuit at 3.3 V. R5, along with R2, R6, C4, C5, and C6 forms the loop compensation network for the circuit. For this design, a Type 3 topology is used.

9.2.2.3 Setting the Output Voltage

The output voltage of the TPS54310 can be set by feeding back a portion of the output to the VSENSE pin using a resistor divider network. In the application circuit of [Figure 10](#), this divider network is comprised of resistors R5 and R4. To calculate the resistor values to generate the required output voltage use [Equation 4](#).

$$R4 = \frac{R5 \times 0.891}{V_O - 0.891} \quad (4)$$

Start with a fixed value of R5 and calculate the required R4 value. Assuming a fixed value of 10 k Ω for R5, the following table gives the appropriate R4 value for several common output voltages:

Table 2. R4 Values for Common Output Voltages

OUTPUT VOLTAGE (V)	R4 VALUE (K Ω)
1.2	28.7
1.5	14.7
1.8	9.76
2.5	5.49
3.3	3.74

9.2.2.4 Operating Frequency

In the application circuit, the 350-kHz operation is selected by leaving RT and SYNC open. Connecting a 68-k Ω to 180-k Ω resistor between RT (pin 20) and analog ground can be used to set the switching frequency from 280 kHz to 700 kHz. To calculate the RT resistor, use the [Equation 5](#):

$$R = \frac{100 \text{ k}\Omega}{f_{SW}} \times 500 \text{ kHz} \quad (5)$$

9.2.2.5 Output Filter

The output filter is composed of a 1.2- μ H inductor and 180- μ F capacitor. The inductor is a low dc resistance (0.017 Ω) type, Coilcraft DO1813P-122HC. The capacitor used is a 4-V special polymer type with a maximum ESR of 0.015 Ω . The feedback loop is compensated so that the unity gain frequency is approximately 75 kHz.

9.2.3 Application Curves

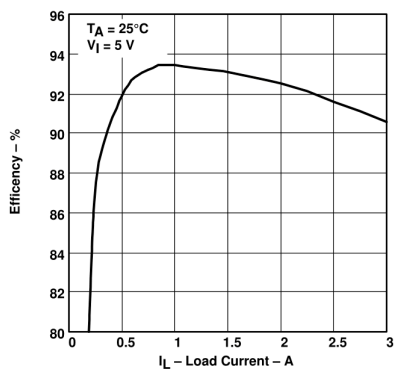

Figure 11. Efficiency vs. Load Current

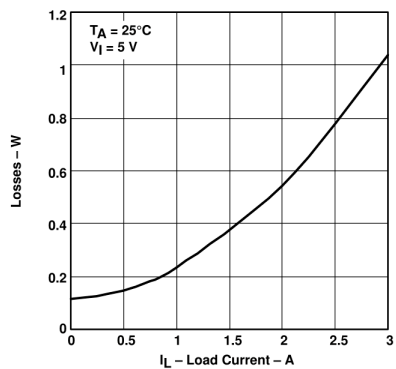

Figure 12. Power Loss vs. Load Current

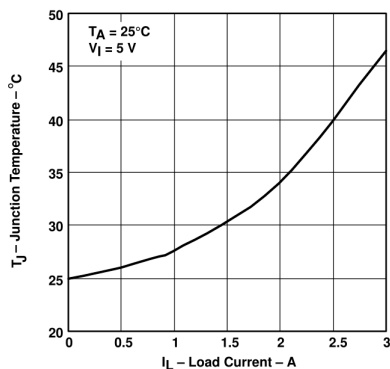

Figure 13. Junction Temperature vs. Load Current

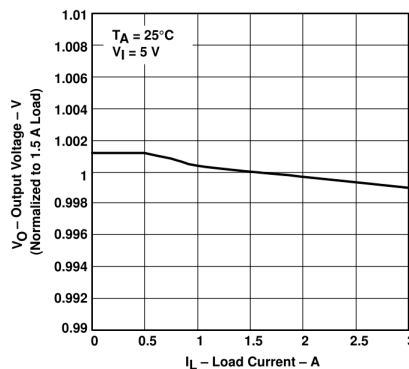

Figure 14. Load Regulation

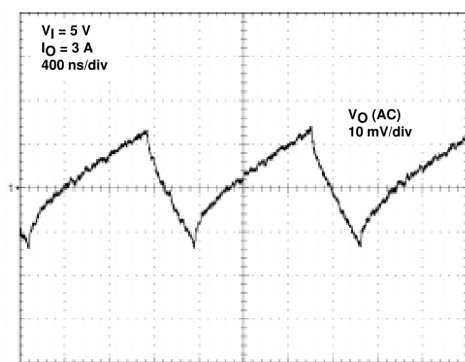

Figure 15. Output Voltage Ripple

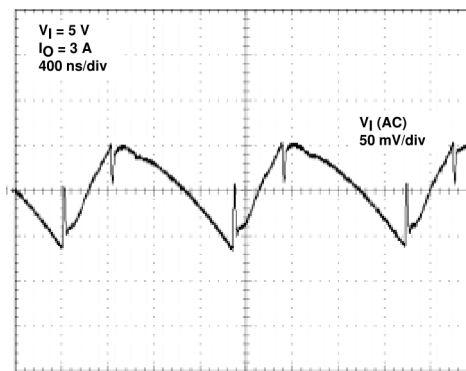

Figure 16. Input Voltage Ripple

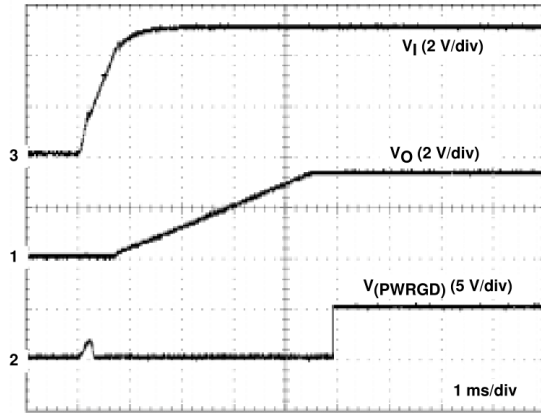

Figure 17. Start-Up From VIN

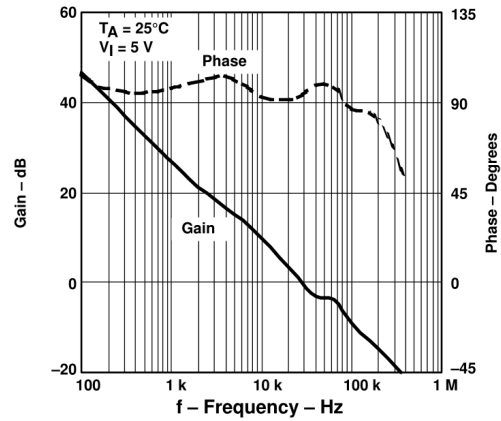

Figure 18. System Bode Plot

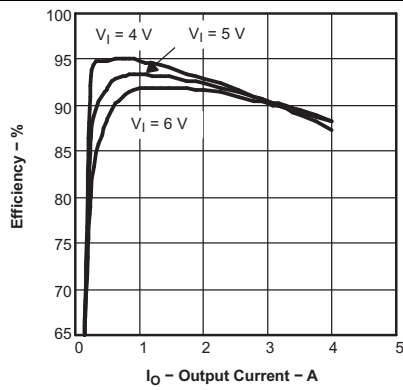

Figure 19. Efficiency vs Output Current

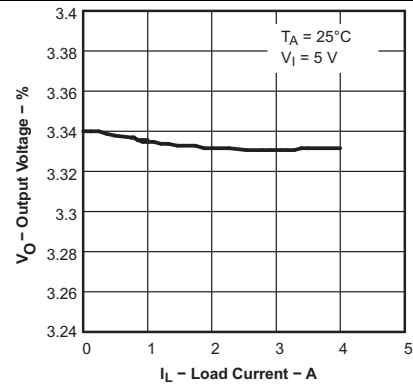

Figure 20. Output Voltage vs Load Current

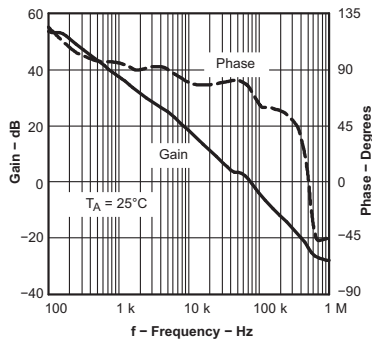

Figure 21. Loop Response

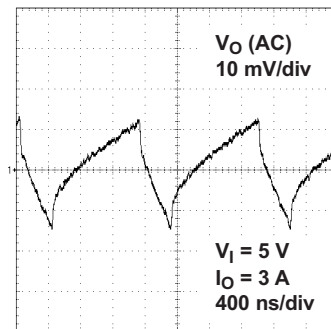

Figure 22. Output Ripple Voltage

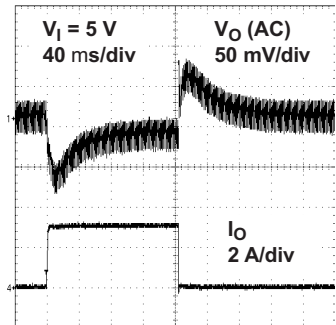

Figure 23. Load Transient Response

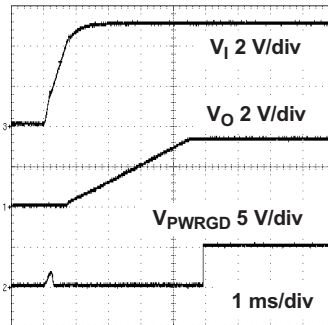
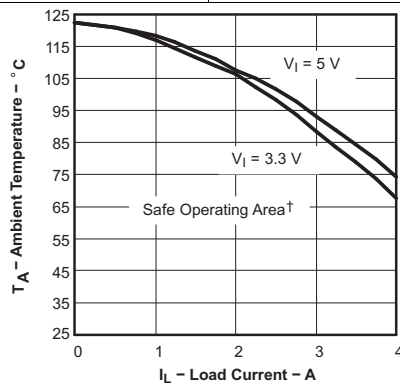

Figure 24. Slow-Start Timing



† Safe operating area is applicable to the test board conditions listed in the dissipation rating table section of this data sheet.

Figure 25. Ambient Temperature vs Load Current

10 Power Supply Recommendations

The TPS54310 is designed to operate from an input supply from 3 V to 6 V on the VIN pins. This supply must be well regulated and properly bypassed for proper operation of the TPS54310. Additionally, the VBIAS pin must have good local bypassing for noise performance. See the recommendations in [Pin Configuration and Functions](#) and [Layout Guidelines](#) for more information.

11 Layout

11.1 Layout Guidelines

[Figure 26](#) shows a generalized PCB layout guide for the TPS54310.

The VIN pins should be connected together on the printed circuit board (PCB) and bypassed with a low ESR ceramic bypass capacitor. Care should be taken to minimize the loop area formed by the bypass capacitor connections, the VIN pins, and the TPS54X10 ground pins. The minimum recommended bypass capacitance is 10- μ F ceramic with a X5R or X7R dielectric and the optimum placement is closest to the VIN pins and the PGND pins.

The TPS54310 has two internal grounds (analog and power). Inside the TPS54310, the analog ground ties to all of the noise sensitive signals, while the power ground ties to the noisier power signals. Noise injected between the two grounds can degrade the performance of the TPS54310, particularly at higher output currents. Ground noise on an analog ground plane can also cause problems with some of the control and bias signals. For these reasons, separate analog and power ground traces are recommended. There should be an area of ground on the top layer directly under the IC, with an exposed area for connection to the PowerPAD. Use vias to connect this ground area to any internal ground planes. Use additional vias at the ground side of the input and output filter capacitors as well. The AGND and PGND pins should be tied to the PCB ground by connecting them to the ground area under the device as shown. The only components that should tie directly to the power ground plane are the input capacitors, the output capacitors, the input voltage decoupling capacitor, and the PGND pins of the TPS54310. Use a separate wide trace for the analog ground signal path. This analog ground should be used for the voltage set point divider, timing resistor RT, slow start capacitor and bias capacitor grounds. Connect this trace directly to AGND (pin 1).

The PH pins should be tied together and routed to the output inductor. Since the PH connection is the switching node, inductor should be located very close to the PH pins and the area of the PCB conductor minimized to prevent excessive capacitive coupling.

Connect the boot capacitor between the phase node and the BOOT pin as shown. Keep the boot capacitor close to the IC and minimize the conductor trace lengths.

Connect the output filter capacitor(s) as shown between the VOUT trace and PGND. It is important to keep the loop formed by the PH pins, Lout, Cout and PGND as small as practical.

Place the compensation components from the VOUT trace to the VSENSE and COMP pins. Do not place these components too close to the PH trace. Due to the size of the IC package and the device pinout, they will have to be routed somewhat close, but maintain as much separation as possible while still keeping the layout compact.

Connect the bias capacitor from the VBIAS pin to analog ground using the isolated analog ground trace. If a slow-start capacitor or RT resistor is used, or if the SYNC pin is used to select 350-kHz operating frequency, connect them to this trace as well.

For operation at full rated load current, the analog ground plane must provide adequate heat dissipating area. A 3 inch by 3 inch plane of 1 ounce copper is recommended, though not mandatory, depending on ambient temperature and airflow. Most applications have larger areas of internal ground plane available, and the PowerPAD should be connected to the largest area available. Additional areas on the top or bottom layers also help dissipate heat, and any area available should be used when 3 A or greater operation is desired. Connection from the exposed area of the PowerPAD to the analog ground plane layer should be made using 0.013 inch diameter vias to avoid solder wicking through the vias. Six vias should be in the PowerPAD area with four additional vias located under the device package. The size of the vias under the package, but not in the exposed thermal pad area, can be increased to 0.018. Additional vias beyond the ten recommended that enhance thermal performance should be included in areas not under the device package.

12 Device and Documentation Support

12.1 Related DC/DC Products

- TPS40000—dc/dc controller
- PT5500 series—3-A plug-in modules
- TPS757XX—3-A low dropout regulator

12.2 Receiving Notification of Documentation Updates

To receive notification of documentation updates, navigate to the device product folder on ti.com. In the upper right corner, click on *Alert me* to register and receive a weekly digest of any product information that has changed. For change details, review the revision history included in any revised document.

12.3 Community Resources

The following links connect to TI community resources. Linked contents are provided "AS IS" by the respective contributors. They do not constitute TI specifications and do not necessarily reflect TI's views; see TI's [Terms of Use](#).

TI E2E™ Online Community *TI's Engineer-to-Engineer (E2E) Community*. Created to foster collaboration among engineers. At e2e.ti.com, you can ask questions, share knowledge, explore ideas and help solve problems with fellow engineers.

Design Support *TI's Design Support* Quickly find helpful E2E forums along with design support tools and contact information for technical support.

12.4 Trademarks

PowerPAD, E2E are trademarks of Texas Instruments.
All other trademarks are the property of their respective owners.

12.5 Electrostatic Discharge Caution



These devices have limited built-in ESD protection. The leads should be shorted together or the device placed in conductive foam during storage or handling to prevent electrostatic damage to the MOS gates.

12.6 Glossary

[SLYZ022](#) — *TI Glossary*.

This glossary lists and explains terms, acronyms, and definitions.

13 Mechanical, Packaging, and Orderable Information

The following pages include mechanical, packaging, and orderable information. This information is the most current data available for the designated devices. This data is subject to change without notice and revision of this document. For browser-based versions of this data sheet, refer to the left-hand navigation.

PACKAGING INFORMATION

Orderable Device	Status (1)	Package Type	Package Drawing	Pins	Package Qty	Eco Plan (2)	Lead finish/ Ball material (6)	MSL Peak Temp (3)	Op Temp (°C)	Device Marking (4/5)	Samples
TPS54310PWPR	ACTIVE	HTSSOP	PWP	20	2000	RoHS & Green	NIPDAU	Level-2-260C-1 YEAR	-40 to 125	TPS54310	Samples
TPS54310PWPRG4	ACTIVE	HTSSOP	PWP	20	2000	RoHS & Green	NIPDAU	Level-2-260C-1 YEAR	-40 to 125	TPS54310	Samples

(1) The marketing status values are defined as follows:

ACTIVE: Product device recommended for new designs.

LIFEBUY: TI has announced that the device will be discontinued, and a lifetime-buy period is in effect.

NRND: Not recommended for new designs. Device is in production to support existing customers, but TI does not recommend using this part in a new design.

PREVIEW: Device has been announced but is not in production. Samples may or may not be available.

OBSOLETE: TI has discontinued the production of the device.

(2) **RoHS:** TI defines "RoHS" to mean semiconductor products that are compliant with the current EU RoHS requirements for all 10 RoHS substances, including the requirement that RoHS substance do not exceed 0.1% by weight in homogeneous materials. Where designed to be soldered at high temperatures, "RoHS" products are suitable for use in specified lead-free processes. TI may reference these types of products as "Pb-Free".

RoHS Exempt: TI defines "RoHS Exempt" to mean products that contain lead but are compliant with EU RoHS pursuant to a specific EU RoHS exemption.

Green: TI defines "Green" to mean the content of Chlorine (Cl) and Bromine (Br) based flame retardants meet JS709B low halogen requirements of <=1000ppm threshold. Antimony trioxide based flame retardants must also meet the <=1000ppm threshold requirement.

(3) MSL, Peak Temp. - The Moisture Sensitivity Level rating according to the JEDEC industry standard classifications, and peak solder temperature.

(4) There may be additional marking, which relates to the logo, the lot trace code information, or the environmental category on the device.

(5) Multiple Device Markings will be inside parentheses. Only one Device Marking contained in parentheses and separated by a "~" will appear on a device. If a line is indented then it is a continuation of the previous line and the two combined represent the entire Device Marking for that device.

(6) Lead finish/Ball material - Orderable Devices may have multiple material finish options. Finish options are separated by a vertical ruled line. Lead finish/Ball material values may wrap to two lines if the finish value exceeds the maximum column width.

Important Information and Disclaimer:The information provided on this page represents TI's knowledge and belief as of the date that it is provided. TI bases its knowledge and belief on information provided by third parties, and makes no representation or warranty as to the accuracy of such information. Efforts are underway to better integrate information from third parties. TI has taken and continues to take reasonable steps to provide representative and accurate information but may not have conducted destructive testing or chemical analysis on incoming materials and chemicals. TI and TI suppliers consider certain information to be proprietary, and thus CAS numbers and other limited information may not be available for release.

In no event shall TI's liability arising out of such information exceed the total purchase price of the TI part(s) at issue in this document sold by TI to Customer on an annual basis.

OTHER QUALIFIED VERSIONS OF TPS54310 :

- Enhanced Product : [TPS54310-EP](#)

NOTE: Qualified Version Definitions:

- Enhanced Product - Supports Defense, Aerospace and Medical Applications

TAPE AND REEL INFORMATION

QUADRANT ASSIGNMENTS FOR PIN 1 ORIENTATION IN TAPE

*All dimensions are nominal

Device	Package Type	Package Drawing	Pins	SPQ	Reel Diameter (mm)	Reel Width W1 (mm)	A0 (mm)	B0 (mm)	K0 (mm)	P1 (mm)	W (mm)	Pin1 Quadrant
TPS54310PWPR	HTSSOP	PWP	20	2000	330.0	16.4	6.95	7.1	1.6	8.0	16.0	Q1

TAPE AND REEL BOX DIMENSIONS



*All dimensions are nominal

Device	Package Type	Package Drawing	Pins	SPQ	Length (mm)	Width (mm)	Height (mm)
TPS54310PWPR	HTSSOP	PWP	20	2000	350.0	350.0	43.0

MECHANICAL DATA

PWP (R-PDSO-G20)

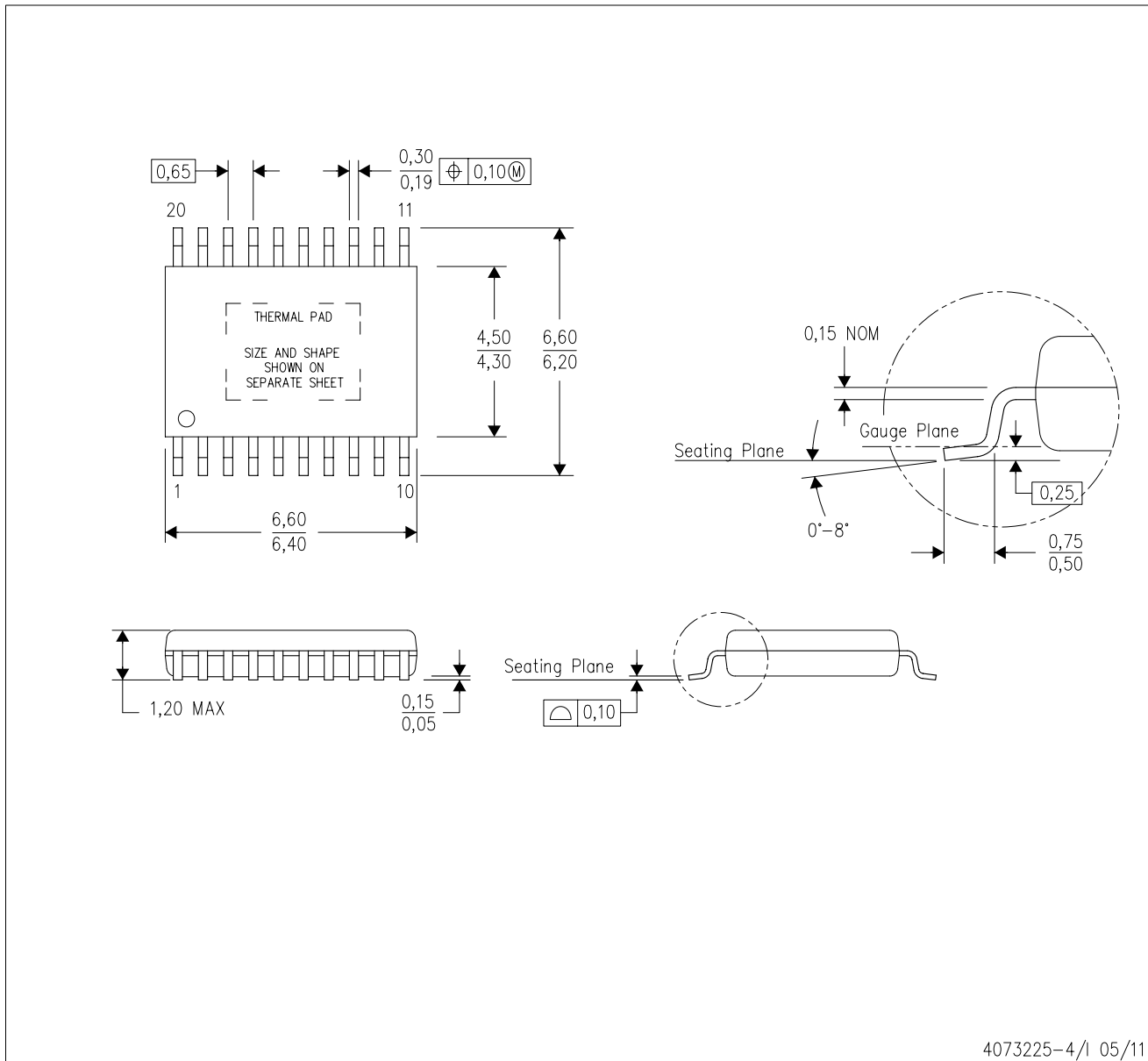
PowerPAD™ PLASTIC SMALL OUTLINE



4073225-4/1 05/11

- NOTES:
- All linear dimensions are in millimeters.
 - This drawing is subject to change without notice.
 - Body dimensions do not include mold flash or protrusions. Mold flash and protrusion shall not exceed 0.15 per side.
 - This package is designed to be soldered to a thermal pad on the board. Refer to Technical Brief, PowerPad Thermally Enhanced Package, Texas Instruments Literature No. SLMA002 for information regarding recommended board layout. This document is available at www.ti.com <<http://www.ti.com>>.
 - See the additional figure in the Product Data Sheet for details regarding the exposed thermal pad features and dimensions.
 - Falls within JEDEC MO-153

PowerPAD is a trademark of Texas Instruments.

THERMAL PAD MECHANICAL DATA

PWP (R-PDSO-G20) PowerPAD™ SMALL PLASTIC OUTLINE

THERMAL INFORMATION

This PowerPAD™ package incorporates an exposed thermal pad that is designed to be attached to a printed circuit board (PCB). The thermal pad must be soldered directly to the PCB. After soldering, the PCB can be used as a heatsink. In addition, through the use of thermal vias, the thermal pad can be attached directly to the appropriate copper plane shown in the electrical schematic for the device, or alternatively, can be attached to a special heatsink structure designed into the PCB. This design optimizes the heat transfer from the integrated circuit (IC).

For additional information on the PowerPAD package and how to take advantage of its heat dissipating abilities, refer to Technical Brief, PowerPAD Thermally Enhanced Package, Texas Instruments Literature No. SLMA002 and Application Brief, PowerPAD Made Easy, Texas Instruments Literature No. SLMA004. Both documents are available at www.ti.com.

The exposed thermal pad dimensions for this package are shown in the following illustration.



Top View

Exposed Thermal Pad Dimensions

4206332-15/AO 01/16

NOTE: A. All linear dimensions are in millimeters

 Exposed tie strap features may not be present.

PowerPAD is a trademark of Texas Instruments

PWP (R-PDSO-G20)

PowerPAD™ PLASTIC SMALL OUTLINE



- NOTES:
- All linear dimensions are in millimeters.
 - This drawing is subject to change without notice.
 - Customers should place a note on the circuit board fabrication drawing not to alter the center solder mask defined pad.
 - This package is designed to be soldered to a thermal pad on the board. Refer to Technical Brief, PowerPad Thermally Enhanced Package, Texas Instruments Literature No. SLMA002, SLMA004, and also the Product Data Sheets for specific thermal information, via requirements, and recommended board layout. These documents are available at www.ti.com <<http://www.ti.com>>. Publication IPC-7351 is recommended for alternate designs.
 - Laser cutting apertures with trapezoidal walls and also rounding corners will offer better paste release. Customers should contact their board assembly site for stencil design recommendations. Example stencil design based on a 50% volumetric metal load solder paste. Refer to IPC-7525 for other stencil recommendations.
 - Customers should contact their board fabrication site for solder mask tolerances between and around signal pads.

IMPORTANT NOTICE AND DISCLAIMER

TI PROVIDES TECHNICAL AND RELIABILITY DATA (INCLUDING DATA SHEETS), DESIGN RESOURCES (INCLUDING REFERENCE DESIGNS), APPLICATION OR OTHER DESIGN ADVICE, WEB TOOLS, SAFETY INFORMATION, AND OTHER RESOURCES "AS IS" AND WITH ALL FAULTS, AND DISCLAIMS ALL WARRANTIES, EXPRESS AND IMPLIED, INCLUDING WITHOUT LIMITATION ANY IMPLIED WARRANTIES OF MERCHANTABILITY, FITNESS FOR A PARTICULAR PURPOSE OR NON-INFRINGEMENT OF THIRD PARTY INTELLECTUAL PROPERTY RIGHTS.

These resources are intended for skilled developers designing with TI products. You are solely responsible for (1) selecting the appropriate TI products for your application, (2) designing, validating and testing your application, and (3) ensuring your application meets applicable standards, and any other safety, security, regulatory or other requirements.

These resources are subject to change without notice. TI grants you permission to use these resources only for development of an application that uses the TI products described in the resource. Other reproduction and display of these resources is prohibited. No license is granted to any other TI intellectual property right or to any third party intellectual property right. TI disclaims responsibility for, and you will fully indemnify TI and its representatives against, any claims, damages, costs, losses, and liabilities arising out of your use of these resources.

TI's products are provided subject to [TI's Terms of Sale](#) or other applicable terms available either on [ti.com](https://www.ti.com) or provided in conjunction with such TI products. TI's provision of these resources does not expand or otherwise alter TI's applicable warranties or warranty disclaimers for TI products.

TI objects to and rejects any additional or different terms you may have proposed.

Mailing Address: Texas Instruments, Post Office Box 655303, Dallas, Texas 75265
Copyright © 2023, Texas Instruments Incorporated