

TMAG5273 Low-Power Linear 3D Hall-Effect Sensor With I²C Interface

1 Features

- Configurable power modes including:
 - 2.3mA active mode current
 - 1µA wake-up and sleep mode current
 - 5nA sleep mode current
- Selectable linear magnetic range at X, Y, or Z axis:
 - TMAG5273x1: ±40mT, ±80mT
 - TMAG5273x2: ±133mT, ±266mT
- Interrupt signal from user-defined magnetic and temperature threshold cross
- 5% (typical) sensitivity drift
- Integrated angle CORDIC calculation with gain and offset adjustment
- 20kSPS single axis conversion rate
- Configurable averaging up to 32x for noise reduction
- Conversion trigger by I²C or dedicated $\overline{\text{INT}}$ pin
- Optimized I²C interface with cyclic redundancy check (CRC):
 - Maximum 1-MHz I²C clock speed
 - Special I²C frame reads for improved throughput
 - Factory-programmed and user-configurable I²C addresses
- Integrated temperature compensation for multiple magnet types
- Built-in temperature sensor
- 1.7-V to 3.6-V supply voltage V_{CC} range
- Operating temperature range: –40°C to +125°C

2 Applications

- [Electricity meters](#)
- [Electronic smart lock](#)
- [Smart thermostat](#)
- [Joystick & gaming controllers](#)
- [Drone payload control](#)
- [Door & window sensor](#)
- [Magnetic proximity sensor](#)
- [Mobile robot motor control](#)
- [E-bike](#)

3 Description

The TMAG5273 is a low-power linear 3D Hall-effect sensor designed for a wide range of industrial and personal electronics applications. This device integrates three independent Hall-effect sensors in the X, Y, and Z axes. A precision analog signal-chain along with an integrated 12-bit ADC digitizes the measured analog magnetic field values. The I²C interface, while supporting multiple operating V_{CC} ranges, ensures seamless data communication with low-voltage microcontrollers. The device has an integrated temperature sensor available for multiple system functions, such as thermal budget check or temperature compensation calculation for a given magnetic field.

The TMAG5273 can be configured through the I²C interface to enable any combination of magnetic axes and temperature measurements. Additionally, the device can be configured to various power options (including wake-up and sleep mode) allowing designers to optimize system power consumption based on their system-level needs. Multiple sensor conversion schemes and I²C read frames help optimize throughput and accuracy. A dedicated $\overline{\text{INT}}$ pin can act as a system interrupt during low power wake-up and sleep mode, and can also be used by a microcontroller to trigger a new sensor conversion.

An integrated angle calculation engine (CORDIC) provides full 360° angular position information for both on-axis and off-axis angle measurement topologies. The angle calculation is performed using two user-selected magnetic axes. The device features magnetic gain and offset correction to mitigate the impact of system mechanical error sources.



The TMAG5273 is offered in four different factory-programmed I²C addresses. The device also supports additional I²C addresses through the modification of a user-configurable I²C address register. Each orderable part can be configured to select one of two magnetic field ranges that suits the magnet strength and component placement during system calibration.

The device performs consistently across a wide ambient temperature range of –40°C to +125°C.

Package Information ⁽¹⁾

PART NUMBER	PACKAGE	PACKAGE SIZE ⁽²⁾
TMAG5273	DBV (SOT-23, 6)	2.9mm × 2.8mm

- (1) For all available packages, see the package option addendum at the end of the data sheet.
- (2) The package size (length × width) is a nominal value and includes pins, where applicable.

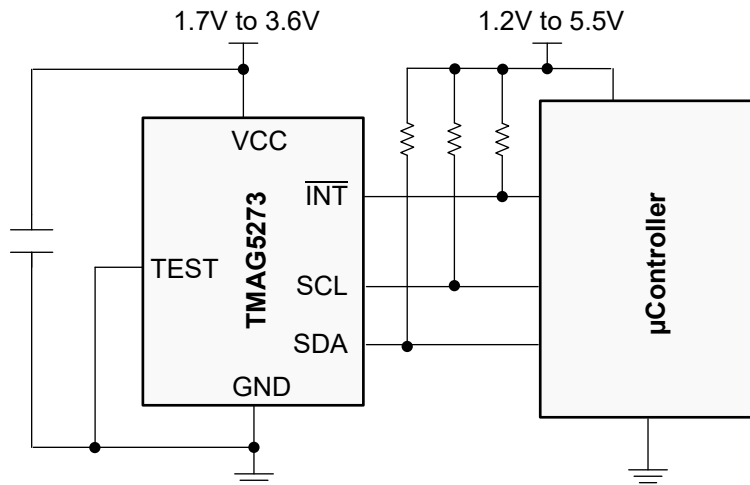

Application Block Diagram

Table of Contents

1 Features	1	6.4 Device Functional Modes.....	18
2 Applications	1	6.5 Programming.....	20
3 Description	1	7 Application and Implementation	28
4 Pin Configuration and Functions	4	7.1 Application Information.....	28
5 Specifications	5	7.2 Typical Application.....	32
5.1 Absolute Maximum Ratings.....	5	7.3 Best Design Practices.....	39
5.2 ESD Ratings.....	5	7.4 Power Supply Recommendations.....	40
5.3 Recommended Operating Conditions.....	5	7.5 Layout.....	40
5.4 Thermal Information.....	6	8 Register Maps	41
5.5 Electrical Characteristics.....	6	8.1 TMAG5273 Registers.....	41
5.6 Temperature Sensor.....	7	9 Device and Documentation Support	52
5.7 Magnetic Characteristics For A1, B1, C1, D1.....	8	9.1 Documentation Support.....	52
5.8 Magnetic Characteristics For A2, B2, C2, D2.....	9	9.2 Receiving Notification of Documentation Updates... 52	
5.9 Magnetic Temp Compensation Characteristics.....	9	9.3 Support Resources.....	52
5.10 I2C Interface Timing.....	10	9.4 Trademarks.....	52
5.11 Power up & Conversion Time.....	10	9.5 Electrostatic Discharge Caution.....	52
5.12 Typical Characteristics.....	11	9.6 Glossary.....	52
6 Detailed Description	12	10 Revision History	52
6.1 Overview.....	12	11 Mechanical, Packaging, and Orderable Information	53
6.2 Functional Block Diagram.....	12		
6.3 Feature Description.....	13		

4 Pin Configuration and Functions

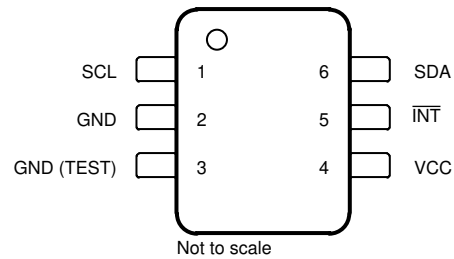

Figure 4-1. DBV Package, 6-Pin SOT-23 (Top View)

Table 4-1. Pin Functions

PIN		TYPE	DESCRIPTION
NAME	NO.		
SCL	1	IO	Serial clock.
GND	2	Ground	Ground reference.
GND (TEST)	3	Input	TI Test Pin. Connect to ground in application.
VCC	4	Power supply	Power supply.
INT	5	IO	Interrupt input/ output. If not used and connected to ground, set MASK_INTB = 1b.
SDA	6	IO	Serial data.

5 Specifications

5.1 Absolute Maximum Ratings

over operating free-air temperature range (unless otherwise noted)⁽¹⁾

		MIN	MAX	UNIT
V _{CC}	Main supply voltage	-0.3	4	V
I _{OUT}	Output current, SDA, $\overline{\text{INT}}$	0	10	mA
V _{OUT}	Output voltage, SDA, $\overline{\text{INT}}$	-0.3	7	V
V _{IN}	Input voltage, SCL, SDA, $\overline{\text{INT}}$	-0.3	7	V
B _{MAX}	Magnetic flux density		Unlimited	T
T _J	Junction temperature	-40	150	°C
T _{stg}	Storage temperature	-65	170	°C

- (1) Operation outside the Absolute Maximum Ratings may cause permanent device damage. Absolute Maximum Ratings do not imply functional operation of the device at these or any other conditions beyond those listed under Recommended Operating Conditions. If used outside the Recommended Operating Conditions but within the Absolute Maximum Ratings, the device may not be fully functional, and this may affect device reliability, functionality, performance, and shorten the device lifetime.

5.2 ESD Ratings

			VALUE	UNIT
V _(ESD)	Electrostatic discharge	Human body model (HBM), per ANSI/ESDA/ JEDEC JS-001, all pins ⁽¹⁾	±2000	V
		Charged device model (CDM), per JEDEC specification JS-002, all pins ⁽²⁾	±500	

- (1) JEDEC document JEP155 states that 500V HBM allows safe manufacturing with a standard ESD control process.
 (2) JEDEC document JEP157 states that 250V CDM allows safe manufacturing with a standard ESD control process.

5.3 Recommended Operating Conditions

over operating free-air temperature range (unless otherwise noted)
 over recommended V_{CC} range (unless otherwise noted)

		MIN	NOM	MAX	UNIT
V _{CC}	Main supply voltage	1.7		3.6	V
V _{OUT}	Output voltage, SDA, $\overline{\text{INT}}$	0		5.5	V
I _{OUT}	Output current, SDA, $\overline{\text{INT}}$			2	mA
V _{IH}	Input HIGH voltage, SCL, SDA, $\overline{\text{INT}}$	0.7			V _{CC}
V _{IL}	Input LOW voltage, SCL, SDA, $\overline{\text{INT}}$			0.3	V _{CC}
$\Delta V_{CC}/\Delta t$ ⁽¹⁾	Supply voltage ramp rate	3			V/ms
T _A	Operating free air temperature	-40		125	°C

- (1) If the VCC ramp rate is slower than the recommended supply voltage ramp rate, run a wake-up and sleep cycle after power-up or power-up reset to avoid I2C address glitch during sleep mode. This action is not required while operating in stand-by or continuous modes.

5.4 Thermal Information

THERMAL METRIC ⁽¹⁾		TMAG5273	UNIT
		DBV (SOT-23)	
		6 pins	
$R_{\theta JA}$	Junction-to-ambient thermal resistance	162	°C/W
$R_{\theta JC(top)}$	Junction-to-case (top) thermal resistance	81.6	°C/W
$R_{\theta JB}$	Junction-to-board thermal resistance	50.1	°C/W
Ψ_{JT}	Junction-to-top characterization parameter	30.7	°C/W
Ψ_{JB}	Junction-to-board characterization parameter	49.8	°C/W

(1) For more information about traditional and new thermal metrics, see the [Semiconductor and IC Package Thermal Metrics](#) application note.

5.5 Electrical Characteristics

over operating free-air temperature range (unless otherwise noted)
over recommended V_{CC} range (unless otherwise noted)

PARAMETER		TEST CONDITIONS	MIN	TYP	MAX	UNIT
SDA, INT						
V_{OL}	Output LOW voltage, SDA, \overline{INT} pin	$I_{OUT} = 2\text{mA}$	0		0.4	V
I_{OZ}	Output leakage current, SDA, \overline{INT} pin	Output disabled, $V_{OZ} = 5.5\text{V}$			± 100	nA
t_{FALL_INT}	\overline{INT} output fall time	$R_{PU} = 10\text{K}\Omega$, $C_L = 20\text{pF}$, $V_{PU} = 1.65\text{V}$ to 5.5V		6		ns
$t_{INT (INT)}$	\overline{INT} Interrupt time duration during pulse mode	$INT_MODE = 001\text{b}$ or 010b		10		μs
$t_{INT (SCL)}$	SCL Interrupt time duration	$INT_MODE = 011\text{b}$ or 100b		10		μs
DC POWER SECTION						
$V_{CCUV}^{(1)}$	Undervoltage threshold at V_{CC}	$V_{CC} = 2.3\text{V}$ to 3.6V	1.9	2.0	2.2	V
I_{ACTIVE}	Active mode current	X, Y, Z, or thermal sensor active conversion, $LP_LN = 0\text{b}$		2.3		mA
I_{ACTIVE}	Active mode current	X, Y, Z, or thermal sensor active conversion, $LP_LN = 1\text{b}$		3.0		mA
$I_{STANDBY}$	Stand-by mode current	Device in trigger mode, no conversion started		0.45		mA
I_{SLEEP}	Sleep mode current			5		nA

over operating free-air temperature range (unless otherwise noted)
over recommended V_{CC} range (unless otherwise noted)

PARAMETER		TEST CONDITIONS	MIN	TYP	MAX	UNIT
AVERAGE POWER DURING WAKE-UP AND SLEEP (W&S) MODE						
I_{CC_DCM}	W&S mode current consumption Wake-up interval 1ms LP_LN =0b	Magnetic 1 channel conversion $V_{CC} = 3.3V$		160		μA
		Magnetic 1 channel conversion $V_{CC} = 1.8V$		156		μA
		Magnetic 4 channel conversion $V_{CC} = 3.3V$		240		μA
		Magnetic 4 channel conversion $V_{CC} = 1.8V$		233		μA
	W&S mode current consumption Wake-up interval 5000ms LP_LN =0b	Magnetic 1 channel conversion $V_{CC} = 3.3V$		1.21		μA
		Magnetic 1 channel conversion $V_{CC} = 1.8V$		1.00		μA
		Magnetic 4 channel conversion $V_{CC} = 3.3V$		1.22		μA
		Magnetic 4-channel conversion $V_{CC} = 1.8V$		1.02		μA

(1) The DIAG_STATUS and VCC_UV_ER bits are not valid for $V_{CC} < 2.3V$

5.6 Temperature Sensor

over operating free-air temperature range (unless otherwise noted)
over recommended V_{CC} range (unless otherwise noted)

PARAMETER		TEST CONDITIONS	MIN	TYP	MAX	UNIT
T_{SENS_RANGE}	Temperature sensing range		-40		170 ⁽¹⁾	$^{\circ}C$
T_{ADC_T0}	Temperature result in decimal value (from 16-bit format) for T_{SENS_T0}			17508		
T_{SENS_T0}	Reference temperature for T_{ADC_T0}			25		$^{\circ}C$
T_{ADC_RES}	Temp sensing resolution (in 16-bit format)			60.1		LSB/ $^{\circ}C$
NRMS_T	RMS (1 Sigma) temperature noise	CONV_AVG = 000b		0.4		$^{\circ}C$
NRMS_T	RMS (1 Sigma) temperature noise	CONV_AVG = 101b		0.2		$^{\circ}C$

(1) TI recommends not to exceed the specified Operating free air temperature per *Recommended Operating Conditions* table

5.7 Magnetic Characteristics For A1, B1, C1, D1

over operating free-air temperature range (unless otherwise noted)

PARAMETER		TEST CONDITIONS	MIN	TYP	MAX	UNIT
B _{IN}	Linear magnetic range for X, Y, and Z	_RANGE = 0b		±40		mT
		_RANGE = 1b		±80		mT
SENS	Sensitivity, X, Y, or Z axis	_RANGE = 0b, ±40mT		820		LSB/mT
		_RANGE = 1b, ±80mT		410		LSB/mT
SENS _{ER}	Sensitivity error, X, Y, Z axis	T _A = 25°C		±5.0%	±20.0%	
SENS _{ER_DR}	Sensitivity error drift from 25°C X, Y, Z axis			±5.0%		
SENS _{LER}	Sensitivity linearity error T _A = 25°C	X, Y Axis		±0.10%		
		Z Axis		±0.10%		
SENS _{MS}	Sensitivity mismatch T _A = 25°C	X-Y axes		±0.50%		
		Y-Z, or X-Z axes		±1.0%		
SENS _{MS_DR}	Sensitivity mismatch drift	X-Y axes		±5%		
		Y-Z, or X-Z axes		±15%		
B _{off}	Offset	T _A = 25°C		±300	±1000	μT
B _{off_TC}	Offset drift			±3.0	±10.0	μT/°C
N _{RMS}	RMS (1 Sigma) magnetic noise CONV_AVG = 000b T _A = 25°C	LP_LN = 0b X, Y Axis		125		μT
		LP_LN = 1b X, Y Axis		110		μT
	RMS (1 Sigma) magnetic noise CONV_AVG = 101b T _A = 25°C	LP_LN = 0b X, Y Axis		22		μT
		LP_LN = 1b X, Y Axis		22		μT
	RMS (1 Sigma) magnetic noise CONV_AVG = 000b T _A = 25°C	LP_LN = 0b Z Axis		68		μT
		LP_LN = 1b Z Axis		66		μT
	RMS (1 Sigma) magnetic noise CONV_AVG = 101b T _A = 25°C	LP_LN = 0b Z Axis		11		μT
		LP_LN = 1b Z Axis		9		μT
A _{ERR}	Angle error CONV_AVG = 101b T _A = 25°C	Y-Z		±1.0		Degree
		X-Z		±1.0		Degree
		X-Y		±0.5		Degree

5.8 Magnetic Characteristics For A2, B2, C2, D2

over operating free-air temperature range (unless otherwise noted)

PARAMETER		TEST CONDITIONS	MIN	TYP	MAX	UNIT
B _{IN}	Linear magnetic range for X, Y, and Z	_RANGE = 0b		±133		mT
		_RANGE = 1b		±266		mT
SENS	Sensitivity, X, Y, or Z axis	_RANGE = 0b, ±133mT		250		LSB/mT
		_RANGE = 0b, ±266mT		125		LSB/mT
SENS _{ER}	Sensitivity error. X, Y, Z axis	T _A = 25°C		±5.0%	±20.0%	
SENS _{ER_DR}	Sensitivity error drift. X, Y, Z axis			±5.0%		
SENS _{LER}	Sensitivity linearity error T _A = 25°C	X, Y Axis		±0.10%		
		Z Axis		±0.10%		
SENS _{MS}	Sensitivity mismatch T _A = 25°C	X-Y axes		±0.50%		
		Y-Z, or X-Z axes		±1.0%		
SENS _{MS_DR}	Sensitivity mismatch drift	X-Y axes		±5%		
		Y-Z, or X-Z axes		±15%		
B _{off}	Offset	T _A = 25°C		±300	±1000	μT
	Offset drift			±3.0	±10	μT/°C
N _{RMS}	RMS (1 Sigma) magnetic noise CONV_AVG = 000b T _A = 25°C	LP_LN = 0b X, Y Axis		147		μT
		LP_LN = 1b X, Y Axis		145		μT
	RMS (1 Sigma) magnetic noise CONV_AVG = 101b T _A = 25°C	LP_LN = 0b X, Y Axis		24		μT
		LP_LN = 1b X, Y Axis		24		μT
	RMS (1 Sigma) magnetic noise CONV_AVG = 000b T _A = 25°C	LP_LN = 0b Z Axis		89		μT
		LP_LN = 1b Z Axis		88		μT
	RMS (1 Sigma) magnetic noise CONV_AVG = 101b T _A = 25°C	LP_LN = 0b Z Axis		15		μT
		LP_LN = 1b Z Axis		15		μT
A _{ERR}	Angle error CONV_AVG = 101b T _A = 25°C	Y-Z		±1.0		Degree
		X-Z		±1.0		Degree
		X-Y		±0.50		Degree

5.9 Magnetic Temp Compensation Characteristics

over operating free-air temperature range (unless otherwise noted)

PARAMETER		TEST CONDITIONS	MIN	TYP	MAX	UNIT
TC ₀₀	Temperature compensation (X, Y, Z-axes)	MAG_TEMPACO = 00b		0		%/°C
TC ₁₂	Temperature compensation (X, Y, Z-axes)	MAG_TEMPACO = 01b		0.12		%/°C
TC ₂₀	Temperature compensation (X, Y, Z-axes)	MAG_TEMPACO = 11b		0.2		%/°C

5.10 I2C Interface Timing

over operating free-air temperature range (unless otherwise noted)

PARAMETER		TEST CONDITIONS	MIN	TYP	MAX	UNIT
I2C Interface Fast Mode Plus ($V_{CC} = 2.3V$ to $3.6V$)						
f_{I2C_fmp}	I2C clock (SCL) frequency	LOAD = 50pF $V_{CC} = 2.3V$ to $3.6V$			1000	KHz
t_{whigh_fmp}	High time: SCL logic high time duration		350			ns
t_{wlo_wfmp}	Low time: SCL logic low time duration		500			ns
$t_{su_cs_fmp}$	SDA data setup time		50			ns
$t_{h_cs_fmp}$	SDA data hold time		120			ns
t_{icr_fmp}	SDA, SCL input rise time				120	ns
t_{icf_fmp}	SDA, SCL input fall time				55	ns
$t_{h_ST_fmp}$	Start condition hold time		0.1			μs
$t_{su_SR_fmp}$	Repeated start condition setup time		0.1			μs
$t_{su_SP_fmp}$	Stop condition setup time		0.1			μs
$t_{w_SP_SR_fmp}$	Bus free time between stop and start condition		0.2			μs
I2C Interface Fast Mode ($V_{CC} = 1.7V$ to $3.6V$)						
f_{I2C}	I2C clock (SCL) frequency	LOAD = 50pF $V_{CC} = 1.7V$ to $3.6V$			400	KHz
t_{whigh}	High time: SCL logic high time duration		600			ns
t_{wlow}	Low time: SCL logic low time duration		1300			ns
t_{su_cs}	SDA data setup time		100			ns
t_{h_cs}	SDA data hold time		0			ns
t_{icr}	SDA, SCL input rise time				300	ns
t_{icf}	SDA, SCL input fall time				300	ns
t_{h_ST}	Start condition hold time		0.3			μs
t_{su_SR}	Repeated start condition setup time		0.3			μs
t_{su_SP}	Stop condition setup time		0.3			μs
$t_{w_SP_SR}$	Bus free time between stop and start condition		0.6			μs

5.11 Power up & Conversion Time

over operating free-air temperature range (unless otherwise noted)

PARAMETER		TEST CONDITIONS	MIN	TYP	MAX	UNIT
$t_{start_power_up}$	Time to go to standby mode after V_{CC} supply voltage crossing V_{CC_MIN}			270		μs
t_{start_sleep}	Time to go from sleep mode to standby mode ⁽¹⁾			50		μs
$t_{start_measure}$	Time to go from standby mode to continuous measure mode			70		μs
$t_{measure}$	Conversion time Only one channel enabled OPERATING_MODE = 10b	CONV_AVG = 000b ⁽²⁾		50		μs
		CONV_AVG = 101b ⁽³⁾		825		μs
t_{go_sleep}	Time to go into sleep mode after SCL goes high			20		μs

- (1) The device only recognizes the I2C communication from a primary during standby or continuous measure modes. While the device is in sleep mode, a valid secondary address wakes up the device but no acknowledge is sent to the primary. Consider the start-up time before addressing the device after wake up.
- (2) Add $25\mu s$ for each additional magnetic channel enabled for conversion with CONV_AVG = 000b. When CONV_AVG = 000b, the conversion time doesn't change with the T_CH_EN bit setting.
- (3) For conversion with CONV_AVG = 101b, each channel data is collected 32 times. If an additional channel is enabled with CONV_AVG = 101b, add $32 \times 25\mu s = 800\mu s$ to the $t_{measure}$ to calculate the conversion time for two channels.

5.12 Typical Characteristics

at $T_A = 25^\circ\text{C}$ typical (unless otherwise noted)

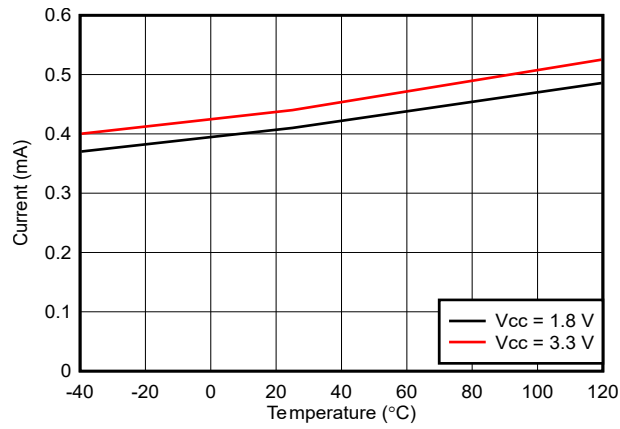

Figure 5-1. Standby Mode ICC vs Temperature

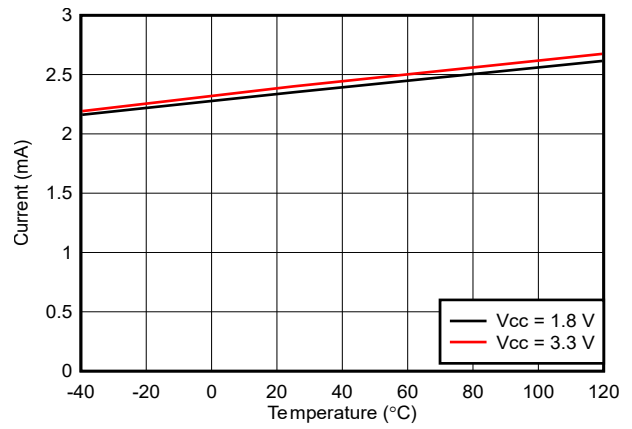

Figure 5-2. Active Mode ICC vs Temperature

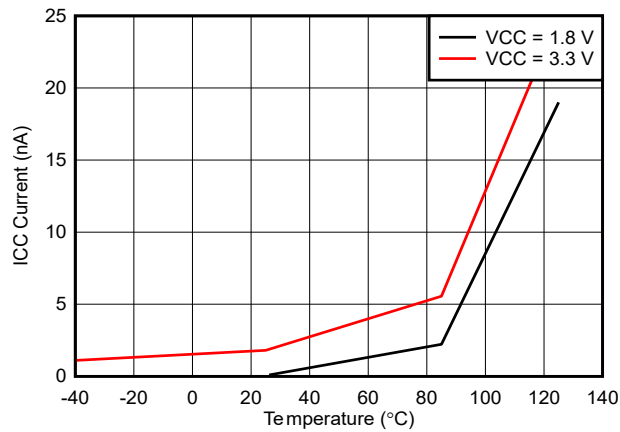

Figure 5-3. Sleep Mode ICC vs Temperature

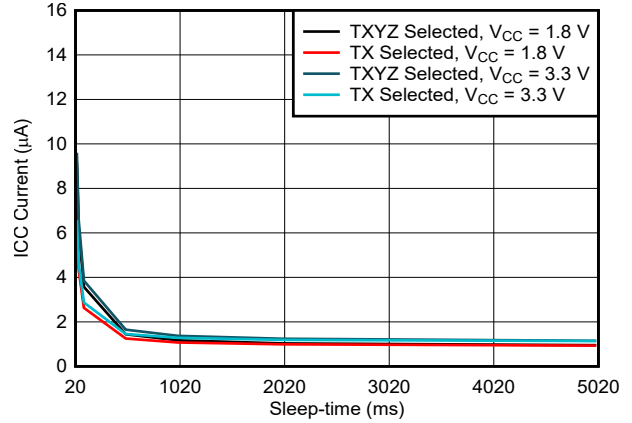

Figure 5-4. Average ICC vs W&S Mode Sleep Time

6 Detailed Description

6.1 Overview

The TMAG5273 IC is based on the Hall-effect technology and precision mixed signal circuitry from Texas Instruments. The output signals (raw X, Y, Z magnetic data and temperature data) are accessible through the I²C interface.

The IC consists of the following functional and building blocks:

- The Power Management & Oscillator block contains a low-power oscillator, biasing circuitry, undervoltage detection circuitry, and a fast oscillator.
- The sensing and temperature measurement block contains the Hall biasing, Hall sensors with multiplexers, noise filters, integrator circuit, temperature sensor, and the ADC. The Hall-effect sensor data and temperature data are multiplexed through the same ADC.
- The Interface block contains the I²C control circuitry, ESD protection circuits, and all the I/O circuits. The TMAG5273 supports multiple I²C read frames along with integrated cyclic redundancy check (CRC).

6.2 Functional Block Diagram

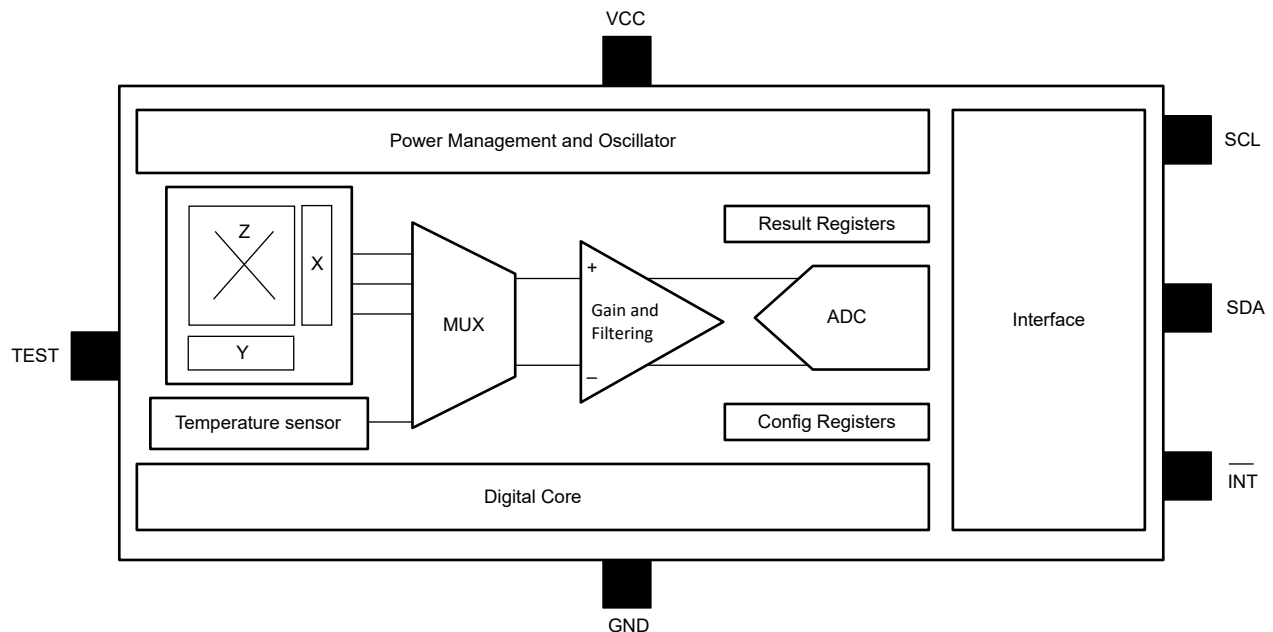

6.3 Feature Description

6.3.1 Magnetic Flux Direction

As shown in Figure 6-1, the TMAG5273 generates positive ADC codes in response to a magnetic north pole in proximity. Similarly, the TMAG5273 generates negative ADC codes if the magnetic south poles approach from the same directions.

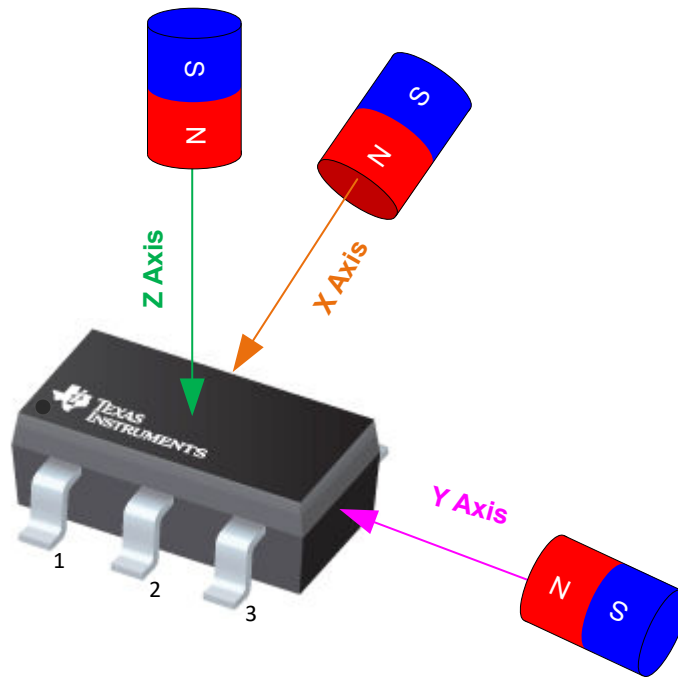

Figure 6-1. Direction of Sensitivity

6.3.2 Sensor Location

Figure 6-2 shows the location of X, Y, Z hall elements inside the TMAG5273.

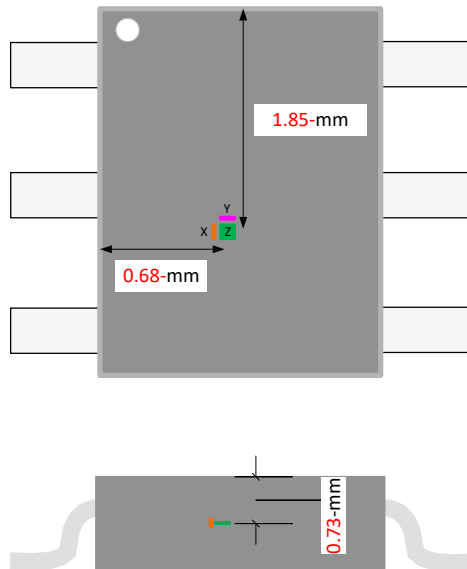

Figure 6-2. Location of X, Y, Z Hall Elements

6.3.3 Interrupt Function

The TMAG5273 supports flexible and configurable interrupt functions through either the $\overline{\text{INT}}$ or the SCL pin. [Table 6-1](#) shows different conversion completion events where result registers and **SET_COUNT** bits update, and where they do not.

Table 6-1. Result Register & SET_COUNT Update After Conversion Completion

INT_MODE	MODE DESCRIPTION	I ² C BUS BUSY, NOT TALKING TO DEVICE		I ² C BUS BUSY & TALKING TO DEVICE		I ² C BUS NOT BUSY	
		RESULT UPDATE?	SET_COUNT UPDATE?	RESULT UPDATE?	SET_COUNT UPDATE?	RESULT UPDATE?	SET_COUNT UPDATE?
000b	No interrupt	Yes	Yes	No	No	Yes	Yes
001b	Interrupt through $\overline{\text{INT}}$	Yes	Yes	No	No	Yes	Yes
010b	Interrupt through $\overline{\text{INT}}$ except when I ² C busy	Yes	Yes	No	No	Yes	Yes
011b	Interrupt through SCL	Yes	Yes	No	No	Yes	Yes
100b	Interrupt through SCL except when I ² C busy	No	No	No	No	Yes	Yes

Note

TI does not recommend sharing the same I²C bus with multiple secondary devices when using the SCL pin for interrupt function. The SCL interrupt may corrupt transactions with other secondary devices if present in the same I²C bus.

Interrupt Through SCL

[Figure 6-3](#) shows an example for interrupt function through the SCL pin with the device programmed to wake up and sleep mode for threshold cross at a predefined intervals. The wake-up intervals can be set through the **SLEEPTIME** bits. When the device detects a magnetic threshold cross, the TMAG5273 asserts a fixed width interrupt signal through the SCL pin, and goes back to standby mode.

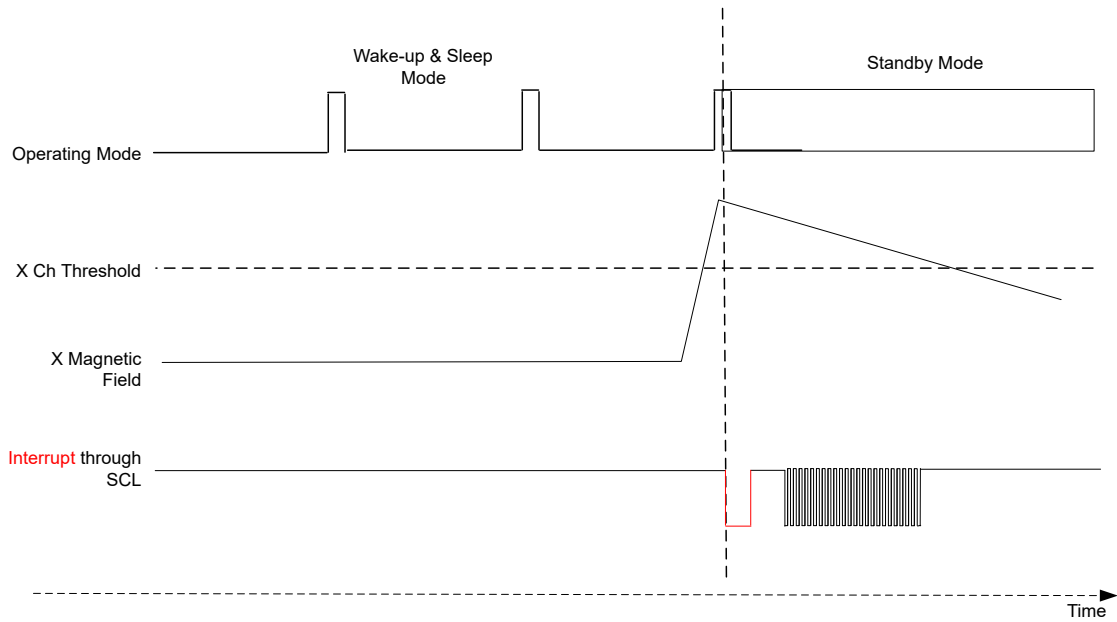

Figure 6-3. Interrupt Through SCL

Fixed Width Interrupt Through $\overline{\text{INT}}$

Figure 6-4 shows an example for fixed-width interrupt function through the $\overline{\text{INT}}$ pin. The device is programmed to be in wake-up and sleep mode to detect a magnetic threshold. The `INT_STATE` register bit is set 1b. When the device detects a magnetic threshold cross, the TMAG5273 asserts a fixed width interrupt signal through the $\overline{\text{INT}}$ pin, and goes back to standby mode.

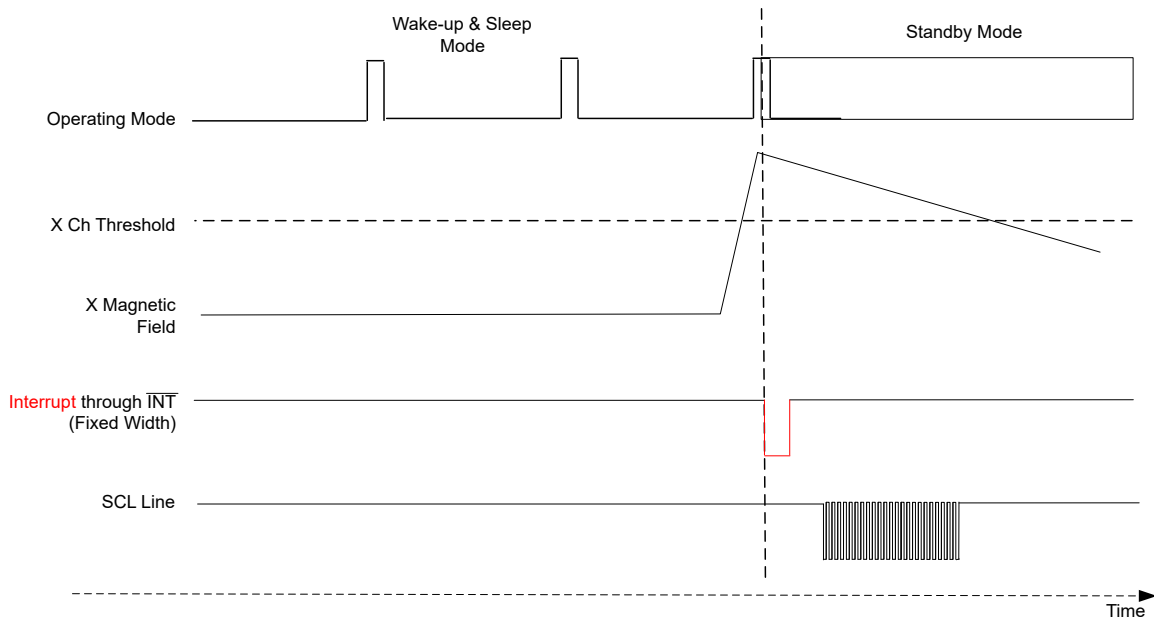

Figure 6-4. Fixed Width Interrupt Through $\overline{\text{INT}}$

Latched Interrupt Through $\overline{\text{INT}}$

Figure 6-5 shows an example for latched interrupt function through the $\overline{\text{INT}}$ pin. The device is programmed to be in wake-up and sleep mode to detect a magnetic threshold. The `INT_STATE` register bit is set 0b. When the device detects a magnetic threshold cross, the TMAG5273 asserts a latched interrupt signal through the $\overline{\text{INT}}$ pin

and goes back to standby mode. The interrupt latch is cleared only after the device receives a valid address through the SCL line.

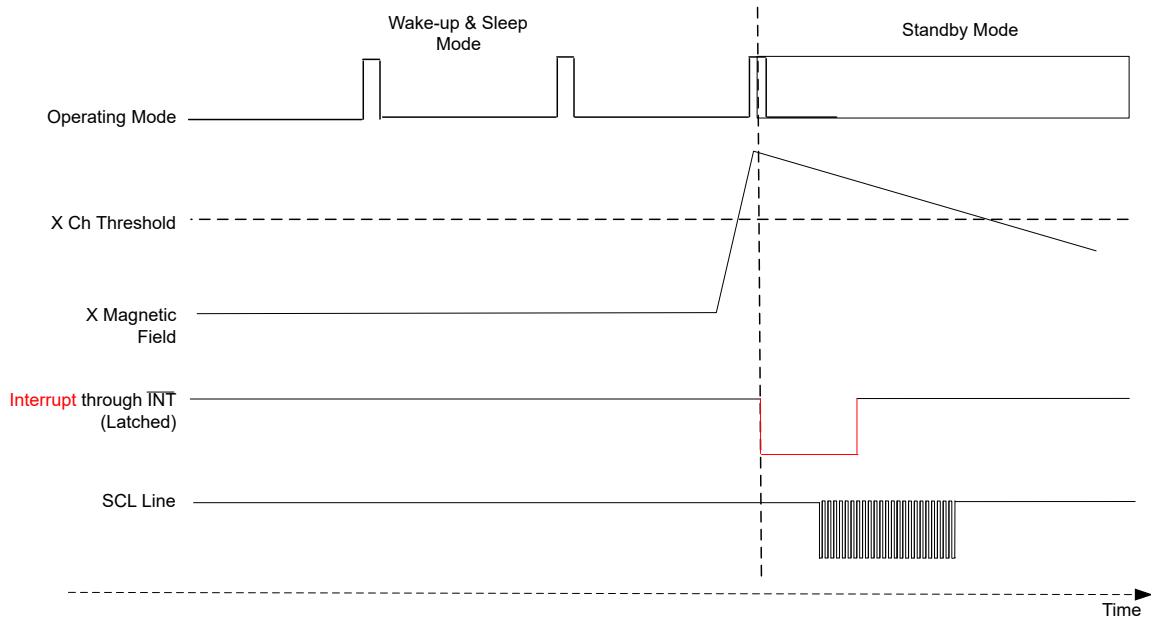

Figure 6-5. Latched Interrupt Through $\overline{\text{INT}}$

6.3.4 Device I²C Address

Table 6-2 shows the default factory programmed I²C addresses of the TMAG5273. The device needs to be addressed with the factory default I²C address after power up. If required, a primary can assign a new I²C address through the I2C_ADDRESS register bits after power up.

Table 6-2. I²C Default Address

DEVICE VERSION	MAGNETIC RANGE	I ² C ADDRESS (7 MSB BITS)	I ² C WRITE ADDRESS (8-BIT)	I ² C READ ADDRESS (8-BIT)
TMAG5273A1	±40 mT, ±80 mT	35h	6Ah	6Bh
TMAG5273B1		22h	44h	45h
TMAG5273C1		78h	F0h	F1h
TMAG5273D1		44h	88h	89h
TMAG5273A2	±133 mT, ±266 mT	35h	6Ah	6Bh
TMAG5273B2		22h	44h	45h
TMAG5273C2		78h	F0h	F1h
TMAG5273D2		44h	88h	89h

6.3.5 Magnetic Range Selection

Table 6-3 shows the magnetic range selection for the TMAG5273 device. The X, Y, and Z axes range can be selected with the [X_Y_RANGE](#) and [Z_RANGE](#) register bits.

Table 6-3. Magnetic Range Selection

	RANGE REGISTER SETTING	TMAG5273A1	TMAG5273A2	COMMENT
X, Y Axis Field	X_Y_RANGE = 0b	±40-mT	±133-mT	
	X_Y_RANGE = 1b	±80-mT	±266-mT	Better SNR performance
Z Axis Field	Z_RANGE = 0b	±40-mT	±133-mT	
	Z_RANGE = 1b	±80-mT	±266-mT	Better SNR performance

6.3.6 Update Rate Settings

The TMAG5273 offers multiple update rates to offer design flexibility to system designers. The different update rates can be selected with the [CONV_AVG](#) register bits. Table 6-4 shows different update rate settings for the TMAG5273.

Table 6-4. Update Rate Settings

OPERATING MODE	REGISTER SETTING	UPDATE RATE			COMMENT
		SINGLE AXIS	TWO AXES	THREE AXES	
X, Y, Z Axis	CONV_AVG = 000b	20.0-kSPS	13.3-kSPS	10.0-kSPS	Fastest update rate
X, Y, Z Axis	CONV_AVG = 001b	13.3-kSPS	8.0-kSPS	5.7-kSPS	
X, Y, Z Axis	CONV_AVG = 010b	8.0-kSPS	4.4-kSPS	3.1-kSPS	
X, Y, Z Axis	CONV_AVG = 011b	4.4-kSPS	2.4-kSPS	1.6-kSPS	
X, Y, Z Axis	CONV_AVG = 100b	2.4-kSPS	1.2-kSPS	0.8-kSPS	
X, Y, Z Axis	CONV_AVG = 101b	1.2-kSPS	0.6-kSPS	0.4-kSPS	Best SNR case

6.4 Device Functional Modes

The TMAG5273 supports multiple functional modes for wide array of applications as explained in [Figure 6-6](#). A specific functional mode is selected by setting the corresponding value in the [OPERATING_MODE](#) register bits. The device starts powering up after VCC supply crosses the minimum threshold as specified in the Recommended Operating Condition (ROC) table.

6.4.1 Standby (Trigger) Mode

The TMAG5273 goes to standby mode after first time powering up. At this mode the digital circuitry and oscillators are on, and the device is ready to accept commands from the primary device. Based off the commands the device can start a sensor data conversion, go to power saving mode, or start data transfer through I²C interface. A new conversion can be triggered through I²C command or through $\overline{\text{INT}}$ pin. In this mode the device retains the immediate past conversion result data in the corresponding result registers. The time for the device to go from power up to standby mode is listed as $T_{\text{start_power_up}}$ in the [Power up & Conversion Time](#) table.

6.4.2 Sleep Mode

The TMAG5273 supports an ultra-low power sleep mode where the device retains the critical user configuration settings. The device does not retain the conversion result data in sleep mode. A primary can wake up the device from sleep mode through I²C interface or the $\overline{\text{INT}}$ pin. During the transition from sleep mode to standby mode through I²C interface the $\overline{\text{INT}}$ pin briefly asserts an interrupt. The $\overline{\text{INT}}$ pin recovers after the device fully transitions to the standby mode with RESULT_STATUS bit set to 0h indicating no conversion is completed. The time it takes for the device to go to standby mode from sleep mode is denoted by $T_{\text{start_sleep}}$.

6.4.3 Wake-up and Sleep (W&S) Mode

In this mode the TMAG5273 can be configured to go to sleep and wake up at a certain interval, and measure sensor data based off the [SLEEPTIME](#) register bits setting. The device can be set to generate an interrupt through the [INT_CONFIG_1](#) register. After the conversion is complete and the interrupt condition is met, the TMAG5273 exits the W&S mode and goes into standby mode. The last measured data is stored in the corresponding result registers before the device goes to the standby mode. If the interrupt condition is not met, the device continues in W&S mode to wake up and measure data at the specified interval. A primary can wake up the TMAG5273 anytime during the W&S mode through I²C bus or $\overline{\text{INT}}$ pin. The result interrupt function is not available during the W&S mode. The time for the device to go from W&S mode to standby mode is listed as $T_{\text{start_sleep}}$ in the [Power up & Conversion Time](#) table.

6.4.4 Continuous Measure Mode

In this mode the TMAG5273 continuously measures the sensor data per SENSOR_CONFIG & DEVICE_CONFIG register settings. In this mode the result registers can be accessed through the I2C lines. The time for the device to go from continuous measure mode to standby mode is listed as $T_{start_measure}$ in the [Power up & Conversion Time](#) table.

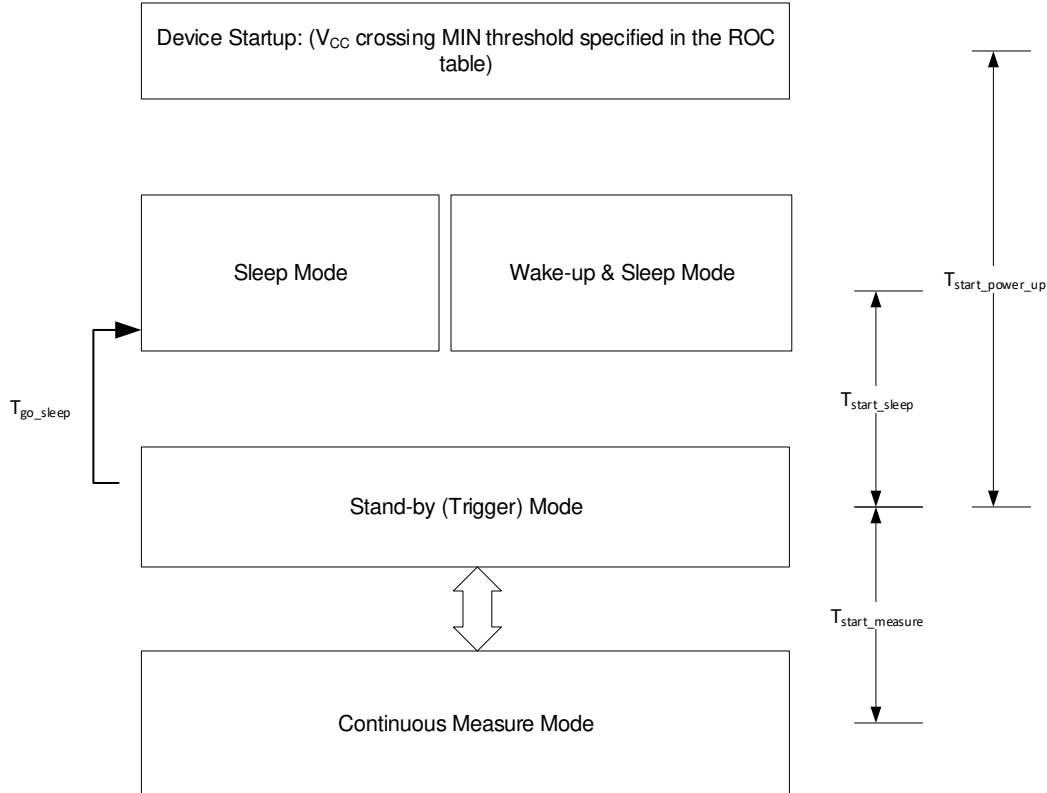

Figure 6-6. TMAG5273 Power-Up Sequence

Table 6-5 shows different device operational modes of the TMAG5273.

Table 6-5. Operating Modes

OPERATING MODE	DEVICE FUNCTION	ACCESS TO USER REGISTERS	RETAIN USER CONFIGURATION	COMMENT
Continuous Measure Mode	Continuously measuring x, y, z axis, or temperature data	Yes	Yes	
Standby Mode	Device is ready to accept I ² C commands and start active conversion	Yes	Yes	
Wake-up and Sleep Mode	Wakes up at a certain interval to measure the x, y, z axis, or temperature data	No	Yes	1ms, 5ms, 10ms, 15ms, 20ms, 30ms, 50ms, 100ms, 500ms, 1000ms, 2000ms, 5000ms, and 20000ms intervals supported.
Sleep Mode	Device retains key configuration settings, but does not retain the measurement data	No	Yes	The primary device can use sleep mode to implement other power saving intervals not supported by wake-up and sleep mode.

6.5 Programming

6.5.1 I²C Interface

The TMAG5273 offers I²C interface, a two-wire interface to connect low-speed devices like microcontrollers, A/D and D/A converters, I/O interfaces and other similar peripherals in embedded systems.

6.5.1.1 SCL

The SCL is the clock line used to synchronize all data transfers over the I²C bus.

6.5.1.2 SDA

SDA is the bidirectional data line for the I²C interface.

6.5.1.3 I²C Read/Write

The TMAG5273 supports multiple I²C read and write frames targeting different applications. [I2C_RD](#) and [CRC_EN](#) bits offers multiple read frames to optimize the read time, data resolution and data integrity for a select application.

6.5.1.3.1 Standard I²C Write

[Figure 6-7](#) shows an example of standard I²C two byte write command supported by TMAG5273. The starting byte contains 7-bit secondary device address and a 0 at the R/W command bit. The MSB of the second byte contains the conversion trigger bit. Write 1 at this trigger bit to start a new conversion after the register address decoding is complete. The seven LSB bits of the second byte contains the starting register address for the write command. After the two command bytes, the primary device starts to send the data to be written at the corresponding register address. Each successive write byte sends the data for the successive register address in the secondary device.

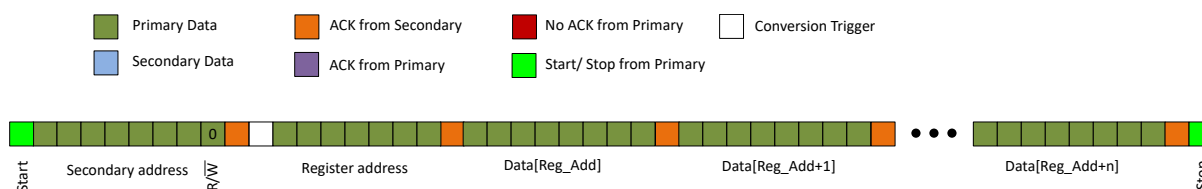

Figure 6-7. Standard I²C Write

6.5.1.3.2 General Call Write

[Figure 6-8](#) shows an example of the general call I²C write command supported by the TMAG5273. This command is useful to configure multiple I²C devices in a I²C bus simultaneously. The starting byte contains 8-bit 0s. The MSB of the second byte contains the conversion trigger bit. Write 1 at this trigger bit to start a new conversion after the register address decoding is completed. The seven LSB bits of the second byte contains the starting register address for the write command. After the two command bytes, the primary device starts to send the data to be written at the corresponding register address of all the secondary devices in the I²C bus. Each successive write byte sends the data for the successive register address in the secondary devices.

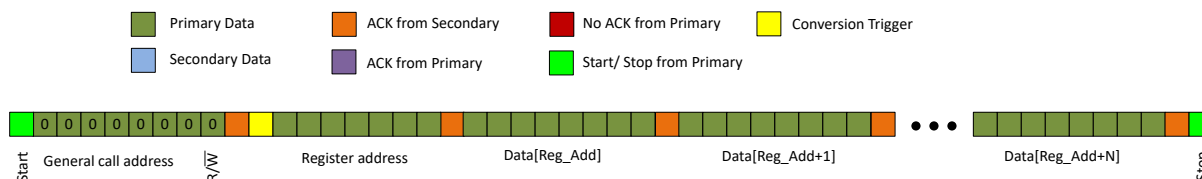

Figure 6-8. General Call I²C Write

6.5.1.3.3 Standard 3-Byte I²C Read

Figure 6-9 and Figure 6-10 show examples of standard I²C three byte read command supported by the TMAG5273. The starting byte contains 7-bit secondary device address and the R/W command bit 0. The MSB of the second byte contains the conversion trigger command bit. Write 1 at this trigger bit to start a new conversion after the register address decoding is completed. The seven LSB bits of the second byte contains the starting register address for the write command. After receiving ACK signal from secondary, the primary send the secondary address once again with R/W command bit as 1. The secondary starts to send the corresponding register data, and sends successive register data with each successive ACK from the primary. If CRC is enabled, the secondary sends the fifth CRC byte based off the CRC calculation of immediate past four register bytes.

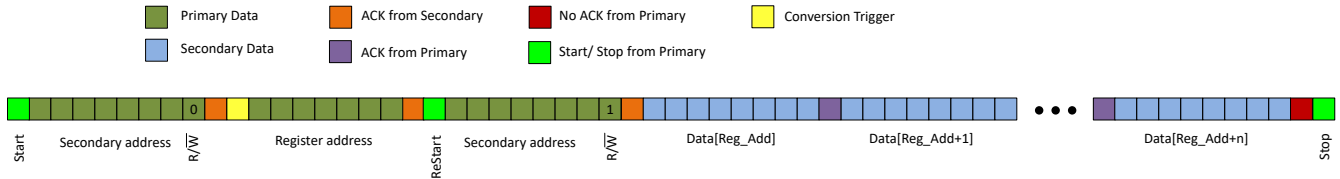

Figure 6-9. Standard 3-Byte I²C Read With CRC Disabled, CRC_EN = 0b

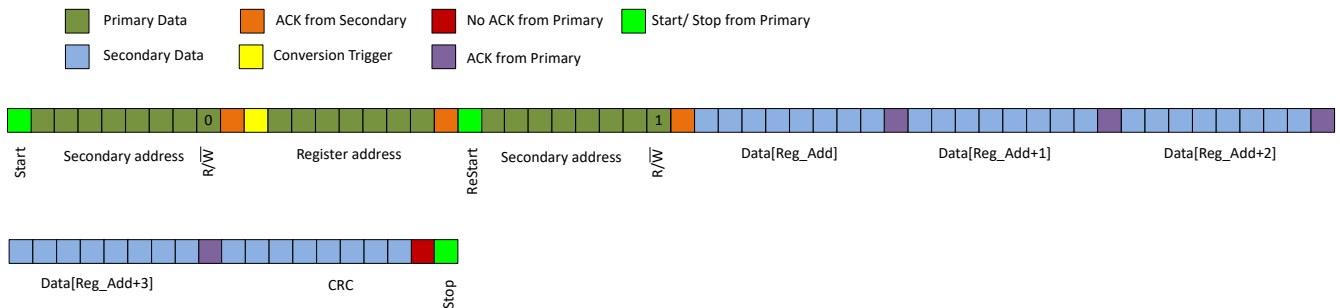

Figure 6-10. Standard 3-Byte I²C Read With CRC Enabled, CRC_EN = 1b

6.5.1.3.4 1-Byte I2C Read Command for 16-Bit Data

Figure 6-11 and Figure 6-12 show examples of 1-byte I²C read command supported by the TMAG5273. Select I2C_RD = 01b to enable this mode. The command byte contains 7-bit secondary device address and a 1 at the R/W bit. In this mode, per MAG_CH_EN and T_CH_EN bits setting, the device sends 16-bit data of the enabled channels and the CONV_STATUS register data byte. If CRC is enabled, the device sends an additional CRC byte based off the CRC calculation of the command byte and the data sent in the current packet. When multiple channels are enabled, the sent data follows the T, X, Y, and Z sequence in the successive data bytes.

TMAG5273

SLYS045B – JUNE 2021 – REVISED JULY 2024



Figure 6-11. 1-Byte I²C Read Command for 16-Bit Data With CRC Disabled, CRC_EN = 0b

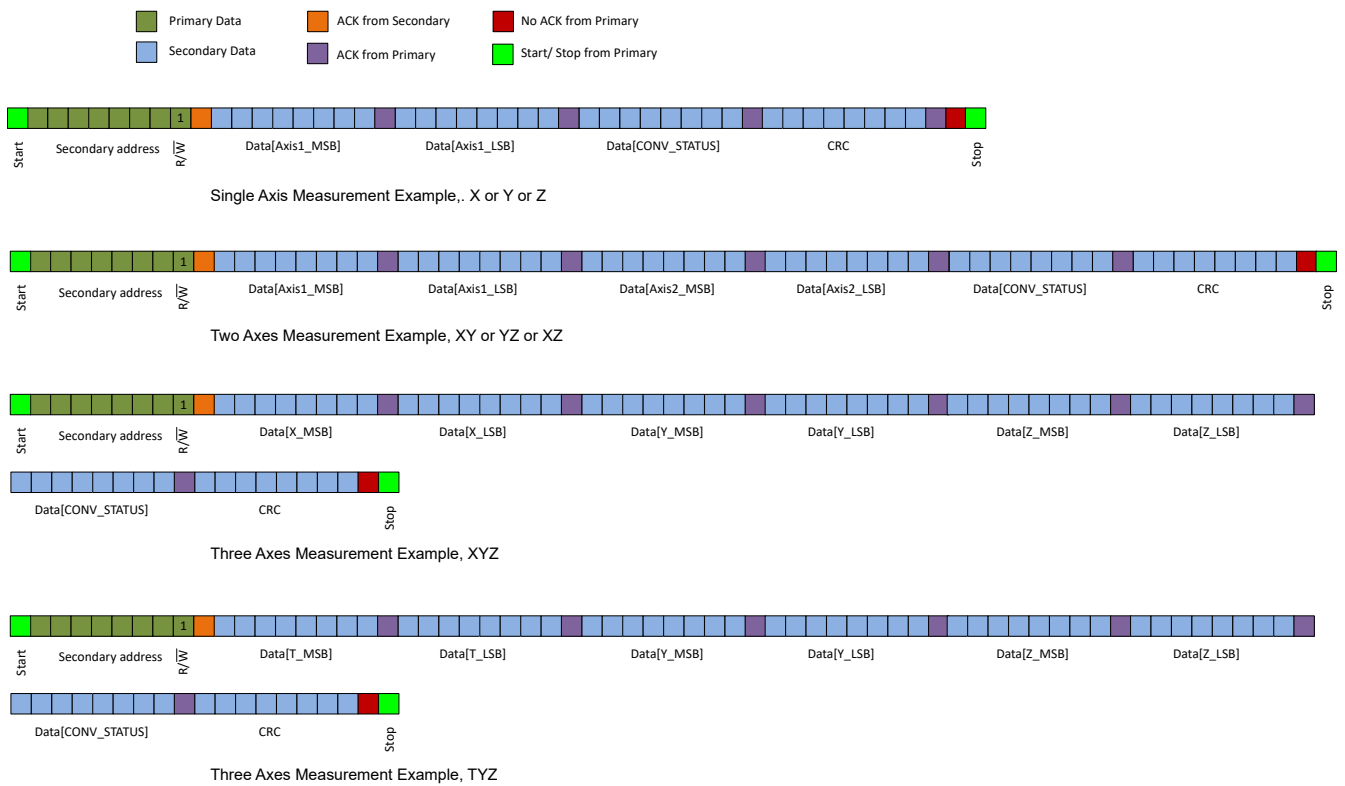

Figure 6-12. 1-Byte I²C Read Command for 16-Bit Data With CRC Enabled, CRC_EN = 1b

6.5.1.3.5 1-Byte I²C Read Command for 8-Bit Data

Figure 6-13 and Figure 6-14 show examples of 1-byte I²C read command supported by the TMAG5273. Select I2C_RD = 10b to enable this mode. The command byte contains 7-bit secondary device address and a 1 at the R/W bit. In this mode, per MAG_CH_EN and T_CH_EN bits setting, the device sends 8-bit data of the enabled channels and the CONV_STATUS register data byte. If CRC is enabled, the device sends an additional CRC byte based off the CRC calculation of the command byte and the data sent in the current packet. When multiple channels are enabled, the sent data follows the T, X, Y, and Z sequence in the successive data bytes.

- Primary Data
- ACK from Secondary
- No ACK from Primary
- Secondary Data
- ACK from Primary
- Start/ Stop from Primary



Single Axis Measurement Example, X or Y or Z

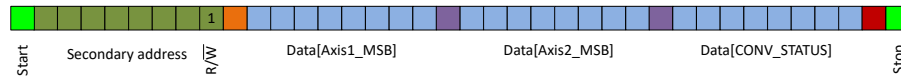

Two Axes Measurement Example, XY or YZ or XZ

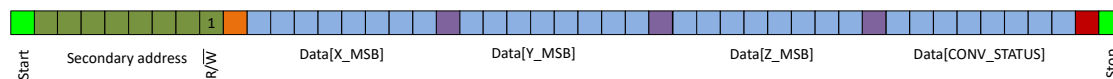

Three Axes Measurement Example, XYZ



All Sensors Measurement Example, TXYZ

Figure 6-13. 1-Byte I²C Read Command for 8-Bit Data With CRC Disabled, CRC_EN = 0b

- Primary Data
- ACK from Secondary
- No ACK from Primary
- Secondary Data
- ACK from Primary
- Start/ Stop from Primary



Single Axis Measurement Example, X or Y or Z



Two Axes Measurement Example, XY or YZ or XZ

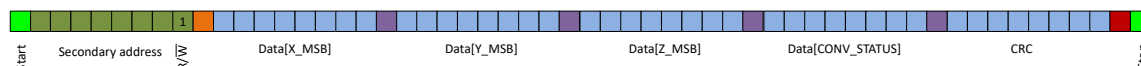

Three Axes Measurement Example, XYZ

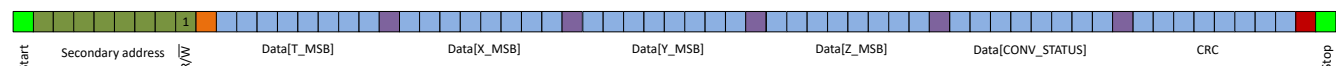

Three Axes & Temperature Measurement Example, TXYZ

Figure 6-14. 1-Byte I²C Read Command for 8-Bit Data With CRC Enabled, CRC_EN = 1b

Note

In the 1-byte read command for 8-bit data any combinations of channels can be sent without restrictions.

6.5.1.3.6 I²C Read CRC

The TMAG5273 supports optional CRC during I²C read. The CRC can be enabled through the [CRC_EN](#) register bit. The CRC is performed on a data string that is determined by the I²C read type. The CRC information is sent as a single byte after the data bytes. The code is generated by the polynomial $x^8 + x^2 + x + 1$. Initial CRC bits are FFh.

The following equations can be employed to calculate CRC:

$$d = \text{Data Input, } c = \text{Initial CRC (FFh)} \quad (1)$$

$$\text{newcrc}[0] = d[7] \wedge d[6] \wedge d[0] \wedge c[0] \wedge c[6] \wedge c[7] \quad (2)$$

$$\text{newcrc}[1] = d[6] \wedge d[1] \wedge d[0] \wedge c[0] \wedge c[1] \wedge c[6] \quad (3)$$

$$\text{newcrc}[2] = d[6] \wedge d[2] \wedge d[1] \wedge d[0] \wedge c[0] \wedge c[1] \wedge c[2] \wedge c[6] \quad (4)$$

$$\text{newcrc}[3] = d[7] \wedge d[3] \wedge d[2] \wedge d[1] \wedge c[1] \wedge c[2] \wedge c[3] \wedge c[7] \quad (5)$$

$$\text{newcrc}[4] = d[4] \wedge d[3] \wedge d[2] \wedge c[2] \wedge c[3] \wedge c[4] \quad (6)$$

$$\text{newcrc}[5] = d[5] \wedge d[4] \wedge d[3] \wedge c[3] \wedge c[4] \wedge c[5] \quad (7)$$

$$\text{newcrc}[6] = d[6] \wedge d[5] \wedge d[4] \wedge c[4] \wedge c[5] \wedge c[6] \quad (8)$$

$$\text{newcrc}[7] = d[7] \wedge d[6] \wedge d[5] \wedge c[5] \wedge c[6] \wedge c[7] \quad (9)$$

The following examples show calculated CRC byte based off various input data:

I²C Data 00h : CRC = F3h

I²C Data FFh : CRC = 00h

I²C Data 80h : CRC = 7Ah

I²C Data 4Ch : CRC = 10h

I²C Data E0h : CRC = 5Dh

I²C Data 00000000h : CRC = D1h

I²C Data FFFFFFFFh : CRC = 0Fh

6.5.2 Data Definition

6.5.2.1 Magnetic Sensor Data

The X, Y, and Z magnetic sensor data are stored in `x_MSB_RESULT` and `x_LSB_RESULT` registers. [Figure 6-15](#) shows that each sensor output stored in a 16-bit 2's complement format in two 8-bit registers. The data can be retrieved as 16-bit format combining both MSB and LSB registers, or as 8-bit format through the MSB register.

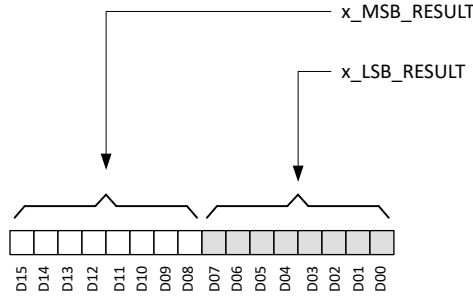

Figure 6-15. Magnetic Sensor Data Definition

The measured magnetic field can be calculated using [Equation 10](#) for 16-bit data, and using [Equation 11](#) for 8-bit data.

$$B = \frac{-(D_{15} \times 2^{15}) + \sum_{i=0}^{14} D_i \times 2^i}{2^{16}} \times 2|B_R| \quad (10)$$

where

- B is magnetic field in mT.
- D_i is the data bit shown in [Figure 6-15](#).
- B_R is the magnetic range in mT for the corresponding channel.

$$B = \frac{-(D_{15} \times 2^7) + \sum_{i=0}^6 D_i \times 8 \times 2^i}{2^8} \times 2|B_R| \quad (11)$$

6.5.2.2 Temperature Sensor Data

The TMAG5273 will measure temperature from $-40\text{ }^\circ\text{C}$ to $170\text{ }^\circ\text{C}$. The temperature sensor data are stored in [T_MSB_RESULT](#) and [T_LSB_RESULT](#) registers. [Figure 6-16](#) shows the sensor output stored in a 16-bit 2's complement format in two 8-bit registers. The data can be retrieved as 16-bit format combining both MSB and LSB registers, or as 8-bit format through the MSB register.

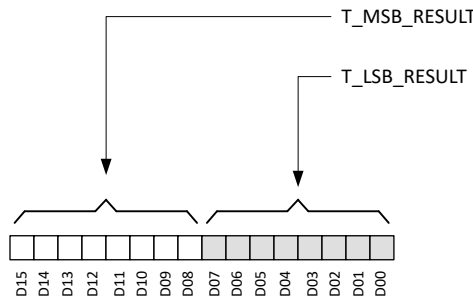

Figure 6-16. Temperature Sensor Data Definition

The measured temperature in degree Celsius can be calculated using [Equation 12](#) for 16-bit data, and using [Equation 13](#) for 8-bit data.

$$T = T_{\text{SENS_T0}} + \frac{T_{\text{ADC_T}} - T_{\text{ADC_T0}}}{T_{\text{ADC_RES}}} \quad (12)$$

where

- T is the measured temperature in degree Celsius.
- $T_{\text{SENS_T0}}$ as listed in the [Electrical Characteristics](#) table.
- $T_{\text{ADC_RES}}$ is the change in ADC code per degree Celsius.

- T_{ADC_T0} as listed in the [Electrical Characteristics](#) table.
- T_{ADC_T} is the measured ADC code for temperature T.

$$T = T_{SENS_T0} + \frac{256 \times \left(T_{ADC_T} - \frac{T_{ADC_T0}}{256} \right)}{T_{ADC_RES}} \quad (13)$$

6.5.2.3 Angle and Magnitude Data Definition

The TMAG5273 calculates the angle from a pair of magnetic axes based off the [ANGLE_EN](#) register bits setting. [Figure 6-17](#) shows the angle information stored in the [ANGLE_RESULT_MSB](#) and [ANGLE_RESULT_LSB](#) registers. Bits D04-D12 store angle integer value from 0 to 360 degree. Bits D00-D03 store fractional angle value. The 3-MSB bits are always populated as b000. The angle can be calculated using [Equation 14](#).

$$A = \sum_{i=4}^{12} D_i \times 2^{i-4} + \frac{\sum_{i=0}^3 D_i \times 2^i}{16} \quad (14)$$

where

- A is the angle measured in degree.
- D_i is the data bit as shown in [Figure 6-17](#).

For example: a 354.50 degree is populated as 0001 0110 0010 1000b and a 17.25 degree is populated as 000 0001 0001 0100b.

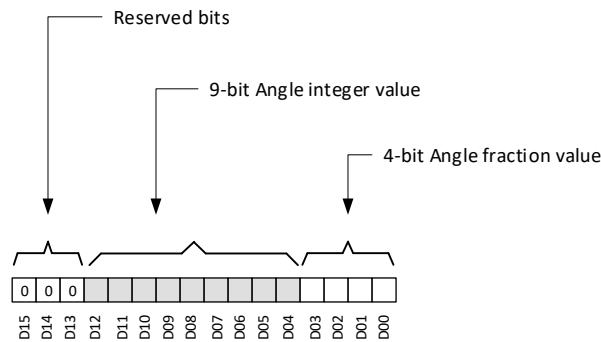

Figure 6-17. Angle Data Definition

During the angle calculation, use [Equation 15](#) to calculate the resultant vector magnitude.

$$M = \sqrt{MADC_{Ch1}^2 + MADC_{Ch2}^2} \quad (15)$$

where

- $MADC_{Ch1}$, $MADC_{Ch2}$ are the ADC codes of the two magnetic channels selected for the angle calculation.

[Figure 6-18](#) shows the magnitude value stored in the [MAGNITUDE_RESULT](#) register. For on-axis angular measurement the magnitude value should remain constant across the full 360° measurement.

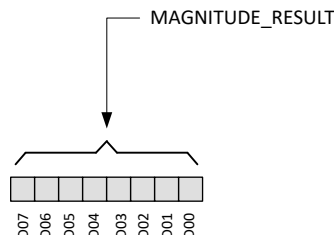

Figure 6-18. Magnitude Result Data Definition

6.5.2.4 Magnetic Sensor Offset Correction

The TMAG5273 enables offset correction for a pair of magnetic axes (see [Figure 6-19](#)). The [MAG_OFFSET_CONFIG_1](#) and [MAG_OFFSET_CONFIG_2](#) registers store the offset values to be corrected in 2's complement data format. As an example, if the uncorrected waveform for a particular axis has a value that is +2mT too high, enter an offset correction value of -2mT in the corresponding offset correction register. The selection and order of the sensors are defined in the [ANGLE_EN](#) register bits setting. The default value of these offset correction registers are set as zero.

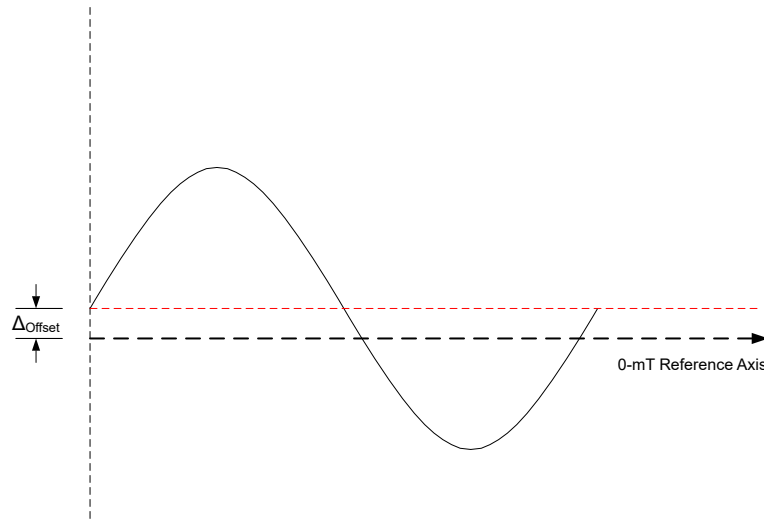

Figure 6-19. Magnetic Sensor Data Offset Correction

The amount of offset for each axis can be calculated using [Equation 16](#). As an example, with a ±40mT range, [MAG_OFFSET_CONFIG_1](#) set at 1000 0000b, and [MAG_OFFSET_CONFIG_2](#) set at 0001 0000b, the offset correction for the first axis is -2.5mT and second axis is 0.312mT.

$$\Delta_{\text{Offset}} = \frac{-(D_7 \times 2^7) + \sum_{i=0}^6 D_i \times 2^i}{2^{12}} \times 2|B_R| \quad (16)$$

where

- Δ_{Offset} is the amount of offset correction to be applied in mT.
- D_i is the data bit in the [MAG_OFFSET_CONFIG_1](#) or [MAG_OFFSET_CONFIG_2](#) register.
- B_R is the magnetic range in mT for the corresponding channel.

Alternately values for [MAG_OFFSET_CONFIG_1](#) or [MAG_OFFSET_CONFIG_2](#) can be calculated for a target offset correction using [Equation 17](#).

$$\text{MAG_OFFSET} = \frac{2^{12} \times \Delta_{\text{Offset}}}{2|B_R|} \quad (17)$$

where

- [MAG_OFFSET](#) is the decimal value to be entered in the [MAG_OFFSET_CONFIG_1](#) or [MAG_OFFSET_CONFIG_2](#) register.
- Δ_{Offset} is the amount of offset correction to be applied in mT.
- B_R is the magnetic range in mT for the corresponding channel.

7 Application and Implementation

Note

Information in the following applications sections is not part of the TI component specification, and TI does not warrant its accuracy or completeness. TI's customers are responsible for determining suitability of components for their purposes, as well as validating and testing their design implementation to confirm system functionality.

7.1 Application Information

7.1.1 Select the Sensitivity Option

Select the highest TMAG5273 sensitivity option that can measure the required range of magnetic flux density so that the ADC input range is maximized.

Larger-sized magnets and farther sensing distances can generally enable better positional accuracy than very small magnets at close distances, because magnetic flux density increases exponentially with the proximity to a magnet. TI created an online tool to help with simple magnet calculations under the [TMAG5273 product folder](#) on ti.com.

7.1.2 Temperature Compensation for Magnets

The TMAG5273 temperature compensation is designed to directly compensate the average temperature drift of several magnets as specified in the [MAG_TEMPCO](#) register bits. The residual induction (B_r) of a magnet typically reduces by 0.12%/°C for NdFeB, and 0.20%/°C for ferrite magnets as the temperature increases. Set the [MAG_TEMPCO](#) bit to default 00b if the device temperature compensation is not needed.

7.1.3 Sensor Conversion

Multiple conversion schemes can be adopted based off the [MAG_CH_EN](#) and [CONV_AVG](#) register bits settings.

7.1.3.1 Continuous Conversion

The TMAG5273 can be set in continuous conversion mode when [OPERATING_MODE](#) is set to 10b. [Figure 7-1](#) shows few examples of continuous conversion. The input magnetic field is processed in two steps. In the first step the device spins the hall sensor elements, and integrates the sampled data. In the second step the ADC block converts the analog signal into digital bits and stores in the corresponding result register. While the ADC starts processing the first magnetic sample, the spin block can start processing another magnetic sample. In this mode the temperature data is taken at the beginning of each new conversion. This temperature data is used to compensate for the magnetic thermal drift.

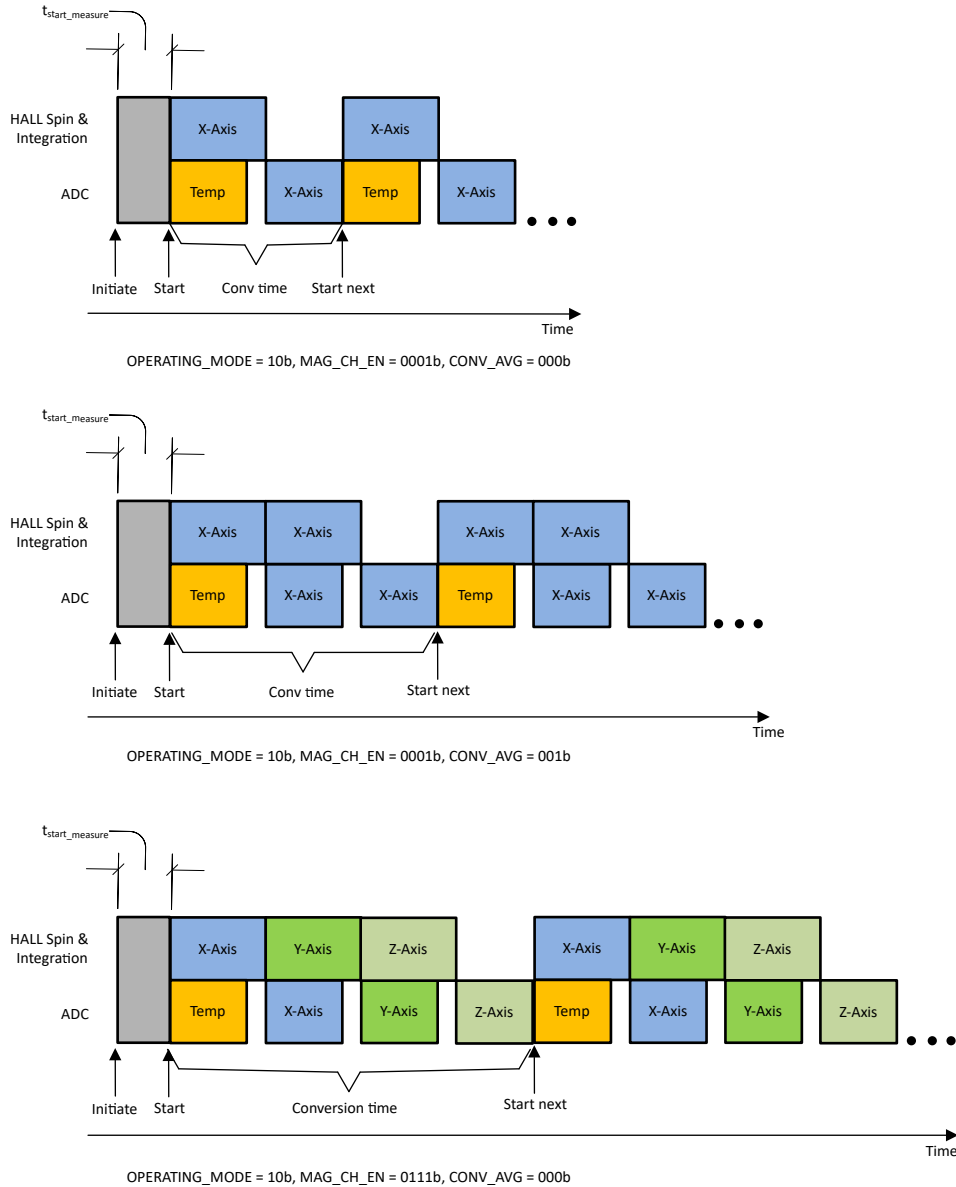

Figure 7-1. Continuous Conversion Examples

7.1.3.2 Trigger Conversion

The TMAG5273 supports trigger conversion with `OPERATING_MODE` set to `00b`. The trigger event can be initiated through I²C command or \overline{INT} signal. Figure 7-2 shows an example of trigger conversion with temperature, X, Y, and Z sensors activated.

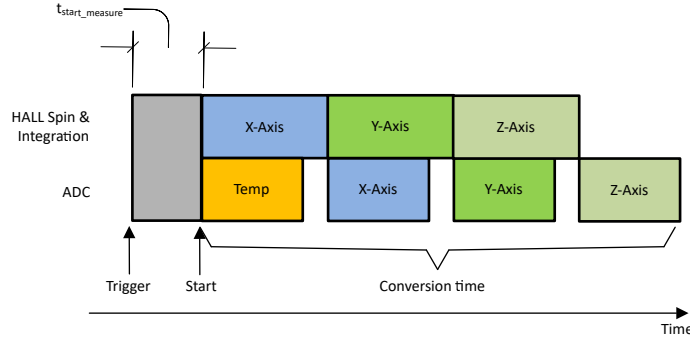

Figure 7-2. Trigger Conversion for Temperature, X, Y, & Z Sensors

7.1.3.3 Pseudo-Simultaneous Sampling

In absolute angle measurement, application sensor data from multiple axes are required to calculate an accurate angle. The magnetic field data collected at different times through the same signal chain introduces error in angle calculation. The TMAG5273 offers pseudo-simultaneous sampling data collection modes to eliminate this error. Figure 7-3 shows an example where MAG_CH_EN is set at 1011b to collect XZX data. Equation 18 shows that the time stamps for the X and Z sensor data are the same.

$$t_z = \frac{t_{x1} + t_{x2}}{2} \tag{18}$$

where

- t_{x1} , t_z , t_{x2} are time stamps for X, Z, X sensor data completion as defined in Figure 7-3.

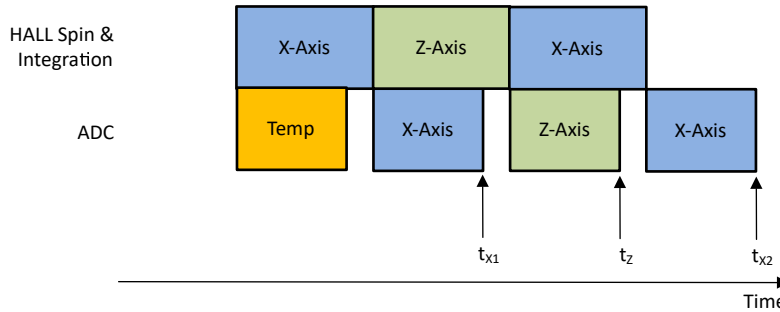

Figure 7-3. XZX Magnetic Field Conversion

The vertical X, Y sensors of the TMAG5273 exhibit more noise than the horizontal Z sensor. The pseudo-simultaneous sampling can be used to equalize the noise floor when two set of vertical sensor data are collected against one set of horizontal sensor data, as in examples of XZX or YZY modes.

7.1.4 Magnetic Limit Check

The TMAG5273 enables magnetic limit checks for single or multiple axes at the same time. Figure 7-4 to Figure 7-7 show examples of magnetic limit cross detection events while the field going above, below, exiting a magnetic band, and entering a magnetic band. The device generates an interrupt with each new conversion if the magnetic fields remain in the shaded regions of the figures. The MAG_THR_DIR and THR_HYST register bits help select different limit cross modes.

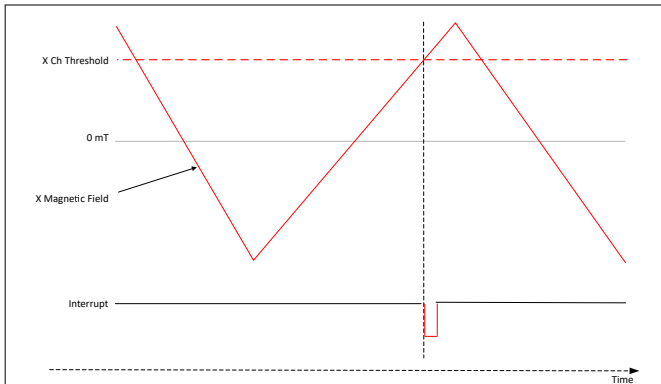

Figure 7-4. Magnetic Upper Limit Cross Check With MAG_THR_DIR =0b, THR_HYST = 000b

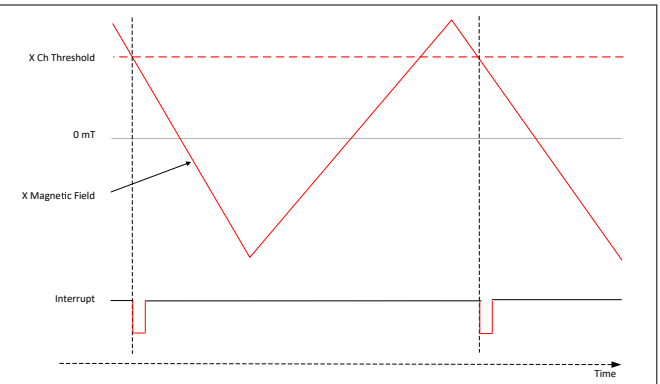

Figure 7-5. Magnetic Lower Limit Cross Check With MAG_THR_DIR =1b, THR_HYST = 000b

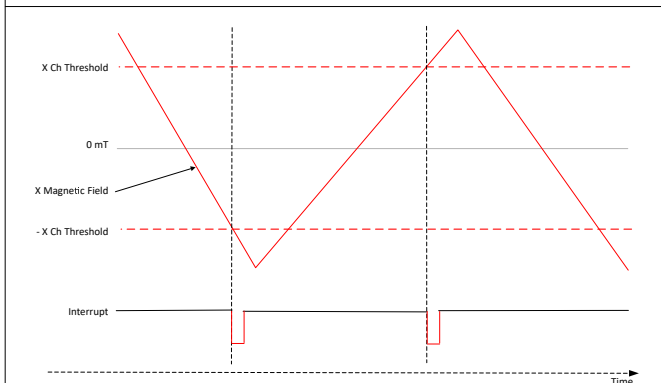

Figure 7-6. Magnetic Field Going Out of Band Check With MAG_THR_DIR =0b, THR_HYST = 001b

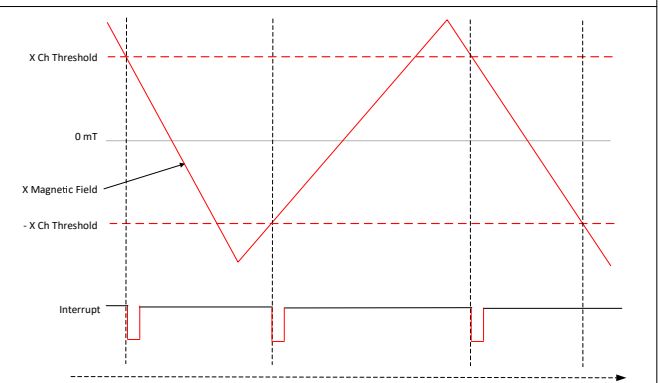

Figure 7-7. Magnetic Field Entering a Band Check With MAG_THR_DIR =1b, THR_HYST = 001b

7.1.5 Error Calculation During Linear Measurement

The TMAG5273 offers independent configurations to perform linear position measurements in X, Y, and Z axes. To calculate the expected error during linear measurement, the contributions from each of the individual error sources must be understood. The relevant error sources include sensitivity error, offset, noise, cross axis sensitivity, hysteresis, nonlinearity, drift across temperature, drift across life time, and so forth. For a 3-axis Hall sensor like the TMAG5273, the cross-axis sensitivity and hysteresis error sources are insignificant. Use [Equation 19](#) to estimate the linear measurement error calculation at room temperature.

$$\text{Error}_{\text{LM}_25\text{C}} = \frac{\sqrt{(B \times \text{SENS}_{\text{ER}})^2 + B_{\text{off}}^2 + N_{\text{RMS}_25}^2}}{B} \times 100\% \quad (19)$$

where

- $\text{Error}_{\text{LM}_25\text{C}}$ is total error in % during linear measurement at 25°C.
- B is input magnetic field.
- SENS_{ER} is sensitivity error in decimal number at 25°C. As an example, enter 0.05 for sensitivity error of 5%.
- B_{off} is offset error at 25°C.
- N_{RMS_25} is RMS noise at 25°C.

In many applications, system level calibration at room temperature can nullify the offset and sensitivity errors at 25°C. The noise errors can be reduced by internally averaging by up to 32x on the device in addition to the averaging that can be done in the microcontroller. Use [Equation 20](#) to estimate the linear measurement error across temperature after calibration at room temperature.

$$\text{Error}_{\text{LM_Temp}} = \frac{\sqrt{(B \times \text{SENS}_{\text{DR}})^2 + B_{\text{off_DR}}^2 + N_{\text{RMS_Temp}}^2}}{B} \times 100\% \quad (20)$$

where

- $\text{Error}_{\text{LM_Temp}}$ is total error in % during linear measurement across temperature after room temperature calibration.
- B is input magnetic field.
- SENS_{DR} is sensitivity drift in decimal number from value at 25°C. As an example, enter 0.05 for sensitivity drift of 5%.
- $B_{\text{off_DR}}$ is offset drift from value at 25°C.
- $N_{\text{RMS_Temp}}$ is RMS noise across temperature.

If room temperature calibration is not performed, sensitivity and offset errors at room temperature must also account for total error calculation across temperature (see [Equation 21](#)).

$$\text{Error}_{\text{LM_Temp_NCal}} = \frac{\sqrt{(B \times \text{SENS}_{\text{ER}})^2 + (B \times \text{SENS}_{\text{DR}})^2 + B_{\text{off}}^2 + B_{\text{off_DR}}^2 + N_{\text{RMS_Temp}}^2}}{B} \times 100\% \quad (21)$$

where

- $\text{Error}_{\text{LM_Temp_NCal}}$ is total error in % during linear measurement across temperature without room temperature calibration.

Note

In this section, error sources such as system mechanical vibration, magnet temperature gradient, earth magnetic field, nonlinearity, lifetime drift, and so forth, are not considered. The user must take these additional error sources into account while calculating overall system error budgets.

7.1.6 Error Calculation During Angular Measurement

The TMAG5273 offers on-chip CORDIC to measure angle data from any of the two magnetic axes. The linear magnetic axis data can be used to calculate the angle using an external CORDIC as well. To calculate the expected error during angular measurement, the contributions from each individual error source must be understood. The relevant error sources include sensitivity error, offset, noise, axis-axis mismatch, nonlinearity, drift across temperature, drift across life time, and so forth. Use the [Angle Error Calculation Tool](#) to estimate the total error during angular measurement.

7.2 Typical Application

Magnetic 3D sensors are very popular due to contactless and reliable measurements, especially in applications requiring long-term measurements in rugged environments. The TMAG5273 offers design flexibility in wide range of industrial and personal electronics applications. In this section three common application examples are discussed in details.

7.2.1 Magnetic Tamper Detection

Given the susceptibility to magnetic tampering, electricity meters often include magnetic sensors designed to detect external magnetic fields and take appropriate actions, such as disconnecting services to the electricity meter or applying a penalty fee for tampering. [Figure 7-8](#) shows that magnetic tampering can result from a permanent magnet in any of the three orientations. Another form of magnetic tampering can be generated through an external coil powered from AC supply mains. The TMAG5273 offers flexible operating modes and configuration of three independent Hall-sensors to detect tampering.

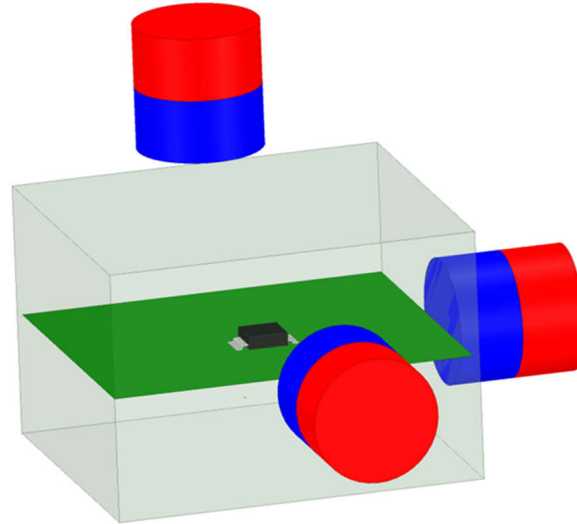

Figure 7-8. TMAG5273 Magnetic Tamper Detection

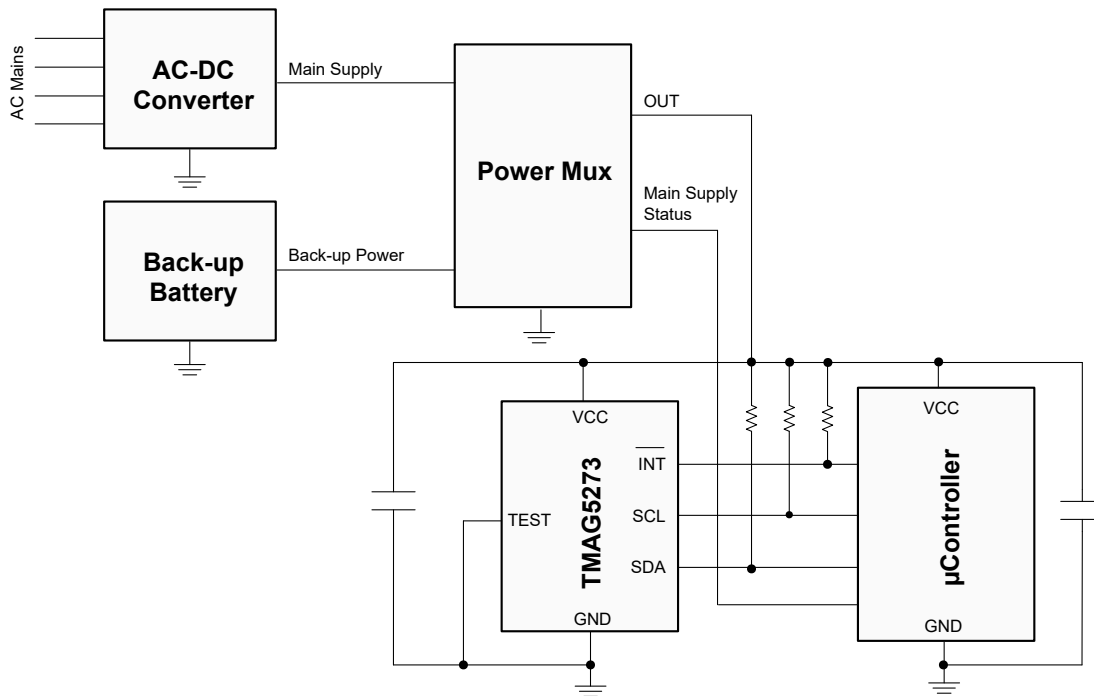

Figure 7-9. TMAG5273 Application Diagram for Tamper Detection

7.2.1.1 Design Requirements

Use the parameters listed in [Table 7-3](#) for this design example.

Table 7-1. Design Parameters

DESIGN PARAMETERS	OPERATING ON AC SUPPLY	OPERATING ON BACK-UP BATTERY
Device	TMAG5273-A2	TMAG5273-A2
VCC	3.3V	3.6V to 1.7V
Operating Mode	Continuous measure mode	Wake-up and sleep mode
Design Objective	Read the raw magnetic data and determine the magnitude and type of tampering (AC or DC magnetic field)	Wake up the microcontroller if magnetic tampering occurs

Table 7-1. Design Parameters (continued)

DESIGN PARAMETERS	OPERATING ON AC SUPPLY	OPERATING ON BACK-UP BATTERY
Timing Budget to Detect Tampering	<100ms	<5s
Desired Battery Life	N/A	5 Year

7.2.1.2 Detailed Design Procedure

Select a power multiplexer that allows powering the system from AC power line as default option. In case of power outage the power multiplexer automatically switches to back-up battery for powering the system. A status signal from, either the AC-DC regulator or the multiplexer, notifies the microcontroller on power outage events. The microcontroller, upon receiving the status signal, configures the TMAG5273 to operate in wake-up and sleep mode. The TMAG5273 wakes up and measures the magnetic field at a prespecified interval. The device repeats the cycle if no tampering happens. In case of tampering, the device can exit the wake-up and sleep mode and send an interrupt signal to the microcontroller.

Perform the following steps to set the device in continuous measure mode and minimize the number of steps required during battery back-up modes:

- Set the [DEVICE_CONFIG_1](#) register to 1h.
- Set the [SENSOR_CONFIG_1](#) register to 79h.
- Set the [T_CONFIG](#) register to 1h.
- Set the [INT_CONFIG_1](#) register to A4h.
- Set the [DEVICE_CONFIG_2](#) register to 22h.
- Wait for the $\overline{\text{INT}}$ signal assert low to indicate conversion complete. When $\overline{\text{INT}}$ goes low, perform the 16-bit T, X, Y, Z register read with one single read command (see [Figure 7-10](#)).

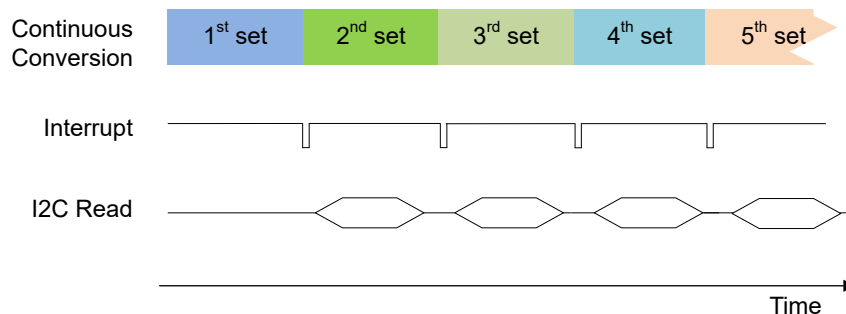
**Figure 7-10. Continuous Conversion With AC Line Power**

During power outage event perform only the following steps to set the sensor in the wake-up and sleep mode:

- Set the [INT_CONFIG_1](#) register to 64h.
- Set the [DEVICE_CONFIG_2](#) register to 23h.
- If a threshold detection even occurs, the $\overline{\text{INT}}$ signal asserts low to wake-up the microcontroller. When $\overline{\text{INT}}$ goes low, perform the 16-bit T, X, Y, Z register read with one single read command (see [Figure 7-11](#)).

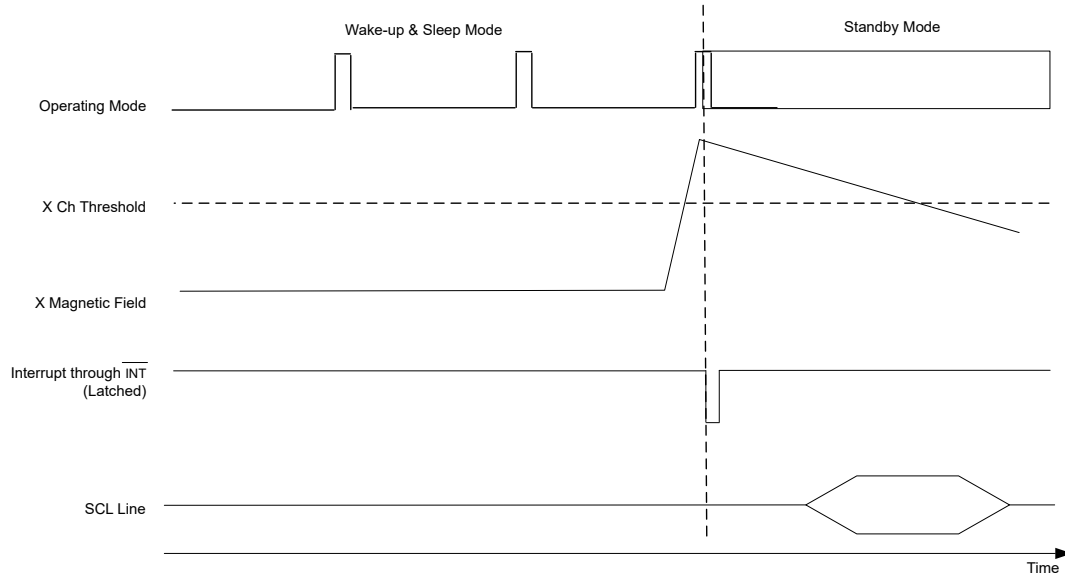

Figure 7-11. Wake-Up and Sleep Mode Operation With Back-Up Battery

7.2.1.3 Application Curves

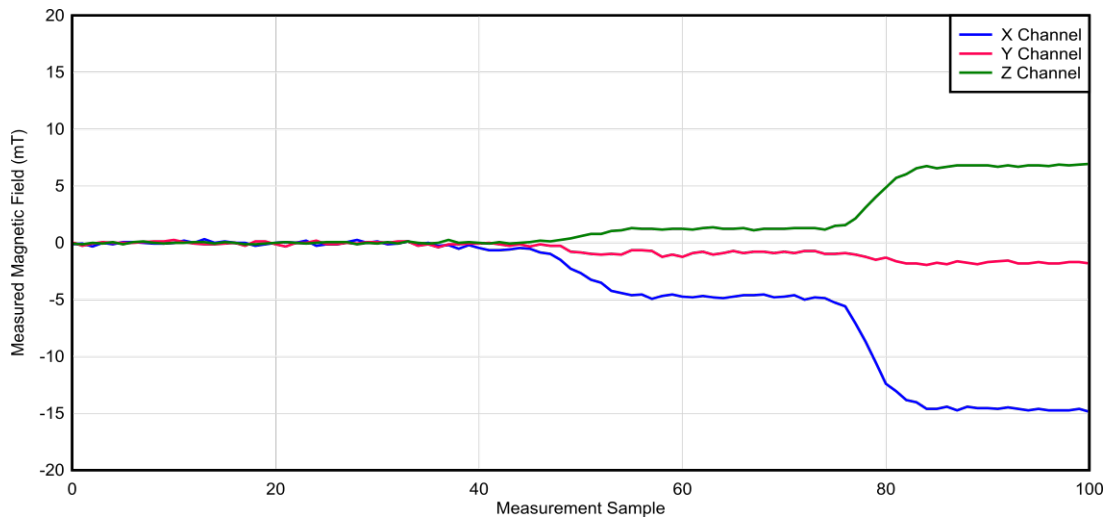

Figure 7-12. Tamper Detection During Continuous Conversion

7.2.2 I²C Address Expansion

The TMAG5273 is offered in four different factory-programmed I²C addresses. The device also supports additional I²C addresses through the configuration of the [I2C_ADDRESS](#) register. There are 7-bits to select 128 different addresses. Take system limitations like bus loading, maximum clock frequency, available GPIOs from a microcontroller, and so forth, in account before selecting maximum number of sensors in a single I²C bus.

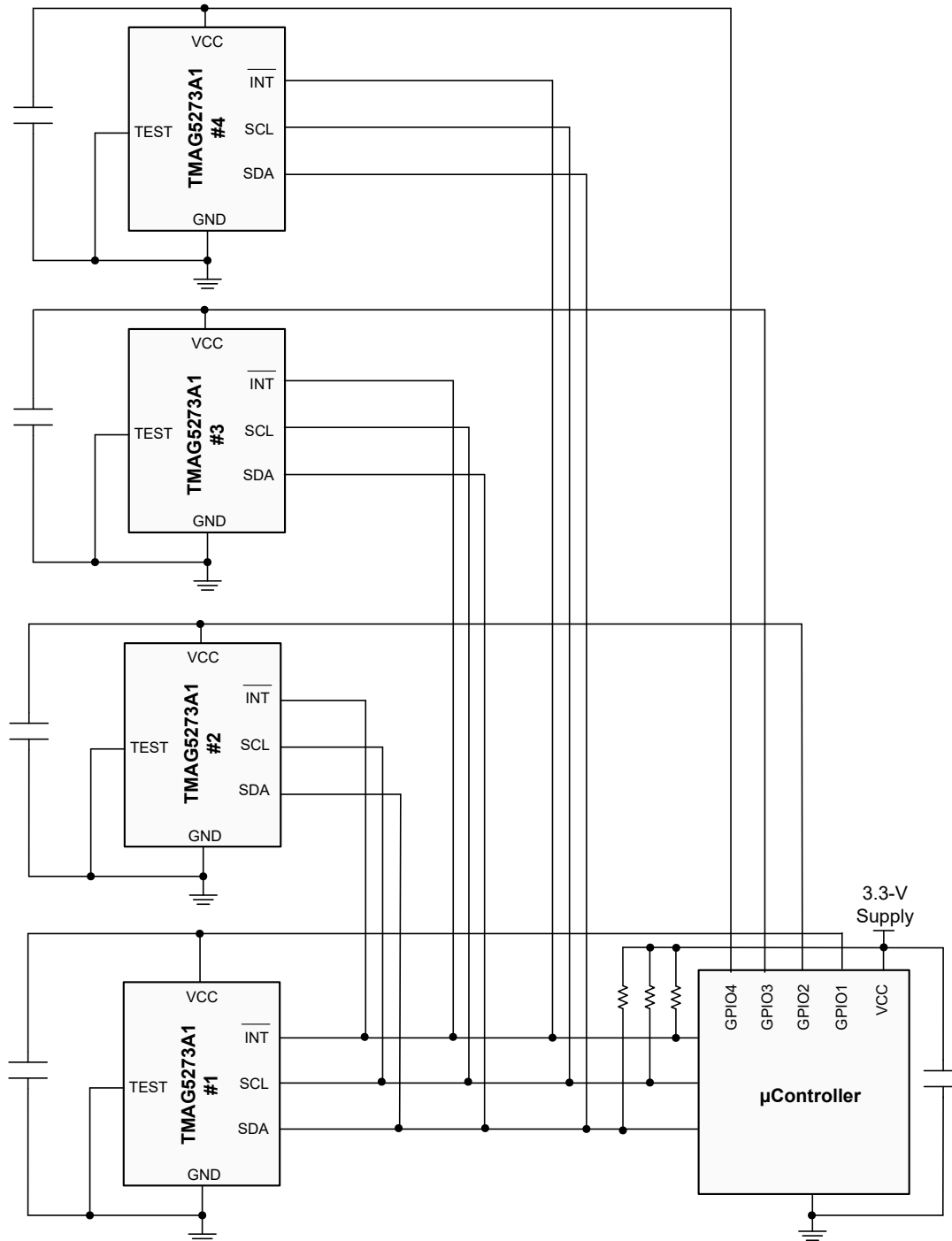

Figure 7-13. TMAG5273 Application Diagram for I²C Address Expansion

7.2.2.1 Design Requirements

Use the parameters listed in [Table 7-3](#) for this design example.

Table 7-2. Design Parameters

PARAMETERS	DESIGN TARGET
Device orderable	TMAG5273A1
VCC	3.3V

Table 7-2. Design Parameters (continued)

PARAMETERS	DESIGN TARGET
# of Devices in same bus	4 (same method can be used to expand the number of sensors in the I ² C bus)
Design objective	Optimize the # GPIO and component count
Current supply per sensor	5mA, supplied by a microcontroller GPIO

7.2.2.2 Detailed Design Procedure

Select GPIO with current supply capability of 5mA. Figure 7-13 shows that the SCL, SDA lines and $\overline{\text{INT}}$ pin can be shared. However, the function of the $\overline{\text{INT}}$ pin needs to be analyzed when shared by multiple sensors. As an example, if the sensors are configured to generate interrupt through the $\overline{\text{INT}}$ pin, the microcontroller needs to read all the sensors to determine which specific one sending the interrupt. Take the following steps sequentially to assign new I²C addresses to the four TMAG5273 shown in Figure 7-14:

- Turn on the GPIO#1 and wait until $t_{\text{start_power_up}}$ time is elapsed.
- Address the device#1 with factory programmed address. Write to the I2C_ADDRESS register to assign a new address.
- Turn on the GPIO#2 and wait until $t_{\text{start_power_up}}$ time is elapsed.
- Address the device#2 with factory programmed address. Write to the I2C_ADDRESS register to assign a new unique address.
- Turn on the GPIO#3 and wait until $t_{\text{start_power_up}}$ time is elapsed.
- Address the device#3 with factory programmed address. Write to the I2C_ADDRESS register to assign a new unique address.
- Turn on the GPIO#4 and wait until $t_{\text{start_power_up}}$ time is elapsed.
- Address the device#4 with factory programmed address. Write to the I2C_ADDRESS register to assign a new unique address.

Repeat the above steps if there is a power outage or power-up reset condition.

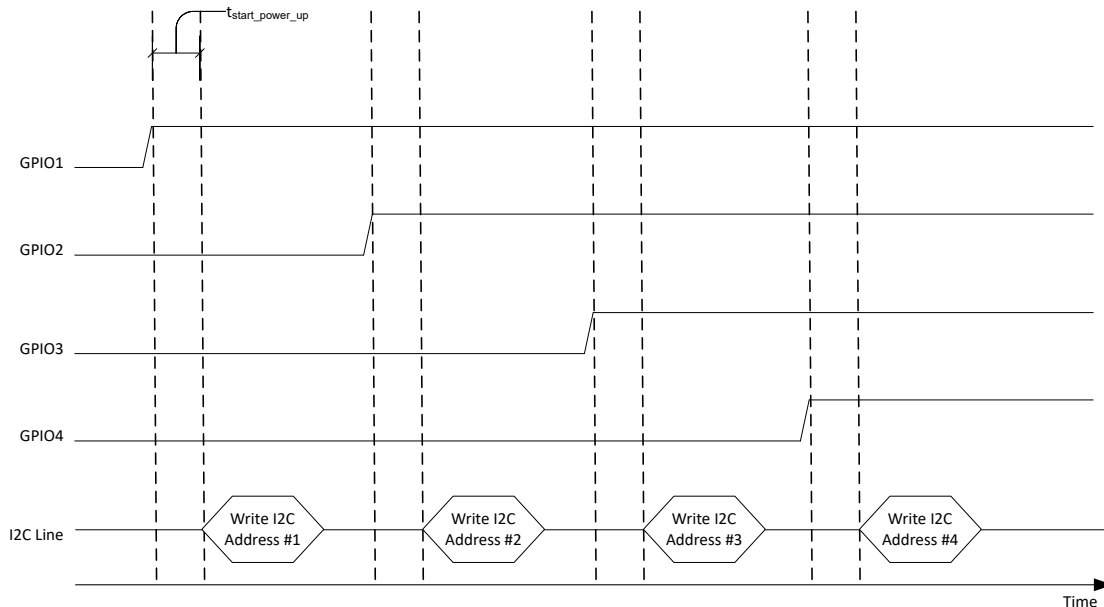

Figure 7-14. Power-Up Timing and I²C Address Allocation for the Four Sensors

7.2.3 Angle Measurement

Magnetic angle sensors are very popular due to contactless and reliable measurements, especially in applications requiring long-term measurements in rugged environments. The TMAG5273 offers an on-chip angle calculator providing angular measurement based off any two of the magnetic axes. The two axes of interest can

be selected in the `ANGLE_EN` register bits. The device offers angle output in complete 360 degree scale. Take several error sources into account for angle calculation, including sensitivity error, offset error, linearity error, noise, mechanical vibration, temperature drift, and so forth.

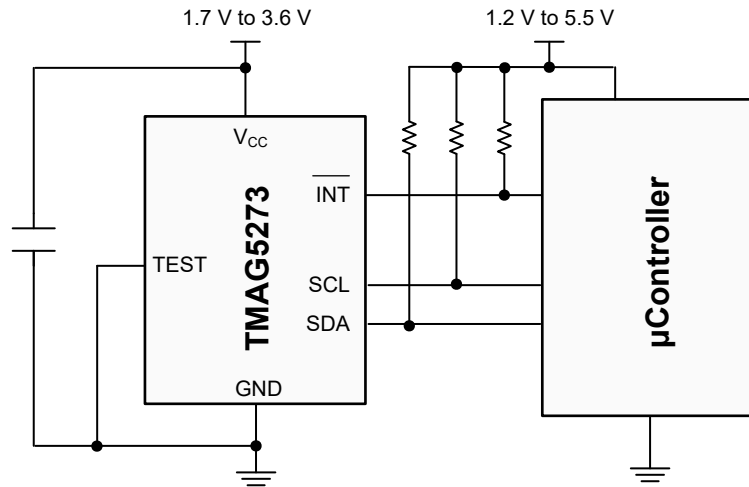

Figure 7-15. TMAG5273 Application Diagram for Angle Measurement

7.2.3.1 Design Requirements

Use the parameters listed in [Table 7-3](#) for this design example.

Table 7-3. Design Parameters

DESIGN PARAMETERS	ON-AXIS MEASUREMENT	OFF-AXIS MEASUREMENT
Device	TMAG5273-A1	TMAG5273-A1
VCC	3.3V	3.3V
Device Position	Directly under the magnet	At the adjacent side of the magnet
Magnet	Cylinder: 4.7625mm diameter, 12.7mm thick, neodymium N52, Br = 1480	Cylinder: 4.7625mm diameter, 12.7mm thick, neodymium N52, Br = 1480
Magnetic Range Selection	Select the same range for both axes based off the highest possible magnetic field seen by the sensor	Select the same range for both axes based off the highest possible magnetic field seen by the sensor
RPM	<600	<600
Desired Accuracy	<2° for 360° rotation	<2° for 360° rotation

7.2.3.2 Detailed Design Procedure

For accurate angle measurement, the two axes amplitudes must be normalized by selecting the proper gain adjustment value in the `MAG_GAIN_CONFIG` register. The gain adjustment value is a fractional decimal number between 0 and 1. The following steps must be followed to calculate this fractional value:

- Set the device at 32x average mode and rotate the shaft full 360 degree.
- Record the two axes sensor ADC codes for the full 360 degree rotation.
- A normalized plot for the full 360 degree rotations are represented in [Figure 7-17](#) or [Figure 7-18](#).
- Measure the maximum peak-peak ADC code delta for each axis, A_X and A_Y .
- If $A_X > A_Y$, set the `MAG_GAIN_CH` register bit to 0b. Calculate the gain adjustment value for X axis: $G_X = \frac{A_Y}{A_X}$
- If $A_X < A_Y$, set the `MAG_GAIN_CH` register bit to 1b. Calculate the gain adjustment value for Y axis: $G_Y = \frac{1}{G_X}$
- The target binary gain setting at the `GAIN_VALUE` register bits are calculated from the equation, G_X or $G_Y = \text{GAIN_VALUE}_{\text{decimal}} / 256$.

Example 1: If $A_X = A_Y = 60,000$, the `GAIN_VALUE` register bits are set at default 0000 0000b.

Example 2: If $A_x = 60,000$, $A_y = 45,000$, the $G_x = 45,000/60,000 = 0.75$. Set `MAG_GAIN_CH` to 0b and `GAIN_VALUE` to 1100 0000b.

Example 3: If $A_x = 45,000$, $A_y = 60,000$, the $G_x = (60,000/45,000) = 1.33$. Since $G_x > 1$, the gain adjustment needs to be applied to Y axis with $G_y = 1/G_x$. Set `MAG_GAIN_CH` to 1b and `GAIN_VALUE` to 1100 0000b.

7.2.3.2.1 Gain Adjustment for Angle Measurement

Common measurement topology include angular position measurements in on-axis or off-axis angular measurements shown in Figure 7-16. Select the on-axis measurement topology whenever possible as this offers the best optimization of magnetic field and the device measurement ranges. The TMAG5273 offers on-chip gain adjustment option to account for mechanical position misalignments.

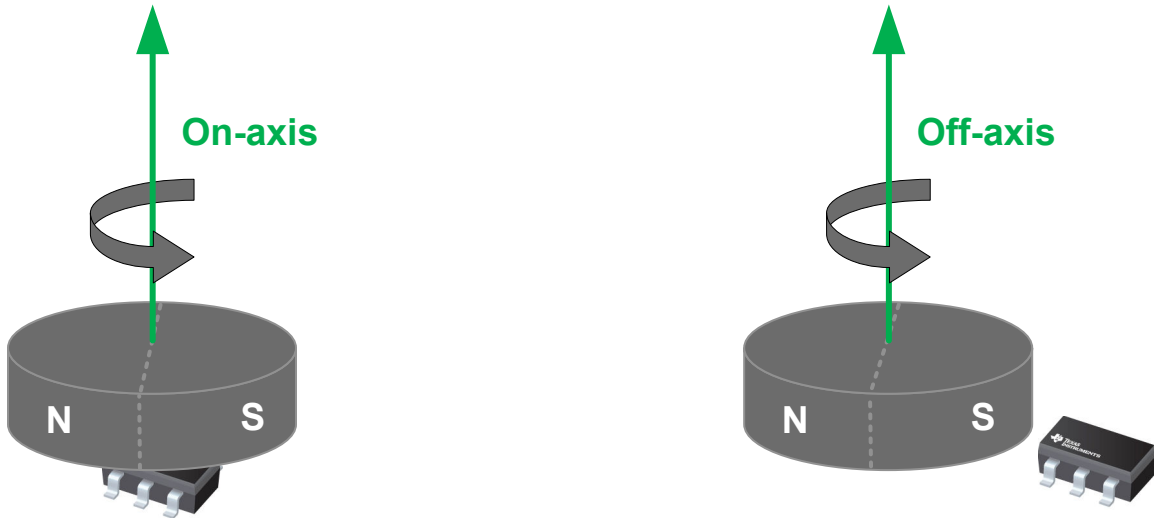

Figure 7-16. On-Axis vs. Off-Axis Angle Measurements

7.2.3.3 Application Curves

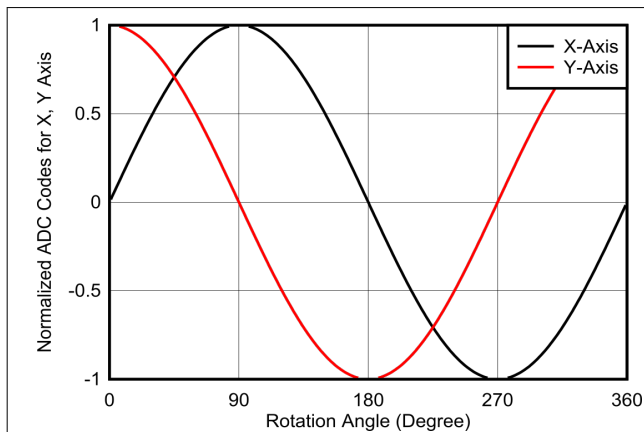

Figure 7-17. X and Y Sensor Data for Full 360 Degree Rotation for On-Axis Measurement

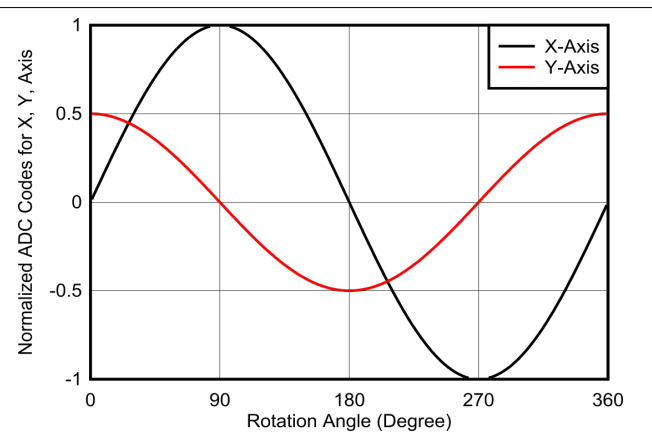

Figure 7-18. X and Y Sensor Data for Full 360 Degree Rotation for Off-Axis Measurement

7.3 Best Design Practices

The TMAG5273 updates the result registers at the end of a conversion. I²C read of the result register needs to be synchronized with the conversion update time to avoid reading a result data while the result register is being updated. For applications with tight timing budget use the $\overline{\text{INT}}$ signal to notify the primary when a conversion is complete.

7.4 Power Supply Recommendations

A decoupling capacitor close to the device must be used to provide local energy with minimal inductance. TI recommends using a ceramic capacitor with a value of at least $0.01\mu\text{F}$. Connect the TEST pin to ground.

7.5 Layout

7.5.1 Layout Guidelines

Magnetic fields pass through most nonferromagnetic materials with no significant disturbance. Embedding Hall effect sensors within plastic or aluminum enclosures and sensing magnets on the outside is common practice. Magnetic fields also easily pass through most printed-circuit boards (PCBs), which makes placing the magnet on the opposite side of the PCB possible.

7.5.2 Layout Example

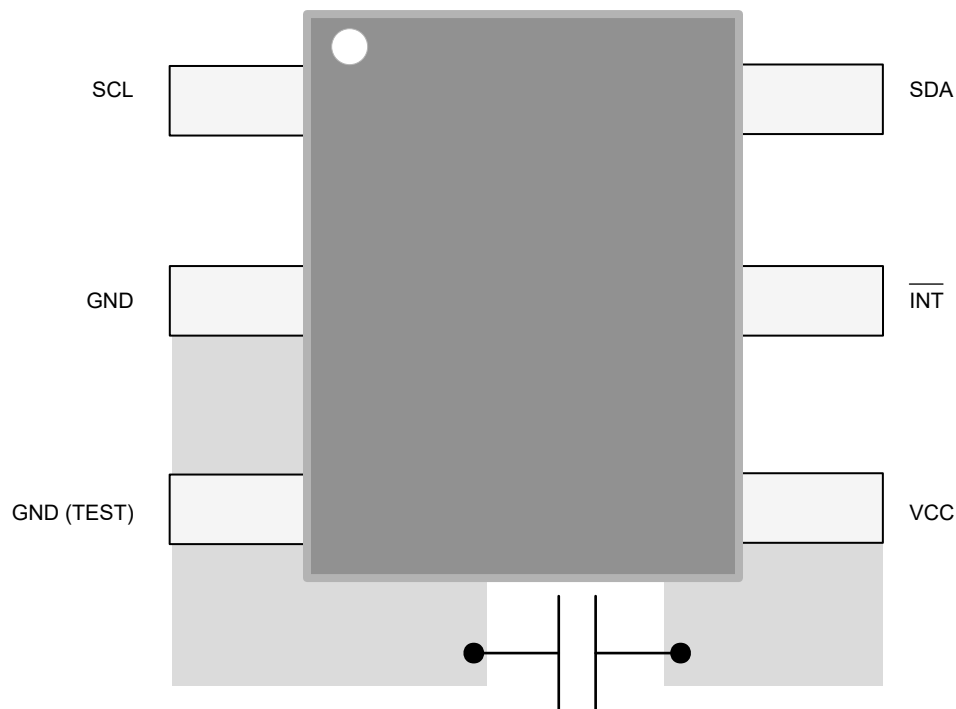

Figure 7-19. Layout Example With TMAG5273

8 Register Maps

8.1 TMAG5273 Registers

Table 8-1 lists the TMAG5273 registers. All register offset addresses not listed in Table 8-1 should be considered as reserved locations and the register contents should not be modified.

User Configuration Registers

Table 8-1. TMAG5273 Registers

Offset	Acronym	Register Name	Section
0h	DEVICE_CONFIG_1	Configure Device Operation Modes	Go
1h	DEVICE_CONFIG_2	Configure Device Operation Modes	Go
2h	SENSOR_CONFIG_1	Sensor Device Operation Modes	Go
3h	SENSOR_CONFIG_2	Sensor Device Operation Modes	Go
4h	X_THR_CONFIG	X Threshold Configuration	Go
5h	Y_THR_CONFIG	Y Threshold Configuration	Go
6h	Z_THR_CONFIG	Z Threshold Configuration	Go
7h	T_CONFIG	Temp Sensor Configuration	Go
8h	INT_CONFIG_1	Configure Device Operation Modes	Go
9h	MAG_GAIN_CONFIG	Configure Device Operation Modes	Go
Ah	MAG_OFFSET_CONFIG_1	Configure Device Operation Modes	Go
Bh	MAG_OFFSET_CONFIG_2	Configure Device Operation Modes	Go
Ch	I2C_ADDRESS	I2C Address Register	Go
Dh	DEVICE_ID	ID for the device die	Go
Eh	MANUFACTURER_ID_LSB	Manufacturer ID lower byte	Go
Fh	MANUFACTURER_ID_MSB	Manufacturer ID upper byte	Go
10h	T_MSB_RESULT	Conversion Result Register	Go
11h	T_LSB_RESULT	Conversion Result Register	Go
12h	X_MSB_RESULT	Conversion Result Register	Go
13h	X_LSB_RESULT	Conversion Result Register	Go
14h	Y_MSB_RESULT	Conversion Result Register	Go
15h	Y_LSB_RESULT	Conversion Result Register	Go
16h	Z_MSB_RESULT	Conversion Result Register	Go
17h	Z_LSB_RESULT	Conversion Result Register	Go
18h	CONV_STATUS	Conversion Status Register	Go
19h	ANGLE_RESULT_MSB	Conversion Result Register	Go
1Ah	ANGLE_RESULT_LSB	Conversion Result Register	Go
1Bh	MAGNITUDE_RESULT	Conversion Result Register	Go
1Ch	DEVICE_STATUS	Device_Diag Status Register	Go

Complex bit access types are encoded to fit into small table cells. Table 8-2 shows the codes that are used for access types in this section.

Table 8-2. TMAG5273 Access Type Codes

Access Type	Code	Description
Read Type		
R	R	Read
Write Type		
W	W	Write

Table 8-2. TMAG5273 Access Type Codes (continued)

Access Type	Code	Description
W1CP	W 1C P	Write 1 to clear Requires privileged access
Reset or Default Value		
- n		Value after reset or the default value

8.1.1 DEVICE_CONFIG_1 Register (Offset = 0h) [Reset = 0h]

DEVICE_CONFIG_1 is shown in [Table 8-3](#).

Return to the [Summary Table](#).

Table 8-3. DEVICE_CONFIG_1 Register Field Descriptions

Bit	Field	Type	Reset	Description
7	CRC_EN	R/W	0h	Enables I2C CRC byte to be sent 0h = CRC disabled 1h = CRC enabled
6-5	MAG_TEMPCO	R/W	0h	Temperature coefficient of the magnet 0h = 0% (No temperature compensation) 1h = 0.12%/ deg C (NdBFe) 2h = Reserved 3h = 0.2%/deg C (Ceramic)
4-2	CONV_AVG	R/W	0h	Enables additional sampling of the sensor data to reduce the noise effect (or to increase resolution) 0h = 1x average, 10.0-kSPS (3-axes) or 20-kSPS (1 axis) 1h = 2x average, 5.7-kSPS (3-axes) or 13.3-kSPS (1 axis) 2h = 4x average, 3.1-kSPS (3-axes) or 8.0-kSPS (1 axis) 3h = 8x average, 1.6-kSPS (3-axes) or 4.4-kSPS (1 axis) 4h = 16x average, 0.8-kSPS (3-axes) or 2.4-kSPS (1 axis) 5h = 32x average, 0.4-kSPS (3-axes) or 1.2-kSPS (1 axis)
1-0	I2C_RD	R/W	0h	Defines the I2C read mode 0h = Standard I2C 3-byte read command 1h = 1-byte I2C read command for 16bit sensor data and conversion status 2h = 1-byte I2C read command for 8 bit sensor MSB data and conversion status 3h = Reserved

8.1.2 DEVICE_CONFIG_2 Register (Offset = 1h) [Reset = 0h]

DEVICE_CONFIG_2 is shown in [Table 8-4](#).

Return to the [Summary Table](#).

Table 8-4. DEVICE_CONFIG_2 Register Field Descriptions

Bit	Field	Type	Reset	Description
7-5	THR_HYST	R/W	0h	Select thresholds for the interrupt function 0h = Takes the 2's complement value of each x_THR_CONFIG register to create a magnetic threshold of the corresponding axis 1h = Takes the 7 LSB bits of the x_THR_CONFIG register to create two opposite magnetic thresholds (one north, and another south) of equal magnitude. 2h = Reserved 3h = Reserved 4h = Reserved 5h = Reserved 6h = Reserved 7h = Reserved

Table 8-4. DEVICE_CONFIG_2 Register Field Descriptions (continued)

Bit	Field	Type	Reset	Description
4	LP_LN	R/W	0h	Selects the modes between low active current or low-noise modes 0h = Low active current mode 1h = Low noise mode
3	I2C_GLITCH_FILTER	R/W	0h	I2C glitch filter 0h = Glitch filter on 1h = Glitch filter off
2	TRIGGER_MODE	R/W	0h	Selects a condition which initiates a single conversion based off already configured registers. A running conversion completes before executing a trigger. Redundant triggers are ignored. TRIGGER_MODE is available only during the mode explicitly mentioned in OPERATING_MODE. 0h = Conversion Start at I2C Command Bits, DEFAULT 1h = Conversion starts through trigger signal at \overline{INT} pin
1-0	OPERATING_MODE	R/W	0h	Selects Operating Mode and updates value based on operating mode if device transitions from Wake-up and sleep mode to Standby mode. 0h = Standby mode (starts new conversion at trigger event) 1h = Sleep mode 2h = Continuous measure mode 3h = Wake-up and sleep mode (W&S mode)

8.1.3 SENSOR_CONFIG_1 Register (Offset = 2h) [Reset = 0h]

SENSOR_CONFIG_1 is shown in [Table 8-5](#).

Return to the [Summary Table](#).

Table 8-5. SENSOR_CONFIG_1 Register Field Descriptions

Bit	Field	Type	Reset	Description
7-4	MAG_CH_EN	R/W	0h	Enables data acquisition of the magnetic axis channel(s) 0h = All magnetic channels of off, DEFAULT 1h = X channel enabled 2h = Y channel enabled 3h = X, Y channel enabled 4h = Z channel enabled 5h = Z, X channel enabled 6h = Y, Z channel enabled 7h = X, Y, Z channel enabled 8h = XYX channel enabled 9h = YXY channel enabled Ah = YZY channel enabled Bh = XZX channel enabled Ch = Reserved Dh = Reserved Eh = Reserved Fh = Reserved

Table 8-5. SENSOR_CONFIG_1 Register Field Descriptions (continued)

Bit	Field	Type	Reset	Description
3-0	SLEEPTIME	R/W	0h	Selects the time spent in low power mode between conversions when OPERATING_MODE = 11b 0h = 1ms 1h = 5ms 2h = 10ms 3h = 15ms 4h = 20ms 5h = 30ms 6h = 50ms 7h = 100ms 8h = 500ms 9h = 1000ms Ah = 2000ms Bh = 5000ms Ch = 20000ms

8.1.4 SENSOR_CONFIG_2 Register (Offset = 3h) [Reset = 0h]

SENSOR_CONFIG_2 is shown in [Table 8-6](#).

Return to the [Summary Table](#).

Table 8-6. SENSOR_CONFIG_2 Register Field Descriptions

Bit	Field	Type	Reset	Description
7	RESERVED	R	0h	Reserved
6	THR_X_COUNT	R/W	0h	Number of threshold crossings before the interrupt is asserted 0h = 1 threshold crossing 1h = 4 threshold crossing
5	MAG_THR_DIR	R/W	0h	Selects the direction of threshold check. This bit is ignored when THR_HYST > 001b 0h = sets interrupt for field above the threshold 1h = sets interrupt for field below the threshold
4	MAG_GAIN_CH	R/W	0h	Selects the axis for magnitude gain correction value entered in MAG_GAIN_CONFIG register 0h = 1st channel is selected for gain adjustment 1h = 2nd channel is selected for gain adjustment
3-2	ANGLE_EN	R/W	0h	Enables angle calculation, magnetic gain, and offset corrections between two selected magnetic channels 0h = No angle calculation, magnitude gain, and offset correction enabled 1h = X 1st, Y 2nd 2h = Y 1st, Z 2nd 3h = X 1st, Z 2nd
1	X_Y_RANGE	R/W	0h	Select the X and Y axes magnetic range from 2 different options. 0h = ±40mT (TMAG5273A1) or ±133mT (TMAG5273A2), DEFAULT 1h = ±80mT (TMAG5273A1) or ±266mT (TMAG5273A2)
0	Z_RANGE	R/W	0h	Select the Z axis magnetic range from 2 different options. 0h = ±40mT (TMAG5273A1) or ±133mT (TMAG5273A2), DEFAULT 1h = ±80mT (TMAG5273A1) or ±266mT (TMAG5273A2)

8.1.5 X_THR_CONFIG Register (Offset = 4h) [Reset = 0h]

X_THR_CONFIG is shown in [Table 8-7](#).

Return to the [Summary Table](#).

Table 8-7. X_THR_CONFIG Register Field Descriptions

Bit	Field	Type	Reset	Description
7-0	X_THR_CONFIG	R/W	0h	8-bit, 2's complement X axis threshold code for limit check. The range of possible threshold entrees can be +/-128. The threshold value in mT is calculated for A1 as $(40(1+X_Y_RANGE)/128)*X_THR_CONFIG$, for A2 as $(133(1+X_Y_RANGE)/128)*X_THR_CONFIG$. Default 0h means no threshold comparison.

8.1.6 Y_THR_CONFIG Register (Offset = 5h) [Reset = 0h]

Y_THR_CONFIG is shown in [Table 8-8](#).

Return to the [Summary Table](#).

Table 8-8. Y_THR_CONFIG Register Field Descriptions

Bit	Field	Type	Reset	Description
7-0	Y_THR_CONFIG	R/W	0h	8-bit, 2's complement Y axis threshold code for limit check. The range of possible threshold entrees can be +/-128. The threshold value in mT is calculated for A1 as $(40(1+X_Y_RANGE)/128)*X_THR_CONFIG$, for A2 as $(133(1+X_Y_RANGE)/128)*X_THR_CONFIG$. Default 0h means no threshold comparison.

8.1.7 Z_THR_CONFIG Register (Offset = 6h) [Reset = 0h]

Z_THR_CONFIG is shown in [Table 8-9](#).

Return to the [Summary Table](#).

Table 8-9. Z_THR_CONFIG Register Field Descriptions

Bit	Field	Type	Reset	Description
7-0	Z_THR_CONFIG	R/W	0h	8-bit, 2's complement Z axis threshold code for limit check. The range of possible threshold entrees can be +/-128. The threshold value in mT is calculated for A1 as $(40(1+Z_RANGE)/128)*Z_THR_CONFIG$, for A2 as $(133(1+Z_RANGE)/128)*Z_THR_CONFIG$. Default 0h means no threshold comparison.

8.1.8 T_CONFIG Register (Offset = 7h) [Reset = 0h]

T_CONFIG is shown in [Table 8-10](#).

Return to the [Summary Table](#).

Table 8-10. T_CONFIG Register Field Descriptions

Bit	Field	Type	Reset	Description
7-1	T_THR_CONFIG	R/W	0h	Temperature threshold code entered by user. The valid temperature threshold ranges are -41C to 170C with the threshold codes for -41C = 1Ah, and 170C = 34h. Resolution is 8 degree C/ LSB. Default 0h means no threshold comparison.
0	T_CH_EN	R/W	0h	Enables data acquisition of the temperature channel 0h = Temp channel disabled 1h = Temp channel enabled

8.1.9 INT_CONFIG_1 Register (Offset = 8h) [Reset = 0h]

INT_CONFIG_1 is shown in [Table 8-11](#).

Return to the [Summary Table](#).

Table 8-11. INT_CONFIG_1 Register Field Descriptions

Bit	Field	Type	Reset	Description
7	RSLT_INT	R/W	0h	Enable interrupt response on conversion complete. 0h = Interrupt is not asserted when the configured set of conversions are complete 1h = Interrupt is asserted when the configured set of conversions are complete
6	THRSLD_INT	R/W	0h	Enable interrupt response on a predefined threshold cross. 0h = Interrupt is not asserted when a threshold is crossed 1h = Interrupt is asserted when a threshold is crossed
5	INT_STATE	R/W	0h	$\overline{\text{INT}}$ interrupt latched or pulsed. 0h = $\overline{\text{INT}}$ interrupt latched until clear by a primary addressing the device 1h = $\overline{\text{INT}}$ interrupt pulse for 10us
4-2	INT_MODE	R/W	0h	Interrupt mode select. 0h = No interrupt 1h = Interrupt through $\overline{\text{INT}}$ 2h = Interrupt through $\overline{\text{INT}}$ except when I2C bus is busy. 3h = Interrupt through SCL 4h = Interrupt through SCL except when I2C bus is busy. 5h = Reserved 6h = Reserved 7h = Reserved
1	RESERVED	R	0h	Reserved
0	MASK_INTB	R/W	0h	Mask $\overline{\text{INT}}$ pin when $\overline{\text{INT}}$ connected to GND 0h = $\overline{\text{INT}}$ pin is enabled 1h = $\overline{\text{INT}}$ pin is disabled (for wake-up and trigger functions)

8.1.10 MAG_GAIN_CONFIG Register (Offset = 9h) [Reset = 0h]

MAG_GAIN_CONFIG is shown in [Table 8-12](#).

Return to the [Summary Table](#).

Table 8-12. MAG_GAIN_CONFIG Register Field Descriptions

Bit	Field	Type	Reset	Description
7-0	GAIN_VALUE	R/W	0h	8-bit gain value determined by a primary to adjust a Hall axis gain. The particular axis is selected based off the settings of MAG_GAIN_CH and ANGLE_EN register bits. The binary 8-bit input is interpreted as a fractional value in between 0 and 1 based off the formula, 'user entered value in decimal/256'. Gain value of 0 is interpreted by the device as 1.

8.1.11 MAG_OFFSET_CONFIG_1 Register (Offset = Ah) [Reset = 0h]

MAG_OFFSET_CONFIG_1 is shown in [Table 8-13](#).

Return to the [Summary Table](#).

Table 8-13. MAG_OFFSET_CONFIG_1 Register Field Descriptions

Bit	Field	Type	Reset	Description
7-0	OFFSET_VALUE_1ST	R/W	0h	8-bit, 2's complement offset value determined by a primary to adjust first axis offset value. The range of possible offset valid entrees can be +/-128. The offset value is calculated by multiplying bit resolution with the entered value.

8.1.12 MAG_OFFSET_CONFIG_2 Register (Offset = Bh) [Reset = 0h]

MAG_OFFSET_CONFIG_2 is shown in [Table 8-14](#).

Return to the [Summary Table](#).

Table 8-14. MAG_OFFSET_CONFIG_2 Register Field Descriptions

Bit	Field	Type	Reset	Description
7-0	OFFSET_VALUE_2ND	R/W	0h	8-bit, 2's complement offset value determined by a primary to adjust second axis offset value. The range of possible offset valid entries can be +/-128. The offset value is calculated by multiplying bit resolution with the entered value.

8.1.13 I2C_ADDRESS Register (Offset = Ch) [Reset = 6Ah]

I2C_ADDRESS is shown in [Table 8-15](#).

Return to the [Summary Table](#).

Table 8-15. I2C_ADDRESS Register Field Descriptions

Bit	Field	Type	Reset	Description
7-1	I2C_ADDRESS	R/W	35h	7-bit default factory I2C address is loaded from OTP during first power up. Change these bits to a new setting if a new I2C address is required (at each power cycle these bits must be written again to avoid going back to default factory address).
0	I2C_ADDRESS_UPDATE_EN	R/W	0h	Enable a new user defined I2C address. 0h = Disable update of I2C address 1h = Enable update of I2C address with bits (7:1)

8.1.14 DEVICE_ID Register (Offset = Dh) [Reset = xh]

DEVICE_ID is shown in [Table 8-16](#).

Return to the [Summary Table](#).

Table 8-16. DEVICE_ID Register Field Descriptions

Bit	Field	Type	Reset	Description
7-2	RESERVED	R	xh	Reserved
1-0	VER	R	xh	Device version indicator. Reset value of DEVICE_ID depends on the orderable part number. 0h = Reserved 1h = ±40-mT and ±80-mT range 2h = ±133-mT and ±266-mT range 3h = Reserved

8.1.15 MANUFACTURER_ID_LSB Register (Offset = Eh) [Reset = 49h]

MANUFACTURER_ID_LSB is shown in [Table 8-17](#).

Return to the [Summary Table](#).

Table 8-17. MANUFACTURER_ID_LSB Register Field Descriptions

Bit	Field	Type	Reset	Description
7-0	MANUFACTURER_ID_[7:0]	R	49h	8-bit unique manufacturer ID

8.1.16 MANUFACTURER_ID_MSB Register (Offset = Fh) [Reset = 54h]

MANUFACTURER_ID_MSB is shown in [Table 8-18](#).

Return to the [Summary Table](#).

Table 8-18. MANUFACTURER_ID_MSB Register Field Descriptions

Bit	Field	Type	Reset	Description
7-0	MANUFACTURER_ID_[15:8]	R	54h	8-bit unique manufacturer ID

8.1.17 T_MSB_RESULT Register (Offset = 10h) [Reset = 0h]

T_MSB_RESULT is shown in [Table 8-19](#).

Return to the [Summary Table](#).

Table 8-19. T_MSB_RESULT Register Field Descriptions

Bit	Field	Type	Reset	Description
7-0	T_CH_RESULT [15:8]	R	0h	T-channel data conversion results, MSB 8 bits.

8.1.18 T_LSB_RESULT Register (Offset = 11h) [Reset = 0h]

T_LSB_RESULT is shown in [Table 8-20](#).

Return to the [Summary Table](#).

Table 8-20. T_LSB_RESULT Register Field Descriptions

Bit	Field	Type	Reset	Description
7-0	T_CH_RESULT [7:0]	R	0h	T-channel data conversion results, LSB 8 bits.

8.1.19 X_MSB_RESULT Register (Offset = 12h) [Reset = 0h]

X_MSB_RESULT is shown in [Table 8-21](#).

Return to the [Summary Table](#).

Table 8-21. X_MSB_RESULT Register Field Descriptions

Bit	Field	Type	Reset	Description
7-0	X_CH_RESULT [15:8]	R	0h	X-channel data conversion results, MSB 8 bits.

8.1.20 X_LSB_RESULT Register (Offset = 13h) [Reset = 0h]

X_LSB_RESULT is shown in [Table 8-22](#).

Return to the [Summary Table](#).

Table 8-22. X_LSB_RESULT Register Field Descriptions

Bit	Field	Type	Reset	Description
7-0	X_CH_RESULT [7:0]	R	0h	X-channel data conversion results, LSB 8 bits.

8.1.21 Y_MSB_RESULT Register (Offset = 14h) [Reset = 0h]

Y_MSB_RESULT is shown in [Table 8-23](#).

Return to the [Summary Table](#).

Table 8-23. Y_MSB_RESULT Register Field Descriptions

Bit	Field	Type	Reset	Description
7-0	Y_CH_RESULT [15:8]	R	0h	Y-channel data conversion results, MSB 8 bits.

8.1.22 Y_LSB_RESULT Register (Offset = 15h) [Reset = 0h]

Y_LSB_RESULT is shown in [Table 8-24](#).

Return to the [Summary Table](#).

Table 8-24. Y_LSB_RESULT Register Field Descriptions

Bit	Field	Type	Reset	Description
7-0	Y_CH_RESULT [7:0]	R	0h	Y-channel data conversion results, LSB 8 bits.

8.1.23 Z_MSB_RESULT Register (Offset = 16h) [Reset = 0h]

Z_MSB_RESULT is shown in [Table 8-25](#).

Return to the [Summary Table](#).

Table 8-25. Z_MSB_RESULT Register Field Descriptions

Bit	Field	Type	Reset	Description
7-0	Z_CH_RESULT [15:8]	R	0h	Z-channel data conversion results, MSB 8 bits.

8.1.24 Z_LSB_RESULT Register (Offset = 17h) [Reset = 0h]

Z_LSB_RESULT is shown in [Table 8-26](#).

Return to the [Summary Table](#).

Table 8-26. Z_LSB_RESULT Register Field Descriptions

Bit	Field	Type	Reset	Description
7-0	Z_CH_RESULT [7:0]	R	0h	Z-channel data conversion results, LSB 8 bits.

8.1.25 CONV_STATUS Register (Offset = 18h) [Reset = 10h]

CONV_STATUS is shown in [Table 8-27](#).

Return to the [Summary Table](#).

Table 8-27. CONV_STATUS Register Field Descriptions

Bit	Field	Type	Reset	Description
7-5	SET_COUNT	R	0h	Rolling Count of Conversion Data Sets
4	POR	R/W1CP	1h	Device powered up, or experienced power-on-reset. Bit is clear when host writes back 1. 0h = No POR 1h = POR occurred
3-2	RESERVED	R	0h	Reserved
1	DIAG_STATUS	R	0h	Detect any internal diagnostics fail which include VCC UV, internal memory CRC error, INT pin error and internal clock error. Ignore this bit status if VCC < 2.3V. 0h = No diag fail 1h = Diag fail detected

Table 8-27. CONV_STATUS Register Field Descriptions (continued)

Bit	Field	Type	Reset	Description
0	RESULT_STATUS	R	0h	Conversion data buffer is ready to be read. 0h = Conversion data not complete 1h = Conversion data complete

8.1.26 ANGLE_RESULT_MSB Register (Offset = 19h) [Reset = 0h]

ANGLE_RESULT_MSB is shown in [Table 8-28](#).

Return to the [Summary Table](#).

Table 8-28. ANGLE_RESULT_MSB Register Field Descriptions

Bit	Field	Type	Reset	Description
7-0	ANGLE_RESULT_MSB	R	0h	Angle measurement result in degree. The data is displayed from 0 to 360 degree in 13 LSB bits after combining the ANGLE_RESULT_MSB and _LSB bits. The 4 LSB bits allocated for fraction of an angle in the format (xxxx/16).

8.1.27 ANGLE_RESULT_LSB Register (Offset = 1Ah) [Reset = 0h]

ANGLE_RESULT_LSB is shown in [Table 8-29](#).

Return to the [Summary Table](#).

Table 8-29. ANGLE_RESULT_LSB Register Field Descriptions

Bit	Field	Type	Reset	Description
7-0	ANGLE_RESULT_LSB	R	0h	Angle measurement result in degree. The data is displayed from 0 to 360 degree in 13 LSB bits after combining the ANGLE_RESULT_MSB and _LSB bits. The 4 LSB bits allocated for fraction of an angle in the format (xxxx/16).

8.1.28 MAGNITUDE_RESULT Register (Offset = 1Bh) [Reset = 0h]

MAGNITUDE_RESULT is shown in [Table 8-30](#).

Return to the [Summary Table](#).

Table 8-30. MAGNITUDE_RESULT Register Field Descriptions

Bit	Field	Type	Reset	Description
7-0	MAGNITUDE_RESULT	R	0h	Resultant vector magnitude (during angle measurement) result. This value should be constant during 360 degree measurements

8.1.29 DEVICE_STATUS Register (Offset = 1Ch) [Reset = 10h]

DEVICE_STATUS is shown in [Table 8-31](#).

Return to the [Summary Table](#).

Table 8-31. DEVICE_STATUS Register Field Descriptions

Bit	Field	Type	Reset	Description
7-5	RESERVED	R	0h	Reserved
4	INTB_RB	R	1h	Indicates the level that the device is reading back from INT pin. The reset value of DEVICE_STATUS depends on the status of the INT pin at power-up. 0h = INT pin driven low 1h = INT pin status high

Table 8-31. DEVICE_STATUS Register Field Descriptions (continued)

Bit	Field	Type	Reset	Description
3	OSC_ER	R/W1CP	0h	Indicates if Oscillator error is detected. Bit is clear when host writes back 1. 0h = No Oscillator error detected 1h = Oscillator error detected
2	INT_ER	R/W1CP	0h	Indicates if $\overline{\text{INT}}$ pin error is detected. Bit is clear when host writes back 1. 0h = No $\overline{\text{INT}}$ error detected 1h = $\overline{\text{INT}}$ error detected
1	OTP_CRC_ER	R/W1CP	0h	Indicates if OTP CRC error is detected. Bit is clear when host writes back 1. 0h = No OTP CRC error detected 1h = OTP CRC error detected
0	VCC_UV_ER	R/W1CP	0h	Indicates if VCC undervoltage was detected. Bit is clear when host writes back 1. Ignore this bit status if VCC < 2.3V. 0h = No VCC UV detected 1h = VCC UV detected

9 Device and Documentation Support

9.1 Documentation Support

9.1.1 Related Documentation

For related documentation see the following:

- Texas Instruments, [HALL-ADAPTER-EVM User's Guide](#)
- Texas Instruments, [TMAG5173 Evaluation Manual user's guide](#)
- Texas Instruments, [Angle Measurement With Multi-Axis Linear Hall-Effect Sensors application note](#)
- Texas Instruments, [Absolute Angle Measurements for Rotational Motion Using Hall-Effect Sensors application brief](#)
- Texas Instruments, [Limit Detection for Tamper and End-of-Travel Detection Using Hall-Effect Sensors application brief](#)

9.2 Receiving Notification of Documentation Updates

To receive notification of documentation updates, navigate to the device product folder on [ti.com](#). Click on *Notifications* to register and receive a weekly digest of any product information that has changed. For change details, review the revision history included in any revised document.

9.3 Support Resources

[TI E2E™ support forums](#) are an engineer's go-to source for fast, verified answers and design help — straight from the experts. Search existing answers or ask your own question to get the quick design help you need.

Linked content is provided "AS IS" by the respective contributors. They do not constitute TI specifications and do not necessarily reflect TI's views; see TI's [Terms of Use](#).

9.4 Trademarks

TI E2E™ is a trademark of Texas Instruments.

All trademarks are the property of their respective owners.

9.5 Electrostatic Discharge Caution



This integrated circuit can be damaged by ESD. Texas Instruments recommends that all integrated circuits be handled with appropriate precautions. Failure to observe proper handling and installation procedures can cause damage.

ESD damage can range from subtle performance degradation to complete device failure. Precision integrated circuits may be more susceptible to damage because very small parametric changes could cause the device not to meet its published specifications.

9.6 Glossary

[TI Glossary](#) This glossary lists and explains terms, acronyms, and definitions.

10 Revision History

NOTE: Page numbers for previous revisions may differ from page numbers in the current version.

Changes from Revision A (September 2021) to Revision B (July 2024)	Page
• Updated formatting of ICC_DCM parameter in the <i>Electrical Characteristics</i> section.....	6
• Updated the formatting of the <i>Magnetic Characteristics for A1</i> test conditions.....	8
• Updated the formatting of the <i>Magnetic Characteristics for A2</i> test conditions.....	9
• Updated the formatting of the <i>Power up & Conversion Time</i> test conditions.....	10
• Added information about the $\overline{\text{INT}}$ function during the transition from sleep mode to standby mode.....	18
• Added sentence: The result interrupt function is not available during the W&S mode.....	18
• Removed the exception note with CRC support for long data stream	21
• Removed the exception note with CRC enabled	21
• Changed DEVICE_ID register reset from 1h to xh.....	41

Changes from Revision * (June 2021) to Revision A (September 2021)	Page
• Changed data sheet status from Advanced Information to Production Data.....	1

11 Mechanical, Packaging, and Orderable Information

The following pages include mechanical, packaging, and orderable information. This information is the most current data available for the designated devices. This data is subject to change without notice and revision of this document. For browser-based versions of this data sheet, refer to the left-hand navigation.

TMAG5173xxx/TMAG5273xxx
DBV0006A-C02



PACKAGE OUTLINE
SOT-23 - 1.4 mm max height

SMALL OUTLINE TRANSISTOR

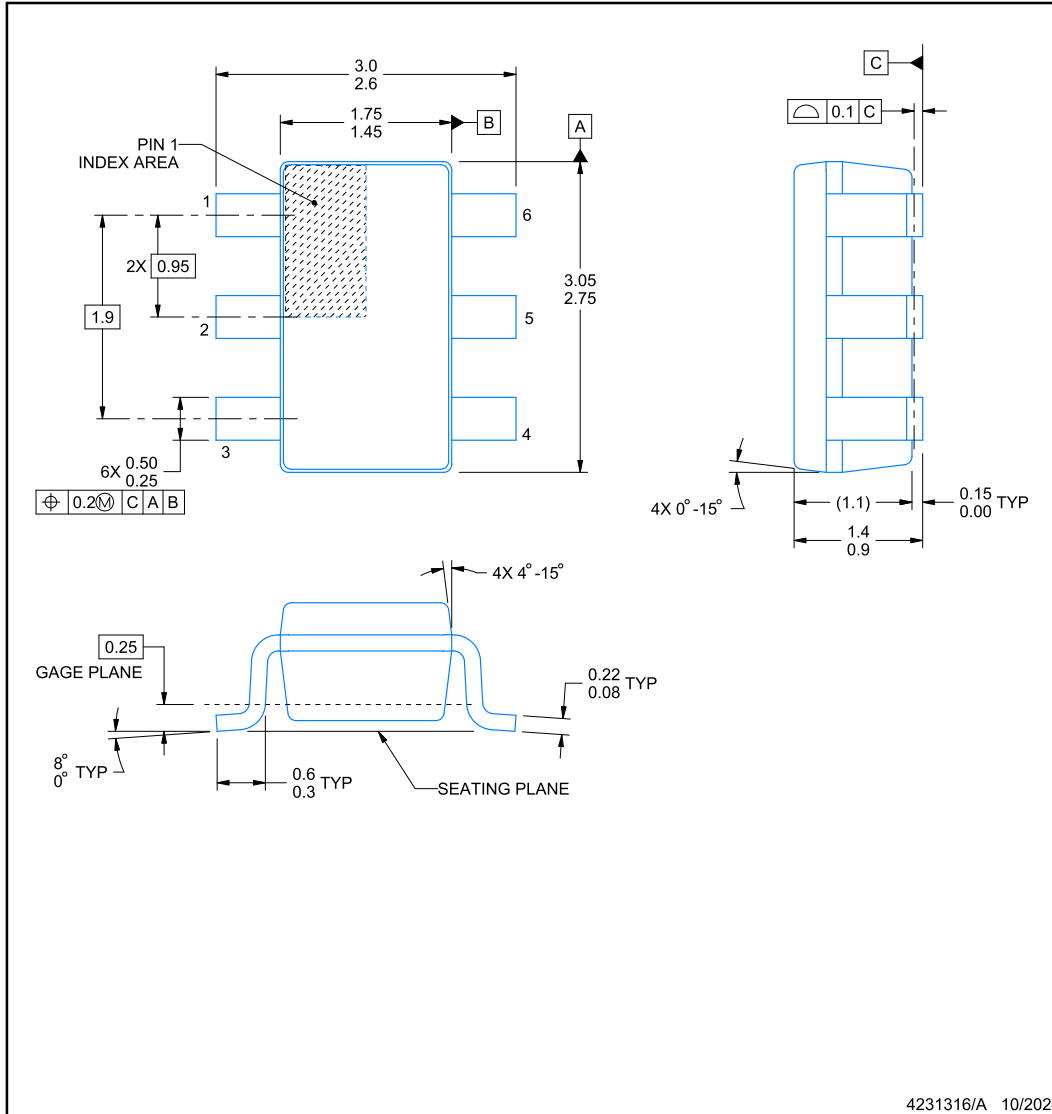

NOTES:

1. All linear dimensions are in millimeters. Any dimensions in parenthesis are for reference only. Dimensioning and tolerancing per ASME Y14.5M.
2. This drawing is subject to change without notice.
3. Body dimensions do not include mold flash or protrusion. Mold flash and protrusion shall not exceed 0.25 per side.
4. Leads 1,2,3 may be wider than leads 4,5,6 for package orientation.
5. Reference JEDEC MO-178.



TMAG5173xxx/TMAG5273xxx
DBV0006A-C02

EXAMPLE BOARD LAYOUT

SOT-23 - 1.4 mm max height

SMALL OUTLINE TRANSISTOR

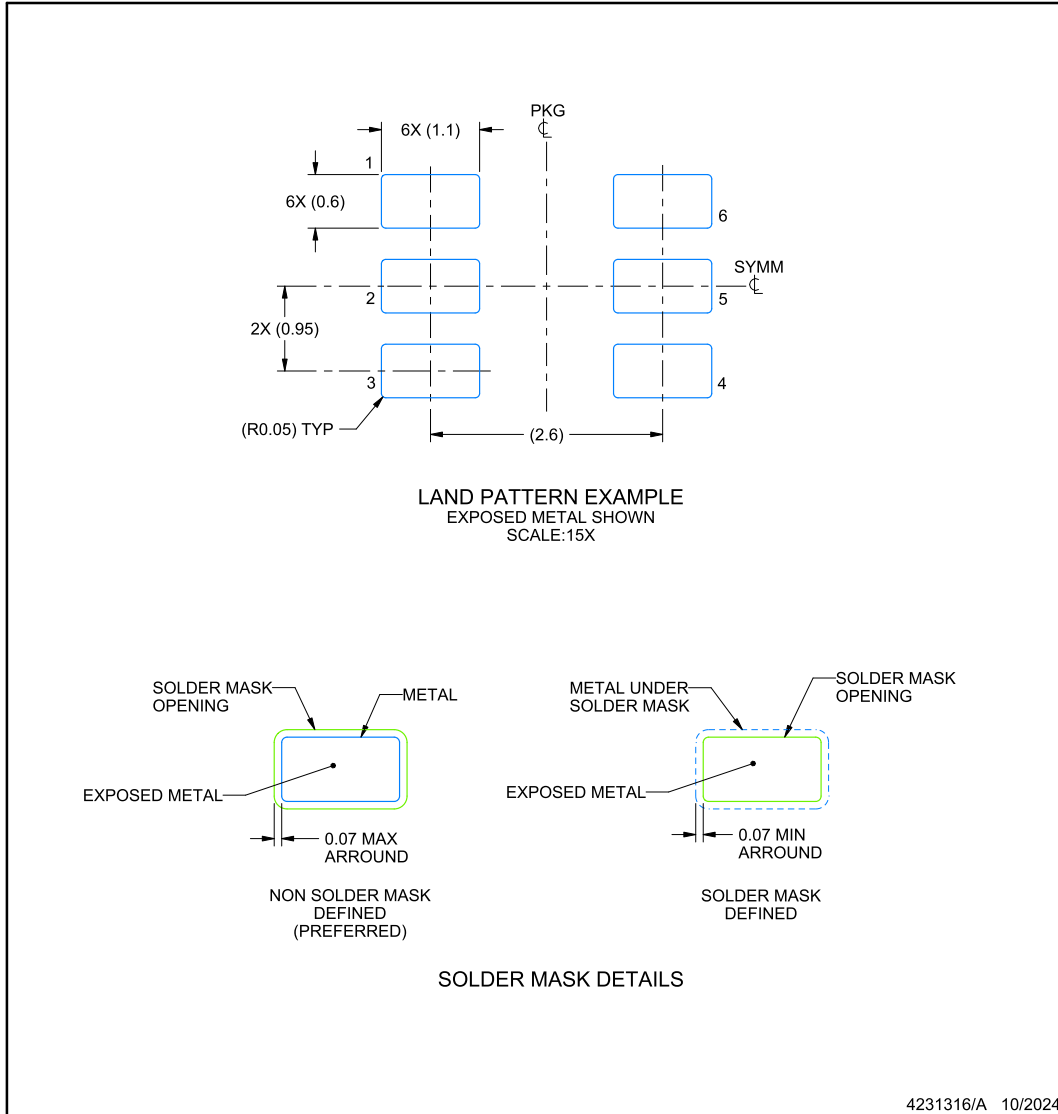

NOTES: (continued)

- 6. Publication IPC-7351 may have alternate designs.
- 7. Solder mask tolerances between and around signal pads can vary based on board fabrication site.

TMAG5173xxx/TMAG5273xxx
DBV0006A-C02

EXAMPLE STENCIL DESIGN

SOT-23 - 1.4 mm max height

SMALL OUTLINE TRANSISTOR

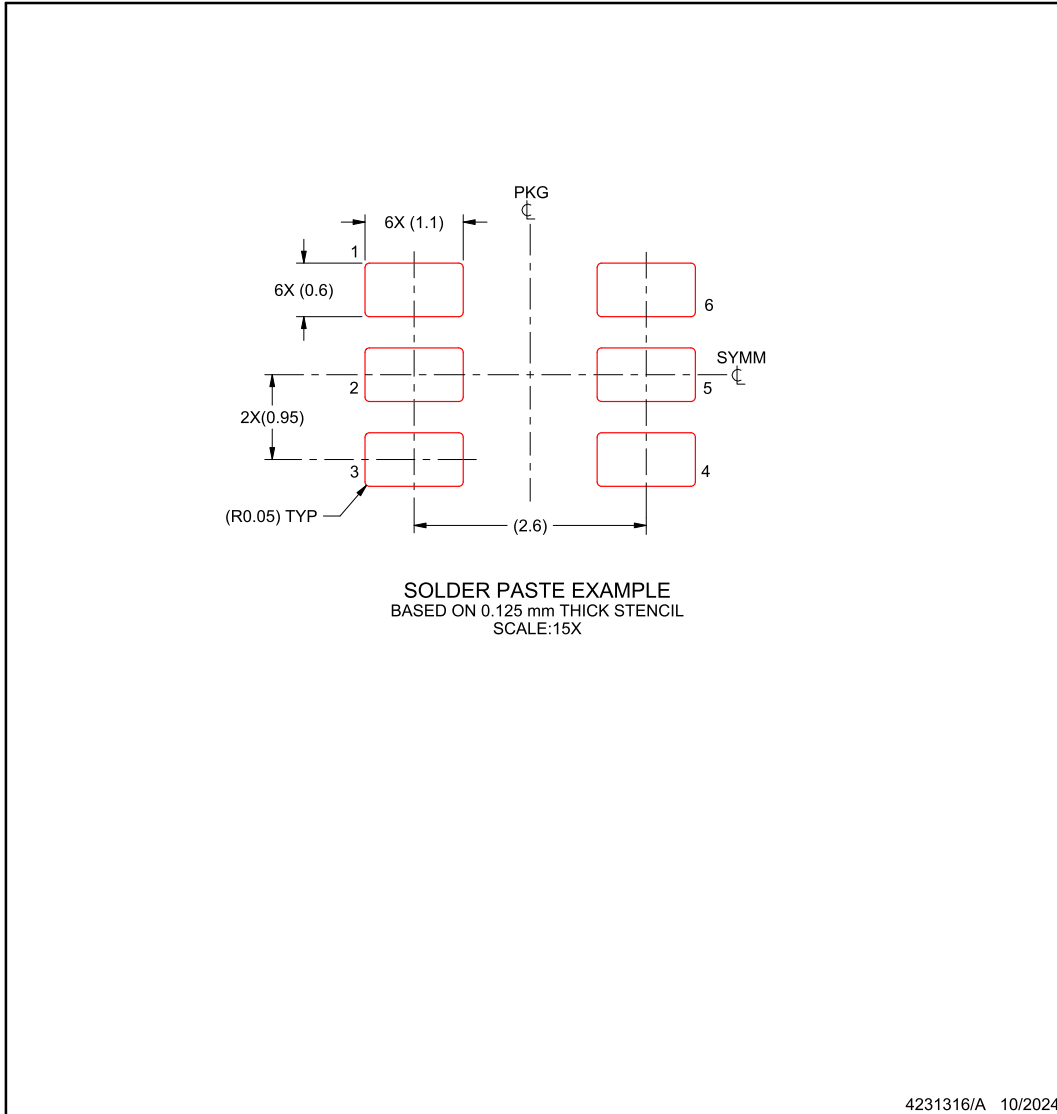

NOTES: (continued)

- 8. Laser cutting apertures with trapezoidal walls and rounded corners may offer better paste release. IPC-7525 may have alternate design recommendations.
- 9. Board assembly site may have different recommendations for stencil design.

PACKAGING INFORMATION

Orderable part number	Status (1)	Material type (2)	Package Pins	Package qty Carrier	RoHS (3)	Lead finish/ Ball material (4)	MSL rating/ Peak reflow (5)	Op temp (°C)	Part marking (6)
TMAG5273A1QDBVR	Active	Production	SOT-23 (DBV) 6	3000 LARGE T&R	Yes	SN	Level-3-260C-168 HR	-40 to 125	52A1
TMAG5273A1QDBVT	Obsolete	Production	SOT-23 (DBV) 6	-	-	Call TI	Call TI	-40 to 125	52A1
TMAG5273A2QDBVR	Active	Production	SOT-23 (DBV) 6	3000 LARGE T&R	Yes	SN	Level-3-260C-168 HR	-40 to 125	52A2
TMAG5273B1QDBVR	Active	Production	SOT-23 (DBV) 6	3000 LARGE T&R	Yes	SN	Level-3-260C-168 HR	-40 to 125	52B1
TMAG5273B2QDBVR	Active	Production	SOT-23 (DBV) 6	3000 LARGE T&R	Yes	SN	Level-3-260C-168 HR	-40 to 125	52B2
TMAG5273C1QDBVR	Active	Production	SOT-23 (DBV) 6	3000 LARGE T&R	Yes	SN	Level-3-260C-168 HR	-40 to 125	52C1
TMAG5273C2QDBVR	Active	Production	SOT-23 (DBV) 6	3000 LARGE T&R	Yes	SN	Level-3-260C-168 HR	-40 to 125	52C2
TMAG5273D1QDBVR	Active	Production	SOT-23 (DBV) 6	3000 LARGE T&R	Yes	SN	Level-3-260C-168 HR	-40 to 125	52D1
TMAG5273D2QDBVR	Active	Production	SOT-23 (DBV) 6	3000 LARGE T&R	Yes	SN	Level-3-260C-168 HR	-40 to 125	52D2

⁽¹⁾ **Status:** For more details on status, see our [product life cycle](#).

⁽²⁾ **Material type:** When designated, preproduction parts are prototypes/experimental devices, and are not yet approved or released for full production. Testing and final process, including without limitation quality assurance, reliability performance testing, and/or process qualification, may not yet be complete, and this item is subject to further changes or possible discontinuation. If available for ordering, purchases will be subject to an additional waiver at checkout, and are intended for early internal evaluation purposes only. These items are sold without warranties of any kind.

⁽³⁾ **RoHS values:** Yes, No, RoHS Exempt. See the [TI RoHS Statement](#) for additional information and value definition.

⁽⁴⁾ **Lead finish/Ball material:** Parts may have multiple material finish options. Finish options are separated by a vertical ruled line. Lead finish/Ball material values may wrap to two lines if the finish value exceeds the maximum column width.

⁽⁵⁾ **MSL rating/Peak reflow:** The moisture sensitivity level ratings and peak solder (reflow) temperatures. In the event that a part has multiple moisture sensitivity ratings, only the lowest level per JEDEC standards is shown. Refer to the shipping label for the actual reflow temperature that will be used to mount the part to the printed circuit board.

⁽⁶⁾ **Part marking:** There may be an additional marking, which relates to the logo, the lot trace code information, or the environmental category of the part.

Multiple part markings will be inside parentheses. Only one part marking contained in parentheses and separated by a "~" will appear on a part. If a line is indented then it is a continuation of the previous line and the two combined represent the entire part marking for that device.

Important Information and Disclaimer: The information provided on this page represents TI's knowledge and belief as of the date that it is provided. TI bases its knowledge and belief on information provided by third parties, and makes no representation or warranty as to the accuracy of such information. Efforts are underway to better integrate information from third parties. TI has taken and

continues to take reasonable steps to provide representative and accurate information but may not have conducted destructive testing or chemical analysis on incoming materials and chemicals. TI and TI suppliers consider certain information to be proprietary, and thus CAS numbers and other limited information may not be available for release.

In no event shall TI's liability arising out of such information exceed the total purchase price of the TI part(s) at issue in this document sold by TI to Customer on an annual basis.

TAPE AND REEL INFORMATION

QUADRANT ASSIGNMENTS FOR PIN 1 ORIENTATION IN TAPE

*All dimensions are nominal

Device	Package Type	Package Drawing	Pins	SPQ	Reel Diameter (mm)	Reel Width W1 (mm)	A0 (mm)	B0 (mm)	K0 (mm)	P1 (mm)	W (mm)	Pin1 Quadrant
TMAG5273A1QDBVR	SOT-23	DBV	6	3000	178.0	9.0	3.3	3.2	1.4	4.0	8.0	Q3
TMAG5273A2QDBVR	SOT-23	DBV	6	3000	178.0	9.0	3.3	3.2	1.4	4.0	8.0	Q3
TMAG5273B1QDBVR	SOT-23	DBV	6	3000	178.0	9.0	3.3	3.2	1.4	4.0	8.0	Q3
TMAG5273B2QDBVR	SOT-23	DBV	6	3000	178.0	9.0	3.3	3.2	1.4	4.0	8.0	Q3
TMAG5273C1QDBVR	SOT-23	DBV	6	3000	178.0	9.0	3.3	3.2	1.4	4.0	8.0	Q3
TMAG5273C2QDBVR	SOT-23	DBV	6	3000	178.0	9.0	3.3	3.2	1.4	4.0	8.0	Q3
TMAG5273D1QDBVR	SOT-23	DBV	6	3000	178.0	9.0	3.3	3.2	1.4	4.0	8.0	Q3
TMAG5273D2QDBVR	SOT-23	DBV	6	3000	178.0	9.0	3.3	3.2	1.4	4.0	8.0	Q3

TAPE AND REEL BOX DIMENSIONS

*All dimensions are nominal

Device	Package Type	Package Drawing	Pins	SPQ	Length (mm)	Width (mm)	Height (mm)
TMAG5273A1QDBVR	SOT-23	DBV	6	3000	190.0	190.0	30.0
TMAG5273A2QDBVR	SOT-23	DBV	6	3000	190.0	190.0	30.0
TMAG5273B1QDBVR	SOT-23	DBV	6	3000	190.0	190.0	30.0
TMAG5273B2QDBVR	SOT-23	DBV	6	3000	190.0	190.0	30.0
TMAG5273C1QDBVR	SOT-23	DBV	6	3000	190.0	190.0	30.0
TMAG5273C2QDBVR	SOT-23	DBV	6	3000	190.0	190.0	30.0
TMAG5273D1QDBVR	SOT-23	DBV	6	3000	190.0	190.0	30.0
TMAG5273D2QDBVR	SOT-23	DBV	6	3000	190.0	190.0	30.0

IMPORTANT NOTICE AND DISCLAIMER

TI PROVIDES TECHNICAL AND RELIABILITY DATA (INCLUDING DATA SHEETS), DESIGN RESOURCES (INCLUDING REFERENCE DESIGNS), APPLICATION OR OTHER DESIGN ADVICE, WEB TOOLS, SAFETY INFORMATION, AND OTHER RESOURCES "AS IS" AND WITH ALL FAULTS, AND DISCLAIMS ALL WARRANTIES, EXPRESS AND IMPLIED, INCLUDING WITHOUT LIMITATION ANY IMPLIED WARRANTIES OF MERCHANTABILITY, FITNESS FOR A PARTICULAR PURPOSE OR NON-INFRINGEMENT OF THIRD PARTY INTELLECTUAL PROPERTY RIGHTS.

These resources are intended for skilled developers designing with TI products. You are solely responsible for (1) selecting the appropriate TI products for your application, (2) designing, validating and testing your application, and (3) ensuring your application meets applicable standards, and any other safety, security, regulatory or other requirements.

These resources are subject to change without notice. TI grants you permission to use these resources only for development of an application that uses the TI products described in the resource. Other reproduction and display of these resources is prohibited. No license is granted to any other TI intellectual property right or to any third party intellectual property right. TI disclaims responsibility for, and you will fully indemnify TI and its representatives against, any claims, damages, costs, losses, and liabilities arising out of your use of these resources.

TI's products are provided subject to [TI's Terms of Sale](#) or other applicable terms available either on [ti.com](https://www.ti.com) or provided in conjunction with such TI products. TI's provision of these resources does not expand or otherwise alter TI's applicable warranties or warranty disclaimers for TI products.

TI objects to and rejects any additional or different terms you may have proposed.

Mailing Address: Texas Instruments, Post Office Box 655303, Dallas, Texas 75265

Copyright © 2025, Texas Instruments Incorporated