

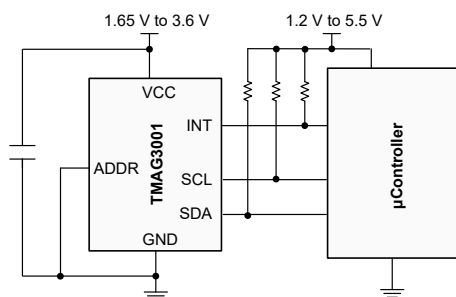
# TMAG3001 Low-Power 3D Linear and Angle Hall-Effect Sensor With I<sup>2</sup>C Interface and Wake Up Detection in WCSP

## 1 Features

- Configurable power modes including:
  - Active mode current: 2.1mA
  - Wake-up and sleep mode current: 0.45µA
  - Sleep mode current: 40nA
- Selectable linear magnetic range at X, Y, or Z axis:
  - TMAG3001A1 sample: ±40mT, ±80mT
  - TMAG3001A2: ±120mT, ±240mT
- Integrated angle calculation with gain and offset adjustment to support off-axis placement
- Conversion trigger by I<sup>2</sup>C or dedicated  $\overline{\text{INT}}$  pin
- Interrupt signal based on
  - Magnetic or Angle threshold crossing
  - Change from previous measurement
- Configurable 3D or angle switch mode
- Optimized for low noise, supporting up to 20kSPS single axis conversion rate
- I<sup>2</sup>C interface with cyclic redundancy check (CRC):
  - Maximum 1MHz I<sup>2</sup>C clock speed
  - ADDR pin enables four devices on the same bus
- Integrated temperature compensation to support multiple magnet types
- Built-in temperature sensor
- Supply voltage V<sub>CC</sub> range: 1.65V to 3.6V
- Operating temperature range: -40°C to 125°C

## 2 Applications

- [Electronic smart locks](#)
- [Door and window sensors](#)
- [Magnetic proximity sensors](#)
- [Mobile robot motor control](#)
- [Smartwatches](#)
- [Actuators](#)
- [Position sensors](#)
- [Foldable smartphones and tablets](#)
- [Joystick and gaming controllers](#)



Application Block Diagram

## 3 Description

The TMAG3001 is a low-power linear 3D Hall-effect sensor designed for a wide range of industrial and personal electronics applications. This device integrates three independent Hall-effect sensors in the X, Y, and Z axes. A precision analog signal-chain along with an integrated 12-bit ADC digitizes the measured analog magnetic field values. The I<sup>2</sup>C interface, while supporting multiple operating V<sub>CC</sub> ranges, allows seamless data communication with low-voltage microcontrollers.

The TMAG3001 can be configured through the I<sup>2</sup>C interface to enable any combination of magnetic axes and temperature measurements. Additionally, the device can be configured to various power options (including wake-up and sleep mode) allowing designers to optimize system power consumption based on their system-level needs. Multiple sensor conversion schemes and I<sup>2</sup>C read frames help optimize throughput and accuracy. A dedicated  $\overline{\text{INT}}$  pin can act as a system interrupt during low power wake-up and sleep mode, and can also be used by a microcontroller to trigger a new sensor conversion. The device also features a configurable low power switch mode for magnetic or angle measurements.

An integrated angle calculation engine (CORDIC) provides full 360° angular position information for both on-axis and off-axis angle measurement topologies. The angle calculation is performed using two user-selected magnetic axes. The device features magnetic gain and offset correction to mitigate the impact of system mechanical error sources.

The TMAG3001 features an ADDR pin that can be used to have four different I<sup>2</sup>C addresses. Each orderable part can be configured to select one of two magnetic field ranges that corresponds to the magnet strength and component placement during system calibration.

The device performs consistently across a wide ambient temperature range of -40°C to 125°C.

### Package Information

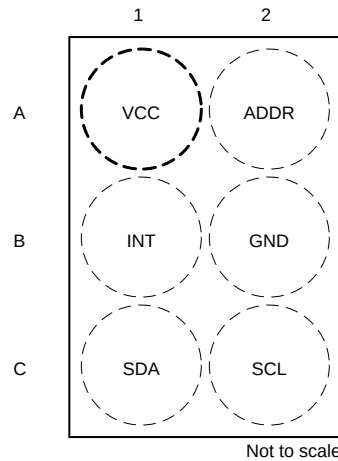
PART NUMBER	PACKAGE (1)	PACKAGE SIZE(2)
TMAG3001	YBG (DSBGA, 6)	0.83mm × 1.32mm

- For all available packages, see the package option addendum at the end of the data sheet.
- The package size (length × width) is a nominal value and includes pins, where applicable.

## Table of Contents

<b>1 Features</b> .....	1	6.3 Feature Description.....	14
<b>2 Applications</b> .....	1	6.4 Device Functional Modes.....	22
<b>3 Description</b> .....	1	6.5 Programming.....	24
<b>4 Pin Configuration and Functions</b> .....	3	<b>7 Register Maps</b> .....	40
<b>5 Specifications</b> .....	4	7.1 TMAG3001 Registers.....	40
5.1 Absolute Maximum Ratings.....	4	<b>8 Application and Implementation</b> .....	60
5.2 ESD Ratings.....	4	8.1 Application Information.....	60
5.3 Recommended Operating Conditions.....	4	8.2 Typical Application.....	71
5.4 Thermal Information.....	4	8.3 Best Design Practices.....	73
5.5 Electrical Characteristics.....	5	8.4 Power Supply Recommendations.....	74
5.6 Temperature Sensor.....	6	8.5 Layout.....	74
5.7 Magnetic Characteristics For A1.....	6	<b>9 Device and Documentation Support</b> .....	75
5.8 Magnetic Characteristics For A2.....	8	9.1 Documentation Support.....	75
5.9 Magnetic Temp Compensation Characteristics.....	9	9.2 Receiving Notification of Documentation Updates....	75
5.10 I <sup>2</sup> C Interface Timing.....	9	9.3 Support Resources.....	75
5.11 Power up Timing.....	11	9.4 Trademarks.....	75
5.12 Timing Diagram.....	11	9.5 Electrostatic Discharge Caution.....	75
5.13 Typical Characteristics.....	12	9.6 Glossary.....	75
<b>6 Detailed Description</b> .....	13	<b>10 Revision History</b> .....	75
6.1 Overview.....	13	<b>11 Mechanical, Packaging, and Orderable Information</b> .....	76
6.2 Functional Block Diagram.....	13		

## 4 Pin Configuration and Functions



**Figure 4-1. YBG (6 - DSBGA) Top View**

**Table 4-1. Pin Functions**

PIN		TYPE	DESCRIPTION
NO.	NAME		
A1	VCC	Power supply	Power supply.
A2	ADDR	Input	Address pin. Can be connected to either SDA, SCL, VCC or GND.
B1	$\overline{\text{INT}}$	IO	Interrupt output and Trigger Input. When used as an open-drain output a pullup resistor is required. When used us a Trigger Input a pullup is not required.
B2	GND	Ground	Ground reference.
C1	SDA	IO	Serial data.
C2	SCL	IO	Serial clock.

## 5 Specifications

### 5.1 Absolute Maximum Ratings

Over operating free-air temperature range (unless otherwise noted)<sup>(1)</sup>

		MIN	MAX	UNIT
V <sub>CC</sub>	Main supply voltage	-0.3	4	V
I <sub>OUT</sub>	Output current, SDA, $\overline{\text{INT}}$	0	10	mA
V <sub>OUT</sub>	Output voltage, SDA, $\overline{\text{INT}}$	-0.3	7	V
V <sub>IN</sub>	Input voltage, SCL, SDA, ADDR, $\overline{\text{INT}}$	-0.3	7	V
B <sub>MAX</sub>	Magnetic flux density		Unlimited	T
T <sub>J</sub>	Junction temperature	-40	150	°C
T <sub>stg</sub>	Storage temperature	-65	170	°C

- (1) Operation outside the Absolute Maximum Ratings may cause permanent device damage. Absolute Maximum Ratings do not imply functional operation of the device at these or any other conditions beyond those listed under Recommended Operating Conditions. If used outside the Recommended Operating Conditions but within the Absolute Maximum Ratings, the device may not be fully functional, and this may affect device reliability, functionality, performance, and shorten the device lifetime.

### 5.2 ESD Ratings

			VALUE	UNIT	
V <sub>(ESD)</sub>	Electrostatic discharge	Human body model (HBM), per ANSI/ESDA/JEDEC JS-001 <sup>(1)</sup>	±2000	V	
		Charged device model (CDM), per ANSI/ESDA/JEDEC JS-002 <sup>(2)</sup>	Corner pins (1, 6, 3, and 4)		±700
			Other pins		±500

- (1) JEDEC document JEP155 states that 500V HBM allows safe manufacturing with a standard ESD control process.  
(2) JEDEC document JEP157 states that 250V CDM allows safe manufacturing with a standard ESD control process.

### 5.3 Recommended Operating Conditions

		MIN	NOM	MAX	UNIT
V <sub>CC</sub>	Supply voltage	1.65		3.6	V
V <sub>OUT</sub>	Output voltage, SDA, $\overline{\text{INT}}$	0		3.6	V
I <sub>OUT</sub>	Output current, SDA, $\overline{\text{INT}}$			4.5	mA
T <sub>A</sub>	Operating free air temperature	-40		125	C

### 5.4 Thermal Information

THERMAL METRIC <sup>(1)</sup>		TMAG3001	UNIT
		YBG (WCSP)	
		6 PINS	
R <sub>θJA</sub>	Junction-to-ambient thermal resistance	131.8	°C/W
R <sub>θJC(top)</sub>	Junction-to-case (top) thermal resistance	1.4	°C/W
R <sub>θJC(bottom)</sub>	Junction-to-case (bottom) thermal resistance	N/A	°C/W
R <sub>θJB</sub>	Junction-to-board thermal resistance	36.4	°C/W
Ψ <sub>JT</sub>	Junction-to-top characterization parameter	0.3	°C/W
Ψ <sub>JB</sub>	Junction-to-board characterization parameter	36.4	°C/W

- (1) For more information about traditional and new thermal metrics, see the [Semiconductor and IC Package Thermal Metrics](#) application note.

## 5.5 Electrical Characteristics

Over free-air temperature range and  $V_{CC} = 1.65V$  to  $3.6V$  (unless otherwise noted); Typical specification are at  $T_A = 25^\circ C$  and  $V_{CC} = 3.3V$  (unless otherwise noted)

PARAMETER		TEST CONDITIONS	MIN	TYP	MAX	UNIT
<b>I/O Characteristics</b>						
$V_{OL}$	Output LOW voltage, SDA, $\overline{INT}$ pin	$I_{OUT} = 2mA$	0		0.4	V
$V_{IH}$	Input HIGH voltage	$V_{CC} = 1.65V$ to $1.9V$	$0.7 \times V_{CC}$			V
		$V_{CC} = 2.3V$ to $3.6V$	$0.65 \times V_{CC}$			V
$V_{IL}$	Input LOW voltage	$V_{CC} = 1.65V$ to $1.9V$			$0.3 \times V_{CC}$	V
		$V_{CC} = 2.3V$ to $3.6V$			$0.35 \times V_{CC}$	V
$I_{OZ}$	Output leakage current, SDA, $\overline{INT}$ pin	Output disabled $V_{OZ} = 5.5V$			$\pm 100$	nA
$t_{FALL\_INT}$	$\overline{INT}$ output fall time	$R_{PU} = 10k\Omega$ $C_L = 20pF$		6		ns
$t_{INT (INT)}$	$\overline{INT}$ Interrupt time duration during pulse mode	$INT\_Mode[2:0] = 1h$ or $2h$		10		$\mu s$
$t_{INT (SCL)}$	SCL Interrupt time duration	$INT\_Mode[2:0] = 3h$ or $4h$		10		$\mu s$
$C_{IN}$	Input capacitance	$f_s = 1MHz$			7.5	pF
<b>DC POWER SECTION</b>						
$I_{ACTIVE}$	Active mode current X, Y, Z, or thermal sensor active conversion	$LP\_LN = 0h$ $V_{CC} = 1.8V$		2.1	3.5	mA
		$LP\_LN = 1h$ $V_{CC} = 1.8V$		2.8	4.5	mA
		$LP\_LN = 0h$ $V_{CC} = 3.3V$		2.4	4	mA
		$LP\_LN = 1h$ $V_{CC} = 3.3V$		3.0	4.8	mA
$I_{STANDBY}$	Stand-by mode current	Device in trigger mode, no conversion started		0.45	1	mA
$I_{SLEEP}$	Sleep mode current			40		nA
<b>AVERAGE POWER DURING DUTY-CYCLE MODE</b>						
$I_{CC\_DCM}$	W&S mode current consumption Wake-up interval of 5000ms $LP\_LN = 0h$	Magnetic 1-channel conversion $V_{CC} = 1.8V$		0.4	1.1	$\mu A$
		Magnetic 1-channel conversion $V_{CC} = 3.3V$		0.5	1.3	$\mu A$
	W&S mode current consumption Wake-up interval of 1ms $Conv\_AVG[2:0] = 0h$ $LP\_LN = 0h$	Magnetic 1-channel conversion $V_{CC} = 3.3V$		110	250	$\mu A$
		Magnetic 4-channel conversion $V_{CC} = 3.3V$		230	375	$\mu A$

## 5.6 Temperature Sensor

Over free-air temperature range and  $V_{CC} = 1.65V$  to  $3.6V$  (unless otherwise noted); Typical specification are at  $T_A = 25^\circ C$  and  $V_{CC} = 3.3V$  (unless otherwise noted)

PARAMETER		TEST CONDITIONS	MIN	TYP	MAX	UNIT
$T_{SENS\_RANGE}$	Temperature sensing range		-40		125	$^\circ C$
$T_{SENS\_RES}$	Temperature sensing resolution (in 16-bit format)			58.2		LSB/ $^\circ C$
$T_{ADC\_TO}$	Temperature result in decimal value at room temperature of $25^\circ C$			17512		
$T_{ERR}$	Temperature error accuracy	$T_A = -40^\circ C$ to $125^\circ C$		$\pm 0.5$	$\pm 5$	$^\circ C$
NRMS_T	RMS (1 Sigma) temperature noise	Conv_AVG = 5h		0.05		$^\circ C$
NRMS_T	RMS (1 Sigma) temperature noise	Conv_AVG = 0h		0.3		$^\circ C$

## 5.7 Magnetic Characteristics For A1

Over free-air temperature range, Conv\_AVG = 5h and  $V_{CC} = 1.65V$  to  $3.6V$  (unless otherwise noted); Typical specification are at  $T_A = 25^\circ C$  and  $V_{CC} = 3.3V$  (unless otherwise noted)

PARAMETER		TEST CONDITIONS	MIN	TYP	MAX	UNIT
$B_{IN}$	Linear magnetic range	_RANGE = 0h		$\pm 37$		mT
		_RANGE = 1h		$\pm 75$		
SENS	Sensitivity, X, Y, or Z axis LP_LN = 1h	$\pm 40mT$ range		885		LSB/mT
		$\pm 80mT$ range		446		
SENS_ERR	Sensitivity error, X, Y, Z axis LP_LN = 1h	$T_A = 25^\circ C$		$\pm 1.8$	$\pm 7.7$	%
SENS_ERR_DR	Sensitivity drift X, Y, Z axis	$T_A = -40^\circ C$ to $25^\circ C$	-0.069		0.037	%/ $^\circ C$
		$T_A = 25^\circ C$ to $85^\circ C$	-0.028		0.069	
		$T_A = 85^\circ C$ to $125^\circ C$	-0.113		0.086	
SENS_LER	Sensitivity linearity error, X, Y axis	$T_A = 25^\circ C$		$\pm 0.11$	$\pm 0.9$	%
	Sensitivity linearity error, Z axis			$\pm 0.30$	$\pm 1.1$	
SENS_DR_LER	Sensitivity drift linearity error	X, Y axis			3.5	%
		Z axis			4.3	
SENS_MS	Sensitivity mismatch, X-Y axes	$T_A = 25^\circ C$ LP_LN = 1h		$\pm 2.8$	$\pm 6$	%
	Sensitivity mismatch, Y-Z, or X-Z axes			$\pm 3.5$	$\pm 8.7$	
SENS_MS_DR	Sensitivity mismatch drift X-Y axes	$T_A = -40^\circ C$ to $25^\circ C$	-0.027		0.029	%/ $^\circ C$
		$T_A = 25^\circ C$ to $85^\circ C$	-0.032		0.023	
		$T_A = 85^\circ C$ to $125^\circ C$	-0.041		0.029	
	Sensitivity mismatch drift X-Z or Y-Z axes	$T_A = -40^\circ C$ to $25^\circ C$	-0.054		0.027	
		$T_A = 25^\circ C$ to $85^\circ C$	-0.063		0.023	
		$T_A = 85^\circ C$ to $125^\circ C$	-0.067		0.036	
SENS_MS_DR_LIN	Sensitivity mismatch drift linearity error	X-Y axes			1.5	%
		Y-Z, or X-Z axes			1.5	%
$B_{off}$	Offset $T_A = 25^\circ C$	Range = 0h		$\pm 85$	$\pm 750$	$\mu T$
		Range = 1h		$\pm 70$	$\pm 650$	$\mu T$
$B_{off\_DR}$	Offset drift from $25^\circ C$ value	$T_A = -40^\circ C$ to $25^\circ C$		$\pm 1$	$\pm 9.3$	$\mu T/^\circ C$
		$T_A = 25^\circ C$ to $125^\circ C$		$\pm 1$	$\pm 9.6$	$\mu T/^\circ C$
$B_{off\_DR\_LIN}$	Offset drift linearity error	Range = 0h			0.06	%
		Range = 1h			0.04	%

Over free-air temperature range, Conv\_AVG = 5h and V<sub>CC</sub> = 1.65V to 3.6V (unless otherwise noted); Typical specification are at T<sub>A</sub> = 25°C and V<sub>CC</sub> = 3.3V (unless otherwise noted)

PARAMETER		TEST CONDITIONS	MIN	TYP	MAX	UNIT	
N <sub>RMS</sub>	RMS (1 Sigma) magnetic noise (X or Y-axis)	LP_LN = 0h Conv_AVG = 0h		105		μT	
		LP_LN = 1h Conv_AVG = 0h		95		μT	
		LP_LN = 0h Conv_AVG = 5h		17.5		μT	
		LP_LN = 1h Conv_AVG = 5h		16		μT	
N <sub>RMS</sub>	RMS (1 Sigma) magnetic noise (Z axis)	LP_LN = 0h Conv_AVG = 0h		58		μT	
		LP_LN = 1h Conv_AVG = 0h		53		μT	
		LP_LN = 0h Conv_AVG = 5h		10		μT	
		LP_LN = 1h Conv_AVG = 5h		9		μT	
A <sub>ERR</sub> <sup>(1)</sup>	Angle error T <sub>A</sub> = 25°C LP_LN = 1h	X-Y Axes		0.4	±0.95	deg	
		X-Z Axes		0.43	±1.0	deg	
		Y-Z Axes		0.38	±0.90	deg	
	Angle error T <sub>A</sub> = -40°C to 125°C LP_LN = 1h	X-Y Axes				±2.3	deg
		X-Z Axes				±1.5	deg
		Y-Z Axes				±1.8	deg
A <sub>NRMS</sub> <sup>(1)</sup>	RMS (1 Sigma) angle noise (X-Y)			0.042		deg	
	RMS (1 Sigma) angle noise (X-Z or Y-Z)	LP_LN = 1h		0.036		deg	

(1) Angle measurements are performed with the magnet aligned to the sensor

## 5.8 Magnetic Characteristics For A2

Over free-air temperature range and  $V_{CC} = 1.65V$  to  $3.6V$  (unless otherwise noted); Typical specification are at  $T_A = 25^\circ C$  and  $V_{CC} = 3.3V$  (unless otherwise noted)

PARAMETER		TEST CONDITIONS	MIN	TYP	MAX	UNIT
$B_{IN}$	Linear magnetic range	$\_RANGE = 0h$		$\pm 120$		mT
		$\_RANGE = 1h$		$\pm 240$		
SENS	Sensitivity, X, Y, or Z axis LP_LN = 1h	$\pm 120mT$ range		273		LSB/mT
		$\pm 240mT$ range		137		
$SENS_{ERR}$	Sensitivity error, X, Y, Z axis LP_LN = 1h	$T_A = 25^\circ C$		$\pm 0.5$	$\pm 6$	%
$SENS_{ERR\_DR}$	Sensitivity drift X, Y, Z axis	$T_A = -40^\circ C$ to $25^\circ C$	-0.063		0.042	%/ $^\circ C$
		$T_A = 25^\circ C$ to $85^\circ C$	-0.018		0.072	
		$T_A = 85^\circ C$ to $125^\circ C$	-0.071		0.046	
$SENS_{LER}$	Sensitivity linearity error, X, Y axis	$T_A = 25^\circ C$		$\pm 0.10$	1.5	%
	Sensitivity linearity error, Z axis	$T_A = 25^\circ C$		$\pm 0.10$	1.5	
$SENS_{DRLER}$	Sensitivity drift linearity error	X, Y axis			2.5	%
		Z axis			3.5	
$SENS_{MS}$	Sensitivity mismatch among X-Y axes	$T_A = 25^\circ C$ LP_LN = 1h		$\pm 0.75$	$\pm 4.5$	%
	Sensitivity mismatch among Y-Z, or X-Z axes			$\pm 0.55$	$\pm 6.5$	
$SENS_{MS\_DR}$	Sensitivity mismatch drift X-Y axes	$T_A = -40^\circ C$ to $25^\circ C$	-0.041		0.041	%/ $^\circ C$
		$T_A = 25^\circ C$ to $85^\circ C$	-0.046		0.044	
		$T_A = 85^\circ C$ to $125^\circ C$	-0.057		0.055	
	Sensitivity mismatch drift X-Z or Y-Z axes	$T_A = -40^\circ C$ to $25^\circ C$	-0.063		0.024	
		$T_A = 25^\circ C$ to $85^\circ C$	-0.074		0.035	
		$T_A = 85^\circ C$ to $125^\circ C$	-0.083		0.070	
$SENS_{MS\_DR\_LIN}$	Sensitivity mismatch drift linearity error, X-Y axes				3.2	%
	Sensitivity mismatch drift linearity error, Z axis				3.5	
$B_{off}$	Offset	$T_A = 25^\circ C$ Range = 0h		$\pm 75$	$\pm 600$	$\mu T$
		$T_A = 25^\circ C$ Range = 1h		$\pm 75$	$\pm 750$	
$B_{off\_DR}$	Offset drift from $25^\circ C$ value	$T_A = -40^\circ C$ to $25^\circ C$		$\pm 1$	$\pm 9.1$	$\mu T/^\circ C$
		$T_A = 25^\circ C$ to $125^\circ C$		$\pm 1$	$\pm 8$	
$B_{off\_DR\_LIN}$	Offset drift linearity error	Range = 0h			0.07	%
		Range = 1h			0.04	



Over free-air temperature range and  $V_{CC} = 1.65V$  to  $3.6V$  (unless otherwise noted); Typical specification are at  $T_A = 25^\circ C$  and  $V_{CC} = 3.3V$  (unless otherwise noted)

PARAMETER		TEST CONDITIONS	MIN	TYP	MAX	UNIT
$N_{RMS}$	RMS (1 Sigma) magnetic noise (X or Y-axis)	LP_LN = 0h Conv_AVG = 0h		116		$\mu T$
		LP_LN = 1h Conv_AVG = 0h		106		
		LP_LN = 0h Conv_AVG = 5h		20		
		LP_LN = 1h Conv_AVG = 5h		19		
	RMS (1 Sigma) magnetic noise (Z axis)	LP_LN = 0h Conv_AVG = 0h		80		
		LP_LN = 1h Conv_AVG = 0h		77		
		LP_LN = 0h Conv_AVG = 5h		14.5		
		LP_LN = 1h Conv_AVG = 5h		14		
$A_{ERR}^{(1)}$	Angle error $T_A = 25^\circ C$ Conv_AVG = 5h LP_LN = 1h	X-Z Axes		$\pm 0.35$	$\pm 0.85$	deg
		X-Y Axes		$\pm 0.43$	$\pm 1.4$	
		Y-Z Axes		$\pm 0.17$	$\pm 0.55$	
	Angle error $T_A = -40^\circ C$ to $125^\circ C$ Conv_AVG = 5h LP_LN = 1h	X-Z Axes			$\pm 1.4$	
		X-Y Axes			$\pm 2.25$	
		Y-Z Axes			$\pm 2.0$	
$A_{NRMS}^{(1)}$	RMS (1 Sigma) angle noise (X-Y)	LP_LN = 1h Conv_AVG = 5h		0.03		deg
	RMS (1 Sigma) angle noise (X-Z or Y-Z)			0.025		

(1) Angle measurements are performed with the magnet aligned to the sensor with gain and offset calibration using X Y Z register output values.

### 5.9 Magnetic Temp Compensation Characteristics

Over free-air temperature range and  $V_{CC} = 1.65V$  to  $3.6V$  (unless otherwise noted); Typical specification are at  $T_A = 25^\circ C$  and  $V_{CC} = 3.3V$  (unless otherwise noted)

PARAMETER		TEST CONDITIONS	MIN	TYP	MAX	UNIT
TC	Temperature compensation (X, Y, Z-axes)	TEMPCO = 0h		0		$\%/^\circ C$
		TEMPCO = 1h		0.12		$\%/^\circ C$
		TEMPCO = 2h		0.03		$\%/^\circ C$
		TEMPCO = 3h		0.2		$\%/^\circ C$

### 5.10 I<sup>2</sup>C Interface Timing

Over free-air temperature range and  $V_{CC} = 1.65V$  to  $3.6V$  (unless otherwise noted); Typical specification are at  $T_A = 25^\circ C$  and  $V_{CC} = 3.3V$  (unless otherwise noted)

		FAST MODE		FAST MODE PLUS		UNIT
		MIN	MAX	MIN	MAX	
$f_{(SCL)}$	SCL operating frequency	1	400	1	1000	kHz
$t_{(BUF)}$	Bus-free time between STOP and START conditions	1.3		0.5		$\mu s$
$t_{(SUSTA)}$	Repeated START condition setup time	0.6		0.26		$\mu s$
$t_{(HDSTA)}$	Hold time after repeated START condition. After this period, the first clock is generated.	0.1		0.1		$\mu s$

**TMAG3001**

SLYS053C – NOVEMBER 2023 – REVISED MAY 2025

Over free-air temperature range and  $V_{CC} = 1.65V$  to  $3.6V$  (unless otherwise noted); Typical specification are at  $T_A = 25^\circ C$  and  $V_{CC} = 3.3V$  (unless otherwise noted)

		FAST MODE		FAST MODE PLUS		UNIT
		MIN	MAX	MIN	MAX	
$t_{(SUSTO)}$	STOP condition setup time	0.6		0.26		$\mu s$
$t_{(HDDAT)}$	Data hold time <sup>(1)</sup>	15	900	15	150	ns
$t_{(SUDAT)}$	Data setup time	100		50		ns
$t_{(LOW)}$	SCL clock low period	1.3		0.5		$\mu s$
$t_{(HIGH)}$	SCL clock high period	0.6		0.26		$\mu s$
$t_R$	SDA, SCL rise time	20	300		120	ns
$t_F$	SDA, SCL fall time	$20 \times$ $(V_{CC} /$ $5.5V)$	300	$20 \times$ $(V_{CC} /$ $5.5V)$	120	ns
$t_{LPF}$	Glitch suppression filter	50		50		ns

(1) The maximum  $t_{(HDDAT)}$  can be  $0.9\mu s$  for fast mode, and is less than the maximum  $t_{(VDAT)}$  by a transition time.

### 5.11 Power up Timing

Over free-air temperature range and  $V_{CC} = 1.65V$  to  $3.6V$  (unless otherwise noted); Typical specification are at  $T_A = 25^\circ C$  and  $V_{CC} = 3.3V$  (unless otherwise noted)

PARAMETER		TEST CONDITIONS	MIN	TYP	MAX	UNIT
$t_{start\_power\_up}$	Time to go to standby mode after $V_{CC}$ supply voltage crossing $V_{CC\_MIN}$		237	270	302	$\mu s$
$t_{start\_sleep}$	Time to go to standby mode from sleep mode <sup>(1)</sup>		44	50	56	$\mu s$
$t_{start\_measure}$	Time to go into continuous measure mode from standby mode		54	62	70	$\mu s$
$t_{measure}$	Conversion time	Conv_AVG[2:0] = 0h Operating_Mode[1:0] = 2h Only one channel enabled	44	50	56	$\mu s$
$t_{measure}$	Conversion time	Conv_AVG[2:0] = 5h Operating_Mode[1:0] = 2h Only one channel enabled	726	825	924	$\mu s$
$t_{go\_sleep}$	Time to go into sleep mode after SCL goes high		17	20	23	$\mu s$

- (1) The device recognizes the I2C communication from a controller only during standby or continuous measure modes. While the device is in sleep mode, a valid target address wakes up the device but no acknowledge is sent to the controller. Consider the start-up time before addressing the device after wake-up.

### 5.12 Timing Diagram

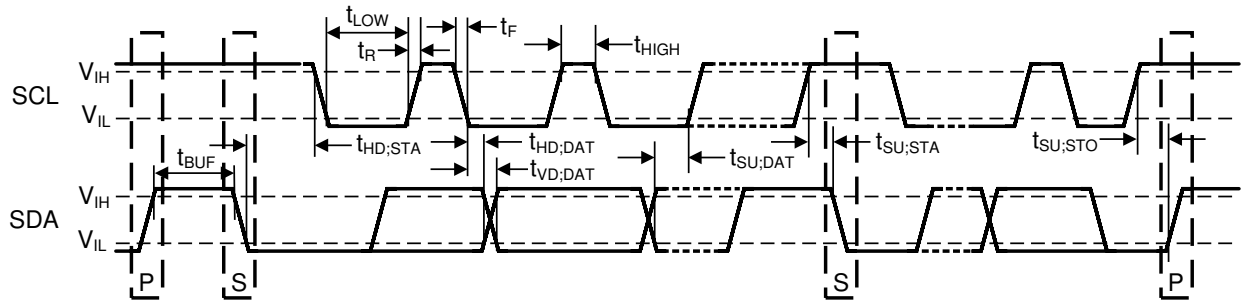
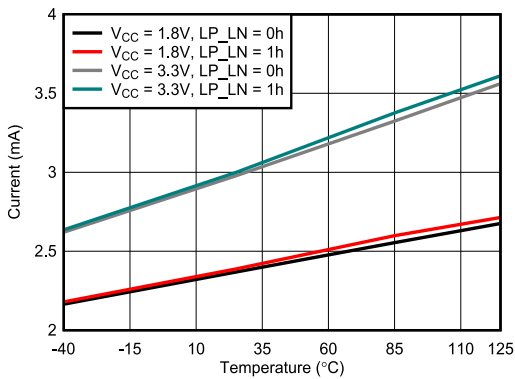
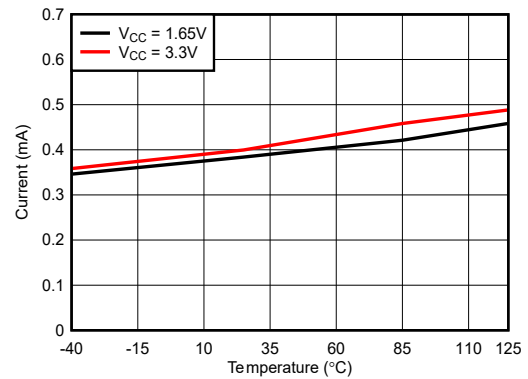


Figure 5-1. I2C Timing Diagram

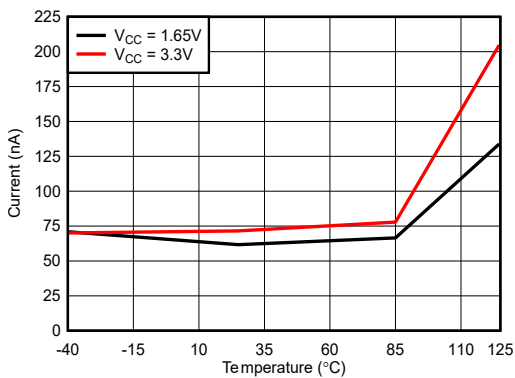
### 5.13 Typical Characteristics



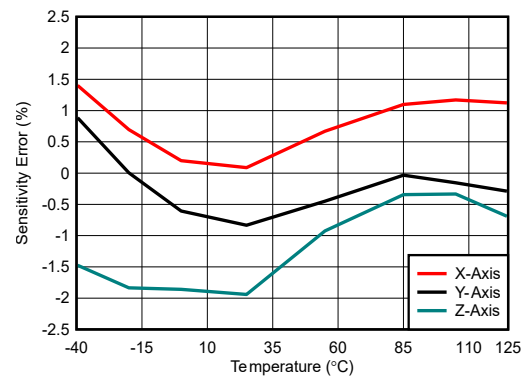
**Figure 5-2.  $I_{ACTIVE}$  vs Temperature**



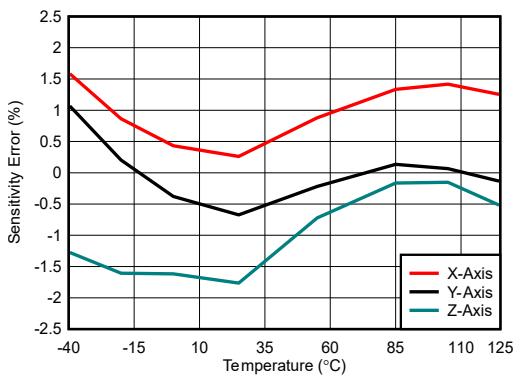
**Figure 5-3.  $I_{STANDBY}$  vs Temperature**



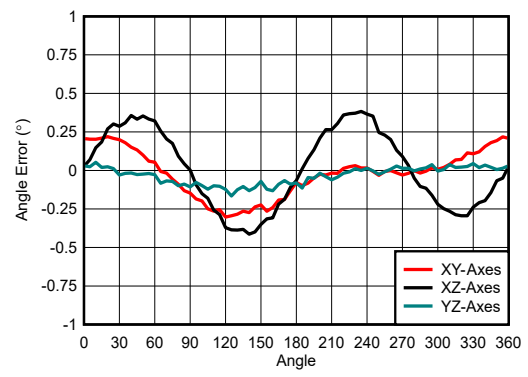
**Figure 5-4.  $I_{SLEEP}$  vs Temperature**



**Figure 5-5. A2 Sensitivity Error vs Temperature,  $V_{CC} = 1.8V$**



**Figure 5-6. A2 Sensitivity Error vs Temperature,  $V_{CC} = 3.3V$**



**Figure 5-7. A2 Angle Error vs Angle,  $V_{CC} = 3.3V$ ,  $T_A = 25^\circ C$**

## 6 Detailed Description

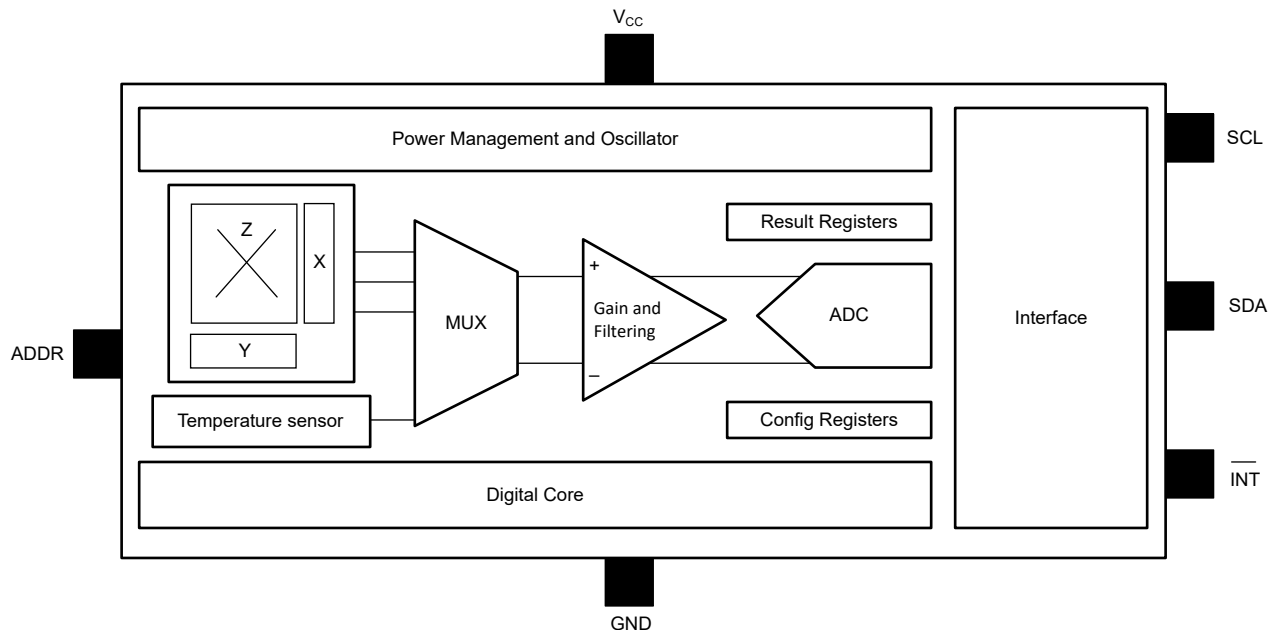
### 6.1 Overview

The TMAG3001 IC is based on the Hall-effect technology and precision mixed signal circuitry from Texas Instruments. The output signals (raw X, Y, Z magnetic data and temperature data) are accessible through the I<sup>2</sup>C interface.

The IC consists of the following functional and building blocks:

- The Power Management and Oscillator block contains a low-power oscillator, biasing circuitry and a fast oscillator.
- The sensing and temperature measurement block contains the Hall biasing, Hall sensors with multiplexers, noise filters, integrator circuit, temperature sensor, and the ADC. The Hall-effect sensor data and temperature data are multiplexed through the same ADC.
- The Interface block contains the I<sup>2</sup>C control circuitry, ESD protection circuits, and all the I/O circuits. The TMAG3001 supports multiple I<sup>2</sup>C read frames along with integrated cyclic redundancy check (CRC).

### 6.2 Functional Block Diagram



### 6.3 Feature Description

#### 6.3.1 Magnetic Flux Direction

As shown in Figure 6-1, the TMAG3001 generates positive ADC codes in response to a magnetic north pole in the proximity for Y and Z axes, and a south pole in proximity for the X axis. Similarly, the TMAG3001 generates negative ADC codes if opposite magnetic poles approach from the same direction.

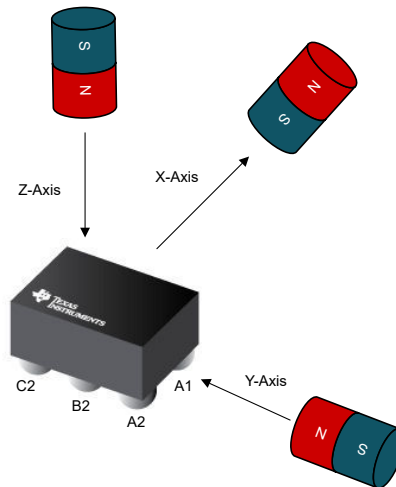


Figure 6-1. Direction of Sensitivity

#### 6.3.2 Sensor Location

Figure 6-2 shows the location of X, Y, Z Hall elements inside the TMAG3001. The distance from the die center to the Z element center is shown. The distance from the Z element center to the X element center is 0.10mm in the X direction. The distance from the Z element center to the Y element center is 0.099mm in the Y direction.

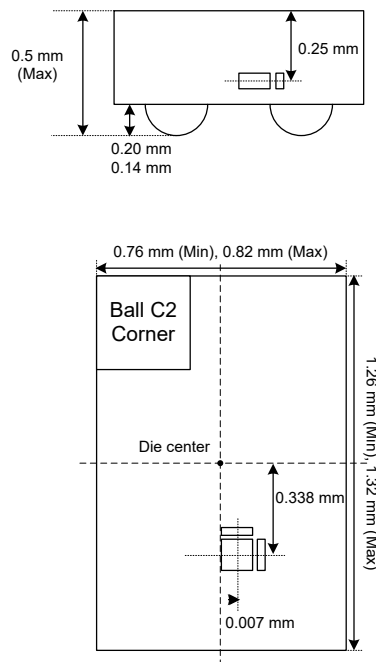


Figure 6-2. Location of X, Y, Z Hall Elements

### 6.3.3 Interrupt Function

The TMAG3001 supports flexible and configurable interrupt functions through either the  $\overline{\text{INT}}$  or the SCL pin. The  $\overline{\text{INT}}$  pin operates as an open drain output. The INTB\_POL and INT\_POL\_EN bits select the output level during an interrupt event when the  $\overline{\text{INT}}$  pin is used for interrupt output. [Table 6-1](#) shows the different interrupt modes supported by the device.

**Table 6-1. Interrupt Modes**

INT_MODE	MODE DESCRIPTION	OUTPUT PIN
0h	No interrupt	None
1h	Interrupt through $\overline{\text{INT}}$	$\overline{\text{INT}}$
2h	Interrupt through $\overline{\text{INT}}$	$\overline{\text{INT}}$
3h	Interrupt through SCL	SCL
4h	Interrupt through SCL except when I <sup>2</sup> C busy	SCL
5h	Unipolar Switch Mode through $\overline{\text{INT}}$	$\overline{\text{INT}}$
6h	Omnipolar Switch Mode through $\overline{\text{INT}}$	$\overline{\text{INT}}$

[Table 6-1](#) shows different conversion completion events where the result registers and SET\_COUNT bits update, and where the result registers and SET\_COUNT bits do not. The result registers that are used to create the interrupt events are updated only after the I<sup>2</sup>C bus is not busy.

**Table 6-2. Result Register and SET\_COUNT Update After Conversion Completion**

OUTPUT PIN	INT_MODE	I <sup>2</sup> C BUS BUSY, NOT TALKING TO DEVICE		I <sup>2</sup> C BUS BUSY AND TALKING TO DEVICE		I <sup>2</sup> C BUS NOT BUSY	
		RESULT UPDATE?	SET_COUNT UPDATE?	RESULT UPDATE?	SET_COUNT UPDATE?	RESULT UPDATE?	SET_COUNT UPDATE?
$\overline{\text{INT}}$		Yes	Yes	No	No	Yes	Yes
SCL	Interrupt through SCL	Yes	Yes	No	No	Yes	Yes
SCL	Interrupt through SCL except when I <sup>2</sup> C busy	No	No	No	No	Yes	Yes

#### Note

TI does not recommend sharing the same I<sup>2</sup>C bus with multiple target devices when using the SCL pin for interrupt function. The SCL interrupt can corrupt transactions with other target devices if present in the same I<sup>2</sup>C bus.

### Interrupt Through SCL

Figure 6-3 shows an example for interrupt function through the SCL pin with the device programmed to wake-up and sleep mode for threshold cross at a predefined intervals. The wake-up intervals can be set through the SLEEPTIME bits. After the magnetic threshold cross is detected, the device asserts a fixed width interrupt signal through the SCL pin, and remains in a low power wait state for a set period of time before the controller can address the interrupt event. The figure below shows a case where the controller responds to the interrupt event during the wait state and places the part back in the wake-up and sleep mode.

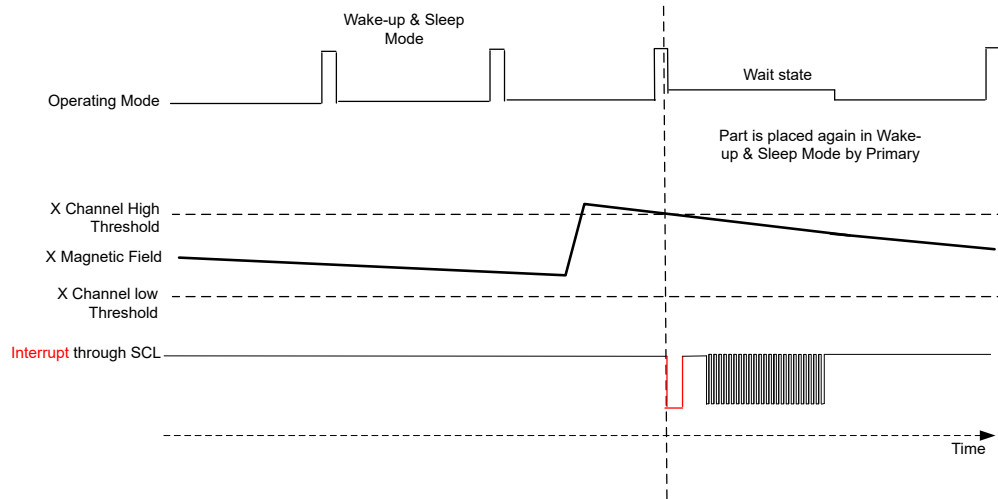


Figure 6-3. Interrupt Through SCL

### Fixed Width Interrupt Through $\overline{\text{INT}}$

Figure 6-4 shows an example for fixed-width interrupt function through the  $\overline{\text{INT}}$  pin. The INT\_STATE register bit is set 1b. After the magnetic threshold cross is detected, the device asserts a fixed width interrupt signal through the  $\overline{\text{INT}}$  pin. If the device is programmed to be in wake-up and sleep mode to detect a magnetic threshold, then the device remains in a low power wait state for a set period of time before the controller can address the interrupt event. The latest results are saved and are accessible through the I<sup>2</sup>C bus in the wait state. If the controller does not read the result registers in the wait time, the device enters a low power state and continues to remain in the wake and sleep mode.

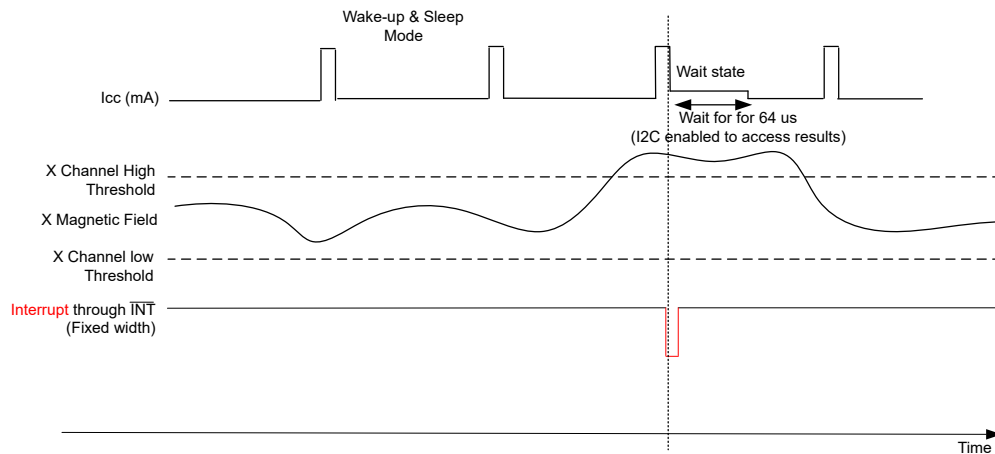


Figure 6-4. Fixed Width Interrupt Through  $\overline{\text{INT}}$



### Latched Interrupt Through $\overline{\text{INT}}$

Figure 6-5 shows an example for latched interrupt function through the  $\overline{\text{INT}}$  pin. The INT\_STATE register bit is set 0b. After the magnetic threshold cross is detected, the device asserts a latched interrupt signal through the  $\overline{\text{INT}}$  pin, and goes back to config mode. The interrupt latch is cleared after any valid standard I<sup>2</sup>C 3-byte read on the bus, or by any valid I<sup>2</sup>C write or 1-byte I<sup>2</sup>C read to the specific device address. If the device is programmed to be in wake-up and sleep mode to detect a magnetic threshold, then the device remains in a low power wait state for a set period of time before the controller can address the interrupt event. If the controller enters the wait state, the device remains in the wait state where the I<sup>2</sup>C is kept active.

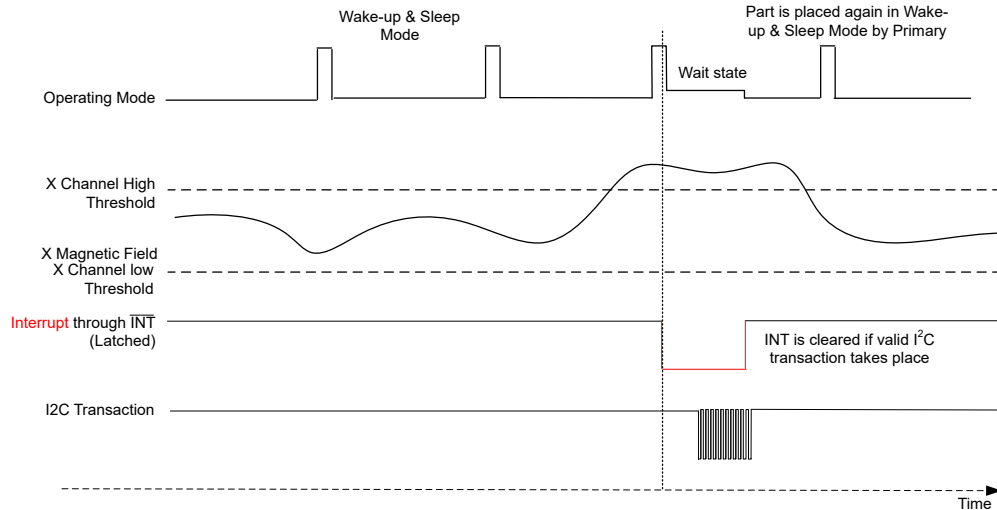


Figure 6-5. Latched Interrupt Through  $\overline{\text{INT}}$

### Unipolar Switch Through $\overline{\text{INT}}$

The TMAG3001 supports switch mode through the  $\overline{\text{INT}}$  pin, where the device acts as a smart switch that can be configured to be sensitive for magnetic or angle threshold crossing. The device can be placed in this unipolar switch mode in standby, active or wake-up and sleep modes. If the device is configured as a switch and placed in a low power wake-up and sleep mode, the device remains in a low power wake-up and sleep mode in case if any interrupt event is detected. Figure 6-6 shows an example for switch mode interrupt function through the  $\overline{\text{INT}}$  pin. After the magnetic threshold cross is detected, the  $\overline{\text{INT}}$  pin changes state.

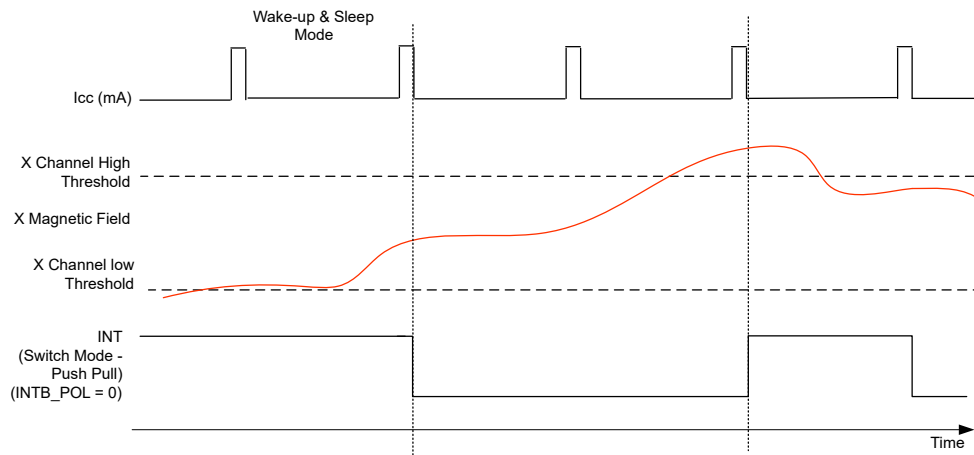


Figure 6-6. Unipolar Switch Through  $\overline{\text{INT}}$

## Omnipolar Switch Through $\overline{\text{INT}}$

The TMAG3001 supports omnipolar switch mode through the  $\overline{\text{INT}}$  pin, where the device acts as a smart switch that can be configured to be sensitive for magnetic threshold crossing. Figure 6-7 shows an example for an omnipolar switch mode interrupt function through the  $\overline{\text{INT}}$  pin. After the magnetic threshold cross is detected, the  $\overline{\text{INT}}$  pin changes state. If the device is configured as an omnipolar switch, the device remains in a low power wake up and sleep mode in case if any interrupt event is detected.

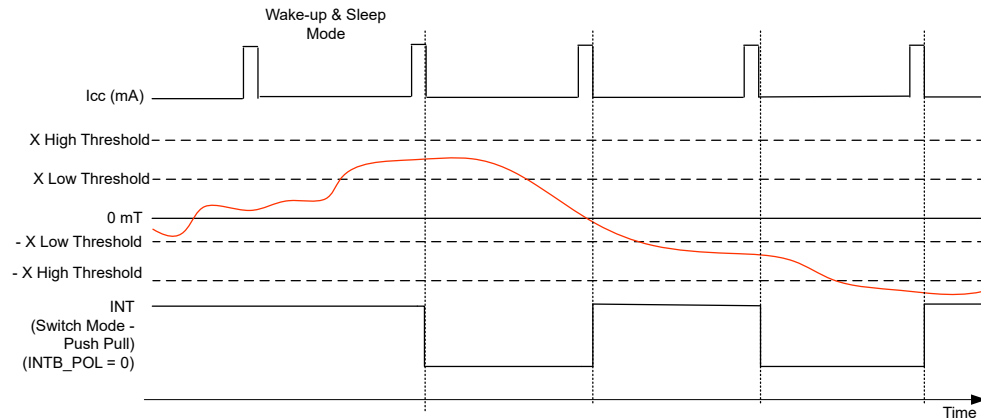


Figure 6-7. Omnipolar Switch Through  $\overline{\text{INT}}$

### 6.3.4 Wake on Change

The TMAG3001 enables relative magnetic limit checks for either magnetic fields or the angle measurements. For applications where only relative measurements are of interest, the device can be configured to respond through the WOC\_SEL bits. In this mode, the device monitors either one of the magnetic axes or the angle output for a change and wakes up the system by providing an interrupt response based on INT\_Mode[2:0] bits. When an interrupt response is obtained, the new sensor measurement is used as the reference threshold for the successive measurements. The wake on change feature is disabled when INT\_Mode[2:0] is set to Unipolar or Omnipolar switch mode, or when THR\_SEL  $\neq$  0h. The device can be configured to provide a wake on change response in standby, active or the wake and sleep mode. If the host reads from the device after a wake on change interrupt when the device is in wake and sleep mode, the host must initiate a conversion before re-entering wake and sleep mode to save the result.

When WOC\_SEL is set to 2h, the device monitors for a change in output measurements on only the first of the enabled magnetic axes according to MAG\_CH\_EN. For example, if MAG\_CH\_EN is set to 5h, only the Z channel are monitored for wake on change. If MAG\_CH\_EN is set to 9h, only the Y channel are monitored for wake on change. In this mode, Figure 6-8 shows the device response. In this example, MAG\_CH\_EN is set to 1h, where the device is responsive to the X magnetic field. The new values of the reference thresholds are set to the sensor output value when the threshold is crossed. The hysteresis is configured using the THR\_HYST bits. If the new measurement changes more than the previous measurement by the set hysteresis value, then an interrupt response is provided. Here the INT\_Mode[2:0] is to 1h to provide interrupt response through the INT pin and INT\_State is set to 1h, to provide a fixed interrupt response.

The wake on change with magnetic axes measurements feature triggers an interrupt upon transition from positive to negative field and vice-versa. The wake on change with angle feature treats an angle transition from 0° to 359°, or 359° to 0°, as a net change of 359° to compare against the threshold settings.

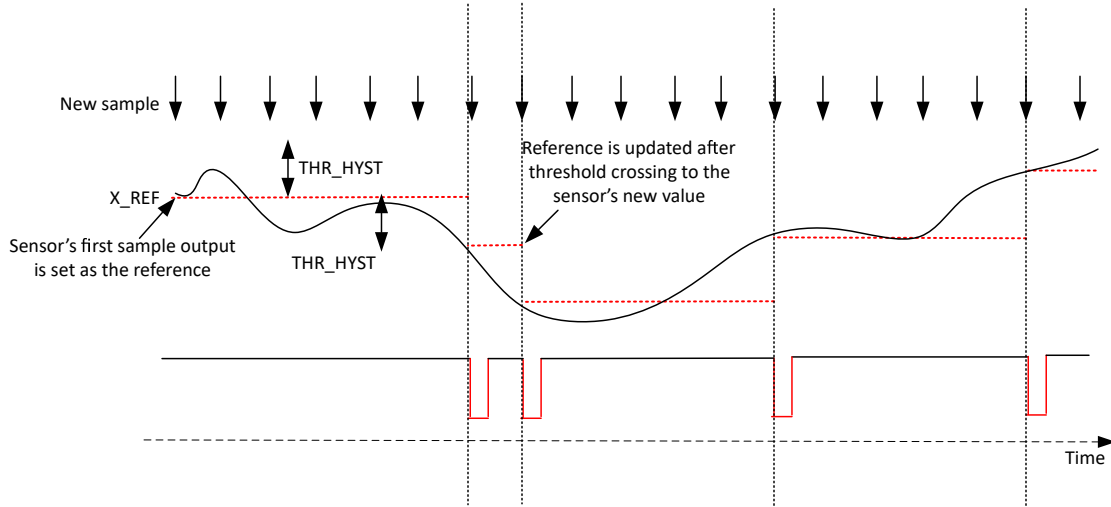


Figure 6-8. Wake on Change With Magnetic Axes Measurements ,  $WOC\_SEL = 2h$ ,  $INT\_State = 1h$

Figure 6-9 shows the device response, when WOC\_SEL = 1h, where the device is responsive to the angle measurements as set using the ANGLE\_EN bits. The thresholds of the present measurement are set based on the previous measured value and the hysteresis as configured using the ANG\_HYS bits. If the new measurement changes more than the previous measurement by the set hysteresis value, then an interrupt response is provided.

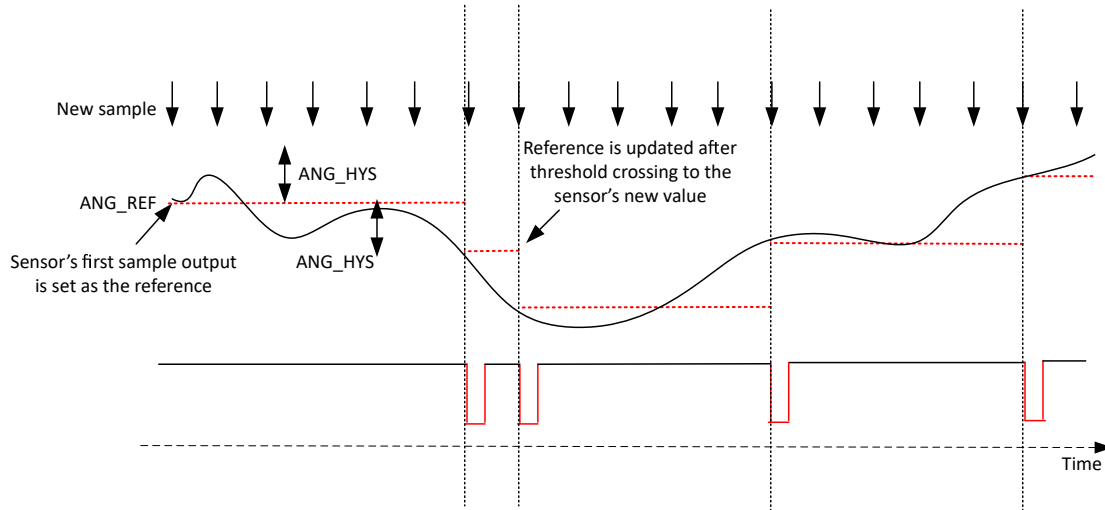


Figure 6-9. Wake on Change With Angle Measurements , WOC\_SEL = 1h, INT\_State = 1h

Table 6-3. Relevant Wake on Change Register Settings

	WOC_SEL SETTING	THR_SEL SETTING	INT_MODE SETTING	HYSTERESIS CONFIGURED BY
Wake on change (angle)	WOC_SEL = 1h	THR_SEL = 0h	INT_MODE ≠ 5h, 6h	Angle_HYS
Wake on change (magnetic field)	WOC_SEL = 2h	THR_SEL = 0h	INT_MODE ≠ 5h, 6h	THR_HYST

### 6.3.5 Device I<sup>2</sup>C Address

Table 6-4 shows the default factory programmed I<sup>2</sup>C addresses of the TMAG3001 and the four different address options that can be obtained using the ADDR pin for each of the device versions. The ADDR pin is only sampled in the Standby or Continuous mode, Operating\_Mode[1:0] = 0h or 2h. If the I2C\_Address\_Update\_EN is set to 1h, the TMAG3001 uses the I2C\_Address[6:0] as the device address. If using Operating\_Mode[1:0] = 1h or 3h, the I2C\_Address[6:0] bit field must be updated with the desired I<sup>2</sup>C address and I2C\_Address\_Update\_En set to 1h. It is possible to assign up to 128 unique addresses by setting the I2C\_Address\_Update\_En bit to 1h.

In addition to the following table, the TMAG3001 supports the General Call I<sup>2</sup>C Address of 00h.

Table 6-4. I<sup>2</sup>C Default Address

DEVICE VERSION	MAGNETIC RANGE	ADDR PIN CONNECTION	I <sup>2</sup> C ADDRESS (7 MSB BITS)	I <sup>2</sup> C WRITE ADDRESS (8-BIT)	I <sup>2</sup> C READ ADDRESS (8-BIT)
TMAG3001Ax	±40mT, ±80mT, ±120mT, ±240mT	GND	34h	68h	69h
		VCC	35h	6Ah	6Bh
		SDA	36h	6Ch	6Dh
		SCL	37h	6Eh	6Fh

An example procedure to use the ADDR designated I<sup>2</sup>C Address in any Operating\_Mode[1:0] is shown here. Adjust the I2C\_Address[6:0] as necessary for your system configuration.

- Power up TMAG3001 with ADDR connected to SDA
- Write 6Dh to register 0Ch (I2C\_Address) to set the 7-bit I2C\_Address[6:0] to 36h until the device is powered-down.
- Configure the Operating\_Mode[1:0] as desired

### 6.3.6 Magnetic Range Selection

Table 6-5 shows the magnetic range selection for the TMAG3001 device. The X, Y, and Z axes range can be selected with the X\_Y\_RANGE and Z\_RANGE register bits.

**Table 6-5. Magnetic Range Selection**

	RANGE REGISTER SETTING	TMAG3001A1	TMAG3001A2	COMMENT
X, Y Axis Field	X_Y_RANGE = 0h	±40mT	±120mT	Higher resolution
	X_Y_RANGE = 1h	±80mT	±240mT	Higher range
Z Axis Field	Z_RANGE = 0h	±40mT	±120mT	Higher resolution
	Z_RANGE = 1h	±80mT	±240mT	Higher range

### 6.3.7 Update Rate Settings

The TMAG3001 offers multiple update rates to offer design flexibility to system designers. The different update rates can be selected with the Conv\_AVG[2:0] register bits. Table 6-6 shows different update rate settings for the TMAG3001.

**Table 6-6. Update Rate Settings**

OPERATING MODE	REGISTER SETTING	UPDATE RATE			COMMENT
		SINGLE AXIS	TWO AXES	THREE AXES	
X, Y, Z Axis	Conv_AVG[2:0] = 0h	20.0kSPS	13.3kSPS	10.0kSPS	Fastest update rate
X, Y, Z Axis	Conv_AVG[2:0] = 1h	13.3kSPS	8.0kSPS	5.7kSPS	
X, Y, Z Axis	Conv_AVG[2:0] = 2h	8.0kSPS	4.4kSPS	3.1kSPS	
X, Y, Z Axis	Conv_AVG[2:0] = 3h	4.4kSPS	2.4kSPS	1.6kSPS	
X, Y, Z Axis	Conv_AVG[2:0] = 4h	2.4kSPS	1.2kSPS	0.8kSPS	
X, Y, Z Axis	Conv_AVG[2:0] = 5h	1.2kSPS	0.6kSPS	0.4kSPS	Best SNR case

## 6.4 Device Functional Modes

The TMAG3001 supports multiple functional modes for wide array of applications as explained in [Figure 6-10](#). A specific functional mode is selected by setting the corresponding value in the `Operating_Mode[1:0]` register bits. The device starts powering up after VCC supply crosses the minimum threshold as specified in the *Recommended Operating Condition (ROC)* table. During any mode of operation, triggering a conversion during an on-going conversion is ignored. The on-going conversion does not restart.

### 6.4.1 Standby (Trigger) Mode

The TMAG3001 goes to standby mode after first time powering up. At this mode the digital circuitry and oscillators are on, and the device is ready to accept commands from the controller device. Based off the commands the device can start a sensor data conversion, go to power saving mode, or start data transfer through I<sup>2</sup>C interface. A new conversion can be triggered through I<sup>2</sup>C command or through  $\overline{\text{INT}}$  pin. When using an I<sup>2</sup>C trigger, the conversion starts immediately after the trigger bit is clocked with the SCL line. In this mode the device retains the immediate past conversion result data in the corresponding result registers. The time the device takes to go from power up to standby mode is denoted by  $T_{\text{start\_power\_up}}$ .

### 6.4.2 Sleep Mode

The TMAG3001 supports an ultra-low power sleep mode where the device retains the critical user configuration settings. In this mode the device does not retain the conversion result data. A controller can wake up the device from sleep mode through I<sup>2</sup>C communications or the  $\overline{\text{INT}}$  pin. During the transition from sleep mode to standby mode through I<sup>2</sup>C interface, the  $\overline{\text{INT}}$  pin briefly asserts an interrupt. The  $\overline{\text{INT}}$  pin recovers after the device fully transitions to the standby mode with `RESULT_STATUS` bit set to 0h indicating no conversion is completed. To prevent this interrupt, the user can set the `MASK_INTB` bit to 1h before the device goes into sleep mode, then set the `MASK_INTB` bit back to 0h after waking up if the  $\overline{\text{INT}}$  pin is needed. The time the device takes to go from sleep mode to standby mode is denoted by  $T_{\text{start\_sleep}}$ .

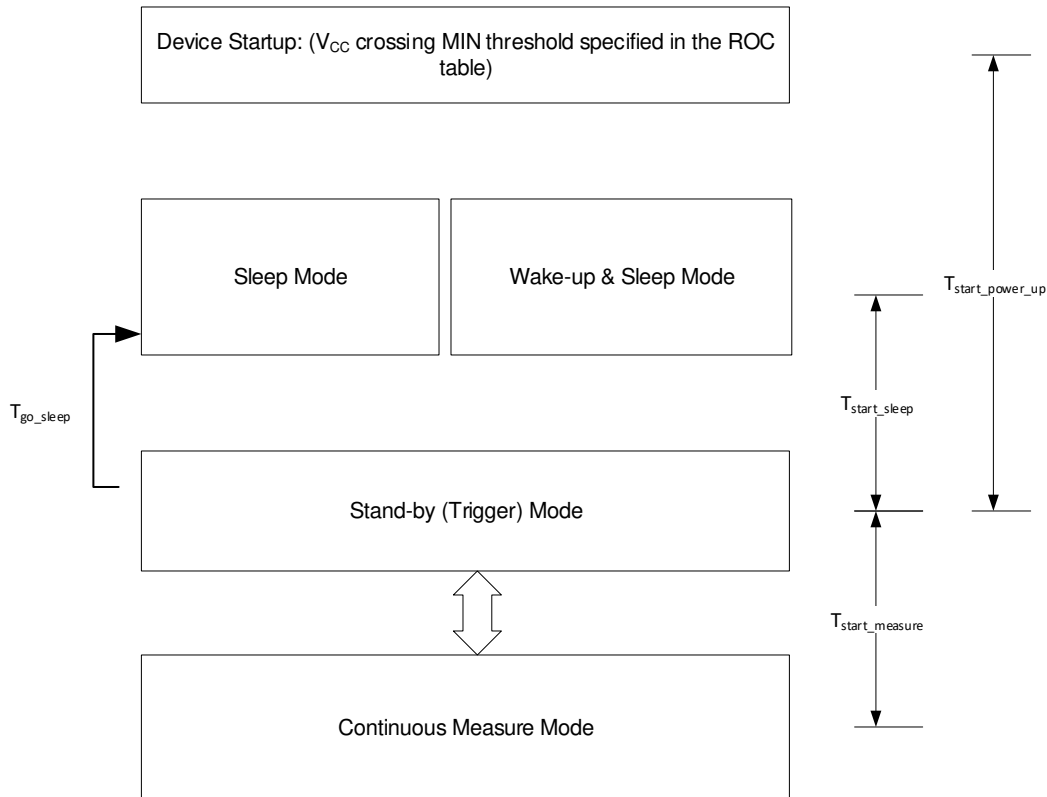
### 6.4.3 Wake-Up and Sleep (W&S) Mode

In this mode the TMAG3001 can be configured to go to sleep and wake up at a certain interval, and measure sensor data based off the `SLEEP_TIME` register bits setting. The device can be set to generate an interrupt through the `INT_CONFIG_1` register. After the conversion is complete and the interrupt condition is met, the TMAG3001 exits the W&S mode and go to the wait state for a fixed period of time. In this state, the last measured data is stored in the corresponding result registers. If the controller does not respond to the interrupt event in the wait state, then the device continues to be in (W&S) mode. If the interrupt condition is not met, the device stays in the W&S mode to wake up and measure data at the specified interval. A controller can wake up the TMAG3001 anytime during the W&S mode through I<sup>2</sup>C bus or  $\overline{\text{INT}}$  pin. The time the device takes to go from W&S mode to standby mode is denoted by  $T_{\text{start\_sleep}}$ .

Reading from the TMAG3001 after an interrupt puts the device in standby mode. The TMAG3001 must be configured back to Wake-up and Sleep mode if an I<sup>2</sup>C read is executed after an interrupt.

### 6.4.4 Continuous Measure Mode

In this mode the TMAG3001 continuously measures the sensor data per Sensor\_Config & Device\_Config register settings. In this mode the result registers can be accessed through the I<sup>2</sup>C lines. The time the device takes to go from standby mode to continuous measure mode is denoted by  $T_{start\_measure}$ .



**Figure 6-10. TMAG3001 Power-Up Sequence**

Table 6-7 shows different device operational modes of the TMAG3001.

**Table 6-7. Operating Modes**

OPERATING MODE	DEVICE FUNCTION	ACCESS TO USER REGISTERS	RETAIN USER CONFIGURATION	COMMENT
Continuous Measure Mode	Continuously measuring x, y, z axis, or temperature data	Yes	Yes	
Standby Mode	Device is ready to accept I <sup>2</sup> C commands and start active conversion	Yes	Yes	
Wake-up and Sleep Mode	Wakes up at a certain interval to measure the x, y, z axis, or temperature data	No	Yes	1, 5, 10, 15, 20, 30, 50, 100, 500, 1000, 2000, 5000, & 20000ms intervals supported.
Sleep Mode	Device retains key configuration settings, but does not retain the measurement data	No	Yes	Sleep mode can be utilized by a Controller device to implement other power saving intervals not supported by wake-up and sleep mode.

## 6.5 Programming

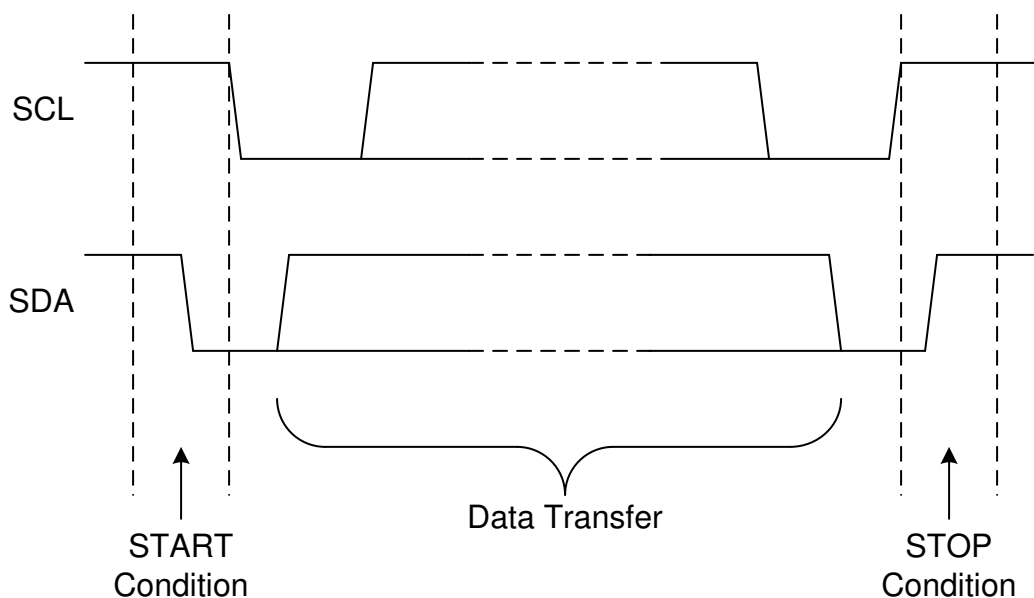
### 6.5.1 I<sup>2</sup>C Interface

The TMAG3001 has a standard bidirectional I<sup>2</sup>C interface that is controlled by a controller device to be configured or read the status of the device. Each target on the I<sup>2</sup>C bus has a specific device address to differentiate between other target devices that are on the same I<sup>2</sup>C bus. Many target devices require configuration upon start-up to set the behavior of the device. This is typically done when the controller accesses internal register maps of the target, which have unique register addresses. A device can have one or multiple registers where data is stored, written, or read. At the start bit of an I<sup>2</sup>C transaction, the conversion result registers are locked to the most recent completed conversion to prevent the results from changing mid transaction. If a conversion is completed mid I<sup>2</sup>C transaction, the device updates the results register with the new values immediately after the stop condition. The TMAG3001 supports transmission data rates up to 1MHz.

The physical I<sup>2</sup>C interface consists of the serial clock (SCL) and serial data (SDA) lines. Both SDA and SCL lines must be connected to a supply through a pullup resistor. The size of the pullup resistor is determined by the amount of capacitance on the I<sup>2</sup>C lines and the communication frequency. For further details, see the [I<sup>2</sup>C Pullup Resistor Calculation application note](#). Data transfer can only be initiated when the bus is idle. A bus is considered idle if both SDA and SCL lines are high after a STOP condition.

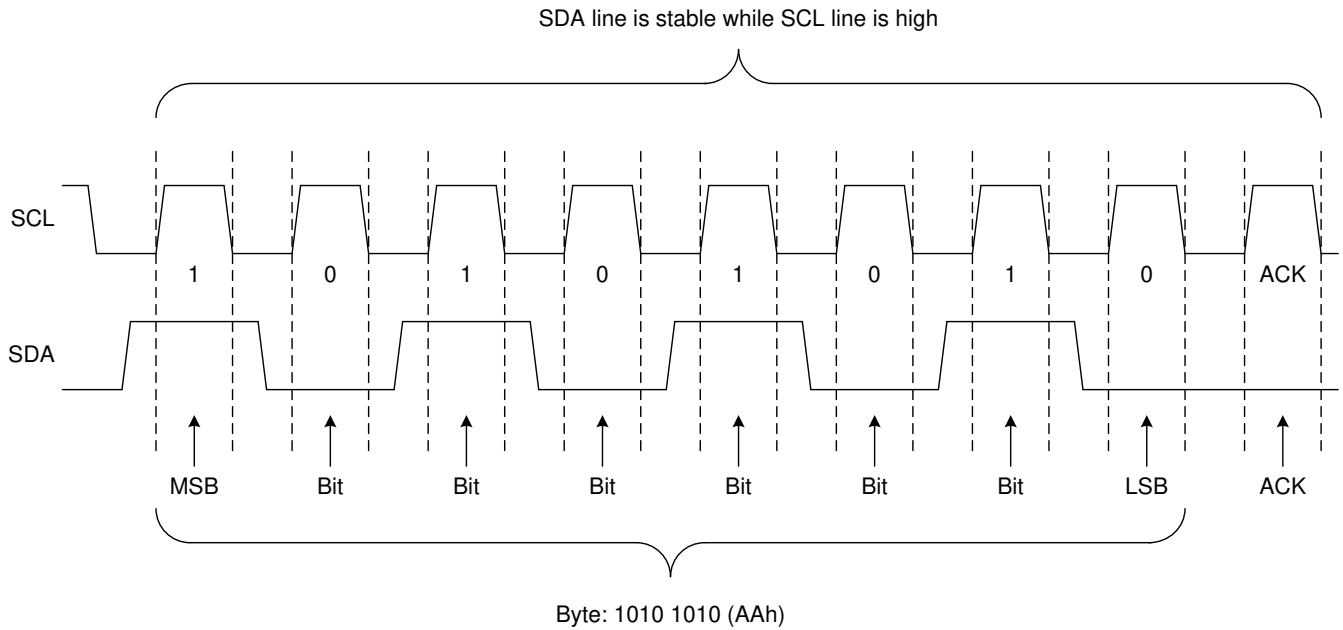
The following is the general procedure for a controller to access a target device:

1. If a controller wants to send data to a target:
  - Controller-transmitter sends a START condition and addresses the target-receiver.
  - Controller-transmitter sends the requested register to write target-receiver.
  - Controller-transmitter sends data to target-receiver.
  - Controller-transmitter terminates the transfer with a STOP condition.
2. If a controller wants to receive or read data from a target:
  - Controller-receiver sends a START condition and addresses the target-transmitter.
  - Controller-receiver sends the requested register to read to target-transmitter.
  - Controller-receiver sends a RESTART condition and addresses the target-transmitter.
  - Controller-receiver receives data from the target-transmitter.
  - Controller-receiver terminates the transfer with a STOP condition.



**Figure 6-11. Definition of Start and Stop Conditions**



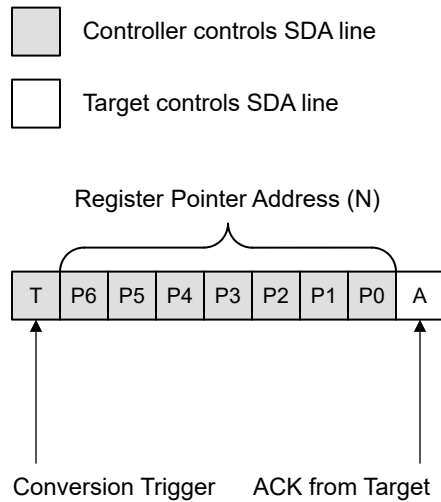


**Figure 6-12. Bit Transfer**

### 6.5.1.1 Conversion Trigger

The TMAG3001 supports the use of a Conversion Trigger bit to start a new conversion. Write a 1 to this bit to start a new conversion after the register address decoding is completed. The last 7 bits of the control register contain the Register Pointer Address.

Figure 6-13 shows the structure of the Control Register



**Figure 6-13. Control Register**

### 6.5.1.2 Bus Transactions

Data must be sent to and received from the target devices, and this is accomplished by reading from or writing to registers in the target device.

Registers are locations in the memory of the target which contain information, whether the information is configuration information or some sampled data to send back to the controller. The controller must write information to these registers to instruct the target device to perform a task.

The I2C\_RD[1:0] and CRC\_EN settings can modify how I<sup>2</sup>C Read transactions are performed as shown in the following sections. When I2D\_RD[1:0] is set to 0h or 3h, only Standard I<sup>2</sup>C Reads can be used. If I2C\_RD[1:0] is set to 1h or 2h, only the respective read command can be used.

The device returns 00h when reading registers outside of the register map. Setting changes during write transactions are acted upon after the last edge

#### 6.5.1.2.1 Three Channels I<sup>2</sup>C Write

To write on the I<sup>2</sup>C bus, the controller sends a START condition on the bus with the address of the target, as well as the last bit (the R/W bit) set to 0b, which signifies a write. The target acknowledges, letting the controller know the target is ready. After this, the controller starts sending the control register data to the target until the controller has sent all the data necessary, and the controller terminates the transmission with a STOP condition. The device auto increments the register address pointer after each byte.

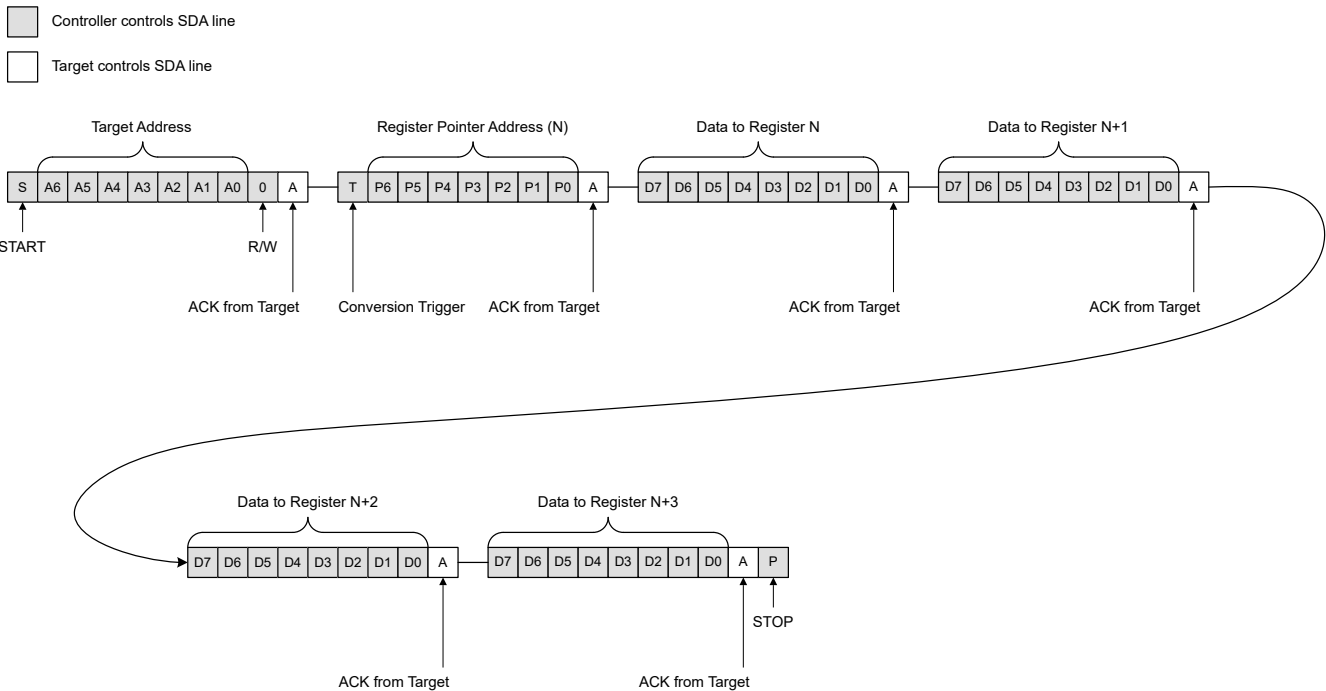
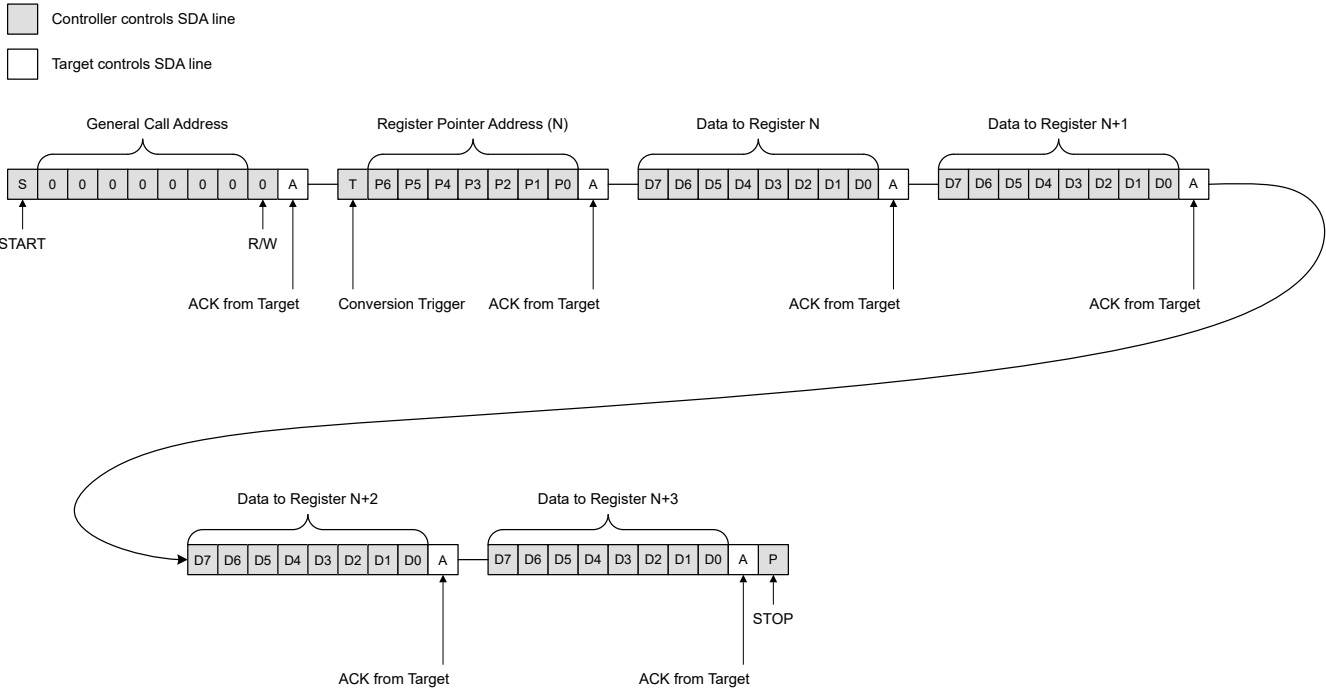


Figure 6-14. Standard I<sup>2</sup>C Write

### 6.5.1.2.2 General Call Write

The TMAG3001 supports the general call I<sup>2</sup>C write command. This allows the configuration of multiple devices at the same time.

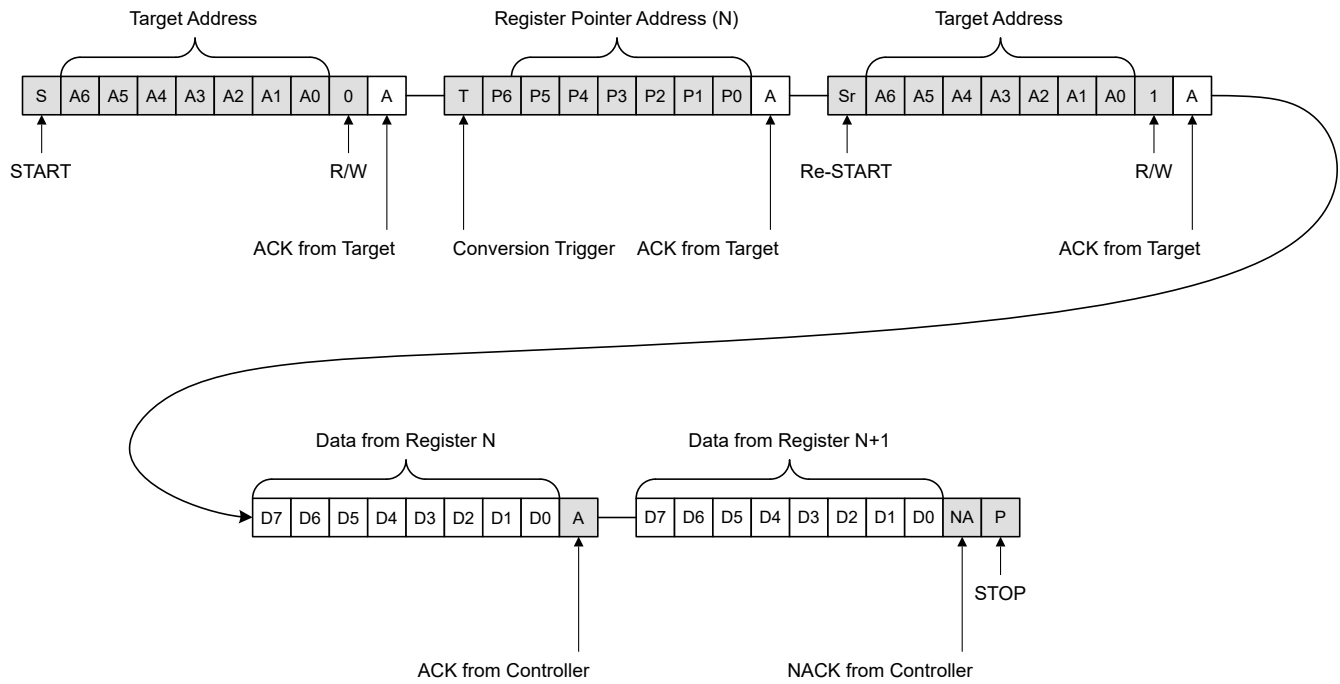


**Figure 6-15. General Call I<sup>2</sup>C Write**

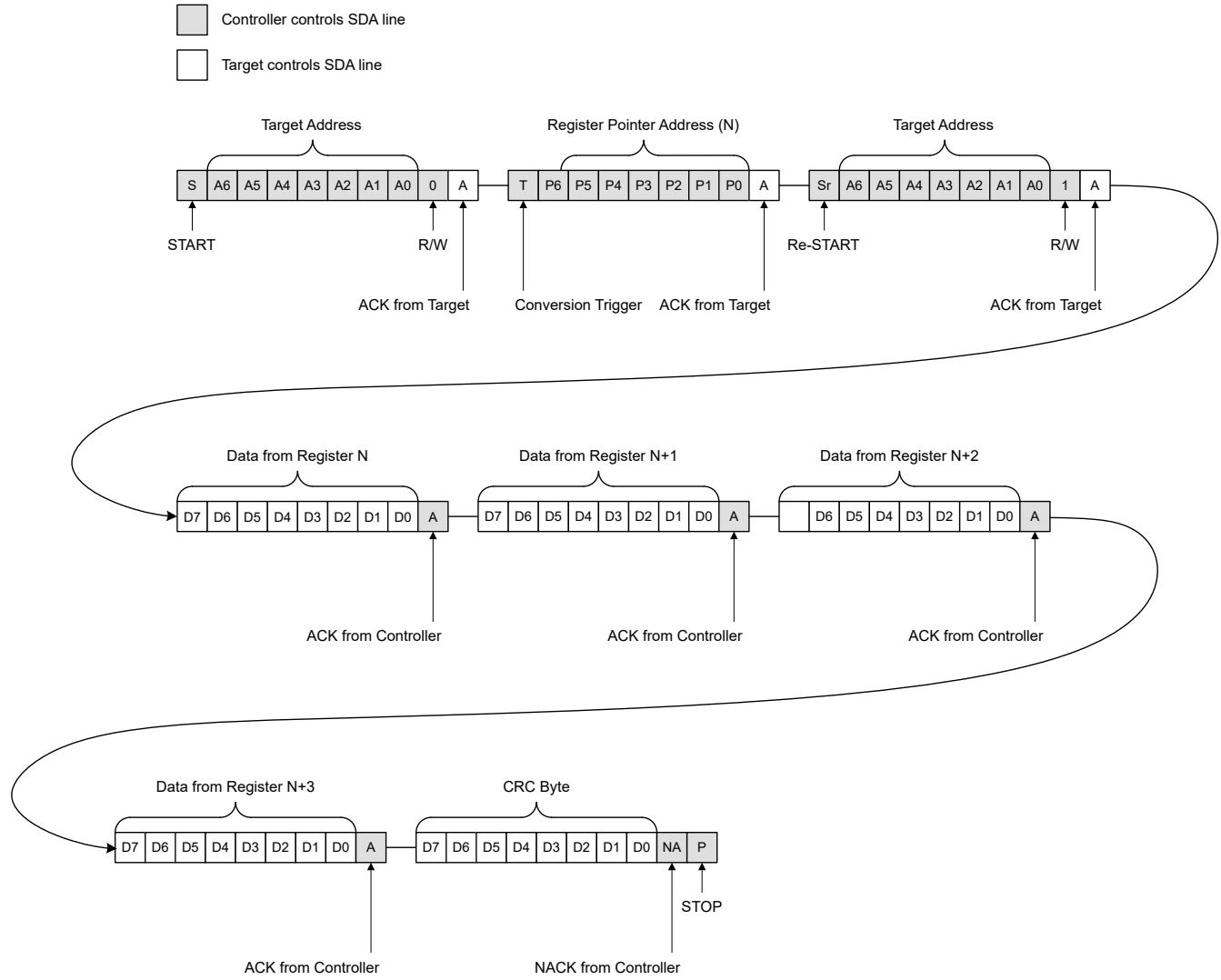
### 6.5.1.2.3 Standard I<sup>2</sup>C Read

For a read operation the controller sends a START condition, followed by the target address with the R/W bit set to 0b (signifying a write). The target acknowledges the write request, and the controller sends the control byte with the Conversion Trigger bit and Register Pointer Address. After the Control Register, the controller initiates a restart followed by the target address with the R/W bit set to 1b (signifying a read). The controller continues to send out clock pulses but releases the SDA line so that the target can transmit data. At the end of every byte of data, the controller sends an ACK to the target, letting the target know that the controller is ready for more data. After the controller has received the number of bytes the controller expected, the controller sends a NACK, signaling to the target to halt communications and release the SDA line. The controller follows this up with a STOP condition.

- Controller controls SDA line
- Target controls SDA line



**Figure 6-16. Standard I<sup>2</sup>C Read With CRC Disabled**



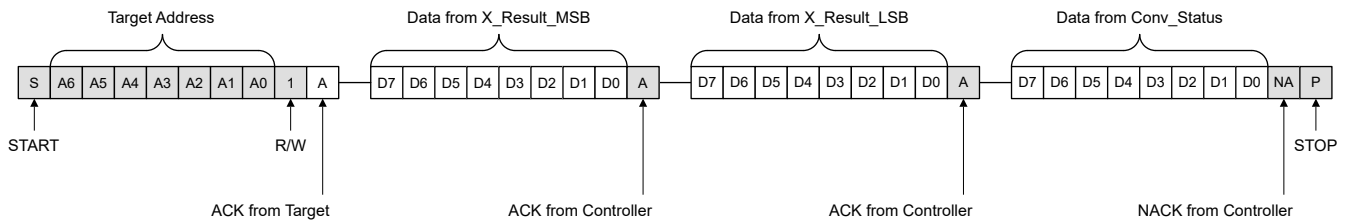
**Figure 6-17. Standard I<sup>2</sup>C Read With CRC Enabled**

**6.5.1.2.4 I<sup>2</sup>C Read Command for 16-Bit Data**

The TMAG3001 allows the user to read from the result registers without writing to the control register and setting the address pointer when I2C\_RD[1:0] = 1h for MSB and LSB data. When multiple channels are enabled, data is sent in the order of X-axis, Y-axis, Z-axis, and Conv\_Status. When a channel is disabled, the channel is skipped in the data sequence.

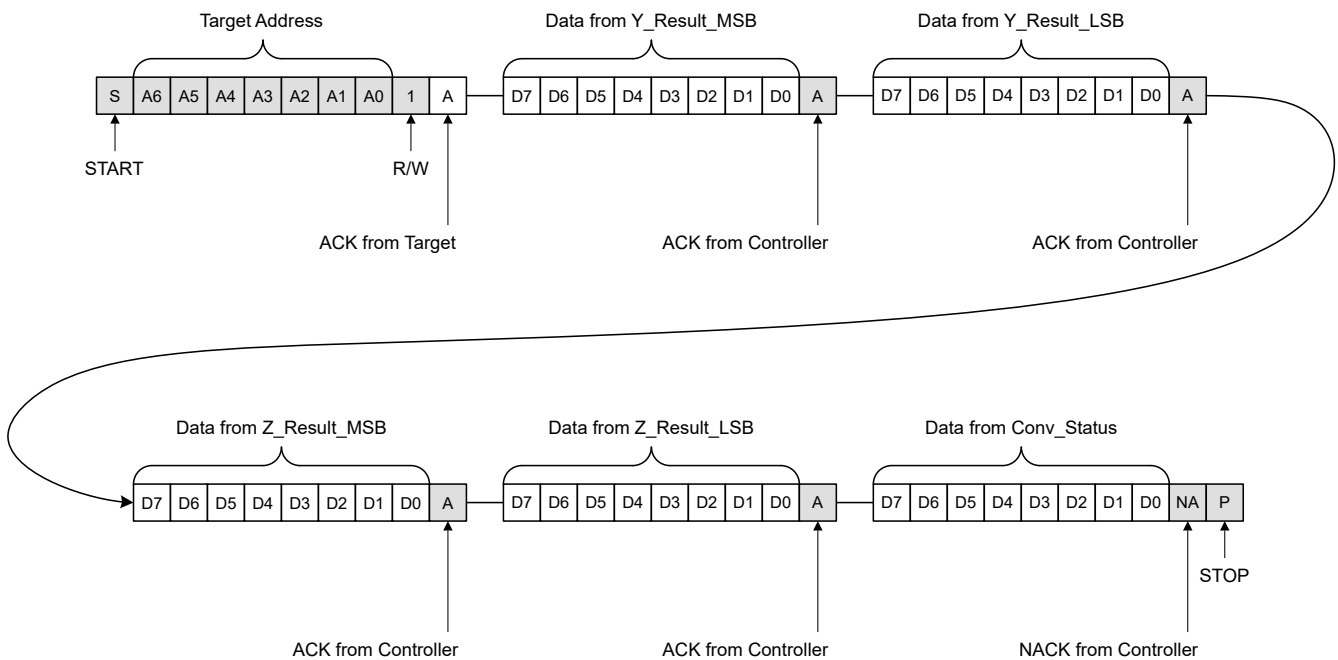
In the Read Command for 16-bit data, only up to three channels of data can be sent when CRC is enabled. This restriction does not apply if CRC is disabled.

- Controller controls SDA line
- Target controls SDA line

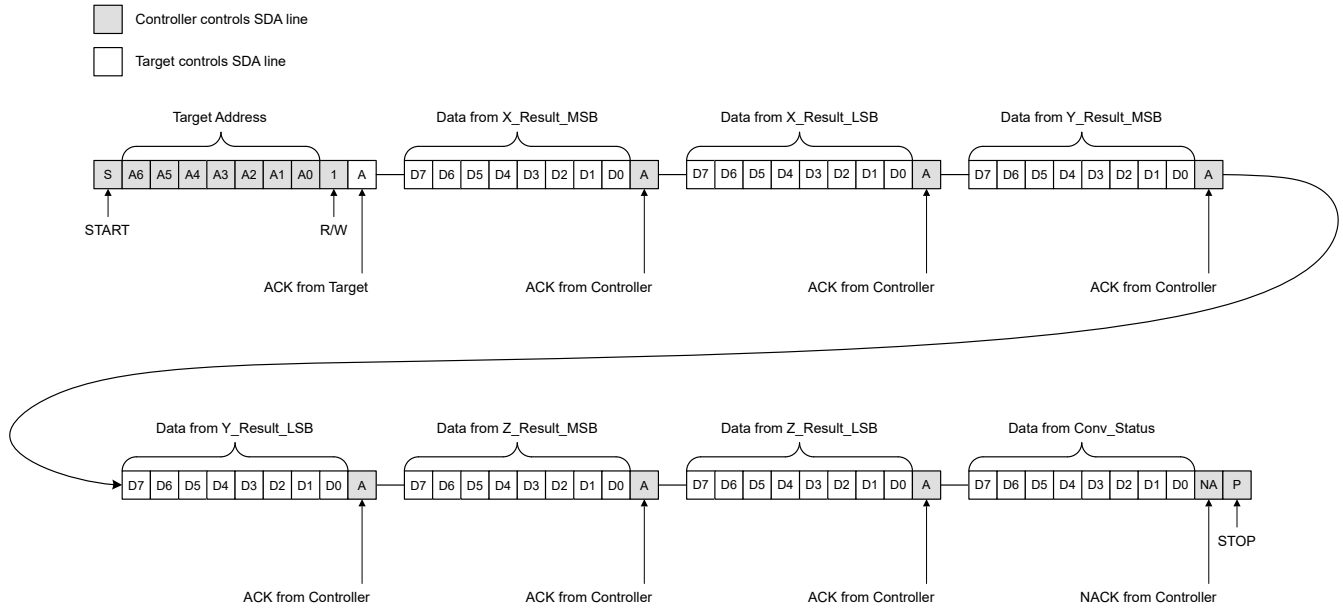


**Figure 6-18. I<sup>2</sup>C Read Command for 16-Bit Data With CRC Disabled, X-Axis Enabled**

- Controller controls SDA line
- Target controls SDA line

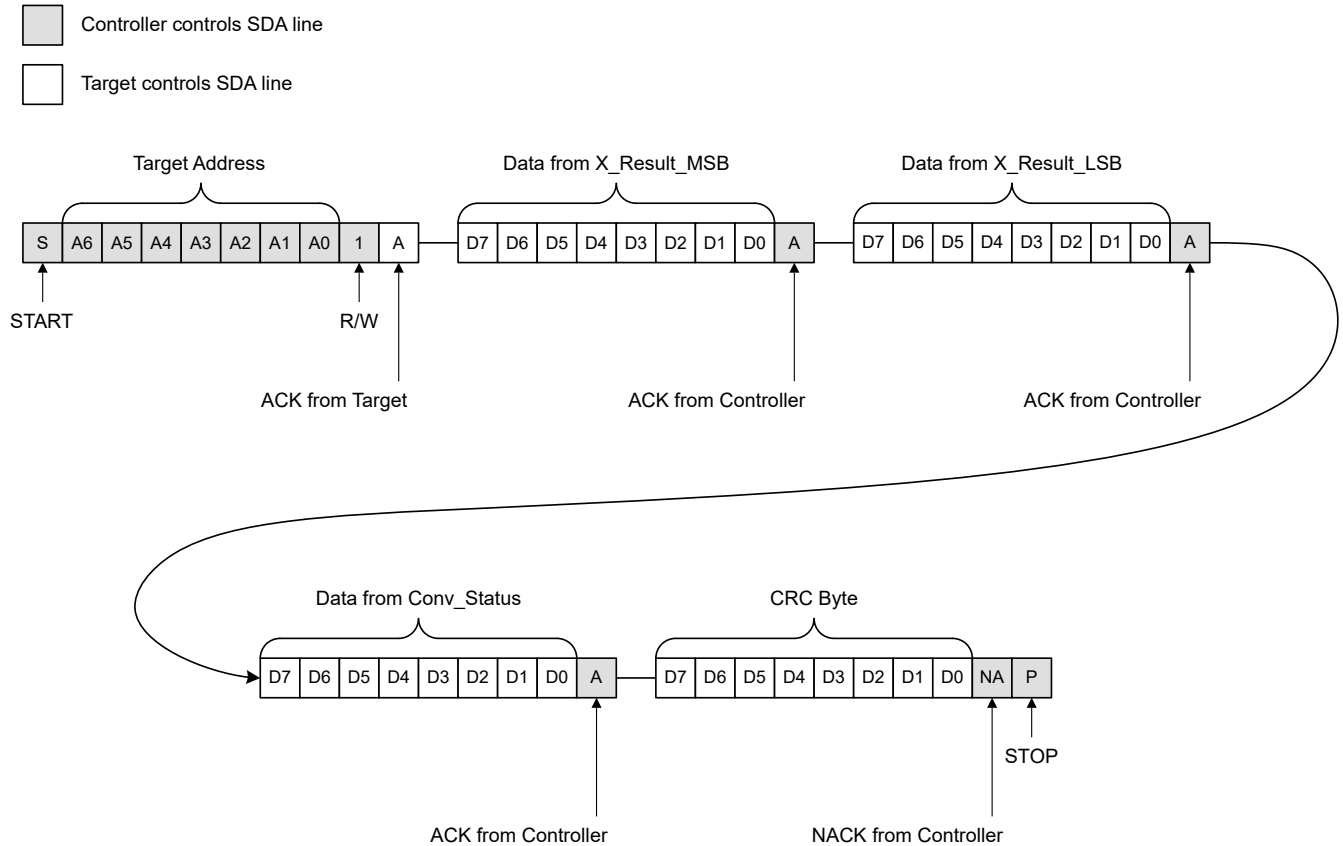


**Figure 6-19. I<sup>2</sup>C Read Command for 16-Bit Data With CRC Disabled, Y and Z Axes Enabled**



**Figure 6-20. I<sup>2</sup>C Read Command for 16-Bit Data With CRC Disabled, X, Y, and Z Axes Enabled**

Only the X-axis with CRC is shown, but other channels that are enabled use the same sequence format.



**Figure 6-21. I<sup>2</sup>C Read Command for 16-Bit Data With CRC Enabled, X-Axis Enabled**

6.5.1.2.5 I<sup>2</sup>C Read Command for 8-Bit Data

The TMAG3001 allows the user to read from the result registers without writing to the control register and setting the address pointer when I2C\_RD[1:0] = 2h for MSB data only. When multiple channels are enabled, data is sent in the order of X-axis, Y-axis, Z-axis, and Conv\_Status. When a channel is disabled, the channel is skipped in the data sequence.

In the Read Command for 8-bit data, only up to three channels of data can be sent when CRC is enabled. This restriction does not apply if CRC is disabled.

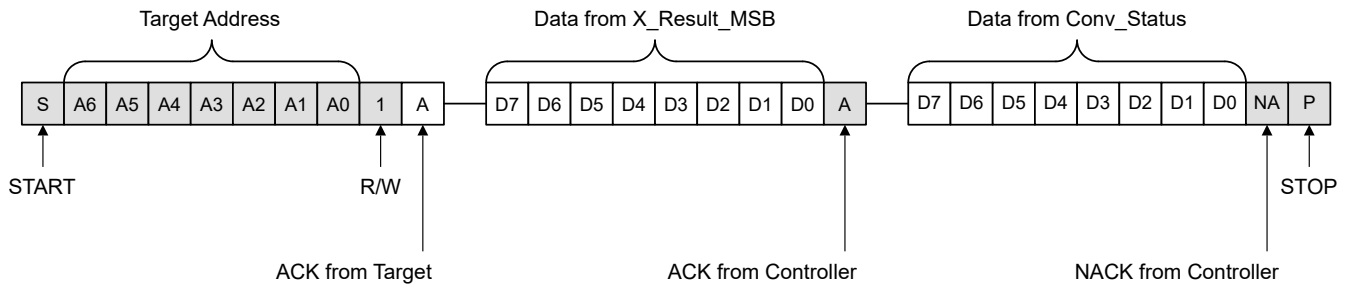
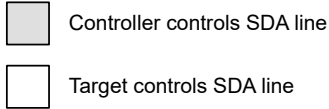


Figure 6-22. I<sup>2</sup>C Read Command for 8-Bit Data With CRC Disabled, X-Axis Enabled

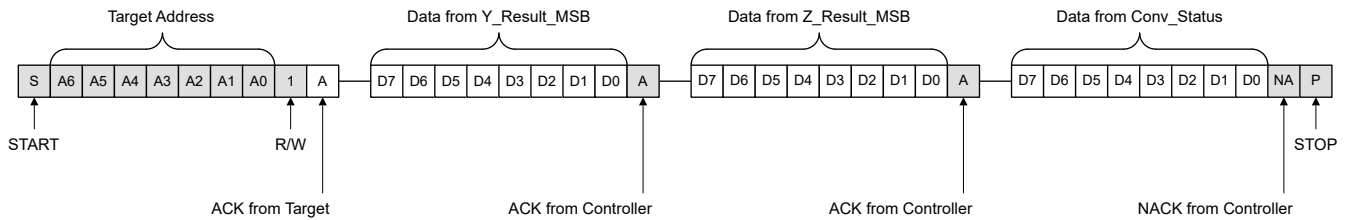
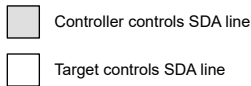


Figure 6-23. I<sup>2</sup>C Read Command for 8-Bit Data With CRC Disabled, Y and Z Axes Enabled



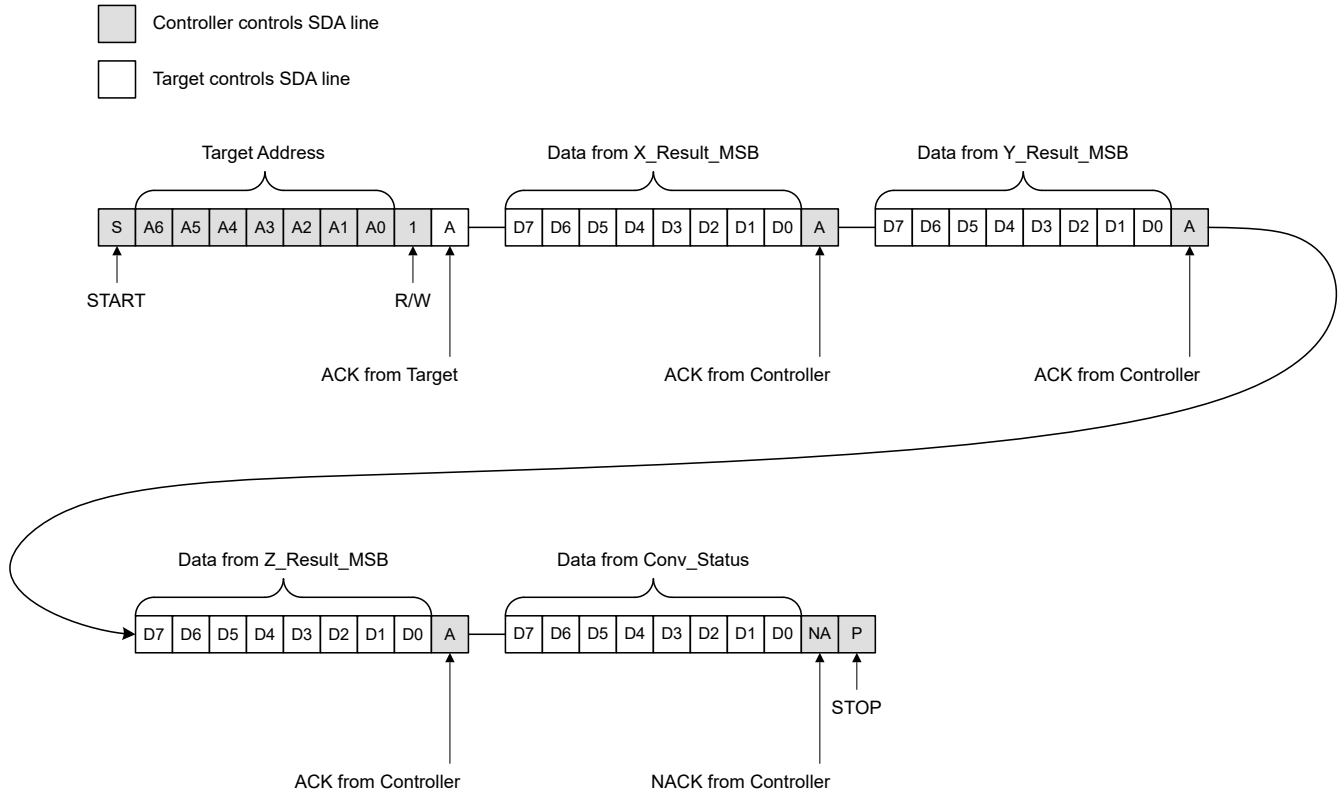


Figure 6-24. I<sup>2</sup>C Read Command for 8-Bit Data With CRC Disabled, X, Y, and Z Axes Enabled

Only the X-axis with CRC is shown, but other channels that are enabled use the same sequence format.

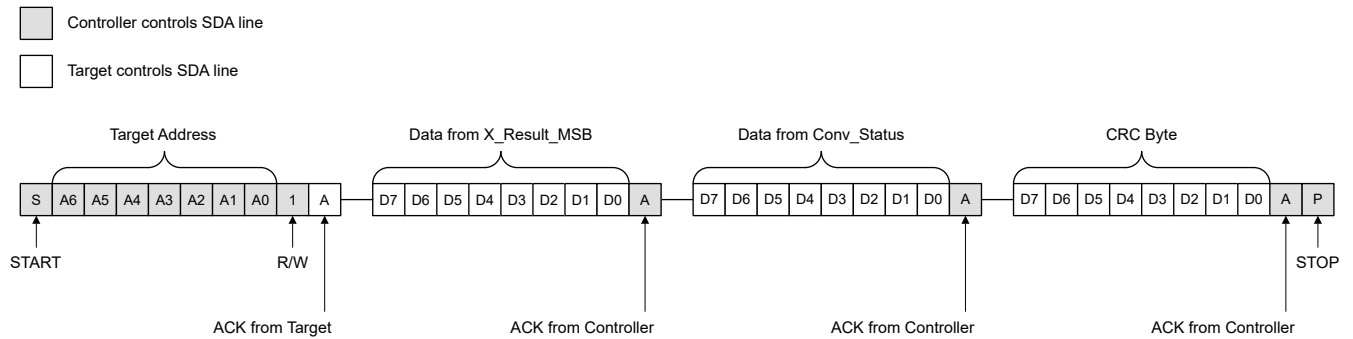


Figure 6-25. I<sup>2</sup>C Read Command for 8-Bit Data With CRC Enabled, X-Axis Enabled

### 6.5.1.2.6 I<sup>2</sup>C Read CRC

The TMAG3001 supports optional CRC during I<sup>2</sup>C read. The CRC can be enabled through the CRC\_EN register bit. The CRC is performed on a data string that is determined by the I<sup>2</sup>C read type. The CRC information is sent as a single byte after the data bytes. The code is generated by the polynomial  $x^8 + x^2 + x + 1$ . Initial CRC bits are FFh. When there are multiple devices on the I<sup>2</sup>C bus, the first CRC may be incorrect when communicating with the TMAG3001.

The following equations can be employed to calculate CRC:

$$d = \text{Data Input, } c = \text{Initial CRC (FFh)} \quad (1)$$

$$\text{newcrc}[0] = d[7] \wedge d[6] \wedge d[0] \wedge c[0] \wedge c[6] \wedge c[7] \quad (2)$$

$$\text{newcrc}[1] = d[6] \wedge d[1] \wedge d[0] \wedge c[0] \wedge c[1] \wedge c[6] \quad (3)$$

$$\text{newcrc}[2] = d[6] \wedge d[2] \wedge d[1] \wedge d[0] \wedge c[0] \wedge c[1] \wedge c[2] \wedge c[6] \quad (4)$$

$$\text{newcrc}[3] = d[7] \wedge d[3] \wedge d[2] \wedge d[1] \wedge c[1] \wedge c[2] \wedge c[3] \wedge c[7] \quad (5)$$

$$\text{newcrc}[4] = d[4] \wedge d[3] \wedge d[2] \wedge c[2] \wedge c[3] \wedge c[4] \quad (6)$$

$$\text{newcrc}[5] = d[5] \wedge d[4] \wedge d[3] \wedge c[3] \wedge c[4] \wedge c[5] \quad (7)$$

$$\text{newcrc}[6] = d[6] \wedge d[5] \wedge d[4] \wedge c[4] \wedge c[5] \wedge c[6] \quad (8)$$

$$\text{newcrc}[7] = d[7] \wedge d[6] \wedge d[5] \wedge c[5] \wedge c[6] \wedge c[7] \quad (9)$$

The following examples show calculated CRC byte based off various input data:

I2C Data 00h : CRC = F3h

I2C Data FFh : CRC = 00h

I2C Data 80h : CRC = 7Ah

I2C Data 4Ch : CRC = 10h

I2C Data E0h : CRC = 5Dh

I2C Data 00000000h : CRC = D1h

I2C Data FFFFFFFFh : CRC = 0Fh

## 6.5.2 Data Definition

### 6.5.2.1 Magnetic Sensor Data

The X, Y, and Z magnetic sensor data are stored in 16-bit 2's complement in `_Result_MSB` and `_Result_LSB` registers for the corresponding channel. When `Conv_AVG = 0h`, the ADC output loads the 12 MSB bits of the 16-bit result along with 4 LSB bits as zeros. When `Conv_AVG ≠ 0h`, all 16 bits are used to store the results. [Table 6-8](#) shows example data out for `X_Result[15:0]`. For the table, three decimal places are used in the calculation. The data format is the same for `Y_Result[15:0]` and `Z_Result[15:0]`. The LSB size for each magnetic range is:

- 40mT: 885LSB/mT
- 80mT: 446LSB/mT
- 120mT: 273LSB/mT
- 240mT: 137LSB/mT

**Table 6-8. 16-Bit X, Y, Z Magnetic Sensor Data Format**

MAGNETIC FIELD (mT)				X_RESULT[15:0]	
RANGE = 40mT	RANGE = 80mT	RANGE = 120mT	RANGE = 240mT	BINARY	HEX
-39.009	-78.019	-120.029	-239.182	1000 0000 0000 0000	8000h
-19.504	-39.009	-60.014	-119.591	1100 0000 0000 0000	C000h
-0.001	-0.002	-0.003	-0.007	1111 1111 1111 1111	FFFFh
0	0	0	0	0000 0000 0000 0000	0000h
0.001	0.002	0.003	0.007	0000 0000 0000 0001	0001h
19.504	39.009	60.014	119.591	0100 0000 0000 0000	4000h
39.008	78.016	120.025	239.175	0111 1111 1111 1111	7FFFh

### 6.5.2.2 Temperature Sensor Data

The TMAG3001 measures temperature and store the value in the `Temp_Result[15:0]` field of the `T_Result_MSB` and `T_Result_LSB` registers. [Table 6-9](#) shows the sensor output stored in a 16-bit 2's complement format in two 8-bit registers. For the table, only three decimal places are used in the calculations. The data can be retrieved as 16-bit format combining both MSB and LSB registers, or as 8-bit format through the MSB register.

Use [Equation 10](#) to calculate the measured temperature in degree Celsius for 16-bit data, and use [Equation 11](#) to calculate the measured temperature in degree Celsius for 8-bit data.

$$T = T_{\text{SENS\_T0}} + \frac{\text{Temp\_Result}[15:0] - T_{\text{ADC\_T0}}}{T_{\text{ADC\_RES}}} \quad (10)$$

where

- T is the measured temperature in degree Celsius
- $T_{\text{SENS\_T0}}$  is 25°C
- $T_{\text{ADC\_RES}}$  is 58.2 LSB/°C
- $T_{\text{ADC\_T0}}$  is 17512
- `Temp_Result[15:0]` is the decimal value the temperature registers

$$T = T_{\text{SENS\_T0}} + \frac{256 \times \left( T_{\text{ADC\_T}} - \frac{\text{Temp\_Result}[15:8]}{256} \right)}{T_{\text{ADC\_RES}}} \quad (11)$$

**Table 6-9. 16-Bit Temperature Data Format**

TEMPERATURE (°C)	TEMP_RESULT[15:0]	
	BINARY	HEX
-40	0011 0101 1010 0001	35A1h
-25	0011 1001 0000 1010	390Ah
0	0011 1110 1011 1001	3EB9h
25	0100 0100 0110 1000	4468h
25.02	0100 0100 0110 1001	4469h
85	0101 0001 1111 1100	520Ch
125	0101 1011 0000 1100	5B0Ch

### 6.5.2.3 Magnetic Sensor Gain Correction

The TMAG3001 enables gain correction for one of the magnetic axes if needed. [Table 6-10](#) shows the register configuration to set magnetic gain. MAG\_GAIN\_CH and ANGLE\_EN[1:0] bits are used to set the specific magnetic channel that can be configured for gain modification. The Sensor\_Config\_4 register is used to store the Gain\_Config to be corrected as an 8-bit value.

**Table 6-10. Register Field Settings to Configure for Magnetic Gain Correction**

REGISTER NAME	REGISTER ALIAS WHEN ANGLE_EN=1b AND THR_SEL = 00 OR 01 OR 11b	DESCRIPTION
Sensor_Config_4	Gain_Config[7:0]	Configure the gain of one of the magnetic channels as defined by MAG_GAIN_CH and ANGLE_EN[1:0] values of Sensor_Config_2 register

The Gain\_Config[7:0] is a direct multiplier to the measured magnetic field with a value between 0 and 1. The LSB size of Gain\_Config[7:0] is 0.00390625. For example, if the field measured by the TMAG3001 was 20mT and a Gain\_Config[7:0] setting of 80h was used, a gain setting of 0.5, the resultant value of X\_Result is 10mT.

**Table 6-11. 8-Bit Gain\_Config Data Format**

GAIN (mT/mT)	GAIN_CONFIG[7:0]	
	BINARY	HEX
0	0000 0000	00h
0.00390625	0000 0001	01h
0.25	0100 0000	40h
0.5	1000 0000	80h
0.75	1100 0000	C0h
0.99609375	1111 1111	FFh

As an example, [Figure 6-26](#) shows the amplitude of a corrected magnetic field using the Gain\_Config[7:0] register settings. The selection and order of the sensors are defined in the ANGLE\_EN[1:0] register bits setting. The gain correction for the selected channel is disabled if the Gain\_Config[7:0] registers are set to 00h.

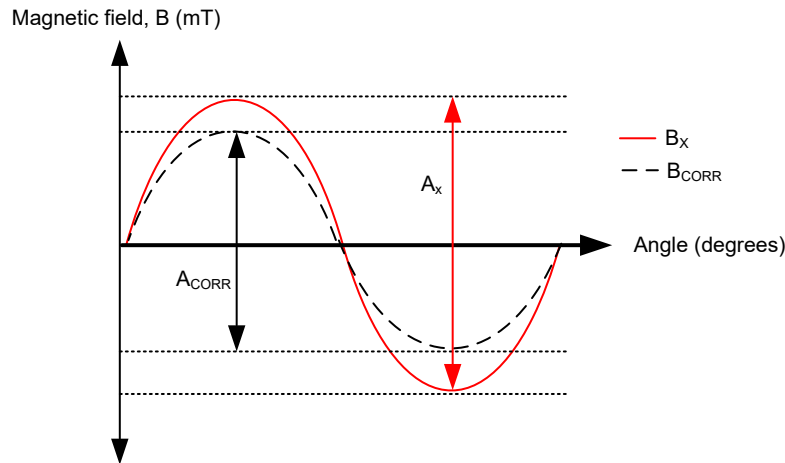


Figure 6-26. Magnetic Sensor Data Gain Correction

#### 6.5.2.4 Magnetic Sensor Offset Correction

The TMAG3001 enables offset correction for a pair of magnetic axes.

Table 6-12. Register Field Settings to Configure for Magnetic Offsets

REGISTER NAME	REGISTER ALIAS WHEN ANGLE_EN[1:0] = 1h OR 2h OR 3h. Or THR_SEL[1:0] = 0h OR 1h OR 3h	DESCRIPTION
<a href="#">Sensor_Config_5</a>	Offset_Config_1	Sets the offset for first channel
<a href="#">Sensor_Config_6</a>	Offset_Config_2	Sets the offset for second channel

The offset correction is stored in 8-bit 2's complement format. Table 6-13 shows example offset for Offset\_Config\_x where x can be the first or second channel. For the table, only three decimal places are shown. The data format is the same for Offset\_Config\_1[7:0] and Offset\_Config\_2[7:0]. The LSB size for each magnetic range is:

- 40mT: 51.2LSB/mT
- 80mT: 25.6LSB/mT
- 120mT: 15.3985LSB/mT
- 240mT: 7.70LSB/mT

Table 6-13. 8-Bit Magnetic Sensor Offset Correction Data Format

MAGNETIC OFFSET (mT)				OFFSET_CONFIG_X[7:0]	
RANGE = 40mT	RANGE = 80mT	RANGE = 120mT	RANGE = 240mT	BINARY	HEX
-2.5	-5	-8.313	-16.625	1000 0000	80h
-1.992	-3.984	-6.624	-13.248	1001 1010	9Ah
-0.019	-0.039	-0.065	-0.130	1111 1111	FFh
0	0	0	0	0000 0000	00h
0.019	0.039	0.065	0.130	0000 0001	01h
1.992	3.984	6.624	13.248	0110 0110	66h
2.480	4.961	8.248	16.495	0111 1111	7Fh

As an example, if the uncorrected waveform for a particular axis has a value that is offset by 2mT, enter the offset correction value of -2mT in the corresponding Offset\_Config\_x[7:0] bit field. This value is added to the measured field before (or after) any gain setting is applied. The selection and order of the sensors are defined in the ANGLE\_EN register bits setting. The default value of these offset correction registers are set as zero, when offset correction is enabled.

### 6.5.2.5 Angle and Magnitude Data Definition

The TMAG3001 calculates the angle from a pair of magnetic axes based off the Angle\_EN[1:0] setting. The 13-bit Angle\_Result[12:0] value is stored in the Angle\_Result\_MSB and Angle\_Result\_LSB registers. The data format is an unsigned angle value with LSB size of 0.0625°. The table below shows example angle values.

**Table 6-14. 13-Bit Angle Data Format**

ANGLE (°)	ANGLE_RESULT[12:0]	
	BINARY	HEX
0	0 0000 0000 0000	0000h
0.0625	0 0000 0000 0001	0001h
90	0 0101 1010 0000	05A0h
180	0 1011 0100 0000	0B40h
270	1 0000 1110 0000	10E0h
360	1 0110 1000 0000	1680h

During the angle calculation, the Magnitude\_Result[7:0] stores the resultant vector magnitude in the Magnitude\_Result register. Magnitude\_Result[7:0] is an unsigned value with a LSB size that depends on the range of device. For the table below, only 3 decimal places are shown.

- 40mT: 3.281LSB/mT
- 80mT: 1.640LSB/mT
- 120mT: 1.066LSB/mT
- 240mT: 0.535LSB/mT

For on-axis angular measurement, the magnitude value must remain constant across the full 360° measurement.

**Table 6-15. 8-Bit Magnitude Data Format**

MAGNITUDE (mT)				MAGNITUDE_RESULT[7:0]	
RANGE = 40mT	RANGE = 80mT	RANGE = 120mT	RANGE = 240mT	BINARY	HEX
0	0	0	0	0000 0000	00h
0.304	0.609	0.937	1.868	0000 0001	01h
4.571	9.142	14.065	28.029	0000 1111	0Fh
37.7904	75.580	116.278	231.708	0111 CC00	7Ch
77.714	155.428	239.120	476.496	1111 1111	FFh

### 6.5.2.6 Angle Offset Correction

The TMAG3001 enables offset correction for a pair of magnetic axes to set a zero reference to compensate for the magnet placement errors after installation. The THR\_CONFIG\_3 register stores the offset values. The default value of these offset correction registers are set as zero. To enable the angle offset correction, Angle\_Offset\_EN bit is set to 1h. The selection and order of the sensors are defined in the Angle\_EN[1:0] register bits setting. The Angle\_Offset\_DIR provides the ability to add or subtract the angle offset value. The TMAG3001 provides the ability to correct the angle offset by  $\pm 255$  degrees with a resolution of 1°/LSB.

**Table 6-16. Register Field Settings to Configure for Angle Offset Correction**

REGISTER NAME	REGISTER ALIAS WHEN THR_SEL[1:0] = 1h, OR 3h	DESCRIPTION
THR_Config_3	Angle_Offset[7:0]	Adds an angle offset to Angle_Result[12:0]. The resolution of the angle offset is 1 degree.

**Table 6-17. 8-Bit Angle Offset Data Format**

ANGLE (°)	Angle_Offset[7:0]	
	BINARY	HEX
0	0000 0000	00h
1	0000 0001	01h
90	0101 1010	5Ah
180	1011 0100	B4h
255	1111 1111	FFh

## 7 Register Maps

### 7.1 TMAG3001 Registers

Result and status register values are locked at the start of any I<sup>2</sup>C transaction. If a conversion finishes during an I<sup>2</sup>C transaction, the latest results are updated immediately after the STOP bit of that transaction.

**Table 7-1. TMAG3001 Registers**

ADDRESS	TYPE	RESET	ACRONYM	REGISTER NAME	SECTION
0h	R/W	00h	Device_Config_1	Configure Device Operation Modes	<a href="#">Go</a>
1h	R/W	00h	Device_Config_2	Configure Device Operation Modes	<a href="#">Go</a>
2h	R/W	00h	Sensor_Config_1	Sensor Device Operation Modes	<a href="#">Go</a>
3h	R/W	00h	Sensor_Config_2	Sensor Device Operation Modes	<a href="#">Go</a>
4h	R/W	00h	THR_Config_1	Threshold Configuration	<a href="#">Go</a>
5h	R/W	00h	THR_Config_2	Threshold Configuration	<a href="#">Go</a>
6h	R/W	00h	THR_Config_3	Threshold Configuration	<a href="#">Go</a>
7h	R/W	00h	Sensor_Config_3	Configure Device Operation Modes	<a href="#">Go</a>
8h	R/W	00h	INT_Config_1	Configure Device Operation Modes	<a href="#">Go</a>
9h	R/W	00h	Sensor_Config_4	Configure Device Operation Modes	<a href="#">Go</a>
Ah	R/W	00h	Sensor_Config_5	Configure Device Operation Modes	<a href="#">Go</a>
Bh	R/W	00h	Sensor_Config_6	Configure Device Operation Modes	<a href="#">Go</a>
Ch	R/W	00h	I2C_Address	I2C Address Register	<a href="#">Go</a>
Dh	R	0xh	Device_ID	ID for the device die	<a href="#">Go</a>
Eh	R	49h	Manufacturer_ID_LSB	Manufacturer ID lower byte	<a href="#">Go</a>
Fh	R	54h	Manufacturer_ID_MSB	Manufacturer ID upper byte	<a href="#">Go</a>
10h	R	00h	T_Result_MSB	Conversion Result Register	<a href="#">Go</a>
11h	R	00h	T_Result_LSB	Conversion Result Register	<a href="#">Go</a>
12h	R	00h	X_Result_MSB	Conversion Result Register	<a href="#">Go</a>
13h	R	00h	X_Result_LSB	Conversion Result Register	<a href="#">Go</a>
14h	R	00h	Y_Result_MSB	Conversion Result Register	<a href="#">Go</a>
15h	R	00h	Y_Result_LSB	Conversion Result Register	<a href="#">Go</a>
16h	R	00h	Z_Result_MSB	Conversion Result Register	<a href="#">Go</a>
17h	R	00h	Z_Result_LSB	Conversion Result Register	<a href="#">Go</a>
18h	R	00h	Conv_Status	Conversion Status Register	<a href="#">Go</a>
19h	R	00h	Angle_Result_MSB	Conversion Result Register	<a href="#">Go</a>
1Ah	R	00h	Angle_Result_LSB	Conversion Result Register	<a href="#">Go</a>
1Bh	R	00h	Magnitude_Result	Conversion Result Register	<a href="#">Go</a>
1Ch	R	00h	Device_Status	Device_Diag Status Register	<a href="#">Go</a>

**Table 7-2. TMAG3001 Access Type Codes**

Access Type	Code	Description
<b>Read Type</b>		
R	R	Read
<b>Write Type</b>		
W	W	Write
W1C	W 1C	Write 1 to clear
<b>Reset or Default Value</b>		
- n		Value after reset or the default value



### 7.1.1 Device\_Config\_1 Register (Address= 0h) [Reset = 00h]

Device\_Config\_1 allows the configuration of CRC, magnetic tempco, averaging, and I2C read mode.

Return to [Register Map](#).

**Figure 7-1. Device\_Config\_1 Register**

7	6	5	4	3	2	1	0
CRC_EN	MAG_Tempco[1:0]		Conv_AVG[2:0]			I2C_RD[1:0]	
R/W-0h	R/W-0h		R/W-0h			R/W-0h	

**Table 7-3. Device\_Config\_1 Register Field Descriptions**

Bit	Field	Type	Reset	Description
7	CRC_EN	R/W	0h	Enables I2C CRC byte to added to I2C read transactions 0h = CRC disabled 1h = CRC enabled
6-5	MAG_Tempco[1:0]	R/W	0h	Temperature Coefficient of Sense Magnet 0h = 0% (Current sensor applications) 1h = 0.12%/ deg C (NdBFe) 2h = 0.03% / deg C (SmCo) 3h = 0.2%/deg C (Ceramic)
4-2	Conv_AVG[2:0]	R/W	0h	Enables additional sampling of the sensor data to reduce the noise effect (or to increase resolution) 0h = 1x - 10.5 ksps (3-axes) or 22 ksps (1 axis) 1h = 2x - 5.9 ksps (3-axes) or 14.3 ksps (1 axis) 2h = 4x - 3.1 ksps (3-axes) or 8.3 ksps (1 axis) 3h = 8x - 1.6 ksps (3-axes) or 4.5 ksps (1 axis) 4h = 16x - 0.8 ksps (3-axes) or 2.4 ksps (1 axis) 5h = 32x - 0.4 ksps (3-axes) or 1.2 ksps (1 axis)
1-0	I2C_RD[1:0]	R/W	0h	Defines the I2C read mode 0h = Standard I2C 3-byte read command 1h = 1-byte I2C read command for 16 bit sensor data and conversion status 2h = 1-byte I2C read command for 8 bit sensor MSB data and conversion status 3h = Reserved

### 7.1.2 Device\_Config\_2 Register (Address = 01h) [Reset = 00h]

Device\_Config\_2 can be used to configure device operation.

Return to [Register Map](#).

**Figure 7-2. Device\_Config\_2 Register**

7	6	5	4	3	2	1	0
THR_HYST[2:0]			LP_LN	I2C_Glitch_Filter	Trigger_Mode	Operating_Mode[1:0]	
R/W-0h			R/W-0h	R/W-0h	R/W-0h	R/W-0h	

**Table 7-4. Device\_Config\_2 Register Field Descriptions**

Bit	Field	Type	Reset	Description
7-5	THR_HYST[2:0]	R/W	0h	Select hysteresis for the magnetic field thresholds in switch mode (INT_MODE = 5h or 6h) or wake on change mode (WOC_SEL = 2h) 0h = 2 LSB of threshold, 12 bit resolution (switch mode)   1 LSB of threshold, 8 bit resolution (wake on change mode) 1h = 4 LSB of threshold, 12 bit resolution (switch mode)   2 LSB of threshold, 8 bit resolution (wake on change mode) 2h = 8 LSB of threshold, 12 bit resolution (switch mode)   4 LSB of threshold, 8 bit resolution (wake on change mode) 3h = 16 LSB of threshold, 12 bit resolution (switch mode)   8 LSB of threshold, 8 bit resolution (wake on change mode) 4h = 32 LSB of threshold, 12 bit resolution (switch mode)   16 LSB of threshold, 8 bit resolution (wake on change mode) 5h = 64 LSB of threshold, 12 bit resolution (switch mode)   32 LSB of threshold, 8 bit resolution (wake on change mode) 6h = 128 LSB of threshold, 12 bit resolution (switch mode)   64 LSB of threshold, 8 bit resolution (wake on change mode) 7h = 256 LSB of threshold, 12 bit resolution (switch mode)   128 LSB of threshold, 8 bit resolution (wake on change mode)
4	LP_LN	R/W	0h	Selects the modes between low active current or low-noise modes 0h = Low active current mode 1h = Low noise mode
3	I2C_Glitch_Filter	R/W	0h	I2C glitch filter 0h = Glitch filter on 1h = Glitch filter off
2	Trigger_Mode	R/W	0h	Selects a condition which initiates a single conversion based off already configured registers. A running conversion completes before executing a trigger. Redundant triggers are ignored. TRIGGER_MODE is available only during the modes explicitly mentioned in OPERATING_MODE[1:0]. 0h = Conversion Start at I2C Command Bits, DEFAULT 1h = Conversion starts through trigger signal at INT pin
1-0	Operating_Mode[1:0]	R/W	0h	Selects Operating Mode and updates value based on operating mode if device transitions from Wake-up and sleep mode to Standby mode. 0h = Standby Mode (starts new conversion at trigger event) 1h = Sleep mode 2h = Continuous mode 3h = Wake-up and Sleep mode (duty-cycled mode)

### 7.1.3 Sensor\_Config\_1 Register (Address = 02h) [Reset = 00h]

Sensor\_Config\_1 can be used to configure the magnetic channels enabled and the sleep time for operating in wake and sleep mode.

Return to [Register Map](#).

**Figure 7-3. Sensor\_Config\_1 Register**

<b>7</b>	<b>6</b>	<b>5</b>	<b>4</b>	<b>3</b>	<b>2</b>	<b>1</b>	<b>0</b>
MAG_CH_EN[3:0]				SLEEPTIME[3:0]			
R/W-0h				R/W-0h			

**Table 7-5. Sensor\_Config\_1 Register Field Descriptions**

Bit	Field	Type	Reset	Description
7-4	MAG_CH_EN[3:0]	R/W	0h	Enables data acquisition of the magnetic axis channel 0h = All magnetic channels of OFF, DEFAULT 1h = X channel enabled 2h = Y channel enabled 3h = X, Y channel enabled 4h = Z channel enabled 5h = Z, X channel enabled 6h = Y, Z channel enabled 7h = X, Y, Z channel enabled 8h = XYX channel enabled 9h = YXY channel enabled Ah = YZY channel enabled Bh = XZX channel enabled Ch = X,Y,Z with positive diagnostic offset Dh = X,Y,Z with negative diagnostic offset Eh = Hall resistance check + ADC check Fh = Hall offset check +AFE check
3-0	SLEEPTIME[3:0]	R/W	0h	Selects the time spent in low power mode between conversions when Operating_Mode[1:0] = 3h 0h = 1ms 1h = 5ms 2h = 10ms 3h = 15ms 4h = 20ms 5h = 30ms 6h = 50ms 7h = 100ms 8h = 500ms 9h = 1000ms Ah = 2000ms Bh = 5000ms Ch = 20000ms

### 7.1.4 Sensor\_Config\_2 Register (Address = 03h) [Reset = 00h]

Sensor\_Config\_2 can be used to configure general sensor operation.

Return to [Register Map](#)

**Figure 7-4. Sensor\_Config\_2 Register**

7	6	5	4	3	2	1	0
T_Rate	INTB_POL	MAG_THR_DIR	MAG_Gain_CH	Angle_EN[1:0]		X_Y_Range	Z_Range
R/W-0h	R/W-0h	R/W-0h	R/W-0h	R/W-0h		R/W-0h	R/W-0h

**Table 7-6. Sensor\_Config\_2 Register Field Descriptions**

Bit	Field	Type	Reset	Description
7	T_Rate	R/W	0h	Temperature Averaging 0h = Single temp conversion if MAG_CH_EN > 0 1h = Filtering per Conv_AVG[2:0]
6	INTB_POL	R/W	0h	Selects the polarity of the interrupt event 0h = INTB pin is set to default high and active low during an interrupt event 1h = INTB pin is set to default low and active high during an interrupt event
5	MAG_THR_DIR	R/W	0h	Selects the direction of threshold check 0h = sets interrupt for external field above the threshold 1h = sets interrupt for external field below the threshold
4	MAG_Gain_CH	R/W	0h	Selects the axis for magnitude gain correction value entered in Sensor_Config_4 register 0h = 1st channel is selected for gain adjustment 1h = 2nd channel is selected for gain adjustment
3-2	Angle_EN[1:0]	R/W	0h	Enables angle calculation, magnetic gain, and offset corrections between two selected magnetic channels 0h = No angle calculation 1h = X 1st, Y 2nd 2h = Y 1st, Z 2nd 3h = X 1st, Z 2nd
1	X_Y_Range	R/W	0h	Select the X and Y axes magnetic range from 2 different options: 0h = ±40mT (TMAG3001x1) or ±120mT (TMAG3001x2) 1h = ±80mT (TMAG3001x1) or ±240mT (TMAG3001x2)
0	Z_Range	R/W	0h	Select the Z axis magnetic range from 2 different options: 0h = ±40mT (TMAG3001x1) or ±120mT (TMAG3001x2) 1h = ±80mT (TMAG3001x1) or ±240mT (TMAG3001x2)

### 7.1.5 THR\_Config\_1 Register (Address = 04h) [Reset = 00h]

THR\_Config\_1 can be used to configure X\_THRLO, ANGLE\_TH\_REF, MAG\_THRLO via the Threshold1[7:0] field.

Return to [Register Map](#)

**Figure 7-5. THR\_Config\_1 Register**

7	6	5	4	3	2	1	0
Threshold1[7:0]							
R/W-00h							

**Table 7-7. THR\_Config\_1 Register Field Descriptions**

Bit	Field	Type	Reset	Description
7-0	Threshold1[7:0]	R/W	00h	<p>Configuration functionality and LSB is based on THR_SEL[1:0] bits:</p> <p>If THR_SEL[1:0] = 1h then Threshold1[7:0] = A_THR_REF (Reference threshold for Angle). A_THR_REF is absolute angle coded an unsigned 8-bit value, with a resolution of 2° per LSB and max range of 360°</p> <p>If THR_SEL[1:0] = 2h then Threshold1[7:0] = X_THR_LO (Low threshold for X channel). If INT_Mode ≠ 5h, X_THR_LO[6:0] create a positive magnetic low threshold for the X channel (X_THR_LO[7] is ignored). If INT_Mode = 5h (unipolar switch mode), X_THR_LO is treated as an 8-bit signed magnitude integer, where X_THR_LO[7] represents the sign (0 for positive, 1 for negative) and X_THR_LO[6:0] represent the magnitude.</p> <p>If THR_SEL[1:0] = 11b then Threshold1[7:0] = M_THR_LO (Low threshold for Magnitude). M_THR_LO is an unsigned 8-bit value with a LSB size that depends on the range of the device.</p> <ul style="list-style-type: none"> <li>• 40mT: 3.281LSB/mT</li> <li>• 80mT: 1.640LSB/mT</li> <li>• 120mT: 1.066LSB/mT</li> <li>• 240mT: 0.535LSB/mT</li> </ul>

### 7.1.6 THR\_Config\_2 Register (Address = 05h) [Reset = 00h]

THR\_Config\_2 can be used to configure Y\_THRLO, ANGLE\_TH\_BAND, MAG\_THRHI via the Threshold2[7:0] field.

Return to [Register Map](#)

**Figure 7-6. THR\_Config\_2 Register**

7	6	5	4	3	2	1	0
Threshold2[7:0]							
R/W-00h							

**Table 7-8. THR\_Config\_2 Register Field Descriptions**

Bit	Field	Type	Reset	Description
7-0	Threshold2[7:0]	R/W	00h	<p>Configuration functionality and LSB is based on THR_SEL[1:0] bits:</p> <p>If THR_SEL[1:0] = 1h, then Threshold2[7:0] = A_THR_BAND (Threshold band for Angle). A_THR_BAND is an absolute angle coded on an unsigned 8-bit value, with a resolution of 1° per LSB and a maximum range of up to 180°.</p> <p>If THR_SEL[1:0] = 2h, then Threshold2[7:0] = Y_THR_LO (Low threshold for Y channel). If INT_Mode ≠ 5h, Y_THR_LO[6:0] create a positive magnetic low threshold for the Y channel (Y_THR_LO[7] is ignored). If INT_Mode = 5h (unipolar switch mode), Y_THR_LO is treated as an 8-bit signed magnitude integer, where Y_THR_LO[7] represents the sign (0 for positive, 1 for negative) and Y_THR_LO[6:0] represent the magnitude.</p> <p>If THR_SEL[1:0] = 3h, then Threshold2[7:0] = M_THR_HI (High threshold for Magnitude). M_THR_HI is an unsigned 8-bit value with a LSB size that depends on the range of the device.</p> <ul style="list-style-type: none"> <li>• 40mT: 3.281LSB/mT</li> <li>• 80mT: 1.640LSB/mT</li> <li>• 120mT: 1.066LSB/mT</li> <li>• 240mT: 0.535LSB/mT</li> </ul>

### 7.1.7 THR\_Config\_3 Register (Address = 06h) [Reset = 00h]

THR\_Config\_3 is shown in [Table 7-9](#).

Return to [Register Map](#)

Z\_THRLO, ANGLE\_OFFSET

**Figure 7-7. THR\_Config\_3 Register**

7	6	5	4	3	2	1	0
Threshold3[7:0]							
R/W-00h							

**Table 7-9. THR\_CONFIG\_3 Register Field Descriptions**

Bit	Field	Type	Reset	Description
7-0	Threshold3[7:0]	R/W	00h	<p>Configuration functionality and LSB is based on THR_SEL[1:0] bits:            If THR_SEL[1:0] = 1h, then Threshold3[7:0] = Angle_Offset[7:0].            Unsigned 8-bit angle value with a resolution of 1° per LSB.            Angle_Offset_DIR provides the ability to add or subtract the angle offset value.</p> <p>If THR_SEL[1:0] = 2h, then Threshold3[7:0] = Z_THR_LO (Low threshold for Z channel). If INT_Mode ≠ 5h, Z_THR_LO[6:0] create a positive magnetic low threshold for the Z channel (Z_THR_LO[7] is ignored). If INT_Mode = 5h (unipolar switch mode), Z_THR_LO is treated as an 8-bit signed magnitude integer, where Z_THR_LO[7] represents the sign (0 for positive, 1 for negative) and Z_THR_LO[6:0] represent the magnitude.</p> <p>If THR_SEL[1:0] = 3h, then Threshold3[7:0] = Angle_Offset[7:0].            Unsigned 8-bit angle value with a resolution of 1° per LSB.            Angle_Offset_DIR provides the ability to add or subtract the angle offset value.</p>

### 7.1.8 Sensor\_Config\_3 Register (Address = 07h) [Reset = 00h]

Sensor\_Config\_3 is used to configure the Wake on change, Thresholds functionality, Angle hysteresis and offset.

Return to [Register Map](#)

**Figure 7-8. Sensor\_Config\_3 Register**

7	6	5	4	3	2	1	0
WOC_SEL[1:0]		THR_SEL[1:0]		Angle_HYS[1:0]		Angle_Offset_E N	ANG_Offset_DI R
R/W-0h		R/W-0h		R/W-0h		R/W-0h	R/W-0h

**Table 7-10. Sensor\_Config\_3 Register Field Descriptions**

Bit	Field	Type	Reset	Description
7-6	WOC_SEL[1:0]	R/W	0h	Enables an interrupt response when any of the measured magnetic readings differ from the previous measurements by THR_HYST. 0h = Wake on change disabled 1h = Wake on change from previous angle measurements. ANGLE_EN bits must to be set to a value other than 0h. 2h = Wake on change from previous magnetic field measurement for one axis. Only responds to changes in the first axis enabled (X, Y, or Z) according to MAG_CH_EN 3h = Reserved
5-4	THR_SEL[1:0]	R/W	0h	Sets the functionality of the THR_Config_1, THR_Config_2 and THR_Config_3 registers 0h = No threshold selected 1h = Angle Thresholds selected. Threshold1[7:0] sets A_THR_REF and Threshold2[7:0] sets A_THR_BAND 2h = B Field Thresholds selected. Threshold1[7:0] sets X_THR_LO, Threshold2[7:0] sets Y_THR_LO, and Threshold3[7:0] sets Z_THR_LO. Gain_X_THR_HI[7:0] sets X_THR_HI, Offset1_Y_THR_HI[7:0] sets Y_THR_HI, and Offset2_Z_THR_HI[7:0] sets Z_THR_HI. 3h = Magnitude Threshold (Button Press) selected. Threshold1[7:0] sets Magnitude_THR_LO and Threshold2[7:0] sets Magnitude_THR_HI. If THR_SEL[1:0] is not equal to 2h, Gain_X_THR_HI[7:0] sets Gain_Config, Offset1_Y_THR_HI[7:0] sets Offset1, Offset2_Z_THR_HI[7:0] sets Offset2, and Threshold3[7:0] sets Angle_Offset
3-2	Angle_HYS[1:0]	R/W	0h	Selects the hysteresis for the angle thresholds in angle switch mode (THR_SEL= 1h) or wake on change mode (WOC_SEL = 1h) 0h = 1 degree (switch mode)   4 degree change triggers interrupt (wake on change) 1h = 2 degrees (switch mode)   6 degree change triggers interrupt (wake on change) 2h = 4 degrees (switch mode)   10 degree change triggers interrupt (wake on change) 3h = 8 degrees (switch mode)   18 degree change triggers interrupt (wake on change)



**Table 7-10. Sensor\_Config\_3 Register Field Descriptions (continued)**

Bit	Field	Type	Reset	Description
1	Angle_Offset_EN	R/W	0h	Enables to add an offset to the final angle value 0h = Value from the register Angle_Offset[7:0] is not added to the final angle result 1h = Value from the register Angle_Offset[7:0] is added to the final angle result
0	Angle_Offset_DIR	R/W	0h	Indicates to add or subtract the offset value in the Angle_Offset[7:0] to the final angle result. 0h = Value from Angle_Offset[7:0] is added to the final angle result 1h = Value from Angle_Offset[7:0] is subtracted from the final angle result

### 7.1.9 INT\_Config\_1 Register (Address = 08h) [Reset = 00h]

INT\_CONFIG\_1 is shown in [Table 7-11](#).

Return to [Register Map](#)

**Figure 7-9. INT\_Config\_1 Register**

7	6	5	4	3	2	1	0
Result_INT	Threshold_INT	INT_State	INT_Mode[2:0]			INT_POL_EN	MASK_INTB
R/W-0h	R/W-0h	R/W-0h	R/W-0h			R/W-0h	R/W-0h

**Table 7-11. INT\_Config\_1 Register Field Descriptions**

Bit	Field	Type	Reset	Description
7	Result_INT	R/W	0h	Enable interrupt response on conversion complete 0h = Interrupt is not asserted when the configured set of conversions are complete 1h = Interrupt is asserted when the configured set of conversions are complete
6	Threshold_INT	R/W	0h	Enable interrupt response on a predefined threshold cross 0h = Interrupt is not asserted when a threshold is crossed 1h = Interrupt is asserted when a threshold is crossed
5	INT_State	R/W	0h	$\overline{INT}$ latched or pulsed 0h = $\overline{INT}$ interrupt latched until clear by a Controller addressing the device 1h = $\overline{INT}$ interrupt pulse for 5us
4-2	INT_Mode[2:0]	R/W	0h	Interrupt Mode Select 0h = No interrupt 1h = Interrupt through $\overline{INT}$ 2h = Interrupt through $\overline{INT}$ and ignore if I2C communication active with the Target. Conversion data lost. 3h = Interrupt through SCL based on width of interrupt 4h = Interrupt through SCL and ignore if I2C communication active irrespective of the Target address. Conversion data lost. 5h = Unipolar Switch Mode. This mode overrides any interrupt function ( $\overline{INT}$ trigger is also disabled), and only implements a Switch function. 6h = Omnipolar Switch Mode. This mode overrides any interrupt function ( $\overline{INT}$ trigger is also disabled), and only implements a Switch function. 7h = Not valid. defaults to no interrupt

**Table 7-11. INT\_Config\_1 Register Field Descriptions (continued)**

Bit	Field	Type	Reset	Description
1	INT_POL_EN	R/W	0h	0h = INT_POL bit from Sensor_Config2 is disabled 1h = INT_POL bit from Sensor_Config2 is enabled
0	MASK_INT	R/W	0h	Mask $\overline{\text{INT}}$ pin when $\overline{\text{INT}}$ connected to GND 0h = $\overline{\text{INT}}$ pin is enabled 1h = $\overline{\text{INT}}$ pin cannot be used as input or output

**7.1.10 Sensor\_Config\_4 Register (Address = 09h) [Reset = 00h]**

Sensor\_Config\_4 is used to configure GAIN\_CONFIG and X\_THR\_HI via Gain\_X\_THR\_HI[7:0].

Return to [Register Map](#)

**Figure 7-10. Sensor\_Config\_4 Register**

7	6	5	4	3	2	1	0
Gain_X_THR_HI[7:0]							
R/W-00h							

**Table 7-12. Sensor\_Config\_4 Register Field Descriptions**

Bit	Field	Type	Reset	Description
7-0	Gain_X_THR_HI[7:0]	R/W	0h	Configuration functionality is based on THR_SEL[1:0] bits: If THR_SEL[1:0] = 0h, 1h, or 3h, then Gain_X_THR_HI[7:0] = Gain_Config (Adjusts gain of a selected magnetic channel). Unsigned 8-bit value with an LSB size of 0.00390625 used as a direct multiplier to the measured magnetic field with a value between 0 and 1. If THR_SEL[1:0] = 2h and ANGLE_EN = 0h, then Gain_X_THR_HI[7:0] = X_THR_HI (High threshold for X channel). Gain_X_THR_HI[6:0] create a positive magnetic high threshold for the X channel (Gain_X_THR_HI[7] is ignored).

**7.1.11 Sensor\_Config\_5 Register (Address = 0Ah) [Reset = 00h]**

Sensor\_Config\_5 is used to configure Offset\_Config\_1, Y\_THR\_HI via Offset1\_Y\_THR\_HI[7:0].

Return to [Register Map](#)

**Figure 7-11. Sensor\_Config\_5 Register**

7	6	5	4	3	2	1	0
Offset1_Y_THR_HI[7:0]							
R/W-00h							

**Table 7-13. Sensor\_Config\_5 Register Field Descriptions**

Bit	Field	Type	Reset	Description
7-0	Offset1_Y_THR_HI[7:0]	R/W	00h	<p>Configuration functionality and LSB is based on THR_SEL[1:0] and ANGLE_EN[1:0]:</p> <p>If ANGLE_EN[1:0] ≠ 0h then Offset1_Y_THR_HI[7:0] = Offset_Config_1[7:0] (Adjusts offset of first magnetic channel measured). Offset correction is stored as an 8-bit 2's complement value with LSB size specific to each magnetic range:</p> <ul style="list-style-type: none"> <li>• 40mT: 51.2LSB/mT</li> <li>• 80mT: 25.6LSB/mT</li> <li>• 120mT: 15.3985LSB/mT</li> <li>• 240mT: 7.70LSB/mT</li> </ul> <p>If THR_SEL[1:0] = 2h and ANGLE_EN = 0h, then Offset1_Y_THR_HI[7:0] = Y_THR_HI[7:0] (High threshold for Y channel). Offset1_Y_THR_HI[6:0] create a positive magnetic high threshold for the Y channel (Offset1_Y_THR_HI[7] is ignored).</p>

### 7.1.12 Sensor\_Config\_6 Register (Address = 0Bh) [Reset = 00h]

Sensor\_Config\_6 is used to configure Offset\_Config\_2, Z\_THR\_HI via Offset2\_Z\_THR\_HI[7:0].

Return to [Register Map](#)

**Figure 7-12. Sensor\_Config\_6 Register**

7	6	5	4	3	2	1	0
Offset2_Z_THR_HI[7:0]							
R/W-00h							

**Table 7-14. Sensor\_Config\_6 Register Field Descriptions**

Bit	Field	Type	Reset	Description
7-0	Offset2_Z_THR_HI[7:0]	R/W	0h	<p>Threshold configuration functionality is set based on THR_SEL[1:0] and ANGLE_EN[1:0]:</p> <p>If ANGLE_EN[1:0] ≠ 0h, then Offset2_Z_THR_HI[7:0] = Offset_Config_2[7:0] (adjusts offset of a second magnetic channel). Offset correction is stored as an 8-bit 2's complement value with LSB size specific to each magnetic range:</p> <ul style="list-style-type: none"> <li>40mT: 51.2LSB/mT</li> <li>80mT: 25.6LSB/mT</li> <li>120mT: 15.3985LSB/mT</li> <li>240mT: 7.70LSB/mT</li> </ul> <p>If THR_SEL[1:0] = 2h and ANGLE_EN[1:0] = 0h then Offset2_Z_THR_HI[7:0] = Z_THR_HI[7:0] (High threshold for Z channel). Offset2_Z_THR_HI[6:0] create a positive magnetic high threshold for the Z channel (Offset2_Z_THR_HI[7] is ignored).</p>

### 7.1.13 I2C\_Address Register (Address = 0Ch) [Reset = 00h]

This register can be used to configure the I2C Address for TMAG3001.

Return to [Register Map](#)

**Figure 7-13. I2C\_Address Register**

7	6	5	4	3	2	1	0
I2C_Address[6:0]							I2C_Address_Update_EN
R/W-00h							R/W-0h

**Table 7-15. I2C\_Address Register Field Descriptions**

Bit	Field	Type	Reset	Description
7-1	I2C_Address[6:0]	R/W	0h	7-bit device address based on the ADDR pin connection. User can change this address to assign a new address if needed.
0	I2C_Address_Update_EN	R/W	0h	0h = Use ADDR pin configuration for target address 1h = Use I2C_Address[6:0] for target address

### 7.1.14 Device\_ID Register (Address = 0Dh) [Reset = 0xh]

This register contains the Device version.

Return to [Register Map](#)

**Figure 7-14. Device\_ID Register**

7	6	5	4	3	2	1	0
Reserved				Version[1:0]		Reserved	
R-0h				R-xh		R-0h	

**Table 7-16. Device\_ID Register Field Descriptions**

Bit	Field	Type	Reset	Description
7-4	Reserved	R	0h	Reserved
3-2	Version[1:0]	R	xh	Device Version 0h = TMAG3001 ±40 mT 2h = TMAG3001 ±120mT
1-0	Reserved	R	0h	Reserved

### 7.1.15 Manufacturer\_ID\_LSB Register (Address = 0Eh) [Reset = 49h]

This register contains the LSB of Manufacturer\_ID[15:0].

Return to [Register Map](#)

**Figure 7-15. Manufacturer\_ID\_LSB Register**

7	6	5	4	3	2	1	0
Manufacturer_ID[7:0]							
R-49h							

**Table 7-17. Manufacturer\_ID\_LSB Register Field Descriptions**

Bit	Field	Type	Reset	Description
7-0	Manufacturer_ID[7:0]	R	49h	LSB of Manufacturer_ID[15:0]

### 7.1.16 Manufacturer\_ID\_MSB Register (Address = 0Fh) [Reset = 54h]

This register contains the MSB of Manufacturer\_ID[15:0].

Return to [Register Map](#)

**Figure 7-16. Manufacturer\_ID\_MSB Register**

7	6	5	4	3	2	1	0
Manufacturer_ID[15:8]							
R-54h							

**Table 7-18. Manufacturer\_ID\_MSB Register Field Descriptions**

Bit	Field	Type	Reset	Description
7-0	Manufacturer_ID[15:8]	R	54h	MSB of Manufacturer_ID[15:0]

### 7.1.17 Temp\_Result\_MSB Register (Address = 10h) [Reset = 00h]

This register is an 8-bit, read-only register that stores the MSB output of the most recent temperature conversion. Data is represented in binary 2's complement format. [Temperature Sensor Data](#) shows how to convert the Temp\_Result[15:0] to temperature.

Return to [Register Map](#)

**Figure 7-17. Temp\_Result\_MSB Register**

7	6	5	4	3	2	1	0
Temp_Result[15:8]							
R-00h							

**Table 7-19. Temp\_Result\_MSB Register Field Descriptions**

Bit	Field	Type	Reset	Description
7-0	Temp_Result[15:8]	R	00h	8-bit MSB of Temperature data conversion results.

### 7.1.18 Temp\_Result\_LSB Register (Address = 11h) [Reset = 00h]

This register is an 8-bit, read-only register that stores the LSB output of the most recent temperature conversion. Data is represented in binary 2's complement format. [Temperature Sensor Data](#) shows how to convert the Temp\_Result[15:0] to temperature.

Return to [Register Map](#)

**Figure 7-18. Temp\_Result\_LSB Register**

7	6	5	4	3	2	1	0
Temp_Result[7:0]							
R-00h							

**Table 7-20. Temp\_Result\_LSB Register Field Descriptions**

Bit	Field	Type	Reset	Description
7-0	Temp_Result[7:0]	R	00h	8-bit LSB of Temperature data conversion results.

### 7.1.19 X\_Result\_MSB Register (Address = 12h) [Reset = 00h]

This register is an 8-bit, read-only register that stores the MSB output of the most recent X-channel conversion. Data is represented in binary 2's complement format.

Return to [Register Map](#)

**Figure 7-19. X\_Result\_MSB Register**

7	6	5	4	3	2	1	0
X_Result[15:8]							
R-00h							

**Table 7-21. X\_Result\_MSB Register Field Descriptions**

Bit	Field	Type	Reset	Description
7-0	X_Result[15:8]	R	00h	8-bit MSB of X-Channel data conversion results

### 7.1.20 X\_Result\_LSB Register (Address = 13h) [Reset = 00h]

This register is an 8-bit, read-only register that stores the LSB output of the most recent X-channel conversion. Data is represented in binary 2's complement format.

Return to [Register Map](#)

**Figure 7-20. X\_Result\_LSB Register**

7	6	5	4	3	2	1	0
X_Result[7:0]							
R-00h							

**Table 7-22. X\_Result\_LSB Register Field Descriptions**

Bit	Field	Type	Reset	Description
7-0	X_Result [7:0]	R	00h	8-bit LSB of X-Channel data conversion results

### 7.1.21 Y\_Result\_MSB Register (Address = 14h) [Reset = 00h]

This register is an 8-bit, read-only register that stores the MSB output of the most recent Y-channel conversion. Data is represented in binary 2's complement format.

Return to [Register Map](#)

**Figure 7-21. Y\_Result\_MSB Register**

7	6	5	4	3	2	1	0
Y_Result[15:8]							
R-00h							

**Table 7-23. Y\_Result\_MSB Register Field Descriptions**

Bit	Field	Type	Reset	Description
7-0	Y_Result[15:8]	R	00h	8-bit MSB of Y-Channel data conversion results

### 7.1.22 Y\_Result\_LSB Register (Address = 15h) [Reset = 00h]

This register is an 8-bit, read-only register that stores the LSB output of the most recent Y-channel conversion. Data is represented in binary 2's complement format.

Return to [Register Map](#)

**Figure 7-22. Y\_Result\_LSB Register**

7	6	5	4	3	2	1	0
Y_Result[7:0]							
R-00h							

**Table 7-24. Y\_Result\_LSB Register Field Descriptions**

Bit	Field	Type	Reset	Description
7-0	Y_Result[7:0]	R	00h	8-bit LSB of Y-Channel data conversion results

### 7.1.23 Z\_Result\_MSB Register (Address = 16h) [Reset = 00h]

This register is an 8-bit, read-only register that stores the MSB output of the most recent Z-channel conversion. Data is represented in binary 2's complement format.

Return to [Register Map](#)

**Figure 7-23. Z\_Result\_MSB Register**

7	6	5	4	3	2	1	0
Z_Result[15:8]							
R-00h							

**Table 7-25. Z\_Result\_MSB Register Field Descriptions**

Bit	Field	Type	Reset	Description
7-0	Z_Result[15:8]	R	00h	8-bit MSB of Z-Channel data conversion results

### 7.1.24 Z\_Result\_LSB Register (Address = 17h) [Reset = 00h]

This register is an 8-bit, read-only register that stores the LSB output of the most recent Z-channel conversion. Data is represented in binary 2's complement format.

Return to [Register Map](#)

**Figure 7-24. Z\_Result\_LSB Register**

7	6	5	4	3	2	1	0
Z_Result[7:0]							
R-00h							

**Table 7-26. Z\_RESULT\_LSB Register Field Descriptions**

Bit	Field	Type	Reset	Description
7-0	Z_Result[7:0]	R	00h	8-bit LSB of Z-Channel data conversion results



### 7.1.25 Conv\_Status Register (Address = 18h) [Reset = 00h]

This register contains the conversion status information.

Return to [Register Map](#)

**Figure 7-25. Conv\_Status Register**

7	6	5	4	3	2	1	0
Set_Count[2:0]			POR	Reserved		Diag_Status	Result_Status
R-0h			R/W1C-0h	R-0h		R-0h	R-0h

**Table 7-27. Conv\_Status Register Field Descriptions**

Bit	Field	Type	Reset	Description
7-5	Set_Count[2:0]	R	0h	Rolling Count of Conversion Data Sets
4	POR	R/W1C	0h	Device powered up, or experienced power-on-reset. Bit is clear when host writes back 1. 0h = No POR has occurred 1h = POR occurred
3-2	Reserved	R	0h	Reserved
1	Diag_Status	R	0h	Detect any internal diagnostics fail which include Internal Memory CRC error, INT pin error 0h = No diagnostic fail 1h = Diagnostic fail detected
0	Result_Status	R	0h	Conversion data result is ready to be read 0h = Conversion Data not complete 1h = Conversion Data complete

### 7.1.26 Angle\_Result\_MSB Register (Address = 19h) [Reset = 00h]

This register is an 8-bit, read-only register that stores the MSB output of the most recent Angle conversion. Angle\_Result[12:0] data is represented in binary 2's complement format with a LSB size of 0.0625°.

Return to [Register Map](#)

**Figure 7-26. Angle\_Result\_MSB Register**

7	6	5	4	3	2	1	0
Reserved				Angle_Result[12:8]			
R-0h				R-00h			

**Table 7-28. Angle\_Result\_MSB Register Field Descriptions**

Bit	Field	Type	Reset	Description
7-5	Reserved	R	0h	Reserved
4-0	Angle_Result[12:8]	R	00h	5-bit MSB of Angle data conversion results

### 7.1.27 Angle\_Result\_LSB Register (Address = 1Ah) [Reset = 00h]

This register is an 8-bit, read-only register that stores the LSB output of the most recent Angle conversion. Angle\_Result[12:0] data is represented in binary 2's complement format with a LSB size of 0.0625°.

Return to [Register Map](#)

**Figure 7-27. Angle\_Result\_LSB Register**

7	6	5	4	3	2	1	0
Angle_Result[7:0]							
R-00h							

**Table 7-29. Angle\_Result\_LSB Register Field Descriptions**

Bit	Field	Type	Reset	Description
7-0	Angle_Result[7:0]	R	00h	8-bit LSB of Angle data conversion results

### 7.1.28 Magnitude\_Result Register (Address = 1Bh) [Reset = 00h]

This register is an 8-bit, read-only register that stores the output of the most recent Magnitude conversion. Data is represented in binary 2's complement format.

Return to [Register Map](#)

**Figure 7-28. Magnitude\_Result\_Register**

7	6	5	4	3	2	1	0
Magnitude_Result[7:0]							
R-00h							

**Table 7-30. Magnitude\_Result Register Field Descriptions**

Bit	Field	Type	Reset	Description
7-0	Magnitude_Result[7:0]	R	00h	Resultant vector magnitude (during angle measurement) result. This value is constant during 360 degree measurements

### 7.1.29 Device\_Status Register (Address = 1Ch) [Reset = 00h]

This register contains the device status information.

Return to [Register Map](#)

**Figure 7-29. Device\_Status Register**

7	6	5	4	3	2	1	0
Reserved		$\overline{\text{INT\_RB}}$		Reserved	INT_ER	OTP_CRC_ER	THR_Cross
R-0h		R-0h		R-0h	R/W1CP-0h	R/W1CP-0h	R-0h

**Table 7-31. Device\_Status Register Field Descriptions**

Bit	Field	Type	Reset	Description
7-5	Reserved	R	0h	Reserved
4	$\overline{\text{INT\_RB}}$	R	0h	Indicates the level that the device is reading back from $\overline{\text{INT}}$ pin. 0h = $\overline{\text{INT}}$ pin driven low 1h = $\overline{\text{INT}}$ pin status high
3	Reserved	R	0h	Reserved
2	INT_ER	R/W1CP	0h	Indicates if $\overline{\text{INT}}$ pin error is detected. Bit is clear when host writes 1h. 0h = No $\overline{\text{INT}}$ Error detected 1h = $\overline{\text{INT}}$ Error detected
1	OTP_CRC_ER	R/W1CP	0h	Indicates if OTP CRC error is detected. Bit is clear when host writes 1h. 0h = No OTP CRC Error detected 1h = OTP CRC Error detected
0	THR_Cross	R	0h	When a threshold crossing is detected, this bit is set. 0h = No threshold crossing detected 1h = Threshold Crossing detected

## 8 Application and Implementation

---

### Note

Information in the following applications sections is not part of the TI component specification, and TI does not warrant its accuracy or completeness. TI's customers are responsible for determining suitability of components for their purposes, as well as validating and testing their design implementation to confirm system functionality.

---

### 8.1 Application Information

#### 8.1.1 Select the Sensitivity Option

The TMAG3001 comes in two sensitivity options A1 and A2. Select the highest TMAG3001 sensitivity option that can measure the required range of magnetic flux density so that the ADC input range is maximized.

Larger-sized magnets and farther sensing distances can generally enable better positional accuracy than very small magnets at close distances, because magnetic flux density increases exponentially with the proximity to a magnet.

#### 8.1.2 Temperature Compensation for Magnets

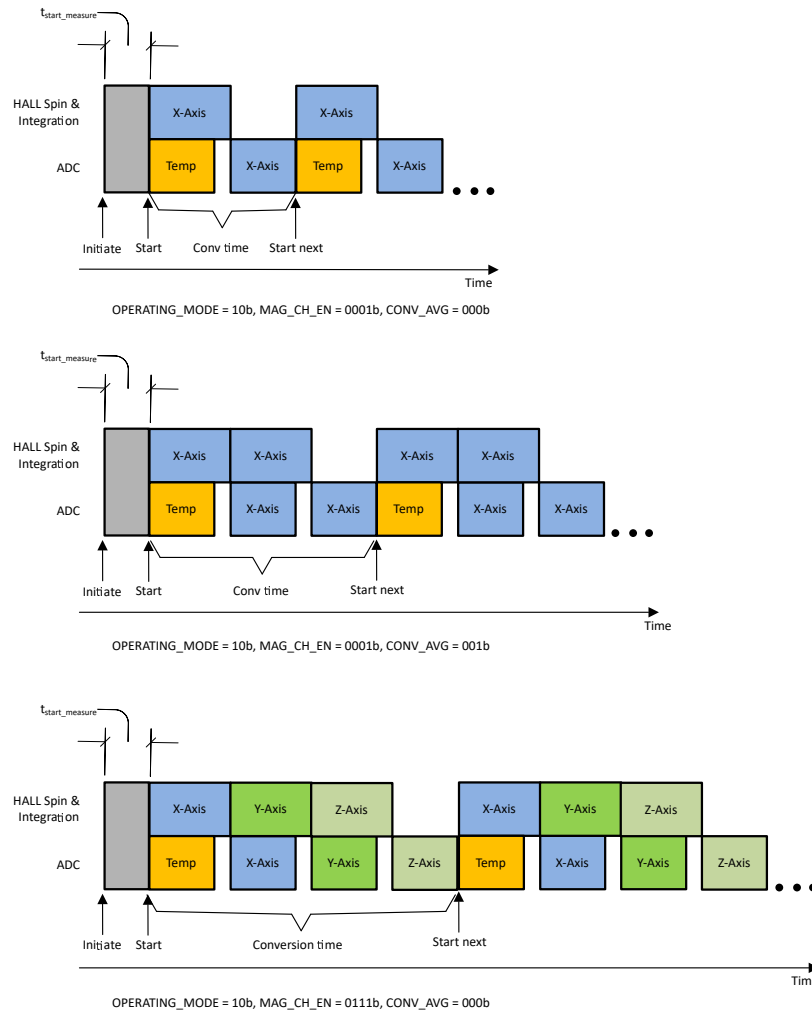
The TMAG3001 temperature compensation is designed to directly compensate the average temperature drift of several magnets as specified in the [MAG\\_TEMPCO](#) register bits. The residual induction ( $B_r$ ) of a magnet typically reduces by 0.12%/°C for NdFeB, and 0.20%/°C for ferrite magnets as the temperature increases. Set the [MAG\\_TEMPCO](#) bit to default 00b if the device temperature compensation is not needed.

### 8.1.3 Sensor Conversion

Multiple conversion schemes can be adopted based off the `MAG_CH_EN` and `CONV_AVG` register bits settings.

#### 8.1.3.1 Continuous Conversion

The TMAG3001 can be set in continuous conversion mode when `Operating_Mode[1:0]` is set to 2h. Figure 8-1 shows few examples of continuous conversion. The input magnetic field is processed in two steps. In the first step the device spins the hall sensor elements, and integrates the sampled data. In the second step the ADC block converts the analog signal into digital bits and stores in the corresponding result register. While the ADC starts processing the first magnetic sample, the spin block can start processing another magnetic sample. In this mode the temperature data is taken at the beginning of each new conversion. This temperature data is used to compensate for the magnetic thermal drift.



**Figure 8-1. Continuous Conversion Examples**

### 8.1.3.2 Trigger Conversion

The TMAG3001 supports trigger conversion with `Operating_Mode[1:0]` set to 0h. The trigger event can be initiated through I<sup>2</sup>C command or INT signal. Figure 8-2 shows an example of trigger conversion with temperature, X, Y, and Z sensors activated.

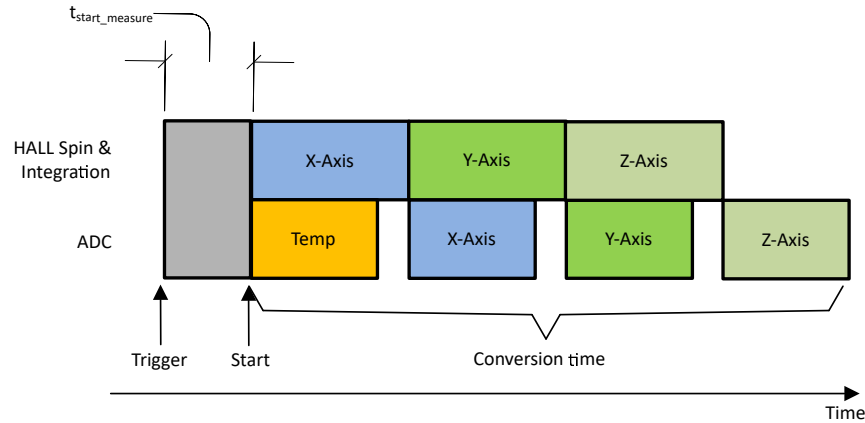


Figure 8-2. Trigger Conversion for Temperature, X, Y, and Z Sensors

### 8.1.3.3 Pseudo-Simultaneous Sampling

In absolute angle measurement, application sensor data from multiple axes are required to calculate an accurate angle. The magnetic field data collected at different times through the same signal chain introduces error in angle calculation. The TMAG3001 offers pseudo-simultaneous sampling data collection modes to eliminate this error. Figure 8-3 shows an example where `MAG_CH_EN` is set at Bh to collect XZX data. Equation 12 shows that the time stamps for the X and Z sensor data are the same.

$$t_z = \frac{t_{X1} + t_{X2}}{2} \tag{12}$$

where

- $t_{X1}$ ,  $t_z$ ,  $t_{X2}$  are time stamps for X, Z, X sensor data completion as defined in Figure 8-3.

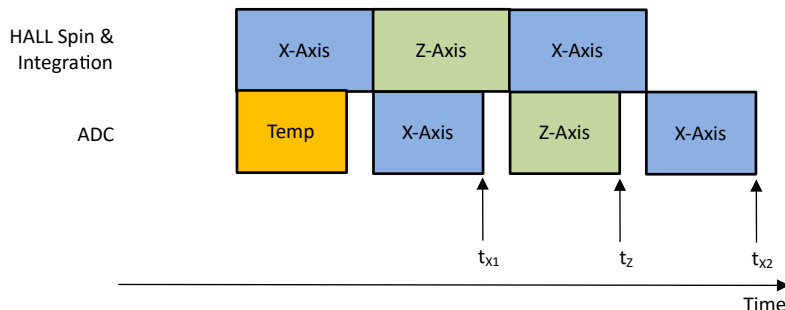


Figure 8-3. XZX Magnetic Field Conversion

The vertical X, Y sensors of the TMAG3001 exhibit more noise than the horizontal Z sensor. The pseudo-simultaneous sampling can be used to equalize the noise floor when two set of vertical sensor data are collected against one set of horizontal sensor data, as in examples of XZX or YZY modes.

### 8.1.4 Magnetic Limit Check

The TMAG3001 enables magnetic limit checks for single or multiple axes at the same time. The device can be configured to be sensitive for X, Y and Z magnetic axes thresholds when THR\_SEL[1:0] is set to 2h.

**Table 8-1. Register Configuration for Magnetic Limit Check When THR\_SEL[1:0] = 1h**

REGISTER NAME	REGISTER ALIAS WHEN THR_SEL[1:0] = 1h	DESCRIPTION
THR_Config_1	X_THR_LO	Sets the lower threshold limit for X channel
THR_Config_2	Y_THR_LO	Sets the lower threshold limit for Y channel
THR_Config_3	Z_THR_LO	Sets the lower threshold limit for Z channel

**Table 8-2. Register Configuration for Magnetic Limit Check When THR\_SEL[1:0] = 2h and Angle\_EN[1:0] = 0h**

REGISTER NAME	REGISTER ALIAS WHEN THR_SEL[1:0] = 2h AND Angle_EN[1:0] = 0h	DESCRIPTION
Sensor_Config_4	X_THR_HI	Sets the upper threshold limit for X channel
Sensor_Config_5	Y_THR_HI	Sets the upper threshold limit for Y channel
Sensor_Config_6	Z_THR_HI	Sets the upper threshold limit for Z channel

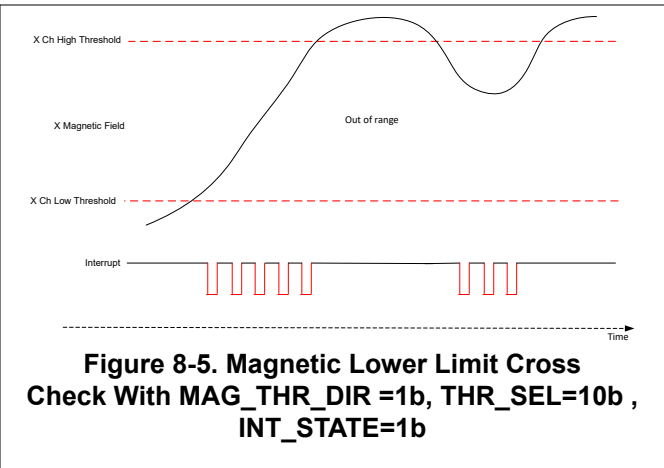
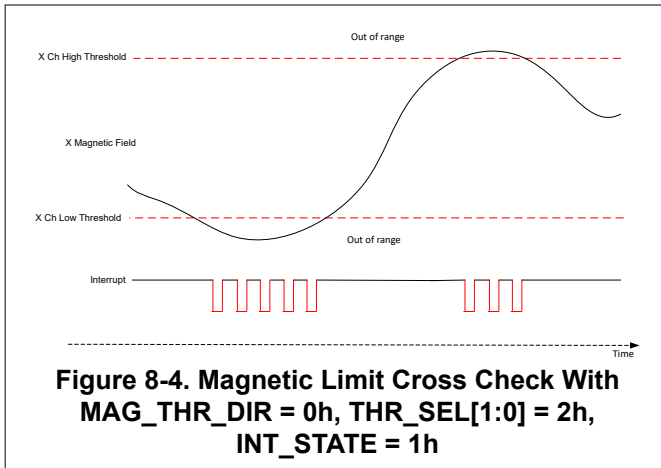
The magnetic higher and lower thresholds are unsigned 7-bit values. x\_THR\_LO[6:0] and x\_THR\_HI[6:0] set positive magnetic thresholds while x\_THR\_LO[7] and x\_THR\_HI[7] are ignored, resulting in the possible range of threshold entries of 1 to 128. Both the higher and lower threshold limits can be enabled independently. No threshold comparison is done if the thresholds are set to 0h. The lower threshold for X channel can be calculated using [Equation 13](#).

$$\text{Threshold (mT)} = \frac{\text{THR\_CONFIG\_1}[6:0] \times 256}{\text{SENS}} \quad (13)$$

For example, for the A1 device version, the default magnetic range is ±37mT with a sensitivity of 885 LSB/mT. If X\_Y\_RANGE=0 and THR\_SEL= 10b, for a threshold configuration of 0000111b in THR\_CONFIG\_1, the X channel lower threshold is given by

$$\text{X Low Threshold (mT)} = \frac{7 \times 256}{885} = 2.025 \text{ mT} \quad (14)$$

[Figure 8-5](#) and [Figure 8-5](#) show examples of magnetic limit cross detection events while the field going above, below, exiting a magnetic band, and entering a magnetic band. The device keeps generating an interrupt with each new conversion if the magnetic fields remain in the shaded regions in the figures. The MAG\_THR\_DIR register bit helps select the out of range regions for threshold crossings. The magnetic limit check can be performed in standby, continuous or wake and sleep operating modes.



### 8.1.5 Magnitude Limit Check

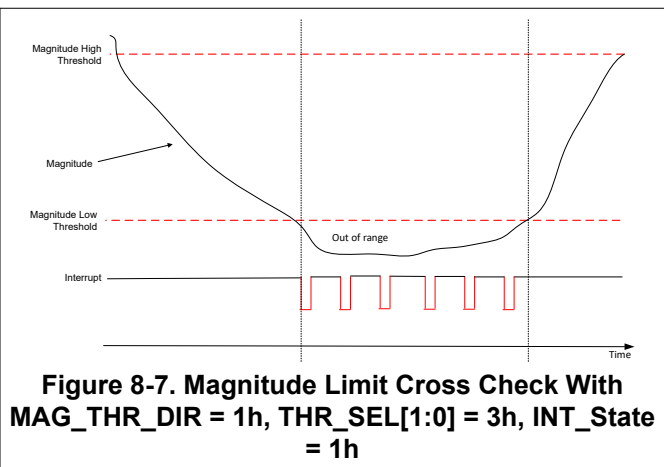
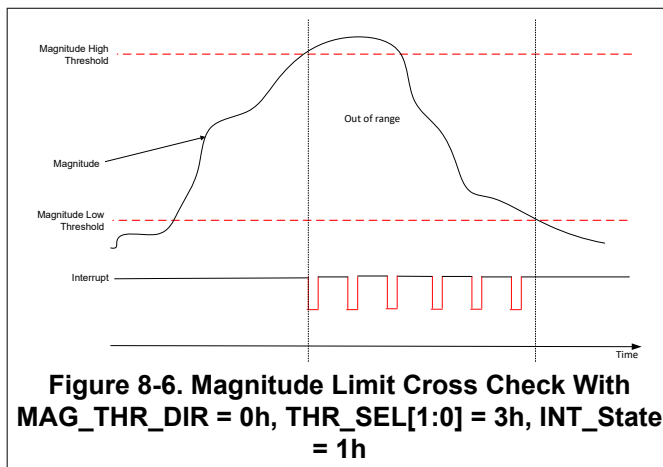
The TMAG3001 enables magnitude limit checks when the part is configured to calculate an angle using ANGLE\_EN. The magnitude of the absolute magnetic field is stored in the Magnitude\_Result register. The device can be configured to be configured for magnitude threshold checks when THR\_SEL[1:0] is set to 3h. Table 8-3 shows the configuration of registers to enable magnetic limit checks.

**Table 8-3. Register Configuration for Magnitude Limit Check**

REGISTER NAME	REGISTER ALIAS WHEN THR_SEL[1:0] = 3h	DESCRIPTION
THR_Config_1	M_THR_LO	Sets the lower threshold limit for magnitude check
THR_Config_2	M_THR_HI	Sets the higher threshold limit for the magnitude check

The magnitude higher and lower thresholds are 8-bit numbers, with the possible range of threshold entries from 0 to 255. Both the higher and lower threshold limits can be enabled independently. No threshold comparison is done if the thresholds are set to 0h.

Figure 8-7 and Figure 8-6 show examples of magnitude limit cross detection events while the field going above, below, exiting a magnetic band, and entering a magnetic band. The device keeps generating an interrupt with each new conversion if the magnetic fields remain in the shaded regions in the figures. The MAG\_THR\_DIR register bit helps select the out of range regions for threshold crossings. The magnitude limit check can be performed in standby, continuous or wake and sleep operating modes.





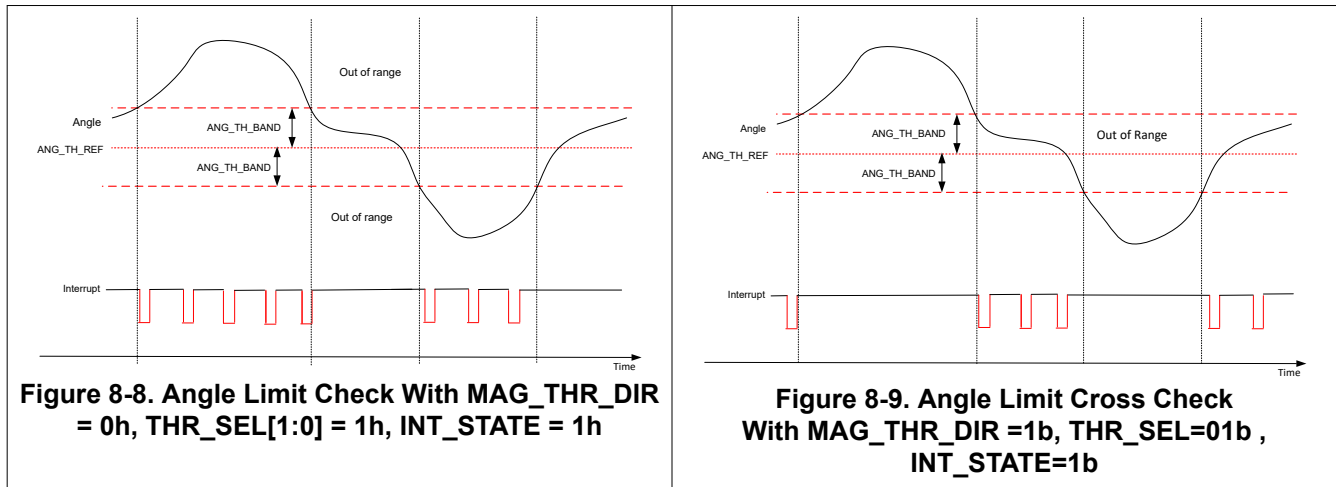
### 8.1.6 Angle Limit Check

The TMAG3001 features an integrated angle calculation so the device can be used as an angle switch for any two axes set by [ANGLE\\_EN](#). The device can be configured to be sensitive for angle thresholds when THR\_SEL[1:0] is set to 1h. When THR\_SEL[1:0] is set to 1h, the THR\_Config\_1 register acts as A\_THR\_REF and THR\_Config\_2 acts as A\_THR\_BAND. The Angle limit checks can be configured using the angle threshold reference set by A\_THR\_REF and the threshold band set by the A\_THR\_BAND. The reference angle threshold, A\_THR\_REF is absolute angle coded on 8 bits (as shown in the following table), with a resolution of 2 degrees per LSB and a maximum range of 360 degrees. A\_THR\_BAND is also absolute angle coded on 8 bits and has a resolution of 1 degree per LSB, with a maximum range of up to 180 degrees.

**Table 8-4. Register Configuration for Angle Limit Check**

REGISTER NAME	REGISTER ALIAS WHEN THR_SEL[1:0] = 1h	DESCRIPTION
THR_Config_1	A_THR_REF	Sets the angle threshold reference
THR_Config_2	A_THR_BAND	Sets the threshold region around the reference
THR_Config_3	Angle_Offset[7:0]	Sets the user defined angle offset

Figure 8-8 and Figure 8-9 show examples of angle limit cross detection events while the measured angle goes above or below, exiting an angle band, and entering an angle band. The device keeps generating an interrupt with each new conversion if the measured angle remains in the shaded regions in the figures. The MAG\_THR\_DIR register bit helps select the out of range regions for threshold crossings.

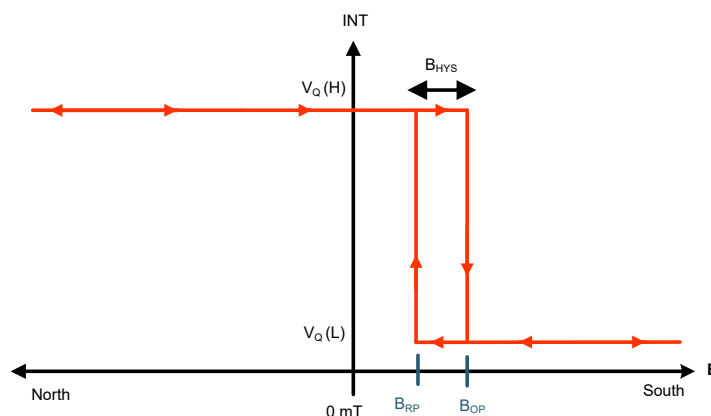


### 8.1.7 Switch Mode

The TMAG3001 supports flexible and configurable switch mode option on the  $\overline{\text{INT}}$  pin. In this mode, the output pin is set to a level based output when a threshold crossing is detected. The device can be configured to be in switch mode in standby, active and wake-up and sleep power modes. If the device is configured in switch mode,  $\overline{\text{INT}}$  pin cannot be used to trigger the conversions or be used as an output for any other purposes. The device supports unipolar and omnipolar switch mode options based on the configured thresholds. With the ability to set both upper and lower thresholds, TMAG3001 is also used for tamper detection where excessive magnetic fields need to be detected. With the ability to calculate angle across any two axes, the device has the ability to also be configured as an angle switch.

### 8.1.7.1 Unipolar Switch Mode

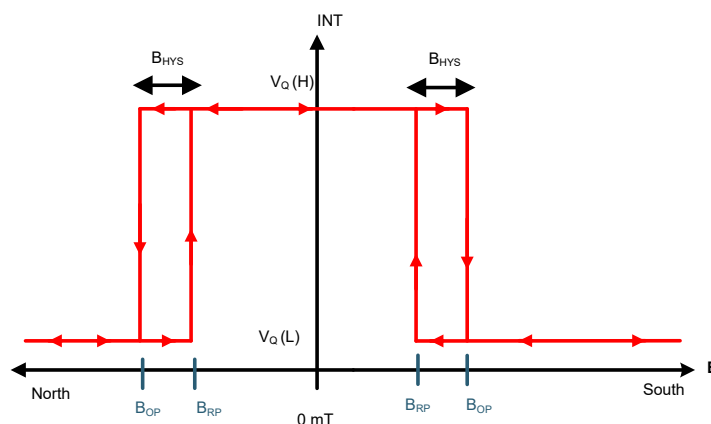
The TMAG3001 is sensitive to both positive and negative magnetic fields. The device can be configured to act as a switch that is sensitive to a single direction on any of the three axes. Figure 8-10 shows an example for unipolar switch mode where the  $B_{OP}$  represents the operating point for the switch above which the  $\overline{INT}$  pin switches to ON state.  $B_{RP}$  represents the reverse operating point, below which the  $\overline{INT}$  pin returns to the OFF operating state. TMAG3001 enables the device to be used as a 3D magnetic switch when all the magnetic channels are enabled and when  $THR\_SEL[1:0]$  bits are set to 2h. When used as a 3D magnetic switch,  $\overline{INT}$  pin switches to ON state, if one of the magnetic channels crosses the operating point, set by the low thresholds that can be configured in  $THR\_Config\_1$ ,  $THR\_Config\_2$  and  $THR\_Config\_3$ . In unipolar switch mode, the thresholds are treated as an 8-bit signed magnitude integer, where  $THR\_Config\_x[7]$  represents the sign (0 for positive, 1 for negative) and  $THR\_Config\_x[6:0]$  represent the magnitude of the threshold. The hysteresis for the switch mode is set using the  $THR\_HYST$  bits. The switch turns to an off position only if the measurements of all the enabled magnetic channels fall below the reverse operating point,  $B_{RP}$ .



**Figure 8-10. Unipolar 3D Magnetic Switch**

### 8.1.7.2 Omnipolar Switch Mode

Figure 8-11 shows an example for the omnipolar switch mode where the device is sensitive to either the positive or negative thresholds. The omnipolar switch mode is particularly useful in cases where the magnet polarity is not controlled during the manufacturing process. In this mode, the same thresholds are used for both the polarities.  $B_{OP}$  represents the operating point for the switch above which the  $\overline{INT}$  pin switches states.  $B_{RP}$  represents the reverse operating point, below which the  $\overline{INT}$  pin returns to the previous operating state. This mode is similar to unipolar switch mode.



**Figure 8-11. Omnipolar Switch Mode**

### 8.1.7.3 Tamper Detection

The TMAG3001 features both the high and low thresholds for individual axes. The device can be used to detect higher than expected magnetic fields by configuring the corresponding high thresholds for X, Y and Z axes. When THR\_SEL[1:0] bits are set 2h, the Sensor\_Config\_4, Sensor\_Config\_5, Sensor\_Config\_6 registers are used to set the higher thresholds ( $B_{TAMPER}$ ) for X, Y and Z axes respectively.

When the device is configured in switch mode, the higher thresholds must be set in the same polarity. The TMAG3001 can be used to detect high magnetic fields on all three axes when all the magnetic channels are enabled. Figure 8-12 shows the unipolar switch mode with higher thresholds configured for the magnetic channels. Figure 8-13 shows the tamper detection feature when the device is configured in the omnipolar switch mode. In the omnipolar switch mode, the sign bit for the thresholds are ignored.

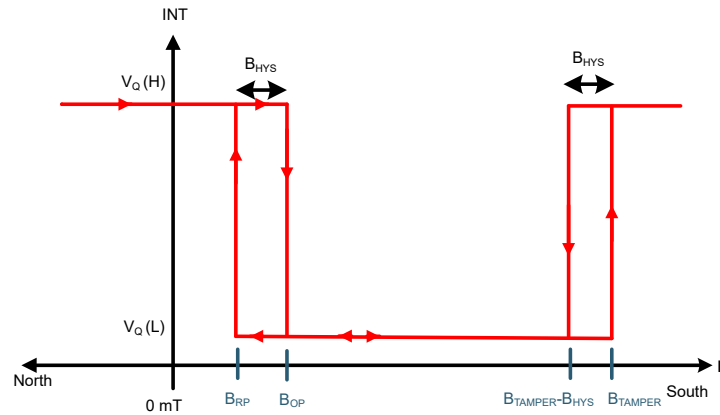


Figure 8-12. Unipolar Switch Mode Showing Tamper Detection

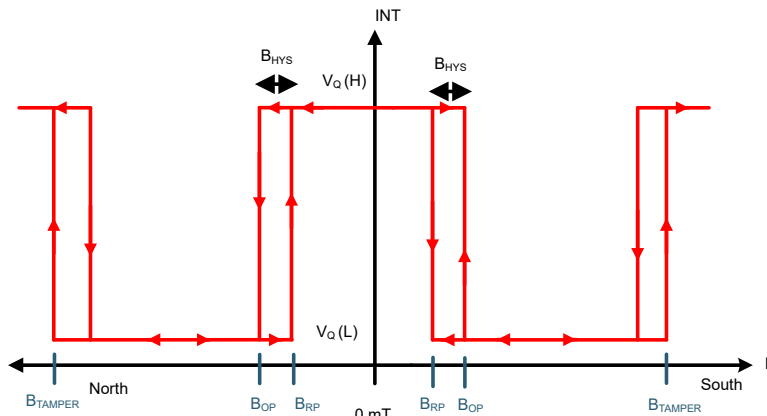


Figure 8-13. Omnipolar Switch Mode Showing Tamper Detection

### 8.1.7.4 Angle Switch

The TMAG3001 features an integrated angle calculation so the device can be used as an angle switch for any two axes set by ANGLE\_EN. The device is configured as an angle switch, when INT\_Mode[2:0] is set to 5h. The THR\_Config\_1 register acts as A\_TH\_REF, that sets the reference threshold for the angle crossing. The THR\_Config\_2 register acts as A\_TH\_BAND, that determines the threshold region for the angle crossing detection. Figure 8-14 shows the response of the device where the switch output is set to ON state and when the measured angle is above the  $\theta_{TH\_REF} + \theta_{TH\_BAND}$  or below  $\theta_{TH\_REF} - \theta_{TH\_BAND}$ . The switch output is set to OFF state if the switch output crosses below the hysteresis value set by  $\theta_{ANG\_HYS}$ . Figure 8-15 shows the response of the device, based on the configured thresholds and hysteresis.

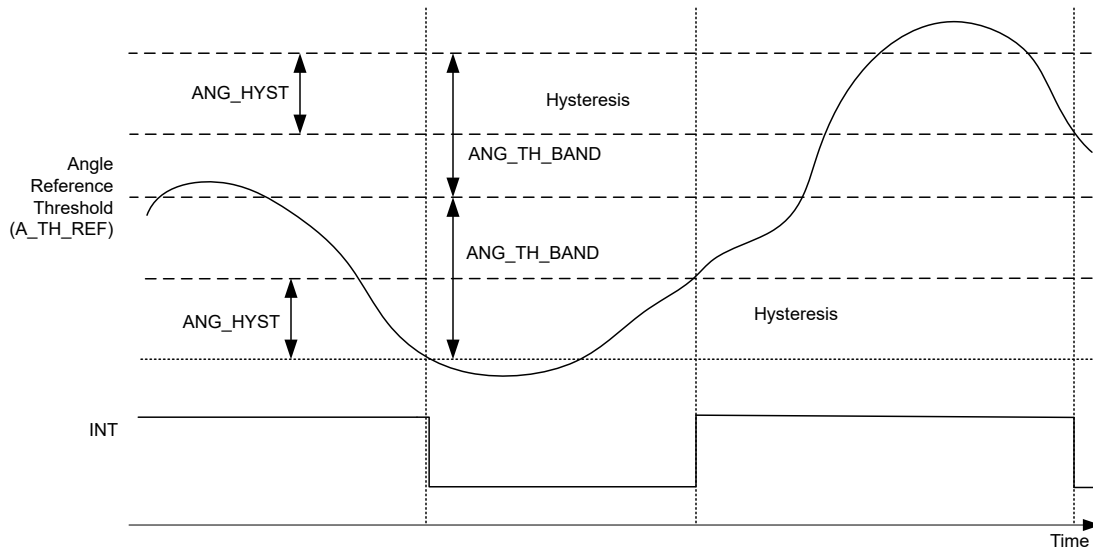


Figure 8-14. Timing Diagram Showing the Angle Switch Operation, THR\_SEL[1:0] = 1h, INT\_Mode[2:0] = 5h

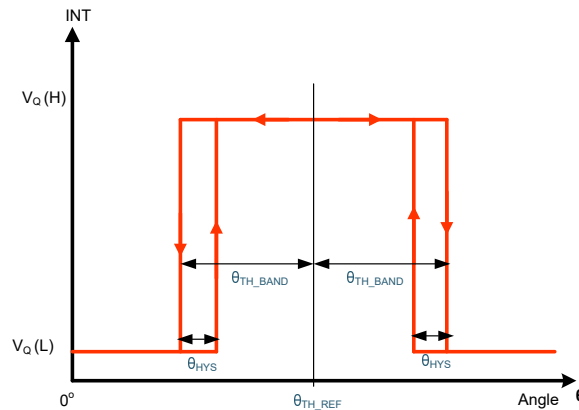


Figure 8-15. Angle Switch

### 8.1.7.5 Magnitude Switch (Button Press Detection)

The TMAG3001 features an integrated CORDIC that enables to calculate the absolute magnitude of the two fields as set by ANGLE\_EN. For angle applications, where the magnet is placed on top of the sensor, a button press event can be detected only by using the absolute magnetic field as given by the Magnitude\_Result register. The magnitude varies exponentially with respect to the airgap between the magnet and the sensor and hence during a button press event, the magnitude of the magnetic field goes higher. The device can be configured to be sensitive for magnitude thresholds when THR\_SEL[1:0] is set to 3h. The device is configured as a magnitude switch, when INT\_Mode[2:0] is set to 5h. The magnitude of the magnetic field is always positive, therefore the device does not support the magnitude switch mode, when the INT\_Mode[2:0] is set to 6h (omnipolar mode). Figure 8-17 shows the response of the device, where the switch output is set to ON state, when the measured angle is above the MAG\_HI and the switch output is set to OFF state, when the measured magnitude is below MAG\_LO, the low threshold. The lower threshold for the magnitude, |BMAG,LO| is configured using the THR\_Config\_1 register and the higher threshold for the magnitude, |BMAG,HI| is configured using the THR\_Config\_2 register.

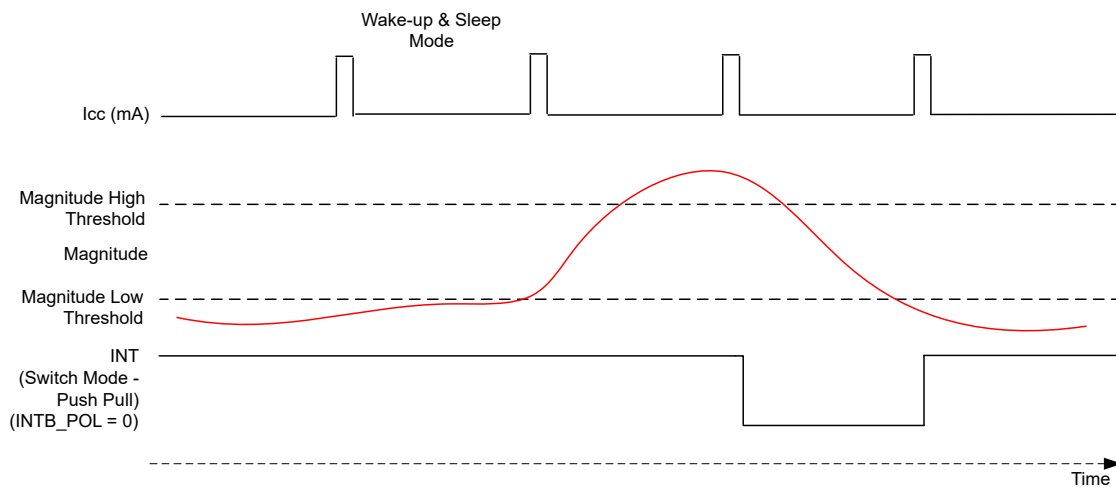


Figure 8-16. Timing Diagram Showing the Magnitude Switch Operation, THR\_SEL[1:0] = 3h, INT\_Mode[2:0] = 5h

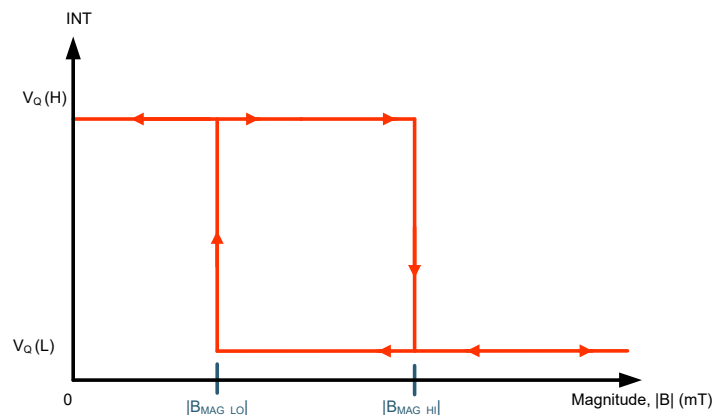


Figure 8-17. Magnitude Switch

### 8.1.8 Error Calculation During Linear Measurement

The TMAG3001 offers independent configurations to perform linear position measurements in X, Y, and Z axes. To calculate the expected error during linear measurement, the contributions from each of the individual error sources must be understood. The relevant error sources include sensitivity error, offset, noise, cross axis sensitivity, hysteresis, nonlinearity, drift across temperature, drift across life time, and so forth. For a 3-axis

Hall solution like the TMAG3001, the cross-axis sensitivity and hysteresis error sources are insignificant. Use [Equation 15](#) to estimate the linear measurement error calculation at room temperature.

$$\text{Error}_{\text{LM}_25\text{C}} = \frac{\sqrt{(B \times \text{SENS}_{\text{ER}})^2 + B_{\text{off}}^2 + N_{\text{RMS}_25}^2}}{B} \times 100\% \quad (15)$$

where

- $\text{Error}_{\text{LM}_25\text{C}}$  is total error in % during linear measurement at 25°C.
- B is input magnetic field.
- $\text{SENS}_{\text{ER}}$  is sensitivity error in decimal number at 25°C. As an example, enter 0.05 for sensitivity error of 5%.
- $B_{\text{off}}$  is offset error at 25°C.
- $N_{\text{RMS}_25}$  is RMS noise at 25°C.

In many applications, system level calibration at room temperature can nullify the offset and sensitivity errors at 25°C. The noise errors can be reduced by internally averaging by up to 32x on the device in addition to the averaging that can be done in the microcontroller. Use [Equation 16](#) to estimate the linear measurement error across temperature after calibration at room temperature.

$$\text{Error}_{\text{LM}_\text{Temp}} = \frac{\sqrt{(B \times \text{SENS}_{\text{DR}})^2 + B_{\text{off\_DR}}^2 + N_{\text{RMS}_\text{Temp}}^2}}{B} \times 100\% \quad (16)$$

where

- $\text{Error}_{\text{LM}_\text{Temp}}$  is total error in % during linear measurement across temperature after room temperature calibration.
- B is input magnetic field.
- $\text{SENS}_{\text{DR}}$  is sensitivity drift in decimal number from value at 25°C. As an example, enter 0.05 for sensitivity drift of 5%.
- $B_{\text{off\_DR}}$  is offset drift from value at 25°C.
- $N_{\text{RMS}_\text{Temp}}$  is RMS noise across temperature.

If room temperature calibration is not performed, sensitivity and offset errors at room temperature must also account for total error calculation across temperature (see [Equation 17](#)).

$$\text{Error}_{\text{LM}_\text{Temp\_NCal}} = \frac{\sqrt{(B \times \text{SENS}_{\text{ER}})^2 + (B \times \text{SENS}_{\text{DR}})^2 + B_{\text{off}}^2 + B_{\text{off\_DR}}^2 + N_{\text{RMS}_\text{Temp}}^2}}{B} \times 100\% \quad (17)$$

where

- $\text{Error}_{\text{LM}_\text{Temp\_NCal}}$  is total error in % during linear measurement across temperature without room temperature calibration.

---

#### Note

In this section, error sources such as system mechanical vibration, magnet temperature gradient, earth magnetic field, nonlinearity, lifetime drift, and so forth, are not considered. The user must take these additional error sources into account while calculating overall system error budgets.

---

### 8.1.9 Error Calculation During Angular Measurement

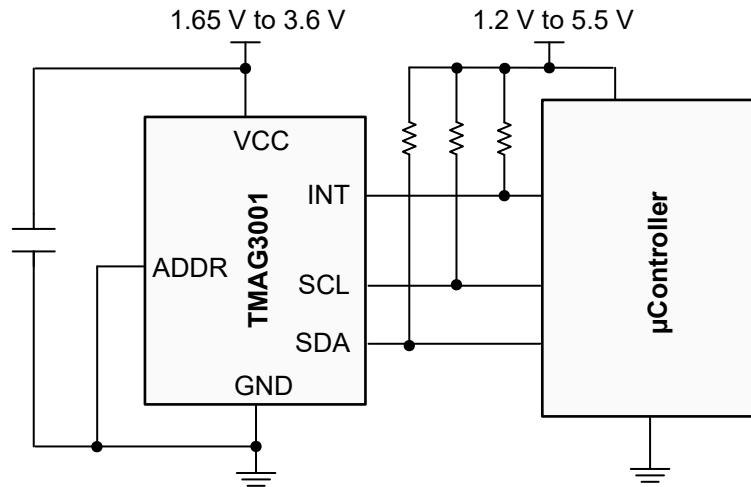
The TMAG3001 offers on-chip CORDIC to measure angle data from any of the two magnetic axes. The linear magnetic axis data can be used to calculate the angle using an external CORDIC as well. To calculate the expected error during angular measurement, the contributions from each individual error source must be understood. The relevant error sources include sensitivity error, offset, noise, axis-axis mismatch, nonlinearity, drift across temperature, drift across life time, and so forth. Use the [Angle Error Calculation Tool](#) to estimate the total error during angular measurement.

## 8.2 Typical Application

Magnetic 3D sensors are very popular due to contactless and reliable measurements, especially in applications requiring long-term measurements in rugged environments. The TMAG3001 offers design flexibility in wide range of industrial and personal electronics applications.

### 8.2.1 Angle Measurement

Magnetic angle sensors are very popular due to contactless and reliable measurements, especially in applications requiring long-term measurements in rugged environments. The TMAG3001 offers an on-chip angle calculator providing angular measurement based off any two of the magnetic axes. The two axes of interest can be selected in the ANGLE\_EN register bits. The device offers angle output in complete 360 degree scale. Take several error sources into account for angle calculation, including sensitivity error, offset error, linearity error, noise, mechanical vibration, temperature drift, and so forth.



**Figure 8-18. TMAG3001 Application Diagram for Angle Measurement**

#### 8.2.1.1 Design Requirements

Use the parameters listed in [Table 8-5](#) for this design example.

**Table 8-5. Design Parameters**

DESIGN PARAMETERS	ON-AXIS MEASUREMENT	OFF-AXIS MEASUREMENT
Device	TMAG3001-A1	TMAG3001-A1
VCC	3.3V	3.3V
Device Position	Directly under the magnet	At the adjacent side of the magnet
Magnet	Cylinder: 4.7625mm diameter, 12.7mm thick, neodymium N52, Br = 1480	Cylinder: 4.7625mm diameter, 12.7mm thick, neodymium N52, Br = 1480
Magnetic Range Selection	Select the same range for both axes based off the highest possible magnetic field seen by the sensor	Select the same range for both axes based off the highest possible magnetic field seen by the sensor
RPM	<600	<600
Desired Accuracy	<2° for 360° rotation	<2° for 360° rotation

### 8.2.1.2 Detailed Design Procedure

For accurate angle measurement, the two axes amplitudes must be normalized by selecting the proper gain adjustment value in the MAG\_GAIN\_CONFIG register. The gain adjustment value is a fractional decimal number between 0 and 1. The following steps must be followed to calculate this fractional value:

- Set the device at 32x average mode and rotate the shaft full 360 degree.
- Record the two axes sensor ADC codes for the full 360 degree rotation.
- A normalized plot for the full 360 degree rotations are represented in [Figure 8-20](#) or [Figure 8-21](#).
- Measure the maximum peak-peak ADC code delta for each axis,  $A_X$  and  $A_Y$ .
- If  $A_X > A_Y$ , set the MAG\_GAIN\_CH register bit to 0b. Calculate the gain adjustment value for X axis:

$$G_X = \frac{A_Y}{A_X} \quad (18)$$

- If  $A_X < A_Y$ , set the MAG\_GAIN\_CH register bit to 1b. Calculate the gain adjustment value for Y axis:

$$G_Y = \frac{1}{G_X} \quad (19)$$

- The target binary gain setting at the GAIN\_VALUE register bits are calculated from the equation,  $G_X$  or  $G_Y = \text{GAIN\_VALUE}_{\text{decimal}} / 256$ .

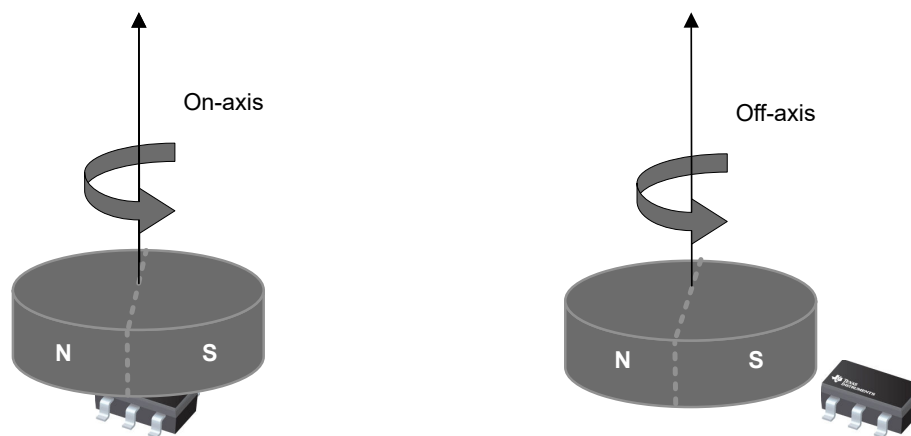
**Example 1:** If  $A_X = A_Y = 60,000$ , the GAIN\_VALUE register bits are set at default 0000 0000b.

**Example 2:** If  $A_X = 60,000$ ,  $A_Y = 45,000$ , the  $G_X = 45,000/60,000 = 0.75$ . Set MAG\_GAIN\_CH to 0b and GAIN\_VALUE to 1100 0000b.

**Example 3:** If  $A_X = 45,000$ ,  $A_Y = 60,000$ , the  $G_X = (60,000/45,000) = 1.33$ .  $G_X > 1$ , therefore the gain adjustment must be applied to Y axis with  $G_Y = 1/G_X$ . Set MAG\_GAIN\_CH to 1b and GAIN\_VALUE to 1100 0000b.

#### 8.2.1.2.1 Gain Adjustment for Angle Measurement

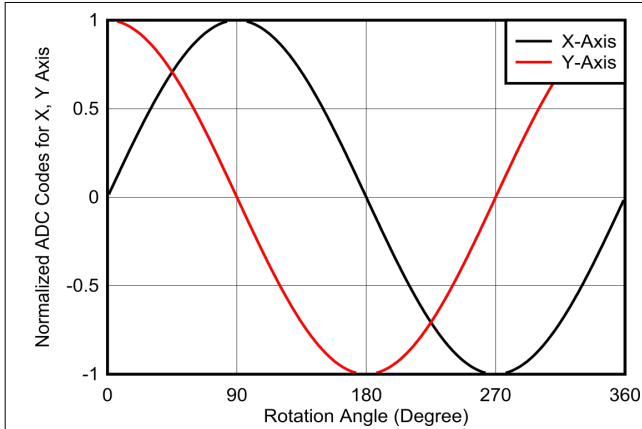
Common measurement topology include angular position measurements in on-axis or off-axis angular measurements shown in [Figure 8-19](#). Select the on-axis measurement topology whenever possible as this offers the best optimization of magnetic field and the device measurement ranges. The TMAG3001 offers on-chip gain adjustment option to account for mechanical position misalignments.



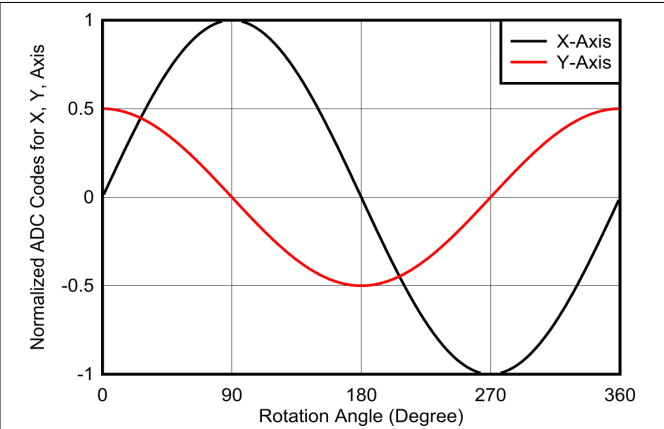
**Figure 8-19. On-Axis vs Off-Axis Angle Measurements**



### 8.2.1.3 Application Curves



**Figure 8-20. X and Y Sensor Data for Full 360 Degree Rotation for On-Axis Measurement**



**Figure 8-21. X and Y Sensor Data for Full 360 Degree Rotation for Off-Axis Measurement**

### 8.3 Best Design Practices

The TMAG3001 updates the result registers at the end of a conversion. I<sup>2</sup>C read of the result register must be synchronized with the conversion update time to avoid reading a result data while the result register is being updated. For applications with tight timing budget use the INT signal to notify the controller when a conversion is complete.

## 8.4 Power Supply Recommendations

A decoupling capacitor close to the device must be used to provide local energy with minimal inductance. TI recommends using a ceramic capacitor with a value of at least 0.01µF.

## 8.5 Layout

### 8.5.1 Layout Guidelines

Magnetic fields pass through most nonferromagnetic materials with no significant disturbance. Embedding Hall effect sensors within plastic or aluminum enclosures and sensing magnets on the outside is common practice. Magnetic fields also easily pass through most printed circuit boards (PCBs), which makes placing the magnet on the opposite side of the PCB possible.

### 8.5.2 Layout Example

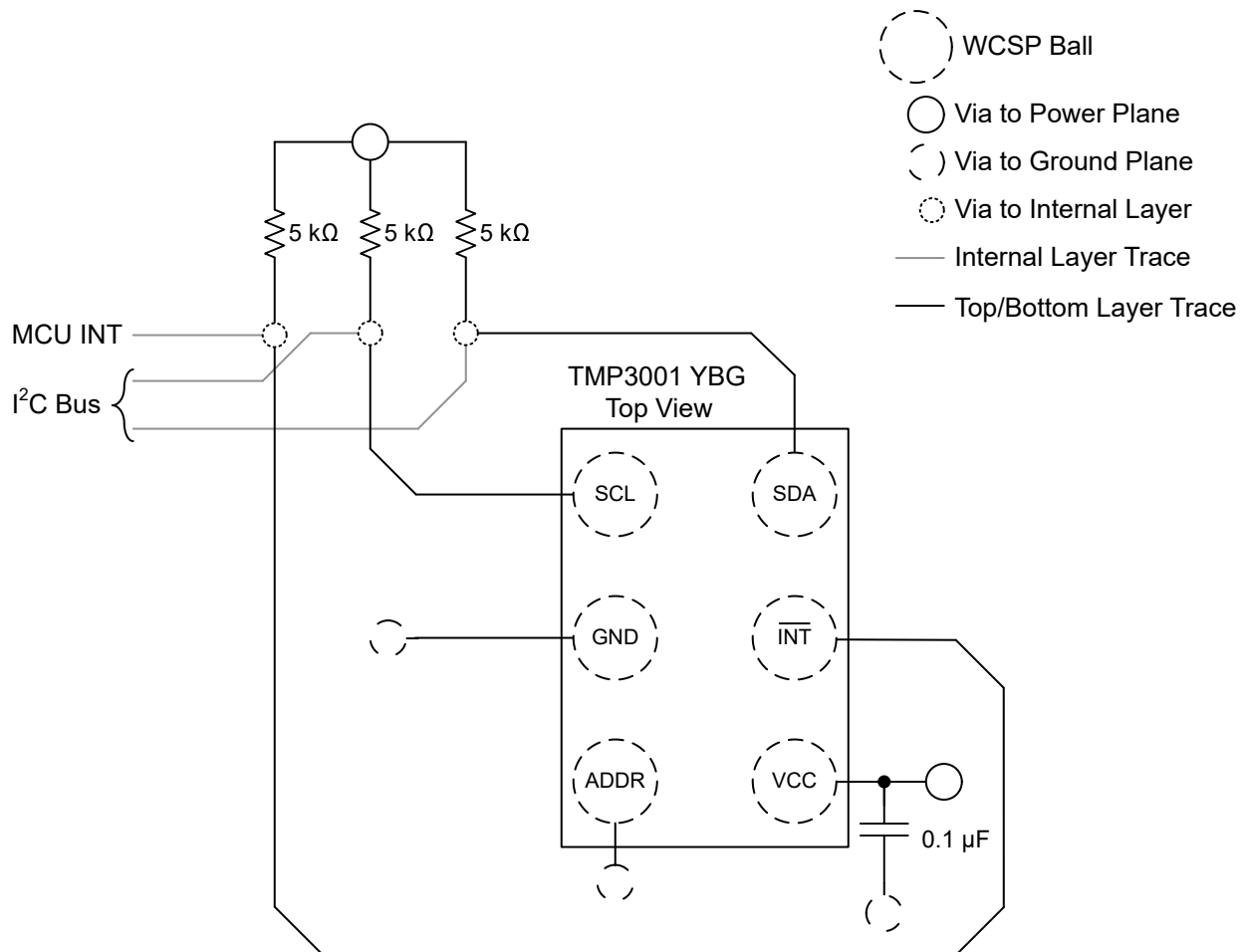


Figure 8-22. Layout Example With TMAG3001

## 9 Device and Documentation Support

### 9.1 Documentation Support

#### 9.1.1 Related Documentation

For related documentation see the following:

- Texas Instruments, [Angle Measurement With Multi-Axis Linear Hall-Effect Sensors application note](#)
- Texas Instruments, [I<sup>2</sup>C Pullup Resistor Calculation application note](#)
- Texas Instruments, [Absolute Angle Measurements for Rotational Motion Using Hall-Effect Sensors application brief](#)
- Texas Instruments, [Limit Detection for Tamper and End-of-Travel Detection Using Hall-Effect Sensors application brief](#)

### 9.2 Receiving Notification of Documentation Updates

To receive notification of documentation updates, navigate to the device product folder on [ti.com](https://www.ti.com). Click on *Notifications* to register and receive a weekly digest of any product information that has changed. For change details, review the revision history included in any revised document.

### 9.3 Support Resources

[TI E2E™ support forums](#) are an engineer's go-to source for fast, verified answers and design help — straight from the experts. Search existing answers or ask your own question to get the quick design help you need.

Linked content is provided "AS IS" by the respective contributors. They do not constitute TI specifications and do not necessarily reflect TI's views; see TI's [Terms of Use](#).

### 9.4 Trademarks

TI E2E™ is a trademark of Texas Instruments.

All trademarks are the property of their respective owners.

### 9.5 Electrostatic Discharge Caution



This integrated circuit can be damaged by ESD. Texas Instruments recommends that all integrated circuits be handled with appropriate precautions. Failure to observe proper handling and installation procedures can cause damage.

ESD damage can range from subtle performance degradation to complete device failure. Precision integrated circuits may be more susceptible to damage because very small parametric changes could cause the device not to meet its published specifications.

### 9.6 Glossary

[TI Glossary](#) This glossary lists and explains terms, acronyms, and definitions.

## 10 Revision History

NOTE: Page numbers for previous revisions may differ from page numbers in the current version.

<b>Changes from Revision B (June 2024) to Revision C (May 2025)</b>	<b>Page</b>
• Updated maximum I <sub>OUT</sub> in <i>Recommended Operating Conditions</i> from 2mA to 4.5mA.....	4
• Corrected top to bottom.....	4
• Changed Sensitivity Drift format in Magnetic Characteristics for A1 table.....	6
• Changed Sensitivity Mismatch Drift format in Magnetic Characteristics for A1 table.....	6
• Changed Sensitivity Drift format in Magnetic Characteristics for A2 table.....	8
• Changed Sensitivity Mismatch Drift format in Magnetic Characteristics for A2 table.....	8
• Added sensing element location from center of die.....	14
• Added INT_POL_EN as a bit field needed to invert INT polarity .....	15
• Added text to latched interrupt through INT behavior .....	15
• Added text to describe wake on change behavior when used in wake and sleep mode.....	18
• Added text to clarify wake on change with magnetic axis measurements.....	18

• Added table to summarize relevant wake on change mode settings.....	18
• Added extra note that TMAG3001 supports General Call I <sup>2</sup> C Address to the I <sup>2</sup> C Address section.....	20
• Added $\overline{\text{INT}}$ behavior while transitioning from sleep to standby mode .....	22
• Added text to describe device behavior when an I <sup>2</sup> C read is executed after an interrupt.....	22
• Added <i>Data from Register N +2</i> and <i>Data from Register N+3</i> information to the <i>Standard I<sup>2</sup>C Read With CRC Enabled</i> image.....	27
• Changed NA to A to align with the ACK from Controller text in <i>I<sup>2</sup>C Read Command for 16-Bit Data</i> .....	29
• Changed NA to A to align with the ACK from Controller text in <i>I<sup>2</sup>C Read Command for 8-Bit Data</i> .....	32
• Added note on CRC behavior with multiple device on the I <sup>2</sup> C bus.....	34
• Changed the LSB size for each magnetic range for magnetic data calculation.....	35
• Changed table title from 1-bit to 8-bit.....	36
• Added text to the THR_HYST[2:0] bit descriptions .....	40
• Added text to the Angle_HYS[1:0] bit descriptions .....	40
• Added text to the Threshold1[7:0], Threshold2[7:0], Threshold3[7:0], Gain_X_THR_HI[7:0], Offset1_Y_THR_HI[7:0], and Offset2_Z_THR_HI[7:0] bitfield descriptions .....	40
• Added text to WOC_SEL[1:0] bitfield description .....	40
• Changed I2C_Address[6:0] bit field description.....	40
• Added text to describe magnetic thresholds.....	63
• Added text to describe unipolar switch mode thresholds.....	66

#### Changes from Revision A (March 2023) to Revision B (June 2024)

Page

• Changed TMAG3001A1 device status from Advanced Information to Production Data.....	1
• Changed data sheet status from Production Mixed to Production Data.....	1
• Updated ESD Ratings formatting.....	4
• Change maximum input capacitance from: 10pF to 7.5pF.....	5
• Added maximum values for the sensitivity linearity error parameter to the Magnetic Characteristics for A2 table.....	8
• Added sensitivity drift linearity error parameter to the Magnetic Characteristics for A2 table.....	8
• Added sensitivity mismatch drift linearity parameter to the Magnetic Characteristics for A2 table.....	8
• Added offset drift linearity error parameter to the Magnetic Characteristics for A2 table.....	8
• Changed minimum hold time after repeated START condition from: 0 $\mu$ s to: 0.1 $\mu$ s.....	9
• Changed minimum data hold time for fast mode from: 0ns to:15ns.....	9
• Changed minimum data hold time for fast mode plus from: 0ns to:15ns.....	9
• Added minimum and maximum values for Power-Up Timing parameters.....	11
• Changed typical time to go to standby mode from sleep mode from: 70 $\mu$ s to: 62 $\mu$ s.....	11

#### Changes from Revision \* (November 2023) to Revision A (March 2024)

Page

• Changed TMAG3001A2 device status from Advanced Information to Production Data.....	1
• Changed data sheet status from Advanced Information to Production Mixed.....	1

## 11 Mechanical, Packaging, and Orderable Information

The following pages include mechanical, packaging, and orderable information. This information is the most current data available for the designated devices. This data is subject to change without notice and revision of this document. For browser-based versions of this data sheet, refer to the left-hand navigation.

**PACKAGING INFORMATION**

Orderable Device	Status (1)	Package Type	Package Drawing	Pins	Package Qty	Eco Plan (2)	Lead finish/ Ball material (6)	MSL Peak Temp (3)	Op Temp (°C)	Device Marking (4/5)	Samples
TMAG3001A1YBGR	ACTIVE	DSBGA	YBG	6	3000	RoHS & Green	SNAGCU	Level-1-260C-UNLIM	-40 to 125	OD	<a href="#">Samples</a>
TMAG3001A2YBGR	ACTIVE	DSBGA	YBG	6	3000	RoHS & Green	SNAGCU	Level-1-260C-UNLIM	-40 to 125	OE	<a href="#">Samples</a>

(1) The marketing status values are defined as follows:

**ACTIVE:** Product device recommended for new designs.

**LIFEBUY:** TI has announced that the device will be discontinued, and a lifetime-buy period is in effect.

**NRND:** Not recommended for new designs. Device is in production to support existing customers, but TI does not recommend using this part in a new design.

**PREVIEW:** Device has been announced but is not in production. Samples may or may not be available.

**OBSOLETE:** TI has discontinued the production of the device.

(2) **RoHS:** TI defines "RoHS" to mean semiconductor products that are compliant with the current EU RoHS requirements for all 10 RoHS substances, including the requirement that RoHS substance do not exceed 0.1% by weight in homogeneous materials. Where designed to be soldered at high temperatures, "RoHS" products are suitable for use in specified lead-free processes. TI may reference these types of products as "Pb-Free".

**RoHS Exempt:** TI defines "RoHS Exempt" to mean products that contain lead but are compliant with EU RoHS pursuant to a specific EU RoHS exemption.

**Green:** TI defines "Green" to mean the content of Chlorine (Cl) and Bromine (Br) based flame retardants meet JS709B low halogen requirements of <=1000ppm threshold. Antimony trioxide based flame retardants must also meet the <=1000ppm threshold requirement.

(3) MSL, Peak Temp. - The Moisture Sensitivity Level rating according to the JEDEC industry standard classifications, and peak solder temperature.

(4) There may be additional marking, which relates to the logo, the lot trace code information, or the environmental category on the device.

(5) Multiple Device Markings will be inside parentheses. Only one Device Marking contained in parentheses and separated by a "~" will appear on a device. If a line is indented then it is a continuation of the previous line and the two combined represent the entire Device Marking for that device.

(6) Lead finish/Ball material - Orderable Devices may have multiple material finish options. Finish options are separated by a vertical ruled line. Lead finish/Ball material values may wrap to two lines if the finish value exceeds the maximum column width.

**Important Information and Disclaimer:**The information provided on this page represents TI's knowledge and belief as of the date that it is provided. TI bases its knowledge and belief on information provided by third parties, and makes no representation or warranty as to the accuracy of such information. Efforts are underway to better integrate information from third parties. TI has taken and continues to take reasonable steps to provide representative and accurate information but may not have conducted destructive testing or chemical analysis on incoming materials and chemicals. TI and TI suppliers consider certain information to be proprietary, and thus CAS numbers and other limited information may not be available for release.

In no event shall TI's liability arising out of such information exceed the total purchase price of the TI part(s) at issue in this document sold by TI to Customer on an annual basis.



**TAPE AND REEL INFORMATION**

**QUADRANT ASSIGNMENTS FOR PIN 1 ORIENTATION IN TAPE**


\*All dimensions are nominal

Device	Package Type	Package Drawing	Pins	SPQ	Reel Diameter (mm)	Reel Width W1 (mm)	A0 (mm)	B0 (mm)	K0 (mm)	P1 (mm)	W (mm)	Pin1 Quadrant
TMAG3001A1YBGR	DSBGA	YBG	6	3000	180.0	8.4	0.9	1.41	0.56	2.0	8.0	Q1
TMAG3001A2YBGR	DSBGA	YBG	6	3000	180.0	8.4	0.9	1.41	0.56	2.0	8.0	Q1

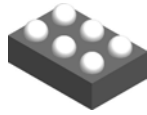
**TAPE AND REEL BOX DIMENSIONS**


\*All dimensions are nominal

Device	Package Type	Package Drawing	Pins	SPQ	Length (mm)	Width (mm)	Height (mm)
TMAG3001A1YBGR	DSBGA	YBG	6	3000	182.0	182.0	20.0
TMAG3001A2YBGR	DSBGA	YBG	6	3000	182.0	182.0	20.0



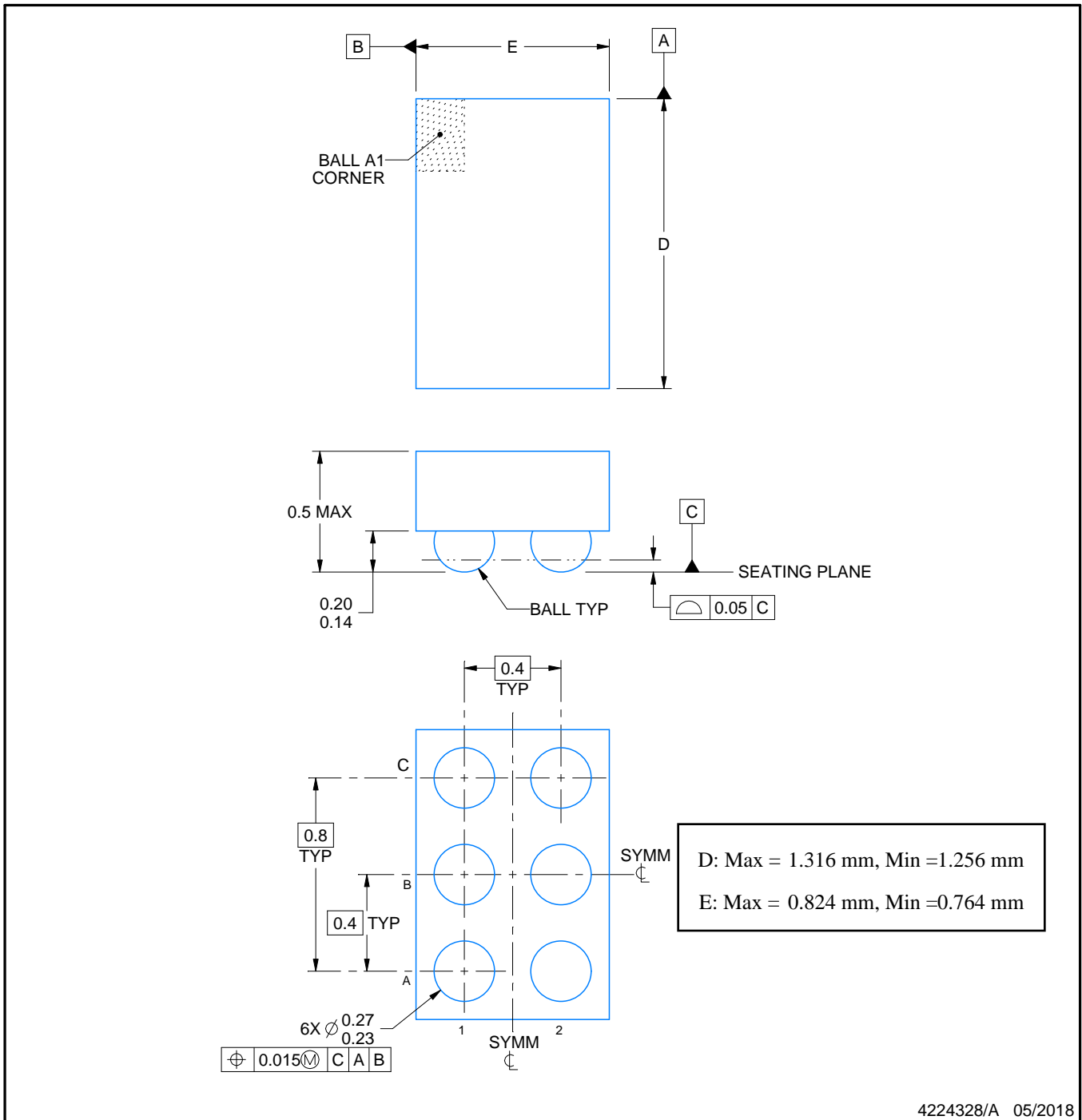
YBG0006



PACKAGE OUTLINE

DSBGA - 0.5 mm max height

DIE SIZE BALL GRID ARRAY



NOTES:

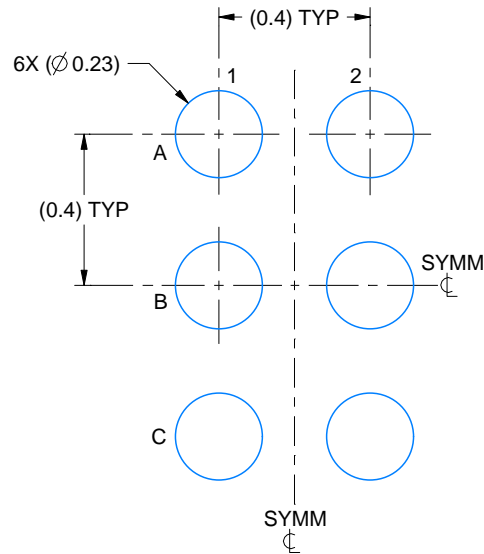
1. All linear dimensions are in millimeters. Any dimensions in parenthesis are for reference only. Dimensioning and tolerancing per ASME Y14.5M.
2. This drawing is subject to change without notice.

# EXAMPLE BOARD LAYOUT

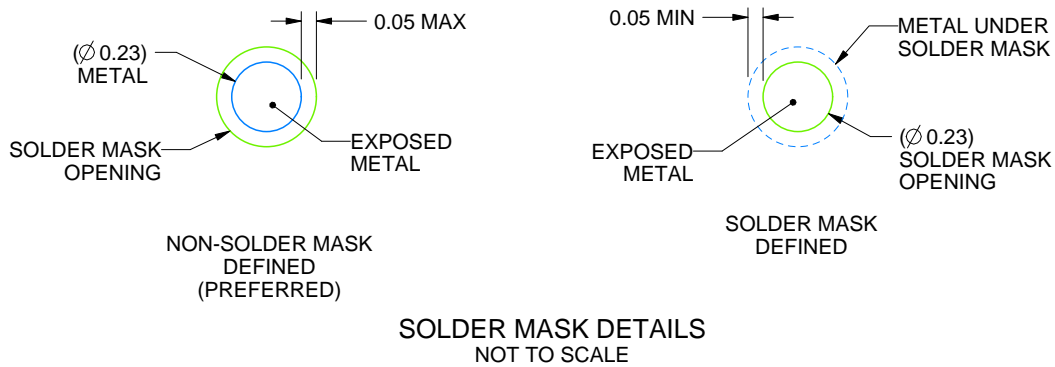
YBG0006

DSBGA - 0.5 mm max height

DIE SIZE BALL GRID ARRAY



LAND PATTERN EXAMPLE  
EXPOSED METAL SHOWN  
SCALE: 50X



SOLDER MASK DETAILS  
NOT TO SCALE

4224328/A 05/2018

NOTES: (continued)

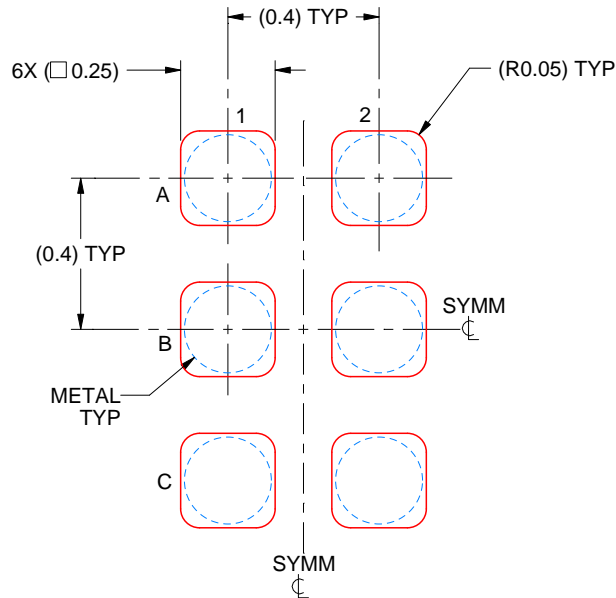
- Final dimensions may vary due to manufacturing tolerance considerations and also routing constraints. See Texas Instruments Literature No. SNVA009 ([www.ti.com/lit/snva009](http://www.ti.com/lit/snva009)).

# EXAMPLE STENCIL DESIGN

YBG0006

DSBGA - 0.5 mm max height

DIE SIZE BALL GRID ARRAY



SOLDER PASTE EXAMPLE  
BASED ON 0.1 mm THICK STENCIL  
SCALE: 50X

4224328/A 05/2018

NOTES: (continued)

4. Laser cutting apertures with trapezoidal walls and rounded corners may offer better paste release.

## IMPORTANT NOTICE AND DISCLAIMER

TI PROVIDES TECHNICAL AND RELIABILITY DATA (INCLUDING DATA SHEETS), DESIGN RESOURCES (INCLUDING REFERENCE DESIGNS), APPLICATION OR OTHER DESIGN ADVICE, WEB TOOLS, SAFETY INFORMATION, AND OTHER RESOURCES "AS IS" AND WITH ALL FAULTS, AND DISCLAIMS ALL WARRANTIES, EXPRESS AND IMPLIED, INCLUDING WITHOUT LIMITATION ANY IMPLIED WARRANTIES OF MERCHANTABILITY, FITNESS FOR A PARTICULAR PURPOSE OR NON-INFRINGEMENT OF THIRD PARTY INTELLECTUAL PROPERTY RIGHTS.

These resources are intended for skilled developers designing with TI products. You are solely responsible for (1) selecting the appropriate TI products for your application, (2) designing, validating and testing your application, and (3) ensuring your application meets applicable standards, and any other safety, security, regulatory or other requirements.

These resources are subject to change without notice. TI grants you permission to use these resources only for development of an application that uses the TI products described in the resource. Other reproduction and display of these resources is prohibited. No license is granted to any other TI intellectual property right or to any third party intellectual property right. TI disclaims responsibility for, and you will fully indemnify TI and its representatives against, any claims, damages, costs, losses, and liabilities arising out of your use of these resources.

TI's products are provided subject to [TI's Terms of Sale](#) or other applicable terms available either on [ti.com](https://www.ti.com) or provided in conjunction with such TI products. TI's provision of these resources does not expand or otherwise alter TI's applicable warranties or warranty disclaimers for TI products.

TI objects to and rejects any additional or different terms you may have proposed.

Mailing Address: Texas Instruments, Post Office Box 655303, Dallas, Texas 75265  
Copyright © 2025, Texas Instruments Incorporated