

# AFE4950 Ultra-Small, Integrated AFE for Wearable Optical Heart-Rate Monitoring, SpO<sub>2</sub> and Electrical Bio-sensing

## 1 Features

- Supports simultaneous and synchronized acquisition of up to 24 PPG and a single-lead ECG signal.
- Flexible allocation of 8 LED, 4 PD in each phase
- ECG signal chain:
  - 1-lead ECG signal acquisition up to 2 kHz
  - RLD output to drive a third electrode
  - Input noise : 0.7  $\mu$ V-rms
  - Supports up to  $\pm 0.65$  V differential DC offset and  $\pm 0.55$  V common mode range
  - Programmable INA gain: 11, 21
  - High-pass filter with quick saturation recovery
  - Integrated 300 Hz anti-aliasing low pass filter
  - AC, DC lead-off detect: 2.9 nA to 92.5 nA
  - Low power continuous lead-on detection
- Impedance signal chain
  - Continuous low-power monitoring of impedance between 2 electrodes
  - 7 M $\Omega$  range
  - 300  $\Omega$  noise on 620 k $\Omega$
- PPG Transmitter:
  - 8-Bit Programmable LED Current with range adjustable from 25 mA to 250 mA
  - Mode to fire two LEDs in parallel
  - Support of 8 LEDs in Common Anode configuration for SpO<sub>2</sub>, Multi-Wavelength HRM
- PPG Receiver:
  - 2 parallel receivers (two sets of TIA/ filter)
  - Supports 4 Time-Multiplexed Photodiode Inputs to each Receiver
  - 8-bit Ambient Offset subtraction at each TIA input with 256  $\mu$ A range
  - 8-bit LED Offset Subtraction DAC with 64  $\mu$ A range
  - Automatic ambient cancellation and dynamic LED DC cancellation at TIA input
  - Ambient rejection close to 100 dB up to 10 Hz
  - Noise filtering with programmable bandwidth
  - Trans-impedance Gain: 3.7 k $\Omega$  to 1 M $\Omega$
- Accurate, Continuous Heart-Rate Monitoring:
  - System SNR up to 109-dB at 16  $\mu$ A PD current
  - Low Current for Continuous Operation on a Wearable Device with a Typical Value: 15- $\mu$ A for an LED, 20- $\mu$ A for the Receiver
- External clock and internal oscillator modes
- Acquire data synchronized with system master clock
- FIFO with 256-sample Depth

- SPI, I<sup>2</sup>C interfaces: Selectable by pin
- 2.6-mm  $\times$  2.5-mm DSBGA, 0.4-mm Pitch
- Supplies: Rx:1.7-1.9V (LDO Bypass); 1.9-3.6V (LDO Enabled), Tx:3-5.5V, IO:1.7-RX\_SUP

## 2 Applications

- Optical Heart-Rate Monitoring (HRM) for Wearables, Hearables
- High performance ECG signal acquisition
- Synchronized PPG, ECG for BP estimation
- Heart-rate variability (HRV)
- Pulse oximetry (SpO<sub>2</sub>) measurements

## 3 Description

The AFE4950 device is an analog front-end (AFE) for synchronized signal acquisition of PPG and ECG signals. The device can also be used for optical bio-sensing applications, such as heart-rate monitoring (HRM) and saturation of peripheral capillary oxygen (SpO<sub>2</sub>). The ECG signal chain supports 2- and 3-electrode configurations and has an integrated Right leg drive (RLD) buffer. The ECG signal chain can also be used to do a continuous, low-power monitoring of the impedance between pair of electrodes.

### Device Information

PART NUMBER	PACKAGE <sup>(1)</sup>	BODY SIZE (NOM)
AFE4950	DSBGA (36)	2.60 mm $\times$ 2.50 mm

- (1) For all available packages, see the orderable addendum at the end of the data sheet.

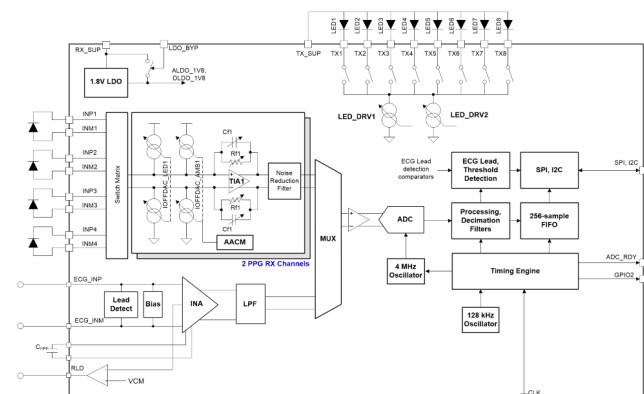

**Simplified Schematic**



## 4 Revision History

NOTE: Page numbers for previous revisions may differ from page numbers in the current version.

---

**Changes from Revision A (July 2020) to Revision B (July 2021) Page**

- Changed the *Features* list *AC, DC lead-off detect* value From: 2.6-nA to 85-nA To: 2.9 nA to 92.5 nA ..... 1
- 

**Changes from Revision \* (June 2020) to Revision A (July 2020) Page**

- Changed the data sheet From: *Advanced Information* To: *Production data*..... 1
-

## 5 Device and Documentation Support

### 5.1 Receiving Notification of Documentation Updates

To receive notification of documentation updates, navigate to the device product folder on [ti.com](http://ti.com). Click on *Subscribe to updates* to register and receive a weekly digest of any product information that has changed. For change details, review the revision history included in any revised document.

### 5.2 Support Resources

TI E2E™ [support forums](#) are an engineer's go-to source for fast, verified answers and design help — straight from the experts. Search existing answers or ask your own question to get the quick design help you need.

Linked content is provided "AS IS" by the respective contributors. They do not constitute TI specifications and do not necessarily reflect TI's views; see TI's [Terms of Use](#).

### 5.3 Trademarks

TI E2E™ is a trademark of Texas Instruments.

All trademarks are the property of their respective owners.

### 5.4 Electrostatic Discharge Caution



This integrated circuit can be damaged by ESD. Texas Instruments recommends that all integrated circuits be handled with appropriate precautions. Failure to observe proper handling and installation procedures can cause damage.

ESD damage can range from subtle performance degradation to complete device failure. Precision integrated circuits may be more susceptible to damage because very small parametric changes could cause the device not to meet its published specifications.

### 5.5 Glossary

[TI Glossary](#) This glossary lists and explains terms, acronyms, and definitions.

### Mechanical, Packaging, and Orderable Information

The following pages include mechanical, packaging, and orderable information. This information is the most current data available for the designated devices. This data is subject to change without notice and revision of this document. For browser-based versions of this data sheet, refer to the left-hand navigation.

**PACKAGING INFORMATION**

Orderable Device	Status (1)	Package Type	Package Drawing	Pins	Package Qty	Eco Plan (2)	Lead finish/ Ball material (6)	MSL Peak Temp (3)	Op Temp (°C)	Device Marking (4/5)	Samples
AFE4950YBGR	ACTIVE	DSBGA	YBG	36	3000	RoHS & Green	SAC396	Level-1-260C-UNLIM	-40 to 85	AFE4950	Samples
AFE4950YBGT	ACTIVE	DSBGA	YBG	36	250	RoHS & Green	SAC396	Level-1-260C-UNLIM	-40 to 85	AFE4950	Samples

(1) The marketing status values are defined as follows:

**ACTIVE:** Product device recommended for new designs.

**LIFEBUY:** TI has announced that the device will be discontinued, and a lifetime-buy period is in effect.

**NRND:** Not recommended for new designs. Device is in production to support existing customers, but TI does not recommend using this part in a new design.

**PREVIEW:** Device has been announced but is not in production. Samples may or may not be available.

**OBSOLETE:** TI has discontinued the production of the device.

(2) **RoHS:** TI defines "RoHS" to mean semiconductor products that are compliant with the current EU RoHS requirements for all 10 RoHS substances, including the requirement that RoHS substance do not exceed 0.1% by weight in homogeneous materials. Where designed to be soldered at high temperatures, "RoHS" products are suitable for use in specified lead-free processes. TI may reference these types of products as "Pb-Free".

**RoHS Exempt:** TI defines "RoHS Exempt" to mean products that contain lead but are compliant with EU RoHS pursuant to a specific EU RoHS exemption.

**Green:** TI defines "Green" to mean the content of Chlorine (Cl) and Bromine (Br) based flame retardants meet JS709B low halogen requirements of <=1000ppm threshold. Antimony trioxide based flame retardants must also meet the <=1000ppm threshold requirement.

(3) MSL, Peak Temp. - The Moisture Sensitivity Level rating according to the JEDEC industry standard classifications, and peak solder temperature.

(4) There may be additional marking, which relates to the logo, the lot trace code information, or the environmental category on the device.

(5) Multiple Device Markings will be inside parentheses. Only one Device Marking contained in parentheses and separated by a "~" will appear on a device. If a line is indented then it is a continuation of the previous line and the two combined represent the entire Device Marking for that device.

(6) Lead finish/Ball material - Orderable Devices may have multiple material finish options. Finish options are separated by a vertical ruled line. Lead finish/Ball material values may wrap to two lines if the finish value exceeds the maximum column width.

**Important Information and Disclaimer:**The information provided on this page represents TI's knowledge and belief as of the date that it is provided. TI bases its knowledge and belief on information provided by third parties, and makes no representation or warranty as to the accuracy of such information. Efforts are underway to better integrate information from third parties. TI has taken and continues to take reasonable steps to provide representative and accurate information but may not have conducted destructive testing or chemical analysis on incoming materials and chemicals. TI and TI suppliers consider certain information to be proprietary, and thus CAS numbers and other limited information may not be available for release.

In no event shall TI's liability arising out of such information exceed the total purchase price of the TI part(s) at issue in this document sold by TI to Customer on an annual basis.

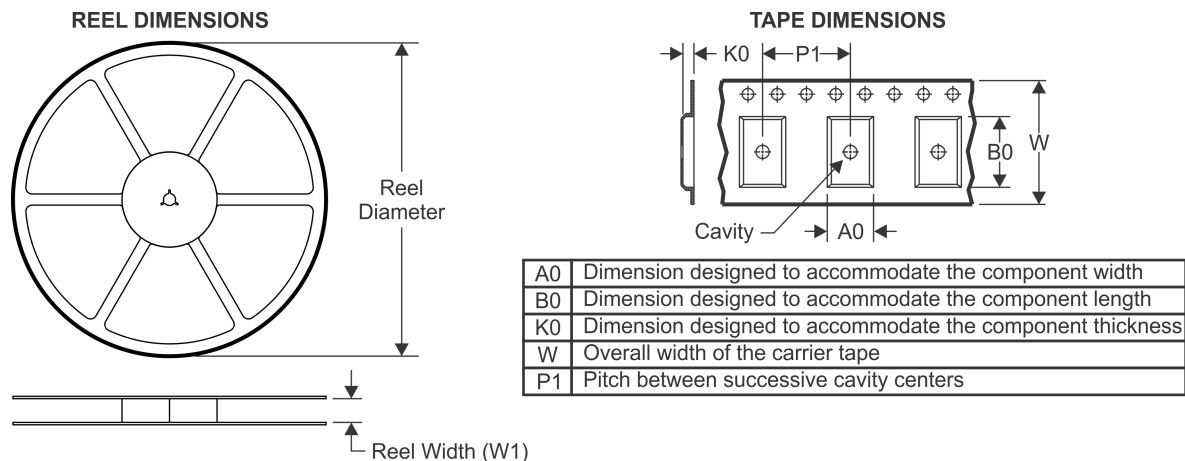

**TAPE AND REEL INFORMATION**

**QUADRANT ASSIGNMENTS FOR PIN 1 ORIENTATION IN TAPE**



\*All dimensions are nominal

Device	Package Type	Package Drawing	Pins	SPQ	Reel Diameter (mm)	Reel Width W1 (mm)	A0 (mm)	B0 (mm)	K0 (mm)	P1 (mm)	W (mm)	Pin1 Quadrant
AFE4950YBGR	DSBGA	YBG	36	3000	330.0	12.4	2.64	2.8	0.74	8.0	12.0	Q1
AFE4950YBGT	DSBGA	YBG	36	250	330.0	12.4	2.64	2.8	0.74	8.0	12.0	Q1

**TAPE AND REEL BOX DIMENSIONS**

\*All dimensions are nominal

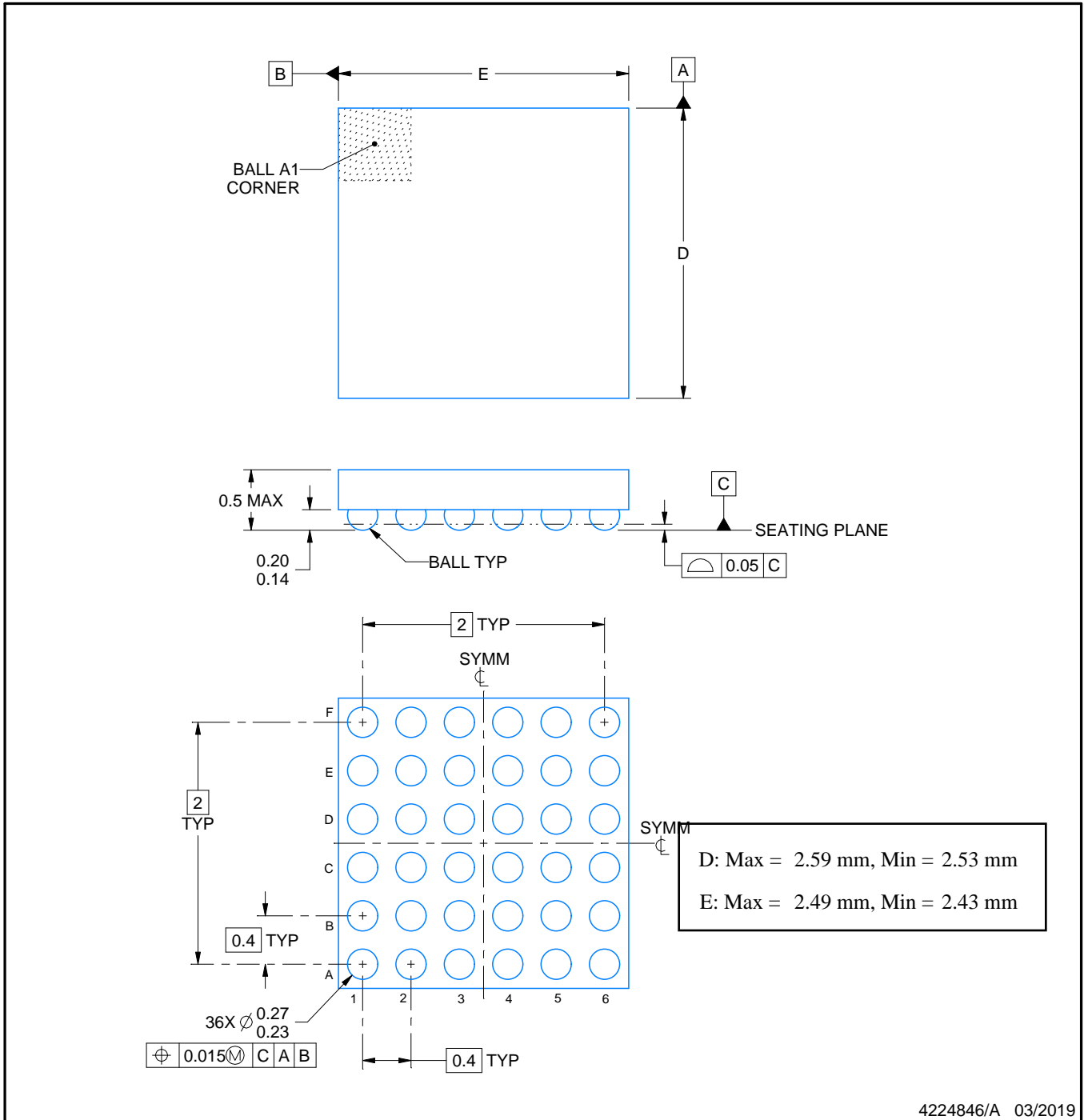
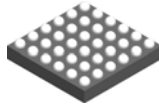
Device	Package Type	Package Drawing	Pins	SPQ	Length (mm)	Width (mm)	Height (mm)
AFE4950YBGR	DSBGA	YBG	36	3000	345.0	365.0	55.0
AFE4950YBGT	DSBGA	YBG	36	250	345.0	365.0	55.0



NOTES:

1. All linear dimensions are in millimeters. Any dimensions in parenthesis are for reference only. Dimensioning and tolerancing per ASME Y14.5M.
2. This drawing is subject to change without notice.



# EXAMPLE BOARD LAYOUT

YBG0036

DSBGA - 0.5 mm max height

DIE SIZE BALL GRID ARRAY

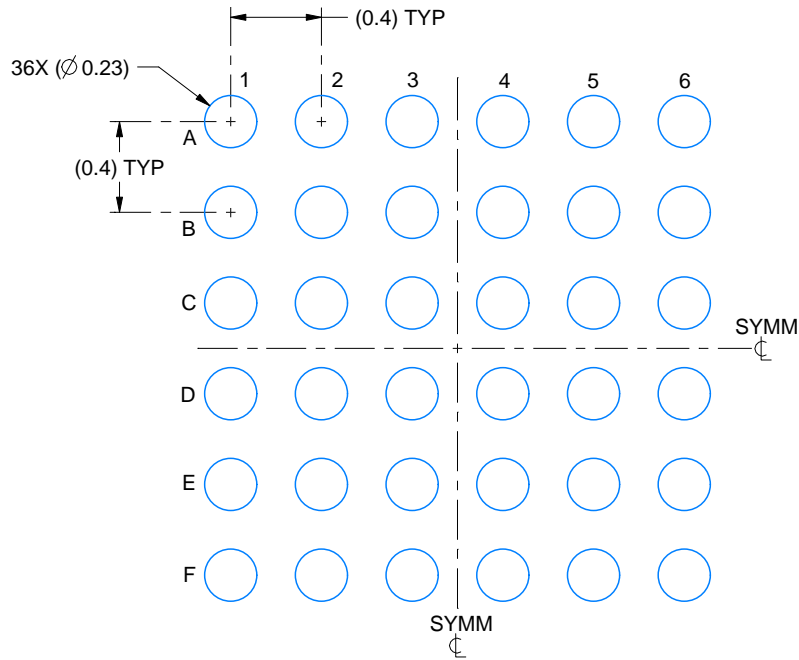

LAND PATTERN EXAMPLE  
EXPOSED METAL SHOWN  
SCALE: 30X

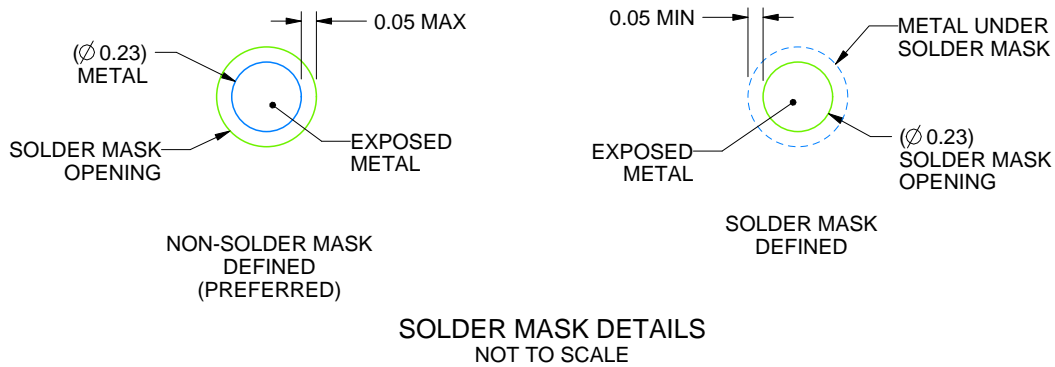

SOLDER MASK DETAILS  
NOT TO SCALE

4224846/A 03/2019

NOTES: (continued)

- Final dimensions may vary due to manufacturing tolerance considerations and also routing constraints. See Texas Instruments Literature No. SNVA009 ([www.ti.com/lit/snva009](http://www.ti.com/lit/snva009)).

# EXAMPLE STENCIL DESIGN

YBG0036

DSBGA - 0.5 mm max height

DIE SIZE BALL GRID ARRAY

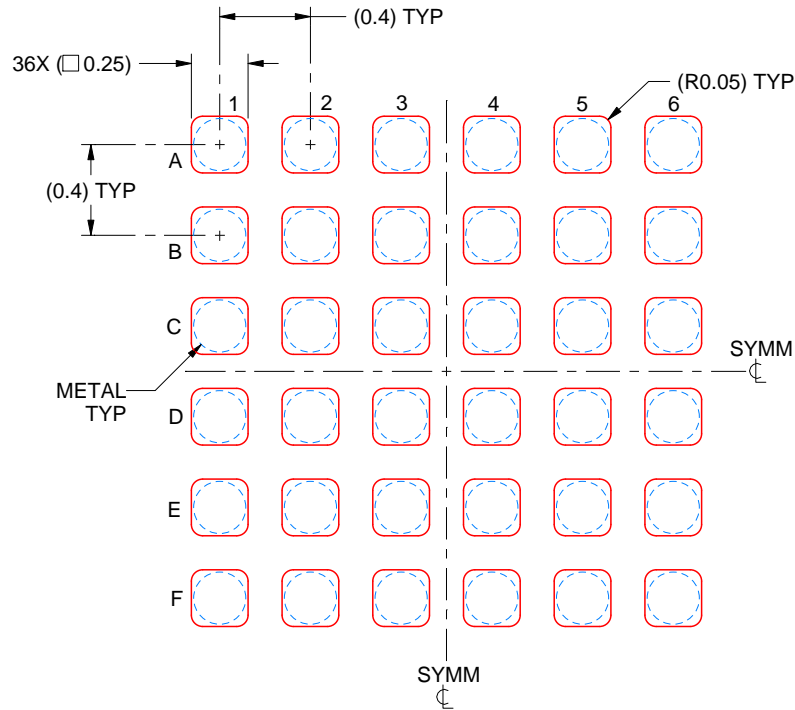

SOLDER PASTE EXAMPLE  
BASED ON 0.1 mm THICK STENCIL  
SCALE: 30X

4224846/A 03/2019

NOTES: (continued)

4. Laser cutting apertures with trapezoidal walls and rounded corners may offer better paste release.

## IMPORTANT NOTICE AND DISCLAIMER

TI PROVIDES TECHNICAL AND RELIABILITY DATA (INCLUDING DATA SHEETS), DESIGN RESOURCES (INCLUDING REFERENCE DESIGNS), APPLICATION OR OTHER DESIGN ADVICE, WEB TOOLS, SAFETY INFORMATION, AND OTHER RESOURCES "AS IS" AND WITH ALL FAULTS, AND DISCLAIMS ALL WARRANTIES, EXPRESS AND IMPLIED, INCLUDING WITHOUT LIMITATION ANY IMPLIED WARRANTIES OF MERCHANTABILITY, FITNESS FOR A PARTICULAR PURPOSE OR NON-INFRINGEMENT OF THIRD PARTY INTELLECTUAL PROPERTY RIGHTS.

These resources are intended for skilled developers designing with TI products. You are solely responsible for (1) selecting the appropriate TI products for your application, (2) designing, validating and testing your application, and (3) ensuring your application meets applicable standards, and any other safety, security, regulatory or other requirements.

These resources are subject to change without notice. TI grants you permission to use these resources only for development of an application that uses the TI products described in the resource. Other reproduction and display of these resources is prohibited. No license is granted to any other TI intellectual property right or to any third party intellectual property right. TI disclaims responsibility for, and you will fully indemnify TI and its representatives against, any claims, damages, costs, losses, and liabilities arising out of your use of these resources.

TI's products are provided subject to [TI's Terms of Sale](#) or other applicable terms available either on [ti.com](https://www.ti.com) or provided in conjunction with such TI products. TI's provision of these resources does not expand or otherwise alter TI's applicable warranties or warranty disclaimers for TI products.

TI objects to and rejects any additional or different terms you may have proposed.

Mailing Address: Texas Instruments, Post Office Box 655303, Dallas, Texas 75265  
Copyright © 2023, Texas Instruments Incorporated