

AFE7901 4T4R RF Sampling AFE with 12 GSPS DACs and 3 GSPS ADCs

1 Features

- [Request full data sheet](#)
- Quad RF sampling 12-GSPS transmit DACs
- Quad RF sampling 3-GSPS receive ADCs
- Maximum RF signal bandwidth per TX or RX: 400 MHz
- RF frequency range: 5 MHz - 7.4 GHz
- Digital step attenuators (DSA):
 - TX: 40 dB range, 0.125-dB steps
 - RX: 25 dB range, 0.5-dB steps
- Single or dual-band DUC or DDCs for TX and RX
- 16x NCOs per TX or RX
- Optional Internal PLL or VCO for DAC or ADC clocks or external clock at DAC or ADC sample rate
- Sysref Alignment Detector
- SerDes data interface:
 - JESD204B and JESD204C compatible
 - 8 SerDes transceivers up to 29.5 Gbps
 - Subclass 1 multi-device synchronization
- Package: 17-mm × 17-mm FCBGA, 0.8-mm pitch

2 Applications

- [Radar](#)
- [Seeker front end](#)
- [Defense radio](#)
- Tactical communications infrastructure
- [Wireless communications test](#)

3 Description

The AFE7901 is a high performance, wide bandwidth multi-channel transceiver, integrating four RF sampling transmitter chains and four RF sampling receiver chains. With operation up to 7.4 GHz, this device enables direct RF sampling in the L, S and C-band frequency ranges without the need for additional frequency conversions stages. This improvement in density and flexibility enables high-channel-count, multi-mission systems.

The TX signal paths support interpolation and digital up conversion options that deliver up to 400 MHz of signal bandwidth per TX path using a single or dual digital up converter. The output of the DUCs drives a 12-GSPS DAC (digital to analog converter) with a mixed mode output option to enhance 2nd Nyquist operation. The DAC output includes a variable gain amplifier (TX DSA) with 40-dB range and 1-dB analog and 0.125-dB digital steps.

Package Information

PART NUMBER	PACKAGE ⁽¹⁾	PACKAGE SIZE ⁽²⁾
AFE7901	FC-BGA	17 mm × 17 mm

- (1) For more information, see *Mechanical, Packaging, and Orderable Information*.
- (2) The package size (length × width) is a nominal value and includes pins, where applicable.

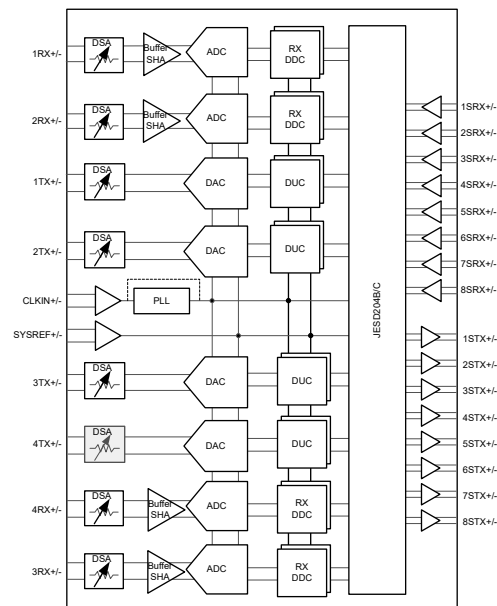

Functional Block Diagram



Table of Contents

1 Features	1	7.7 PLL/VCO/Clock Electrical Characteristics.....	28
2 Applications	1	7.8 Digital Electrical Characteristics.....	30
3 Description	1	7.9 Power Supply Electrical Characteristics.....	32
4 Description (continued)	3	7.10 Timing Requirements.....	34
5 Revision History	3	7.11 Switching Characteristics.....	35
6 Pin Configuration and Functions	4	7.12 Typical Characteristics.....	36
7 Specifications	11	8 Device and Documentation Support	150
7.1 Absolute Maximum Ratings.....	11	8.1 Receiving Notification of Documentation Updates..	150
7.2 ESD Ratings.....	11	8.2 Support Resources.....	150
7.3 Recommended Operating Conditions.....	12	8.3 Trademarks.....	150
7.4 Thermal Information AFE79xx.....	12	8.4 Electrostatic Discharge Caution.....	150
7.5 Transmitter Electrical Characteristics.....	13	8.5 Glossary.....	150
7.6 RF ADC Electrical Characteristics.....	22	9 Mechanical, Packaging, and Orderable Information	150

4 Description (continued)

Each receiver chain includes a 25-dB range DSA (Digital Step Attenuator), followed by a 3-GSPS ADC (analog-to-digital converter). Each receiver channel has an analog peak power detector and various digital power detectors to assist an external or internal autonomous automatic gain controller, and RF overload detectors for device reliability protection. Flexible decimation options provide optimization of signal bandwidth up to 400 MHz using one or two digital down converters (DDCs).

5 Revision History

NOTE: Page numbers for previous revisions may differ from page numbers in the current version.

Changes from April 20, 2023 to June 13, 2023 (from Revision * (April 2023) to Revision A (June 2023))		Page
• Added note 2 to the <i>Package Information</i> table.....		1
• Deleted <i>TX Clock Dither Enabled</i> from all TX Typical Characteristics description.....		78
• Changed 1 st Nyquist zone output to 2 nd Nyquist zone output.....		136

6 Pin Configuration and Functions

	A	B	C	D	E	F	G	H	J	K	L	M	N	P	R	T	U	V	W	Y	
20	VDD1P2 TXCLK	2TXOUT+	2TXOUT-	VDD1P2 TXCLK	VDD1P8TX	1TXOUT-	1TXOUT+	VDD1P8TX	VSSTX	VDD1P2 PLLCLK REF	VDD1P8 PLLVCO	VSSTX	VDD1P8TX	3TXOUT+	3TXOUT-	VDD1P8TX	VDD1P2 TXCLK	4TXOUT-	4TXOUT+	VDD1P2 TXCLK	20
19	VSSTXCLK	VSSTX	VSSTX	VSSTXCLK	VSSTX	VSSTX	VSSTX	VSSTX	PLL LDOUT	SYSREF+	SYSREF-	VSSPLL	VSSTX	VSSTX	VSSTX	VSSTX	VSSTXCLK	VSSTX	VSSTX	VSSTXCLK	19
18	VSSFBCLK	VSSFBCLK	VSSTX	VSSTX	VSSTX	VSSTX	VSSTX	VSSTX	VSSPLL CLKREF	VDD1P2 PLLCLK REF	VDD1P8 PLLCLK REF	VSSPLL CLKREF	VSSTX	VSSTX	VSSTX	VSSTX	VSSTX	VSSTX	VSSFBCLK	VSSFBCLK	18
17	VDD1P8 FBCLK	VSSFB	VSSTX	VDD1P2 TXENC	VSSTXENC	VSSTX	VDD1P8 TXDAC	VDD1P8 TXDAC	VSS PLLXCML	REFCLK+	REFCLK-	VSS PLLXCML	VDD1P8 TXDAC	VDD1P8 TXDAC	VSSTX	VSSTXENC	VDD1P2 TXENC	VSSTX	VSSFB	VDD1P8 FBCLK	17
16	NC	VSSFB	VDD1P8FB	VDD1P2FB	VSSTXENC	GTR_7_SPIB2SEN	GTR_17_SPIB1CLK	GTR_14_SPIB1SEN	VSSPLL FBGML	VDD1P8PLL	VDD1P8PLL	VSSPLL FBGML	GTL_7_ALARM1	GTL_15_SPIASDO	GTL_18_SPIASDO	VSSTXENC	VDD1P2FB	VDD1P8FB	VSSFB	NC	16
15	NC	VSSFB	VDD1P8FB	VDD1P2FB	VDD1P2FB	GTR_15_RESETEZ	GTR_13_TRST	GTR_3_TXTDD1	GTR_9_SPIB2SDO	VDD1P2 PLLXCML	VDD1P2 PLLFBCML	GTL_3_AUX0	GTL_2_ALARM2	GTL_4_SPIACLK	GTL_6_RXTDD2	VDD1P2FB	VDD1P2FB	VDD1P8FB	VSSFB	NC	15
14	VDD1P8 FBCLK	VSSFB	VSSFB	VDD1P2FB	VDD1P2RX	GTR_5_TDO	GTR_18_TDI	GTR_4_TCLK	GTR_2_SPIB2CLK	GTR_8_FBTD01	GTL_8_AUX1	GTL_9_AUX2	GTL_17_SPIASDIO	GTL_1_SPIASEN	GTL_5_SPIASEN	VDD1P2RX	VDD1P2FB	VSSFB	VSSFB	VDD1P8 FBCLK	14
13	VDD1P2RX	VSSRX	VSSRX	VSSRX	VDD1P2RX	VDD1P2RX	GTR_0_RXG5WAP	GTR_6_SPIB2_SDO	GND_ESD	DVDD0P9	DVDD0P9	GND_ESD	GTL_0_GPIO2	GTL_11_AUX3	VDD1P2RX	VDD1P2RX	VSSRX	VSSRX	VSSRX	VDD1P2RX	13
12	1RXIN+	VSSRX	VSSRX	VSSRX	VDD1P2RX	VDD1P2RX	GTR_11_SPIB1_SDO	GTR_1_GPIO1	DGND	DVDD0P9	DVDD0P9	DGND	GTL_13_AUX4	GTL_12_BIST1	VDD1P2RX	VDD1P2RX	VSSRX	VSSRX	VSSRX	3RXIN+	12
11	1RXIN-	VSSRX	VDD1P8RX	VDD1P8RX	VDD1P2RX	VDD1P2RX	GTR_10_TMS	GTR_12_SPIB1_SDO	DGND	DVDD0P9	DVDD0P9	DGND	GTL_14_AUX5	GTL_10_BIST0	VDD1P2RX	VDD1P2RX	VDD1P8RX	VDD1P8RX	VSSRX	3RXIN-	11
10	VDD1P2RX	VSSRX	VDD1P8RX	VDD1P8RX	VDD1P8RX	VDD1P8RX	GBR_6_RXBLNB	GBR_5_SPIB2_SDO	DGND	DVDD0P9	DVDD0P9	DGND	GBL_9_GPIO15	GBL_6_GPIO16	VDD1P8RX	VDD1P8RX	VDD1P8RX	VDD1P8RX	VSSRX	VDD1P2RX	10
9	VDD1P8 RXCLK	VSSRXCLK	VDD1P8RX	VDD1P8RX	VDD1P8RX	VDD1P8RX	GBR_3_SYNCB_OUT0-	GBR_7_SYNCB_OUT0+	DGND	DVDD0P9	DVDD0P9	DGND	GBL_7_SYNCB_OUT1+	GBL_3_SYNCB_OUT1-	VDD1P8RX	VDD1P8RX	VDD1P8RX	VDD1P8RX	VSSRXCLK	VDD1P8 RXCLK	9
8	2RXIN-	VSSRX	VSSRXCLK	GND_ESD	GBR_10_FSPICLKA	VDD1P8RX	GBR_13_GPIO8	GBR_9_SYNCB_IN0+	DGND	DVDD0P9	DVDD0P9	DGND	GBL_9_SYNCB_IN1+	GBL_13_GPIO19	VDD1P8RX	GBL_10_GPIO17	GND_ESD	VSSRXCLK	VSSRX	4RXIN-	8
7	2RXIN+	VSSRX	VSSRXCLK	GND_ESD	GBR_11_RXTDD1	GBR_14_FSPIDA	GBR_12_GPIO7	GBR_17_SYNCB_IN0-	DGND	DVDD0P9	DVDD0P9	DGND	GBL_17_SYNCB_IN1-	GBL_12_FSPICLKD	GBL_14_FSPIDD	GBL_11_GPIO18	GND_ESD	VSSRXCLK	VSSRX	4RXIN+	7
6	VDD1P8 RXCLK	VSSRXCLK	GBR_0_GPIO4	GBR_19_GPIO12	GBR_16_GPIO10	GBR_1_GPIO5	GBR_15_GPIO9	VDD1P8 GPIO	DGND	DVDD0P9	DVDD0P9	DGND	VDD1P8 GPIO	GBL_15_FSPIDC	GBL_1_FBTDD2	GBL_16_RXCLNB	GBL_19_GPIO20	GBL_0_GPIO13	VSSRXCLK	VDD1P8 RXCLK	6
5	VSSRXCLK	VSSRXCLK	GBR_18_GPIO11	GBR_2_RXALNB	GBR_4_GPIO6	GBR_3_FSPICLKB	IFORCE	VSSGPIO	DGND	DVDD0P9	DVDD0P9	DGND	VSSGPIO	VSENSE	GBL_3_GPIO14	GBL_4_RXDLNB	GBL_2_FSPICLKC	GBL_18_TXTDD2	VSSRXCLK	VSSRXCLK	5
4	VSSST	VSSST	1STX+	VDDTOP9	2STX+	VDDA1P8	3STX-	VDDA1P8	4STX-	VSSST	VSSST	5STX-	VDDA1P8	6STX-	VDDA1P8	7STX+	VDDTOP9	8STX+	VSSST	VSSST	4
3	1SRX+	VSSST	1STX-	VDDTOP9	2STX-	VDDA1P8	3STX+	VDDA1P8	4STX+	SERDES_AMUX1	SERDES_AMUX2	5STX+	VDDA1P8	6STX+	VDDA1P8	7STX-	VDDTOP9	8STX-	VSSST	8SRX+	3
2	1SRX-	VSSST	VSSST	VSSST	VSSST	VSSST	VSSST	VSSST	VSSST	DVDD0P9	DVDD0P9	VSSST	VSSST	VSSST	VSSST	VSSST	VSSST	VSSST	VSSST	8SRX-	2
1	VSSST	2SRX+	2SRX-	VSSST	3SRX+	3SRX-	VSSST	4SRX+	4SRX-	VSSST	VSSST	5SRX-	5SRX+	VSSST	6SRX-	6SRX+	VSSST	7SRX-	7SRX+	VSSST	1

TX Outputs
RX Inputs
Clock Inputs
Serial Receivers
Serial Transmitters
MISC Analog
GPIO
0.9V Supplies
1.2V Supplies
1.8V Supplies
GROUND

Figure 6-1. FCBGA Package, 400-Pin (Top View)

Table 6-1. Pin Functions

BALL NAME	BALL NUMBER	TYPE ⁽¹⁾	DESCRIPTION
RF INTERFACES			
NC	A15, A16, Y15, Y16	I	Do not connect.
1RXIN-	A11	I	Receiver Channel 1 RF input: negative terminal. Unused RX inputs can be left open.
1RXIN+	A12	I	Receiver Channel 1 RF input: positive terminal. Unused RX inputs can be left open.
2RXIN-	A8	I	Receiver Channel 2 RF input: negative terminal. Unused RX inputs can be left open.

Table 6-1. Pin Functions (continued)

BALL NAME	BALL NUMBER	TYPE ⁽¹⁾	DESCRIPTION
2RXIN+	A7	I	Receiver Channel 2 RF input: positive terminal. Unused RX inputs can be left open.
3RXIN-	Y11	I	Receiver Channel 3 RF input: negative terminal.
3RXIN+	Y12	I	Receiver Channel 3 RF input: positive terminal. Unused RX inputs can be left open.
4RXIN-	Y8	I	Receiver Channel 4 RF input: negative terminal. Unused RX inputs can be left open.
4RXIN+	Y7	I	Receiver Channel 4 RF input: positive terminal. Unused RX inputs can be left open.
1TXOUT-	F20	O	Transmitter Channel 1 RF output: negative terminal. Connect to 1.8 V when not used.
1TXOUT+	G20	O	Transmitter Channel 1 RF output: positive terminal. Connect to 1.8 V when not used.
2TXOUT-	C20	O	Transmitter Channel 2 RF output: negative terminal. Connect to 1.8 V when not used.
2TXOUT+	B20	O	Transmitter Channel 2 RF output: positive terminal. Connect to 1.8 V when not used.
3TXOUT-	R20	O	Transmitter Channel 3 RF output: negative terminal. Connect to 1.8 V when not used.
3TXOUT+	P20	O	Transmitter Channel 3 RF output: positive terminal. Connect to 1.8 V when not used.
4TXOUT-	V20	O	Transmitter Channel 4 RF output: negative terminal. Connect to 1.8 V when not used.
4TXOUT+	W20	O	Transmitter Channel 4 RF output: positive terminal. Connect to 1.8 V when not used.
DIFFERENTIAL CLOCKS INPUTS			
REFCLK-	L17	I	Reference Clock Inputs: negative terminal
REFCLK+	K17	I	Reference Clock Inputs: positive terminal
SYSREF-	L19	I	SYSREEF inputs: negative terminals
SYSREF+	K19	I	SYSREEF inputs: positive terminals
SerDes CML INTERFACE			
1SRX-	A2	I	CML SerDes Interface Lane 1 input: negative terminal. Unused Serdes inputs can be left open.
1SRX+	A3	I	CML SerDes Interface Lane 1 input: positive terminal. Unused Serdes inputs can be left open.
2SRX-	C1	I	CML SerDes Interface Lane 2 input: negative terminal. Unused Serdes inputs can be left open.
2SRX+	B1	I	CML SerDes Interface Lane 2 input: positive terminal. Unused Serdes inputs can be left open.
3SRX-	F1	I	CML SerDes Interface Lane 3 input: negative terminal
3SRX+	E1	I	CML SerDes Interface Lane 3 input: positive terminal. Unused Serdes inputs can be left open.
4SRX-	J1	I	CML SerDes Interface Lane 4 input: negative terminal
4SRX+	H1	I	CML SerDes Interface Lane 4 input: positive terminal
5SRX-	M1	I	CML SerDes Interface Lane 5 input: negative terminal. Unused Serdes inputs can be left open.
5SRX+	N1	I	CML SerDes Interface Lane 5 input: positive terminal
6SRX-	R1	I	CML SerDes Interface Lane 6 input: negative terminal
6SRX+	T1	I	CML SerDes Interface Lane 6 input: positive terminal. Unused Serdes inputs can be left open.

Table 6-1. Pin Functions (continued)

BALL NAME	BALL NUMBER	TYPE ⁽¹⁾	DESCRIPTION
7SRX–	V1	I	CML SerDes Interface Lane 7 input: negative terminal
7SRX+	W1	I	CML SerDes Interface Lane 7 input: positive terminal. Unused Serdes inputs can be left open.
8SRX–	Y2	I	CML SerDes Interface Lane 8 input: negative terminal
8SRX+	Y3	I	CML SerDes Interface Lane 8 input: positive terminal. Unused Serdes inputs can be left open.
1STX–	C3	O	CML SerDes Interface Lane 1 output: negative terminal. Unused Serdes outputs can be left open.
1STX+	C4	O	CML SerDes Interface Lane 1 output: positive terminal. Unused Serdes outputs can be left open.
2STX–	E3	O	CML SerDes Interface Lane 2 output: negative terminal. Unused Serdes outputs can be left open.
2STX+	E4	O	CML SerDes Interface Lane 2 output: positive terminal. Unused Serdes outputs can be left open.
3STX–	G4	O	CML SerDes Interface Lane 3 output: negative terminal. Unused Serdes outputs can be left open.
3STX+	G3	O	CML SerDes Interface Lane 3 output: positive terminal. Unused Serdes outputs can be left open.
4STX–	J4	O	CML SerDes Interface Lane 4 output: negative terminal. Unused Serdes outputs can be left open.
4STX+	J3	O	CML SerDes Interface Lane 4 output: positive terminal. Unused Serdes outputs can be left open.
5STX–	M4	O	CML SerDes Interface Lane 5 output: negative terminal. Unused Serdes outputs can be left open.
5STX+	M3	O	CML SerDes Interface Lane 5 output: positive terminal. Unused Serdes outputs can be left open.
6STX–	P4	O	CML SerDes Interface Lane 6 output: negative terminal. Unused Serdes outputs can be left open.
6STX+	P3	O	CML SerDes Interface Lane 6 output: positive terminal. Unused Serdes outputs can be left open.
7STX–	T3	O	CML SerDes Interface Lane 7 output: negative terminal. Unused Serdes outputs can be left open.
7STX+	T4	O	CML SerDes Interface Lane 7 output: positive terminal. Unused Serdes outputs can be left open.
8STX–	V3	O	CML SerDes Interface Lane 8 output: negative terminal. Unused Serdes outputs can be left open.
8STX+	V4	O	CML SerDes Interface Lane 8 output: positive terminal. Unused Serdes outputs can be left open.
GPIO FUNCTIONS			
GBL_0_GPIO13	V6	I/O	GPIO.
GBL_1_FBTDD2	R6	I/O	Default location of FB TDD2 input signal.
GBL_2_FSPICLK	U5	I/O	Default and recommended location of FSPI C clock (FSPI for factory use only, available as generic GPIO).
GBL_3_GPIO14	R5	I/O	GPIO.
GBL_4_RXDLNB	T5	I/O	Default location of RX channel D AGC LNA Bypass output signal.
GBL_5_GPIO15	N10	I/O	GPIO.
GBL_6_GPIO16	P10	I/O	GPIO.

Table 6-1. Pin Functions (continued)

BALL NAME	BALL NUMBER	TYPE ⁽¹⁾	DESCRIPTION
GBL_7_SYNCB_OUT1+	N9	I/O	Default location of JESD Syncl 1 output differential positive terminal.
GBL_8_SYNCB_IN1+	N8	I/O	Default location of JESD Syncl 1 input differential positive terminal.
GBL_9_SYNCB_OUT1–	P9	I/O	Default location of JESD Syncl 1 output differential negative terminal.
GBL_10_GPIO17	T8	I/O	GPIO.
GBL_11_GPIO18	T7	I/O	GPIO.
GBL_12_FSPICLKD	P7	I/O	Default and recommended location of FSPI D clock (FSPI for factory use only, available as generic GPIO).
GBL_13_GPIO19	P8	I/O	GPIO.
GBL_14_FSPIDD	R7	I/O	Default and recommended location of FSPI D data (FSPI for factory use only, available as generic GPIO).
GBL_15_FSPIDC	P6	I/O	Default and recommended location of FSPI C clock (FSPI for factory use only, available as generic GPIO).
GBL_16_RXCLNB	T6	I/O	Default location of RX channel C AGC LNA Bypass output signal.
GBL_17_SYNCB_IN1–	N7	I/O	Default location of JESD Syncl 1 input differential negative terminal.
GBL_18_TXTDD2	V5	I/O	Default location of TX TDD2 input signal.
GBL_19_GPIO20	U6	I/O	GPIO.
GBR_0_GPIO4	C6	I/O	GPIO.
GBR_1_GPIO5	F6	I/O	GPIO.
GBR_2_RXALNB	D5	I/O	Default location of RX channel A AGC LNA Bypass output signal.
GBR_3_FSPICLKB	F5	I/O	Default and recommended location of FSPI B clock (FSPI for factory use only, available as generic GPIO).
GBR_4_GPIO6	E5	I/O	GPIO.
GBR_5_FSPIDB	H10	I/O	Default and recommended location of FSPI B data (FSPI for factory use only, available as generic GPIO).
GBR_6_RXBLNB	G10	I/O	Default location of RX channel B AGC LNA Bypass output signal.
GBR_7_SYNCB_OUT0+	H9	I/O	Default location of JESD Syncl 0 output differential positive terminal.
GBR_8_SYNCB_IN0+	H8	I/O	Default location of JESD Syncl 0 input differential positive terminal.
GBR_9_SYNCB_OUT0–	G9	I/O	Default location of JESD Syncl 0 output differential negative terminal.
GBR_10_FSPICLKA	E8	I/O	Default location of FSPI A clock (FSPI for factory use only, available as generic GPIO).
GBR_11_RXTDD1	E7	I/O	Default location of RX TDD1 input signal.
GBR_12_GPIO7	G7	I/O	GPIO.
GBR_13_GPIO8	G8	I/O	GPIO.
GBR_14_FSPIDA	F7	I/O	Default and recommended location of FSPI A clock (FSPI for factory use only, available as generic GPIO).
GBR_15_GPIO9	G6	I/O	GPIO.
GBR_16_GPIO10	E6	I/O	GPIO.
GBR_17_SYNCB_IN0–	H7	I/O	Default location of JESD Syncl 0 input differential negative terminal.
GBR_18_GPIO11	C5	I/O	GPIO.
GBR_19_GPIO12	D6	I/O	GPIO.

Table 6-1. Pin Functions (continued)

BALL NAME	BALL NUMBER	TYPE ⁽¹⁾	DESCRIPTION
GTL_0_GPIO2	N13	I/O	GPIO.
GTL_1_SLEEP	P14	I/O	Default location of Sleep input signal.
GTL_2_ALARM2	N15	I/O	Default location of Alarm 2 output signal.
GTL_3_AUX0	M15	I/O	GPIO or auxiliary low-speed ADC input 0
GTL_4_SPIACLK	P15	I/O	Fixed Location of SPI A Clock.
GTL_5_SPIASEN	R14	I/O	Fixed Location of SPI A Send Enable.
GTL_6_RXTDD2	R15	I/O	Default location of RX TDD2 input signal.
GTL_7_ALARM1	N16	I/O	Default location of Alarm 1 output signal.
GTL_8_AUX1	L14	I/O	GPIO or auxiliary low-speed ADC input 1.
GTL_9_AUX2	M14	I/O	GPIO or auxiliary low-speed ADC input 2.
GTL_10_BIST0	P11	I/O	Fixed Location for BIST0 Function. Set low when using JTAG, set high for normal operation.
GTL_11_AUX3	P13	I/O	GPIO or auxiliary low-speed ADC input 3.
GTL_12_BIST1	P12	I/O	Fixed Location for BIST1 Function. Set high when using JTAG, set low for normal operation.
GTL_13_AUX4	N12	I/O	GPIO or auxiliary low-speed ADC input 4.
GTL_14_AUX5	N11	I/O	GPIO or auxiliary low-speed ADC input 5.
GTL_15_GPIO3	P16	I/O	GPIO.
GTL_17_SPIASDIO	N14	I/O	Fixed Location of SPI A Serial Data Input (3- and 4-wire mode) or Output (3 wire mode only).
GTL_18_SPIASDO	R16	I/O	Fixed Location of SPI A Serial Data Output in 4-wire mode.
GTR_0_RXGSWAP	G13	I/O	Default location of RX gain swap input.
GTR_1_GPIO1	H12	I/O	GPIO.
GTR_2_SPIB2CLK	J14	I/O	Default and recommended location of SPI B2 clock.
GTR_3_TXTDD1	H15	I/O	Default location of TX TDD1 input signal.
GTR_4_TCLK	H14	I/O	Fixed location for JTAG Test Clock.
GTR_5_TDO	F14	I/O	Fixed location for JTAG Test Data Out.
GTR_6_SPIB2_SDIO	H13	I/O	Default and recommended location of SPI B2 serial data input/output.
GTR_7_SPIB2SEN	F16	I/O	Default and recommended location of SPI B2 enable input.
GTR_8_FBTDD1	K14	I/O	Default location of FB TDD1 input signal.
GTR_9_SPIB2SDO	J15	I/O	Default and recommended location of SPI B2 serial data output (4-wire mode)
GTR_10_TMS	G11	I/O	Fixed location for JTAG Test Mode Select.
GTR_11_SPIB1_SDO	G12	I/O	Default and recommended location of SPI B1 serial data output (4-wire mode).
GTR_12_SPIB1_SDIO	H11	I/O	Default and recommended location of SPI B1 serial data input/output.
GTR_13_TRST	G15	I/O	Fixed location for JTAG Test Reset. Must be pulled low when the JTAG port is not used.
GTR_14_SPIB1SEN	H16	I/O	Default and recommended location of SPI B1 enable input.
GTR_15_RESETZ	F15	I/O	Fixed Location for reset function. Chip Reset to default register settings.
GTR_17_SPIB1CLK	G16	I/O	Default and recommended location of SPI B1 clock.
GTR_18_TDI	G14	I/O	Fixed location for JTAG Test Data Input.
POWER SUPPLIES			
DVDD	K2, K5, K6, K7, K8, K9, K10, K11, K12, K13, L2, L5, L6, L7, L8, L9, L10, L11, L12, L13	—	0.9-V digital power supply

Table 6-1. Pin Functions (continued)

BALL NAME	BALL NUMBER	TYPE ⁽¹⁾	DESCRIPTION
VDD1P2FB	D14, D15, D16, E15, U14, U15, U16, T15	—	1.2-V supply for FB ADCs.
VDD1P8FB	C15, C16, V15, V16	—	1.8-V supply for FB ADC.
VDD1P8FBCLK	A14, A17, Y17, Y14	—	1.8-V supply for FB ADC clock.
VDD1P2PLLCLKREF	K20, K18, L18	—	1.2-V supply for PLL.
VDDPLL1P2FBCML	L15	—	1.2-V supply for PLL clock distribution to FB ADC.
VDDPLL1P2RXCML	K15	—	1.2-V supply for clock distribution to RX ADC.
VDD1P8PLL	K16, L16	—	1.8-V supply for PLL.
VDD1P8PLLVCO	L20	—	1.8-V supply for PLL/VCO. This is a sensitive net and requires extra care in layout.
VDD1P2RX	A10, A13, E11, E12, E13, E14, F11, F12, F13, R11, R12, R13, T11, T12, T13, T14, Y10, Y13	—	1.2-V supply for RX ADCs.
VDD1P8RX	C9, C10, C11, D9, D10, D11, E9, E10, F8, F9, F10, R8, R9, R10, T9, T10, U9, U10, U11, V9, V10, V11	—	1.8-V supply for RX ADCs.
VDD1P8RXCLK	A6, A9, Y6, Y9	—	1.8-V supply for RX ADC clocks.
VDD1P2TXENC	D17, U17	—	1.2-V supply for DAC encoder.
VDD1P2TXCLK	A20, D20, U20, Y20	—	1.2-V supply for DAC clock.
VDD1P8TX	E20, H20, N20, T20	—	1.8-V supply for DAC.
VDD1P8TXDAC	G17, H17, N17, P17	—	1.8-V supply for DAC.
VDD1P8GPIO	H6, N6	—	1.8-V supply for GPIO.
VDDA1P8	F3, F4, H3, H4, R3, R4, N3, N4	—	SerDes analog 1.8-V power supply.
VDDT0P9	D3, D4, U3, U4	—	SerDes digital 0.9-V power supply.
GROUND			
DGND	J5, J6, J7, J8, J9, J10, J11, J12, M5, M6, M7, M8, M9, M10, M11, M12	—	Digital core ground
VSSGPIO	H5, N5	—	GPIO ground.
VSSFB	B14, B15, B16, B17, C14, V14, W14, W15, W16, W17	—	Ground for FB ADC supply.
VSSFBCLK	A18, B18, W18, Y18	—	Ground for FB ADC 1.8-V clock supply.
GND_ESD	D7, D8, J13, M13, U7, U8	—	Ground for ESD protection circuits.
VSSRX	B7, B8, B10, B11, B12, C12, D12, B13, C13, D13, W7, W8, W10, W11, W13, U12, V12, W12, U13, V13	—	Ground for RX ADC.
VSSRXCLK	A5, B5, B6, B9, C7, C8, W5, W6, W9, Y5, V7, V8	—	Ground for RX ADC clocks.
VSSTX	B19, C17, C18, C19, D18, E18, E19, F17, F18, F19, G18, G19, H18, H19, J20, M20, N18, N19, P18, P19, R17, R18, R19, T18, T19, U18, V17, V18, V19, W19	—	Ground for TX DAC.
VSSTXENC	E16, E17, T16, T17	—	Ground for TX DAC encoder.
VSSTXCLK	A19, D19, U19, Y19	—	Ground for TX DAC clock.
VSSPLL	M19	—	Ground for PLL.
VSSPLLFBCML	J16, M16	—	Ground for FB ADC clock.

Table 6-1. Pin Functions (continued)

BALL NAME	BALL NUMBER	TYPE ⁽¹⁾	DESCRIPTION
VSSPLLCLKREF	J18, M18	—	Ground for CLKREF PLL.
VSSPLLRCML	J17, M17	—	Ground for RX ADC clock.
VSST	A1, A4, B2, B3, B4, C2, D1, D2, E2, F2, G1, G2, H2, J2, K1, K4, L1, L4, M2, N2, P1, P2, R2, T2, U1, U2, V2, W2, W3, W4, Y1, Y4	—	SerDes ground.
OTHERS			
IFORCE	G5	—	Reserved for TI use only. Do not connect.
PLL_LDOUT	J19	—	Connect with 100-nF capacitor to GND
SerDes_AMUX1	K3	—	Analog test pin for SerDes lane 1-4, can be left floating
SerDes_AMUX2	L3	—	Analog test pin for SerDes lane 5-8, can be left floating
VSENSE	P5	—	Process test: sense voltage (TI use only). Do not connect.

(1) Signal Types: I = Input, O = Output, I/O = Input or Output.

7 Specifications

7.1 Absolute Maximum Ratings

over operating free-air temperature range (unless otherwise noted)⁽¹⁾

		MIN	MAX	UNIT
Supply Voltage Range	DVDD0P9, VDDT0P9	-0.3	1.2	V
	VDD1P2RX, VDD1P2TXCLK, VDD1P2TXENC, VDD1P2PLL, VDD1P2PLLCLKREF, VDD1P2FB, VDD1P2FBCML, VDD1P2RXCML	-0.3	1.4	V
	VDD1P8RX, VDD1P8RXCLK, VDD1P8TX, VDD1P8TXDAC, VDD1P8TXENC, VDD1P8PLL, VDD1P8PLLVC0, VDD1P8FB, VDD1P8FBCLK, VDD1P8GPIO, VDDA1P8	-0.5	2.1	V
Pin Voltage Range	{1/2/3/4}RXIN+/-	-0.5	VDDR1P8+0.3	V
	1FBIN+/-, 2FB+/-	-0.5	VDDFB1P8+0.3	V
	{1/2/3/4}TXOUT+/-	-0.5	VDDTX1P8+0.3	V
	REFCLK+/-, SYSREF+/-	-0.3	1.4	V
	{1:8}SRX+/-	-0.3	1.4	V
	{1:8}STX+/-	-0.3	1.4	V
	GPIO{B/C/D/E}x, SPICLK, SPISDIO, SPISDO, SPISEN, RESETZ, BISTB0, BISTB1	-0.5	VDD1P8GPIO + 0.3	V
	IFORCE, VSENSE	-0.3	VDDCLK1P8 + 0.3	V
SRDAMUX1, SRDAMUX2	-0.3	VDDA1P8+0.3	V	
Peak Input Current	any input		20	mA
T _J	Junction temperature		150	°C
T _{stg}	Storage temperature	-65	150	°C

- (1) Stresses beyond those listed under *Absolute Maximum Rating* may cause permanent damage to the device. These are stress ratings only, which do not imply functional operation of the device at these or any other conditions beyond those indicated under *Recommended Operating Conditions*. Exposure to absolute-maximum-rated conditions for extended periods may affect device reliability.

7.2 ESD Ratings

			VALUE	UNIT
V _(ESD)	Electrostatic discharge	Human body model (HBM), per ANSI/ESDA/ JEDEC JS-001, all pins ⁽¹⁾	1000	V
		Charged device model (CDM), per JEDEC specification JESD22-C101, all pins	150	

- (1) JEDEC document JEP155 states that 500-V HBM allows safe manufacturing with a standard ESD control process.

7.3 Recommended Operating Conditions

over operating free-air temperature range (unless otherwise noted)

		MIN	NOM	MAX	UNIT
DVDD0P9, VDDT0P9	Supply voltage 0.9V	0.9	0.925	0.95	V
VDD1P2{RX/TXCLK/TXENC/FB/PLL/ PLLCLKREF/FBCML/RXCML}	Supply voltage 1.2V	1.15	1.2	1.25	V
VDD1P8{RX/RXCLK/TX/TXDAC/ TXENC/PLL/PLLVCO/FB/FBCLK/ GPIO}, VDDA1P8	Supply voltage 1.8V	1.75	1.8	1.85	V
T _A	Ambient temperature	-40		85	°C
T _J	Operating Junction Temperature			110 ⁽¹⁾	°C
	Maximum Operating Junction Temperature	125			°C

- (1) Prolonged use at or above this junction temperature can increase the device failure-in-time (FIT) rate. Refer to [SBAA403 application note](#) for additional details

7.4 Thermal Information AFE79xx

THERMAL METRIC ⁽¹⁾		17mmx17mm FC-BGA	UNIT
		400 PINS	
R _{θJA}	Junction-to-ambient thermal resistance	16.2	°C/W
R _{θJC(top)}	Junction-to-case (top) thermal resistance	0.42	°C/W
R _{θJB}	Junction-to-board thermal resistance	4.85	°C/W
Ψ _{JT}	Junction-to-top characterization parameter	0.12	°C/W
Ψ _{JB}	Junction-to-board characterization parameter	4.6	°C/W

- (1) For more information about traditional and new thermal metrics, see the [Semiconductor and IC Package Thermal Metrics](#) application report.

7.5 Transmitter Electrical Characteristics

Typical values at $T_A = +25^\circ\text{C}$, full temperature range is $T_{A,\text{MIN}} = -40^\circ\text{C}$ to $T_{J,\text{MAX}} = +110^\circ\text{C}$; TX Input Rate = 491.52MSPS, $f_{\text{DAC}} = 11796.48\text{MSPS}$ below 6GHz and $f_{\text{DAC}} = 9000\text{MSPS}$ above 6GHz; PLL clock mode below 6GHz output frequency and External clock mode above 6GHz output frequency; interleave mode for 1st Nyquist, non-interleave mix mode for 2nd Nyquist, nominal power supplies; 1 tone at -1 dBFS; DSA Attenuation = 0dB, unless otherwise noted.

PARAMETER		TEST CONDITIONS	MIN	TYP	MAX	UNIT
DAC_{RES}	DAC resolution			14		bits
f_{RFout}	RF output frequency range	$f_{\text{DAC}} = 12\text{ GSPS}$, 1 st Nyquist	5		6000	MHz
		$f_{\text{DAC}} = 9\text{ GSPS}$, 1 st Nyquist	5		4500	
		$f_{\text{DAC}} = 9\text{ GSPS}$, 2 nd Nyquist	4500		7400	
		$f_{\text{DAC}} = 6\text{ GSPS}$, 1 st Nyquist	5		3000	
		$f_{\text{DAC}} = 6\text{ GSPS}$, 2 nd Nyquist	3000		6000	
$P_{\text{max_FS}}$	Max Full Scale Output Power, max gain 1 tone, at device pins	$f_{\text{out}} = 10\text{ MHz}$, $f_{\text{DAC}} = 6\text{ GSPS}$, -0.1dBFS		6.5		dBm
		$f_{\text{out}} = 30\text{ MHz}$, $f_{\text{DAC}} = 6\text{ GSPS}$, -0.1dBFS		6.5		dBm
		$f_{\text{out}} = 400\text{ MHz}$, $f_{\text{DAC}} = 6\text{ GSPS}$, -0.1dBFS		5.6		dBm
		$f_{\text{out}} = 850\text{ MHz}$, $f_{\text{DAC}} = 5898.24\text{ MSPS}$, -0.5dBFS		4.3		dBm
		$f_{\text{out}} = 1800\text{ MHz}$, $f_{\text{DAC}} = 5898.24\text{ MSPS}$, -0.5dBFS		3.2		dBm
		$f_{\text{out}} = 2600\text{ MHz}$, $f_{\text{DAC}} = 8847.36\text{ MSPS}$, -0.5dBFS		2.3		dBm
		$f_{\text{out}} = 3500\text{ MHz}$, -0.5dBFS		2.9		dBm
		$f_{\text{out}} = 4900\text{ MHz}$, -0.5dBFS		-0.6		dBm
		$f_{\text{out}} = 3500\text{ MHz}$, $f_{\text{DAC}} = 5898.24\text{ MSPS}$, -0.5dBFS, straight mode		-2.3		dBm
		$f_{\text{out}} = 4900\text{ MHz}$, $f_{\text{DAC}} = 5898.24\text{ MSPS}$, -0.5dBFS, straight mode		-3.4		dBm
		$f_{\text{out}} = 4900\text{ MHz}$, $f_{\text{DAC}} = 8847.36\text{ MSPS}$, -0.5dBFS, straight mode		-3.9		dBm
R_{TERM}	Output termination resistor	Default setting		100		Ω
$\text{ATT}_{\text{range}}$	DSA Attenuation range			40		dB
ATT_{step}	DSA Analog Attenuation step			1.0		dB
	DSA Attenuation step accuracy (DNL) (2)	0 < Atten < 40dB, after calibration		± 0.1		dB
		0 < Atten < 40dB, before calibration			± 0.2	
ATT_{step}	DSA Gain Steps Phase accuracy, any 8dB range(2)	$f_{\text{out}} = 30\text{ MHz}$		± 1		deg
		$f_{\text{out}} = 400\text{ MHz}$		± 1		deg
		$f_{\text{out}} = 850\text{ MHz}$		± 1		deg
		$f_{\text{out}} = 1800\text{ MHz}$		± 1		deg
		$f_{\text{out}} = 2600\text{ MHz}$		± 1		deg
		$f_{\text{out}} = 3500\text{ MHz}$		± 1		
		$f_{\text{out}} = 4900\text{ MHz}$		± 1		deg
G_{flat}	Gain flatness	any 20MHz		0.1		dB
		600MHz BW, $F_{\text{out}} < 4.9\text{ G}$		1.2		

7.5 Transmitter Electrical Characteristics (continued)

Typical values at $T_A = +25^\circ\text{C}$, full temperature range is $T_{A,\text{MIN}} = -40^\circ\text{C}$ to $T_{J,\text{MAX}} = +110^\circ\text{C}$; TX Input Rate = 491.52MSPS, $f_{\text{DAC}} = 11796.48\text{MSPS}$ below 6GHz and $f_{\text{DAC}} = 9000\text{MSPS}$ above 6GHz; PLL clock mode below 6GHz output frequency and External clock mode above 6GHz output frequency; interleave mode for 1st Nyquist, non-interleave mix mode for 2nd Nyquist, nominal power supplies; 1 tone at -1 dBFS; DSA Attenuation = 0dB, unless otherwise noted.

PARAMETER		TEST CONDITIONS	MIN	TYP	MAX	UNIT
IMD3	3rd Order Intermodulation distortion	$f_{\text{DAC}} = 6\text{ GSPS}$, $f_{\text{out}} = 5\text{MHz}$ $\pm 1\text{MHz}$, -7dBFS each tone		-48		dBc
		$f_{\text{DAC}} = 6\text{ GSPS}$, $f_{\text{out}} = 30\text{MHz}$ $\pm 1\text{MHz}$, -7dBFS each tone		-47		dBc
		$f_{\text{DAC}} = 6\text{ GSPS}$, $f_{\text{out}} = 400\text{MHz}$ $\pm 2\text{MHz}$, -7dBFS each tone		-51		dBc
		$f_{\text{out}} = 850\text{MHz} \pm 10\text{MHz}$, -7dBFS each tone		-61		dBc
		$f_{\text{out}} = 1800\text{MHz} \pm 10\text{MHz}$, -7dBFS each tone		-62		dBc
		$f_{\text{out}} = 2600\text{MHz} \pm 10\text{MHz}$, -7dBFS each tone		-64		dBc
		$f_{\text{out}} = 3500\text{MHz} \pm 10\text{MHz}$, -7dBFS each tone		-63		dBc
		$f_{\text{out}} = 4900\text{MHz} \pm 10\text{MHz}$, -7dBFS each tone		-64		dBc
		$f_{\text{out}} = 5\text{MHz} \pm 1\text{MHz}$, -13dBFS each tone		-72		dBc
		$f_{\text{DAC}} = 6\text{ GSPS}$, $f_{\text{out}} = 30\text{MHz}$ $\pm 1\text{MHz}$, -13dBFS each tone		-71		dBc
		$f_{\text{DAC}} = 6\text{ GSPS}$, $f_{\text{out}} = 400\text{MHz}$ $\pm 2\text{MHz}$, -13dBFS each tone		-72		dBc
		$f_{\text{out}} = 850\text{MHz} \pm 10\text{MHz}$, -13dBFS each tone		-73		dBc
		$f_{\text{out}} = 1800\text{MHz} \pm 10\text{MHz}$, -13dBFS each tone		-75		dBc
		$f_{\text{out}} = 2600\text{MHz} \pm 10\text{MHz}$, -13dBFS each tone		-79		dBc
		$f_{\text{out}} = 3500\text{MHz} \pm 10\text{MHz}$, -13dBFS each tone		-77		dBc
$f_{\text{out}} = 4900\text{MHz} \pm 10\text{MHz}$, -13dBFS each tone		-77		dBc		
SFDR	Spurious Free Dynamic Range (within Nyquist zone)	$f_{\text{out}} = 30\text{ MHz}$, $f_{\text{DAC}} = 6000\text{ MSPS}$, interleave mode, 20Gbps SerDes rate		45		dBc
		$f_{\text{out}} = 400\text{ MHz}$, $f_{\text{DAC}} = 6000\text{ MSPS}$, interleave mode, 20Gbps SerDes rate		48		dBc
		$f_{\text{out}} = 850\text{ MHz}$, $f_{\text{DAC}} = 11796.48\text{ MSPS}$		62		dBc
		$f_{\text{out}} = 1800\text{ MHz}$, $f_{\text{DAC}} = 11796.48\text{ MSPS}$		56		dBc
		$f_{\text{out}} = 2600\text{ MHz}$, $f_{\text{DAC}} = 11796.48\text{ MSPS}$		39		dBc
		$f_{\text{out}} = 3500\text{ MHz}$, $f_{\text{DAC}} = 11796.48\text{ MSPS}$		42		dBc
		$f_{\text{out}} = 4900\text{ MHz}$, $f_{\text{DAC}} = 11796.48\text{ MSPS}$		60		dBc

7.5 Transmitter Electrical Characteristics (continued)

Typical values at $T_A = +25^\circ\text{C}$, full temperature range is $T_{A,MIN} = -40^\circ\text{C}$ to $T_{J,MAX} = +110^\circ\text{C}$; TX Input Rate = 491.52MSPS, $f_{DAC} = 11796.48\text{MSPS}$ below 6GHz and $f_{DAC} = 9000\text{MSPS}$ above 6GHz; PLL clock mode below 6GHz output frequency and External clock mode above 6GHz output frequency; interleave mode for 1st Nyquist, non-interleave mix mode for 2nd Nyquist, nominal power supplies; 1 tone at -1 dBFS; DSA Attenuation = 0dB, unless otherwise noted.

PARAMETER		TEST CONDITIONS	MIN	TYP	MAX	UNIT
$f_s/2 - f_{OUT}$	Interleaving Image	$f_{DAC} = 5898.24\text{MSPS}$, interleave mode		-47		dBc
		$f_{DAC} = 8847.36\text{ MSPS}$, interleave mode		-43		dBc
		$f_{DAC} = 11796.48\text{MSPS}$, interleave mode		-43		dBc
HD2	2 nd Harmonic Distortion (within Nyquist zone)	$f_{DAC} = 6\text{ GSPS}$, $f_{out} = 5\text{ MHz}$		-72		dBc
		$f_{DAC} = 6\text{ GSPS}$, $f_{out} = 30\text{ MHz}$		-75		dBc
		$f_{DAC} = 6\text{ GSPS}$, $f_{out} = 100\text{ MHz}$		-73		dBc
		$f_{out} = 400\text{ MHz}$		-46		dBc
		$f_{out} = 850\text{ MHz}$		-65		dBc
		$f_{out} = 1800\text{ MHz}$		-68		dBc
		$f_{out} = 2600\text{ MHz}$		-47		dBc
		$f_{out} = 3500\text{ MHz}$		-59		dBc
		$f_{out} = 4900\text{ MHz}$		-48		dBc
		$f_{out} = 850\text{ MHz}$, $A_{OUT} = -12\text{dBFS}$		-74		dBc
		$f_{out} = 1800\text{ MHz}$, $A_{OUT} = -12\text{dBFS}$		-67		dBc
		$f_{out} = 2600\text{ MHz}$, $A_{OUT} = -12\text{dBFS}$		-58		dBc
		$f_{out} = 3500\text{ MHz}$, $A_{OUT} = -12\text{dBFS}$		-69		dBc
$f_{out} = 4900\text{ MHz}$, $A_{OUT} = -12\text{dBFS}$		-59		dBc		
HD3	3 rd Harmonic Distortion (within Nyquist zone)	$f_{DAC} = 6\text{ GSPS}$, $f_{out} = 5\text{ MHz}$		-46		dBc
		$f_{DAC} = 6\text{ GSPS}$, $f_{out} = 30\text{ MHz}$		-48		dBc
		$f_{DAC} = 6\text{ GSPS}$, $f_{out} = 100\text{ MHz}$		-49		dBc
		$f_{DAC} = 6\text{ GSPS}$, $f_{out} = 400\text{ MHz}$		-49		dBc
		$f_{out} = 850\text{ MHz}$		-56		dBc
		$f_{out} = 1800\text{ MHz}$		-58		dBc
		$f_{out} = 2600\text{ MHz}$		-60		dBc
		$f_{out} = 3500\text{ MHz}$		-63		dBc
		$f_{out} = 4900\text{ MHz}$		-66		dBc
		$f_{DAC} = 6\text{ GSPS}$, $f_{out} = 5\text{ MHz}$, $A_{OUT} = -12\text{dBFS}$		-83		dBc
		$f_{DAC} = 6\text{ GSPS}$, $f_{out} = 30\text{ MHz}$, $A_{OUT} = -12\text{dBFS}$		-83		dBc
		$f_{DAC} = 6\text{ GSPS}$, $f_{out} = 100\text{ MHz}$, $A_{OUT} = -12\text{dBFS}$		-82		dBc
		$f_{DAC} = 6\text{ GSPS}$, $f_{out} = 400\text{ MHz}$, $A_{OUT} = -12\text{dBFS}$		-79		dBc
		$f_{out} = 850\text{ MHz}$, $A_{OUT} = -12\text{dBFS}$		-87		dBc
		$f_{out} = 1800\text{ MHz}$, $A_{OUT} = -12\text{dBFS}$		-84		dBc
		$f_{out} = 2600\text{ MHz}$, $A_{OUT} = -12\text{dBFS}$		-79		dBc
		$f_{out} = 3500\text{ MHz}$, $A_{OUT} = -12\text{dBFS}$		-84		dBc
		$f_{out} = 4900\text{ MHz}$, $A_{OUT} = -12\text{dBFS}$		-88		dBc

7.5 Transmitter Electrical Characteristics (continued)

Typical values at $T_A = +25^\circ\text{C}$, full temperature range is $T_{A,\text{MIN}} = -40^\circ\text{C}$ to $T_{J,\text{MAX}} = +110^\circ\text{C}$; TX Input Rate = 491.52MSPS, $f_{\text{DAC}} = 11796.48\text{MSPS}$ below 6GHz and $f_{\text{DAC}} = 9000\text{MSPS}$ above 6GHz; PLL clock mode below 6GHz output frequency and External clock mode above 6GHz output frequency; interleave mode for 1st Nyquist, non-interleave mix mode for 2nd Nyquist, nominal power supplies; 1 tone at -1 dBFS; DSA Attenuation = 0dB, unless otherwise noted.

PARAMETER		TEST CONDITIONS	MIN	TYP	MAX	UNIT
HD _n , n >= 4	Harmonic Distortion n >= 4 (within Nyquist zone)	$f_{\text{DAC}} = 6 \text{ GSPS}$, $f_{\text{out}} = 5 \text{ MHz}$		-58		dBc
		$f_{\text{DAC}} = 6 \text{ GSPS}$, $f_{\text{out}} = 30 \text{ MHz}$		-60		dBc
		$f_{\text{DAC}} = 6 \text{ GSPS}$, $f_{\text{out}} = 100 \text{ MHz}$		-61		dBc
		$f_{\text{DAC}} = 6 \text{ GSPS}$, $f_{\text{out}} = 400 \text{ MHz}$		-50		dBc
		$f_{\text{out}} = 850 \text{ MHz}$		-85		dBc
		$f_{\text{out}} = 1800 \text{ MHz}$		-90		dBc
		$f_{\text{out}} = 2600 \text{ MHz}$		-84		dBc
		$f_{\text{out}} = 3500 \text{ MHz}$		-86		dBc
		$f_{\text{out}} = 4900 \text{ MHz}$		-87		dBc
		$f_{\text{DAC}} = 6 \text{ GSPS}$, $f_{\text{out}} = 5 \text{ MHz}$, $A_{\text{OUT}} = -12\text{dBFS}$		-92		dBc
		$f_{\text{DAC}} = 6 \text{ GSPS}$, $f_{\text{out}} = 30 \text{ MHz}$, $A_{\text{OUT}} = -12\text{dBFS}$		-94		dBc
		$f_{\text{DAC}} = 6 \text{ GSPS}$, $f_{\text{out}} = 100 \text{ MHz}$, $A_{\text{OUT}} = -12\text{dBFS}$		-93		dBc
		$f_{\text{DAC}} = 6 \text{ GSPS}$, $f_{\text{out}} = 400 \text{ MHz}$, $A_{\text{OUT}} = -12\text{dBFS}$		-85		dBc
		$f_{\text{out}} = 850 \text{ MHz}$, $A_{\text{OUT}} = -12\text{dBFS}$		-89		dBc
		$f_{\text{out}} = 1800 \text{ MHz}$, $A_{\text{OUT}} = -12\text{dBFS}$		-92		dBc
		$f_{\text{out}} = 2600 \text{ MHz}$, $A_{\text{OUT}} = -12\text{dBFS}$		-87		dBc
		$f_{\text{out}} = 3500 \text{ MHz}$, $A_{\text{OUT}} = -12\text{dBFS}$		-88		dBc
		$f_{\text{out}} = 4900 \text{ MHz}$, $A_{\text{OUT}} = -12\text{dBFS}$		-89		dBc
SFDR +/- 250 MHz	Spurious Free Dynamic Range within +/- 250 MHz	$f_{\text{DAC}} = 6 \text{ GSPS}$, $f_{\text{out}} = 400 \text{ MHz}$		87		dBc
		$f_{\text{out}} = 850 \text{ MHz}$, $f_{\text{DAC}} = 11796.48 \text{ MSPS}$		84		dBc
		$f_{\text{out}} = 1800 \text{ MHz}$, $f_{\text{DAC}} = 11796.48 \text{ MSPS}$		78		dBc
		$f_{\text{out}} = 2600 \text{ MHz}$, $f_{\text{DAC}} = 11796.48 \text{ MSPS}$		80		dBc
		$f_{\text{out}} = 3500 \text{ MHz}$, $f_{\text{DAC}} = 11796.48 \text{ MSPS}$		81		dBc
		$f_{\text{out}} = 4900 \text{ MHz}$, $f_{\text{DAC}} = 11796.48 \text{ MSPS}$		74		dBc
$f_s/4$	Fixed Spur	$f_{\text{DAC}} = 5898.24\text{MSPS}$, $f_{\text{OUT}} = f_{\text{DAC}}/4\text{-}50\text{MHz}$		-95		dBFS
		$f_{\text{DAC}} = 8847.36\text{MSPS}$, $f_{\text{OUT}} = f_{\text{DAC}}/4\text{-}50\text{MHz}$		-88		dBFS
		$f_{\text{DAC}} = 11796.48\text{MSPS}$, $f_{\text{OUT}} = f_{\text{DAC}}/4\text{-}50\text{MHz}$		-76		dBFS
$f_s/2$	Fixed Spur	$f_{\text{DAC}} = 5898.24\text{MSPS}$, $f_{\text{OUT}} = f_{\text{DAC}}/2\text{-}50\text{MHz}$		-52		dBFS
		$f_{\text{DAC}} = 8847.36\text{MSPS}$, $f_{\text{OUT}} = f_{\text{DAC}}/2\text{-}50\text{MHz}$		-45		dBFS
		$f_{\text{DAC}} = 11796.48 \text{ MSPS}$, $f_{\text{OUT}} = f_{\text{DAC}}/2\text{-}50\text{MHz}$		-49		dBFS

7.5 Transmitter Electrical Characteristics (continued)

Typical values at $T_A = +25^\circ\text{C}$, full temperature range is $T_{A,MIN} = -40^\circ\text{C}$ to $T_{J,MAX} = +110^\circ\text{C}$; TX Input Rate = 491.52MSPS, $f_{DAC} = 11796.48\text{MSPS}$ below 6GHz and $f_{DAC} = 9000\text{MSPS}$ above 6GHz; PLL clock mode below 6GHz output frequency and External clock mode above 6GHz output frequency; interleave mode for 1st Nyquist, non-interleave mix mode for 2nd Nyquist, nominal power supplies; 1 tone at -1 dBFS; DSA Attenuation = 0dB, unless otherwise noted.

PARAMETER		TEST CONDITIONS	MIN	TYP	MAX	UNIT
3*f _S /4	Fixed Spur	2nd Nyquist, f _{DAC} = 5898.24MSPS, f _{OUT} =3*f _{DAC} /4-50MHz		-82		dBFS
		2nd Nyquist, f _{DAC} = 8847.36MSPS, f _{OUT} =3*f _{DAC} /4-50MHz		-75		dBFS
		2nd Nyquist, f _{DAC} = 11796.48MSPS, f _{OUT} =3*f _{DAC} /4-50MHz		-49		dBFS
ACPR _{1xcarr}	ACPR - 1 carrier, LTE 20MHz E-TM1.1 carrier f _{out} = 0.85 GHz	Atten=0dB, f _{DAC} = 11796.48MSPS, Pout=-13dBFS		-70		dBc
		Atten=20dB, f _{DAC} = 11796.48MSPS, Pout=-13dBFS		-66		dBc
		Atten=28dB, f _{DAC} = 11796.48MSPS, Pout=-13dBFS		-62		dBc
		Atten=39dB, f _{DAC} = 11796.48MSPS, Pout=-13dBFS		-51		dBc
ACPR _{1xcarr}	ACPR - 1 carrier, LTE 20MHz E-TM1.1 carrier f _{out} = 1.8425 GHz	Atten=0dB, f _{DAC} = 11796.48MSPS, Pout=-13dBFS		-71		dBc
		Atten=20dB, f _{DAC} = 11796.48MSPS, Pout=-13dBFS		-66		dBc
		Atten=28dB, f _{DAC} = 11796.48MSPS, Pout=-13dBFS		-61		dBc
		Atten=39dB, f _{DAC} = 11796.48MSPS, Pout=-13dBFS		-50		dBc
ACPR _{1xcarr}	ACPR - 1 carrier, LTE 20MHz E-TM1.1 carrier f _{out} = 2.6 GHz	Atten=0dB, f _{DAC} = 11796.48MSPS, Pout=-13dBFS		-72		dBc
		Atten=20dB, f _{DAC} = 11796.48MSPS, Pout=-13dBFS		-66		dBc
		Atten=28dB, f _{DAC} = 11796.48MSPS, Pout=-13dBFS		-60		dBc
		Atten=39dB, f _{DAC} = 11796.48MSPS, Pout=-13dBFS		-49		dBc
ACPR _{1xcarr}	ACPR - 1 carrier, LTE 20MHz E-TM1.1 carrier f _{out} = 3.5 GHz	Atten=0dB, f _{DAC} = 11796.48MSPS, Pout=-13dBFS		-71		dBc
		Atten=20dB, f _{DAC} = 11796.48MSPS, Pout=-13dBFS		-65		dBc
		Atten=28dB, f _{DAC} = 11796.48MSPS, Pout=-13dBFS		-58		dBc
		Atten=39dB, f _{DAC} = 11796.48MSPS, Pout=-13dBFS		-47		dBc
ACPR _{1xcarr}	ACPR - 1 carrier, LTE 20MHz E-TM1.1 carrier f _{out} = 4.9 GHz	Atten=0dB, f _{DAC} = 11796.48MSPS, Pout=-13dBFS		-69		dBc
		Atten=20dB, f _{DAC} = 11796.48MSPS, Pout=-13dBFS		-64		dBc
		Atten=28dB, f _{DAC} = 11796.48MSPS, Pout=-13dBFS		-58		dBc
		Atten=39dB, f _{DAC} = 11796.48MSPS, Pout=-13dBFS		-47		dBc

7.5 Transmitter Electrical Characteristics (continued)

Typical values at $T_A = +25^\circ\text{C}$, full temperature range is $T_{A,\text{MIN}} = -40^\circ\text{C}$ to $T_{J,\text{MAX}} = +110^\circ\text{C}$; TX Input Rate = 491.52MSPS, $f_{\text{DAC}} = 11796.48\text{MSPS}$ below 6GHz and $f_{\text{DAC}} = 9000\text{MSPS}$ above 6GHz; PLL clock mode below 6GHz output frequency and External clock mode above 6GHz output frequency; interleave mode for 1st Nyquist, non-interleave mix mode for 2nd Nyquist, nominal power supplies; 1 tone at -1 dBFS; DSA Attenuation = 0dB, unless otherwise noted.

PARAMETER		TEST CONDITIONS	MIN	TYP	MAX	UNIT
ACPR _{1xcarr}	ACPR - 1 carrier, NR 100MHz E-TM1.1 carrier $f_{\text{out}} = 2.6$ GHz	Atten=0dB, $f_{\text{DAC}} = 11796.48\text{MSPS}$, $P_{\text{out}}=-13\text{dBFS}$		-65		dBc
		Atten=20dB, $f_{\text{DAC}} = 11796.48\text{MSPS}$, $P_{\text{out}}=-13\text{dBFS}$		-59		dBc
		Atten=28dB, $f_{\text{DAC}} = 11796.48\text{MSPS}$, $P_{\text{out}}=-13\text{dBFS}$		-53		dBc
		Atten=39dB, $f_{\text{DAC}} = 11796.48\text{MSPS}$, $P_{\text{out}}=-13\text{dBFS}$		-41		dBc
ACPR _{1xcarr}	ACPR - 1 carrier, NR 100MHz E-TM1.1 carrier $f_{\text{out}} = 3.5$ GHz	Atten=0dB, $f_{\text{DAC}} = 11796.48\text{MSPS}$, $P_{\text{out}}=-13\text{dBFS}$		-63		dBc
		Atten=20dB, $f_{\text{DAC}} = 11796.48\text{MSPS}$, $P_{\text{out}}=-13\text{dBFS}$		-56		dBc
		Atten=28dB, $f_{\text{DAC}} = 11796.48\text{MSPS}$, $P_{\text{out}}=-13\text{dBFS}$		-49		dBc
		Atten=39dB, $f_{\text{DAC}} = 11796.48\text{MSPS}$, $P_{\text{out}}=-13\text{dBFS}$		-38		dBc
ACPR _{1xcarr}	ACPR - 1 carrier, NR 100MHz E-TM1.1 carrier $f_{\text{out}} = 4.9$ GHz	Atten=0dB, $f_{\text{DAC}} = 11796.48\text{MSPS}$, $P_{\text{out}}=-13\text{dBFS}$		-63		dBc
		Atten=20dB, $f_{\text{DAC}} = 11796.48\text{MSPS}$, $P_{\text{out}}=-13\text{dBFS}$		-56		dBc
		Atten=28dB, $f_{\text{DAC}} = 11796.48\text{MSPS}$, $P_{\text{out}}=-13\text{dBFS}$		-51		dBc
		Atten=39dB, $f_{\text{DAC}} = 11796.48\text{MSPS}$, $P_{\text{out}}=-13\text{dBFS}$		-41		dBc
EVM	Error Vector Magnitude, 1x 20MHz E-TM3.1/3.1a, no ref. clock noise	$F_{\text{out}} = 0.85$ GHz, $f_{\text{DAC}} = 11796.48\text{MSPS}$, $P_{\text{OUT}}=-13\text{dBFS}$		0.16		%
		$F_{\text{out}} = 1.8425$ GHz, $f_{\text{DAC}} = 11796.48\text{MSPS}$, $P_{\text{OUT}}=-13\text{dBFS}$		0.21		%
		$F_{\text{out}} = 2.6$ GHz, $f_{\text{DAC}} = 11796.48\text{MSPS}$, $P_{\text{OUT}}=-13\text{dBFS}$		0.24		%
		$F_{\text{out}} = 3.5$ GHz, $P_{\text{OUT}}=-13\text{dBFS}$		0.27		%
		$F_{\text{out}} = 4.9$ GHz, $P_{\text{OUT}}=-13\text{dBFS}$		0.38		%
NSD _{dBFS}	Noise Spectral Density 20MHz offset $f_{\text{OUT}} = 5$ MHz	Atten=0dB, $f_{\text{DAC}} = 6000\text{MSPS}$, 20Gbps SerDes rate, $P_{\text{out}}=-12\text{dBFS}$		-148		dBFS/Hz
		Atten=20dB, $f_{\text{DAC}} = 6000\text{MSPS}$, 20Gbps SerDes rate, $P_{\text{out}}=-12\text{dBFS}$		-143		dBFS/Hz
		Atten=28dB, $f_{\text{DAC}} = 6000\text{MSPS}$, 20Gbps SerDes rate, $P_{\text{out}}=-12\text{dBFS}$		-139		dBFS/Hz
		Atten=39dB, $f_{\text{DAC}} = 6000\text{MSPS}$, 20Gbps SerDes rate, $P_{\text{out}}=-12\text{dBFS}$		-129		dBFS/Hz
NSD _{dBFS}	Noise Spectral Density 20MHz offset $f_{\text{OUT}} = 30$ MHz	Atten=0dB, $f_{\text{DAC}} = 6000\text{MSPS}$, 20Gbps SerDes rate, $P_{\text{out}}=-12\text{dBFS}$		-154		dBFS/Hz
		Atten=20dB, $f_{\text{DAC}} = 6000\text{MSPS}$, 20Gbps SerDes rate, $P_{\text{out}}=-12\text{dBFS}$		-146		dBFS/Hz
		Atten=28dB, $f_{\text{DAC}} = 6000\text{MSPS}$, 20Gbps SerDes rate, $P_{\text{out}}=-12\text{dBFS}$		-142		dBFS/Hz
		Atten=39dB, $f_{\text{DAC}} = 6000\text{MSPS}$, 20Gbps SerDes rate, $P_{\text{out}}=-12\text{dBFS}$		-132		dBFS/Hz

7.5 Transmitter Electrical Characteristics (continued)

Typical values at $T_A = +25^\circ\text{C}$, full temperature range is $T_{A,\text{MIN}} = -40^\circ\text{C}$ to $T_{J,\text{MAX}} = +110^\circ\text{C}$; TX Input Rate = 491.52MSPS, $f_{\text{DAC}} = 11796.48\text{MSPS}$ below 6GHz and $f_{\text{DAC}} = 9000\text{MSPS}$ above 6GHz; PLL clock mode below 6GHz output frequency and External clock mode above 6GHz output frequency; interleave mode for 1st Nyquist, non-interleave mix mode for 2nd Nyquist, nominal power supplies; 1 tone at -1 dBFS; DSA Attenuation = 0dB, unless otherwise noted.

PARAMETER		TEST CONDITIONS	MIN	TYP	MAX	UNIT
NSD _{dBFS}	Noise Spectral Density 20MHz offset $f_{\text{OUT}} = 100\text{ MHz}$	Atten=0dB, $f_{\text{DAC}} = 6000\text{MSPS}$, 20Gbps SerDes rate, Pout=-12dBFS		-158		dBFS/ Hz
		Atten=20dB, $f_{\text{DAC}} = 6000\text{MSPS}$, 20Gbps SerDes rate, Pout=-12dBFS		-150		dBFS/ Hz
		Atten=28dB, $f_{\text{DAC}} = 6000\text{MSPS}$, 20Gbps SerDes rate, Pout=-12dBFS		-146		dBFS/ Hz
		Atten=39dB, $f_{\text{DAC}} = 6000\text{MSPS}$, 20Gbps SerDes rate, Pout=-12dBFS		-136		dBFS/ Hz
NSD _{dBFS}	Noise Spectral Density 20MHz offset $f_{\text{OUT}} = 400\text{ MHz}$	Atten=0dB, $f_{\text{DAC}} = 6000\text{MSPS}$, 20Gbps SerDes rate, Pout=-12dBFS		-160		dBFS/ Hz
		Atten=20dB, $f_{\text{DAC}} = 6000\text{MSPS}$, 20Gbps SerDes rate, Pout=-12dBFS		-153		dBFS/ Hz
		Atten=28dB, $f_{\text{DAC}} = 6000\text{MSPS}$, 20Gbps SerDes rate, Pout=-12dBFS		-150		dBFS/ Hz
		Atten=39dB, $f_{\text{DAC}} = 6000\text{MSPS}$, 20Gbps SerDes rate, Pout=-12dBFS		-139		dBFS/ Hz
NSD _{dBFS}	Noise Spectral Density 20MHz offset $f_{\text{OUT}} = 0.85\text{ GHz}$	Atten=0dB, $f_{\text{DAC}} = 5898.24\text{MSPS}$, Pout=-13dBFS		-158.8		dBFS/ Hz
		Atten=20dB, $f_{\text{DAC}} = 5898.24\text{MSPS}$, Pout=-13dBFS		-152.7		dBFS/ Hz
		Atten=28dB, $f_{\text{DAC}} = 5898.24\text{MSPS}$, Pout=-13dBFS		-148.7		dBFS/ Hz
		Atten=39dB, $f_{\text{DAC}} = 5898.24\text{MSPS}$, Pout=-13dBFS		-137.9		dBFS/ Hz
NSD _{dBFS}	Noise Spectral Density 20MHz offset $f_{\text{OUT}} = 1.8\text{ GHz}$	Atten=0dB, $f_{\text{DAC}} = 5898.24\text{MSPS}$, Pout=-13dBFS		-157.9		dBFS/ Hz
		Atten=20dB, $f_{\text{DAC}} = 5898.24\text{MSPS}$, Pout=-13dBFS		-151.3		dBFS/ Hz
		Atten=28dB, $f_{\text{DAC}} = 5898.24\text{MSPS}$, Pout=-13dBFS		-145.6		dBFS/ Hz
		Atten=39dB, $f_{\text{DAC}} = 5898.24\text{MSPS}$, Pout=-13dBFS		-134.8		dBFS/ Hz
NSD _{dBFS}	Noise Spectral Density 20MHz offset $f_{\text{OUT}} = 2.6\text{ GHz}$	Atten=0dB, $f_{\text{DAC}} = 8847.36\text{MSPS}$, Pout=-13dBFS		-158.3		dBFS/ Hz
		Atten=20dB, $f_{\text{DAC}} = 8847.36\text{MSPS}$, Pout=-13dBFS		-151.6		dBFS/ Hz
		Atten=28dB, $f_{\text{DAC}} = 8847.36\text{MSPS}$, Pout=-13dBFS		-144.9		dBFS/ Hz
		Atten=39dB, $f_{\text{DAC}} = 8847.36\text{MSPS}$, Pout=-13dBFS		-134.0		dBFS/ Hz
NSD _{dBFS}	Noise Spectral Density 20MHz offset $F_{\text{out}} = 3.5\text{ GHz}$	Atten=0dB, $f_{\text{DAC}} = 11796.48\text{MSPS}$, Pout=-13dBFS		-158.2		dBFS/ Hz
		Atten=20dB, $f_{\text{DAC}} = 11796.48\text{MSPS}$, Pout=-13dBFS		-150.9		dBFS/ Hz
		Atten=28dB, $f_{\text{DAC}} = 11796.48\text{MSPS}$, Pout=-13dBFS		-144.4		dBFS/ Hz
		Atten=39dB, $f_{\text{DAC}} = 11796.48\text{MSPS}$, Pout=-13dBFS		-133.4		dBFS/ Hz

7.5 Transmitter Electrical Characteristics (continued)

Typical values at $T_A = +25^\circ\text{C}$, full temperature range is $T_{A,\text{MIN}} = -40^\circ\text{C}$ to $T_{J,\text{MAX}} = +110^\circ\text{C}$; TX Input Rate = 491.52MSPS, $f_{\text{DAC}} = 11796.48\text{MSPS}$ below 6GHz and $f_{\text{DAC}} = 9000\text{MSPS}$ above 6GHz; PLL clock mode below 6GHz output frequency and External clock mode above 6GHz output frequency; interleave mode for 1st Nyquist, non-interleave mix mode for 2nd Nyquist, nominal power supplies; 1 tone at -1 dBFS; DSA Attenuation = 0dB, unless otherwise noted.

PARAMETER		TEST CONDITIONS	MIN	TYP	MAX	UNIT
NSD _{dBFS}	Noise Spectral Density 20MHz offset $F_{\text{out}} = 4.9\text{ GHz}$	Atten=0dB, $f_{\text{DAC}} = 11796.48\text{MSPS}$, Pout=-13dBFS		-154.6		dBFS/ Hz
		Atten=20dB, $f_{\text{DAC}} = 11796.48\text{MSPS}$, Pout=-13dBFS		-147.0		dBFS/ Hz
		Atten=28dB, $f_{\text{DAC}} = 11796.48\text{MSPS}$, Pout=-13dBFS		-140.7		dBFS/ Hz
		Atten=39dB, $f_{\text{DAC}} = 11796.48\text{MSPS}$, Pout=-13dBFS		-129.9		dBFS/ Hz
S22	Output Return Loss, +/- $f_c * 10\%$	with matching		-12		dB
Isolation	Near Channel: 1TXOUT to 2TXOUT or 3TXOUT to 4TXOUT ⁽¹⁾	$f_{\text{out}} = 10\text{ MHz}$, $f_{\text{DAC}} = 6000\text{MSPS}$, straight mode ⁽³⁾		-96		dB
		$f_{\text{out}} = 30\text{ MHz}$, $f_{\text{DAC}} = 6000\text{MSPS}$, straight mode ⁽³⁾		-97		dB
		$f_{\text{out}} = 100\text{ MHz}$, $f_{\text{DAC}} = 6000\text{MSPS}$, straight mode ⁽³⁾		-102		dB
		$f_{\text{out}} = 400\text{ MHz}$, $f_{\text{DAC}} = 6000\text{MSPS}$, straight mode ⁽⁴⁾		-85		dB
		$f_{\text{out}} = 900\text{ MHz}$, $f_{\text{DAC}} = 8847.36\text{MSPS}$, straight mode		-80		dB
		$f_{\text{out}} = 1850\text{ MHz}$, $f_{\text{DAC}} =$ 8847.36MSPS, straight mode		-77		dB
		$f_{\text{out}} = 2600\text{ MHz}$, $f_{\text{DAC}} =$ 8847.36MSPS, straight mode		-64		dB
		$f_{\text{out}} = 3500\text{ MHz}$, $f_{\text{DAC}} =$ 8847.36MSPS, straight mode		-61		dB
		$f_{\text{out}} = 4900\text{ MHz}$, $f_{\text{DAC}} =$ 8847.36MSPS, straight mode		-60		dB
Isolation	Far Channel: 1/2TXOUT to 3/4TXOUT	$f_{\text{out}} = 10\text{ MHz}$, $f_{\text{DAC}} = 6000\text{MSPS}$, straight mode ⁽³⁾		-104		dB
		$f_{\text{out}} = 30\text{ MHz}$, $f_{\text{DAC}} = 6000\text{MSPS}$, straight mode ⁽³⁾		-100		dB
		$f_{\text{out}} = 100\text{ MHz}$, $f_{\text{DAC}} = 6000\text{MSPS}$, straight mode ⁽³⁾		-105		dB
		$f_{\text{out}} = 400\text{ MHz}$, $f_{\text{DAC}} = 6000\text{MSPS}$, straight mode ⁽⁴⁾		-97		dB
		$f_{\text{out}} = 900\text{ MHz}$, $f_{\text{DAC}} = 8847.36\text{MSPS}$, straight mode		-90		dB
		$f_{\text{out}} = 1850\text{ MHz}$, $f_{\text{DAC}} =$ 8847.36MSPS, straight mode		-91		dB
		$f_{\text{out}} = 2600\text{ MHz}$, $f_{\text{DAC}} =$ 8847.36MSPS, straight mode		-93		dB
		$f_{\text{out}} = 3500\text{ MHz}$, $f_{\text{DAC}} =$ 8847.36MSPS, straight mode		-94		dB
		$f_{\text{out}} = 4900\text{ MHz}$, $f_{\text{DAC}} =$ 8847.36MSPS, straight mode		-83.2		dB

7.5 Transmitter Electrical Characteristics (continued)

Typical values at $T_A = +25^\circ\text{C}$, full temperature range is $T_{A,\text{MIN}} = -40^\circ\text{C}$ to $T_{J,\text{MAX}} = +110^\circ\text{C}$; TX Input Rate = 491.52MSPS, $f_{\text{DAC}} = 11796.48\text{MSPS}$ below 6GHz and $f_{\text{DAC}} = 9000\text{MSPS}$ above 6GHz; PLL clock mode below 6GHz output frequency and External clock mode above 6GHz output frequency; interleave mode for 1st Nyquist, non-interleave mix mode for 2nd Nyquist, nominal power supplies; 1 tone at -1 dBFS; DSA Attenuation =0dB, unless otherwise noted.

PARAMETER		TEST CONDITIONS	MIN	TYP	MAX	UNIT
PN _{TXADD}	Additive Phase Noise External Clock Mode ⁽⁵⁾	$f_{\text{out}} = 3.7\text{GHz}, f_{\text{OFFSET}} = 100\text{Hz}$		-97		dBc/Hz
		$f_{\text{out}} = 3.7\text{GHz}, f_{\text{OFFSET}} = 1\text{kHz}$		-106		dBc/Hz
		$f_{\text{out}} = 3.7\text{GHz}, f_{\text{OFFSET}} = 10\text{kHz}$		-117		dBc/Hz
		$f_{\text{out}} = 3.7\text{GHz}, f_{\text{OFFSET}} = 100\text{kHz}$		-128		dBc/Hz
		$f_{\text{out}} = 3.7\text{GHz}, f_{\text{OFFSET}} = 1\text{MHz}$		-138		dBc/Hz
		$f_{\text{out}} = 3.7\text{GHz}, f_{\text{OFFSET}} = 10\text{MHz}$		-144		dBc/Hz

- (1) Measured with differential 100 ohm across TxP/M. The DC bias to 1.8V to each TxP/M at each pin remains and is not removed. Other external components on the TX paths are disconnected.
- (2) After DSA calibration procedure
- (3) measured with 1μH DC feed inductor
- (4) measured with 0.39μH DC feed inductor
- (5) Input clock phase noise subtracted.

7.6 RF ADC Electrical Characteristics

Typical values at $T_A = +25^\circ\text{C}$, full temperature range is $T_{A,\text{MIN}} = -40^\circ\text{C}$ to $T_{J,\text{MAX}} = +110^\circ\text{C}$; RX Output Rate = 491.52MSPS, $f_{\text{ADC}} = 2949.12\text{MSPS}$; PLL clock mode with $f_{\text{REF}} = 491.52\text{MHz}$; nominal power supplies; DSA Setting = 3dB; SerDes rate = 24.33Gbps; unless otherwise noted.

PARAMETER		TEST CONDITIONS	MIN	TYP	MAX	UNIT
ADC_{RES}	ADC resolution			14		bits
F_{RFIn}	RF input frequency range		5		7400	MHz
$\text{P}_{\text{FS,CW,min}}$	Min Full scale input power, at device pins ⁽¹⁾	$f_{\text{IN}} = 5 \text{ MHz}$, DSA=0dB, $f_{\text{ADC}} = 1500\text{MSPS}$, $f_{\text{NCO}} = 17\text{MHz}$, Decimate by 48		-0.4		dBm
		$f_{\text{IN}} = 30 \text{ MHz}$, DSA=0dB, $f_{\text{ADC}} = 1500\text{MSPS}$, $f_{\text{NCO}} = 30\text{MHz}$, Decimate by 24		-2.2		dBm
		$f_{\text{IN}} = 410 \text{ MHz}$, DSA=0dB, $f_{\text{ADC}} = 3000\text{MSPS}$, $f_{\text{NCO}} = 400\text{MHz}$, Decimate by 12		-2.5		dBm
		$f_{\text{IN}} = 830 \text{ MHz}$, DSA=0dB		-2.9		dBm
		$f_{\text{IN}} = 1760 \text{ MHz}$, DSA=0dB		-2.8		dBm
		$f_{\text{IN}} = 2610 \text{ MHz}$, DSA=0dB		-1.8		dBm
		$f_{\text{IN}} = 3610 \text{ MHz}$, DSA=0dB		-0.4		dBm
		$f_{\text{IN}} = 4910 \text{ MHz}$, DSA=0dB		0.1		dBm
$\text{P}_{\text{FS,CW,MAX}}$	MAX Full scale input power - reliability limited, at device pins	$f_{\text{IN}} = 5 \text{ MHz}$, $f_{\text{ADC}} = 1500\text{MSPS}$, $f_{\text{NCO}} = 17\text{MHz}$, Decimate by 48		19.7		dBm
		$f_{\text{IN}} = 30 \text{ MHz}$, $f_{\text{ADC}} = 1500\text{MSPS}$, $f_{\text{NCO}} = 30\text{MHz}$, Decimate by 24		17.8		dBm
		$f_{\text{IN}} = 410 \text{ MHz}$, $f_{\text{ADC}} = 3000\text{MSPS}$, $f_{\text{NCO}} = 400\text{MHz}$, Decimate by 24		17.6		dBm
		$f_{\text{IN}} = 830 \text{ MHz}$		16.7		dBm
		$f_{\text{IN}} = 1760 \text{ MHz}$		17.0		dBm
		$f_{\text{IN}} = 2610 \text{ MHz}$		18		dBm
		$f_{\text{IN}} = 3610 \text{ MHz}$		18.5		dBm
		$f_{\text{IN}} = 4910 \text{ MHz}$		19.3		dBm
R_{TERM}	Input reference impedance			100.0		Ω
$\text{ATT}_{\text{range}}$	DSA Attenuation range			25.0		dB
ATT_{step}	DSA Attenuation step			0.5		dB
	DSA Attenuation step accuracy	$\Delta = \text{Gatt}(X) - \text{Gatt}(X-1)$, $F_{\text{in}} = 3610\text{MHz}$, after calibration		0.1		dB
	DSA Gain Steps Phase accuracy any 8dB range	$F_{\text{in}} = 3610\text{MHz}$, after calibration		0.9		deg
	DSA Gain Steps Phase accuracy any 8dB range	$F_{\text{in}} = 4910\text{MHz}$, after calibration		1.8		deg
G_{flat}	Gain flatness	Measured Over 80MHz BW		0.2		dB
		Measured Over 200MHz BW		0.5		dB
		Measured Over 400MHz BW		1.1		dB

7.6 RF ADC Electrical Characteristics (continued)

Typical values at $T_A = +25^\circ\text{C}$, full temperature range is $T_{A,\text{MIN}} = -40^\circ\text{C}$ to $T_{J,\text{MAX}} = +110^\circ\text{C}$; RX Output Rate = 491.52MSPS, $f_{\text{ADC}} = 2949.12\text{MSPS}$; PLL clock mode with $f_{\text{REF}} = 491.52\text{MHz}$; nominal power supplies; DSA Setting = 3dB; SerDes rate = 24.33Gbps; unless otherwise noted.

PARAMETER		TEST CONDITIONS	MIN	TYP	MAX	UNIT
NSD	Noise Density ⁽³⁾ (small signal = -30dBFS)	$f_{\text{IN}} = 5\text{ MHz}$, DSA = 3dB, $f_{\text{ADC}} = 1500\text{MSPS}$, $f_{\text{NCO}} = 17\text{MHz}$, Decimate by 48		-147.1		dBFS/Hz
		$f_{\text{IN}} = 30\text{ MHz}$, DSA = 3dB, $f_{\text{ADC}} = 1500\text{MSPS}$, $f_{\text{NCO}} = 30\text{MHz}$, Decimate by 24		-150.7		dBFS/Hz
		$f_{\text{IN}} = 410\text{ MHz}$, DSA = 3dB, $f_{\text{ADC}} = 3000\text{MSPS}$, $f_{\text{NCO}} = 400\text{MHz}$, Decimate by 24		-155.4		dBFS/Hz
		$f_{\text{IN}} = 830\text{ MHz}$, DSA = 3dB		-156.2		dBFS/Hz
		$f_{\text{IN}} = 1760\text{ MHz}$, DSA = 3dB		-156.0		dBFS/Hz
		$f_{\text{IN}} = 2610\text{ MHz}$, DSA = 3dB		-155.4		dBFS/Hz
		$f_{\text{IN}} = 3610\text{ MHz}$, DSA = 3dB		-155.1		dBFS/Hz
		$f_{\text{IN}} = 4910\text{ MHz}$, DSA = 3dB		-155.1		dBFS/Hz
		$f_{\text{IN}} = 5\text{ MHz}$, $f_{\text{ADC}} = 1500\text{MSPS}$, $f_{\text{NCO}} = 17\text{MHz}$, Decimate by 48, 3<=Atten<=22		-147.8		dBFS/Hz
		$f_{\text{IN}} = 30\text{ MHz}$, $f_{\text{ADC}} = 1500\text{MSPS}$, $f_{\text{NCO}} = 30\text{MHz}$, Decimate by 24, 3<=Atten<=22		-151.5		dBFS/Hz
		$f_{\text{IN}} = 410\text{ MHz}$, 3<=Atten<=22, $f_{\text{ADC}} = 3000\text{MSPS}$, $f_{\text{NCO}} = 400\text{MHz}$, Decimate by 24		-156.6		dBFS/Hz
		$f_{\text{IN}} = 830\text{ MHz}$, 3<=Atten<=22		-156.0		dBFS/Hz
		$f_{\text{IN}} = 1760\text{ MHz}$, 3<=Atten<=25		-155.8		dBFS/Hz
		$f_{\text{IN}} = 2610\text{ MHz}$, 3<=Atten<=25		-155.7		dBFS/Hz
$f_{\text{IN}} = 3610\text{ MHz}$, 3<=Atten<=25		-155.4		dBFS/Hz		
$f_{\text{IN}} = 4910\text{ MHz}$, 3<=Atten<=25		-155.8		dBFS/Hz		
NF _{min}	Noise Figure min DSA Atten=0 - 3dB	$f_{\text{IN}} = 5\text{ MHz}$, $f_{\text{ADC}} = 1500\text{MSPS}$, $f_{\text{NCO}} = 17\text{MHz}$, Decimate by 48		29.4		dB
		$f_{\text{IN}} = 30\text{ MHz}$, $f_{\text{ADC}} = 1500\text{MSPS}$, $f_{\text{NCO}} = 30\text{MHz}$, Decimate by 24		24.5		dB
		$f_{\text{IN}} = 410\text{ MHz}$, $f_{\text{ADC}} = 3000\text{MSPS}$, $f_{\text{NCO}} = 400\text{MHz}$, Decimate by 24		19.3		dB
		$f_{\text{IN}} = 830\text{ MHz}$		19.1		dB
		$f_{\text{IN}} = 1760\text{ MHz}$		19.0		dB
		$f_{\text{IN}} = 2610\text{ MHz}$		20.9		dB
		$f_{\text{IN}} = 3610\text{ MHz}$		22.8		dB
$f_{\text{IN}} = 4910\text{ MHz}$		22.4		dB		

7.6 RF ADC Electrical Characteristics (continued)

Typical values at $T_A = +25^\circ\text{C}$, full temperature range is $T_{A,\text{MIN}} = -40^\circ\text{C}$ to $T_{J,\text{MAX}} = +110^\circ\text{C}$; RX Output Rate = 491.52MSPS, $f_{\text{ADC}} = 2949.12\text{MSPS}$; PLL clock mode with $f_{\text{REF}} = 491.52\text{MHz}$; nominal power supplies; DSA Setting = 3dB; SerDes rate = 24.33Gbps; unless otherwise noted.

PARAMETER		TEST CONDITIONS	MIN	TYP	MAX	UNIT
NF	Noise Figure ⁽⁴⁾ DSA Atten=4dB	$f_{\text{IN}} = 5\text{ MHz}$, $f_{\text{ADC}} = 1500\text{MSPS}$, $f_{\text{NCO}} = 17\text{MHz}$, Decimate by 48		30.6		dB
		$f_{\text{IN}} = 30\text{ MHz}$, $f_{\text{ADC}} = 1500\text{MSPS}$, $f_{\text{NCO}} = 30\text{MHz}$, Decimate by 24		25.1		dB
		$f_{\text{IN}} = 410\text{ MHz}$, $f_{\text{ADC}} = 3000\text{MSPS}$, $f_{\text{NCO}} = 400\text{MHz}$, Decimate by 24		20.1		dB
		$f_{\text{IN}} = 830\text{ MHz}$		20.0		dB
		$f_{\text{IN}} = 1760\text{ MHz}$		20.6		dB
		$f_{\text{IN}} = 2610\text{ MHz}$		21.9		dB
		$f_{\text{IN}} = 3610\text{ MHz}$		23.5		dB
		$f_{\text{IN}} = 4910\text{ MHz}$		22.3		dB
NF _{max}	Noise Figure DSA Atten=20dB	$f_{\text{IN}} = 5\text{ MHz}$, $f_{\text{ADC}} = 1500\text{MSPS}$, $f_{\text{NCO}} = 17\text{MHz}$, Decimate by 48		45.9		dB
		$f_{\text{IN}} = 30\text{ MHz}$, $f_{\text{ADC}} = 1500\text{MSPS}$, $f_{\text{NCO}} = 30\text{MHz}$, Decimate by 24		40.2		dB
		$f_{\text{IN}} = 410\text{ MHz}$, $f_{\text{ADC}} = 3000\text{MSPS}$, $f_{\text{NCO}} = 400\text{MHz}$, Decimate by 24		35.0		dB
		$f_{\text{IN}} = 830\text{ MHz}$		34.7		dB
		$f_{\text{IN}} = 1760\text{ MHz}$		35.2		dB
		$f_{\text{IN}} = 2610\text{ MHz}$		36.0		dB
		$f_{\text{IN}} = 3610\text{ MHz}$		37.3		dB
		$f_{\text{IN}} = 4910\text{ MHz}$		37.6		dB
IMD3	3 rd order intermodulation 2 tones at at $f_{\text{IN}} \pm 10\text{MHz}$ -7dBFS each tone	$f_{\text{IN}} = 30 \pm 1\text{ MHz}$, $f_{\text{ADC}} = 1500\text{MSPS}$, $f_{\text{NCO}} = 30\text{MHz}$, Decimate by 24		-82		dBc
		$f_{\text{IN}} = 400\text{MHz}$ and 405MHz , $f_{\text{ADC}} = 3000\text{MSPS}$, $f_{\text{NCO}} = 400\text{MHz}$, Decimate by 24		-75		dBc
		$f_{\text{IN}} = 840\text{ MHz}$		-82		dBc
		$f_{\text{IN}} = 1770\text{ MHz}$		-84		dBc
		$f_{\text{IN}} = 2610\text{ MHz}$		-74		dBc
		$f_{\text{IN}} = 3610\text{ MHz}$		-77		dBc
		$f_{\text{IN}} = 4920\text{ MHz}$		-76		dBc
SFDR	Spurious Free Dynamic Range within output bandwidth, $A_{\text{IN}} = -3\text{ dBFS}$	$f_{\text{IN}} = 5\text{ MHz}$, $f_{\text{ADC}} = 1500\text{MSPS}$, $f_{\text{NCO}} = 17\text{MHz}$, Decimate by 48		78		dBFS
		$f_{\text{IN}} = 30\text{ MHz}$, $f_{\text{ADC}} = 1500\text{MSPS}$, $f_{\text{NCO}} = 30\text{MHz}$, Decimate by 24		100		dBFS
		$f_{\text{IN}} = 410\text{ MHz}$, $f_{\text{ADC}} = 3000\text{MSPS}$, $f_{\text{NCO}} = 400\text{MHz}$, Decimate by 24		94		dBFS
		$f_{\text{IN}} = 830\text{ MHz}$		88		dBFS
		$f_{\text{IN}} = 1760\text{ MHz}$		81		dBFS
		$f_{\text{IN}} = 2610\text{ MHz}$		88		dBFS
		$f_{\text{IN}} = 3610\text{ MHz}$		84		dBFS
		$f_{\text{IN}} = 4910\text{ MHz}$		79		dBFS

7.6 RF ADC Electrical Characteristics (continued)

Typical values at $T_A = +25^\circ\text{C}$, full temperature range is $T_{A,MIN} = -40^\circ\text{C}$ to $T_{J,MAX} = +110^\circ\text{C}$; RX Output Rate = 491.52MSPS, $f_{ADC} = 2949.12\text{MSPS}$; PLL clock mode with $f_{REF} = 491.52\text{MHz}$; nominal power supplies; DSA Setting = 3dB; SerDes rate = 24.33Gbps; unless otherwise noted.

PARAMETER		TEST CONDITIONS	MIN	TYP	MAX	UNIT
HD2	2nd Harmonic Distortion $A_{IN} = -3 \text{ dBFS}^{(2)}$	$f_{IN} = 5 \text{ MHz}$, $f_{ADC} = 1500\text{MSPS}$, $f_{NCO} = 17\text{MHz}$, Decimate by 48		-84		dBFS
		$f_{IN} = 30 \text{ MHz}$, $f_{ADC} = 1500\text{MSPS}$, Bypass Mode (TI only test mode)		-91		dBFS
		$f_{IN} = 410 \text{ MHz}$, $f_{ADC} = 3000\text{MSPS}$, Bypass Mode (TI only test mode)		-90		dBFS
		$f_{IN} = 830 \text{ MHz}$		-86		dBFS
		$f_{IN} = 1760 \text{ MHz}$		-90		dBFS
		$f_{IN} = 2610 \text{ MHz}$		-88		dBFS
		$f_{IN} = 3610 \text{ MHz}$		-87		dBFS
		$f_{IN} = 4910 \text{ MHz}$		-84		dBFS
HD3	3rd Harmonic Distortion $A_{IN} = -3 \text{ dBFS}$	$f_{IN} = 5 \text{ MHz}$, $f_{ADC} = 1500\text{MSPS}$, $f_{NCO} = 17\text{MHz}$, Decimate by 48		-78		dBFS
		$f_{IN} = 30 \text{ MHz}$, $f_{ADC} = 1500\text{MSPS}$, Bypass Mode (TI only test mode)		-96		dBFS
		$f_{IN} = 410 \text{ MHz}$, $f_{ADC} = 3000\text{MSPS}$, Bypass Mode (TI only test mode)		-94		dBFS
		$f_{IN} = 830 \text{ MHz}$		-80		dBFS
		$f_{IN} = 1760 \text{ MHz}$		-85		dBFS
		$f_{IN} = 2610 \text{ MHz}$		-86		dBFS
		$f_{IN} = 3610 \text{ MHz}$		-78		dBFS
		$f_{IN} = 4910 \text{ MHz}$		-75		dBFS
HDn, n>3	SFDR excl. HD2 and HD3 $A_{IN} = -3 \text{ dBFS}$	$f_{IN} = 5 \text{ MHz}$, $f_{ADC} = 1500\text{MSPS}$, $f_{NCO} = 17\text{MHz}$, Decimate by 48		-94		dBFS
		$f_{IN} = 30 \text{ MHz}$, $f_{ADC} = 1500\text{MSPS}$, $f_{NCO} = 30\text{MHz}$, Decimate by 24		-94		dBFS
		$f_{IN} = 410 \text{ MHz}$, $f_{ADC} = 3000\text{MSPS}$, $f_{NCO} = 400\text{MHz}$, Decimate by 24		-94		dBFS
		$f_{IN} = 830 \text{ MHz}$		-88		dBFS
		$f_{IN} = 1760 \text{ MHz}$		-81		dBFS
		$f_{IN} = 2610 \text{ MHz}$		-88		dBFS
		$f_{IN} = 3610 \text{ MHz}$		-84		dBFS
		$f_{IN} = 4910 \text{ MHz}$		-82		dBFS
SFDR	Spurious Free Dynamic Range $A_{IN} = -13 \text{ dBFS}$	$f_{IN} = 5 \text{ MHz}$, $f_{ADC} = 1500\text{MSPS}$, $f_{NCO} = 17\text{MHz}$, Decimate by 48		101		dBFS
		$f_{IN} = 30 \text{ MHz}$, $f_{ADC} = 1500\text{MSPS}$, $f_{NCO} = 30\text{MHz}$, Decimate by 24		105		dBFS
		$f_{IN} = 410 \text{ MHz}$, $f_{ADC} = 3000\text{MSPS}$, $f_{NCO} = 400\text{MHz}$, Decimate by 24		95		dBFS
		$f_{IN} = 830 \text{ MHz}$		89		dBFS
		$f_{IN} = 1760 \text{ MHz}$		89		dBFS
		$f_{IN} = 2610 \text{ MHz}$		95		dBFS
		$f_{IN} = 3610 \text{ MHz}$		87		dBFS
		$f_{IN} = 4910 \text{ MHz}$		90		dBFS

7.6 RF ADC Electrical Characteristics (continued)

Typical values at $T_A = +25^\circ\text{C}$, full temperature range is $T_{A,\text{MIN}} = -40^\circ\text{C}$ to $T_{J,\text{MAX}} = +110^\circ\text{C}$; RX Output Rate = 491.52MSPS, $f_{\text{ADC}} = 2949.12\text{MSPS}$; PLL clock mode with $f_{\text{REF}} = 491.52\text{MHz}$; nominal power supplies; DSA Setting = 3dB; SerDes rate = 24.33Gbps; unless otherwise noted.

PARAMETER		TEST CONDITIONS	MIN	TYP	MAX	UNIT
HD2	2nd Harmonic Distortion ⁽²⁾ $A_{\text{IN}} = -13\text{ dBFS}$	$f_{\text{IN}} = 5\text{ MHz}$, $f_{\text{ADC}} = 1500\text{MSPS}$, $f_{\text{NCO}} = 17\text{MHz}$, Decimate by 48		-104		dBFS
		$f_{\text{IN}} = 30\text{ MHz}$, $f_{\text{ADC}} = 1500\text{MSPS}$, Bypass Mode (TI only test mode)		-91		dBFS
		$f_{\text{IN}} = 410\text{ MHz}$, $f_{\text{ADC}} = 3000\text{MSPS}$, Bypass Mode (TI only test mode)		-104		dBFS
		$f_{\text{IN}} = 830\text{ MHz}$, with board trim		-79		dBFS
		$f_{\text{IN}} = 1760\text{ MHz}$, with board trim		-102		dBFS
		$f_{\text{IN}} = 2610\text{ MHz}$, with board trim		-100		dBFS
		$f_{\text{IN}} = 3610\text{ MHz}$, with board trim		-101		dBFS
		$f_{\text{IN}} = 4910\text{ MHz}$, with board trim		-99		dBFS
HD3	3rd Harmonic Distortion $A_{\text{IN}} = -13\text{ dBFS}$	$f_{\text{IN}} = 5\text{ MHz}$, $f_{\text{ADC}} = 1500\text{MSPS}$, $f_{\text{NCO}} = 17\text{MHz}$, Decimate by 48		-103		dBFS
		$f_{\text{IN}} = 30\text{ MHz}$, $f_{\text{ADC}} = 1500\text{MSPS}$, Bypass Mode (TI only test mode)		-84		dBFS
		$f_{\text{IN}} = 381\text{ MHz}$, $f_{\text{ADC}} = 3000\text{MSPS}$, Bypass Mode (TI only test mode)		-91		dBFS
		$f_{\text{IN}} = 830\text{ MHz}$		-95		dBFS
		$f_{\text{IN}} = 1760\text{ MHz}$		-95		dBFS
		$f_{\text{IN}} = 2610\text{ MHz}$		-98		dBFS
		$f_{\text{IN}} = 3610\text{ MHz}$		-97		dBFS
		$f_{\text{IN}} = 4910\text{ MHz}$		-94		dBFS
HDn, n>3	SFDR excl. HD2 and HD3 $A_{\text{IN}} = -13\text{ dBFS}$	$f_{\text{IN}} = 5\text{ MHz}$, $f_{\text{ADC}} = 1500\text{MSPS}$, $f_{\text{NCO}} = 17\text{MHz}$, Decimate by 48		-104		dBFS
		$f_{\text{IN}} = 30\text{ MHz}$, $f_{\text{ADC}} = 1500\text{MSPS}$, $f_{\text{NCO}} = 30\text{MHz}$, Decimate by 24		-105		dBFS
		$f_{\text{IN}} = 410\text{ MHz}$, $f_{\text{ADC}} = 3000\text{MSPS}$, $f_{\text{NCO}} = 400\text{MHz}$, Decimate by 24		-95		dBFS
		$f_{\text{IN}} = 830\text{ MHz}$		-89		dBFS
		$f_{\text{IN}} = 1760\text{ MHz}$		-89		dBFS
		$f_{\text{IN}} = 2610\text{ MHz}$		-95		dBFS
		$f_{\text{IN}} = 3610\text{ MHz}$		-90		dBFS
		$f_{\text{IN}} = 4910\text{ MHz}$		-90		dBFS
RX-RX/FB Isolation	Near Channel: 1RXIN to 2RXIN 3RXIN to 4RXIN	$f_{\text{IN}} = 5\text{ MHz}$, $f_{\text{ADC}} = 1500\text{MSPS}$, $f_{\text{NCO}} = 17\text{MHz}$, Decimate by 48		-98		dB
		$f_{\text{IN}} = 30\text{ MHz}$, $f_{\text{ADC}} = 1500\text{MSPS}$, $f_{\text{NCO}} = 30\text{MHz}$, Decimate by 24		-98		dB
		$f_{\text{IN}} = 400\text{ MHz}$		-88		dB
		$f_{\text{IN}} = 830\text{ MHz}$		-77		dB
		$f_{\text{IN}} = 1760\text{ MHz}$		-71		dB
		$f_{\text{IN}} = 2610\text{ MHz}$		-74		dB
		$f_{\text{IN}} = 3610\text{ MHz}$		-77		dB
		$f_{\text{IN}} = 4910\text{ MHz}$		-65		dB

7.6 RF ADC Electrical Characteristics (continued)

Typical values at $T_A = +25^\circ\text{C}$, full temperature range is $T_{A,\text{MIN}} = -40^\circ\text{C}$ to $T_{J,\text{MAX}} = +110^\circ\text{C}$; RX Output Rate = 491.52MSPS, $f_{\text{ADC}} = 2949.12\text{MSPS}$; PLL clock mode with $f_{\text{REF}} = 491.52\text{MHz}$; nominal power supplies; DSA Setting = 3dB; SerDes rate = 24.33Gbps; unless otherwise noted.

PARAMETER		TEST CONDITIONS	MIN	TYP	MAX	UNIT
TX-RX Isolation	1TXOUT to 1RXIN 3TXOUT to 2RXIN	$f_{\text{IN}} = 5\text{ MHz}$, $f_{\text{ADC}} = 1500\text{MSPS}$, $f_{\text{NCO}} = 17\text{MHz}$, Decimate by 48		-105		dB
		$f_{\text{IN}} = 30\text{ MHz}$, $f_{\text{ADC}} = 1500\text{MSPS}$, $f_{\text{NCO}} = 30\text{MHz}$, Decimate by 24		-101		dB
		$f_{\text{IN}} = 400\text{ MHz}$		-99		dB
		$f_{\text{IN}} = 830\text{ MHz}$		-86		dB
		$f_{\text{IN}} = 1760\text{ MHz}$		-87		dB
		$f_{\text{IN}} = 2610\text{ MHz}$		-84		dB
		$f_{\text{IN}} = 3610\text{ MHz}$		-82		dB
		$f_{\text{IN}} = 4910\text{ MHz}$		-82		dB

- (1) The input fullscale at minimum attenuation can be reduce by adding a digital gain range to the DSA, extending the useful range of the DSA. The noise figure remains constant over the digital gain range.
- (2) After HD2 trim on specific printed circuit board.
- (3) From DSA = 3dB down to 0dB, NSD increases 1dB per DSA dB
- (4) NF increase 1dB per DSA 1dB above DSA = 3dB

7.7 PLL/VCO/Clock Electrical Characteristics

Typical values at TA = +25°C, full temperature range is T_{A,MIN} = -40°C to T_{J,MAX} = +110°C; Reference clock input frequency 491.52MHz (unless otherwise noted), f_{DAC} = f_{VCO}, f_{OUT} = f_{DAC}/4, normalized to f_{VCO}.

PARAMETER		TEST CONDITIONS	MIN	TYP	MAX	UNIT
f _{VCO1}	VCO1 min frequency				7.2	GHz
	VCO1 max frequency		7.68			GHz
f _{VCO2}	VCO2 min frequency				8.848	GHz
	VCO2 max frequency		9.216			GHz
f _{VCO3}	VCO3 min frequency				9.8304	GHz
	VCO3 max frequency		10.24			GHz
f _{VCO4}	VCO4 min frequency				11.7965	GHz
	VCO4 max frequency		12.288			GHz
DIV _{DAC}	DAC sample rate divider			1, 2 or 3		
DIV _{RXADC}	ADC sample rate divider			1, 2, 3, 4, 6 or 8		
PN _{VCO}	Closed Loop Phase Noise F _{PLL} = 11.79848 GHz F _{REF} =491.52MHz	600kHz		-113		dBc/Hz
		800kHz		-116		dBc/Hz
		1MHz		-119		dBc/Hz
		1.8MHz		-125		dBc/Hz
		5MHz		-133		dBc/Hz
		50MHz		-141		dBc/Hz
	Closed Loop Phase Noise F _{PLL} =8.84736 GHz F _{REF} =491.52MHz	600kHz		-114		dBc/Hz
		800kHz		-118		dBc/Hz
		1MHz		-120		dBc/Hz
		1.8MHz		-127		dBc/Hz
		5MHz		-135		dBc/Hz
		50MHz		-142		dBc/Hz
	Closed Loop Phase Noise F _{PLL} = 9.8403 GHz F _{REF} =491.52MHz	600kHz		-113		dBc/Hz
		800kHz		-116		dBc/Hz
		1MHz		-119		dBc/Hz
		1.8MHz		-125		dBc/Hz
		5MHz		-134		dBc/Hz
		50MHz		-140		dBc/Hz
	Closed Loop Phase Noise F _{PLL} = 7.86432GHz F _{REF} =491.52MHz	600kHz		-116		dBc/Hz
		800kHz		-119		dBc/Hz
		1MHz		-122		dBc/Hz
		1.8MHz		-127		dBc/Hz
		5MHz		-136		dBc/Hz
		50MHz		-143		dBc/Hz
F _{rms}	Clock PLL integrated phase error ⁽¹⁾	f _{PLL} =11.79848 GHz, [1KHz, 100MHz]		-43.4		dBc/Hz
		f _{PLL} =8.8536 GHz, [1KHz, 100MHz]		-47.6		dBc/Hz
		f _{PLL} =9.8304 GHz, [1KHz, 100MHz]		-46.2		dBc/Hz
f _{PFD}	PFD frequency		100		500	MHz
PN _{pll_flat}	Normalized PLL flat Noise	f _{VCO} = 11796.48MHz		-226.5		dBc/Hz
F _{REF}	Input Clock frequency		0.1		12	GHz
V _{SS}	Input Clock level		0.6		1.8	Vppdiff

7.7 PLL/VCO/Clock Electrical Characteristics (continued)

Typical values at $T_A = +25^\circ\text{C}$, full temperature range is $T_{A,\text{MIN}} = -40^\circ\text{C}$ to $T_{J,\text{MAX}} = +110^\circ\text{C}$; Reference clock input frequency 491.52MHz (unless otherwise noted), $f_{\text{DAC}} = f_{\text{VCO}}$, $f_{\text{OUT}} = f_{\text{DAC}}/4$, normalized to f_{VCO} .

PARAMETER		TEST CONDITIONS	MIN	TYP	MAX	UNIT
Coupling				AC Coupling Only		
	REFCLK input impedance ⁽²⁾	Parallel resistance		100		Ω
		Parallel capacitance		0.5		pF

- (1) Single Sideband, not including the reference clock contribution
 (2) Refer to S11 data available from TI for impedance vs frequency

7.8 Digital Electrical Characteristics

Typical values at TA = +25°C, full temperature range is T_{A,MIN} = -40°C to T_{J,MAX} = +110°C (unless otherwise noted)

PARAMETER		TEST CONDITIONS	MIN	TYP	MAX	UNIT
CML SerDes Inputs [8:1]SRX+/-						
V _{SRDIFF}	SerDes Receiver Input Amplitude	differential	100		1200	mVpp
V _{SRCOM}	SerDes Input Common Mode			400		mV
Z _{SRdiff}	SerDes Internal Differential Termination ⁽¹⁾			100		Ω
F _{SerDes}	SerDes Bit Rate	Full rate mode	19		29.5	Gbps
		Half rate mode	9.5		16.25	Gbps
		Quarter rate mode	4.75		8.125	Gbps
	Insertion Loss Tolerance ⁽²⁾	Serdes supply = 1.8V		25		dB
TJ	Total Jitter Tolerance				0.42	UI
CML SerDes Outputs [8:1]STX+/-						
V _{STDIFF}	SerDes Transmitter Output Amplitude	differential	500		1000	mVpp
V _{STCOM}	SerDes Output Common Mode		0.4	0.45	0.55	V
Z _{STdiff}	SerDes Output Impedance			100		Ω
TRF	Output rise and fall time	20-80%	8			ps
TEQS	Equalization range				7	dB
TTJ	Output total jitter				0.21	UI
CMOS I/O: GPIO{B/C/D/E}x, SPICLK, SPISDIO, SPISDO, SPISEN, RESETZ, BISTB0, BISTB1						
V _{IH}	High-Level Input Voltage		0.6×VDD1 P8GPIO			V
V _{IL}	Low-Level Input Voltage				0.4×VDD1 P8GPIO	V
I _{IH}	High-Level Input Current		-250		250	μA
I _{IL}	Low-Level Input Current		-250		250	μA
C _L	CMOS input capacitance			2		pF
V _{OH}	High-Level Input Voltage		VDD1P8G PIO-0.2			V
V _{OL}	Low-Level Input Voltage				0.2	V
Differential Inputs: SYSREF+/- Mode A						
F _{SYSREFMAX}	SYSREF Input Frequency Maximum			40		MHz
V _{SWINGSRMAX}	SYSREF Input Swing Maximum			1.8		Vppdiff ⁽³⁾
V _{SWINGSRMIN}	SYSREF Input Swing Minimum	f _{REF} < 500MHz		0.3		Vppdiff ⁽³⁾
V _{SWINGSRMIN}	SYSREF Input Swing Minimum	f _{REF} > 500MHz		0.6		Vppdiff ⁽³⁾
V _{COMSRMAX}	SYSREF Input Common Mode Voltage Maximum			0.8		V
V _{COMSRMIN}	SYSREF Input Common Mode Voltage Minimum			0.6		V
Z _T	Input termination	differential		100 ⁽¹⁾		Ω
C _L	Input capacitance	Each pin to GND		0.5		pF
LVDS Inputs: 0SYNCIN+/- and 1SYNCIN+/-						
V _{ICOM}	Input Common Voltage			1.2		V
V _{ID}	Differential Input Voltage swing			450		Vppdiff ⁽³⁾
Z _T	Input termination	differential		100		Ω
LVDS Outputs: 0SYNCOUT+/- and 1SYNCOUT+/-						
V _{OCOM}	Output Common Voltage			1.2		V
V _{OD}	Differential Output Voltage swing			500		Vppdiff ⁽³⁾

7.8 Digital Electrical Characteristics (continued)

Typical values at $T_A = +25^\circ\text{C}$, full temperature range is $T_{A,\text{MIN}} = -40^\circ\text{C}$ to $T_{J,\text{MAX}} = +110^\circ\text{C}$ (unless otherwise noted)

PARAMETER		TEST CONDITIONS	MIN	TYP	MAX	UNIT
Z_T	Internal Termination			100		Ω

- (1) SYSREF termination is programmable between 100 Ω , 150 Ω and 300 Ω
- (2) Loss tolerance is bump to bump from STX to SRX
- (3) V_{ppdiff} is the difference between the maximum differential voltage (positive value) and minimum differential voltage (negative value).

7.9 Power Supply Electrical Characteristics

Typical values at $T_A = +25^\circ\text{C}$, full temperature range is $T_{A,\text{MIN}} = -40^\circ\text{C}$ to $T_{J,\text{MAX}} = +110^\circ\text{C}$; TX Input Rate = 500MSPS, RX Output Rate = 500MSPS, $f_{\text{DAC}} = 9000\text{MSPS}$ interleave mode; $f_{\text{ADC}} = 3000\text{MSPS}$; nominal power supplies; 1 tone at -1 dBFS; DSA Attenuation = 0dB; SerDes rate = 20Gbps; unless otherwise noted.

PARAMETER		TEST CONDITIONS	MIN	TYP	MAX	UNIT	
I_{VDD1P8}	Group 3A: VDD1P8FB + VDD1P8RX + VDD1P8TX	Mode 1: 4T4R - TDD with TX 75%, RX 25% TX Dual Band: 72x Int, TX Rate 125 MSPS RX Dual Band: 24x Dec, RX Rate 125 MSPS $f_{\text{DAC}} = 9000\text{MSPS}$, $f_{\text{OUT}}=f_{\text{IN}} = 1.9, 2.6\text{ GHz}$ $f_{\text{ADC}} = 3000\text{MSPS}$ JESD: 8/10 coding, 20Gbps TX: 2-16-16-1, RX: 2-16-16-1		588		mA	
	Group 3B: VDD1P8FBCLK + VDD1P8RXCLK + VDD1P8TXDAC+ VDD1P8GPIO + VDDA1P8			439		mA	
	Group 3C: VDD1P8PLL + VDD1P8PLLVC0				74		mA
I_{VDD1P2}	Group 2: VDD1P2FB + VDD1P2RX + VDD1P2TXCLK + VDD1P2TXENC + VDD1P2FBCML + VDD1P2RXCML + VDD1P2PLLCLKREF				1191		mA
I_{VDD0P9}	Group 1A: DVDD0P9 + VDDT0P9				1928		mA
P_{diss}	Power Dissipation				5196		mW
I_{VDD1P8}	Group 3A: VDD1P8FB + VDD1P8RX + VDD1P8TX	Mode 2: 4T4R - FDD TX Dual Band: 96x Int, TX Rate 125 MSPS RX Dual Band: RX 24x, RX Rate 125 MSPS $f_{\text{DAC}} = 12\text{ GSPS}$, $f_{\text{TX}} = 1.85\text{ GHz}$ $f_{\text{ADC}} = 3\text{ GSPS}$, $f_{\text{RX}} = 1.75\text{ GHz}$ JESD: 8/10 coding, 20Gbps TX: 2-16-16-1, RX: 2-16-16-1		1146		mA	
	Group 3B: VDD1P8FBCLK + VDD1P8RXCLK + VDD1P8TXDAC+ VDD1P8GPIO + VDDA1P8				553		mA
	Group 3C: VDD1P8PLL + VDD1P8PLLVC0					78	
I_{VDD1P2}	Group 2: VDD1P2FB + VDD1P2RX + VDD1P2TXCLK + VDD1P2TXENC + VDD1P2FBCML + VDD1P2RXCML + VDD1P2PLLCLKREF				2152		mA
I_{VDD0P9}	Group 1A: DVDD0P9 + VDDT0P9				3217		mA
P_{diss}	Power Dissipation				8757		mW
I_{VDD1P8}	Group 3A: VDD1P8FB + VDD1P8RX + VDD1P8TX	Mode 3: 4T4R - FDD TX Single Band: 96x Int, TX Rate 125 MSPS RX Single Band: RX 24x, RX Rate 125 MSPS $f_{\text{DAC}} = 12\text{ GSPS}$, $f_{\text{TX}} = 1.85\text{ GHz}$ $f_{\text{ADC}} = 3\text{ GSPS}$, $f_{\text{RX}} = 1.75\text{ GHz}$ JESD: 8/10 coding, 20Gbps TX: 1-8-16-1, RX: 1-8-16-1		1146		mA	
	Group 3B: VDD1P8FBCLK + VDD1P8RXCLK + VDD1P8TXDAC+ VDD1P8GPIO + VDDA1P8				546		mA
	Group 3C: VDD1P8PLL + VDD1P8PLLVC0					78	
I_{VDD1P2}	Group 2: VDD1P2FB + VDD1P2RX + VDD1P2TXCLK + VDD1P2TXENC + VDD1P2FBCML + VDD1P2RXCML + VDD1P2PLLCLKREF				2144		mA
I_{VDD0P9}	Group 1A: DVDD0P9 + VDDT0P9				2904		mA
P_{diss}	Power Dissipation				8444		mW

7.9 Power Supply Electrical Characteristics (continued)

Typical values at $T_A = +25^\circ\text{C}$, full temperature range is $T_{A,\text{MIN}} = -40^\circ\text{C}$ to $T_{J,\text{MAX}} = +110^\circ\text{C}$; TX Input Rate = 500MSPS, RX Output Rate = 500MSPS, $f_{\text{DAC}} = 9000\text{MSPS}$ interleave mode; $f_{\text{ADC}} = 3000\text{MSPS}$; nominal power supplies; 1 tone at -1 dBFS; DSA Attenuation = 0dB; SerDes rate = 20Gbps; unless otherwise noted.

PARAMETER		TEST CONDITIONS	MIN	TYP	MAX	UNIT	
I_{VDD1P8}	Group 3A: VDD1P8FB + VDD1P8RX + VDD1P8TX	Mode 4: 4T4R - FDD TX Single Band: 24x Int, TX Rate 500 MSPS RX Single Band: RX 6x, RX Rate 500 MSPS		1147		mA	
	Group 3B: VDD1P8FBCLK + VDD1P8RXCLK + VDD1P8TXDAC + VDD1P8GPIO + VDDA1P8			700		mA	
	Group 3C: VDD1P8PLL + VDD1P8PLLCO			78		mA	
I_{VDD1P2}	Group 2: VDD1P2FB + VDD1P2RX + VDD1P2TXCLK + VDD1P2TXENC + VDD1P2FBCML + VDD1P2RXCML + VDD1P2PLLCLKREF	$f_{\text{DAC}} = 12\text{ GSPS}$, $f_{\text{TX}} = 1.85\text{ GHz}$ $f_{\text{ADC}} = 3\text{ GSPS}$, $f_{\text{RX}} = 1.75\text{ GHz}$ JESD: 8/10 coding, 20Gbps TX: 4-8-4-1, RX: 4-8-4-1		2150		mA	
I_{VDD0P9}	Group 1A: DVDD0P9 + VDDT0P9			3228		mA	
P_{diss}	Power Dissipation			9031		mW	
I_{VDD1P8}	Group 3A: VDD1P8FB + VDD1P8RX + VDD1P8TX	Mode 5: same configuration as Mode 4 Sleep Mode. SLEEP pin is pull high.		24		mA	
	Group 3B: VDD1P8FBCLK + VDD1P8RXCLK + VDD1P8TXDAC + VDD1P8GPIO + VDDA1P8			339		mA	
	Group 3C: VDD1P8PLL + VDD1P8PLLCO			12		mA	
I_{VDD1P2}	Group 2: VDD1P2FB + VDD1P2RX + VDD1P2TXCLK + VDD1P2TXENC + VDD1P2FBCML + VDD1P2RXCML + VDD1P2PLLCLKREF			58		mA	
I_{VDD0P9}	Group 1A: DVDD0P9 + VDDT0P9				282		mA
P_{diss}	Power Dissipation				1004		mW

7.10 Timing Requirements

Typical values at $T_A = +25^\circ\text{C}$, full temperature range is $T_{A,\text{MIN}} = -40^\circ\text{C}$ to $T_{J,\text{MAX}} = +110^\circ\text{C}$; TX Input Rate = 491.52MSPS, $f_{\text{DAC}} = 8847.36\text{MSPS}$; $f_{\text{ADC}} = 2949.12\text{MSPS}$; nominal power supplies; 1 tone at -1 dBFS; DSA Attenuation = 0dB; SerDes rate = 24.33Gbps; unless otherwise noted.

		MIN	NOM	MAX	UNIT
Timing: SYSREF+/-					
$t_{\text{s}}(\text{SYSREF})$	Setup Time, SYSREF+/- Valid to Rising Edge of CLK+/-		50		ps
$t_{\text{h}}(\text{SYSREF})$	Hold Time, SYSREF+/- Valid after Rising Edge of CLK+/-		50		ps
Timing: Serial ports					
$t_{\text{s}}(\text{SENB})$	Setup Time, SENB to Rising Edge of SCLK			15	ns
$t_{\text{h}}(\text{SENB})$	Hold Time, SENB after last Rising Edge of SCLK ⁽¹⁾		$5 + t_{\text{SCLK}}$		ns
$t_{\text{s}}(\text{SDIO})$	Setup Time, SDIO valid to Rising Edge of SCLK			15	ns
$t_{\text{h}}(\text{SDIO})$	Hold Time, SDIO valid after Rising Edge of SCLK			5	ns
$t_{\text{(SCLK)_W}}$	Minimum SCLK period: registers write			25	ns
$t_{\text{(SCLK)_R}}$	Minimum SCLK period: registers read			50	ns
$t_{\text{d}}(\text{data_out})$	Minimum Data Output delay after Falling Edge of SCLK			0	ns
	Maximum Data Output delay after Falling Edge of SCLK			15	ns
t_{RESET}	Minimum RESETZ Pulse Width		1		ms

(1) $\overline{\text{SDEN}}$ need to be held one more extra clock cycle with the last SCLK edge

7.11 Switching Characteristics

Typical values at $T_A = +25^\circ\text{C}$, full temperature range is $T_{A,\text{MIN}} = -40^\circ\text{C}$ to $T_{J,\text{MAX}} = +110^\circ\text{C}$; TX Input Rate = 491.52MSPS, $f_{\text{DAC}} = 8847.36\text{MSPS}$; $f_{\text{ADC}} = 2949.12\text{MSPS}$; nominal power supplies; 1 tone at -1 dBFS; DSA Attenuation = 0dB; SerDes rate = 24.33Gbps; unless otherwise noted.

PARAMETER		TEST CONDITIONS	MIN	TYP	MAX	UNIT
TX Channel Latency						
	SerDes Receiver Analog Delay	Full rate		2.8		ns
$t_{\text{JESD TX}}$	JESD to TX output Latency	LMFSHd=2-8-8-1, 368.64 MSPS input rate, 24x Interpolation, Serdes rate = 16.22Gbps (JESD204C)		152		interface clock cycles ⁽¹⁾
		LMFSHd=8-16-4-1, 491.52 MSPS 24x Interpolation, Serdes rate = 16.22Gbps (JESD204C)		176		
		LMFSHd=4-16-8-1, 245.76 MSPS 48x Interpolation, Serdes rate = 16.22Gbps (JESD204C)		124		
		LMFSHd=2-16-16-1, 122.88 MSPS 96x Interpolation, Serdes rate = 16.22Gbps (JESD204C)		97		
RX Channel Latency						
	SerDes Transmitter Analog Delay			3.6		ns
$t_{\text{JESD RX}}$	RX input to JESD output Latency	LMFS=2-16-16-1, 122.88 MSPS, 24x Decimation, Serdes rate = 16.22Gbps (JESD204C)		92		interface clock cycles ⁽¹⁾
		LMFS=4-16-8-1, 245.76 MSPS, 12x Decimation, Serdes rate = 16.22Gbps (JESD204C)		108		
		LMFS=2-8-8-1, 368.64 MSPS, 8x Decimation, Serdes rate = 16.22Gbps (JESD204C)		118		
		LMFS=4-8-4-1, 491.52 MSPS, 6x Decimation, Serdes rate = 16.22Gbps (JESD204C)		153		
FB Channel Latency						
	SerDes Transmitter Analog Delay			3.6		ns
$t_{\text{JESD FB}}$	FB input to JESD output Latency	LMFS=1-2-8-1, 368.64 MSPS, 8x Decimation		151		interface clock cycles ⁽¹⁾
		LMFS=2-4-4-1, 491.52 MSPS, 6x Decimation		177		

(1) Interface clock cycles is the period of the digital interface clock rate, e.g. 1GSPS = 1ns.

7.12 Typical Characteristics

7.12.1 RX Typical Characteristics 30 MHz and 400 MHz

Typical values at $T_A = +25^\circ\text{C}$. Default conditions at 30MHz: ADC Sampling Rate = 1500 MSPS, output sample rate = 62.5 MSPS (decimate by 24x), PLL clock mode with $f_{\text{REF}} = 500\text{ MHz}$, $A_{\text{IN}} = -3\text{ dBFS}$, DSA setting = 3 dB. Default conditions at 400 MHz: ADC Sampling Rate = 1500 MSPS, output sample rate = 125 MSPS (decimate by 12x), PLL clock mode with $f_{\text{REF}} = 500\text{ MHz}$, $A_{\text{IN}} = -3\text{ dBFS}$, DSA setting = 3 dB.

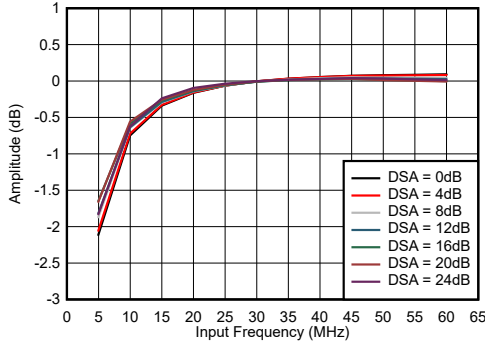

Normalized to 30 MHz
Figure 7-1. RX In-Band Gain Flatness, $f_{\text{IN}} = 30\text{ MHz}$

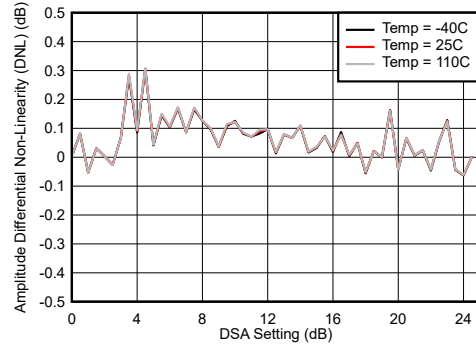

Differential Amplitude Error = $P_{\text{IN}}(\text{DSA Setting} - 1) - P_{\text{IN}}(\text{DSA Setting}) + 1$
Figure 7-2. RX Uncalibrated Differential Amplitude Error vs DSA Setting at 30 MHz

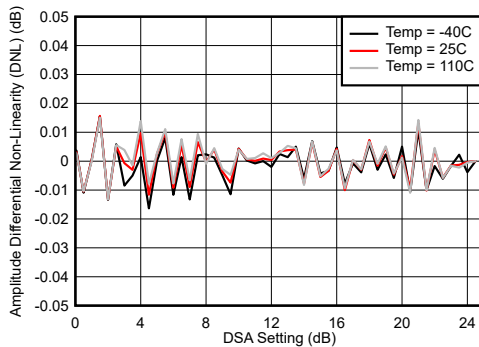

Differential Amplitude Error = $P_{\text{IN}}(\text{DSA Setting} - 1) - P_{\text{IN}}(\text{DSA Setting}) + 1$
Figure 7-3. RX Calibrated Differential Amplitude Error vs DSA Setting at 30 MHz

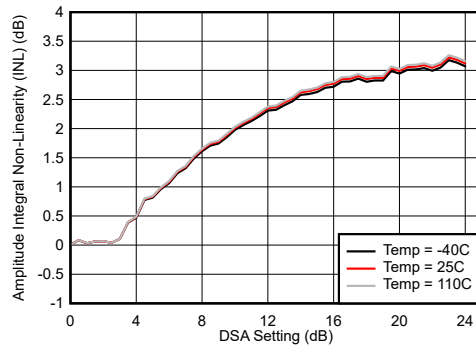

Integrated Amplitude Error = $P_{\text{IN}}(\text{DSA Setting}) - P_{\text{IN}}(\text{DSA Setting} = 0) + (\text{DSA Setting})$
Figure 7-4. RX Uncalibrated Integrated Amplitude Error vs DSA Setting at 30 MHz

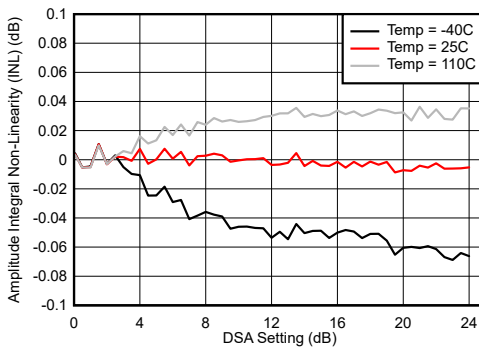

Integrated Amplitude Error = $P_{\text{IN}}(\text{DSA Setting}) - P_{\text{IN}}(\text{DSA Setting} = 0) + (\text{DSA Setting})$
Figure 7-5. RX Calibrated Integrated Amplitude Error vs DSA Setting at 30 MHz

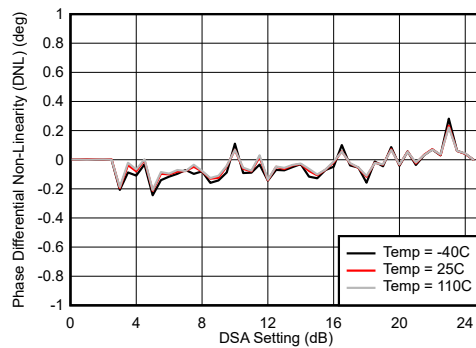

Differential Phase Error = $\text{Phase}_{\text{IN}}(\text{DSA Setting} - 1) - \text{Phase}_{\text{IN}}(\text{DSA Setting})$
Figure 7-6. RX Uncalibrated Differential Phase Error vs DSA Setting at 30 MHz

7.12.1 RX Typical Characteristics 30 MHz and 400 MHz (continued)

Typical values at $T_A = +25^\circ\text{C}$. Default conditions at 30MHz: ADC Sampling Rate = 1500 MSPS, output sample rate = 62.5 MSPS (decimate by 24x), PLL clock mode with $f_{REF} = 500$ MHz, $A_{IN} = -3$ dBFS, DSA setting = 3 dB. Default conditions at 400 MHz: ADC Sampling Rate = 1500 MSPS, output sample rate = 125 MSPS (decimate by 12x), PLL clock mode with $f_{REF} = 500$ MHz, $A_{IN} = -3$ dBFS, DSA setting = 3 dB.

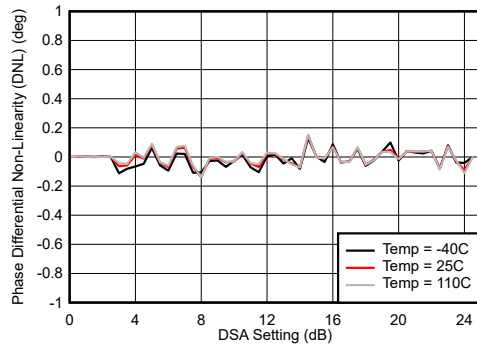

$$\text{Differential Phase Error} = \text{Phase}_{IN}(\text{DSA Setting} - 1) - \text{Phase}_{IN}(\text{DSA Setting})$$

Figure 7-7. RX Calibrated Differential Phase Error vs DSA Setting at 30 MHz

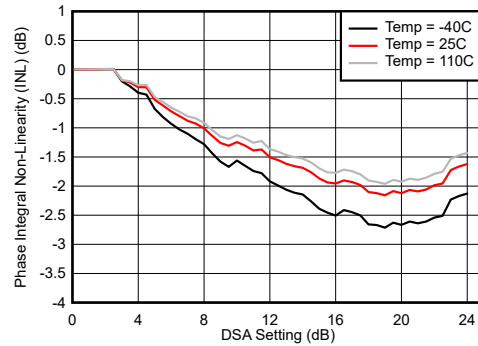

$$\text{Integrated Phase Error} = \text{Phase}(\text{DSA Setting}) - \text{Phase}(\text{DSA Setting} = 0)$$

Figure 7-8. RX Uncalibrated Integrated Phase Error vs DSA Setting at 30 MHz

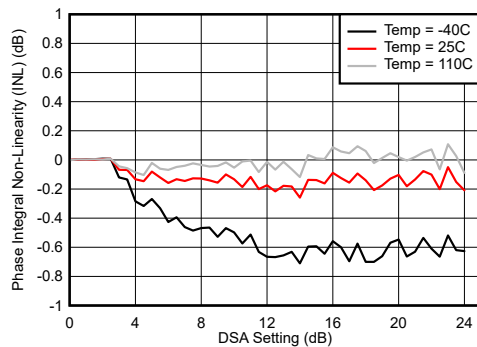

With 0.8 GHz matching

$$\text{Integrated Phase Error} = \text{Phase}(\text{DSA Setting}) - \text{Phase}(\text{DSA Setting} = 0)$$

Figure 7-9. RX Calibrated Integrated Phase Error vs DSA Setting at 30 MHz

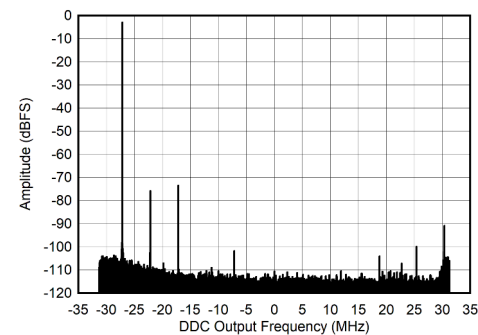

$A_{IN} = -3$ dBFS, $f_{ADC} = 1500$ MSPS, $f_{NCO} = 32.13$ MHz, Decimate by 24x

Figure 7-10. RX Output FFT at 5 MHz

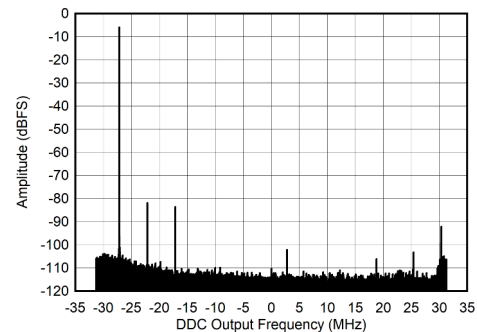

$A_{IN} = -6$ dBFS, $f_{ADC} = 1500$ MSPS, $f_{NCO} = 32.$, Decimate by 24x

Figure 7-11. RX Output FFT at 5 MHz

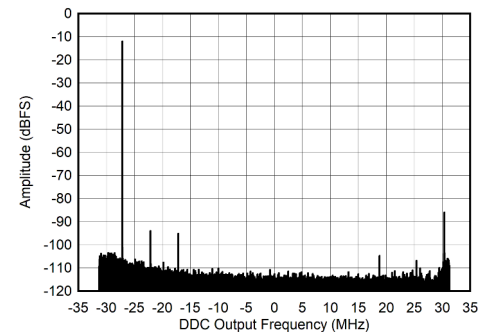

$A_{IN} = -12$ dBFS, $f_{ADC} = 1500$ MSPS, $f_{NCO} = 32.13$ MHz, Decimate by 24x

Figure 7-12. RX Output FFT at 5 MHz

7.12.1 RX Typical Characteristics 30 MHz and 400 MHz (continued)

Typical values at $T_A = +25^\circ\text{C}$. Default conditions at 30MHz: ADC Sampling Rate = 1500 MSPS, output sample rate = 62.5 MSPS (decimate by 24x), PLL clock mode with $f_{\text{REF}} = 500\text{ MHz}$, $A_{\text{IN}} = -3\text{ dBFS}$, DSA setting = 3 dB. Default conditions at 400 MHz: ADC Sampling Rate = 1500 MSPS, output sample rate = 125 MSPS (decimate by 12x), PLL clock mode with $f_{\text{REF}} = 500\text{ MHz}$, $A_{\text{IN}} = -3\text{ dBFS}$, DSA setting = 3 dB.

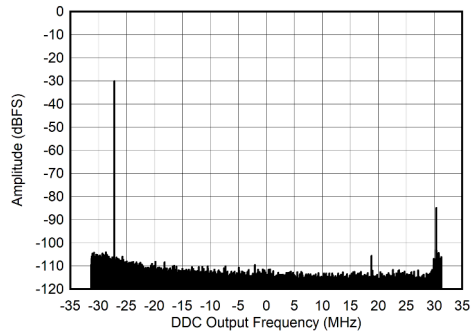

$A_{\text{IN}} = -30\text{ dBFS}$, $f_{\text{ADC}} = 1500\text{ MSPS}$, $f_{\text{NCO}} = 32.13\text{ MHz}$,
Decimate by 24x

Figure 7-13. RX Output FFT at 5 MHz

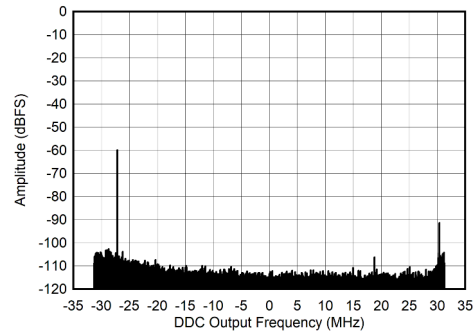

$A_{\text{IN}} = -60\text{ dBFS}$, $f_{\text{ADC}} = 1500\text{ MSPS}$, $f_{\text{NCO}} = 32.13\text{ MHz}$,
Decimate by 24x

Figure 7-14. RX Output FFT at 5 MHz

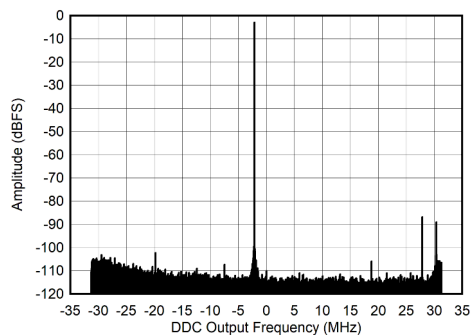

$A_{\text{IN}} = -3\text{ dBFS}$, $f_{\text{ADC}} = 1500\text{ MSPS}$, $f_{\text{NCO}} = 32.13\text{ MHz}$,
Decimate by 24x

Figure 7-15. RX Output FFT at 30 MHz

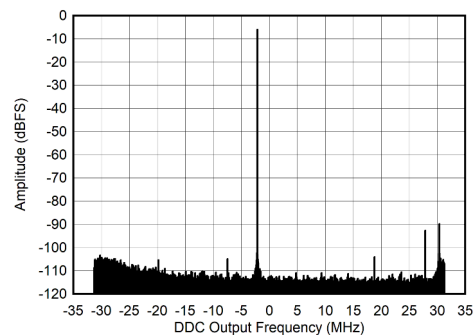

$A_{\text{IN}} = -6\text{ dBFS}$, $f_{\text{ADC}} = 1500\text{ MSPS}$, $f_{\text{NCO}} = 32.13\text{ MHz}$,
Decimate by 24x

Figure 7-16. RX Output FFT at 30 MHz

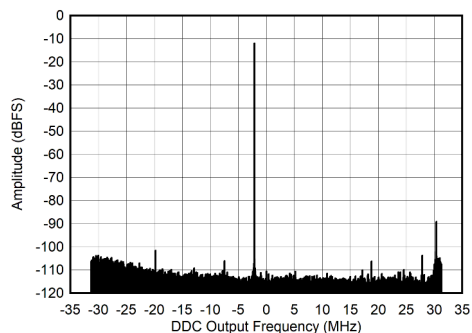

$A_{\text{IN}} = -12\text{ dBFS}$, $f_{\text{ADC}} = 1500\text{ MSPS}$, $f_{\text{NCO}} = 32.13\text{ MHz}$,
Decimate by 24x

Figure 7-17. RX Output FFT at 30 MHz

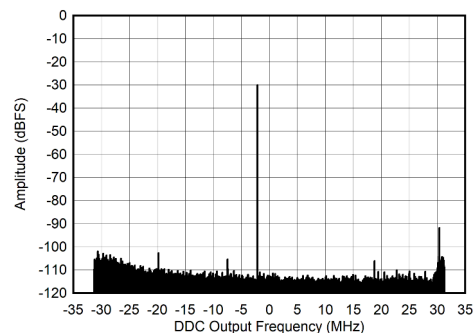

$A_{\text{IN}} = -30\text{ dBFS}$, $f_{\text{ADC}} = 1500\text{ MSPS}$, $f_{\text{NCO}} = 32.13\text{ MHz}$,
Decimate by 24x

Figure 7-18. RX Output FFT at 30 MHz

7.12.1 RX Typical Characteristics 30 MHz and 400 MHz (continued)

Typical values at $T_A = +25^\circ\text{C}$. Default conditions at 30MHz: ADC Sampling Rate = 1500 MSPS, output sample rate = 62.5 MSPS (decimate by 24x), PLL clock mode with $f_{\text{REF}} = 500$ MHz, $A_{\text{IN}} = -3$ dBFS, DSA setting = 3 dB. Default conditions at 400 MHz: ADC Sampling Rate = 1500 MSPS, output sample rate = 125 MSPS (decimate by 12x), PLL clock mode with $f_{\text{REF}} = 500$ MHz, $A_{\text{IN}} = -3$ dBFS, DSA setting = 3 dB.

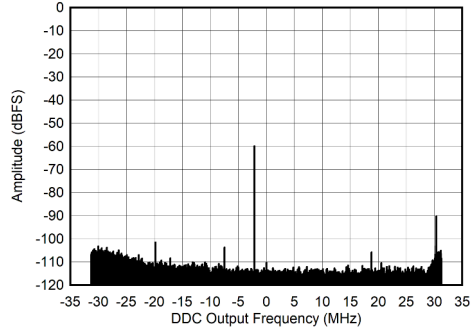

$A_{\text{IN}} = -60$ dBFS, $f_{\text{ADC}} = 1500$ MSPS, $f_{\text{NCO}} = 32.13$ MHz, Decimate by 24x

Figure 7-19. RX Output FFT at 30 MHz

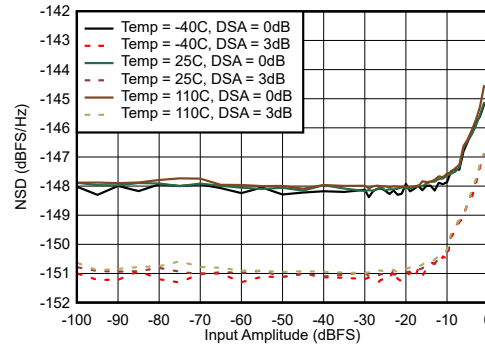

$f_{\text{ADC}} = 1500$ MSPS, $f_{\text{NCO}} = 32.13$ MHz, Decimate by 24x

Figure 7-20. NSD vs Input Amplitude at 30 MHz with DSA = 0 and 3dB

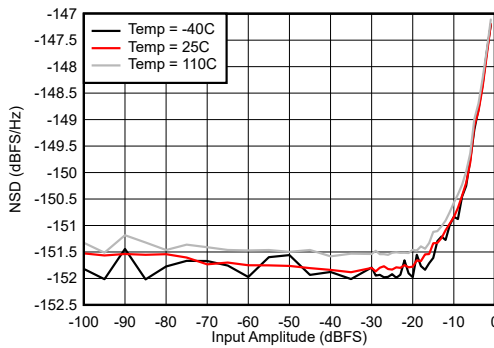

$f_{\text{ADC}} = 1500$ MSPS, $f_{\text{NCO}} = 32.13$ MHz, Decimate by 24x

Figure 7-21. NSD vs Input Amplitude at 30 MHz with DSA = 12

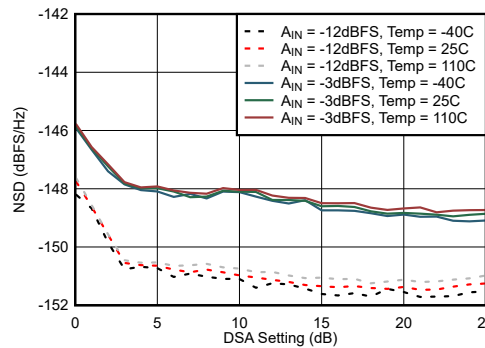

$f_{\text{ADC}} = 1500$ MSPS, $f_{\text{NCO}} = 32.13$ MHz, Decimate by 24x

Figure 7-22. NSD vs DSA Attenuation at 30 MHz

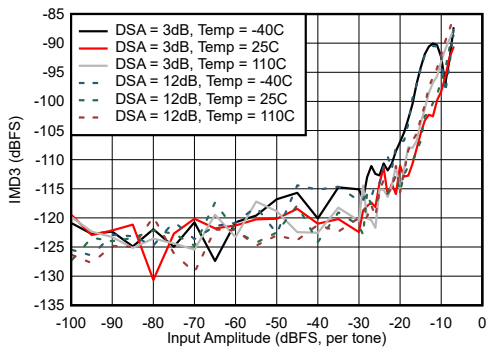

$f_{\text{ADC}} = 1500$ MSPS, $f_{\text{NCO}} = 32.13$ MHz, Decimate by 24x

Figure 7-23. IMD3 vs Input Amplitude at 30 MHz

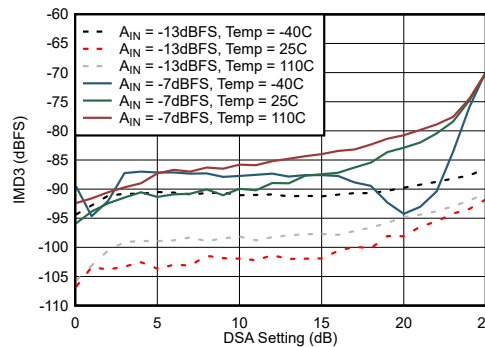

$f_{\text{ADC}} = 1500$ MSPS, $f_{\text{NCO}} = 32.13$ MHz, Decimate by 24x

Figure 7-24. IMD3 vs DSA Setting at 30 MHz

7.12.1 RX Typical Characteristics 30 MHz and 400 MHz (continued)

Typical values at $T_A = +25^\circ\text{C}$. Default conditions at 30MHz: ADC Sampling Rate = 1500 MSPS, output sample rate = 62.5 MSPS (decimate by 24x), PLL clock mode with $f_{REF} = 500\text{ MHz}$, $A_{IN} = -3\text{ dBFS}$, DSA setting = 3 dB. Default conditions at 400 MHz: ADC Sampling Rate = 1500 MSPS, output sample rate = 125 MSPS (decimate by 12x), PLL clock mode with $f_{REF} = 500\text{ MHz}$, $A_{IN} = -3\text{ dBFS}$, DSA setting = 3 dB.

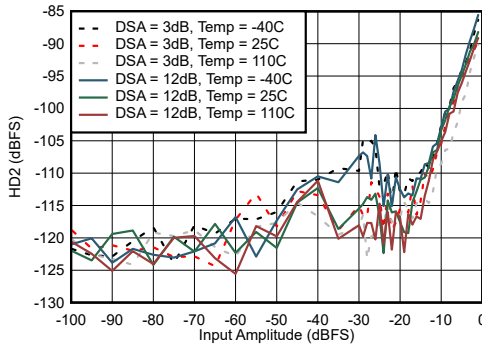

$f_{ADC} = 1500\text{ MSPS}$, $f_{NCO} = 32.13\text{ MHz}$, Decimate by 24x

Figure 7-25. HD2 vs Input Amplitude at 30 MHz

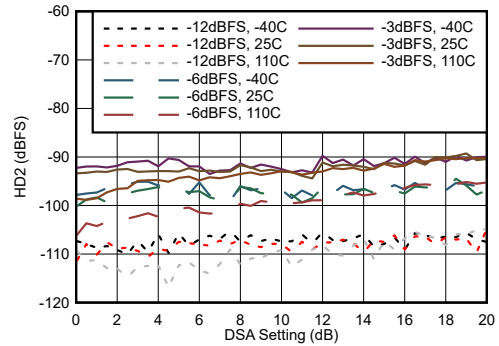

$f_{ADC} = 1500\text{ MSPS}$, $f_{NCO} = 32.$, Decimate by 24x

Figure 7-26. HD2 vs DSA Setting at 30 MHz

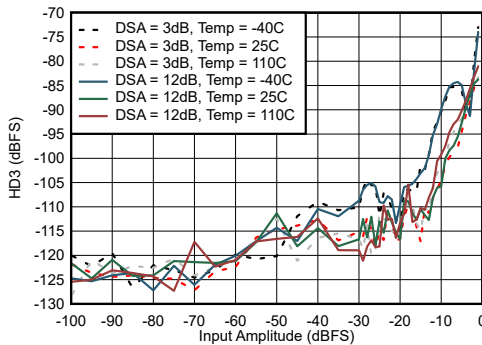

$f_{ADC} = 1500\text{ MSPS}$, $f_{NCO} = 32.13\text{ MHz}$, Decimate by 24x

Figure 7-27. HD3 vs Input Amplitude at 30 MHz

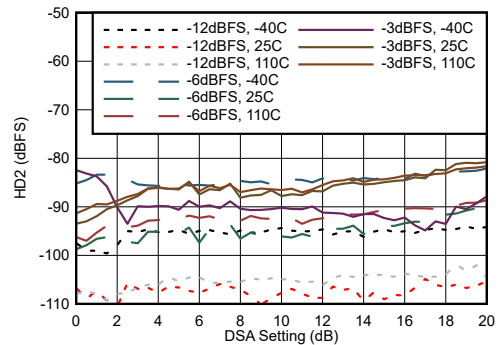

$f_{ADC} = 1500\text{ MSPS}$, $f_{NCO} = 32.13\text{ MHz}$, Decimate by 24x

Figure 7-28. HD3 vs DSA Setting at 30 MHz

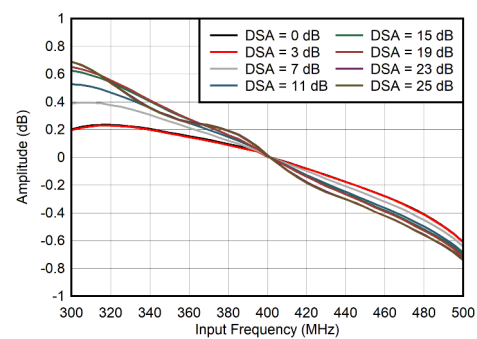

Normalized to 4000 MHz

Figure 7-29. RX In-Band Gain Flatness, $f_{IN} = 400\text{ MHz}$

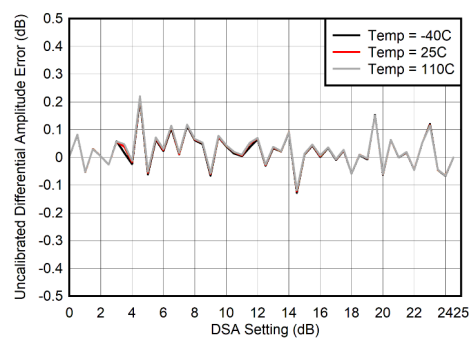

Differential Amplitude Error = $P_{IN}(\text{DSA Setting} - 1) - P_{IN}(\text{DSA Setting}) + 1$

Figure 7-30. RX Uncalibrated Differential Amplitude Error vs DSA Setting at 30 MHz

7.12.1 RX Typical Characteristics 30 MHz and 400 MHz (continued)

Typical values at $T_A = +25^\circ\text{C}$. Default conditions at 30MHz: ADC Sampling Rate = 1500 MSPS, output sample rate = 62.5 MSPS (decimate by 24x), PLL clock mode with $f_{REF} = 500\text{ MHz}$, $A_{IN} = -3\text{ dBFS}$, DSA setting = 3 dB. Default conditions at 400 MHz: ADC Sampling Rate = 1500 MSPS, output sample rate = 125 MSPS (decimate by 12x), PLL clock mode with $f_{REF} = 500\text{ MHz}$, $A_{IN} = -3\text{ dBFS}$, DSA setting = 3 dB.

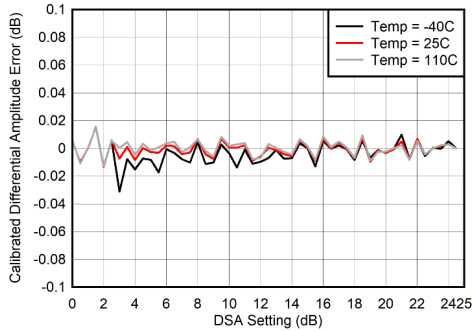

$$\text{Differential Amplitude Error} = P_{IN}(\text{DSA Setting} - 1) - P_{IN}(\text{DSA Setting}) + 1$$

Figure 7-31. RX Calibrated Differential Amplitude Error vs DSA Setting at 400 MHz

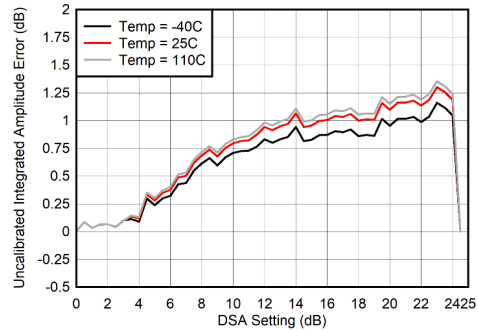

$$\text{Integrated Amplitude Error} = P_{IN}(\text{DSA Setting}) - P_{IN}(\text{DSA Setting} = 0) + (\text{DSA Setting})$$

Figure 7-32. RX Uncalibrated Integrated Amplitude Error vs DSA Setting at 400 MHz

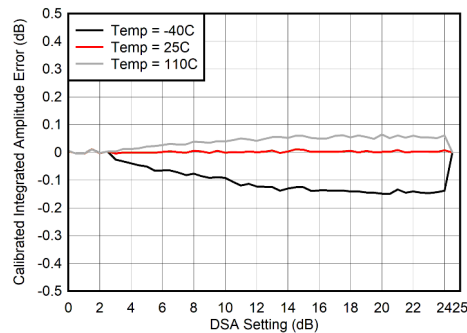

$$\text{Integrated Amplitude Error} = P_{IN}(\text{DSA Setting}) - P_{IN}(\text{DSA Setting} = 0) + (\text{DSA Setting})$$

Figure 7-33. RX Calibrated Integrated Amplitude Error vs DSA Setting at 400 MHz

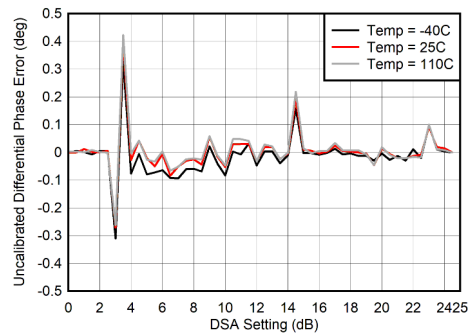

$$\text{Differential Phase Error} = \text{Phase}_{IN}(\text{DSA Setting} - 1) - \text{Phase}_{IN}(\text{DSA Setting})$$

Figure 7-34. RX Uncalibrated Differential Phase Error vs DSA Setting at 400 MHz

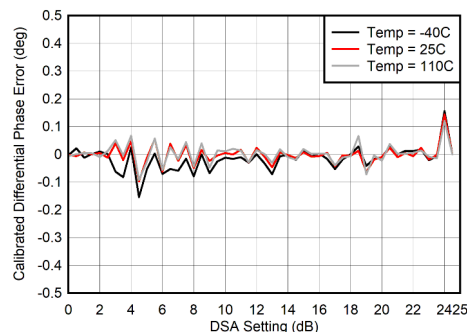

$$\text{Differential Phase Error} = \text{Phase}_{IN}(\text{DSA Setting} - 1) - \text{Phase}_{IN}(\text{DSA Setting})$$

Figure 7-35. RX Calibrated Differential Phase Error vs DSA Setting at 400 MHz

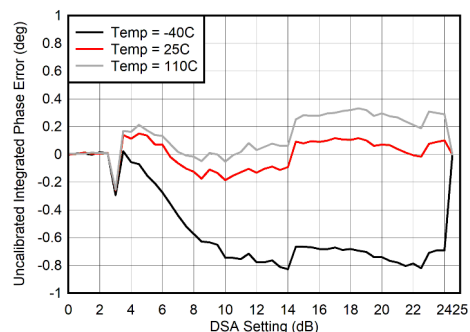

$$\text{Integrated Phase Error} = \text{Phase}(\text{DSA Setting}) - \text{Phase}(\text{DSA Setting} = 0)$$

Figure 7-36. RX Uncalibrated Integrated Phase Error vs DSA Setting at 400 MHz

7.12.1 RX Typical Characteristics 30 MHz and 400 MHz (continued)

Typical values at $T_A = +25^\circ\text{C}$. Default conditions at 30MHz: ADC Sampling Rate = 1500 MSPS, output sample rate = 62.5 MSPS (decimate by 24x), PLL clock mode with $f_{REF} = 500$ MHz, $A_{IN} = -3$ dBFS, DSA setting = 3 dB. Default conditions at 400 MHz: ADC Sampling Rate = 1500 MSPS, output sample rate = 125 MSPS (decimate by 12x), PLL clock mode with $f_{REF} = 500$ MHz, $A_{IN} = -3$ dBFS, DSA setting = 3 dB.

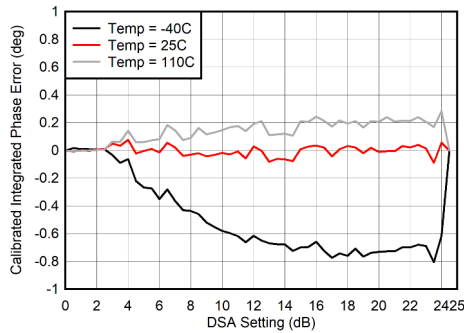

Integrated Phase Error = Phase(DSA Setting) – Phase(DSA Setting = 0)

Figure 7-37. RX Calibrated Integrated Phase Error vs DSA Setting at 400 MHz

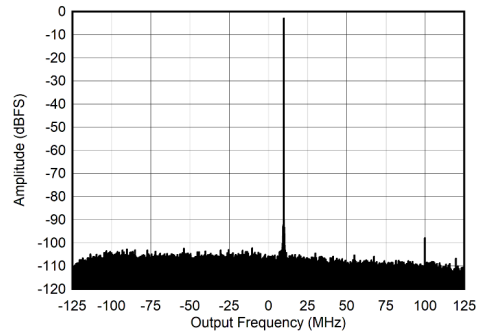

$f_{NCO} = 400$ MHz

Figure 7-38. RX Output FFT at 405 MHz and -3 dBFS

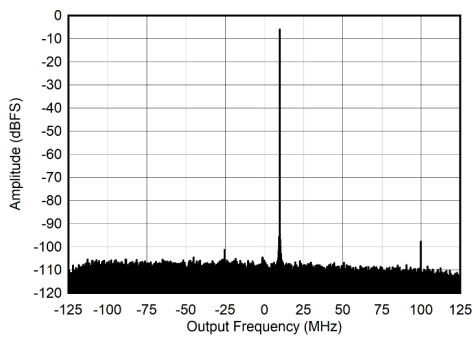

$f_{NCO} = 400$ MHz

Figure 7-39. RX Output FFT at 405 MHz and -6 dBFS

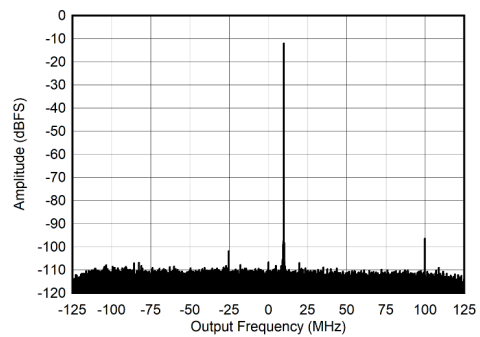

$f_{NCO} = 400$ MHz

Figure 7-40. RX Output FFT at 405 MHz and -12 dBFS

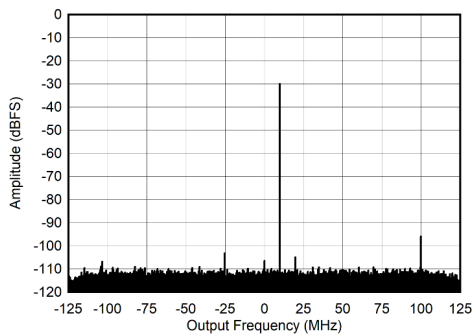

$f_{NCO} = 400$ MHz

Figure 7-41. RX Output FFT at 405 MHz and -30 dBFS

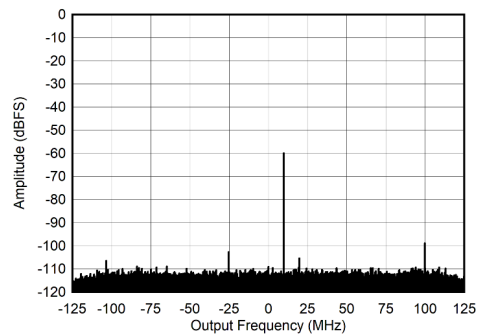

$f_{NCO} = 400$ MHz

Figure 7-42. RX Output FFT at 405 MHz and -60 dBFS

7.12.1 RX Typical Characteristics 30 MHz and 400 MHz (continued)

Typical values at $T_A = +25^\circ\text{C}$. Default conditions at 30MHz: ADC Sampling Rate = 1500 MSPS, output sample rate = 62.5 MSPS (decimate by 24x), PLL clock mode with $f_{REF} = 500\text{ MHz}$, $A_{IN} = -3\text{ dBFS}$, DSA setting = 3 dB. Default conditions at 400 MHz: ADC Sampling Rate = 1500 MSPS, output sample rate = 125 MSPS (decimate by 12x), PLL clock mode with $f_{REF} = 500\text{ MHz}$, $A_{IN} = -3\text{ dBFS}$, DSA setting = 3 dB.

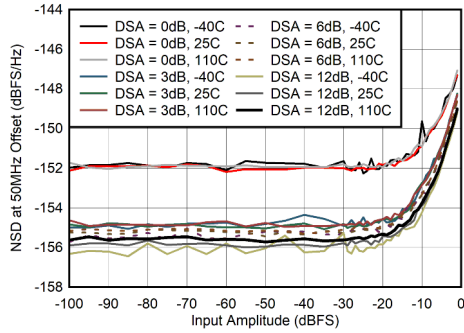

$f_{OFFSET} = 50\text{ MHz}$

Figure 7-43. NSD vs Input Amplitude at 400 MHz

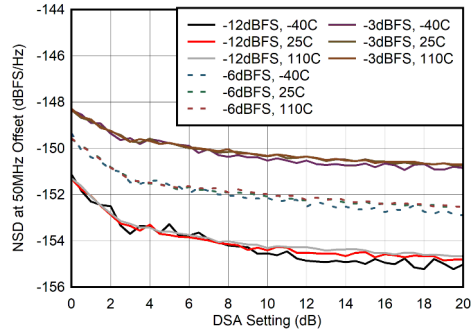

$f_{OFFSET} = 50\text{ MHz}$

Figure 7-44. NSD vs DSA Setting at 400 MHz

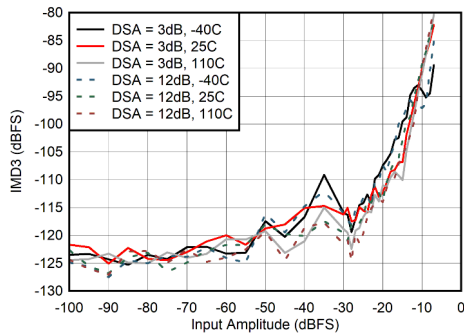

Figure 7-45. IMD3 vs Input Amplitude at 400 MHz

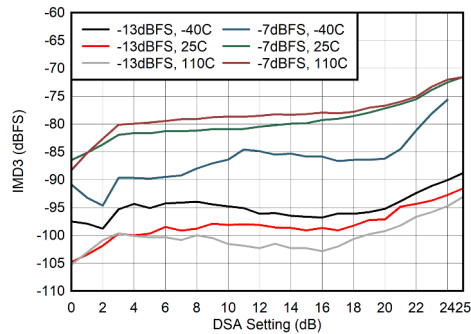

Figure 7-46. IMD3 vs DSA Setting at 400 MHz

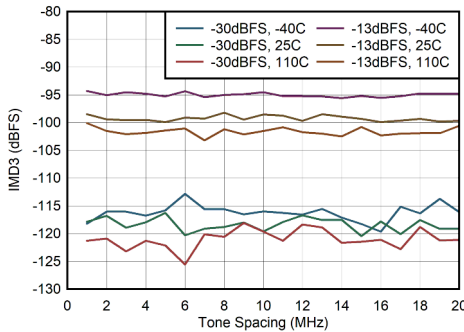

Figure 7-47. IMD3 vs Tone Spacing at 400 MHz

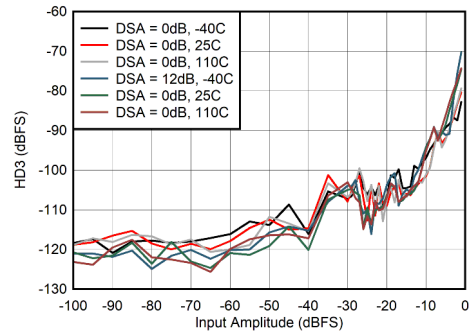

Figure 7-48. HD3 vs Input Amplitude at 400 MHz

7.12.1 RX Typical Characteristics 30 MHz and 400 MHz (continued)

Typical values at $T_A = +25^\circ\text{C}$. Default conditions at 30MHz: ADC Sampling Rate = 1500 MSPS, output sample rate = 62.5 MSPS (decimate by 24x), PLL clock mode with $f_{REF} = 500$ MHz, $A_{IN} = -3$ dBFS, DSA setting = 3 dB. Default conditions at 400 MHz: ADC Sampling Rate = 1500 MSPS, output sample rate = 125 MSPS (decimate by 12x), PLL clock mode with $f_{REF} = 500$ MHz, $A_{IN} = -3$ dBFS, DSA setting = 3 dB.

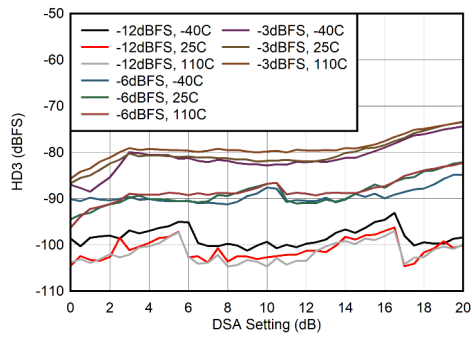
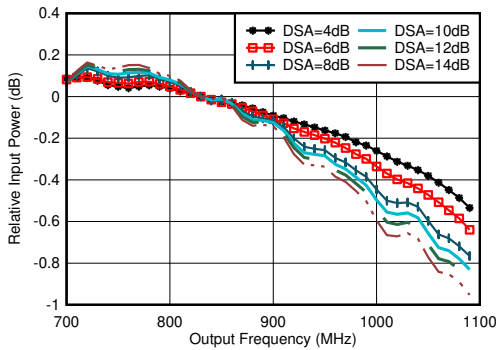

Figure 7-49. HD3 vs DSA Setting at 400 MHz

7.12.2 RX Typical Characteristics at 800 MHz

Typical values at $T_A = +25^\circ\text{C}$, ADC Sampling Rate = 2949.12 GHz. Default conditions: output sample rate = 491.52MSPS (decimate by 6), PLL clock mode with $f_{REF} = 491.52\text{MHz}$, $A_{IN} = -3\text{ dBFS}$, DSA setting = 4 dB.



With 0.8 GHz matching, normalized to 830 MHz

Figure 7-50. RX In-Band Gain Flatness for Channel 1RX, $f_{IN} = 830\text{ MHz}$

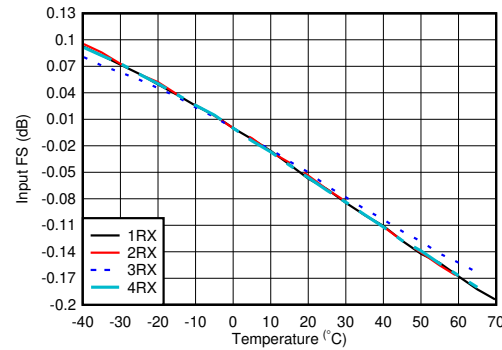

With 0.8 GHz matching, normalized to fullscale at 25°C for each channel

Figure 7-51. RX Input Fullscale vs Temperature and Channel at 800 MHz

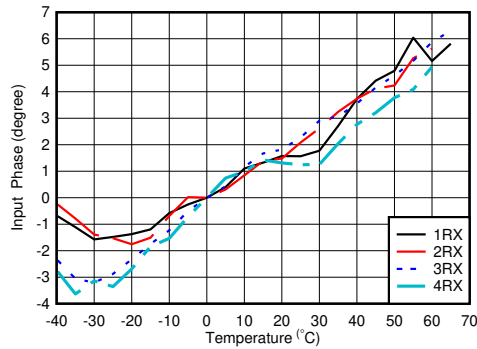

With 0.8 GHz matching, normalized to phase at 25°C

Figure 7-52. RX Input Phase vs Temperature and DSA at $f_{OUT} = 0.8\text{ GHz}$

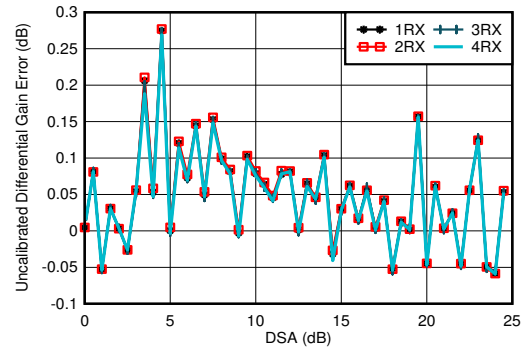

With 0.8 GHz matching

Differential Amplitude Error = $P_{IN}(\text{DSA Setting} - 1) - P_{IN}(\text{DSA Setting}) + 1$

Figure 7-53. RX Uncalibrated Differential Amplitude Error vs DSA Setting at 0.8 GHz

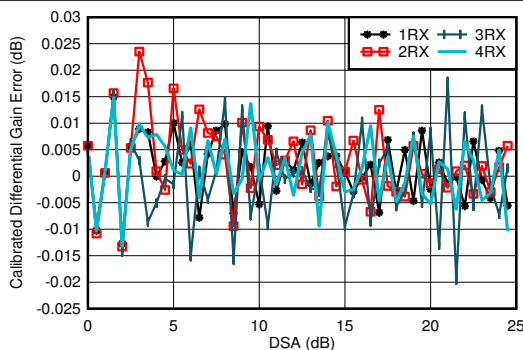

With 0.8 GHz matching

Differential Amplitude Error = $P_{IN}(\text{DSA Setting} - 1) - P_{IN}(\text{DSA Setting}) + 1$

Figure 7-54. RX Calibrated Differential Amplitude Error vs DSA Setting at 0.8 GHz

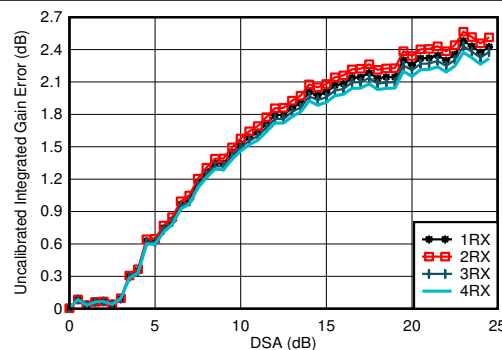

With 0.8 GHz matching

Integrated Amplitude Error = $P_{IN}(\text{DSA Setting}) - P_{IN}(\text{DSA Setting} = 0) + (\text{DSA Setting})$

Figure 7-55. RX Uncalibrated Integrated Amplitude Error vs DSA Setting at 0.8 GHz

7.12.2 RX Typical Characteristics at 800 MHz (continued)

Typical values at $T_A = +25^\circ\text{C}$, ADC Sampling Rate = 2949.12 GHz. Default conditions: output sample rate = 491.52MSPS (decimate by 6), PLL clock mode with $f_{REF} = 491.52\text{MHz}$, $A_{IN} = -3\text{ dBFS}$, DSA setting = 4 dB.

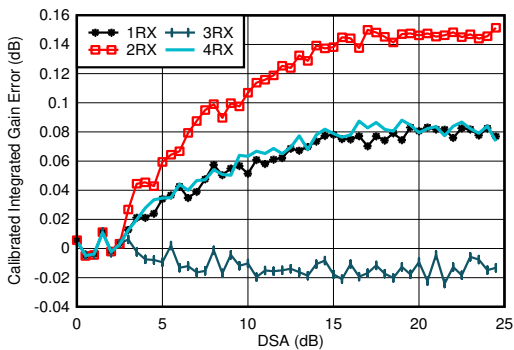

With 0.8 GHz matching
 Integrated Amplitude Error = $P_{IN}(\text{DSA Setting}) - P_{IN}(\text{DSA Setting} = 0) + (\text{DSA Setting})$

Figure 7-56. RX Calibrated Integrated Amplitude Error vs DSA Setting at 2.6 GHz

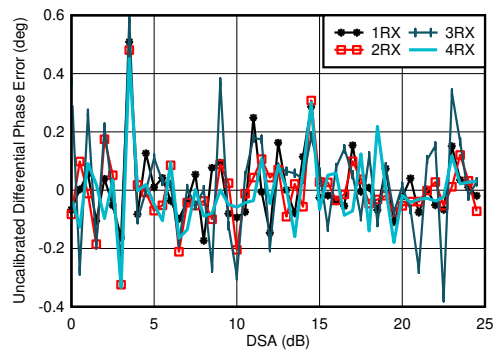

With 0.8 GHz matching
 Differential Phase Error = $\text{Phase}_{IN}(\text{DSA Setting} - 1) - \text{Phase}_{IN}(\text{DSA Setting})$

Figure 7-57. RX Uncalibrated Differential Phase Error vs DSA Setting at 0.8 GHz

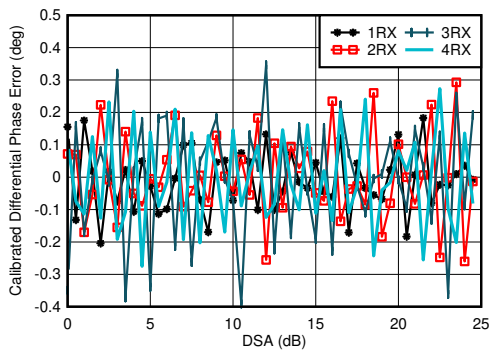

With 0.8 GHz matching
 Differential Phase Error = $\text{Phase}_{IN}(\text{DSA Setting} - 1) - \text{Phase}_{IN}(\text{DSA Setting})$

Figure 7-58. RX Calibrated Differential Phase Error vs DSA Setting at 0.8 GHz

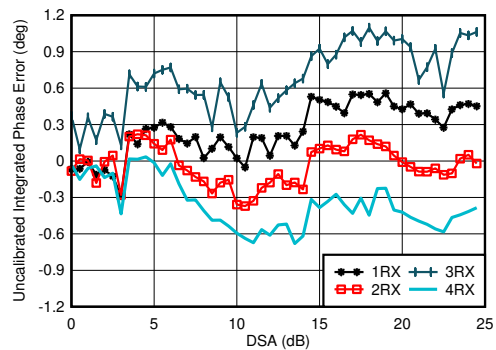

With 0.8 GHz matching
 Integrated Phase Error = $\text{Phase}(\text{DSA Setting}) - \text{Phase}(\text{DSA Setting} = 0)$

Figure 7-59. RX Uncalibrated Integrated Phase Error vs DSA Setting at 0.8 GHz

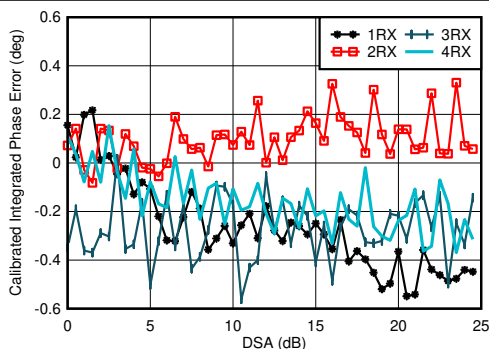

With 0.8 GHz matching
 Integrated Phase Error = $\text{Phase}(\text{DSA Setting}) - \text{Phase}(\text{DSA Setting} = 0)$

Figure 7-60. RX Calibrated Integrated Phase Error vs DSA Setting at 0.8 GHz

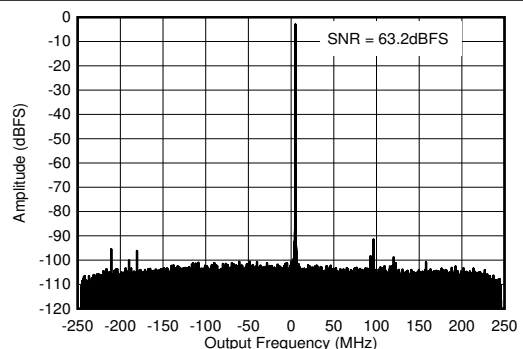

With 0.8 GHz matching, $f_{IN} = 840\text{ MHz}$, $A_{IN} = -3\text{ dBFS}$

Figure 7-61. RX Output FFT at 0.8 GHz

7.12.2 RX Typical Characteristics at 800 MHz (continued)

Typical values at $T_A = +25^\circ\text{C}$, ADC Sampling Rate = 2949.12 GHz. Default conditions: output sample rate = 491.52MSPS (decimate by 6), PLL clock mode with $f_{REF} = 491.52\text{MHz}$, $A_{IN} = -3\text{ dBFS}$, DSA setting = 4 dB.

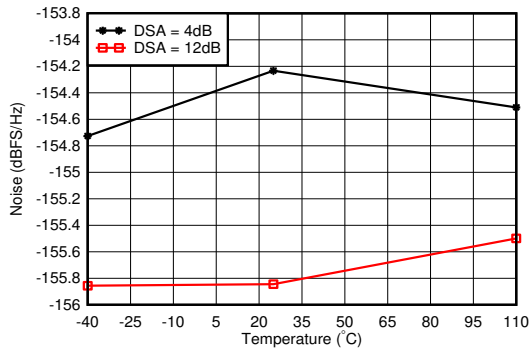

With 0.8 GHz matching, 12.5-MHz offset from tone

Figure 7-62. RX Noise Spectral Density vs Temperature at 0.8 GHz

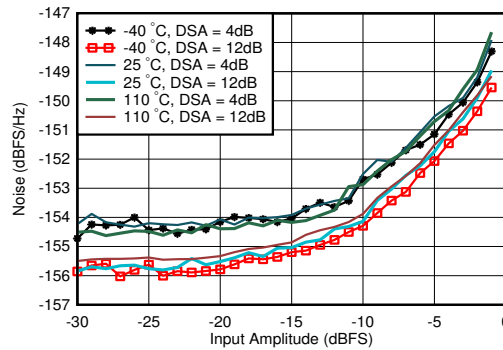

With 0.8 GHz matching, DSA Setting = 12 dB, 12.5-MHz offset from tone

Figure 7-63. RX Noise Spectral Density vs Input Amplitude and Temperature at 0.8 GHz

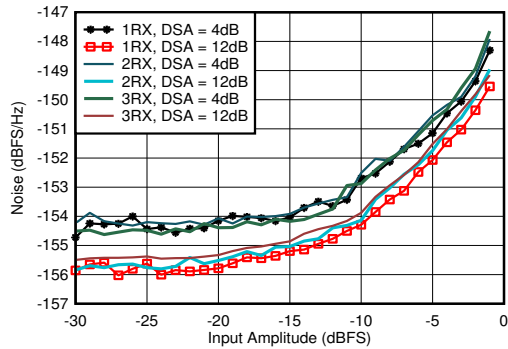

With 0.8 GHz matching, 12.5-MHz offset from tone

Figure 7-64. RX Noise Spectral Density vs Input Amplitude and Channel at 0.8 GHz

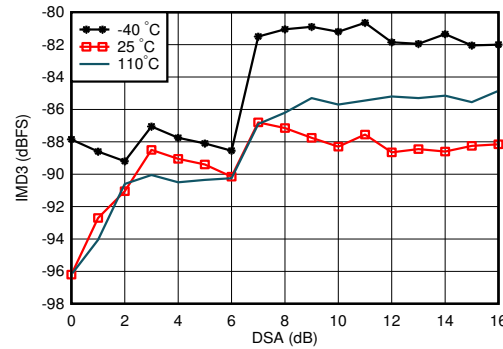

A. With 0.8 GHz matching, each tone -7 dBFS , tone spacing = 20 MHz

Figure 7-65. RX IMD3 vs DSA Setting and Temperature at 0.8 GHz

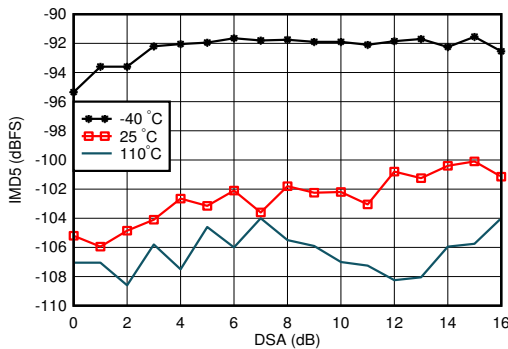

With 0.8 GHz matching, each tone -7 dBFS , tone spacing = 20 MHz

Figure 7-66. RX IMD5 vs DSA Setting and Temperature at 0.8 GHz

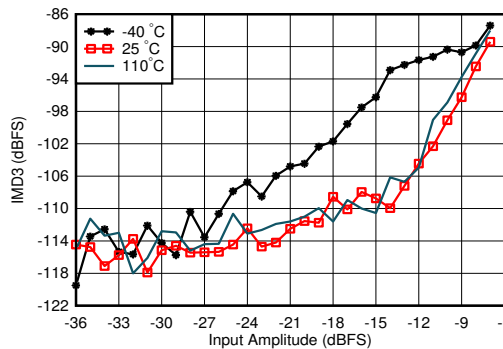

With 0.8 GHz matching, tone spacing = 20 MHz, DSA = 4 dB

Figure 7-67. RX IMD3 vs Input Level and Temperature at 0.8 GHz

7.12.2 RX Typical Characteristics at 800 MHz (continued)

Typical values at $T_A = +25^\circ\text{C}$, ADC Sampling Rate = 2949.12 GHz. Default conditions: output sample rate = 491.52MSPS (decimate by 6), PLL clock mode with $f_{REF} = 491.52\text{MHz}$, $A_{IN} = -3\text{dBFS}$, DSA setting = 4 dB.

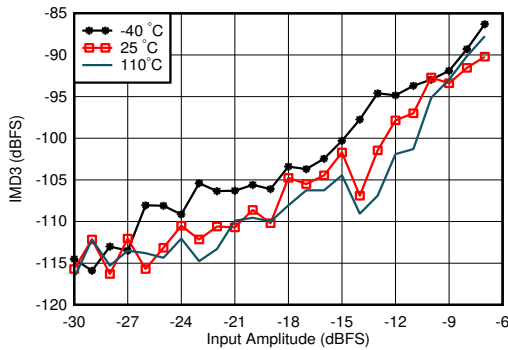

With 0.8 GHz matching, tone spacing = 20 MHz, DSA = 12 dB

Figure 7-68. RX IMD3 vs Input Level and Temperature at 0.8 GHz

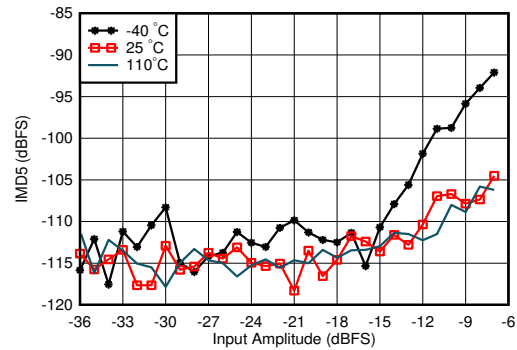

With 0.8 GHz matching, tone spacing = 20 MHz, DSA = 12 dB

Figure 7-69. RX IMD5 vs Input Level and Temperature at 0.8 GHz

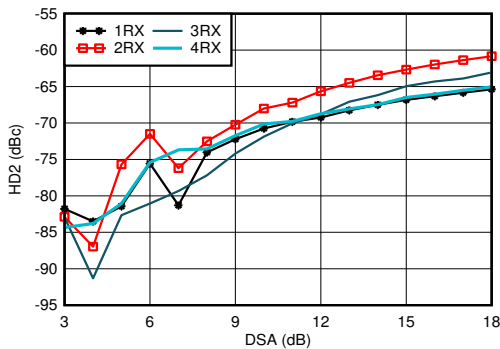

With 0.8 GHz matching, measured after HD2 trim, DDC bypass mode (TI only mode for characterization)

Figure 7-70. RX HD2 vs DSA Setting and Channel at 0.8 GHz

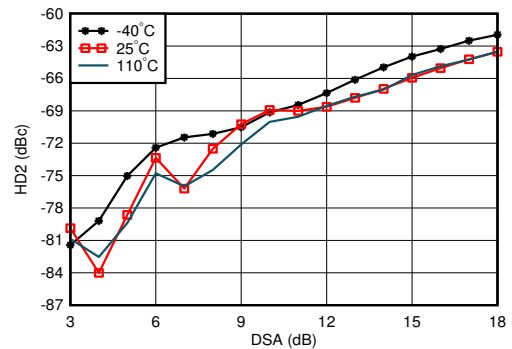

With 0.8 GHz matching, measured after HD2 trim, DDC bypass mode (TI only mode for characterization)

Figure 7-71. RX HD2 vs DSA Setting and Temperature at 0.8 GHz

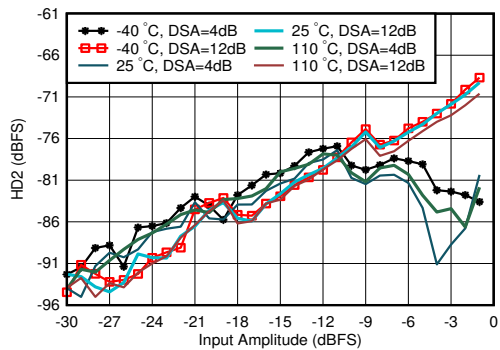

With 0.8 GHz matching, measured after HD2 trim, DDC bypass mode (TI only mode for characterization)

Figure 7-72. RX HD2 vs Input Level and Temperature at 0.8 GHz

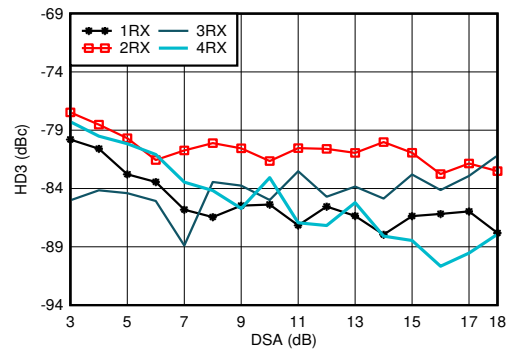

With 0.8 GHz matching, DDC bypass mode (TI only mode for characterization)

Figure 7-73. RX HD3 vs DSA Setting and Channel at 0.8 GHz

7.12.2 RX Typical Characteristics at 800 MHz (continued)

Typical values at $T_A = +25^\circ\text{C}$, ADC Sampling Rate = 2949.12 GHz. Default conditions: output sample rate = 491.52MSPS (decimate by 6), PLL clock mode with $f_{REF} = 491.52\text{MHz}$, $A_{IN} = -3\text{ dBFS}$, DSA setting = 4 dB.

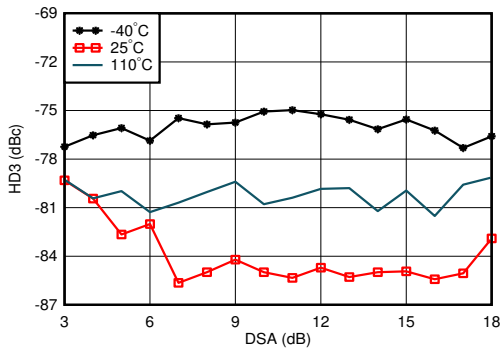

With 0.8 GHz matching, DDC bypass mode (TI only mode for characterization)

Figure 7-74. RX HD3 vs DSA Setting and Temperature at 0.8 GHz

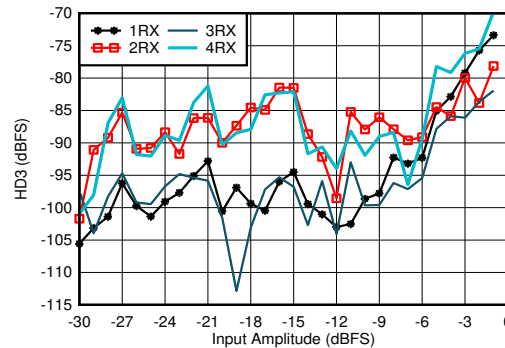

With 0.8 GHz matching, DDC bypass mode (TI only mode for characterization)

Figure 7-75. RX HD3 vs Input Level and Channel at 0.8 GHz

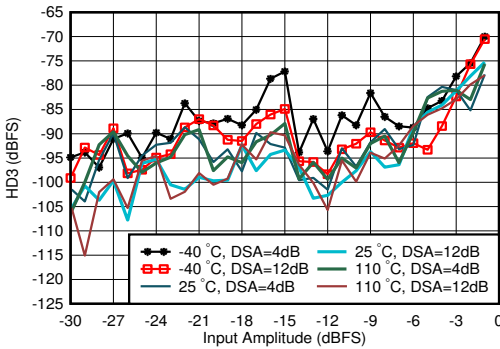

With 0.8 GHz matching, DDC bypass mode (TI only mode for characterization)

Figure 7-76. RX HD3 vs Input Level and Temperature at 0.8 GHz

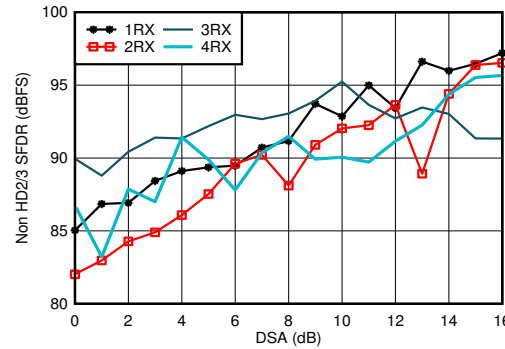

With 0.8 GHz matching

Figure 7-77. RX Non-HD2/3 vs DSA Setting at 0.8 GHz

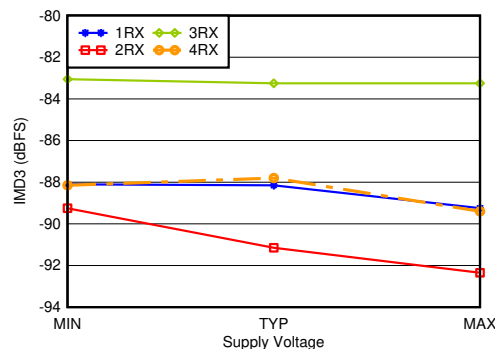

With 0.8 GHz matching, -7 dBFS each tone, 20-MHz tone spacing, all supplies at MIN, TYP, or MAX recommended operating voltages

Figure 7-78. RX IMD3 vs Supply and Channel at 0.8 GHz

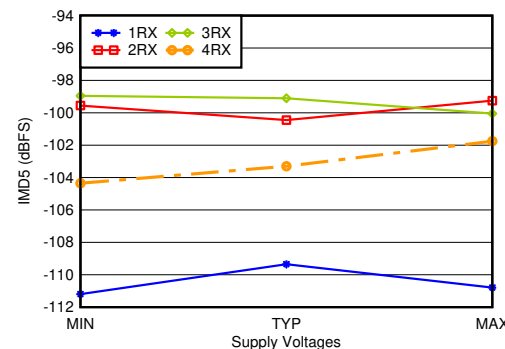

With 0.8 GHz matching, -7 dBFS each tone, 20-MHz tone spacing, all supplies at MIN, TYP, or MAX recommended operating voltages

Figure 7-79. RX IMD5 vs Supply and Channel at 0.8 GHz

7.12.2 RX Typical Characteristics at 800 MHz (continued)

Typical values at $T_A = +25^\circ\text{C}$, ADC Sampling Rate = 2949.12 GHz. Default conditions: output sample rate = 491.52MSPS (decimate by 6), PLL clock mode with $f_{REF} = 491.52\text{MHz}$, $A_{IN} = -3 \text{ dBFS}$, DSA setting = 4 dB.

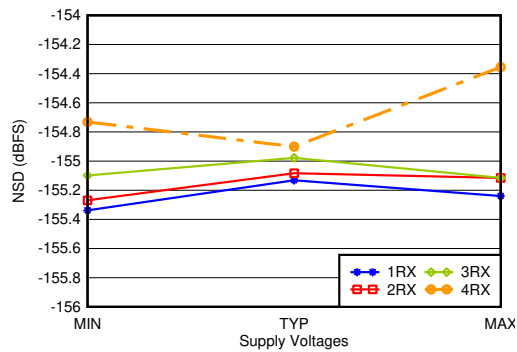

With 0.8 GHz matching, 12.5-MHz offset, all supplies at MIN, TYP, or MAX recommended operating voltages

Figure 7-80. RX Noise Spectral Density vs Supply and Channel at 0.8 GHz

7.12.3 RX Typical Characteristics 1.75 GHz to 1.9 GHz

Typical values at $T_A = +25^\circ\text{C}$, ADC Sampling Rate = 2949.12 GHz. Default conditions: output sample rate = 491.52MSPS (decimate by 6), PLL clock mode with $f_{REF} = 491.52\text{ MHz}$, $A_{IN} = -3\text{ dBFS}$, DSA setting = 4 dB.

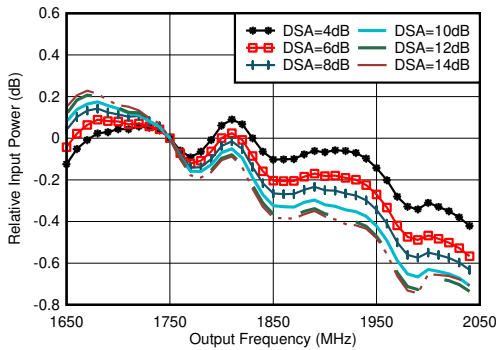

With 1.8 GHz matching, normalized to 1.75 GHz
Figure 7-81. RX In-Band Gain Flatness, $f_{IN} = 1750\text{ MHz}$

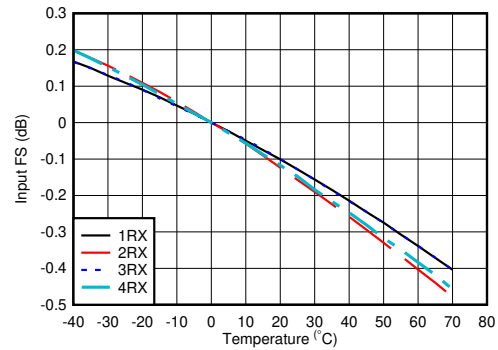

With 1.8 GHz matching, normalized to fullscale at 25°C for each channel
Figure 7-82. RX Input Fullscale vs Temperature and Channel at 1.75 GHz

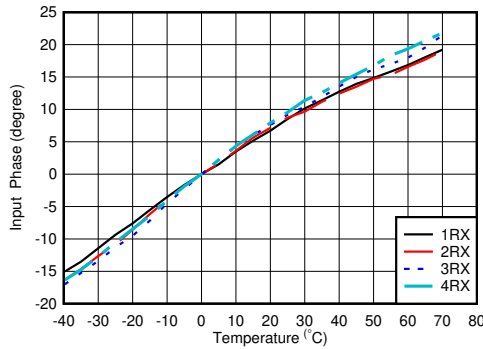

With 2.6 GHz matching, normalized to phase at 25°C
Figure 7-83. RX Input Phase vs Temperature and DSA at $f_{IN} = 1.75\text{ GHz}$

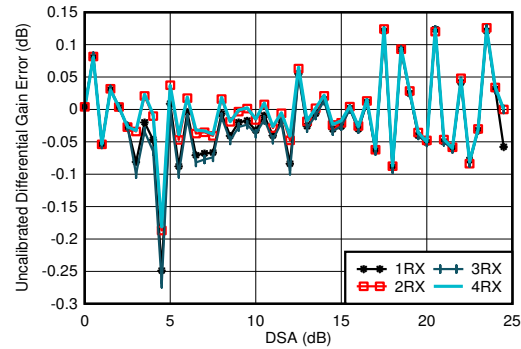

With 1.8 GHz matching
Differential Amplitude Error = $P_{IN}(\text{DSA Setting} - 1) - P_{IN}(\text{DSA Setting}) + 1$
Figure 7-84. RX Uncalibrated Differential Amplitude Error vs DSA Setting at 1.75 GHz

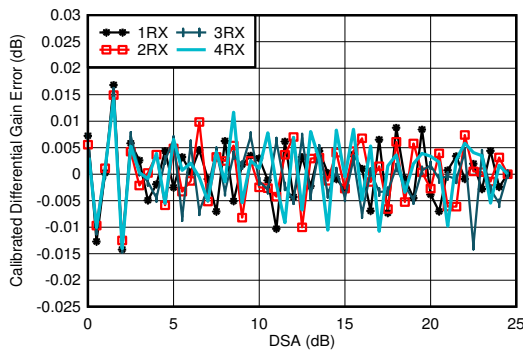

With 1.8 GHz matching
Differential Amplitude Error = $P_{IN}(\text{DSA Setting} - 1) - P_{IN}(\text{DSA Setting}) + 1$
Figure 7-85. RX Calibrated Differential Amplitude Error vs DSA Setting at 1.75 GHz

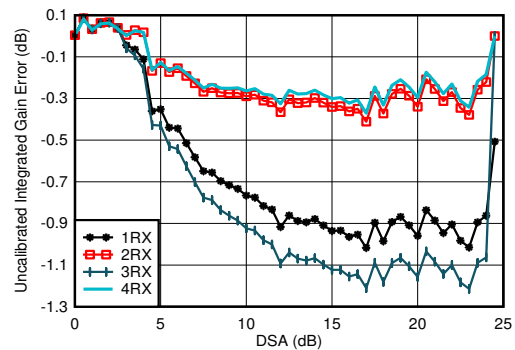

With 1.8 GHz matching
Integrated Amplitude Error = $P_{IN}(\text{DSA Setting}) - P_{IN}(\text{DSA Setting} = 0) + (\text{DSA Setting})$
Figure 7-86. RX Uncalibrated Integrated Amplitude Error vs DSA Setting at 1.75 GHz

7.12.3 RX Typical Characteristics 1.75 GHz to 1.9 GHz (continued)

Typical values at $T_A = +25^\circ\text{C}$, ADC Sampling Rate = 2949.12 MHz. Default conditions: output sample rate = 491.52MSPS (decimate by 6), PLL clock mode with $f_{REF} = 491.52\text{ MHz}$, $A_{IN} = -3\text{ dBFS}$, DSA setting = 4 dB.

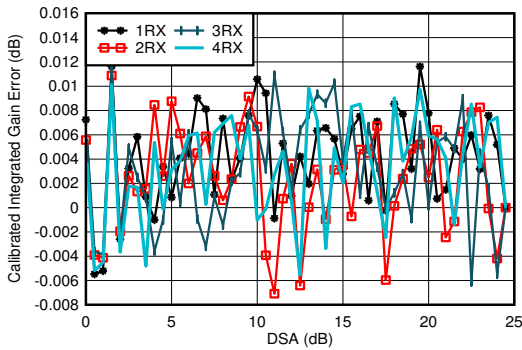

With 1.8 GHz matching
 Integrated Amplitude Error = $P_{IN}(\text{DSA Setting}) - P_{IN}(\text{DSA Setting} = 0) + (\text{DSA Setting})$

Figure 7-87. RX Calibrated Integrated Amplitude Error vs DSA Setting at 1.75 GHz

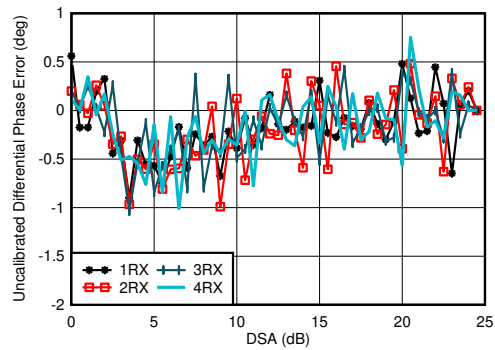

With 1.8 GHz matching
 Differential Phase Error = $\text{Phase}_{IN}(\text{DSA Setting} - 1) - \text{Phase}_{IN}(\text{DSA Setting})$

Figure 7-88. RX Uncalibrated Differential Phase Error vs DSA Setting at 1.75 GHz

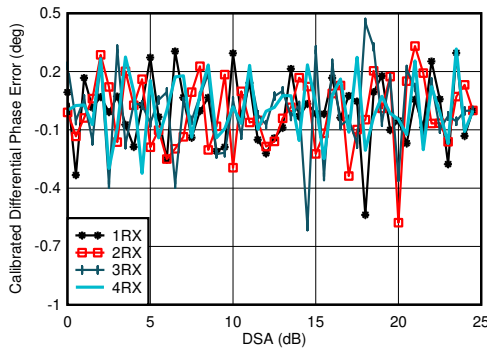

With 1.8 GHz matching
 Differential Phase Error = $\text{Phase}_{IN}(\text{DSA Setting} - 1) - \text{Phase}_{IN}(\text{DSA Setting})$

Figure 7-89. RX Calibrated Differential Phase Error vs DSA Setting at 1.75 GHz

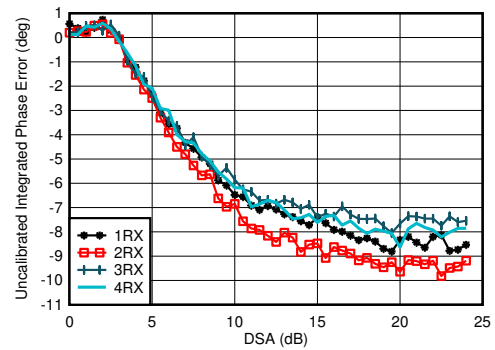

With 1.8 GHz matching
 Integrated Phase Error = $\text{Phase}(\text{DSA Setting}) - \text{Phase}(\text{DSA Setting} = 0)$

Figure 7-90. RX Uncalibrated Integrated Phase Error vs DSA Setting at 1.75 GHz

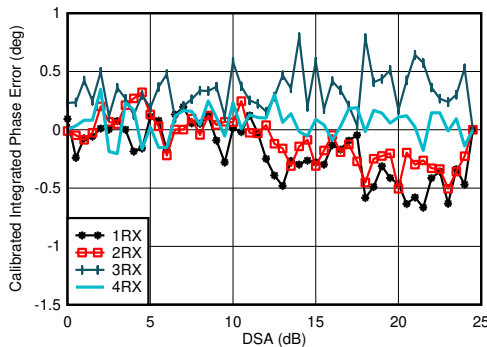

With 1.8 GHz matching
 Integrated Phase Error = $\text{Phase}(\text{DSA Setting}) - \text{Phase}(\text{DSA Setting} = 0)$

Figure 7-91. RX Calibrated Integrated Phase Error vs DSA Setting at 1.75 GHz

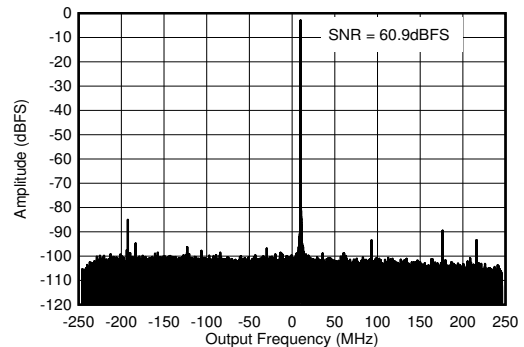

With 1.8 GHz matching, $f_{IN} = 2610\text{ MHz}$, $A_{IN} = -3\text{ dBFS}$

Figure 7-92. RX Output FFT at 1.75 GHz

7.12.3 RX Typical Characteristics 1.75 GHz to 1.9 GHz (continued)

Typical values at $T_A = +25^\circ\text{C}$, ADC Sampling Rate = 2949.12 MHz. Default conditions: output sample rate = 491.52MSPS (decimate by 6), PLL clock mode with $f_{\text{REF}} = 491.52\text{ MHz}$, $A_{\text{IN}} = -3\text{ dBFS}$, DSA setting = 4 dB.

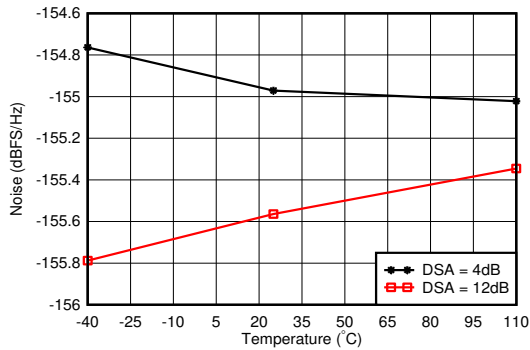

With 1.8 GHz matching, 12.5-MHz offset from tone

Figure 7-93. RX Noise Spectral Density vs Temperature at 1.75 GHz

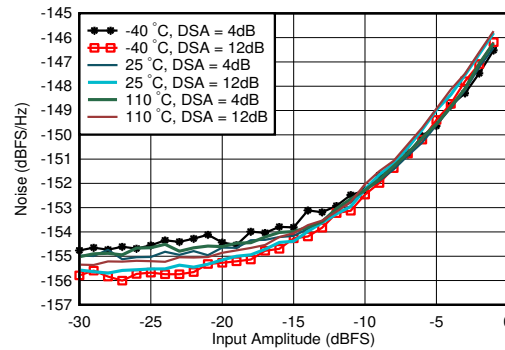

With 1.8 GHz matching, DSA Setting = 12 dB, 12.5-MHz offset from tone

Figure 7-94. RX Noise Spectral Density vs Input Amplitude and Temperature at 1.75 GHz

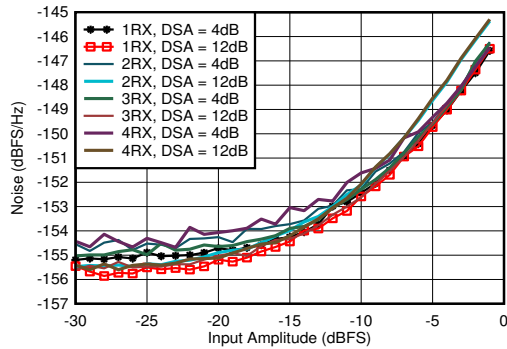

With 1.8 GHz matching, 12.5-MHz offset from tone

Figure 7-95. RX Noise Spectral Density vs Input Amplitude and Channel at 1.75 GHz

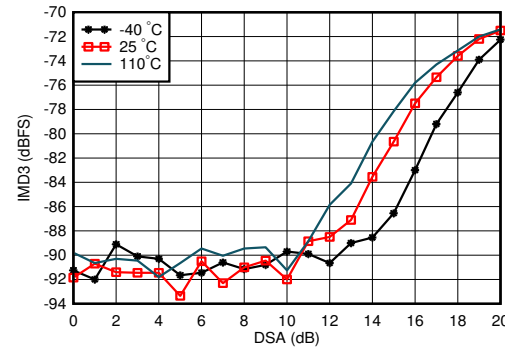

With 1.8 GHz matching, each tone -7 dBFS , tone spacing = 20 MHz

Figure 7-96. RX IMD3 vs DSA Setting and Temperature at 1.75 GHz

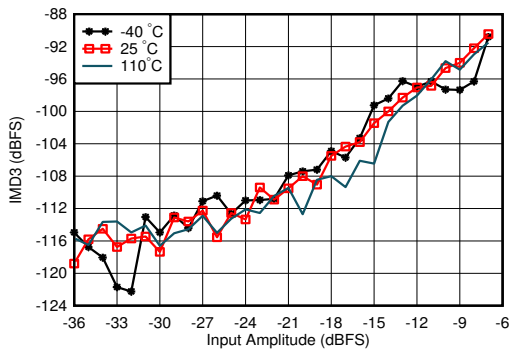

With 1.8 GHz matching, tone spacing = 20 MHz, DSA = 4 dB

Figure 7-97. RX IMD3 vs Input Level and Temperature at 1.75 GHz

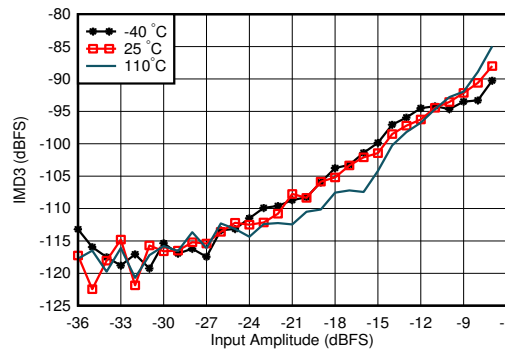

With 1.8 GHz matching, tone spacing = 20 MHz, DSA = 12 dB

Figure 7-98. RX IMD3 vs Input Level and Temperature at 1.75 GHz

7.12.3 RX Typical Characteristics 1.75 GHz to 1.9 GHz (continued)

Typical values at $T_A = +25^\circ\text{C}$, ADC Sampling Rate = 2949.12 GHz. Default conditions: output sample rate = 491.52MSPS (decimate by 6), PLL clock mode with $f_{REF} = 491.52\text{ MHz}$, $A_{IN} = -3\text{ dBFS}$, DSA setting = 4 dB.

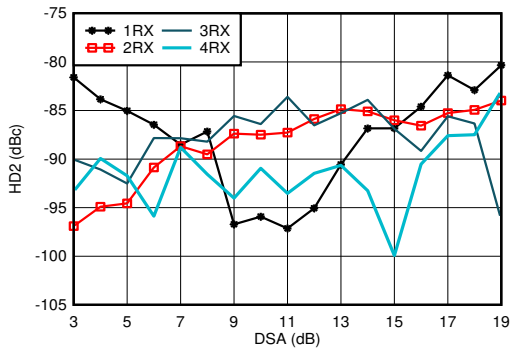

With 1.8 GHz matching, $f_{in} = 1900\text{ MHz}$, measured after HD2 trim, DDC bypass mode (TI only mode for characterization)

Figure 7-99. RX HD2 vs DSA Setting and Channel at 1.9 GHz

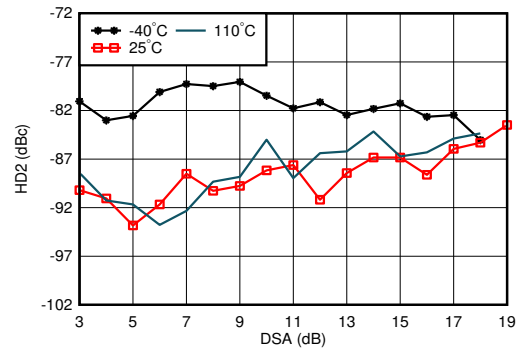

With 1.8 GHz matching, $f_{in} = 1900\text{ MHz}$, measured after HD2 trim, DDC bypass mode (TI only mode for characterization)

Figure 7-100. RX HD2 vs DSA Setting and Temperature at 1.9 GHz

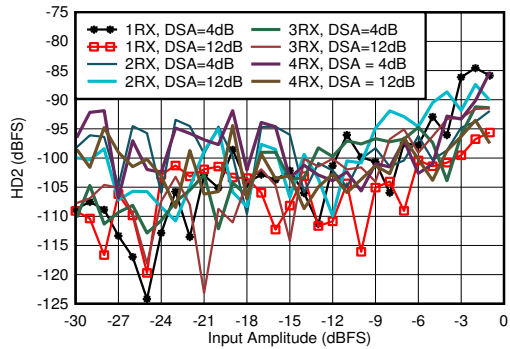

With 1.8 GHz matching, $f_{in} = 1900\text{ MHz}$, measured after HD2 trim, DDC bypass mode (TI only mode for characterization)

Figure 7-101. RX HD2 vs Input Amplitude and Channel at 1.9 GHz

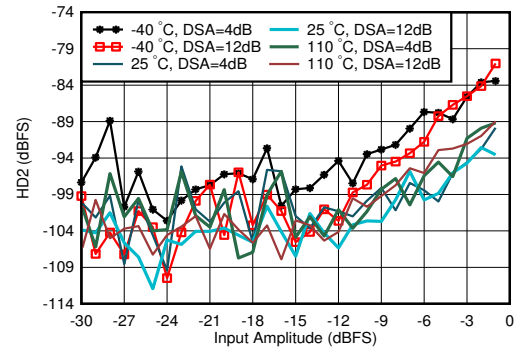

With 1.8 GHz matching, $f_{in} = 1900\text{ MHz}$, measured after HD2 trim, DDC bypass mode (TI only mode for characterization)

Figure 7-102. RX HD2 vs Input Amplitude and Temperature at 1.9 GHz

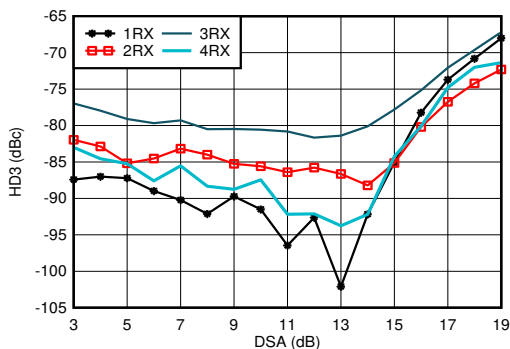

With 1.8 GHz matching, $f_{in} = 1900\text{ MHz}$, DDC bypass mode (TI only mode for characterization)

Figure 7-103. RX HD3 vs DSA Setting and Channel at 1.9 GHz

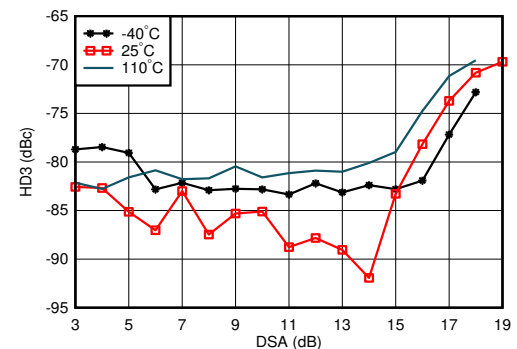

With 1.8 GHz matching, $f_{in} = 1900\text{ MHz}$, DDC bypass mode (TI only mode for characterization)

Figure 7-104. RX HD3 vs DSA Setting and Temperature at 1.9 GHz

7.12.3 RX Typical Characteristics 1.75 GHz to 1.9 GHz (continued)

Typical values at $T_A = +25^\circ\text{C}$, ADC Sampling Rate = 2949.12 MHz. Default conditions: output sample rate = 491.52MSPS (decimate by 6), PLL clock mode with $f_{REF} = 491.52\text{ MHz}$, $A_{IN} = -3\text{ dBFS}$, DSA setting = 4 dB.

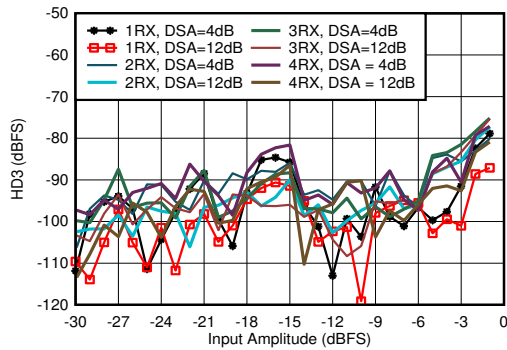

With 1.8 GHz matching, $f_{in} = 1900\text{ MHz}$, DDC bypass mode (TI only mode for characterization)

Figure 7-105. RX HD3 vs Input Level and Channel at 1.9 GHz

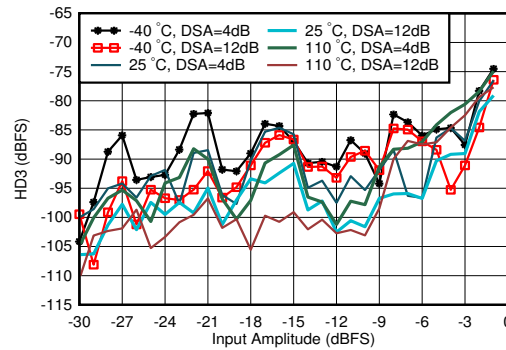

With 1.8 GHz matching, $f_{in} = 1900\text{ MHz}$, DDC bypass mode (TI only mode for characterization)

Figure 7-106. RX HD3 vs Input Level and Temperature at 1.9 GHz

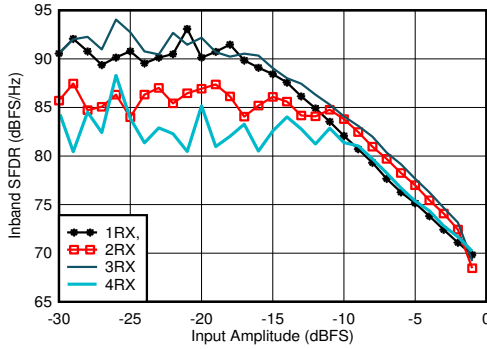

With 1.8 GHz matching, decimated by 3

Figure 7-107. RX In-Band SFDR ($\pm 400\text{ MHz}$) vs Input Amplitude at 1.75 GHz

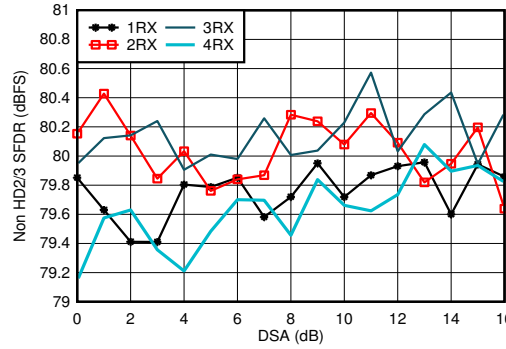

With 1.8 GHz matching

Figure 7-108. RX Non-HD2/3 vs DSA Setting at 1.75 GHz

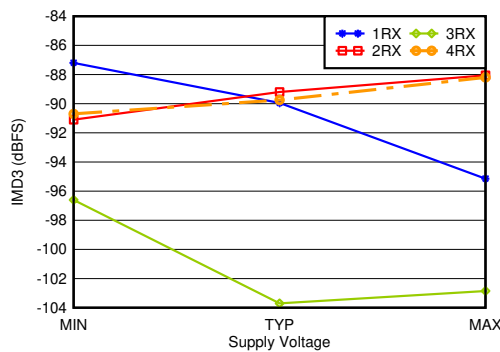

With 1.8 GHz matching, -7 dBFS each tone, 20-MHz tone spacing, all supplies at MIN, TYP, or MAX recommended operating voltages

Figure 7-109. RX IMD3 vs Supply and Channel at 1.75 GHz

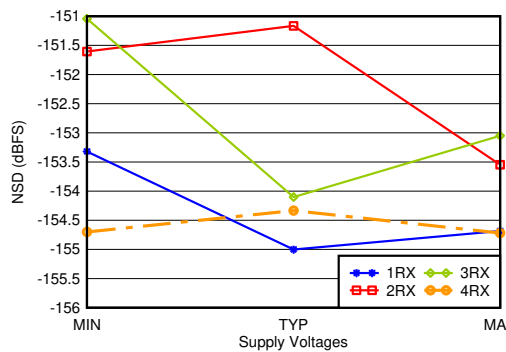

With 1.8 GHz matching, 12.5-MHz offset, all supplies at MIN, TYP, or MAX recommended operating voltages

Figure 7-110. RX Noise Spectral Density vs Supply and Channel at 1.75 GHz

7.12.4 RX Typical Characteristics 2.6 GHz

Typical values at $T_A = +25^\circ\text{C}$, ADC Sampling Rate = 2949.12 MHz. Default conditions: output sample rate = 491.52 MSPS (decimate by 6), PLL clock mode with $f_{REF} = 491.52\text{MHz}$, $A_{IN} = -3\text{ dBFS}$, DSA setting = 4 dB.

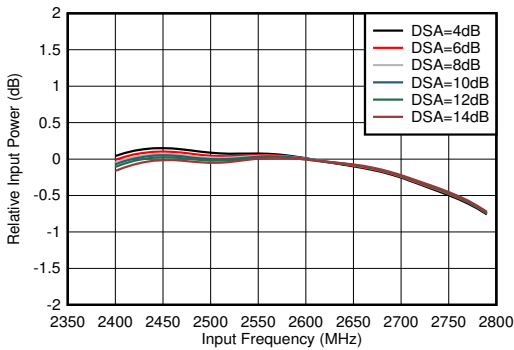

With matching, normalized to power at 2.6 GHz for each DSA setting

Figure 7-111. RX Inband Gain Flatness, $f_{IN} = 2600\text{ MHz}$

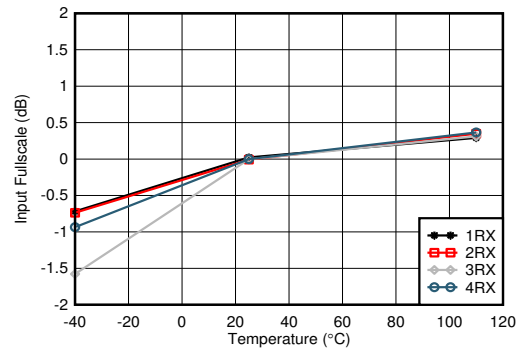

With 2.6 GHz matching, normalized to fullscale at 25°C for each channel

Figure 7-112. RX Input Fullscale vs Temperature and Channel at 2.6 GHz

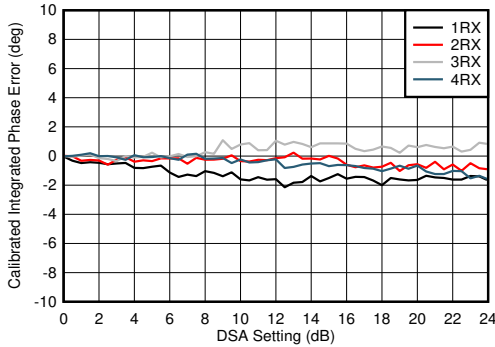

With 2.6 GHz matching
Integrated Phase Error = Phase(DSA Setting) – Phase(DSA Setting = 0)

Figure 7-113. RX Calibrated Integrated Phase Error vs DSA Setting at 2.6 GHz

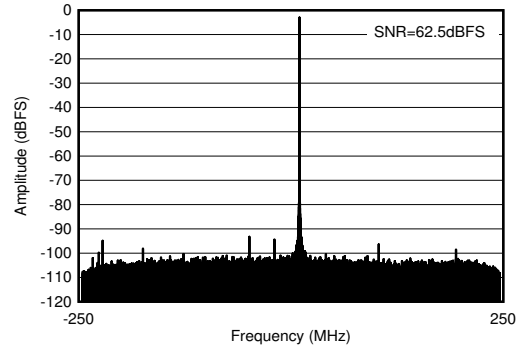

With 2.6 GHz matching, $f_{IN} = 2610\text{ MHz}$, $A_{IN} = -3\text{ dBFS}$

Figure 7-114. RX Output FFT at 2.6 GHz

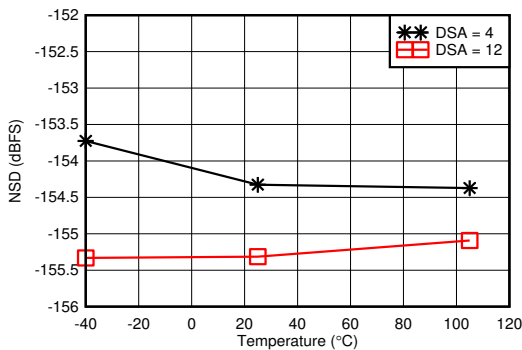

With 2.6 GHz matching, 12.5-MHz offset from tone

Figure 7-115. RX Noise Spectral Density vs Temperature at 2.6 GHz

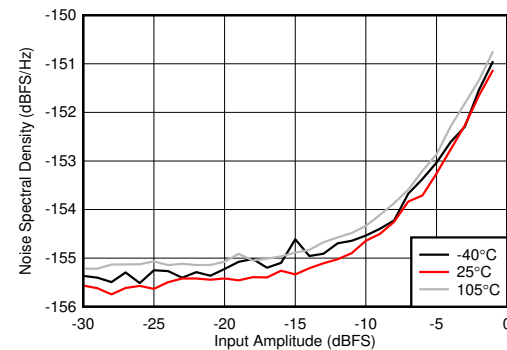

With 2.6 GHz matching, DSA Setting = 12 dB, 12.5-MHz offset from tone

Figure 7-116. RX Noise Spectral Density vs Input Amplitude and Temperature at 2.6 GHz

7.12.4 RX Typical Characteristics 2.6 GHz (continued)

Typical values at $T_A = +25^\circ\text{C}$, ADC Sampling Rate = 2949.12 MHz. Default conditions: output sample rate = 491.52 MSPS (decimate by 6), PLL clock mode with $f_{REF} = 491.52\text{MHz}$, $A_{IN} = -3\text{ dBFS}$, DSA setting = 4 dB.

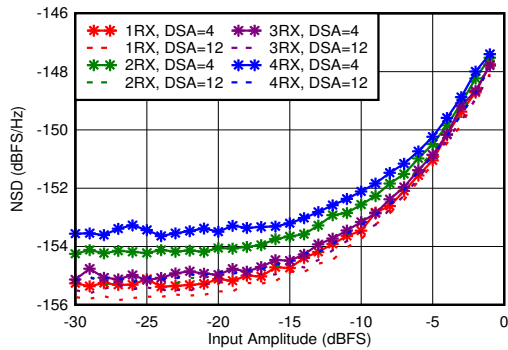

With 2.6 GHz matching, 12.5-MHz offset from tone

Figure 7-117. RX Noise Spectral Density vs Input Amplitude and Channel at 2.6 GHz

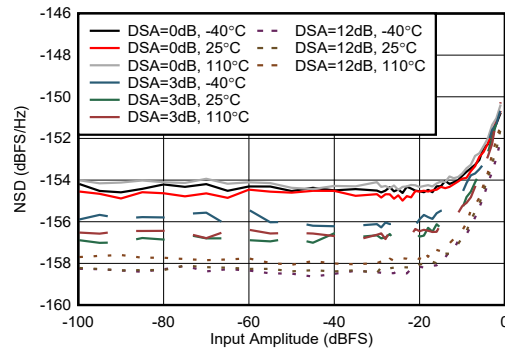

50-MHz offset from tone, external clock mode

Figure 7-118. RX Noise Spectral Density vs Input Amplitude at 2.61 GHz (Ext. Clock)

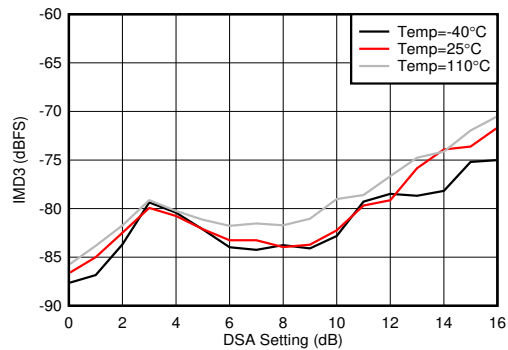

With 2.6 GHz matching, each tone -7 dBFS , tone spacing = 20 MHz

Figure 7-119. RX IMD3 vs DSA Setting and Temperature at 2.6 GHz

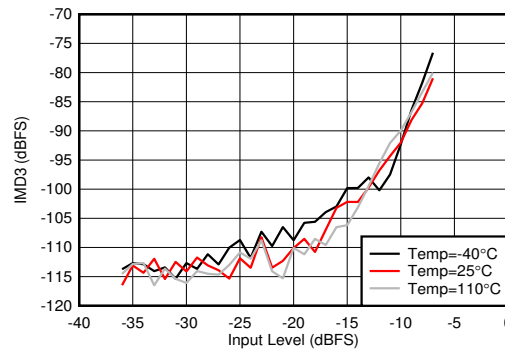

With 2.6 GHz matching, tone spacing = 20 MHz, DSA = 4 dB

Figure 7-120. RX IMD3 vs Input Level and Temperature at 2.6 GHz

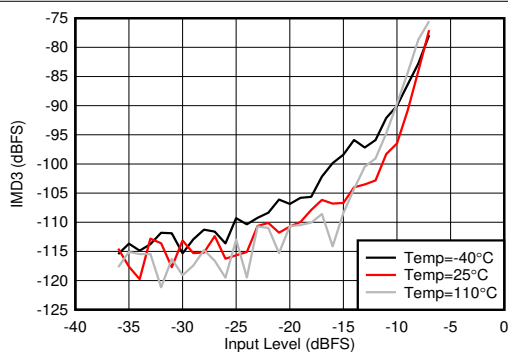

With 2.6 GHz matching, tone spacing = 20 MHz, DSA = 12 dB

Figure 7-121. RX IMD3 vs Input Level and Temperature at 2.6 GHz

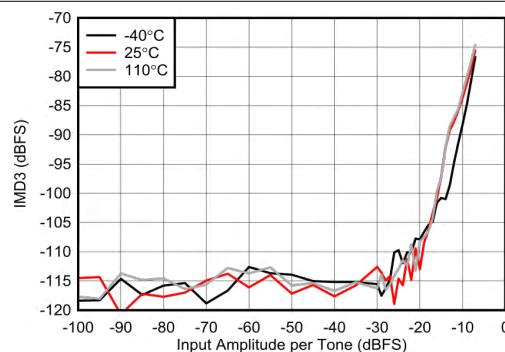

Tone spacing = 50 MHz, External clock mode

Figure 7-122. RX IMD3 vs Input Level at 2.6 GHz (Ext. Clock)

7.12.4 RX Typical Characteristics 2.6 GHz (continued)

Typical values at $T_A = +25^\circ\text{C}$, ADC Sampling Rate = 2949.12 MHz. Default conditions: output sample rate = 491.52 MSPS (decimate by 6), PLL clock mode with $f_{REF} = 491.52\text{MHz}$, $A_{IN} = -3\text{ dBFS}$, DSA setting = 4 dB.

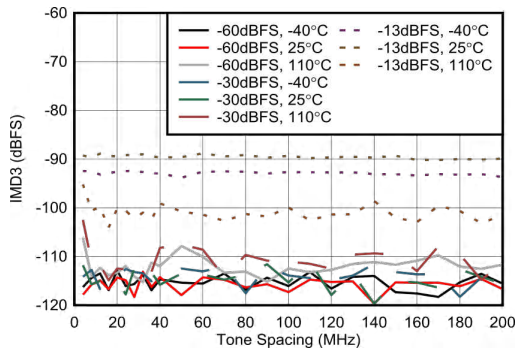

External clock mode

Figure 7-123. RX IMD3 vs Tone Spacing at 2.6 GHz (Ext. Clock)

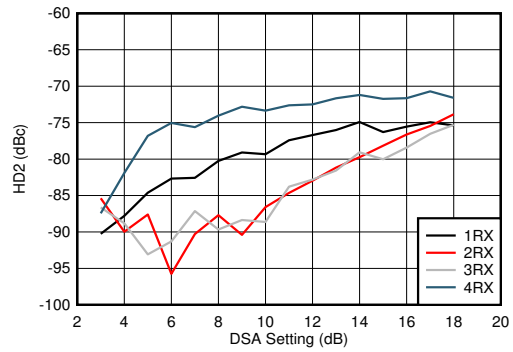

With 2.6 GHz matching, DDC bypass mode (TI only mode for characterization)

Figure 7-124. RX HD2 vs DSA Setting and Channel at 2.6 GHz

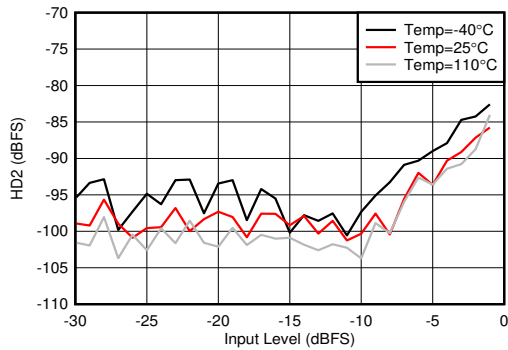

With 2.6 GHz matching, DDC bypass mode (TI only mode for characterization)

Figure 7-125. RX HD2 vs Input Level and Temperature at 2.6 GHz

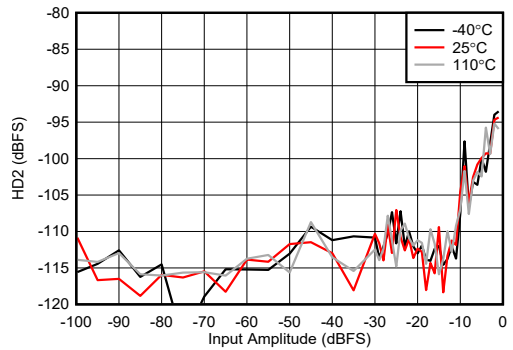

External clock mode

Figure 7-126. RX HD2 vs Input Level and Temperature at 2.6 GHz

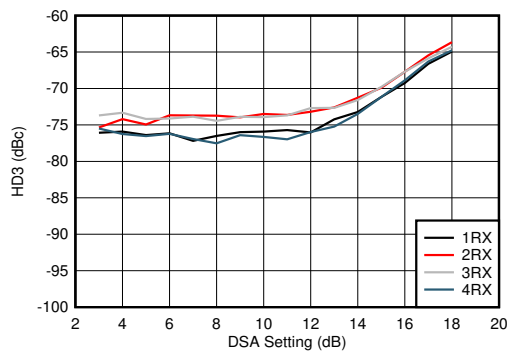

With 2.6 GHz matching, DDC bypass mode (TI only mode for characterization)

Figure 7-127. RX HD3 vs DSA Setting and Channel at 2.6 GHz

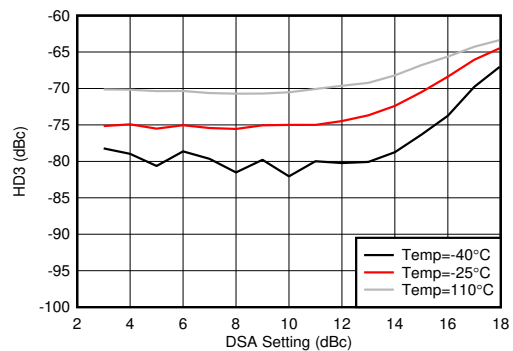

With 2.6 GHz matching, DDC bypass mode (TI only mode for characterization)

Figure 7-128. RX HD3 vs DSA Setting and Temperature at 2.6 GHz

7.12.4 RX Typical Characteristics 2.6 GHz (continued)

Typical values at $T_A = +25^\circ\text{C}$, ADC Sampling Rate = 2949.12 MHz. Default conditions: output sample rate = 491.52 MSPS (decimate by 6), PLL clock mode with $f_{REF} = 491.52\text{MHz}$, $A_{IN} = -3\text{ dBFS}$, DSA setting = 4 dB.

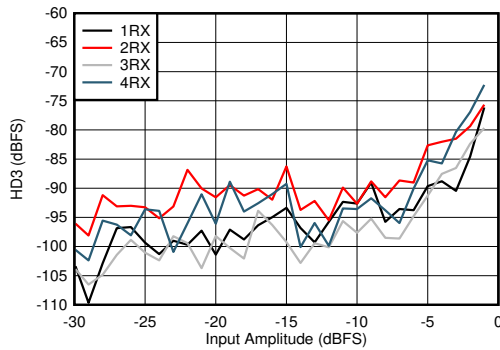

With 2.6 GHz matching, DDC bypass mode (TI only mode for characterization)

Figure 7-129. RX HD3 vs Input Level and Channel at 2.6 GHz

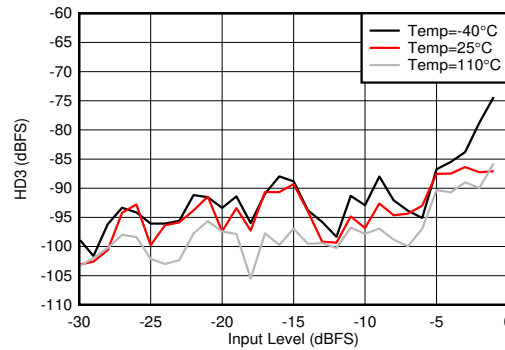

With 2.6 GHz matching, DDC bypass mode (TI only mode for characterization)

Figure 7-130. RX HD3 vs Input Level and Temperature at 2.6 GHz

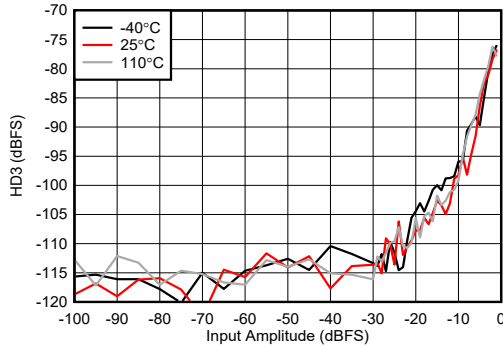

External clock mode

Figure 7-131. RX HD3 vs Input Level and Temperature at 2.6 GHz

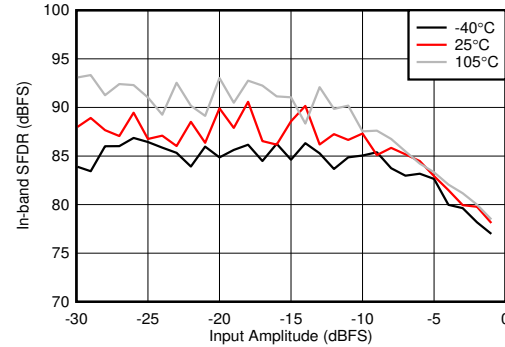

With 2.6 GHz matching, decimate by 4

Figure 7-132. RX In-Band SFDR ($\pm 300\text{ MHz}$) vs Input Amplitude and Temperature at 2.6 GHz

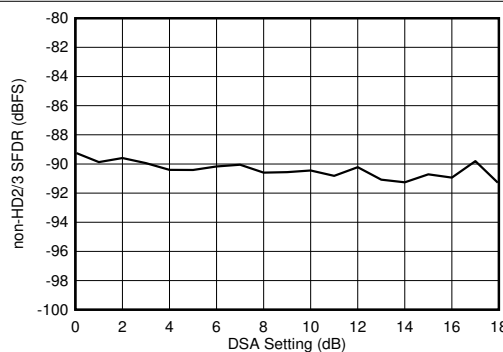

With 2.6 GHz matching

Figure 7-133. RX Non-HD2/3 vs DSA Setting at 2.6 GHz

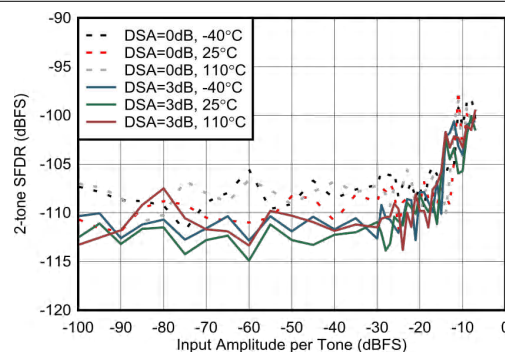

External clock mode, 50MHz tone spacing, excluding 3rd order distortion

Figure 7-134. RX 2-tone SFDR vs Input Amplitude at 2.6 GHz

7.12.4 RX Typical Characteristics 2.6 GHz (continued)

Typical values at $T_A = +25^\circ\text{C}$, ADC Sampling Rate = 2949.12 GHz. Default conditions: output sample rate = 491.52 MSPS (decimate by 6), PLL clock mode with $f_{REF} = 491.52\text{MHz}$, $A_{IN} = -3\text{ dBFS}$, DSA setting = 4 dB.

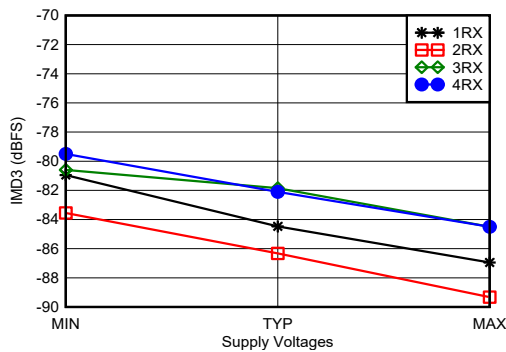

With 2.6 GHz matching, -7 dBFS each tone, 20-MHz tone spacing, all supplies at MIN, TYP, or MAX recommended operating voltages

Figure 7-135. RX IMD3 vs Supply and Channel at 2.6 GHz

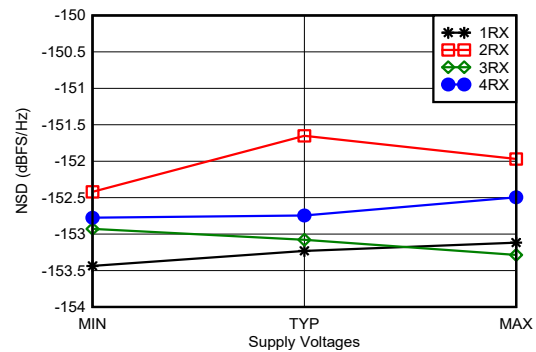

With 2.6 GHz matching, 12.5-MHz offset, all supplies at MIN, TYP, or MAX recommended operating voltages

Figure 7-136. RX Noise Spectral Density vs Supply and Channel at 2.6 GHz

7.12.5 RX Typical Characteristics 3.5 GHz

Typical values at $T_A = +25^\circ\text{C}$, ADC Sampling Rate = 2949.12 GHz. Default conditions: output sample rate = 491.52 MSPS (decimate by 6), PLL clock mode with $f_{\text{REF}} = 491.52\text{ MHz}$, $A_{\text{IN}} = -3\text{ dBFS}$, DSA setting = 4 dB.

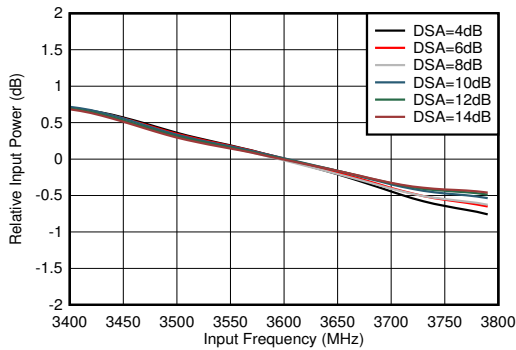

With 3.6 GHz matching, normalized to 3.6 GHz

Figure 7-137. RX In-Band Gain Flatness, $f_{\text{IN}} = 3600\text{ MHz}$

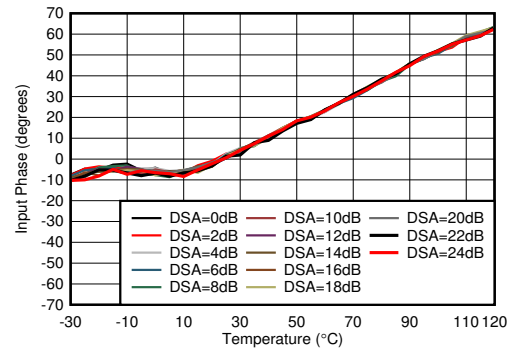

With 3.6 GHz matching, normalized to phase at 25°C

Figure 7-138. RX Input Phase vs Temperature at 3.6 GHz

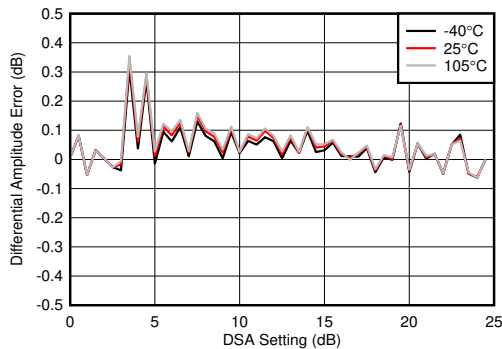

With 3.6 GHz matching

$$\text{Differential Amplitude Error} = P_{\text{IN}}(\text{DSA Setting} - 1) - P_{\text{IN}}(\text{DSA Setting}) + 1$$

Figure 7-139. RX Uncalibrated Differential Amplitude Error vs DSA Setting at 3.6 GHz

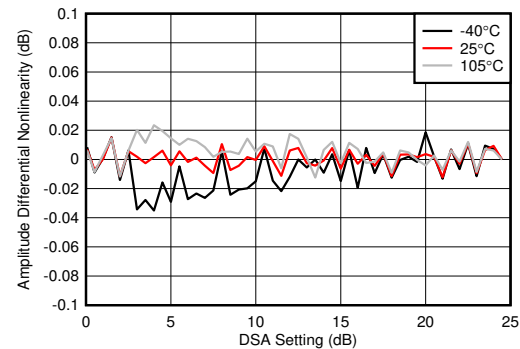

With 3.6 GHz matching

$$\text{Differential Amplitude Error} = P_{\text{IN}}(\text{DSA Setting} - 1) - P_{\text{IN}}(\text{DSA Setting}) + 1$$

Figure 7-140. RX Calibrated Differential Amplitude Error vs DSA Setting at 3.6 GHz

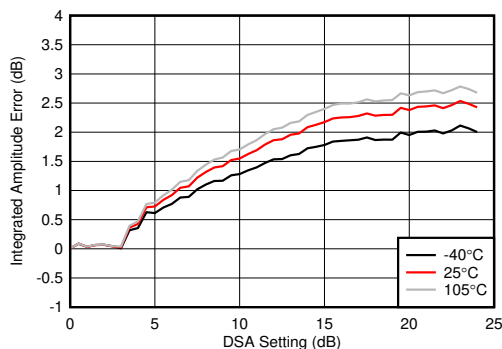

With 3.6 GHz matching

$$\text{Integrated Amplitude Error} = P_{\text{IN}}(\text{DSA Setting}) - P_{\text{IN}}(\text{DSA Setting} = 0) + (\text{DSA Setting})$$

Figure 7-141. RX Uncalibrated Integrated Amplitude Error vs DSA Setting at 3.6 GHz

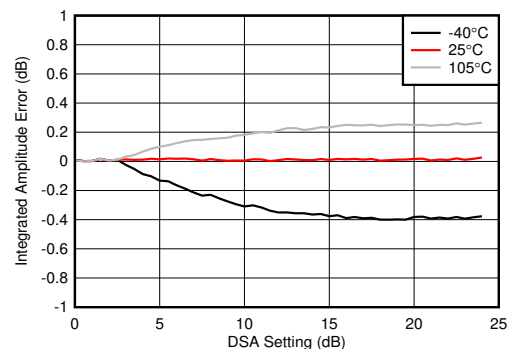

With 3.6 GHz matching

$$\text{Integrated Amplitude Error} = P_{\text{IN}}(\text{DSA Setting}) - P_{\text{IN}}(\text{DSA Setting} = 0) + (\text{DSA Setting})$$

Figure 7-142. RX Calibrated Integrated Amplitude Error vs DSA Setting at 3.6 GHz

7.12.5 RX Typical Characteristics 3.5 GHz (continued)

Typical values at $T_A = +25^\circ\text{C}$, ADC Sampling Rate = 2949.12 MHz. Default conditions: output sample rate = 491.52 MSPS (decimate by 6), PLL clock mode with $f_{REF} = 491.52\text{ MHz}$, $A_{IN} = -3\text{ dBFS}$, DSA setting = 4 dB.

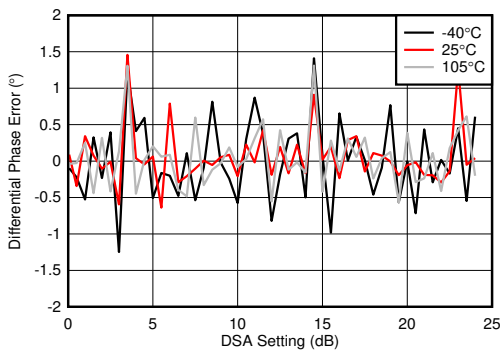

With 3.6 GHz matching
 Differential Phase Error = $\text{Phase}_{IN}(\text{DSA Setting} - 1) - \text{Phase}_{IN}(\text{DSA Setting})$

Figure 7-143. RX Uncalibrated Differential Phase Error vs DSA Setting at 3.6 GHz

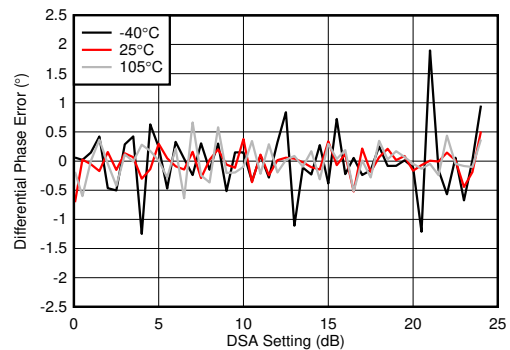

With 3.6 GHz matching
 Differential Phase Error = $\text{Phase}_{IN}(\text{DSA Setting} - 1) - \text{Phase}_{IN}(\text{DSA Setting})$

Figure 7-144. RX Calibrated Differential Phase Error vs DSA Setting at 3.6 GHz

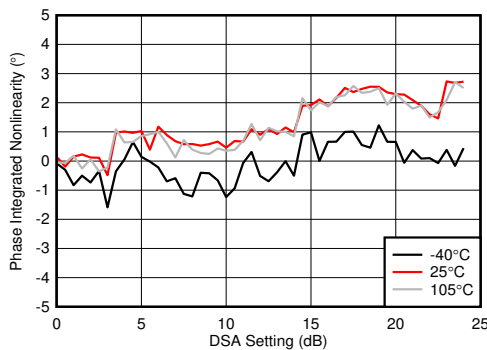

With 3.6 GHz matching
 Integrated Phase Error = $\text{Phase}(\text{DSA Setting}) - \text{Phase}(\text{DSA Setting} = 0)$

Figure 7-145. RX Uncalibrated Integrated Phase Error vs DSA Setting at 3.6 GHz

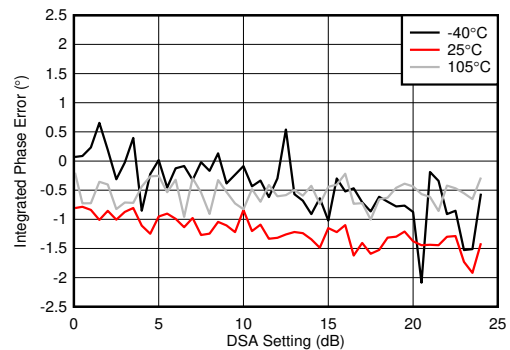

With 3.6 GHz matching
 Integrated Phase Error = $\text{Phase}(\text{DSA Setting}) - \text{Phase}(\text{DSA Setting} = 0)$

Figure 7-146. RX Calibrated Integrated Phase Error vs DSA Setting at 3.6 GHz

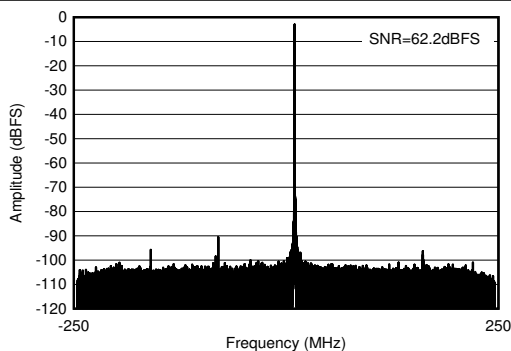

With 3.6 GHz matching, $f_{IN} = 3610\text{ MHz}$, $A_{IN} = -3\text{ dBFS}$

Figure 7-147. RX Output FFT at 3.6 GHz

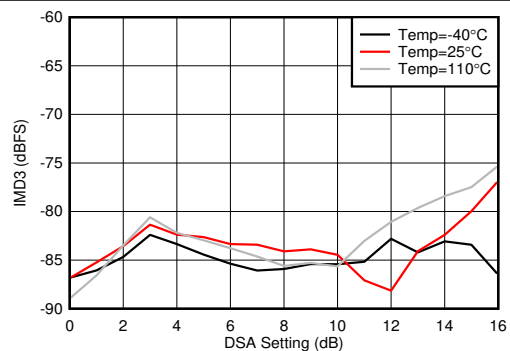

With 3.5 GHz matching, each tone at -7 dBFS , 20-MHz tone spacing

Figure 7-148. RX IMD3 vs DSA Setting and Temperature at 3.6 GHz

7.12.5 RX Typical Characteristics 3.5 GHz (continued)

Typical values at $T_A = +25^\circ\text{C}$, ADC Sampling Rate = 2949.12 MHz. Default conditions: output sample rate = 491.52 MSPS (decimate by 6), PLL clock mode with $f_{REF} = 491.52\text{ MHz}$, $A_{IN} = -3\text{ dBFS}$, DSA setting = 4 dB.

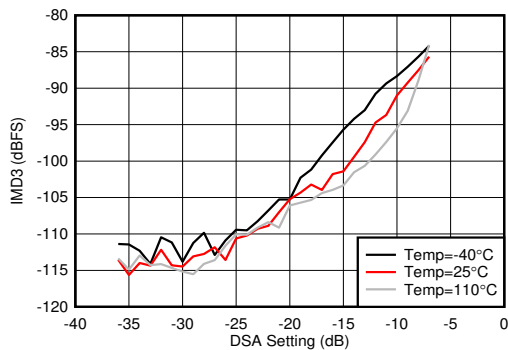

With 3.5 GHz matching, 20-MHz tone spacing

Figure 7-149. RX IMD3 vs Input Level and Temperature at 3.6 GHz

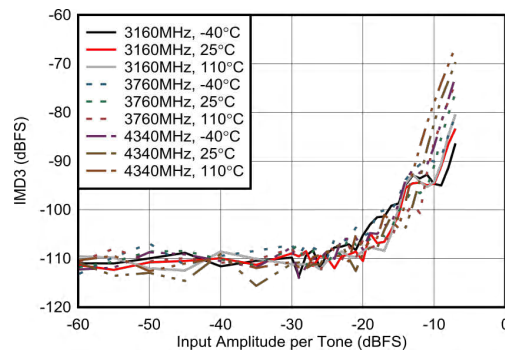

External clock mode, 20-MHz tone spacing, 2x Decimation

Figure 7-150. RX IMD3 vs Input Level

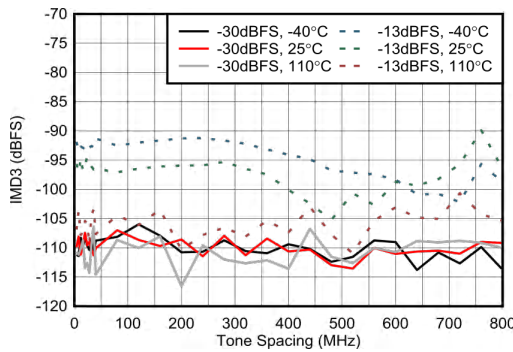

External clock mode, 2x Decimation

Figure 7-151. RX IMD3 vs Tone Spacing at 3.76 GHz

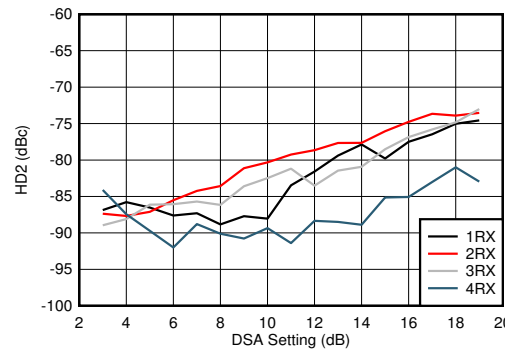

With 3.5 GHz matching, DDC bypass mode (TI only mode for characterization)

Figure 7-152. RX HD2 vs DSA Setting and Channel at 3.6 GHz

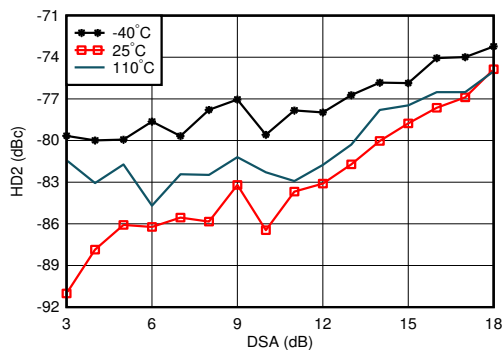

With 3.5 GHz matching, DDC bypass mode (TI only mode for characterization)

Figure 7-153. RX HD2 vs DSA Setting and Temperature at 3.6 GHz

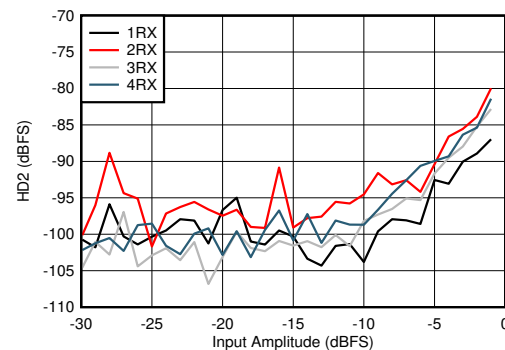

With 3.5 GHz matching, DDC bypass mode (TI only mode for characterization)

Figure 7-154. RX HD2 vs Input Level and Channel at 3.6 GHz

7.12.5 RX Typical Characteristics 3.5 GHz (continued)

Typical values at $T_A = +25^\circ\text{C}$, ADC Sampling Rate = 2949.12 MHz. Default conditions: output sample rate = 491.52 MSPS (decimate by 6), PLL clock mode with $f_{REF} = 491.52\text{ MHz}$, $A_{IN} = -3\text{ dBFS}$, DSA setting = 4 dB.

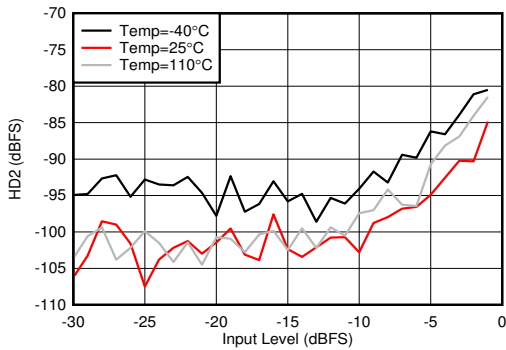

With 3.5 GHz matching, DDC bypass mode (TI only mode for characterization)

Figure 7-155. RX HD2 vs Input Level and Temperature at 3.6 GHz

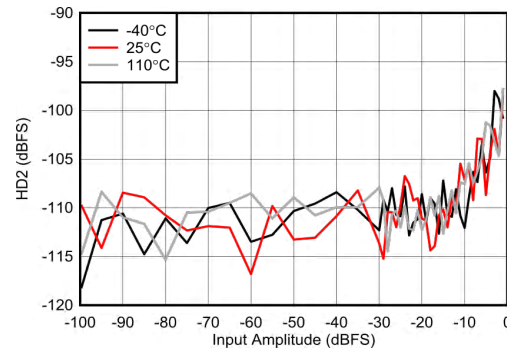

External clock mode, 2x Decimation

Figure 7-156. RX HD2 vs Input Level at 3.76 GHz

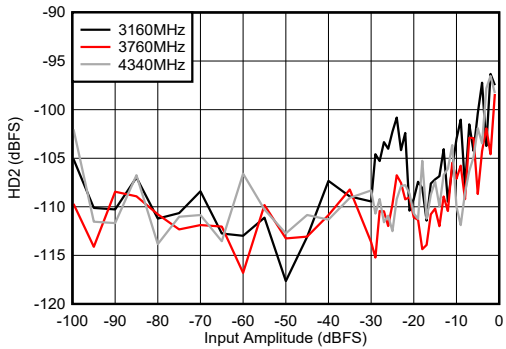

External clock mode, 25°C, 2x Decimation

Figure 7-157. RX HD2 vs Input Level

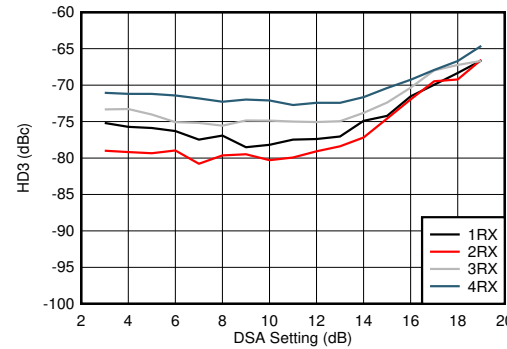

With 3.5 GHz matching, DDC bypass mode (TI only mode for characterization)

Figure 7-158. RX HD3 vs DSA Setting and Channel at 3.6 GHz

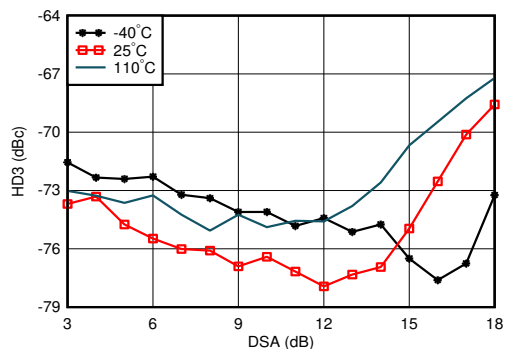

With 3.5 GHz matching, DDC bypass mode (TI only mode for characterization)

Figure 7-159. RX HD3 vs DSA Setting and Temperature at 3.6 GHz

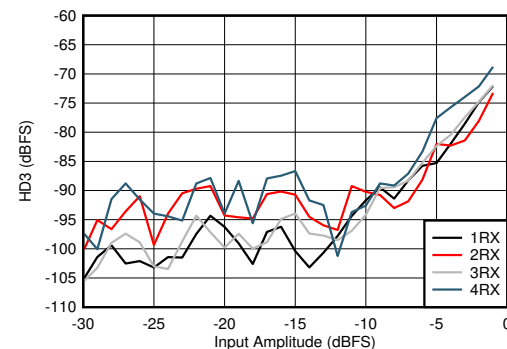

With 3.5 GHz matching, DDC bypass mode (TI only mode for characterization)

Figure 7-160. RX HD3 vs Input Level and Channel at 3.6 GHz

7.12.5 RX Typical Characteristics 3.5 GHz (continued)

Typical values at $T_A = +25^\circ\text{C}$, ADC Sampling Rate = 2949.12 MHz. Default conditions: output sample rate = 491.52 MSPS (decimate by 6), PLL clock mode with $f_{REF} = 491.52\text{ MHz}$, $A_{IN} = -3\text{ dBFS}$, DSA setting = 4 dB.

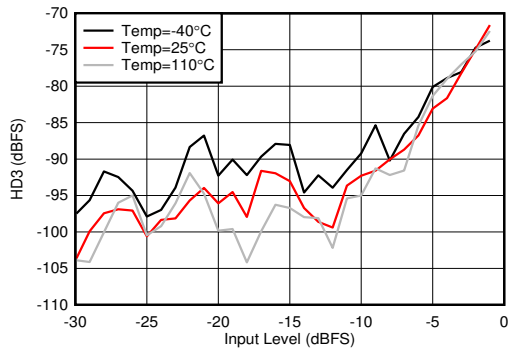

With 3.5 GHz matching, DDC bypass mode (TI only mode for characterization)

Figure 7-161. RX HD3 vs Input Level and Temperature at 3.6 GHz

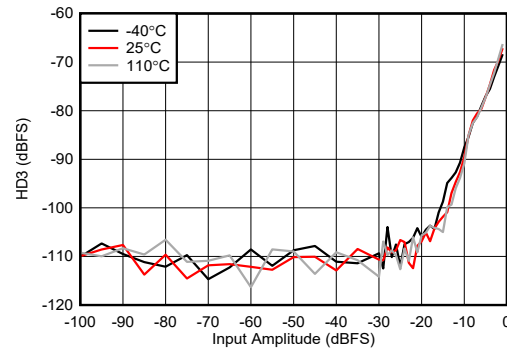

External clock mode, 2x Decimation

Figure 7-162. RX HD3 vs Input Level at 3.76 GHz

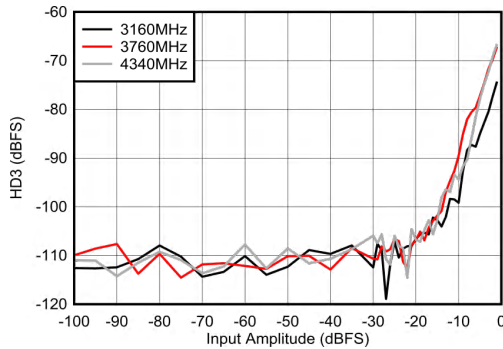

External clock mode, 25°C, 2x Decimation

Figure 7-163. RX HD3 vs Input Level

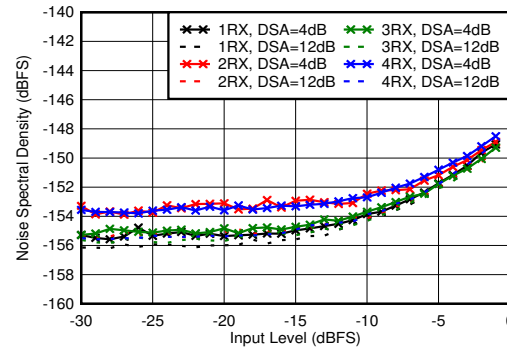

With 3.5 GHz matching, 12.5-MHz offset from tone

Figure 7-164. RX Noise Spectral Density vs Input Level and DSA Setting at 3.6 GHz

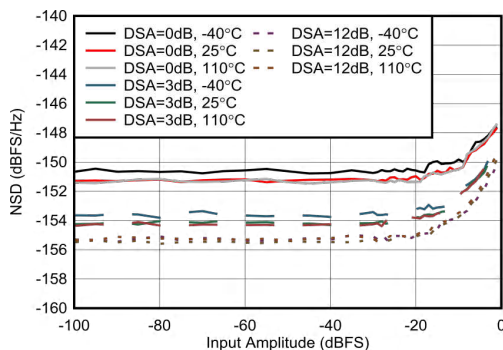

External clock mode, 25°C, 2x Decimation

Figure 7-165. RX Noise Spectral Density vs Input Level at 3.76GHz

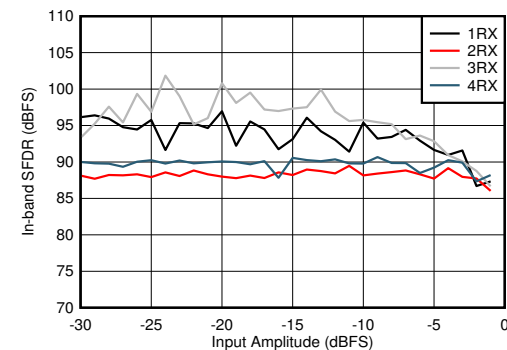

With 3.5 GHz matching

Figure 7-166. RX In-Band SFDR ($\pm 200\text{ MHz}$) vs Input Level and Channel at 3.6 GHz

7.12.5 RX Typical Characteristics 3.5 GHz (continued)

Typical values at $T_A = +25^\circ\text{C}$, ADC Sampling Rate = 2949.12 GHz. Default conditions: output sample rate = 491.52 MSPS (decimate by 6), PLL clock mode with $f_{REF} = 491.52\text{ MHz}$, $A_{IN} = -3\text{ dBFS}$, DSA setting = 4 dB.

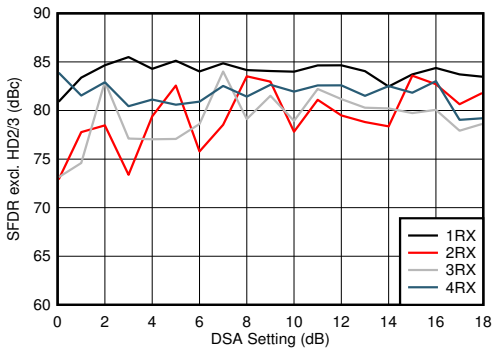

With 3.5 GHz matching

Figure 7-167. RX SFDR Excluding HD2/3 vs DSA Setting and Channel at 3.6 GHz

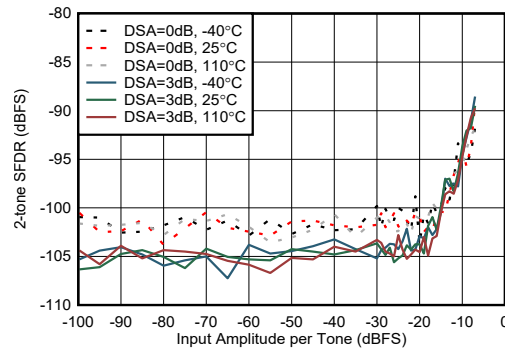

External clock mode, 20MHz tone spacing, excluding 3rd order distortion

Figure 7-168. RX 2-tone SFDR vs Input Amplitude and DSA Setting at 3.7 GHz

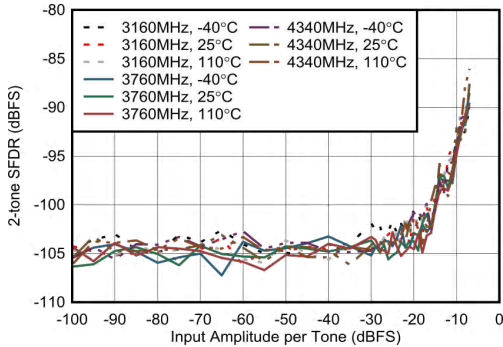

External clock mode, 20MHz tone spacing, excluding 3rd order distortion

Figure 7-169. RX 2-tone SFDR vs Input Amplitude and Frequency at 3.7 GHz

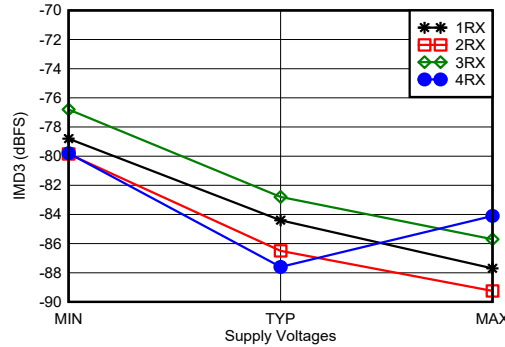

With 3.6 GHz matching, -7 dBFS each tone, 20-MHz tone spacing, all supplies at MIN, TYP, or MAX recommended operating voltages

Figure 7-170. RX IMD3 vs Supply Voltage and Channel at 3.6 GHz

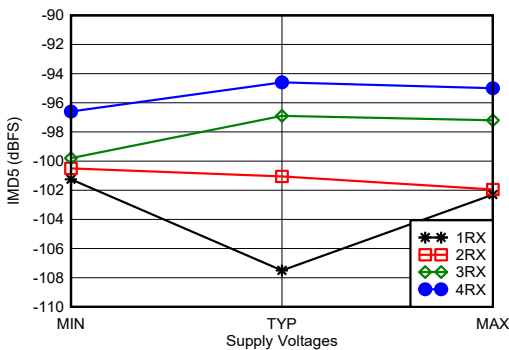

With 3.6 GHz matching, -7 dBFS each tone, 20-MHz tone spacing, all supplies at MIN, TYP, or MAX recommended operating voltages

Figure 7-171. RX IMD5 vs Supply Voltage and Channel at 3.6 GHz

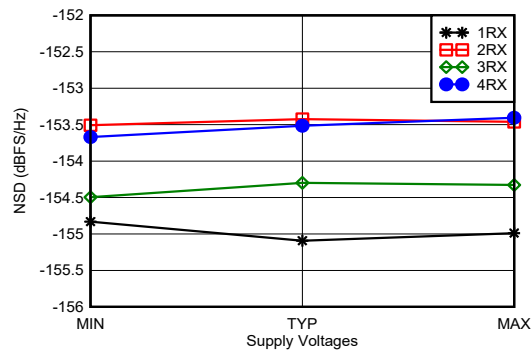

With 3.6 GHz matching, tone at -20 dBFS, 12.5-MHz offset frequency, all supplies at MIN, TYP, or MAX recommended operating voltages

Figure 7-172. RX Noise Spectral Density vs Supply Voltage and Channel at 3.6 GHz

7.12.6 RX Typical Characteristics 4.9 GHz

Typical values at $T_A = +25^\circ\text{C}$, ADC Sampling Rate = 2949.12 MHz. Default conditions: output sample rate = 491.52 MSPS (decimate by 6), PLL clock mode with $f_{REF} = 491.52\text{ MHz}$, $A_{IN} = -3\text{ dBFS}$, DSA setting = 4 dB.

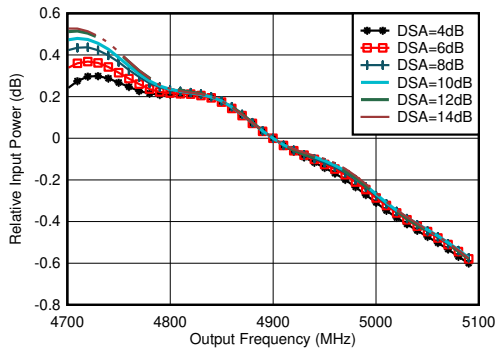

With matching, normalized to power at 4.9GHz for each DSA setting

Figure 7-173. RX Inband Gain Flatness, $f_{IN} = 4900\text{ MHz}$

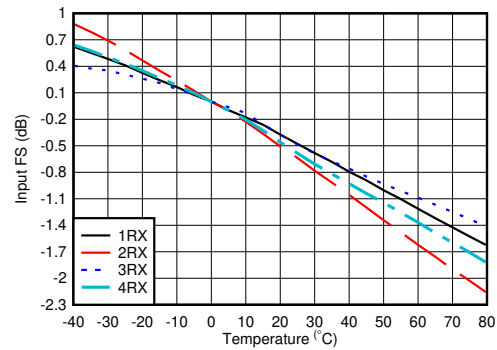

With 4.9 GHz matching, normalized to fullscale at 25°C for each channel

Figure 7-174. RX Input Fullscale vs Temperature and Channel at 4.9 GHz

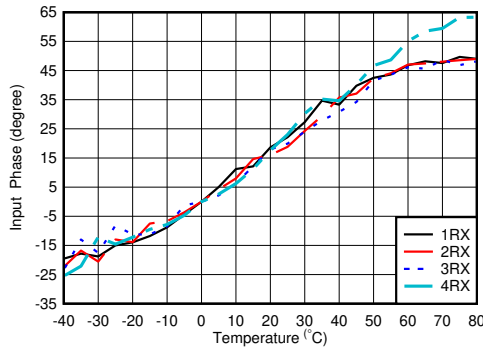

With 4.9 GHz matching, normalized to phase at 25°C

Figure 7-175. RX Input Phase vs Temperature and DSA at $f_{OUT} = 4.9\text{ GHz}$

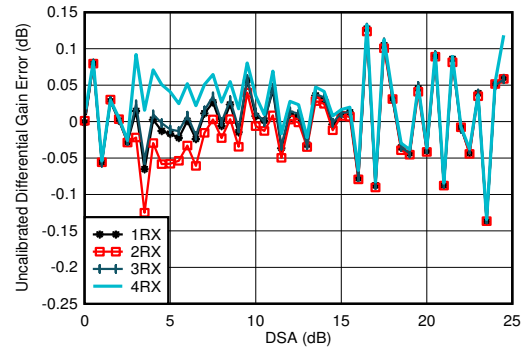

With 4.9 GHz matching

$$\text{Differential Amplitude Error} = P_{IN}(\text{DSA Setting} - 1) - P_{IN}(\text{DSA Setting}) + 1$$

Figure 7-176. RX Uncalibrated Differential Amplitude Error vs DSA Setting at 4.9 GHz

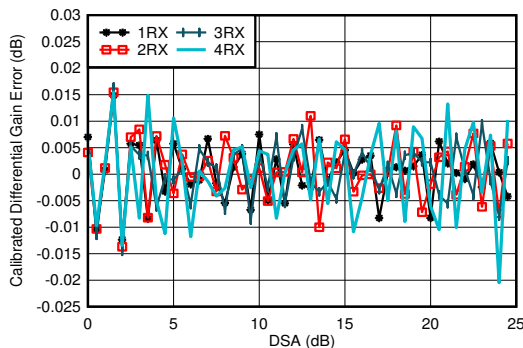

With 4.9 GHz matching

$$\text{Differential Amplitude Error} = P_{IN}(\text{DSA Setting} - 1) - P_{IN}(\text{DSA Setting}) + 1$$

Figure 7-177. RX Calibrated Differential Amplitude Error vs DSA Setting at 4.9 GHz

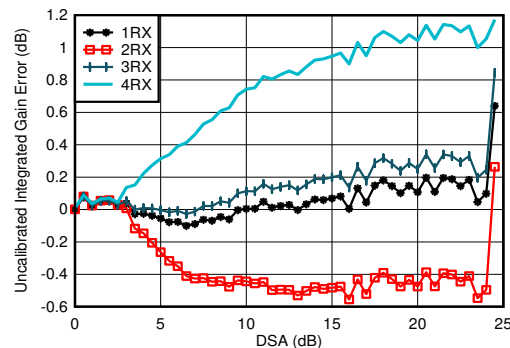

With 4.9 GHz matching

$$\text{Integrated Amplitude Error} = P_{IN}(\text{DSA Setting}) - P_{IN}(\text{DSA Setting} = 0) + (\text{DSA Setting})$$

Figure 7-178. RX Uncalibrated Integrated Amplitude Error vs DSA Setting at 4.9 GHz

7.12.6 RX Typical Characteristics 4.9 GHz (continued)

Typical values at $T_A = +25^\circ\text{C}$, ADC Sampling Rate = 2949.12 MHz. Default conditions: output sample rate = 491.52 MSPS (decimate by 6), PLL clock mode with $f_{REF} = 491.52\text{ MHz}$, $A_{IN} = -3\text{ dBFS}$, DSA setting = 4 dB.

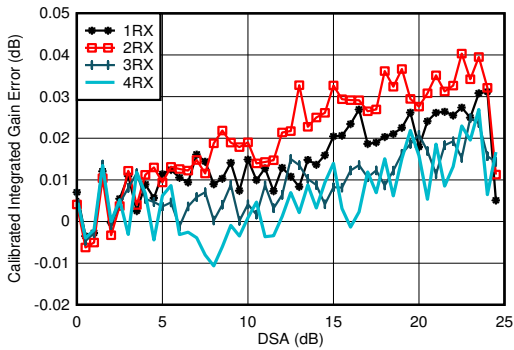

With 4.9 GHz matching
 Integrated Amplitude Error = $P_{IN}(\text{DSA Setting}) - P_{IN}(\text{DSA Setting} = 0) + (\text{DSA Setting})$

Figure 7-179. RX Calibrated Integrated Amplitude Error vs DSA Setting at 4.9 GHz

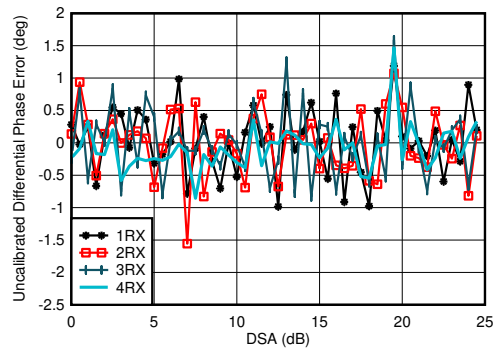

With 4.9 GHz matching
 Differential Phase Error = $\text{Phase}_{IN}(\text{DSA Setting} - 1) - \text{Phase}_{IN}(\text{DSA Setting})$

Figure 7-180. RX Uncalibrated Differential Phase Error vs DSA Setting at 4.9 GHz

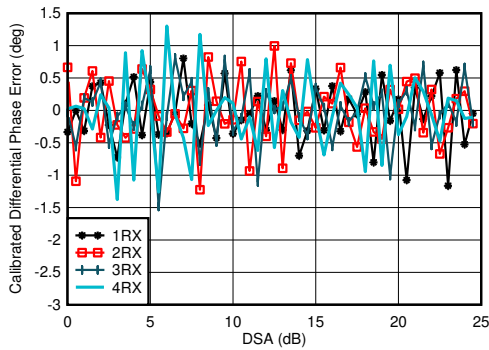

With 4.9 GHz matching
 Differential Phase Error = $\text{Phase}_{IN}(\text{DSA Setting} - 1) - \text{Phase}_{IN}(\text{DSA Setting})$

Figure 7-181. RX Calibrated Differential Phase Error vs DSA Setting at 4.9 GHz

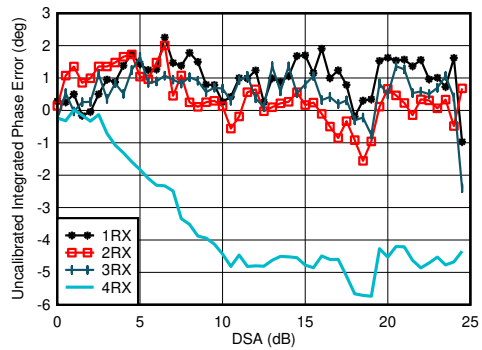

With 4.9 GHz matching
 Integrated Phase Error = $\text{Phase}(\text{DSA Setting}) - \text{Phase}(\text{DSA Setting} = 0)$

Figure 7-182. RX Uncalibrated Integrated Phase Error vs DSA Setting at 4.9 GHz

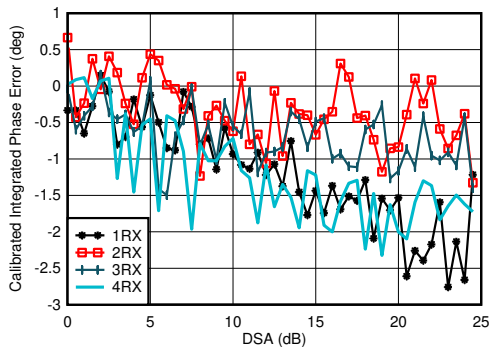

With 4.9 GHz matching
 Integrated Phase Error = $\text{Phase}(\text{DSA Setting}) - \text{Phase}(\text{DSA Setting} = 0)$

Figure 7-183. RX Calibrated Integrated Phase Error vs DSA Setting at 4.9 GHz

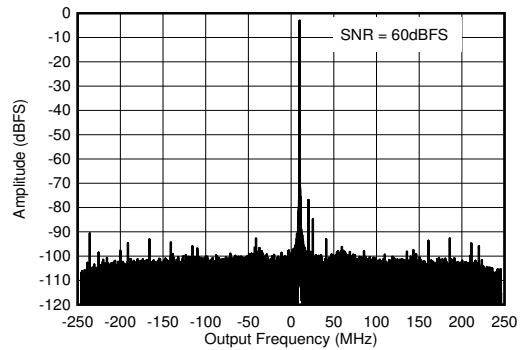

With 4.9 GHz matching, $f_{IN} = 4910\text{ MHz}$, $A_{IN} = -3\text{ dBFS}$

Figure 7-184. RX Output FFT at 4.9 GHz

7.12.6 RX Typical Characteristics 4.9 GHz (continued)

Typical values at $T_A = +25^\circ\text{C}$, ADC Sampling Rate = 2949.12 MHz. Default conditions: output sample rate = 491.52 MSPS (decimate by 6), PLL clock mode with $f_{REF} = 491.52\text{ MHz}$, $A_{IN} = -3\text{ dBFS}$, DSA setting = 4 dB.

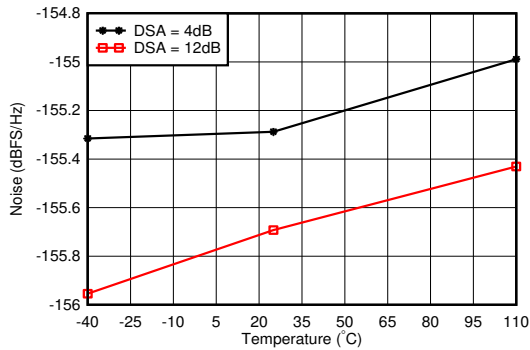

With 4.9 GHz matching, 12.5-MHz offset from tone

Figure 7-185. RX Noise Spectral Density vs Temperature at 4.9 GHz

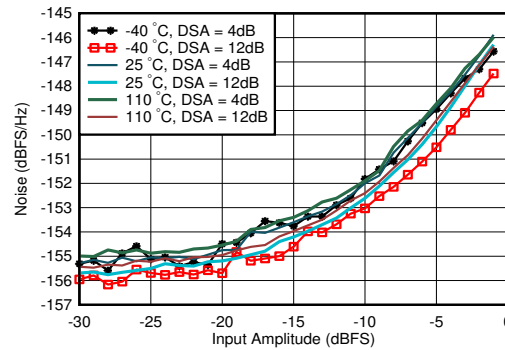

With 4.9 GHz matching, DSA Setting = 12 dB, 12.5-MHz offset from tone

Figure 7-186. RX Noise Spectral Density vs Input Amplitude and Temperature at 4.9 GHz

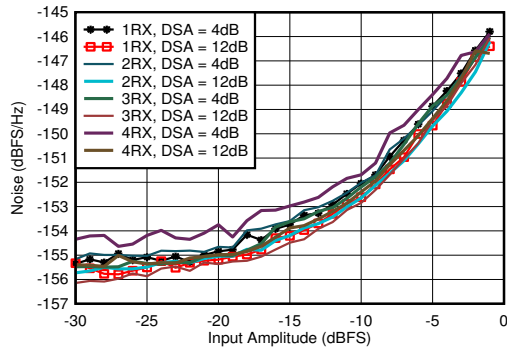

With 4.9 GHz matching, 12.5-MHz offset from tone

Figure 7-187. RX Noise Spectral Density vs Input Amplitude and Channel at 4.9 GHz

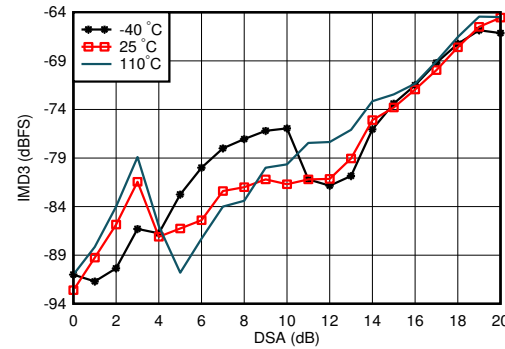

With 4.9 GHz matching, each tone -7 dBFS , tone spacing = 20 MHz

Figure 7-188. RX IMD3 vs DSA Setting and Temperature at 4.9 GHz

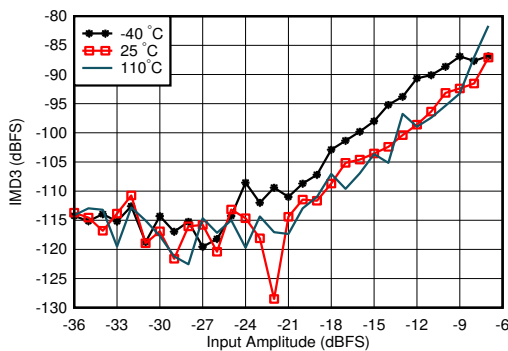

With 4.9 GHz matching, tone spacing = 20 MHz, DSA = 4 dB

Figure 7-189. RX IMD3 vs Input Level and Temperature at 4.9 GHz

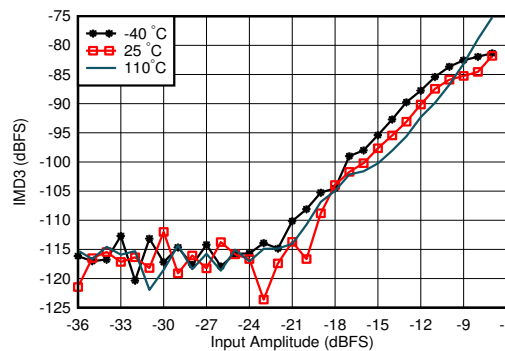

With 4.9 GHz matching, tone spacing = 20 MHz, DSA = 12 dB

Figure 7-190. RX IMD3 vs Input Level and Temperature at 4.9 GHz

7.12.6 RX Typical Characteristics 4.9 GHz (continued)

Typical values at $T_A = +25^\circ\text{C}$, ADC Sampling Rate = 2949.12 MHz. Default conditions: output sample rate = 491.52 MSPS (decimate by 6), PLL clock mode with $f_{REF} = 491.52\text{ MHz}$, $A_{IN} = -3\text{ dBFS}$, DSA setting = 4 dB.

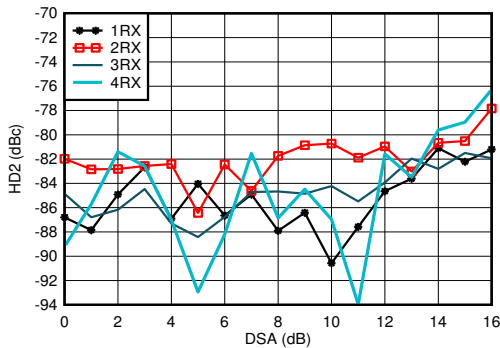

With 4.9 GHz matching, measured after HD2 trim, DDC bypass mode (TI only mode for characterization)

Figure 7-191. RX HD2 vs DSA Setting and Channel at 4.9 GHz

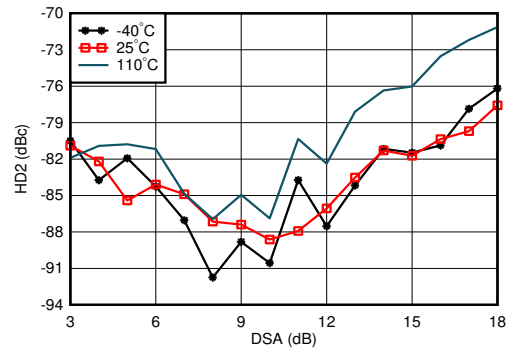

With 4.9 GHz matching, measured after HD2 trim, DDC bypass mode (TI only mode for characterization)

Figure 7-192. RX HD2 vs DSA and Temperature at 4.9 GHz

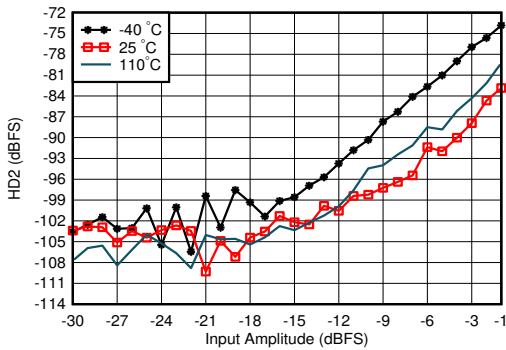

With 4.9 GHz matching, measured after HD2 trim, DDC bypass mode (TI only mode for characterization)

Figure 7-193. RX HD2 vs Input Level and Temperature at 4.9 GHz

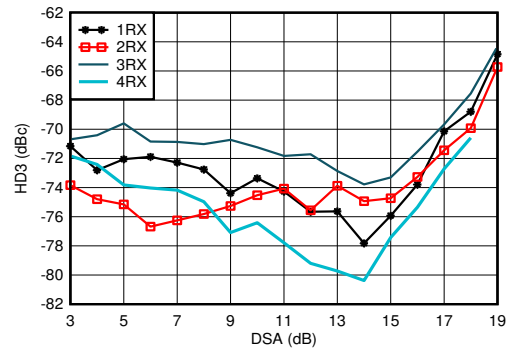

With 4.9 GHz matching, DDC bypass mode (TI only mode for characterization)

Figure 7-194. RX HD3 vs DSA Setting and Channel at 4.9 GHz

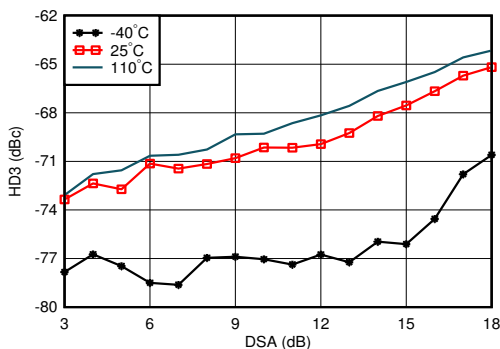

With 4.9 GHz matching, DDC bypass mode (TI only mode for characterization)

Figure 7-195. RX HD3 vs DSA Setting and Temperature at 4.9 GHz

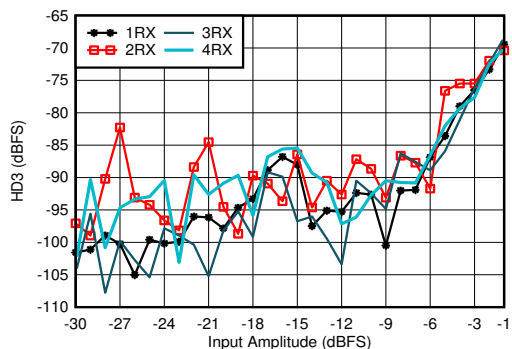

With 4.9 GHz matching, DDC bypass mode (TI only mode for characterization)

Figure 7-196. RX HD3 vs Input Level and Channel at 4.9 GHz

7.12.6 RX Typical Characteristics 4.9 GHz (continued)

Typical values at $T_A = +25^\circ\text{C}$, ADC Sampling Rate = 2949.12 GHz. Default conditions: output sample rate = 491.52 MSPS (decimate by 6), PLL clock mode with $f_{REF} = 491.52\text{ MHz}$, $A_{IN} = -3\text{ dBFS}$, DSA setting = 4 dB.

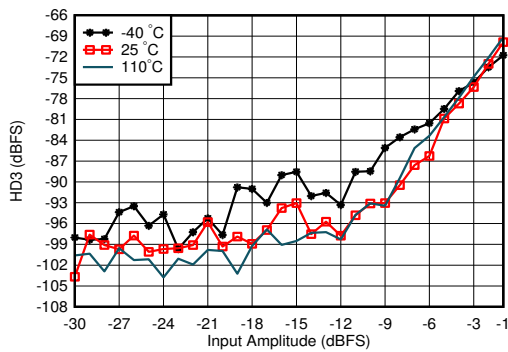

With 4.9 GHz matching, DDC bypass mode (TI only mode for characterization)

Figure 7-197. RX HD3 vs Input Level and Temperature at 4.9 GHz

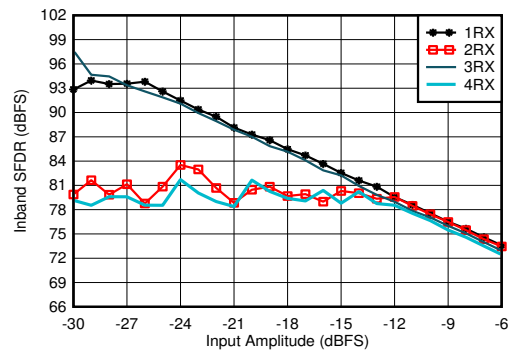

With 4.9 GHz matching, decimate by 3

Figure 7-198. RX In-Band SFDR ($\pm 400\text{ MHz}$) vs Input Amplitude and Channel at 4.9 GHz

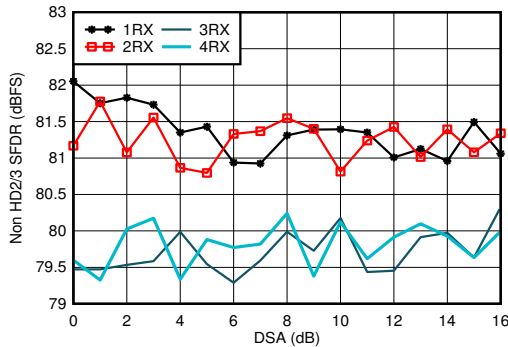

With 4.9 GHz matching

Figure 7-199. RX Non-HD2/3 vs DSA Setting at 4.9 GHz

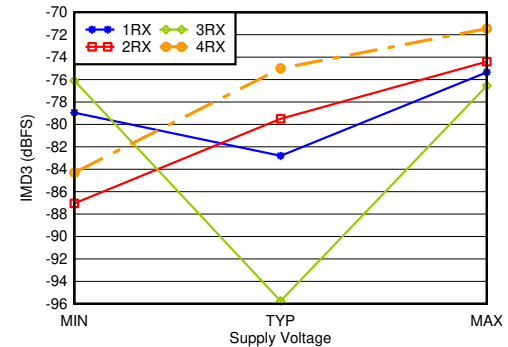

With 4.9 GHz matching, -7 dBFS each tone, 20-MHz tone spacing, all supplies at MIN, TYP, or MAX recommended operating voltages

Figure 7-200. RX IMD3 vs Supply and Channel at 4.9 GHz

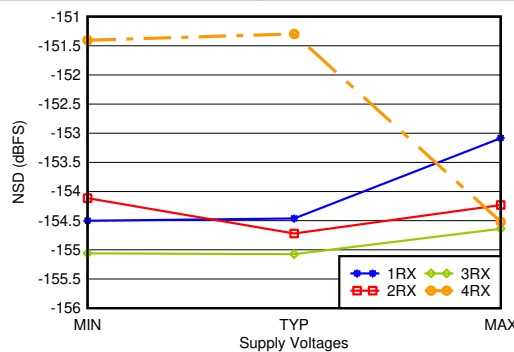

With 4.9 GHz matching, 12.5-MHz offset, all supplies at MIN, TYP, or MAX recommended operating voltages

Figure 7-201. RX Noise Spectral Density vs Supply and Channel at 4.9 GHz

7.12.7 RX Typical Characteristics 6.8 GHz

Typical values at $T_A = +25^\circ\text{C}$. Default conditions at 30 MHz: ADC Sampling Rate = 3000MSPS, output sample rate = 500 MSPS (decimate by 6x), External clock mode , $A_{IN} = -3$ dBFS, DSA setting = 3 dB.

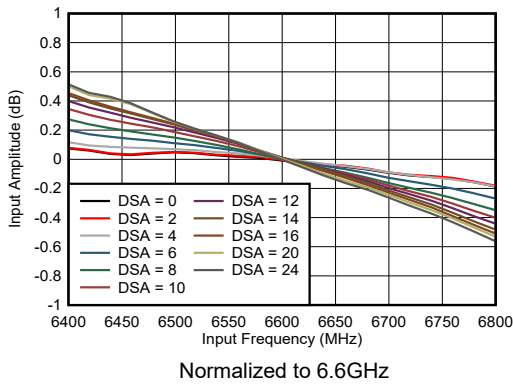

Figure 7-202. RX In-Band Gain Flatness

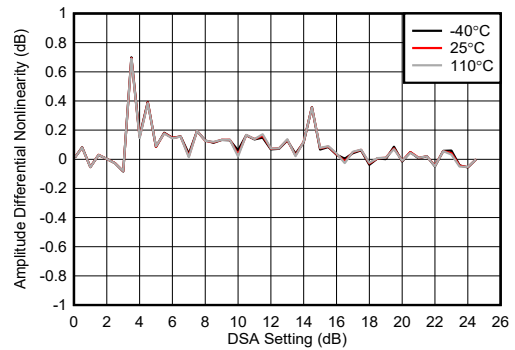

Figure 7-203. RX Uncalibrated Differential Amplitude Error at 6.851 GHz

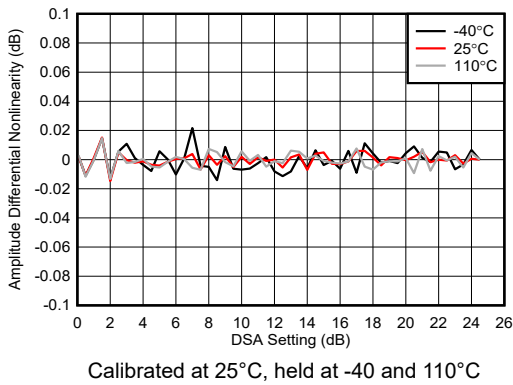

Figure 7-204. RX Calibrated Differential Amplitude Error at 6.851 GHz

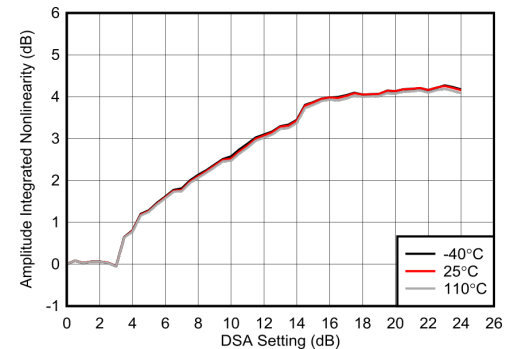

Figure 7-205. RX Uncalibrated Integrated Amplitude Error at 6.851 GHz

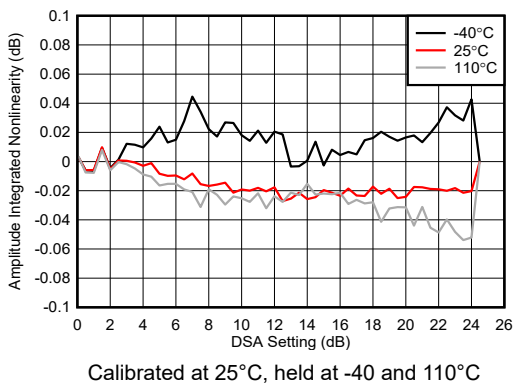

Figure 7-206. RX Calibrated Integrated Amplitude Error at 6.851 GHz

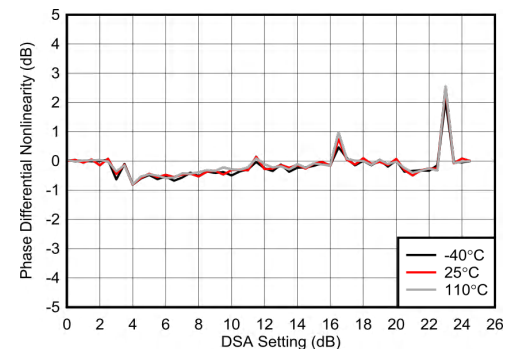
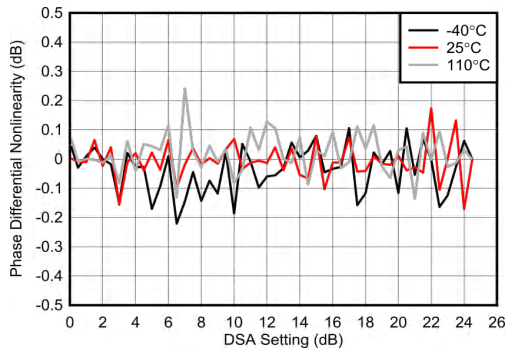

Figure 7-207. RX Uncalibrated Differential Phase Error at 6.851 GHz

7.12.7 RX Typical Characteristics 6.8 GHz (continued)

Typical values at $T_A = +25^\circ\text{C}$. Default conditions at 30 MHz: ADC Sampling Rate = 3000MSPS, output sample rate = 500 MSPS (decimate by 6x), External clock mode, $A_{IN} = -3$ dBFS, DSA setting = 3 dB.



Calibrated at 25°C, held at -40 and 110°C

Figure 7-208. RX Calibrated Differential Phase Error at 6.851 GHz

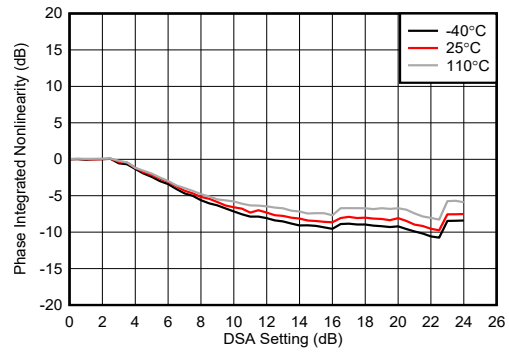
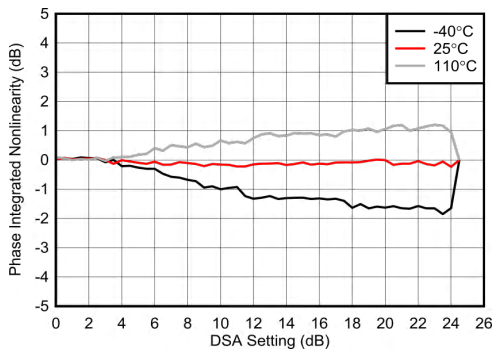
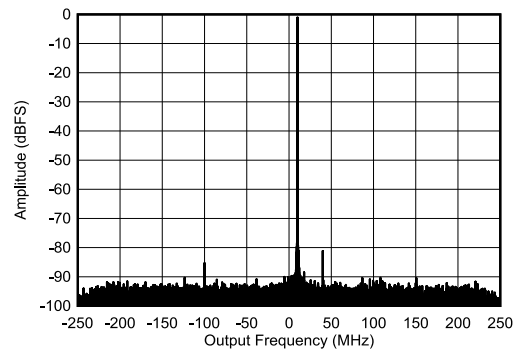

Figure 7-209. RX Uncalibrated Integrated Phase Error at 6.851 GHz



Calibrated at 25°C, held at -40 and 110°C

Figure 7-210. RX Calibrated Integrated Phase Error at 6.851 GHz



$F_{NCO} = 7.1$ GHz

Figure 7-211. Single Tone RX Output FFT at 7.11 GHz and -1 dBFS

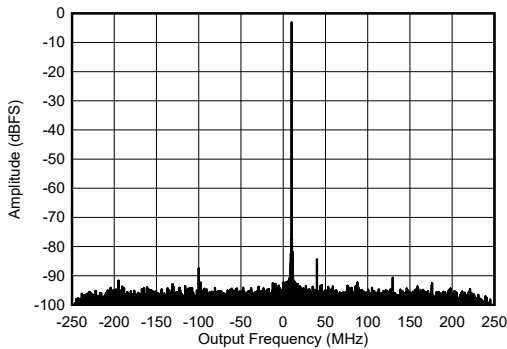

$F_{NCO} = 7.1$ GHz

Figure 7-212. Single Tone RX Output FFT at 7.11 GHz and -3 dBFS

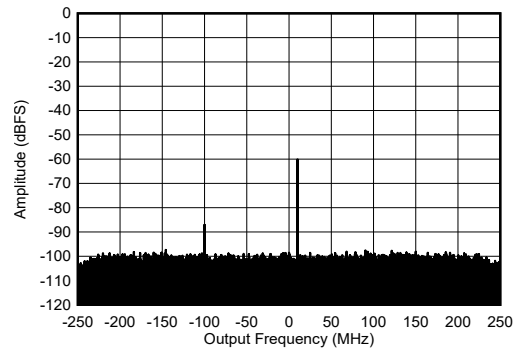

$F_{NCO} = 7.1$ GHz

Figure 7-213. Single Tone RX Output FFT at 7.11 GHz and -6 dBFS

7.12.7 RX Typical Characteristics 6.8 GHz (continued)

Typical values at $T_A = +25^\circ\text{C}$. Default conditions at 30 MHz: ADC Sampling Rate = 3000MSPS, output sample rate = 500 MSPS (decimate by 6x), External clock mode , $A_{IN} = -3$ dBFS, DSA setting = 3 dB.

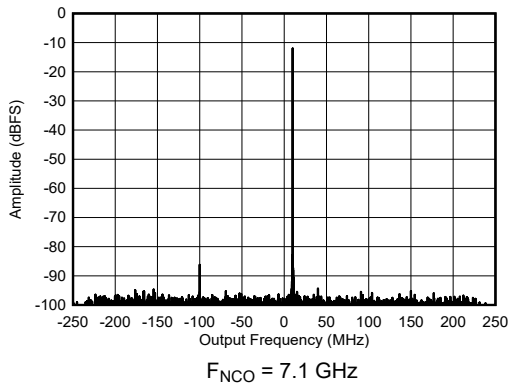

Figure 7-214. Single Tone RX Output FFT at 7.11 GHz and -12 dBFS

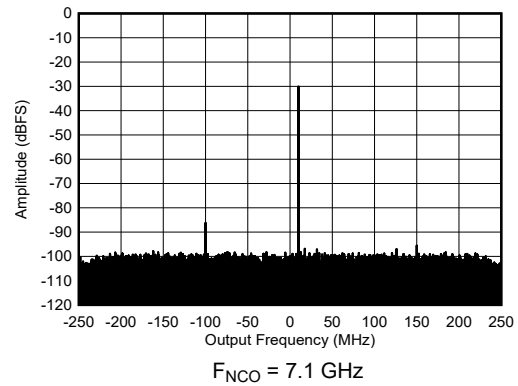

Figure 7-215. Single Tone RX Output FFT at 7.11 GHz and -30 dBFS

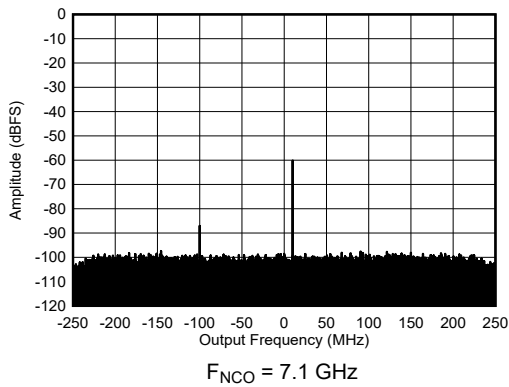

Figure 7-216. Single Tone RX Output FFT at 7.1 GHz and -60 dBFS

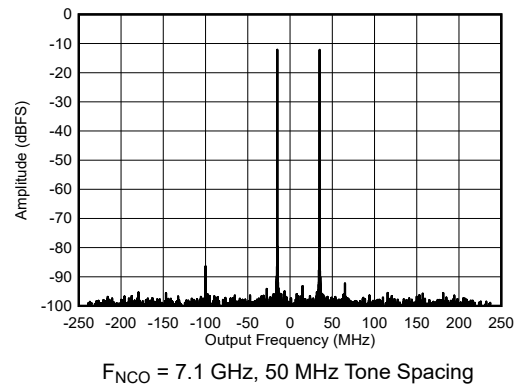

Figure 7-217. Dual Tone RX Output FFT at 7.1 GHz and -12 dBFS per Tone

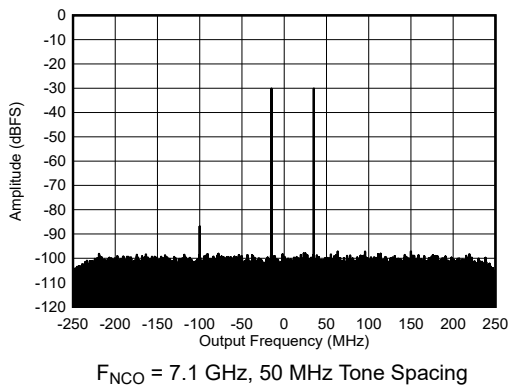

Figure 7-218. Dual Tone RX Output FFT at 7.1 GHz and -30 dBFS per Tone

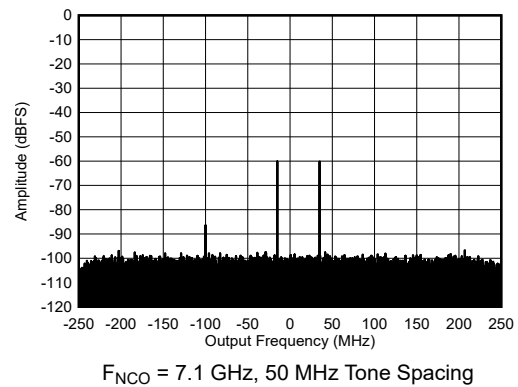

Figure 7-219. Dual Tone RX Output FFT at 7.1 GHz and -60 dBFS per Tone

7.12.7 RX Typical Characteristics 6.8 GHz (continued)

Typical values at $T_A = +25^\circ\text{C}$. Default conditions at 30 MHz: ADC Sampling Rate = 3000MSPS, output sample rate = 500 MSPS (decimate by 6x), External clock mode, $A_{IN} = -3$ dBFS, DSA setting = 3 dB.

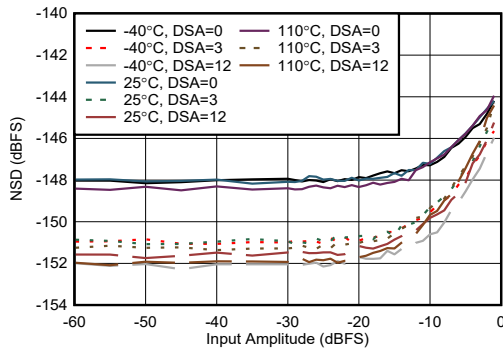
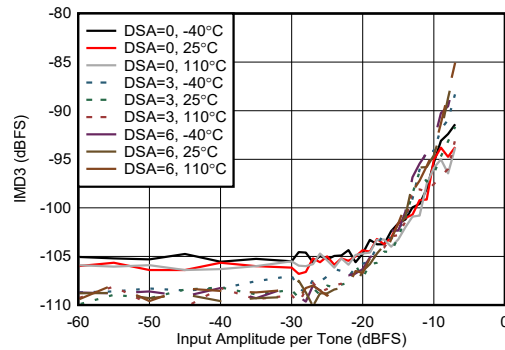
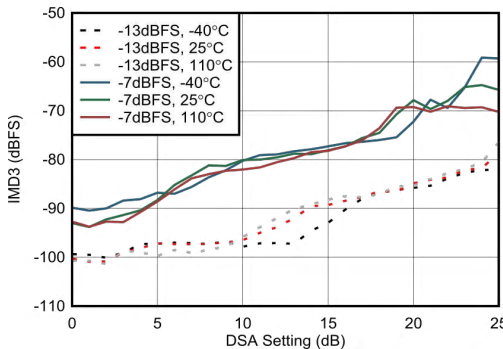

Figure 7-220. RX NSD vs Input Amplitude at 6.851 GHz



100 MHz Tone Spacing

Figure 7-221. RX IMD3 vs Input Amplitude at 6.851 GHz



100 MHz Tone Spacing

Figure 7-222. RX IMD3 vs DSA Setting at 6.851 GHz

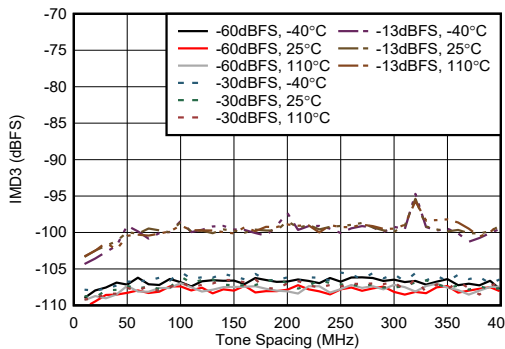

Figure 7-223. RX IMD3 vs Tone Spacing at 6.851 GHz

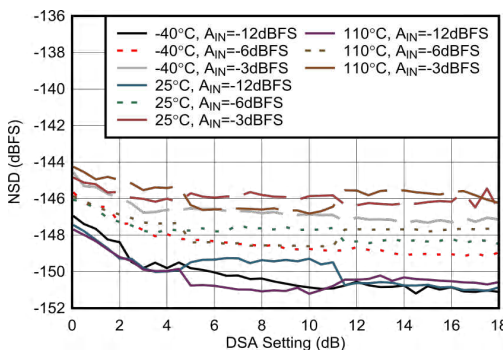

Figure 7-224. RX NSD vs DSA Setting at 6.851 GHz

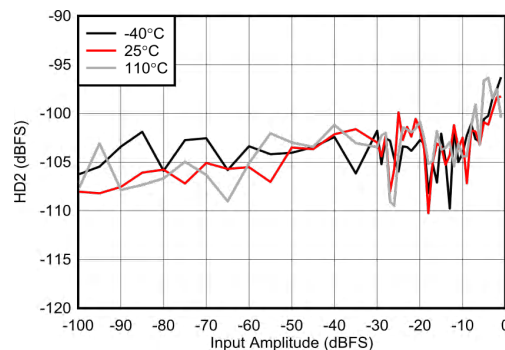

Figure 7-225. RX HD2 vs Input Amplitude at 6.851 GHz

7.12.7 RX Typical Characteristics 6.8 GHz (continued)

Typical values at $T_A = +25^\circ\text{C}$. Default conditions at 30 MHz: ADC Sampling Rate = 3000MSPS, output sample rate = 500 MSPS (decimate by 6x), External clock mode, $A_{IN} = -3\text{ dBFS}$, DSA setting = 3 dB.

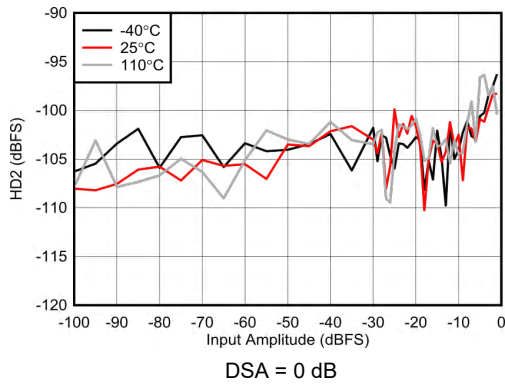

Figure 7-226. RX HD2 vs Input Amplitude at 6.851 GHz

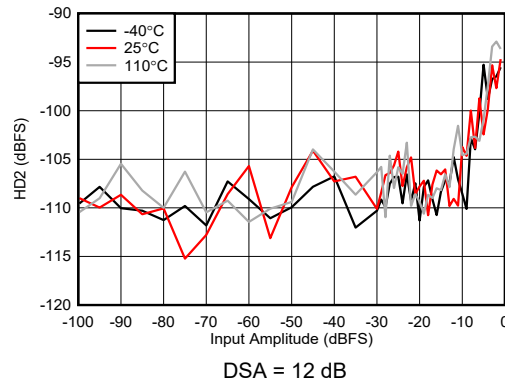

Figure 7-227. RX HD2 vs Input Amplitude at 6.851 GHz

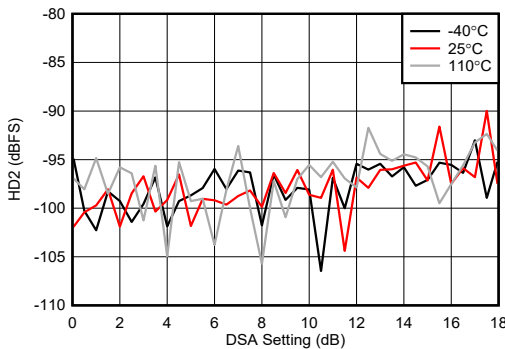

Figure 7-228. RX HD2 vs DSA Setting at 6.851 GHz

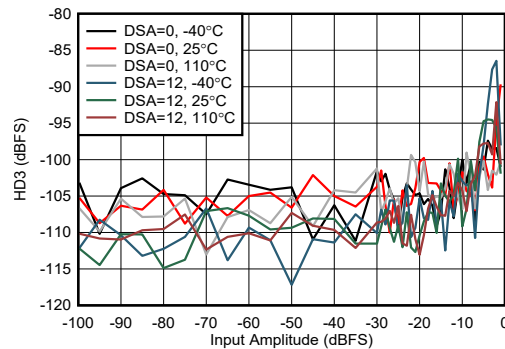

Figure 7-229. RX HD3 vs Input Amplitude at 6.851 GHz

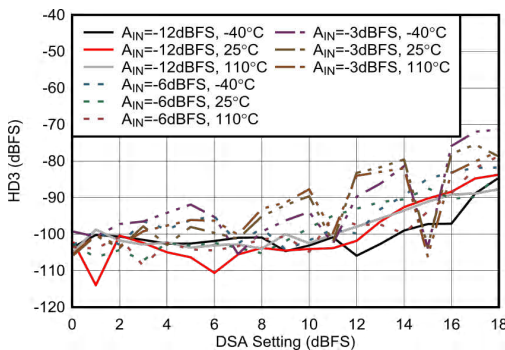

Figure 7-230. RX HD3 vs DSA Setting at 6.851 GHz

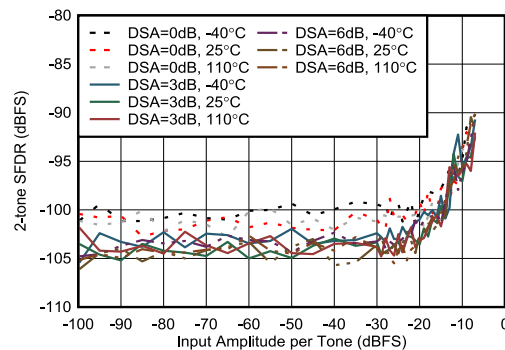

Figure 7-231. RX 2-tone SFDR vs Input Amplitude at 6.85 GHz
100 MHz tone spacing, excluding 3rd order distortion

7.12.7 RX Typical Characteristics 6.8 GHz (continued)

Typical values at $T_A = +25^\circ\text{C}$. Default conditions at 30 MHz: ADC Sampling Rate = 3000MSPS, output sample rate = 500 MSPS (decimate by 6x), External clock mode, $A_{IN} = -3$ dBFS, DSA setting = 3 dB.

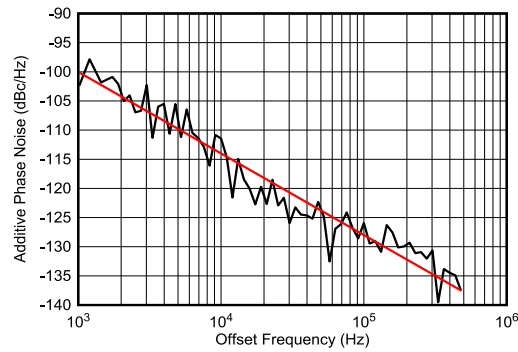
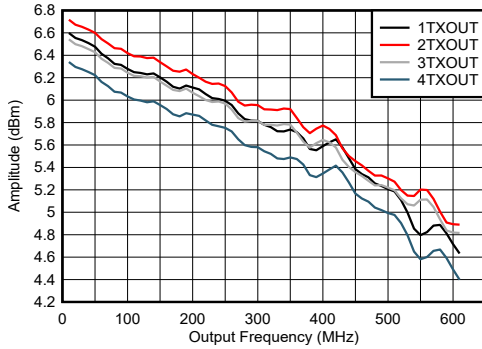

Figure 7-232. RX Additive Phase Noise at 6.85 GHz

7.12.8 TX Typical Characteristics at 30 MHz and 400 MHz

Typical values at $T_A = +25^\circ\text{C}$ with nominal supplies. Default conditions: TX input data rate = 125 MSPS, $f_{\text{DAC}} = 6000$ MSPS (48x interpolation), interleave mode, 1st Nyquist zone output, PLL clock mode with $f_{\text{REF}} = 500$ MHz. Additional default conditions for all plots, $A_{\text{OUT}} = -1$ dBFS, DSA = 0 dB, Sin(x)/x enabled, DSA calibrated.



including PCB and cable losses

Figure 7-233. TX Output Fullscale vs Output Frequency: 5 MHz - 600 MHz

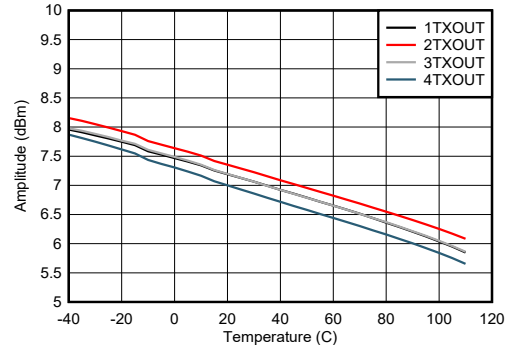

including PCB and cable losses

Figure 7-234. TX Output Fullscale vs Temperature at 30 MHz

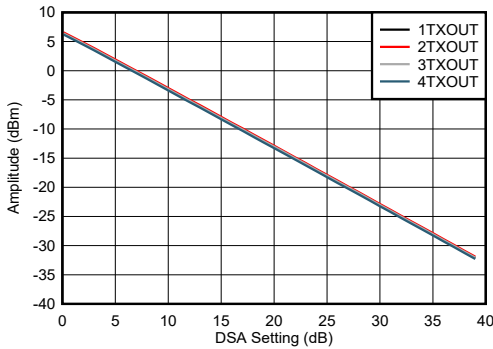

including PCB and cable losses

Figure 7-235. TX Output Fullscale vs DSA Setting at 30 MHz

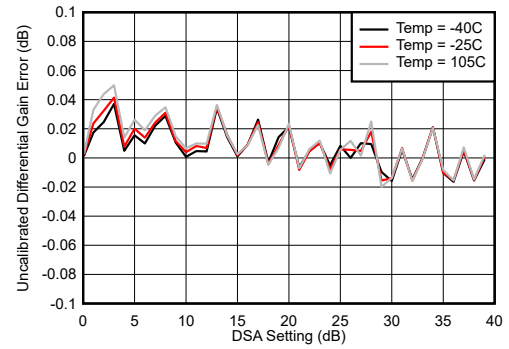

Differential Gain Error = $P_{\text{OUT}}(\text{DSA Setting} - 1) - P_{\text{OUT}}(\text{DSA Setting}) + 1$

Figure 7-236. Uncalibrated TX Differential Gain Error (DNL) at 30 MHz

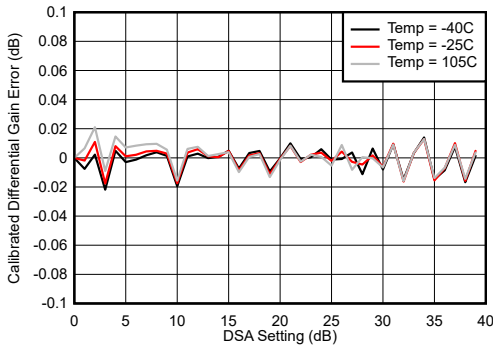

Differential Gain Error = $P_{\text{OUT}}(\text{DSA Setting} - 1) - P_{\text{OUT}}(\text{DSA Setting}) + 1$

Figure 7-237. Calibrated TX Differential Gain Error (DNL) at 30MHz

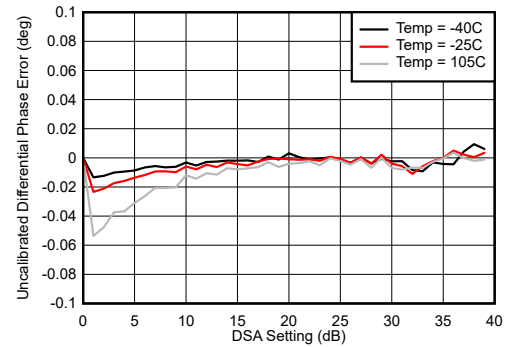

Differential Gain Error = $P_{\text{OUT}}(\text{DSA Setting} - 1) - P_{\text{OUT}}(\text{DSA Setting}) + 1$

Figure 7-238. Calibrated TX Differential Gain Error (DNL) at 30 MHz

7.12.8 TX Typical Characteristics at 30 MHz and 400 MHz (continued)

Typical values at $T_A = +25^\circ\text{C}$ with nominal supplies. Default conditions: TX input data rate = 125 MSPS, $f_{\text{DAC}} = 6000$ MSPS (48x interpolation), interleave mode, 1st Nyquist zone output, PLL clock mode with $f_{\text{REF}} = 500$ MHz. Additional default conditions for all plots, $A_{\text{OUT}} = -1$ dBFS, DSA = 0 dB, Sin(x)/x enabled, DSA calibrated.

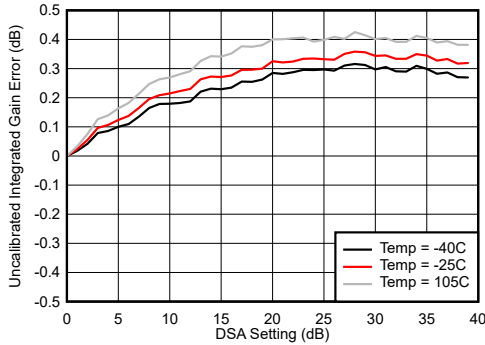

$$\text{Integrated Gain Error} = P_{\text{OUT}}(\text{DSA Setting}) - P_{\text{OUT}}(\text{DSASetting} = 0) + (\text{DSA Setting})$$

Figure 7-239. Uncalibrated TX Integrated Gain Error (INL) at 30 MHz

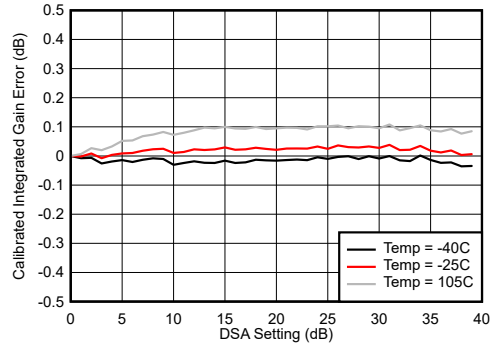

$$\text{Integrated Gain Error} = P_{\text{OUT}}(\text{DSA Setting}) - P_{\text{OUT}}(\text{DSASetting} = 0) + (\text{DSA Setting})$$

Figure 7-240. Calibrated TX Integrated Gain Error (INL) at 30 MHz

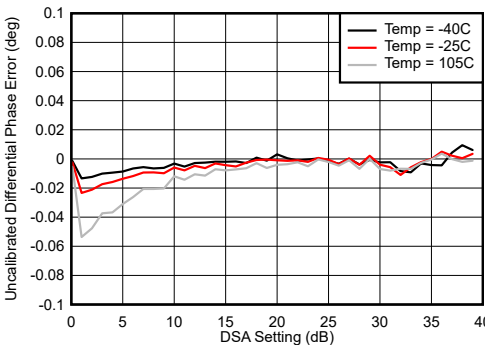

$$\text{Differential Phase Error} = \text{Phase}_{\text{OUT}}(\text{DSA Setting} - 1) - \text{Phase}_{\text{OUT}}(\text{DSA Setting})$$

Figure 7-241. Uncalibrated TX Differential Phase Error (DNL) at 30 MHz

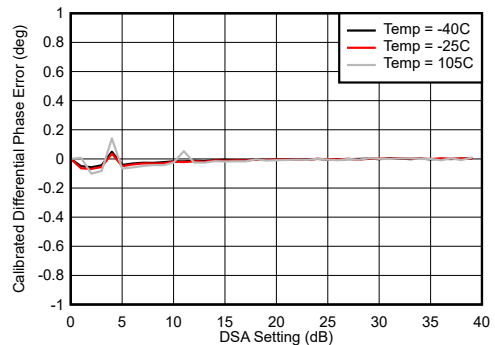

$$\text{Differential Phase Error} = \text{Phase}_{\text{OUT}}(\text{DSA Setting} - 1) - \text{Phase}_{\text{OUT}}(\text{DSA Setting})$$

Figure 7-242. Calibrated TX Differential Phase Error (DNL) at 30 MHz

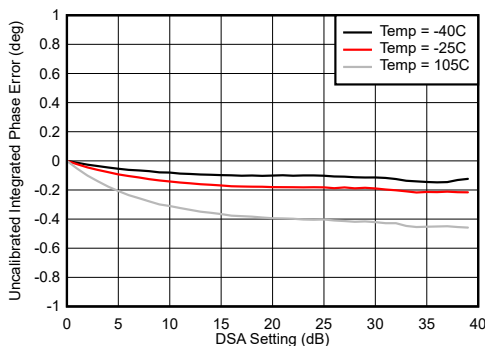

$$\text{Integrated Phase Error} = \text{Phase}_{\text{OUT}}(\text{DSA Setting}) - \text{Phase}_{\text{OUT}}(\text{DSASetting} = 0)$$

Figure 7-243. Uncalibrated TX Integrated Phase Error (INL) at 30 MHz

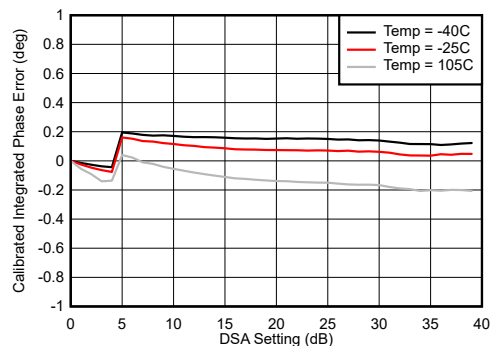

$$\text{Integrated Phase Error} = \text{Phase}_{\text{OUT}}(\text{DSA Setting}) - \text{Phase}_{\text{OUT}}(\text{DSASetting} = 0)$$

Figure 7-244. Calibrated TX Integrated Phase Error (INL) at 30 MHz

7.12.8 TX Typical Characteristics at 30 MHz and 400 MHz (continued)

Typical values at $T_A = +25^\circ\text{C}$ with nominal supplies. Default conditions: TX input data rate = 125 MSPS, $f_{\text{DAC}} = 6000$ MSPS (48x interpolation), interleave mode, 1st Nyquist zone output, PLL clock mode with $f_{\text{REF}} = 500$ MHz. Additional default conditions for all plots, $A_{\text{OUT}} = -1$ dBFS, DSA = 0 dB, Sin(x)/x enabled, DSA calibrated.

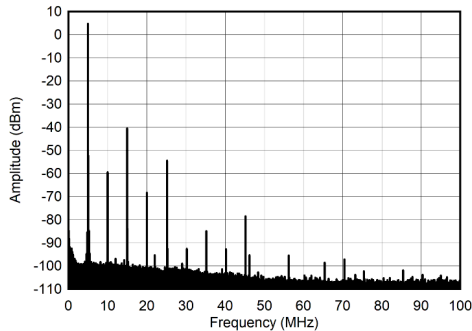

Figure 7-245. Single Tone Spectrum at 5 MHz and -1 dBFS (0 - 100 MHz)

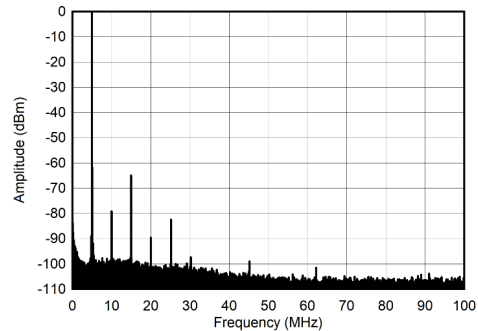

Figure 7-246. Single Tone Spectrum at 5 MHz and -6d BFS (0 - 100 MHz)

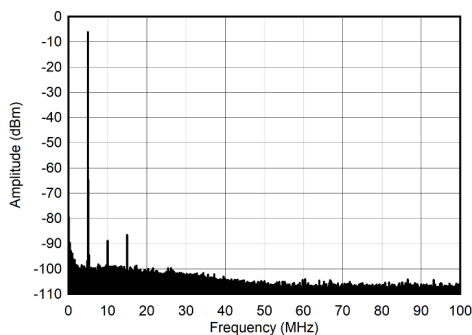

Figure 7-247. Single Tone Spectrum at 5 MHz and -12 dBFS (0 - 100 MHz)

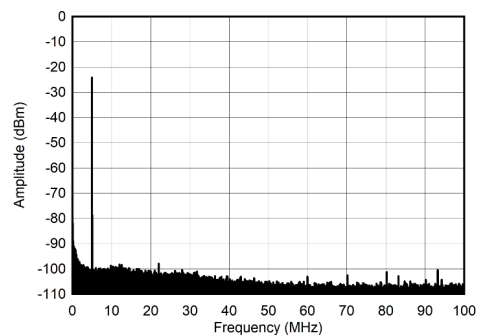

Figure 7-248. Single Tone Spectrum at 5 MHz and -30 dBFS (0 - 100 MHz)

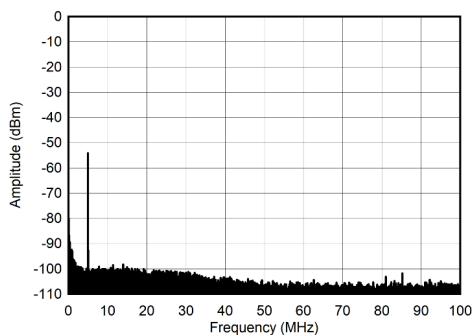

Figure 7-249. Single Tone Spectrum at 5 MHz and -60 dBFS (0 - 100 MHz)

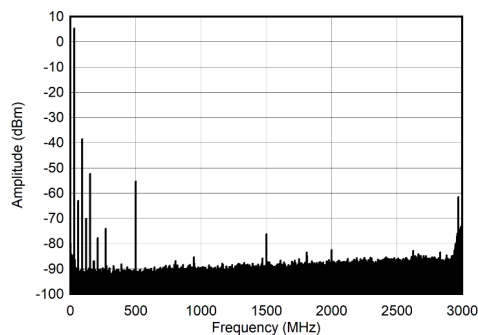

Figure 7-250. Single Tone Spectrum at 30 MHz and -1 dBFS (Nyquist)

7.12.8 TX Typical Characteristics at 30 MHz and 400 MHz (continued)

Typical values at $T_A = +25^\circ\text{C}$ with nominal supplies. Default conditions: TX input data rate = 125 MSPS, $f_{\text{DAC}} = 6000$ MSPS (48x interpolation), interleave mode, 1st Nyquist zone output, PLL clock mode with $f_{\text{REF}} = 500$ MHz. Additional default conditions for all plots, $A_{\text{OUT}} = -1$ dBFS, DSA = 0 dB, Sin(x)/x enabled, DSA calibrated.

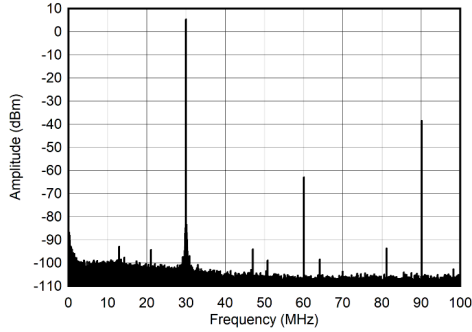

Figure 7-251. Single Tone Spectrum at 30 MHz and -1 dBFS (0 - 100 MHz)

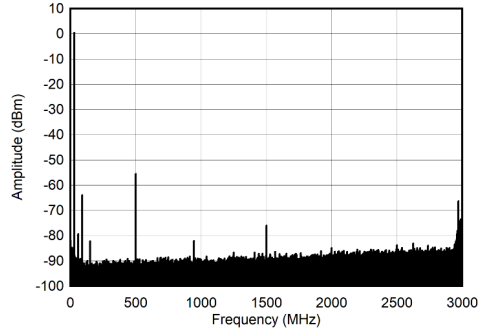

Figure 7-252. Single Tone Spectrum at 30 MHz and -6 dBFS (Nyquist)

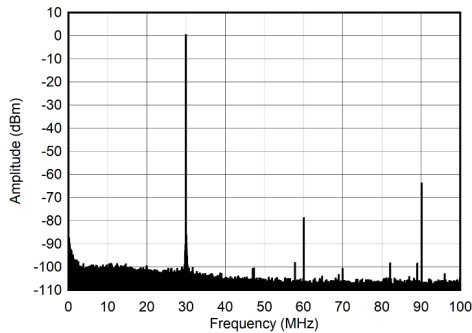

Figure 7-253. Single Tone Spectrum at 30 MHz and -6 dBFS (0 - 100 MHz)

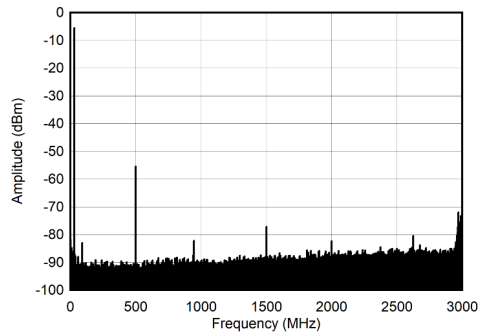

Figure 7-254. Single Tone Spectrum at 30 MHz and -12 dBFS (Nyquist)

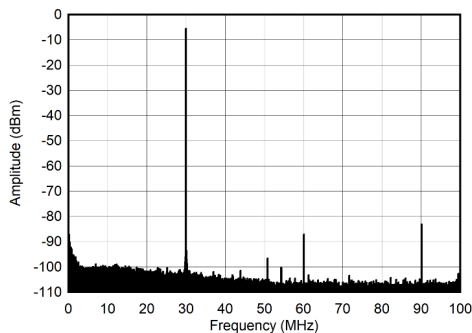

Figure 7-255. Single Tone Spectrum at 30 MHz and -12 dBFS (0 - 100 MHz)

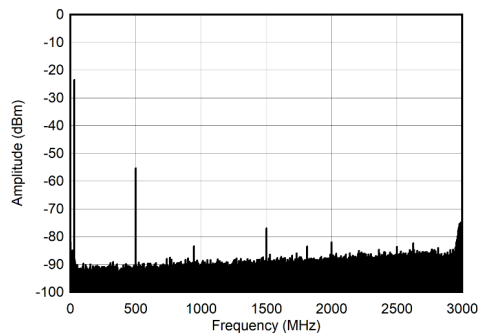

Figure 7-256. Single Tone Spectrum at 30 MHz and -30 dBFS (Nyquist)

7.12.8 TX Typical Characteristics at 30 MHz and 400 MHz (continued)

Typical values at $T_A = +25^\circ\text{C}$ with nominal supplies. Default conditions: TX input data rate = 125 MSPS, $f_{\text{DAC}} = 6000$ MSPS (48x interpolation), interleave mode, 1st Nyquist zone output, PLL clock mode with $f_{\text{REF}} = 500$ MHz. Additional default conditions for all plots, $A_{\text{OUT}} = -1$ dBFS, DSA = 0 dB, Sin(x)/x enabled, DSA calibrated.

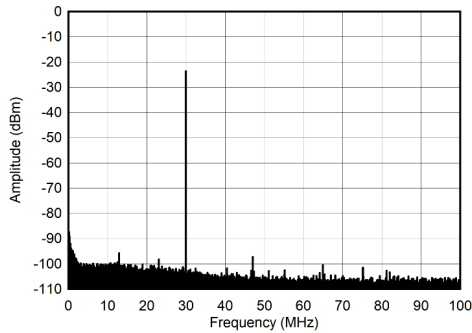

Figure 7-257. Single Tone Spectrum at 30 MHz and -30 dBFS (0 - 100 MHz)

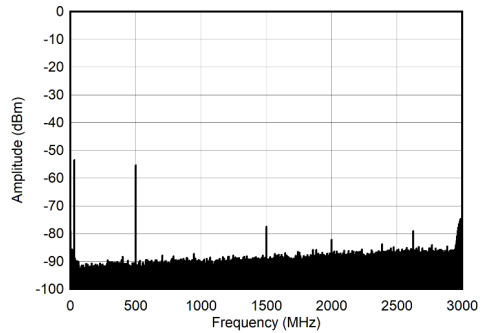

Figure 7-258. Single Tone Spectrum at 30 MHz and -60 dBFS (Nyquist)

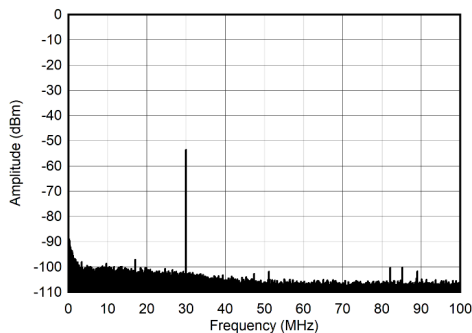

Figure 7-259. Single Tone Spectrum at 30 MHz and -60 dBFS (0 - 100 MHz)

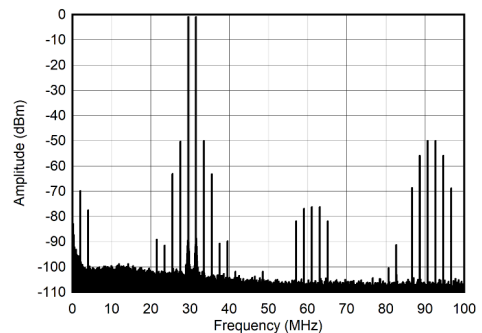

Figure 7-260. Dual Tone Spectrum at 30 MHz and -7 dBFS (0 - 100 MHz)

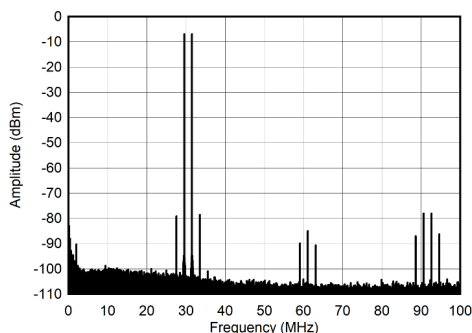

Figure 7-261. Dual Tone Spectrum at 30 MHz and -13 dBFS (0 - 100 MHz)

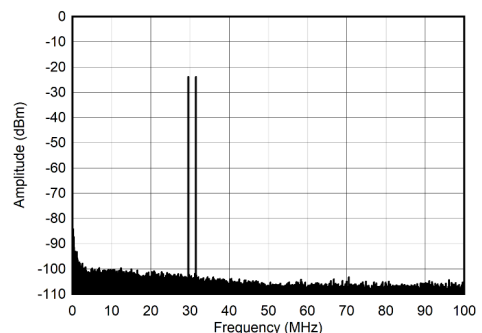

Figure 7-262. Dual Tone Spectrum at 30 MHz and -30 dBFS (0 - 100 MHz)

7.12.8 TX Typical Characteristics at 30 MHz and 400 MHz (continued)

Typical values at $T_A = +25^\circ\text{C}$ with nominal supplies. Default conditions: TX input data rate = 125 MSPS, $f_{\text{DAC}} = 6000$ MSPS (48x interpolation), interleave mode, 1st Nyquist zone output, PLL clock mode with $f_{\text{REF}} = 500$ MHz. Additional default conditions for all plots, $A_{\text{OUT}} = -1$ dBFS, DSA = 0 dB, Sin(x)/x enabled, DSA calibrated.

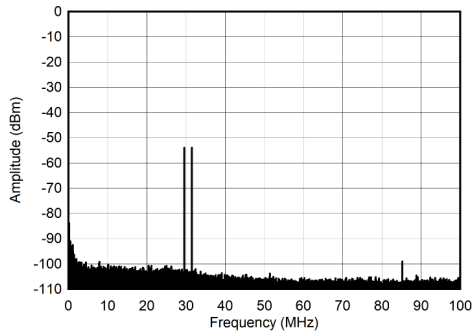
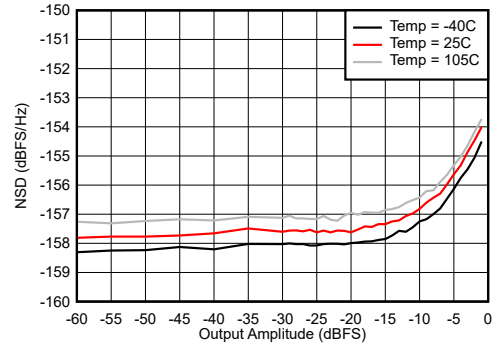
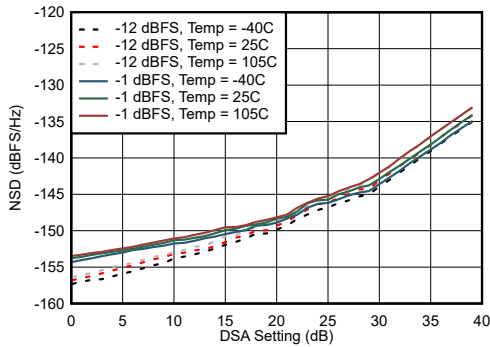

Figure 7-263. Dual Tone Spectrum at 30 MHz and -60d BFS (0 - 100 MHz)



measured at +50 MHz offset

Figure 7-264. Noise Spectral Density vs Digital Amplitude at 30 MHz



measured at +50 MHz offset

Figure 7-265. Noise Spectral Density vs DSA Setting at 30 MHz

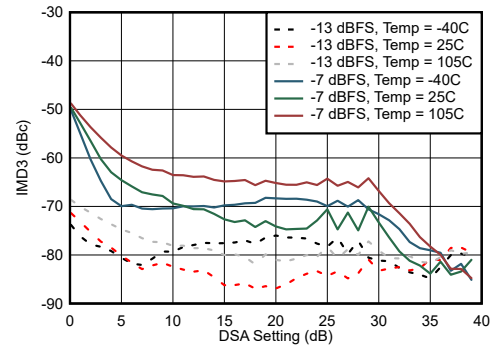

Figure 7-266. IMD3 vs DSA Setting at 30 MHz

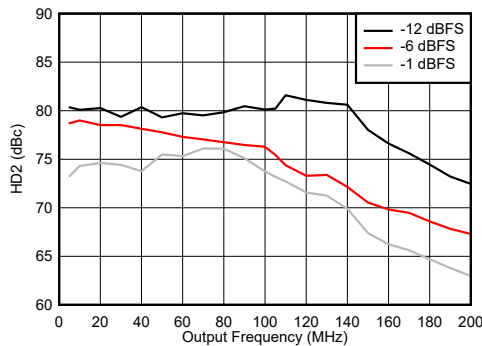

Figure 7-267. HD2 vs Frequency 0 - 200 MHz

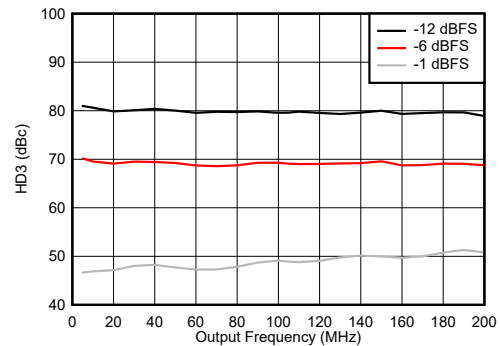
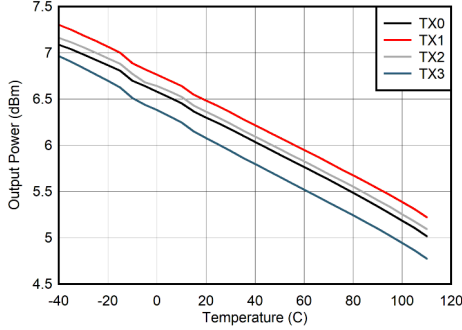

Figure 7-268. HD3 vs Frequency 0 - 200 MHz

7.12.8 TX Typical Characteristics at 30 MHz and 400 MHz (continued)

Typical values at $T_A = +25^\circ\text{C}$ with nominal supplies. Default conditions: TX input data rate = 125 MSPS, $f_{\text{DAC}} = 6000$ MSPS (48x interpolation), interleave mode, 1st Nyquist zone output, PLL clock mode with $f_{\text{REF}} = 500$ MHz. Additional default conditions for all plots, $A_{\text{OUT}} = -1$ dBFS, DSA = 0 dB, $\text{Sin}(x)/x$ enabled, DSA calibrated.



including PCB and cable losses

Figure 7-269. TX Output Fullscale vs Temperature at 400 MHz

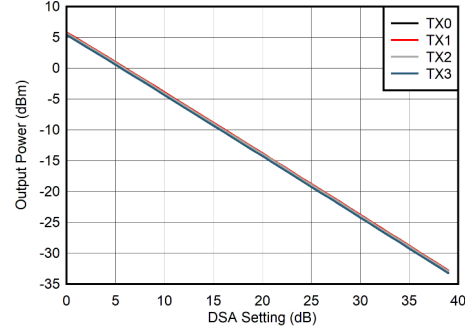

including PCB and cable losses

Figure 7-270. TX Output Fullscale vs DSA Setting at 400 MHz

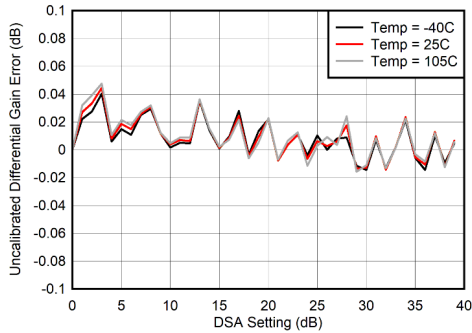

Differential Gain Error = $P_{\text{OUT}}(\text{DSA Setting} - 1) - P_{\text{OUT}}(\text{DSA Setting}) + 1$

Figure 7-271. Uncalibrated TX Differential Gain Error (DNL) at 400 MHz

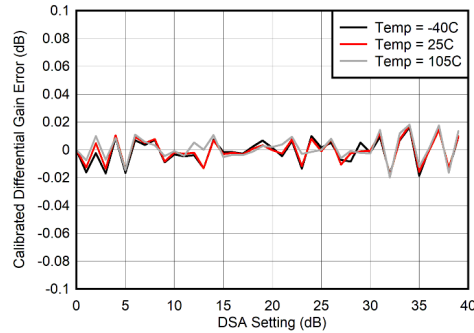

Differential Gain Error = $P_{\text{OUT}}(\text{DSA Setting} - 1) - P_{\text{OUT}}(\text{DSA Setting}) + 1$

Figure 7-272. Calibrated TX Differential Gain Error (DNL) at 400 MHz

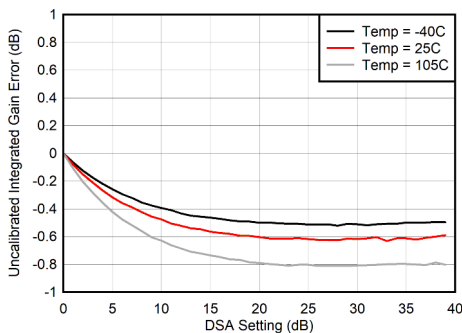

Integrated Gain Error = $P_{\text{OUT}}(\text{DSA Setting}) - P_{\text{OUT}}(\text{DSASetting} = 0) + (\text{DSA Setting})$

Figure 7-273. Uncalibrated TX Integrated Gain Error (INL) at 400 MHz

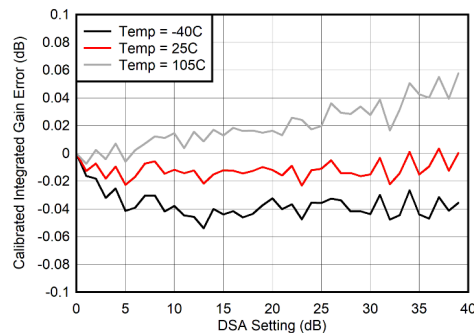

Integrated Gain Error = $P_{\text{OUT}}(\text{DSA Setting}) - P_{\text{OUT}}(\text{DSASetting} = 0) + (\text{DSA Setting})$

Figure 7-274. Calibrated TX Integrated Gain Error (INL) at 400 MHz

7.12.8 TX Typical Characteristics at 30 MHz and 400 MHz (continued)

Typical values at $T_A = +25^\circ\text{C}$ with nominal supplies. Default conditions: TX input data rate = 125 MSPS, $f_{\text{DAC}} = 6000$ MSPS (48x interpolation), interleave mode, 1st Nyquist zone output, PLL clock mode with $f_{\text{REF}} = 500$ MHz. Additional default conditions for all plots, $A_{\text{OUT}} = -1$ dBFS, DSA = 0 dB, Sin(x)/x enabled, DSA calibrated.

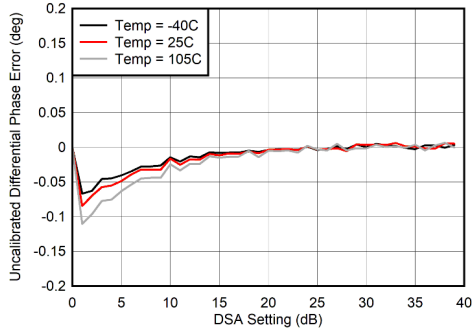

$$\text{Differential Phase Error} = \text{Phase}_{\text{OUT}}(\text{DSA Setting} - 1) - \text{Phase}_{\text{OUT}}(\text{DSA Setting})$$

Figure 7-275. Uncalibrated TX Differential Phase Error (DNL) at 400 MHz

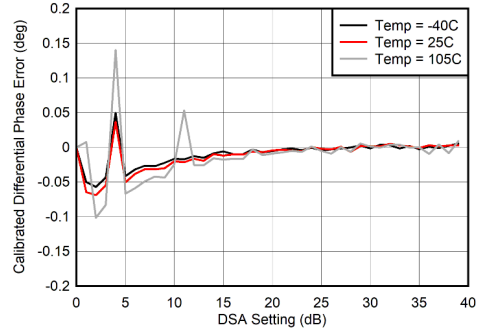

$$\text{Differential Phase Error} = \text{Phase}_{\text{OUT}}(\text{DSA Setting} - 1) - \text{Phase}_{\text{OUT}}(\text{DSA Setting})$$

Figure 7-276. Calibrated TX Differential Phase Error (DNL) at 400 MHz

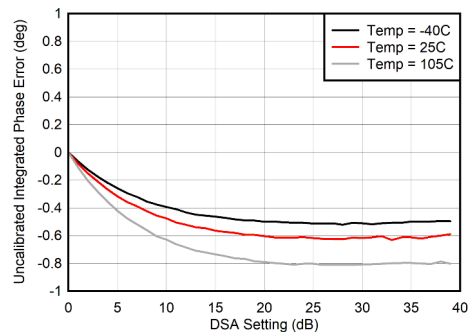

$$\text{Integrated Phase Error} = \text{Phase}_{\text{OUT}}(\text{DSA Setting}) - \text{Phase}_{\text{OUT}}(\text{DSASetting} = 0)$$

Figure 7-277. Uncalibrated TX Integrated Phase Error (INL) at 400 MHz

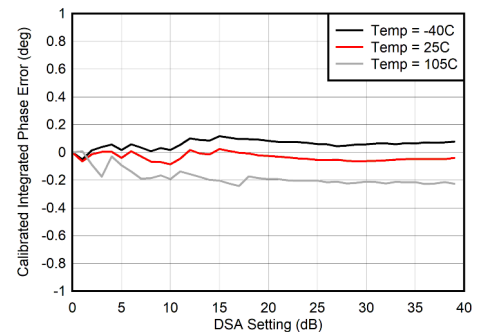

$$\text{Integrated Phase Error} = \text{Phase}_{\text{OUT}}(\text{DSA Setting}) - \text{Phase}_{\text{OUT}}(\text{DSASetting} = 0)$$

Figure 7-278. Calibrated TX Integrated Phase Error (INL) at 400 MHz

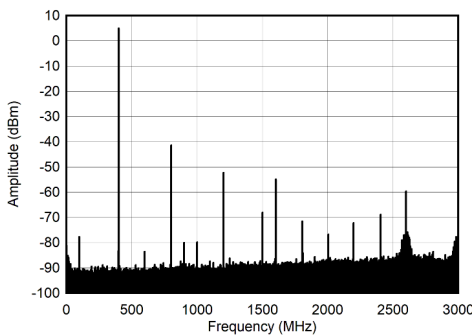

Figure 7-279. Single Tone Spectrum at 400 MHz and -1 dBFS (Nyquist)

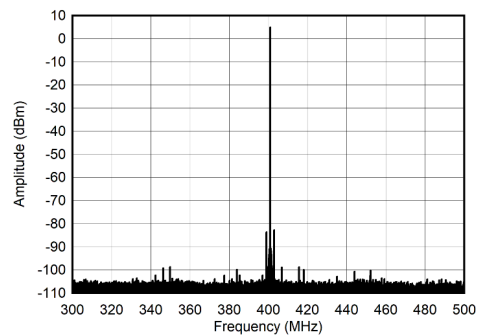

Figure 7-280. Single Tone Spectrum at 400 MHz and -1 dBFS (±100MHz)

7.12.8 TX Typical Characteristics at 30 MHz and 400 MHz (continued)

Typical values at $T_A = +25^\circ\text{C}$ with nominal supplies. Default conditions: TX input data rate = 125 MSPS, $f_{\text{DAC}} = 6000$ MSPS (48x interpolation), interleave mode, 1st Nyquist zone output, PLL clock mode with $f_{\text{REF}} = 500$ MHz. Additional default conditions for all plots, $A_{\text{OUT}} = -1$ dBFS, DSA = 0 dB, Sin(x)/x enabled, DSA calibrated.

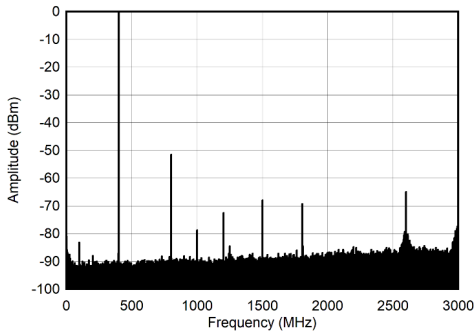

Figure 7-281. Single Tone Spectrum at 400 MHz and -6 dBFS (Nyquist)

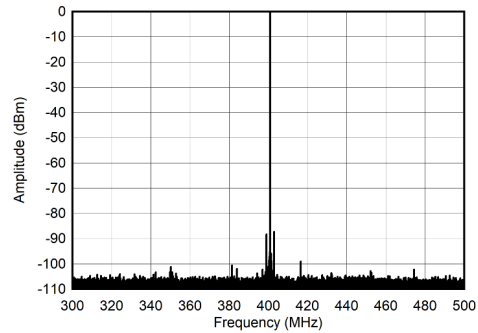

Figure 7-282. Single Tone Spectrum at 400 MHz and -6 dBFS (±100MHz)

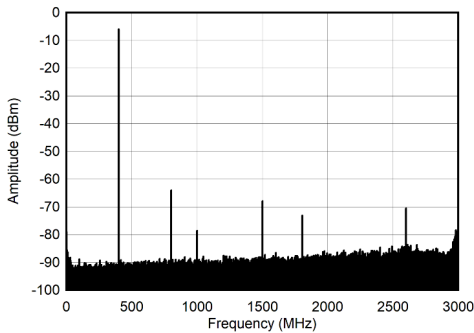

Figure 7-283. Single Tone Spectrum at 400 MHz and -12 dBFS (Nyquist)

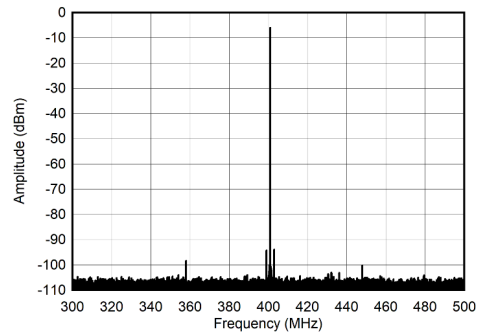

Figure 7-284. Single Tone Spectrum at 400 MHz and -12 dBFS (±100MHz)

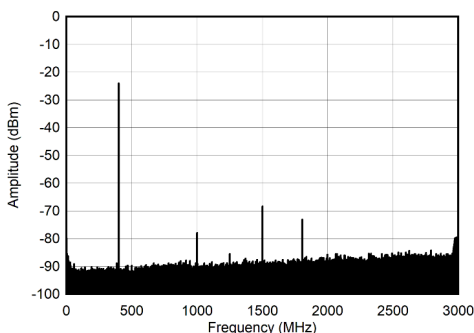

Figure 7-285. Single Tone Spectrum at 400 MHz and -30 dBFS (Nyquist)

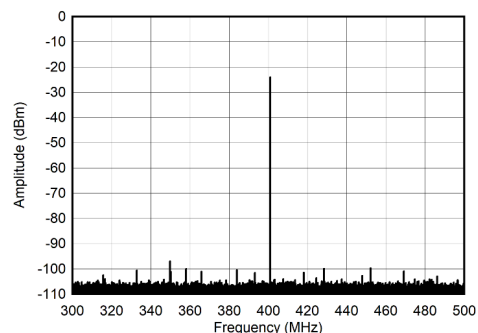

Figure 7-286. Single Tone Spectrum at 400 MHz and -30 dBFS (±100MHz)

7.12.8 TX Typical Characteristics at 30 MHz and 400 MHz (continued)

Typical values at $T_A = +25^\circ\text{C}$ with nominal supplies. Default conditions: TX input data rate = 125 MSPS, $f_{\text{DAC}} = 6000$ MSPS (48x interpolation), interleave mode, 1st Nyquist zone output, PLL clock mode with $f_{\text{REF}} = 500$ MHz. Additional default conditions for all plots, $A_{\text{OUT}} = -1$ dBFS, DSA = 0 dB, Sin(x)/x enabled, DSA calibrated.

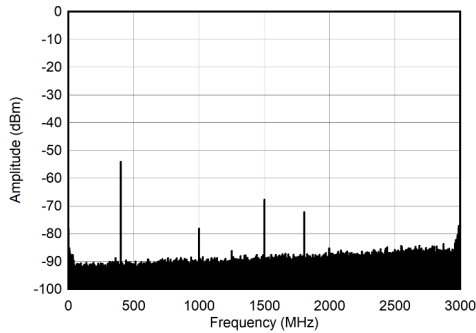

Figure 7-287. Single Tone Spectrum at 400 MHz and -60 dBFS (Nyquist)

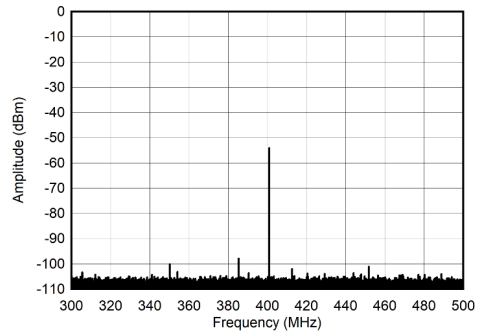
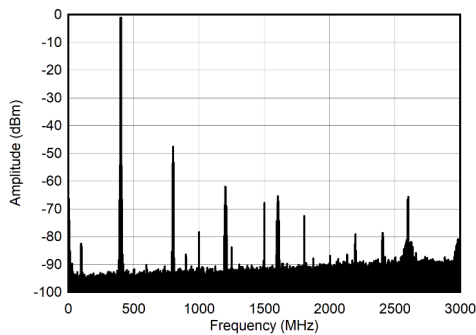
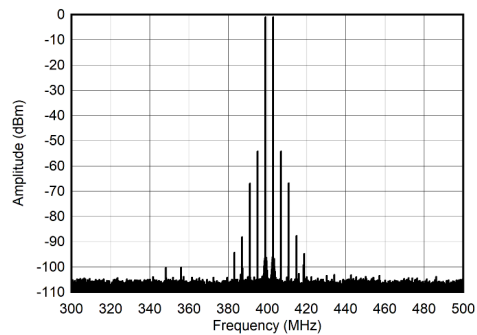

Figure 7-288. Single Tone Spectrum at 400 MHz and -60 dBFS (±100MHz)



Tone Spacing = 4 MHz

Figure 7-289. Dual Tone Spectrum at 400 MHz and -7 dBFS (Nyquist)



Tone Spacing = 4 MHz

Figure 7-290. Dual Tone Spectrum at 400 MHz and -7 dBFS (±100MHz)

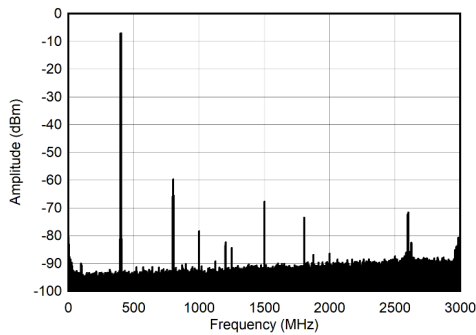

Tone Spacing = 4 MHz

Figure 7-291. Dual Tone Spectrum at 400 MHz and -13 dBFS (Nyquist)

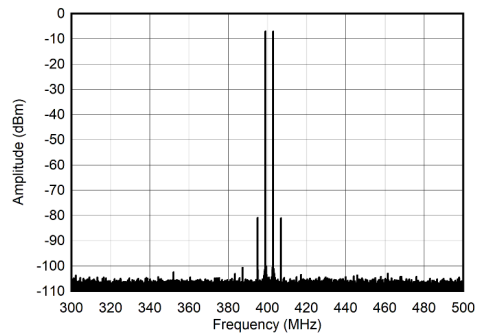

Tone Spacing = 4 MHz

Figure 7-292. Dual Tone Spectrum at 400 MHz and -13 dBFS (±100 MHz)

7.12.8 TX Typical Characteristics at 30 MHz and 400 MHz (continued)

Typical values at $T_A = +25^\circ\text{C}$ with nominal supplies. Default conditions: TX input data rate = 125 MSPS, $f_{DAC} = 6000$ MSPS (48x interpolation), interleave mode, 1st Nyquist zone output, PLL clock mode with $f_{REF} = 500$ MHz. Additional default conditions for all plots, $A_{OUT} = -1$ dBFS, DSA = 0 dB, Sin(x)/x enabled, DSA calibrated.

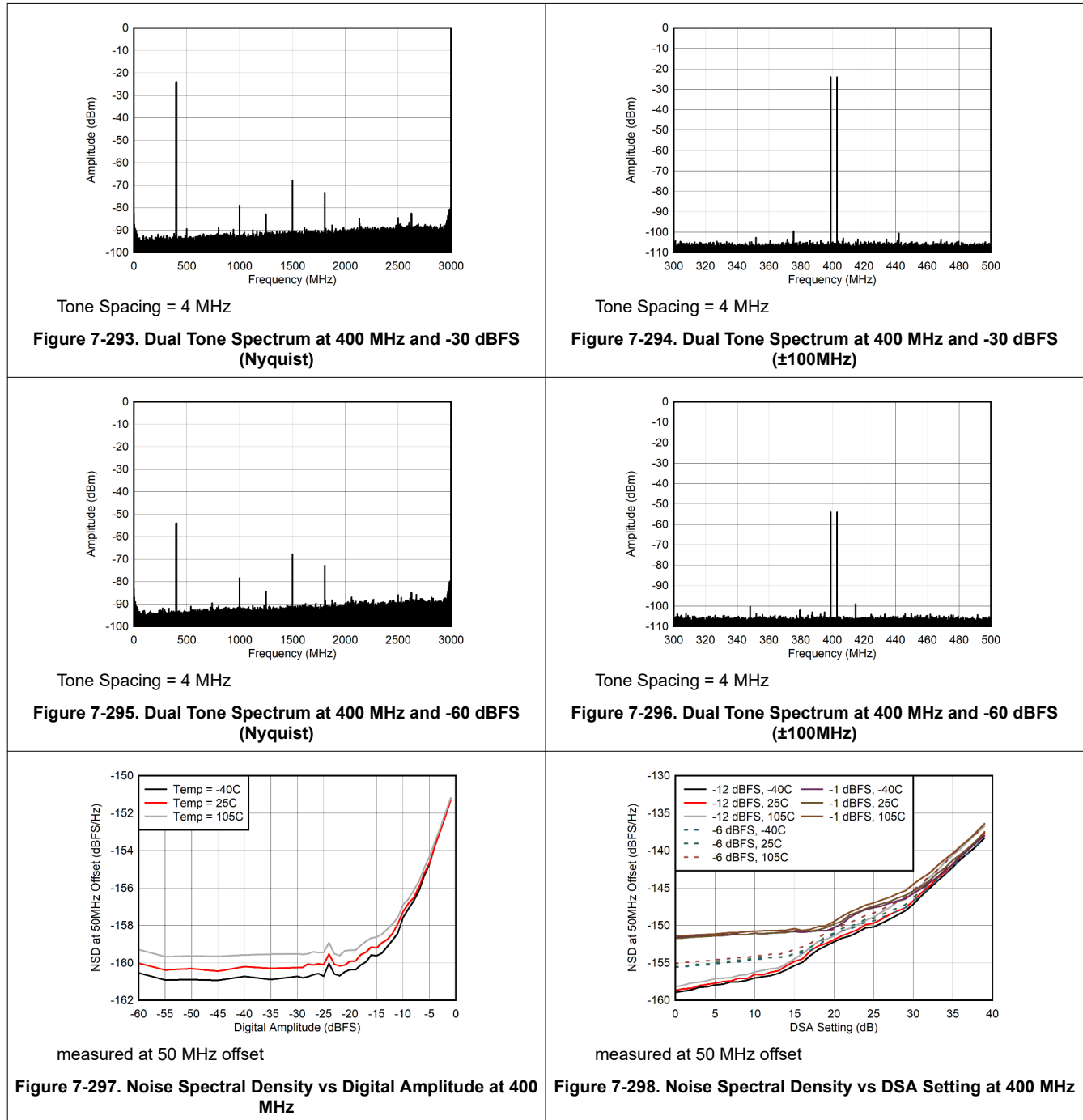

7.12.8 TX Typical Characteristics at 30 MHz and 400 MHz (continued)

Typical values at $T_A = +25^\circ\text{C}$ with nominal supplies. Default conditions: TX input data rate = 125 MSPS, $f_{\text{DAC}} = 6000$ MSPS (48x interpolation), interleave mode, 1st Nyquist zone output, PLL clock mode with $f_{\text{REF}} = 500$ MHz. Additional default conditions for all plots, $A_{\text{OUT}} = -1$ dBFS, DSA = 0 dB, $\text{Sin}(x)/x$ enabled, DSA calibrated.

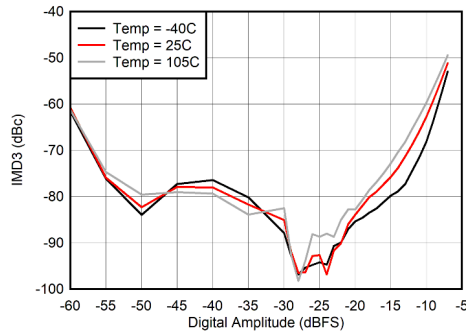

Tone Spacing = 4 MHz

Figure 7-299. IMD3 vs Digital Amplitude at 400 MHz

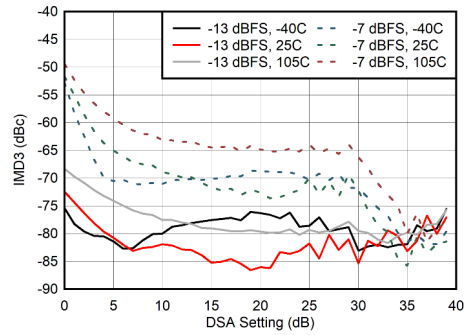

Tone Spacing = 4 MHz

Figure 7-300. IMD3 vs DSA Setting at 400 MHz

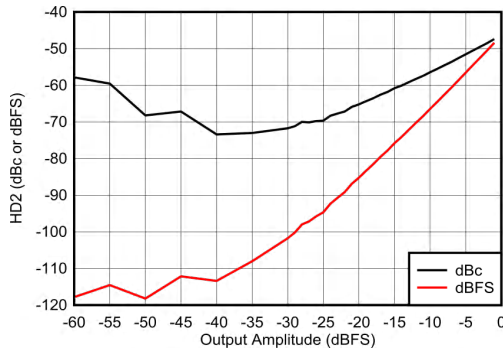

Figure 7-301. HD2 vs Amplitude at 400 MHz

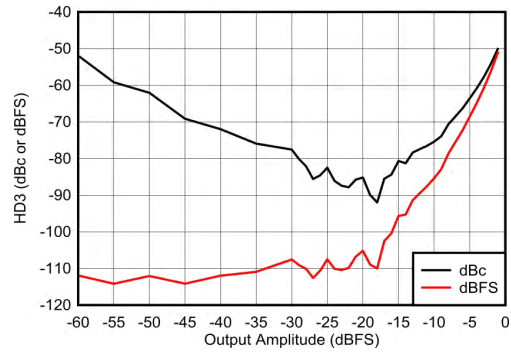
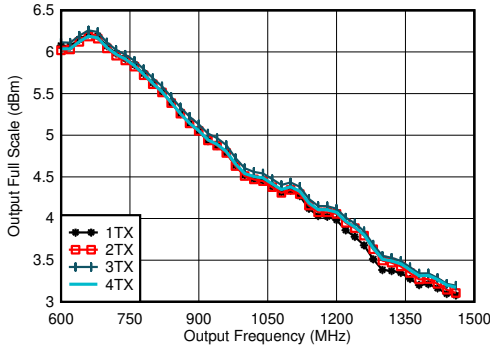

Figure 7-302. HD3 vs Amplitude at 400 MHz

7.12.9 TX Typical Characteristics at 800 MHz

Typical values at $T_A = +25^\circ\text{C}$ with nominal supplies. Unless otherwise noted, TX input data rate = 491.52 MSPS, $f_{\text{DAC}} = 11796.48$ MSPS, interleave mode, $A_{\text{OUT}} = -1$ dBFS, 1st Nyquist zone output, Internal PLL, $f_{\text{REF}} = 491.52$ MSPS, 24x Interpolation, DSA = 0 dB, Sin(x)/x enabled, DSA calibrated.



Including PCB and cable losses, $A_{\text{out}} = -0.5$ dBFS, DSA = 0, 0.8 GHz matching

Figure 7-303. TX Full Scale vs RF Frequency and Channel at 5898.24 MSPS, Straight Mode

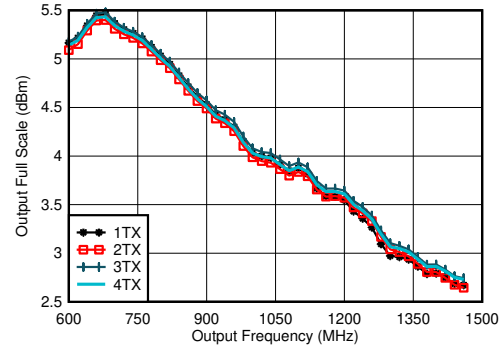

Including PCB and cable losses, $A_{\text{out}} = -0.5$ dBFS, DSA = 0, 0.8 GHz matching

Figure 7-304. TX Full Scale vs RF Frequency and Channel at 8847.36 MSPS, Straight Mode

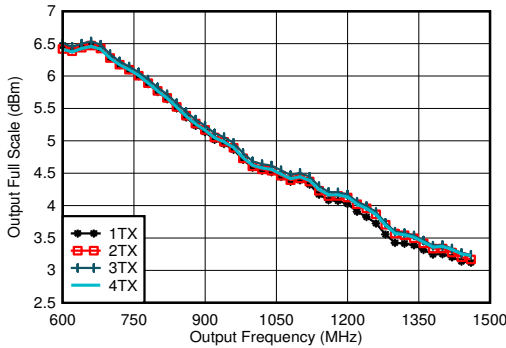

Including PCB and cable losses, $A_{\text{out}} = -0.5$ dBFS, DSA = 0, 0.8 GHz matching

Figure 7-305. TX Full Scale vs RF Frequency and Channel at 5898.24 MSPS, Interleave Mode

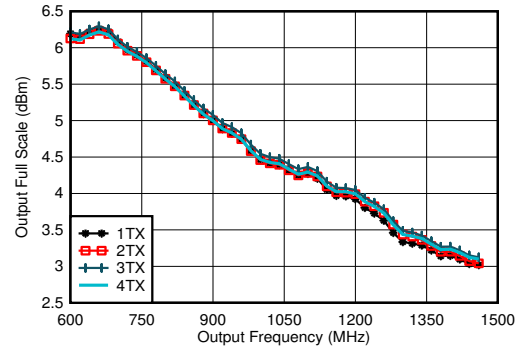

Including PCB and cable losses, $A_{\text{out}} = -0.5$ dBFS, DSA = 0, 0.8 GHz matching

Figure 7-306. TX Full Scale vs RF Frequency and Channel at 8847.36 MSPS, Interleave Mode

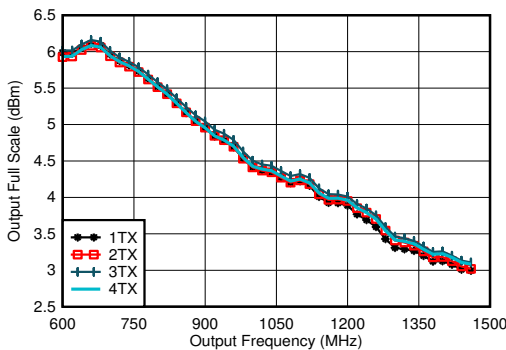

Including PCB and cable losses, $A_{\text{out}} = -0.5$ dBFS, DSA = 0, 0.8 GHz matching

Figure 7-307. TX Full Scale vs RF Frequency and Channel at 11796.48 MSPS, Interleave Mode

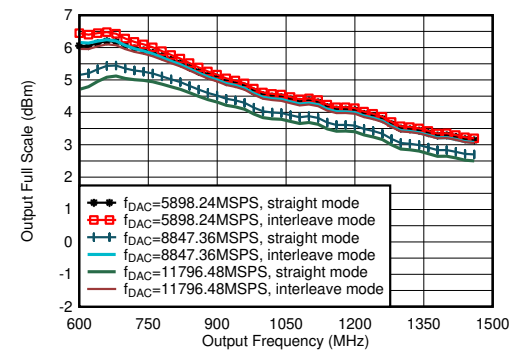

Including PCB and cable losses, $A_{\text{out}} = -0.5$ dBFS, DSA = 0, 0.8 GHz matching

Figure 7-308. TX Output Fullscale vs Output Frequency

7.12.9 TX Typical Characteristics at 800 MHz (continued)

Typical values at $T_A = +25^\circ\text{C}$ with nominal supplies. Unless otherwise noted, TX input data rate = 491.52 MSPS, $f_{DAC} = 11796.48$ MSPS, interleaved mode, $A_{OUT} = -1$ dBFS, 1st Nyquist zone output, Internal PLL, $f_{REF} = 491.52$ MSPS, 24x Interpolation, DSA = 0 dB, $\text{Sin}(x)/x$ enabled, DSA calibrated.

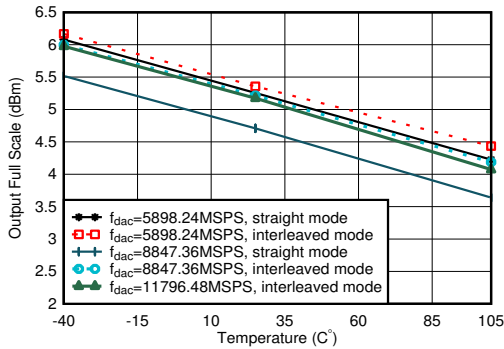

including PCB and cable losses, $A_{out} = -0.5$ dBFS, DSA = 0, 0.8 GHz matching

Figure 7-309. TX Output Fullscale vs Temperature

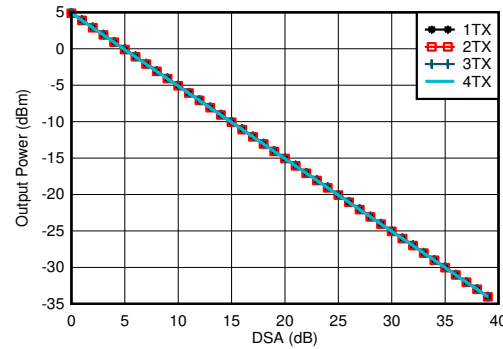

$f_{DAC} = 11796.48$ MSPS, interleaved mode, $A_{out} = -0.5$ dBFS, matching 0.8 GHz

Figure 7-310. TX Output Power vs DSA Setting and Channel at 0.85 GHz

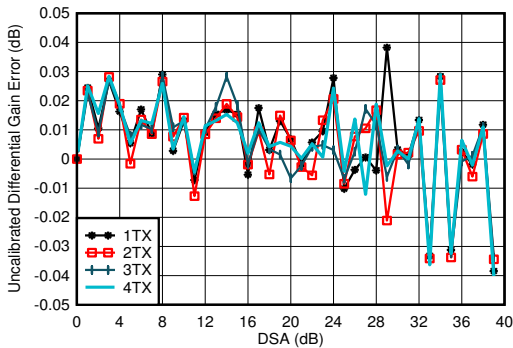

$f_{DAC} = 5898.24$ MSPS, interleaved mode, matching at 0.8 GHz
Differential Gain Error = $P_{OUT}(\text{DSA Setting} - 1) - P_{OUT}(\text{DSA Setting}) + 1$

Figure 7-311. TX Uncalibrated Differential Gain Error vs DSA Setting and Channel at 0.85 GHz

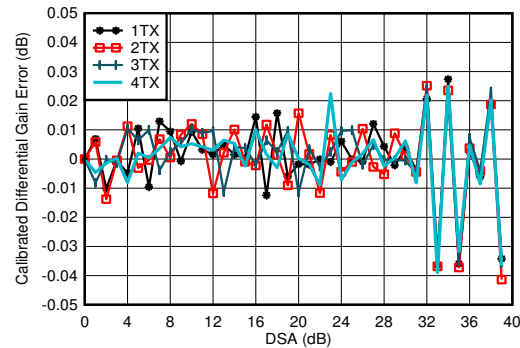

$f_{DAC} = 5898.24$ MSPS, interleaved mode, matching at 0.8 GHz
Differential Gain Error = $P_{OUT}(\text{DSA Setting} - 1) - P_{OUT}(\text{DSA Setting}) + 1$

Figure 7-312. TX Calibrated Differential Gain Error vs DSA Setting and Channel at 0.85 GHz

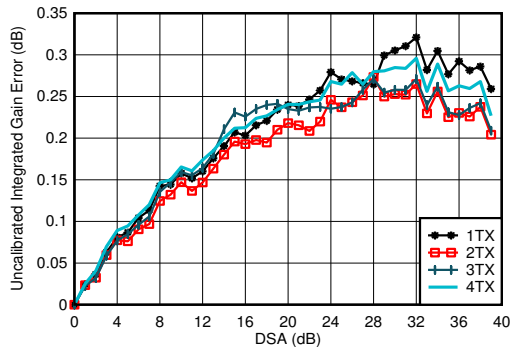

$f_{DAC} = 5898.24$ MSPS, interleaved mode, matching at 0.8 GHz
Integrated Gain Error = $P_{OUT}(\text{DSA Setting}) - P_{OUT}(\text{DSA Setting} = 0) + \text{DSA Settings}$

Figure 7-313. TX Uncalibrated Integrated Gain Error vs DSA Setting and Channel at 0.85 GHz

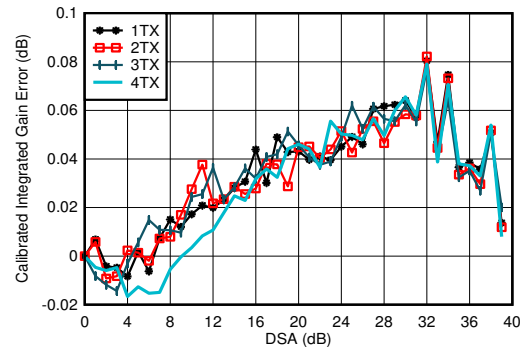

$f_{DAC} = 5898.24$ MSPS, interleaved mode, matching at 0.8 GHz
Integrated Gain Error = $P_{OUT}(\text{DSA Setting}) - P_{OUT}(\text{DSA Setting} = 0) + \text{DSA Setting}$

Figure 7-314. TX Calibrated Integrated Gain Error vs DSA Setting and Channel at 0.85 GHz

7.12.9 TX Typical Characteristics at 800 MHz (continued)

Typical values at $T_A = +25^\circ\text{C}$ with nominal supplies. Unless otherwise noted, TX input data rate = 491.52 MSPS, $f_{\text{DAC}} = 11796.48$ MSPS, interleave mode, $A_{\text{OUT}} = -1$ dBFS, 1st Nyquist zone output, Internal PLL, $f_{\text{REF}} = 491.52$ MSPS, 24x Interpolation, DSA = 0 dB, Sin(x)/x enabled, DSA calibrated.

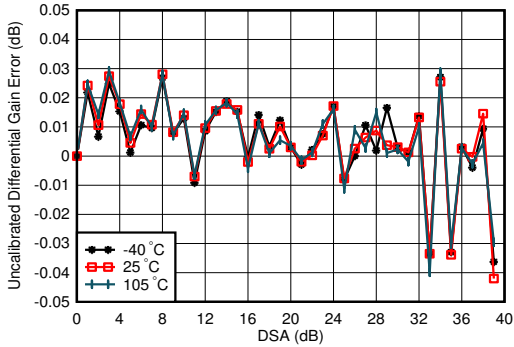

$f_{\text{DAC}} = 5898.24$ MSPS, interleave mode, matching at 0.8 GHz
 Differential Gain Error = $P_{\text{OUT}}(\text{DSA Setting} - 1) - P_{\text{OUT}}(\text{DSA Setting}) + 1$

Figure 7-315. TX Uncalibrated Differential Gain Error vs DSA Setting and Temperature at 0.85 GHz

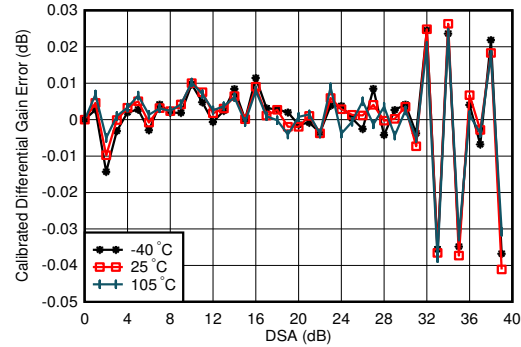

$f_{\text{DAC}} = 5898.24$ MSPS, interleave mode, matching at 0.8 GHz
 Differential Gain Error = $P_{\text{OUT}}(\text{DSA Setting} - 1) - P_{\text{OUT}}(\text{DSA Setting}) + 1$

Figure 7-316. TX Calibrated Differential Gain Error vs DSA Setting and Temperature at 0.85 GHz

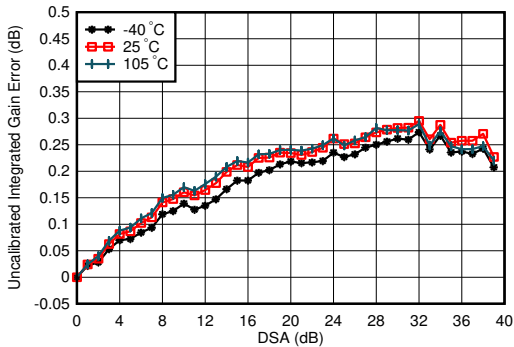

$f_{\text{DAC}} = 5898.24$ MSPS, interleave mode, matching at 0.8 GHz
 Integrated Gain Error = $P_{\text{OUT}}(\text{DSA Setting}) - P_{\text{OUT}}(\text{DSA Setting} = 0) + \text{DSA Setting}$

Figure 7-317. TX Uncalibrated Integrated Gain Error vs DSA Setting and Temperature at 0.85 GHz

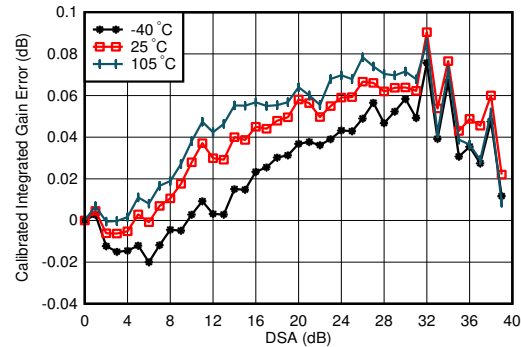

$f_{\text{DAC}} = 5898.24$ MSPS, interleave mode, matching at 0.8 GHz
 Integrated Gain Error = $P_{\text{OUT}}(\text{DSA Setting}) - P_{\text{OUT}}(\text{DSA Setting} = 0) + \text{DSA Setting}$

Figure 7-318. TX Calibrated Integrated Gain Error vs DSA Setting and Temperature at 0.85 GHz

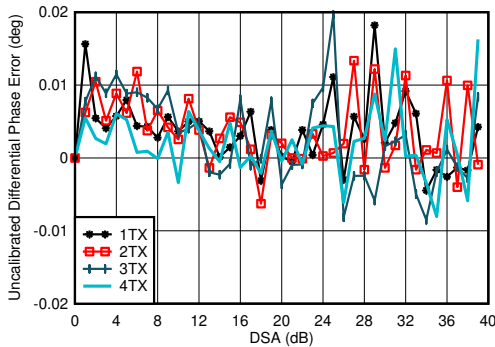

$f_{\text{DAC}} = 5898.24$ MSPS, interleave mode, matching at 0.8 GHz
 Differential Phase Error = $\text{Phase}_{\text{OUT}}(\text{DSA Setting} - 1) - \text{Phase}_{\text{OUT}}(\text{DSA Setting})$

Figure 7-319. TX Uncalibrated Differential Phase Error vs DSA Setting and Channel at 0.85 GHz

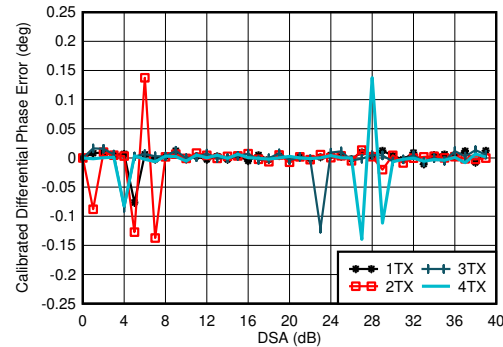

$f_{\text{DAC}} = 5898.24$ MSPS, interleave mode, matching at 0.8 GHz
 Differential Phase Error = $\text{Phase}_{\text{OUT}}(\text{DSA Setting} - 1) - \text{Phase}_{\text{OUT}}(\text{DSA Setting})$
 Phase DNL spike may occur at any DSA setting.

Figure 7-320. TX Calibrated Differential Phase Error vs DSA Setting and Channel at 0.85 GHz

7.12.9 TX Typical Characteristics at 800 MHz (continued)

Typical values at $T_A = +25^\circ\text{C}$ with nominal supplies. Unless otherwise noted, TX input data rate = 491.52 MSPS, $f_{\text{DAC}} = 11796.48$ MSPS, interleave mode, $A_{\text{OUT}} = -1$ dBFS, 1st Nyquist zone output, Internal PLL, $f_{\text{REF}} = 491.52$ MSPS, 24x Interpolation, DSA = 0 dB, Sin(x)/x enabled, DSA calibrated.

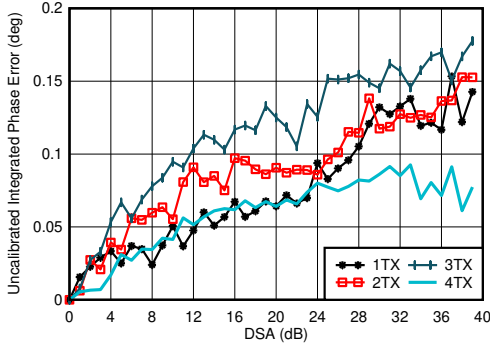

$f_{\text{DAC}} = 5898.24$ MSPS, interleave mode, matching at 0.8 GHz
Integrated Phase Error = $\text{Phase}_{\text{OUT}}(\text{DSA Setting}) - \text{Phase}_{\text{OUT}}(\text{DSA Setting} = 0)$

Figure 7-321. TX Uncalibrated Integrated Phase Error vs DSA Setting and Channel at 0.85 GHz

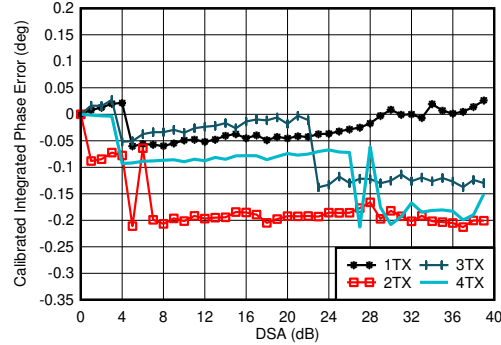

$f_{\text{DAC}} = 5898.24$ MSPS, interleave mode, matching at 0.8 GHz
Integrated Phase Error = $\text{Phase}_{\text{OUT}}(\text{DSA Setting}) - \text{Phase}_{\text{OUT}}(\text{DSA Setting} = 0)$

Figure 7-322. TX Calibrated Integrated Phase Error vs DSA Setting and Channel at 0.85 GHz

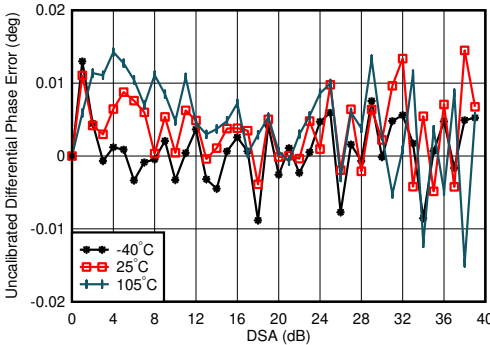

$f_{\text{DAC}} = 5898.24$ MSPS, interleave mode, matching at 0.8 GHz
Differential Phase Error = $\text{Phase}_{\text{OUT}}(\text{DSA Setting} - 1) - \text{Phase}_{\text{OUT}}(\text{DSA Setting}) + 1$

Figure 7-323. TX Uncalibrated Differential Phase Error vs DSA Setting and Temperature at 0.85 GHz

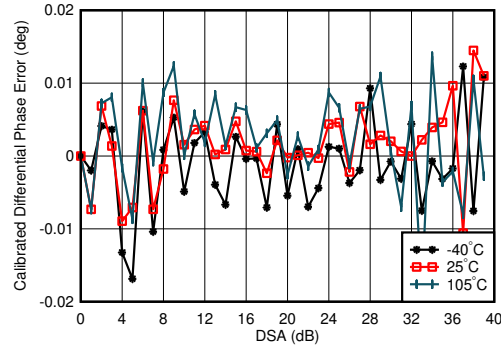

$f_{\text{DAC}} = 5898.24$ MSPS, interleave mode, matching at 0.8 GHz, channel with the median variation over DSA setting at 25°C
Differential Phase Error = $\text{Phase}_{\text{OUT}}(\text{DSA Setting} - 1) - \text{Phase}_{\text{OUT}}(\text{DSA Setting}) + 1$

Figure 7-324. TX Calibrated Differential Phase Error vs DSA Setting and Temperature at 0.85 GHz

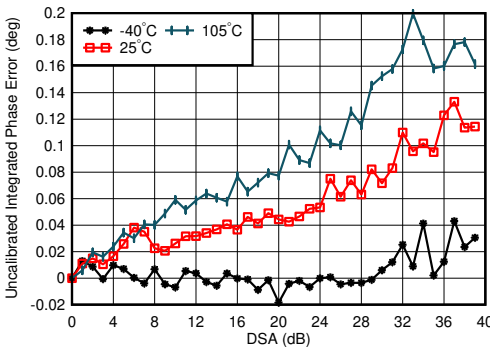

$f_{\text{DAC}} = 5898.24$ MSPS, interleave mode, matching at 0.8 GHz
Integrated Phase Error = $\text{Phase}_{\text{OUT}}(\text{DSA Setting}) - \text{Phase}_{\text{OUT}}(\text{DSA Setting} = 0)$

Figure 7-325. TX Uncalibrated Integrated Phase Error vs DSA Setting and Temperature at 0.85 GHz

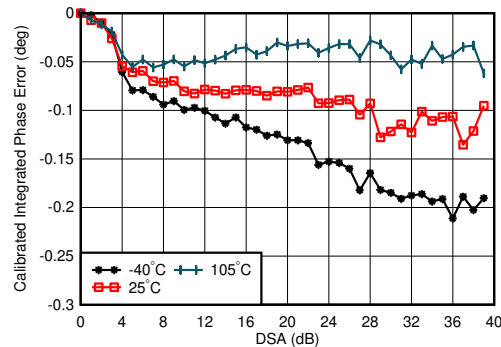

$f_{\text{DAC}} = 5898.24$ MSPS, interleave mode, matching at 0.8 GHz
Integrated Phase Error = $\text{Phase}_{\text{OUT}}(\text{DSA Setting}) - \text{Phase}_{\text{OUT}}(\text{DSA Setting} = 0)$

Figure 7-326. TX Calibrated Integrated Phase Error vs DSA Setting and Temperature at 0.85 GHz

7.12.9 TX Typical Characteristics at 800 MHz (continued)

Typical values at $T_A = +25^\circ\text{C}$ with nominal supplies. Unless otherwise noted, TX input data rate = 491.52 MSPS, $f_{\text{DAC}} = 11796.48$ MSPS, interleave mode, $A_{\text{OUT}} = -1$ dBFS, 1st Nyquist zone output, Internal PLL, $f_{\text{REF}} = 491.52$ MSPS, 24x Interpolation, DSA = 0 dB, Sin(x)/x enabled, DSA calibrated.

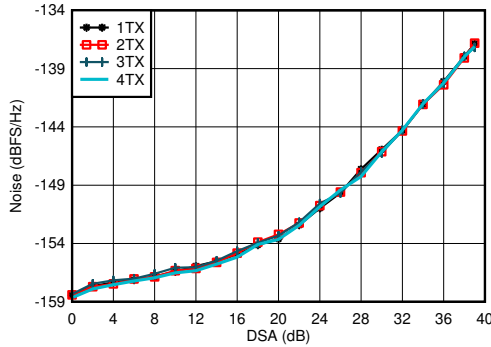

$f_{\text{DAC}} = 5898.24$ MSPS, interleave mode, matching at 0.8 GHz, $P_{\text{OUT}} = -13$ dBFS

Figure 7-327. TX Output Noise vs Channel and Attenuation at 0.85 GHz

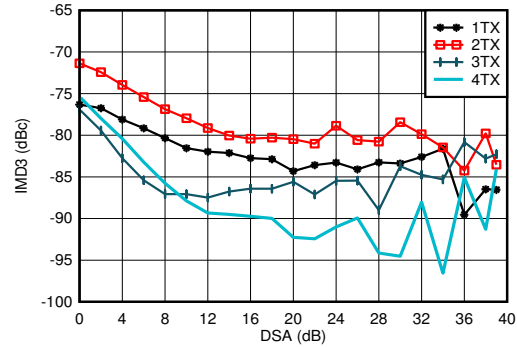

$f_{\text{DAC}} = 11796.48$ MSPS, interleave mode, $f_{\text{CENTER}} = 0.85$ GHz, matching at 0.8 GHz, -13 dBFS each tone

Figure 7-328. TX IMD3 vs DSA Setting at 0.85 GHz

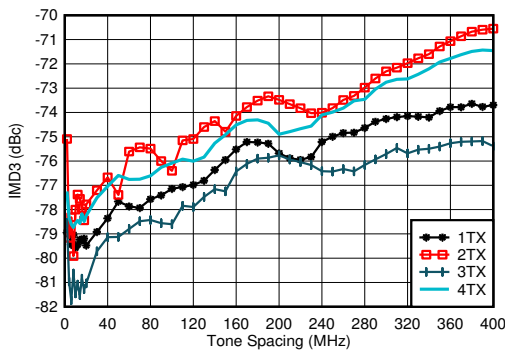

$f_{\text{DAC}} = 5898.24$ MSPS, straight mode, $f_{\text{CENTER}} = 0.85$ GHz, matching at 0.8 GHz, -13 dBFS each tone

Figure 7-329. TX IMD3 vs Tone Spacing and Channel at 0.85 GHz

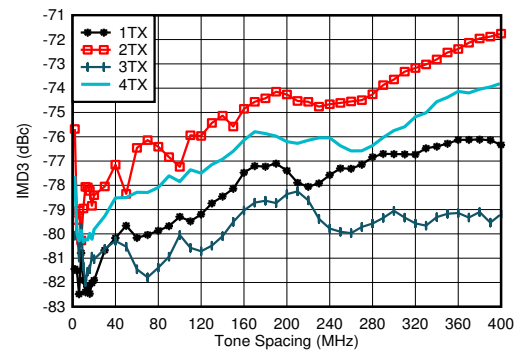

$f_{\text{DAC}} = 8847.36$ MSPS, straight mode, $f_{\text{CENTER}} = 0.85$ GHz, matching at 0.8 GHz, -13 dBFS each tone

Figure 7-330. TX IMD3 vs Tone Spacing and Channel at 0.85 GHz

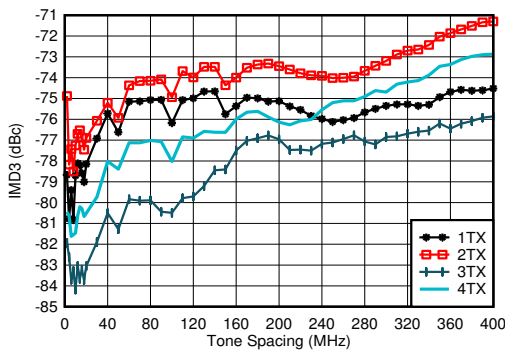

$f_{\text{DAC}} = 11796.48$ MSPS, interleave mode, $f_{\text{CENTER}} = 0.85$ GHz, matching at 0.8 GHz, -13 dBFS each tone

Figure 7-331. TX IMD3 vs Tone Spacing and Channel at 0.85 GHz

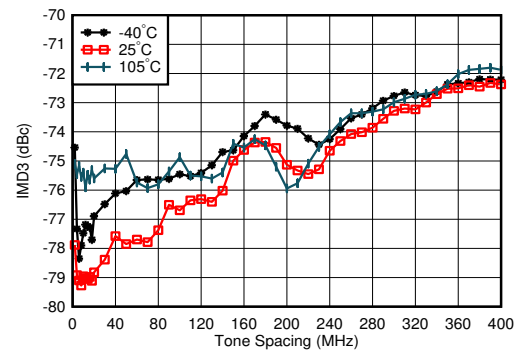

$f_{\text{DAC}} = 5898.24$ MSPS, straight mode, $f_{\text{CENTER}} = 0.85$ GHz, matching at 0.8 GHz, -13 dBFS each tone, worst channel

Figure 7-332. TX IMD3 vs Tone Spacing and Temperature at 0.85 GHz

7.12.9 TX Typical Characteristics at 800 MHz (continued)

Typical values at $T_A = +25^\circ\text{C}$ with nominal supplies. Unless otherwise noted, TX input data rate = 491.52 MSPS, $f_{\text{DAC}} = 11796.48$ MSPS, interleave mode, $A_{\text{OUT}} = -1$ dBFS, 1st Nyquist zone output, Internal PLL, $f_{\text{REF}} = 491.52$ MSPS, 24x Interpolation, DSA = 0 dB, Sin(x)/x enabled, DSA calibrated.

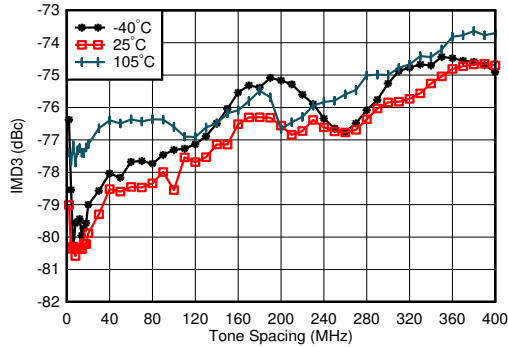

$f_{\text{DAC}} = 8847.36$ MSPS, straight mode, $f_{\text{CENTER}} = 0.85$ GHz, matching at 0.8 GHz, -13 dBFS each tone, worst channel

Figure 7-333. TX IMD3 vs Tone Spacing and Temperature at 0.85 GHz

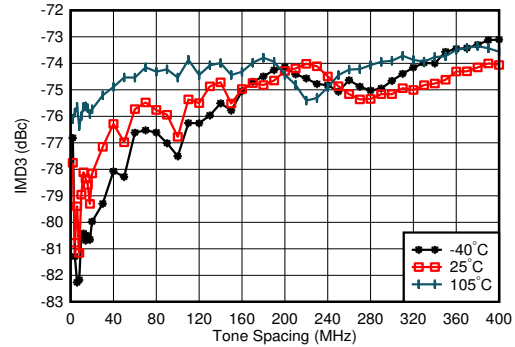

$f_{\text{DAC}} = 11796.48$ MSPS, straight mode, $f_{\text{CENTER}} = 0.85$ GHz, matching at 0.8 GHz, -13 dBFS each tone, worst channel

Figure 7-334. TX IMD3 vs Tone Spacing and Temperature at 0.85 GHz

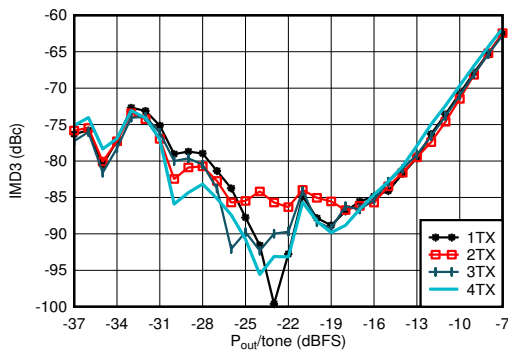

$f_{\text{DAC}} = 5898.24$ MSPS, straight mode, $f_{\text{CENTER}} = 0.85$ GHz, $f_{\text{SPACING}} = 20$ MHz, matching at 0.8 GHz

Figure 7-335. TX IMD3 vs Digital Level at 0.85 GHz

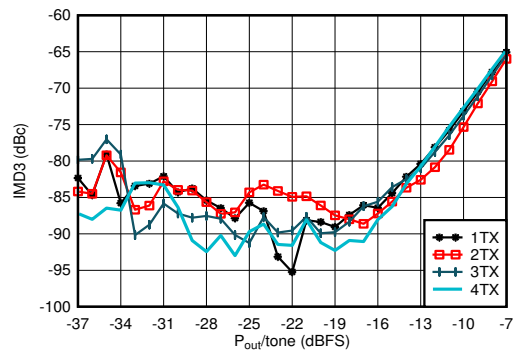

$f_{\text{DAC}} = 8847.36$ MSPS, straight mode, $f_{\text{CENTER}} = 0.85$ GHz, $f_{\text{SPACING}} = 20$ MHz, matching at 0.8 GHz

Figure 7-336. TX IMD3 vs Digital Level at 0.85 GHz

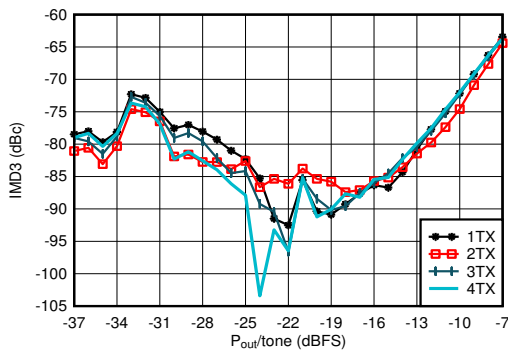

$f_{\text{DAC}} = 11796.48$ MSPS, interleave mode, $f_{\text{CENTER}} = 0.85$ GHz, $f_{\text{SPACING}} = 20$ MHz, matching at 0.8 GHz

Figure 7-337. TX IMD3 vs Digital Level at 0.85 GHz

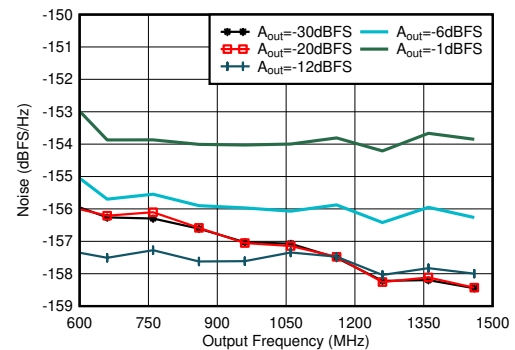

Matching at 0.8 GHz, Single tone, $f_{\text{DAC}} = 11.79648$ GSPS, interleave mode, 40-MHz offset, DSA = 0dB

Figure 7-338. TX Single Tone Output Noise vs Frequency and Amplitude at 0.85 GHz

7.12.9 TX Typical Characteristics at 800 MHz (continued)

Typical values at $T_A = +25^\circ\text{C}$ with nominal supplies. Unless otherwise noted, TX input data rate = 491.52 MSPS, $f_{\text{DAC}} = 11796.48$ MSPS, interleave mode, $A_{\text{OUT}} = -1$ dBFS, 1st Nyquist zone output, Internal PLL, $f_{\text{REF}} = 491.52$ MSPS, 24x Interpolation, DSA = 0 dB, Sin(x)/x enabled, DSA calibrated.

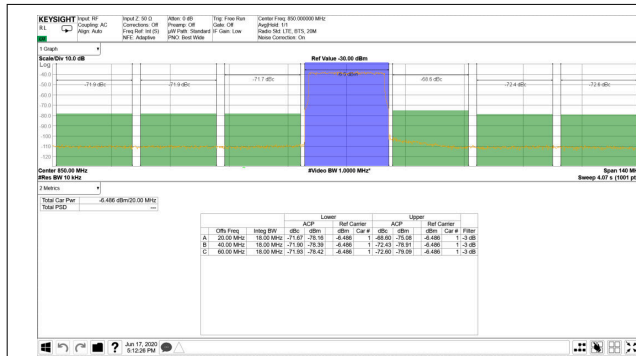

TM1.1, $P_{\text{OUT_RMS}} = -13$ dBFS

Figure 7-339. TX 20-MHz LTE Output Spectrum at 0.85 GHz

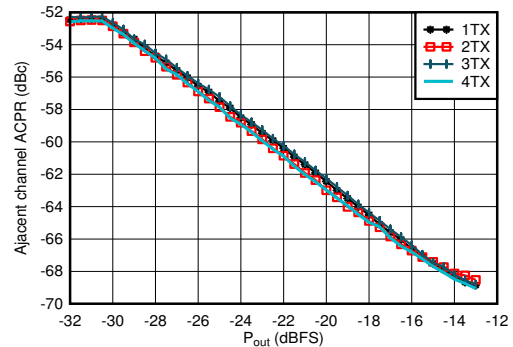

Matching at 0.8 GHz, single carrier 20-MHz BW TM1.1 LTE

Figure 7-340. TX 20-MHz LTE ACPR vs Digital Level at 0.85 GHz

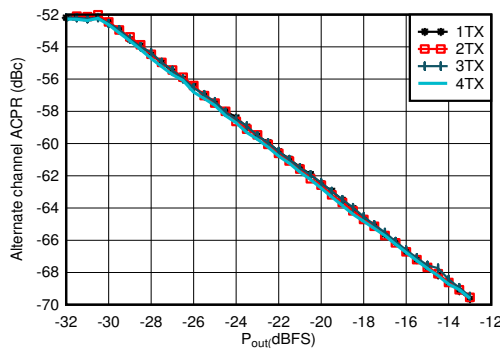

Matching at 0.8 GHz, single carrier 20-MHz BW TM1.1 LTE

Figure 7-341. TX 20-MHz LTE alt-ACPR vs Digital Level at 0.85 GHz

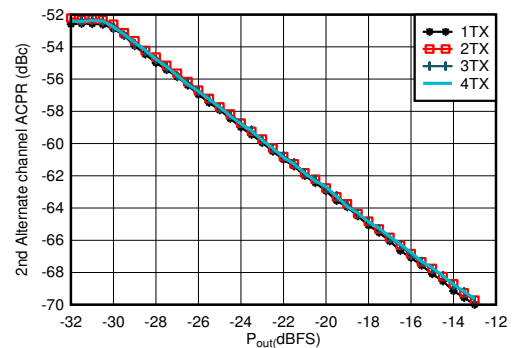

Matching at 0.8 GHz, single carrier 20-MHz BW TM1.1 LTE

Figure 7-342. TX 20-MHz LTE alt2-ACPR vs Digital Level at 0.85 GHz

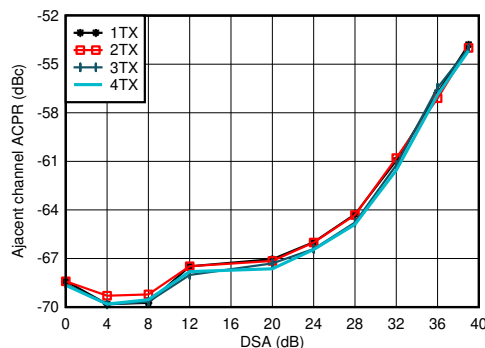

Matching at 0.8 GHz, single carrier 20-MHz BW TM1.1 LTE

Figure 7-343. TX 20-MHz LTE ACPR vs DSA at 0.85 GHz

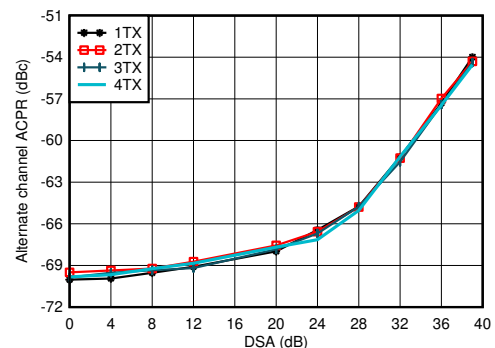

Matching at 0.8 GHz, single carrier 20-MHz BW TM1.1 LTE

Figure 7-344. TX 20-MHz LTE alt-ACPR vs DSA at 0.85 GHz

7.12.9 TX Typical Characteristics at 800 MHz (continued)

Typical values at $T_A = +25^\circ\text{C}$ with nominal supplies. Unless otherwise noted, TX input data rate = 491.52 MSPS, $f_{\text{DAC}} = 11796.48$ MSPS, interleave mode, $A_{\text{OUT}} = -1$ dBFS, 1st Nyquist zone output, Internal PLL, $f_{\text{REF}} = 491.52$ MSPS, 24x Interpolation, DSA = 0 dB, Sin(x)/x enabled, DSA calibrated.

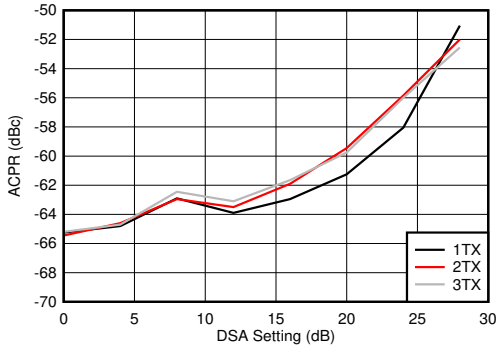

Matching at 0.8 GHz, single carrier 100-MHz BW TM1.1 NR

Figure 7-345. TX 100-MHz NR ACPR vs DSA at 0.85 GHz

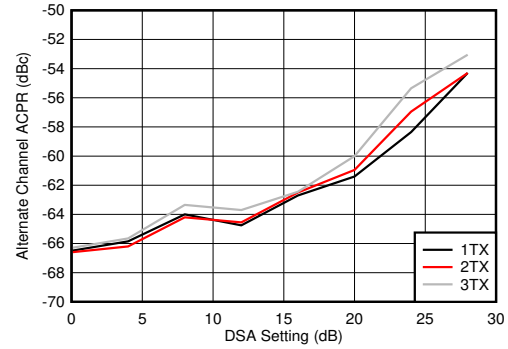

Matching at 0.8 GHz, single carrier 100-MHz BW TM1.1 NR

Figure 7-346. TX 100-MHz NR alt-ACPR vs DSA at 0.85 GHz

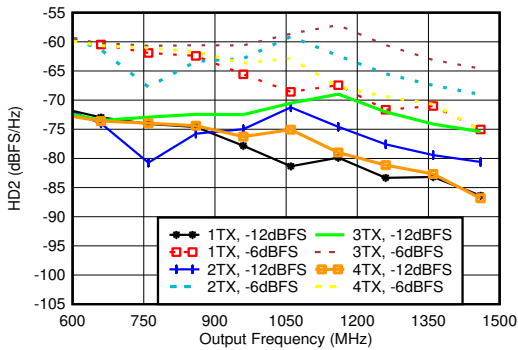

Matching at 0.8 GHz, $f_{\text{DAC}} = 5898.24$ GSPPS, straight mode

Figure 7-347. TX HD2 vs Digital Amplitude and Output Frequency at 0.85 GHz

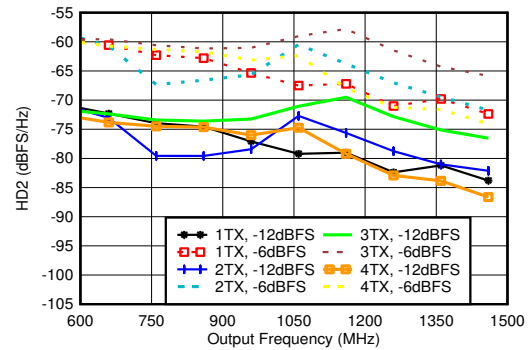

Matching at 0.8 GHz, $f_{\text{DAC}} = 8847.36$ GSPPS, straight mode

Figure 7-348. TX HD2 vs Digital Amplitude and Output Frequency at 0.85 GHz

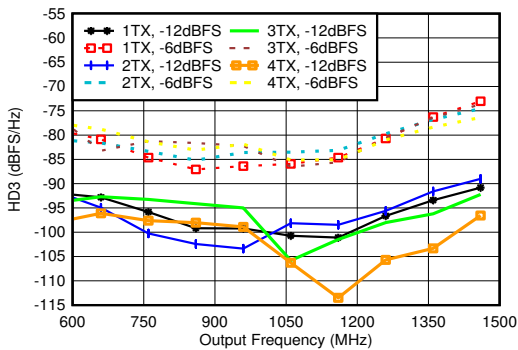

Matching at 0.8 GHz, $f_{\text{DAC}} = 5898.24$ MSPS, straight mode, normalized to output power at harmonic frequency

Figure 7-349. TX HD3 vs Digital Amplitude and Output Frequency at 0.85 GHz

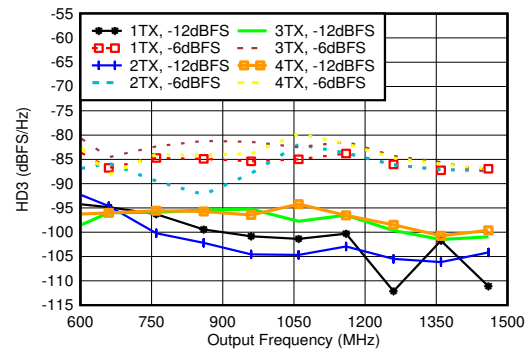

Matching at 0.8 GHz, $f_{\text{DAC}} = 8847.36$ MSPS, straight mode, normalized to output power at harmonic frequency

Figure 7-350. TX HD3 vs Digital Amplitude and Output Frequency at 0.85 GHz

7.12.9 TX Typical Characteristics at 800 MHz (continued)

Typical values at $T_A = +25^\circ\text{C}$ with nominal supplies. Unless otherwise noted, TX input data rate = 491.52 MSPS, $f_{\text{DAC}} = 11796.48$ MSPS, interleave mode, $A_{\text{OUT}} = -1$ dBFS, 1st Nyquist zone output, Internal PLL, $f_{\text{REF}} = 491.52$ MSPS, 24x Interpolation, DSA = 0 dB, Sin(x)/x enabled, DSA calibrated.

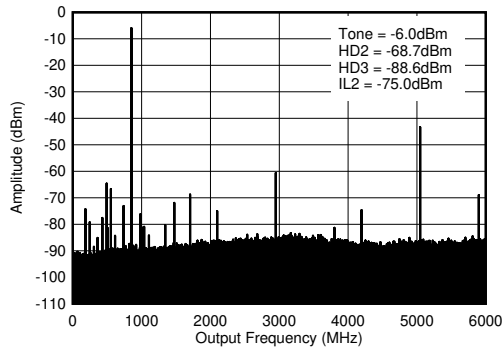

$f_{\text{DAC}} = 5898.24$ MSPS, interleave mode, 0.8 GHz matching, includes PCB and cable losses. $\text{ILn} = f_s/n \pm f_{\text{OUT}}$.

Figure 7-351. TX Single Tone (-12 dBFS) Output Spectrum at 0.85 GHz ($0-f_{\text{DAC}}$)

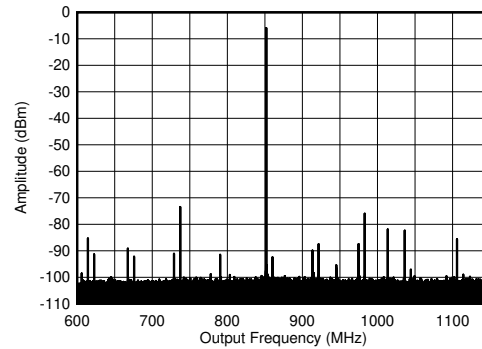

$f_{\text{DAC}} = 5898.24$ MSPS, interleave mode, 0.8 GHz matching, includes PCB and cable losses

Figure 7-352. TX Single Tone (-12 dBFS) Output Spectrum at 0.85 GHz (± 300 MHz)

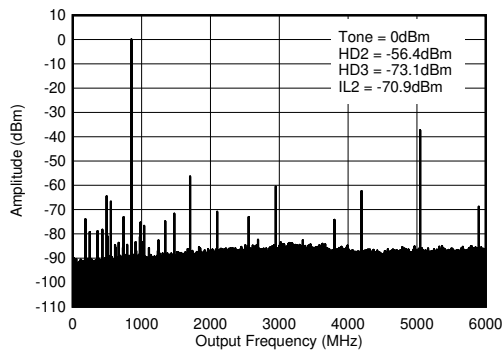

$f_{\text{DAC}} = 5898.24$ MSPS, interleave mode, 0.8 GHz matching, includes PCB and cable losses. $\text{ILn} = f_s/n \pm f_{\text{OUT}}$.

Figure 7-353. TX Single Tone (-6 dBFS) Output Spectrum at 0.85 GHz ($0-f_{\text{DAC}}$)

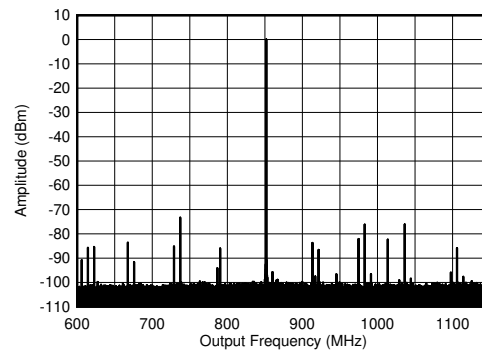

$f_{\text{DAC}} = 5898.24$ MSPS, interleave mode, 0.8 GHz matching, includes PCB and cable losses

Figure 7-354. TX Single Tone (-6 dBFS) Output Spectrum at 0.85 GHz (± 300 MHz)

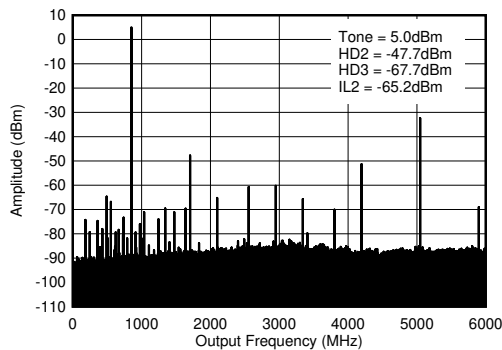

$f_{\text{DAC}} = 5898.24$ MSPS, interleave mode, 0.8 GHz matching, includes PCB and cable losses. $\text{ILn} = f_s/n \pm f_{\text{OUT}}$.

Figure 7-355. TX Single Tone (-1 dBFS) Output Spectrum at 0.85 GHz ($0-f_{\text{DAC}}$)

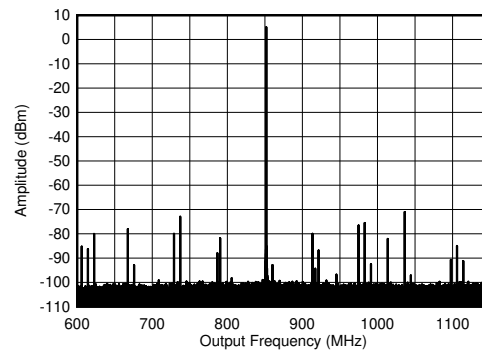

$f_{\text{DAC}} = 5898.24$ MSPS, interleave mode, 0.8 GHz matching, includes PCB and cable losses

Figure 7-356. TX Single Tone (-1 dBFS) Output Spectrum at 0.85 GHz (± 300 MHz)

7.12.9 TX Typical Characteristics at 800 MHz (continued)

Typical values at $T_A = +25^\circ\text{C}$ with nominal supplies. Unless otherwise noted, TX input data rate = 491.52 MSPS, $f_{\text{DAC}} = 11796.48$ MSPS, interleave mode, $A_{\text{OUT}} = -1$ dBFS, 1st Nyquist zone output, Internal PLL, $f_{\text{REF}} = 491.52$ MSPS, 24x Interpolation, DSA = 0 dB, Sin(x)/x enabled, DSA calibrated.

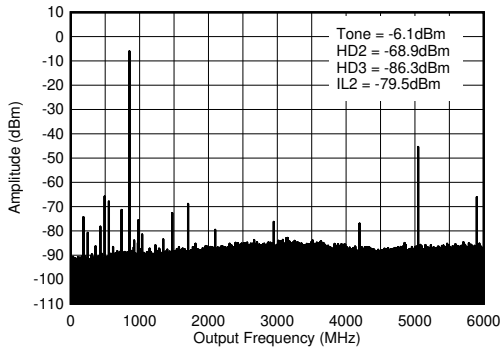

$f_{\text{DAC}} = 5898.24$ MSPS, straight mode, 0.8 GHz matching, includes PCB and cable losses. $\text{ILn} = f_s/n \pm f_{\text{OUT}}$ and is due to mixing with digital clocks.

Figure 7-357. TX Single Tone (-12 dBFS) Output Spectrum at 0.85 GHz ($0-f_{\text{DAC}}$)

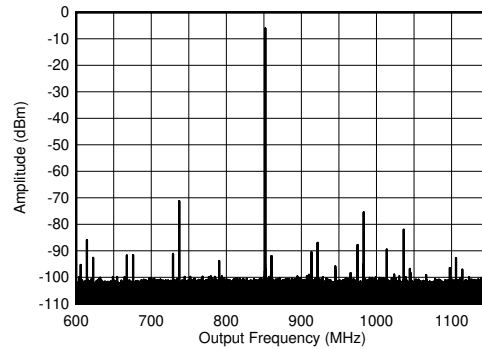

$f_{\text{DAC}} = 5898.24$ MSPS, straight mode, 0.8 GHz matching, includes PCB and cable losses

Figure 7-358. TX Single Tone (-12 dBFS) Output Spectrum at 0.85 GHz (± 300 MHz)

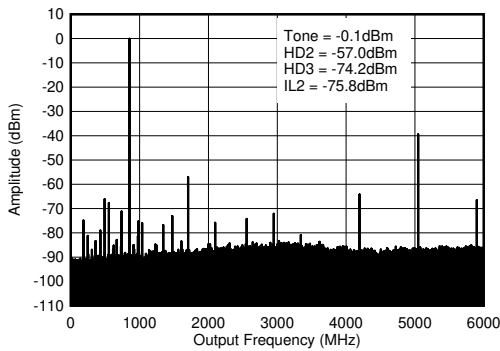

$f_{\text{DAC}} = 5898.24$ MSPS, straight mode, 0.8 GHz matching, includes PCB and cable losses. $\text{ILn} = f_s/n \pm f_{\text{OUT}}$ and is due to mixing with digital clocks.

Figure 7-359. TX Single Tone (-6 dBFS) Output Spectrum at 0.85 GHz ($0-f_{\text{DAC}}$)

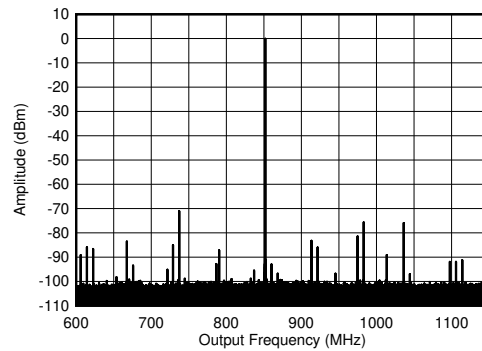

$f_{\text{DAC}} = 5898.24$ MSPS, straight mode, 0.8 GHz matching, includes PCB and cable losses

Figure 7-360. TX Single Tone (-6 dBFS) Output Spectrum at 0.85 GHz (± 300 MHz)

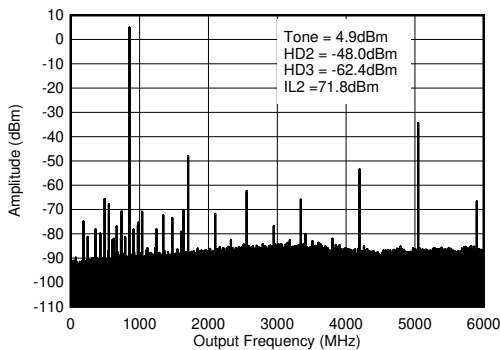

$f_{\text{DAC}} = 5898.24$ MSPS, straight mode, 0.8 GHz matching, includes PCB and cable losses. $\text{ILn} = f_s/n \pm f_{\text{OUT}}$ and is due to mixing with digital clocks.

Figure 7-361. TX Single Tone (-1 dBFS) Output Spectrum at 0.85 GHz ($0-f_{\text{DAC}}$)

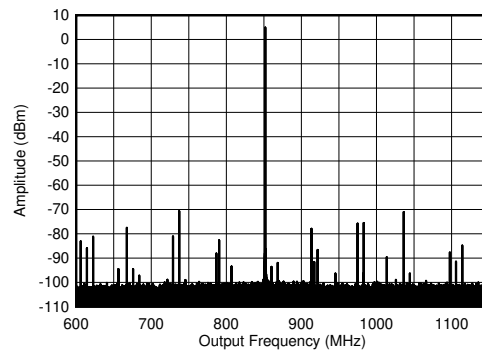

$f_{\text{DAC}} = 5898.24$ MSPS, straight mode, 0.8 GHz matching, includes PCB and cable losses

Figure 7-362. TX Single Tone (-1 dBFS) Output Spectrum at 0.85 GHz (± 300 MHz)

7.12.10 TX Typical Characteristics at 1.8 GHz

Typical values at $T_A = +25^\circ\text{C}$ with nominal supplies. Unless otherwise noted, TX input data rate = 491.52 MSPS, $f_{DAC} = 11796.48$ MSPS, interleave mode, $A_{OUT} = -1$ dBFS, 1st Nyquist zone output, Internal PLL, $f_{REF} = 491.52$ MSPS, 24x Interpolation, DSA = 0 dB, $\text{Sin}(x)/x$ enabled, DSA calibrated.

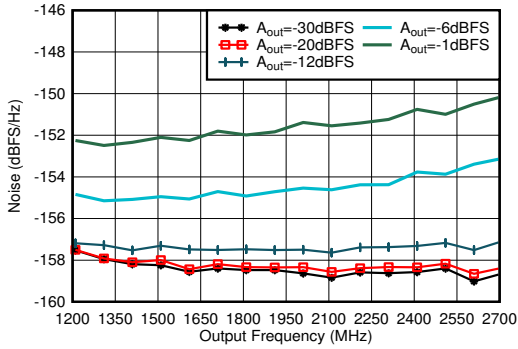

Matching at 1.8 GHz, Single tone, $f_{DAC} = 11.79648$ GSPS, interleave mode, 40-MHz offset

Figure 7-363. TX Single Tone Output Noise vs Frequency and Amplitude at 1.8 GHz

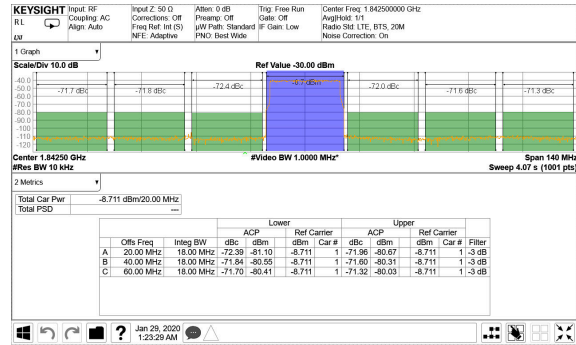

TM1.1, $P_{OUT_RMS} = -13$ dBFS

Figure 7-364. TX 20-MHz LTE Output Spectrum at 1.8425 GHz

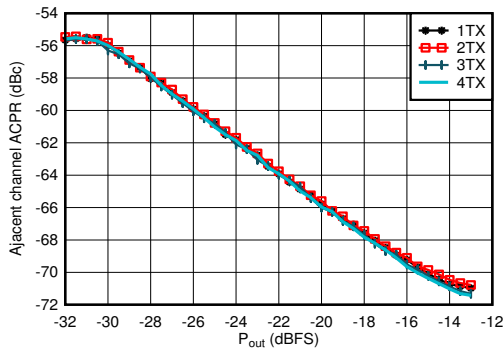

Matching at 1.8 GHz, single carrier 20-MHz BW TM1.1 LTE

Figure 7-365. TX 20-MHz LTE ACPR vs Digital Level at 1.8425 GHz

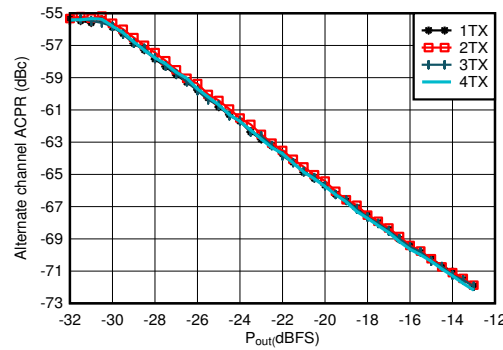

Matching at 1.8 GHz, single carrier 20-MHz BW TM1.1 LTE

Figure 7-366. TX 20-MHz LTE alt-ACPR vs Digital Level at 1.8425 GHz

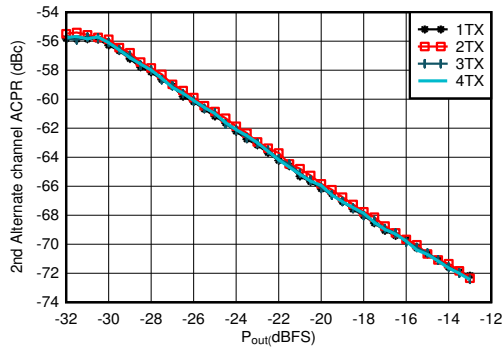

Matching at 1.8 GHz, single carrier 20-MHz BW TM1.1 LTE

Figure 7-367. TX 20-MHz LTE alt2-ACPR vs Digital Level at 1.8425 GHz

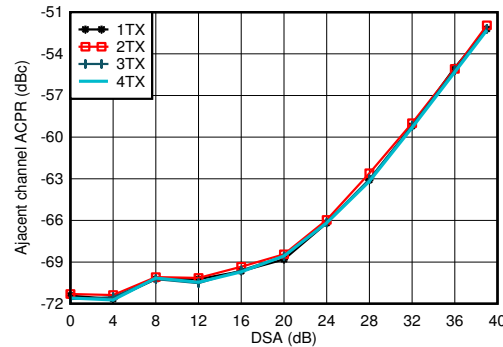

Matching at 1.8 GHz, single carrier 20-MHz BW TM1.1 LTE

Figure 7-368. TX 20-MHz LTE ACPR vs DSA at 1.8 GHz

7.12.10 TX Typical Characteristics at 1.8 GHz (continued)

Typical values at $T_A = +25^\circ\text{C}$ with nominal supplies. Unless otherwise noted, TX input data rate = 491.52 MSPS, $f_{\text{DAC}} = 11796.48$ MSPS, interleave mode, $A_{\text{OUT}} = -1$ dBFS, 1st Nyquist zone output, Internal PLL, $f_{\text{REF}} = 491.52$ MSPS, 24x Interpolation, DSA = 0 dB, $\text{Sin}(x)/x$ enabled, DSA calibrated.

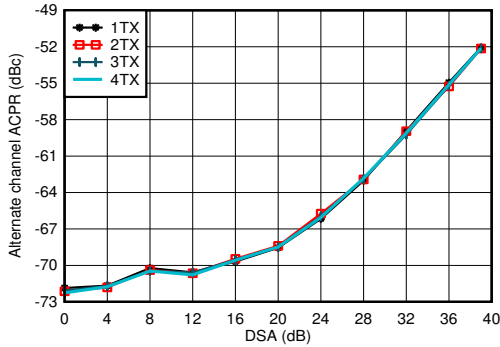

Matching at 1.8 GHz, single carrier 20-MHz BW TM1.1 LTE
Figure 7-369. TX 20-MHz LTE alt-ACPR vs DSA at 1.8 GHz

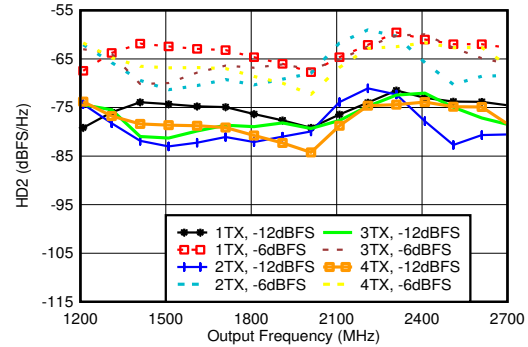

Matching at 1.8 GHz, $f_{\text{DAC}} = 11.79648$ GSPS, interleave mode, normalized to output power at harmonic frequency
Figure 7-370. TX HD2 vs Digital Amplitude and Output Frequency at 1.8 GHz

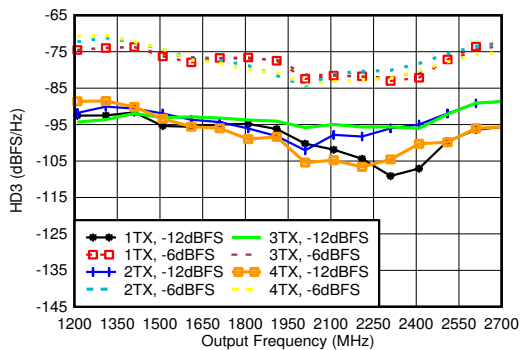

Matching at 1.8 GHz, $f_{\text{DAC}} = 11.79648$ GSPS, interleave mode, normalized to output power at harmonic frequency
Figure 7-371. TX HD3 vs Digital Amplitude and Output Frequency at 1.8 GHz

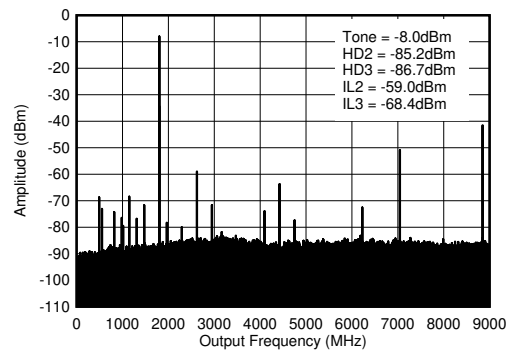

$f_{\text{DAC}} = 8847.36$ MSPS, interleave mode, 1.8 GHz matching, includes PCB and cable losses. $\text{IL}_n = f_{\text{S}}/n \pm f_{\text{OUT}}$.
Figure 7-372. TX Single Tone (-12 dBFS) Output Spectrum at 1.8 GHz ($0-f_{\text{DAC}}$)

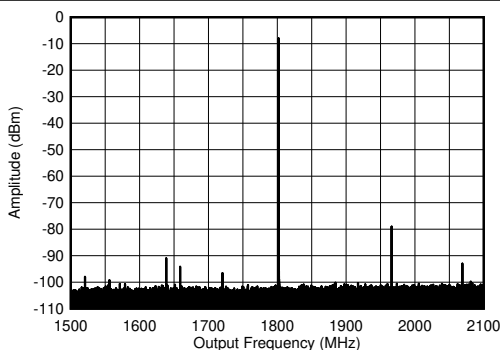

$f_{\text{DAC}} = 8847.36$ MSPS, interleave mode, 1.8 GHz matching, includes PCB and cable losses
Figure 7-373. TX Single Tone (-12 dBFS) Output Spectrum at 1.8 GHz (± 300 MHz)

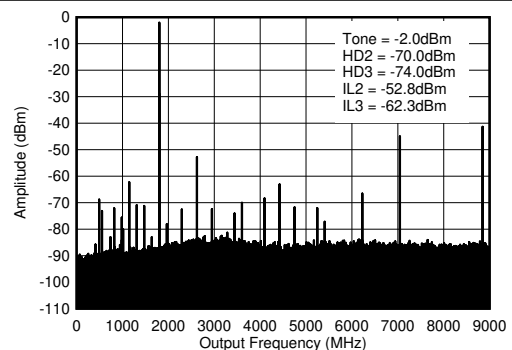

$f_{\text{DAC}} = 8847.36$ MSPS, interleave mode, 1.8 GHz matching, includes PCB and cable losses. $\text{IL}_n = f_{\text{S}}/n \pm f_{\text{OUT}}$.
Figure 7-374. TX Single Tone (-6 dBFS) Output Spectrum at 1.8 GHz ($0-f_{\text{DAC}}$)

7.12.10 TX Typical Characteristics at 1.8 GHz (continued)

Typical values at $T_A = +25^\circ\text{C}$ with nominal supplies. Unless otherwise noted, TX input data rate = 491.52 MSPS, $f_{\text{DAC}} = 11796.48$ MSPS, interleave mode, $A_{\text{OUT}} = -1$ dBFS, 1st Nyquist zone output, Internal PLL, $f_{\text{REF}} = 491.52$ MSPS, 24x Interpolation, DSA = 0 dB, $\text{Sin}(x)/x$ enabled, DSA calibrated.

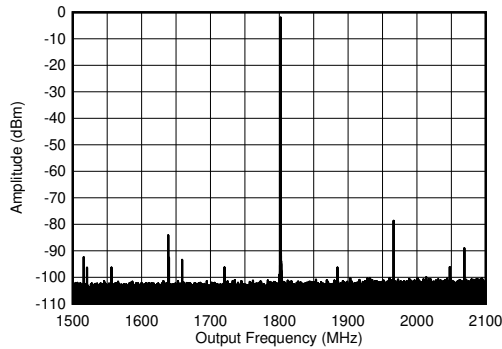

$f_{\text{DAC}} = 8847.36$ MSPS, interleave mode, 1.8 GHz matching, includes PCB and cable losses

Figure 7-375. TX Single Tone (-6 dBFS) Output Spectrum at 1.8 GHz (± 300 MHz)

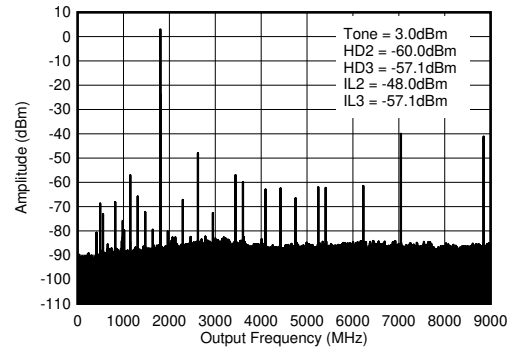

$f_{\text{DAC}} = 8847.36$ MSPS, interleave mode, 1.8 GHz matching, includes PCB and cable losses. $\text{IL}_n = f_{\text{S}}/n \pm f_{\text{OUT}}$.

Figure 7-376. TX Single Tone (-1 dBFS) Output Spectrum at 1.8 GHz ($0-f_{\text{DAC}}$)

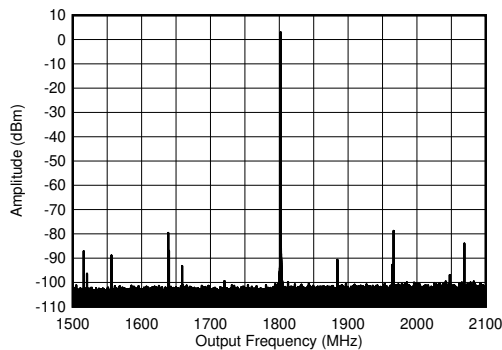

$f_{\text{DAC}} = 8847.36$ MSPS, interleave mode, 1.8 GHz matching, includes PCB and cable losses

Figure 7-377. TX Single Tone (-1 dBFS) Output Spectrum at 1.8 GHz (± 300 MHz)

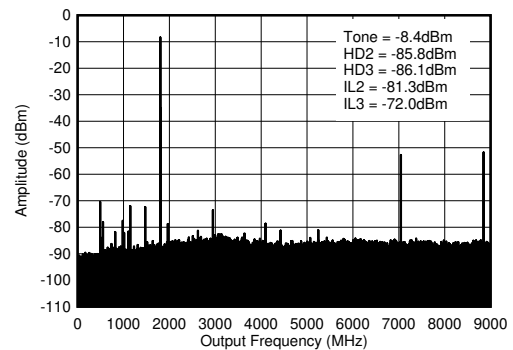

$f_{\text{DAC}} = 8847.36$ MSPS, straight mode, 1.8 GHz matching, includes PCB and cable losses. $\text{IL}_n = f_{\text{S}}/n \pm f_{\text{OUT}}$ and is due to mixing with digital clocks.

Figure 7-378. TX Single Tone (-12 dBFS) Output Spectrum at 1.8 GHz ($0-f_{\text{DAC}}$)

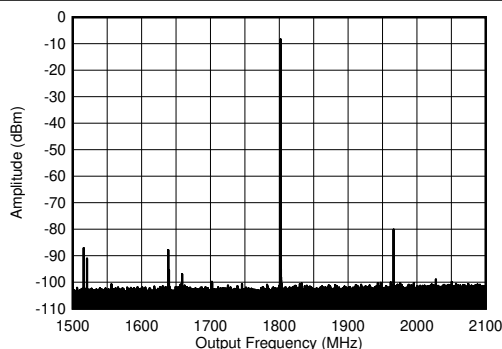

$f_{\text{DAC}} = 8847.36$ MSPS, straight mode, 1.8 GHz matching, includes PCB and cable losses

Figure 7-379. TX Single Tone (-12 dBFS) Output Spectrum at 1.8 GHz (± 300 MHz)

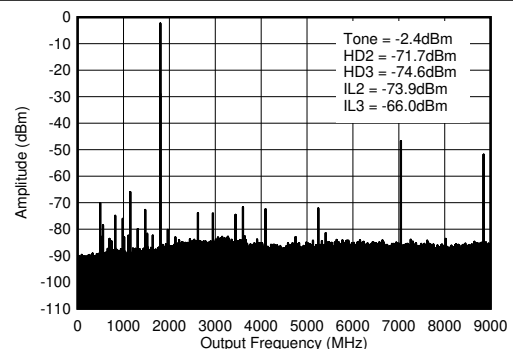

$f_{\text{DAC}} = 8847.36$ MSPS, straight mode, 1.8 GHz matching, includes PCB and cable losses. $\text{IL}_n = f_{\text{S}}/n \pm f_{\text{OUT}}$ and is due to mixing with digital clocks.

Figure 7-380. TX Single Tone (-6 dBFS) Output Spectrum at 1.8 GHz ($0-f_{\text{DAC}}$)

7.12.10 TX Typical Characteristics at 1.8 GHz (continued)

Typical values at $T_A = +25^\circ\text{C}$ with nominal supplies. Unless otherwise noted, TX input data rate = 491.52 MSPS, $f_{\text{DAC}} = 11796.48$ MSPS, interleave mode, $A_{\text{OUT}} = -1$ dBFS, 1st Nyquist zone output, Internal PLL, $f_{\text{REF}} = 491.52$ MSPS, 24x Interpolation, DSA = 0 dB, $\text{Sin}(x)/x$ enabled, DSA calibrated.

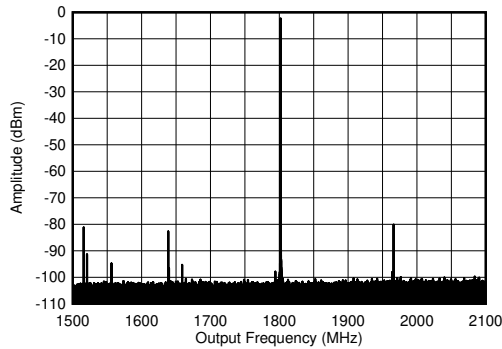

$f_{\text{DAC}} = 8847.36$ MSPS, straight mode, 1.8 GHz matching, includes PCB and cable losses

Figure 7-381. TX Single Tone (-6 dBFS) Output Spectrum at 1.8 GHz (± 300 MHz)

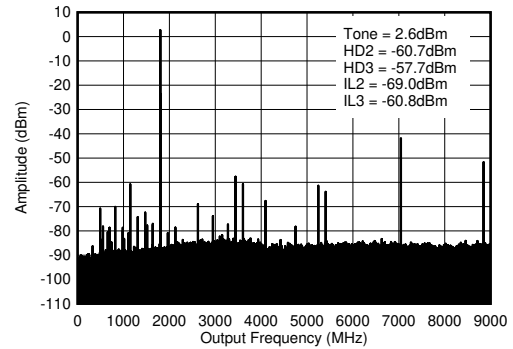

$f_{\text{DAC}} = 8847.36$ MSPS, straight mode, 1.8 GHz matching, includes PCB and cable losses. $\text{IL}_n = f_{\text{S}}/n \pm f_{\text{OUT}}$ and is due to mixing with digital clocks.

Figure 7-382. TX Single Tone (-1 dBFS) Output Spectrum at 1.8 GHz ($0-f_{\text{DAC}}$)

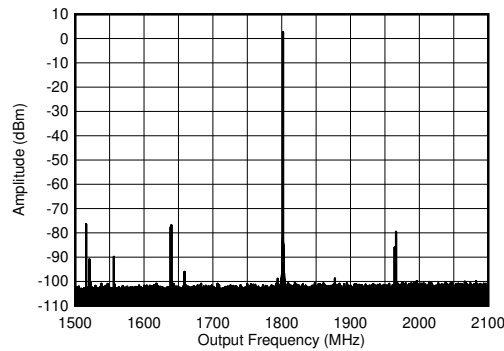

$f_{\text{DAC}} = 8847.36$ MSPS, straight mode, 1.8 GHz matching, includes PCB and cable losses

Figure 7-383. TX Single Tone (-1 dBFS) Output Spectrum at 1.8 GHz (± 300 MHz)

7.12.11 TX Typical Characteristics at 2.6 GHz

Typical values at $T_A = +25^\circ\text{C}$ with nominal supplies. Unless otherwise noted, TX input data rate = 491.52 MSPS, $f_{\text{DAC}} = 11796.48$ MSPS, interleave mode, $A_{\text{OUT}} = -1$ dBFS, 1st Nyquist zone output, Internal PLL, $f_{\text{REF}} = 491.52$ MSPS, 24x Interpolation, DSA = 0 dB, Sin(x)/x enabled, DSA calibrated.

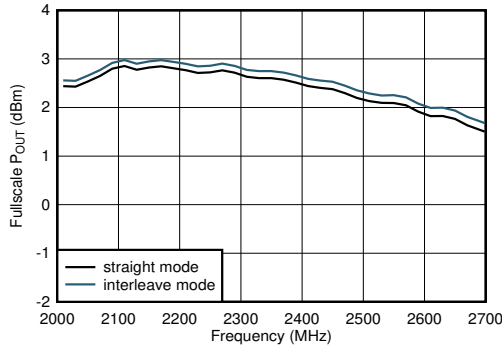

Including PCB and cable losses, $A_{\text{out}} = -0.5$ dBFS, DSA = 0, 2.6 GHz matching

Figure 7-384. TX Full Scale vs RF Frequency at 5898.24 MSPS

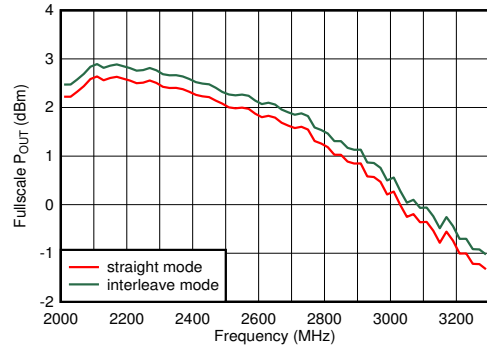

Including PCB and cable losses, $A_{\text{out}} = -0.5$ dBFS, DSA = 0, 2.6 GHz matching

Figure 7-385. TX Full Scale vs RF Frequency at 8847.36 MSPS

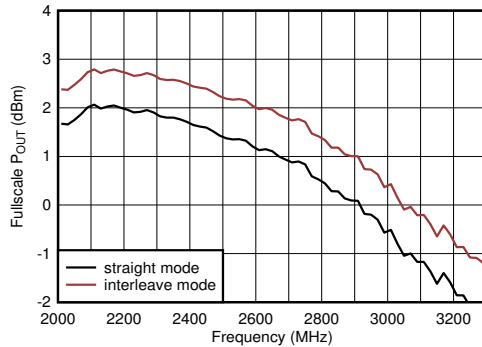

Including PCB and cable losses, $A_{\text{out}} = -0.5$ dBFS, DSA = 0, 2.6 GHz matching

Figure 7-386. TX Full Scale vs RF Frequency at 11796.48 MSPS

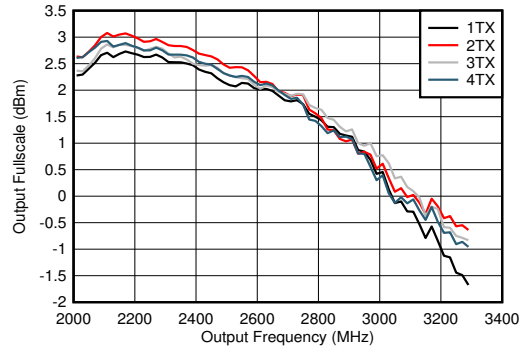

$f_{\text{DAC}} = 8847.36$ MSPS, interleave mode, including PCB and cable losses, $A_{\text{out}} = -0.5$ dBFS, DSA = 0, 2.6 GHz matching

Figure 7-387. TX Output Fullscale vs Output Frequency and Channel

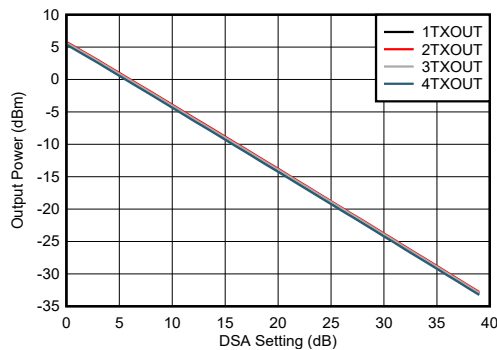

$f_{\text{DAC}} = 8847.36$ MSPS, $A_{\text{out}} = -0.5$ dBFS, matching 2.6 GHz

Figure 7-388. TX Output Power vs DSA Setting and Channel at 2.6 GHz

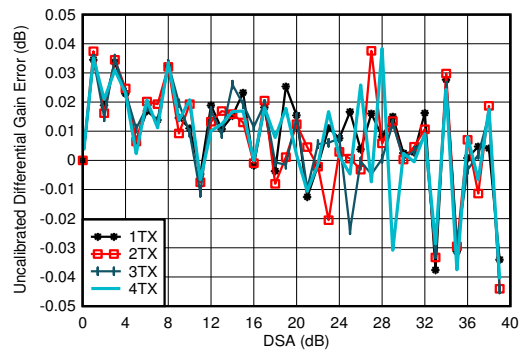

$f_{\text{DAC}} = 8847.36$ MSPS, straight mode, matching at 2.6 GHz
Differential Gain Error = $P_{\text{OUT}}(\text{DSA Setting} - 1) - P_{\text{OUT}}(\text{DSA Setting}) + 1$

Figure 7-389. TX Uncalibrated Differential Gain Error vs DSA Setting and Channel at 2.6 GHz

7.12.11 TX Typical Characteristics at 2.6 GHz (continued)

Typical values at $T_A = +25^\circ\text{C}$ with nominal supplies. Unless otherwise noted, TX input data rate = 491.52 MSPS, $f_{\text{DAC}} = 11796.48$ MSPS, interleave mode, $A_{\text{OUT}} = -1$ dBFS, 1st Nyquist zone output, Internal PLL, $f_{\text{REF}} = 491.52$ MSPS, 24x Interpolation, DSA = 0 dB, Sin(x)/x enabled, DSA calibrated.

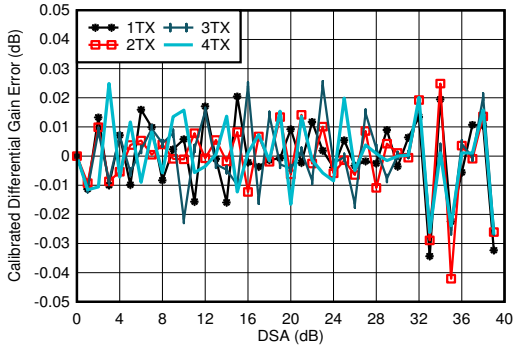

$f_{\text{DAC}} = 8847.36$ MSPS, straight mode, matching at 2.6 GHz
Differential Gain Error = $P_{\text{OUT}}(\text{DSA Setting} - 1) - P_{\text{OUT}}(\text{DSA Setting}) + 1$

Figure 7-390. TX Calibrated Differential Gain Error vs DSA Setting and Channel at 2.6 GHz

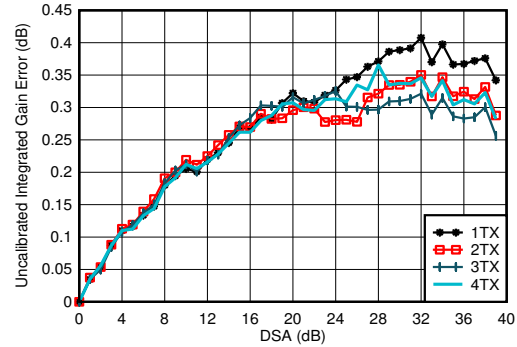

$f_{\text{DAC}} = 8847.36$ MSPS, straight mode, matching at 2.6 GHz
Integrated Gain Error = $P_{\text{OUT}}(\text{DSA Setting}) - P_{\text{OUT}}(\text{DSA Setting} = 0) + (\text{DSA Setting})$

Figure 7-391. TX Uncalibrated Integrated Gain Error vs DSA Setting and Channel at 2.6 GHz

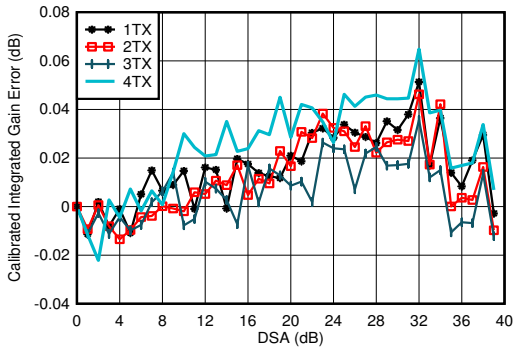

$f_{\text{DAC}} = 8847.36$ MSPS, straight mode, matching at 2.6 GHz
Integrated Gain Error = $P_{\text{OUT}}(\text{DSA Setting}) - P_{\text{OUT}}(\text{DSA Setting} = 0) + (\text{DSA Setting})$

Figure 7-392. TX Calibrated Integrated Gain Error vs DSA Setting and Channel at 2.6 GHz

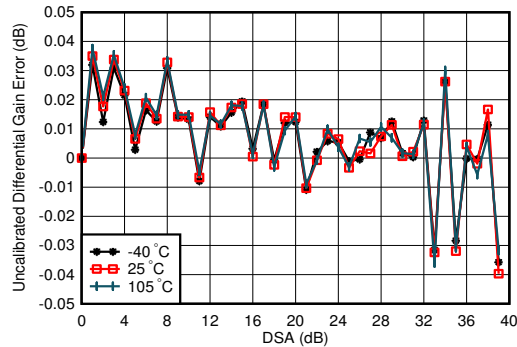

$f_{\text{DAC}} = 8847.36$ MSPS, straight mode, matching at 2.6 GHz, channel with the median variation over DSA setting at 25°C
Differential Gain Error = $P_{\text{OUT}}(\text{DSA Setting} - 1) - P_{\text{OUT}}(\text{DSA Setting}) + 1$

Figure 7-393. TX Uncalibrated Differential Gain Error vs DSA Setting and Temperature at 2.6 GHz

7.12.11 TX Typical Characteristics at 2.6 GHz (continued)

Typical values at $T_A = +25^\circ\text{C}$ with nominal supplies. Unless otherwise noted, TX input data rate = 491.52 MSPS, $f_{\text{DAC}} = 11796.48$ MSPS, interleave mode, $A_{\text{OUT}} = -1$ dBFS, 1st Nyquist zone output, Internal PLL, $f_{\text{REF}} = 491.52$ MSPS, 24x Interpolation, DSA = 0 dB, Sin(x)/x enabled, DSA calibrated.

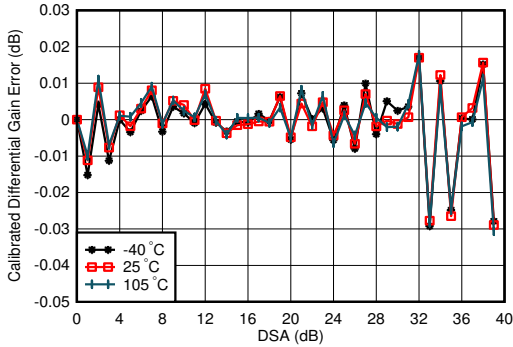

$f_{\text{DAC}} = 8847.36$ MSPS, straight mode, matching at 2.6 GHz, channel with the median variation over DSA setting at 25°C
 Differential Gain Error = $P_{\text{OUT}}(\text{DSA Setting} - 1) - P_{\text{OUT}}(\text{DSA Setting}) + 1$

Figure 7-394. TX Calibrated Differential Gain Error vs DSA Setting and Temperature at 2.6 GHz

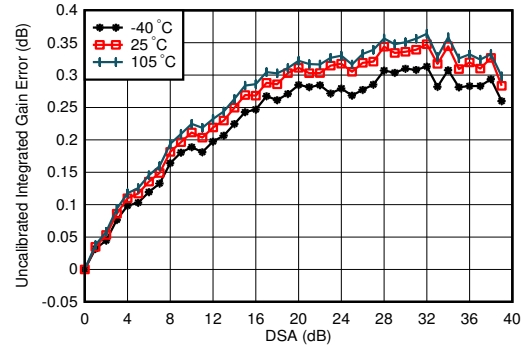

$f_{\text{DAC}} = 8847.36$ MSPS, straight mode, matching at 2.6 GHz, channel with the median variation over DSA setting at 25°C
 Integrated Gain Error = $P_{\text{OUT}}(\text{DSA Setting}) - P_{\text{OUT}}(\text{DSA Setting} = 0) + (\text{DSA Setting})$

Figure 7-395. TX Uncalibrated Integrated Gain Error vs DSA Setting and Temperature at 2.6 GHz

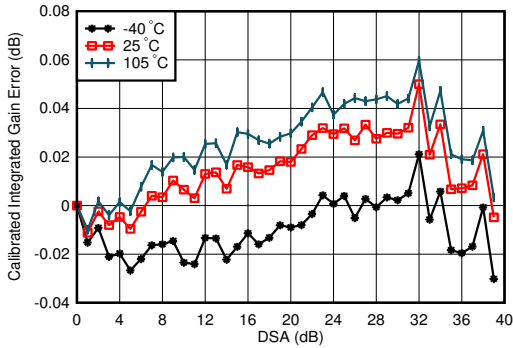

$f_{\text{DAC}} = 8847.36$ MSPS, straight mode, matching at 2.6 GHz, channel with the median variation over DSA setting at 25°C
 Integrated Gain Error = $P_{\text{OUT}}(\text{DSA Setting}) - P_{\text{OUT}}(\text{DSA Setting} = 0) + (\text{DSA Setting})$

Figure 7-396. TX Calibrated Integrated Gain Error vs DSA Setting and Temperature at 2.6 GHz

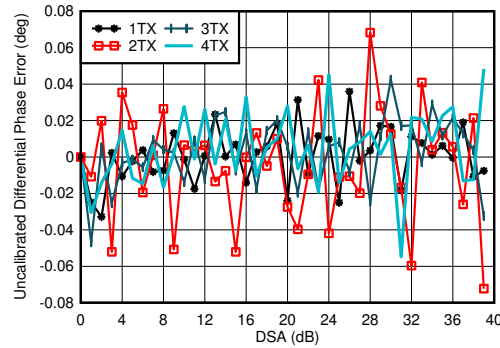

$f_{\text{DAC}} = 8847.36$ MSPS, straight mode, matching at 2.6 GHz
 Differential Phase Error = $\text{Phase}_{\text{OUT}}(\text{DSA Setting} - 1) - \text{Phase}_{\text{OUT}}(\text{DSA Setting})$

Figure 7-397. TX Uncalibrated Differential Phase Error vs DSA Setting and Channel at 2.6 GHz

7.12.11 TX Typical Characteristics at 2.6 GHz (continued)

Typical values at $T_A = +25^\circ\text{C}$ with nominal supplies. Unless otherwise noted, TX input data rate = 491.52 MSPS, $f_{\text{DAC}} = 11796.48$ MSPS, interleave mode, $A_{\text{OUT}} = -1$ dBFS, 1st Nyquist zone output, Internal PLL, $f_{\text{REF}} = 491.52$ MSPS, 24x Interpolation, DSA = 0 dB, Sin(x)/x enabled, DSA calibrated.

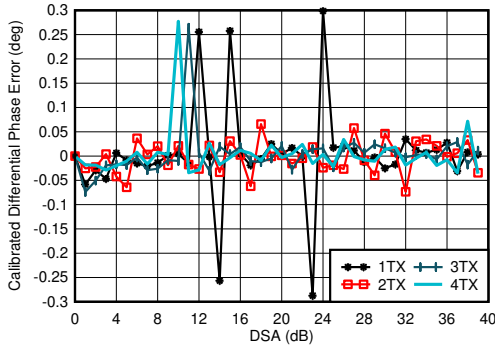

$f_{\text{DAC}} = 8847.36$ MSPS, straight mode, matching at 2.6 GHz
Differential Phase Error = $\text{Phase}_{\text{OUT}}(\text{DSA Setting} - 1) - \text{Phase}_{\text{OUT}}(\text{DSA Setting})$
Phase DNL spike may occur at any DSA setting.

Figure 7-398. TX Calibrated Differential Phase Error vs DSA Setting and Channel at 2.6 GHz

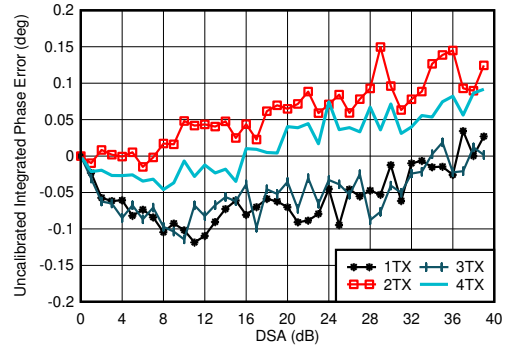

$f_{\text{DAC}} = 8847.36$ MSPS, straight mode, matching at 2.6 GHz
Integrated Phase Error = $\text{Phase}(\text{DSA Setting}) - \text{Phase}(\text{DSA Setting} = 0)$

Figure 7-399. TX Uncalibrated Integrated Phase Error vs DSA Setting and Channel at 2.6 GHz

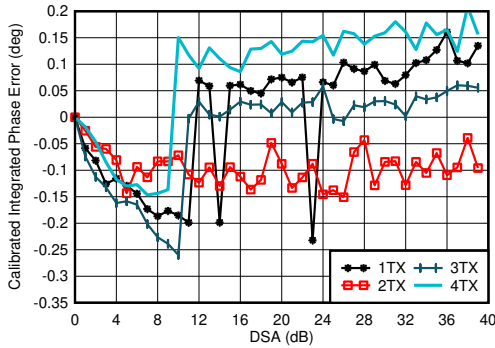

$f_{\text{DAC}} = 8847.36$ MSPS, straight mode, matching at 2.6 GHz
Integrated Phase Error = $\text{Phase}(\text{DSA Setting}) - \text{Phase}(\text{DSA Setting} = 0)$

Figure 7-400. TX Calibrated Integrated Phase Error vs DSA Setting and Channel at 2.6 GHz

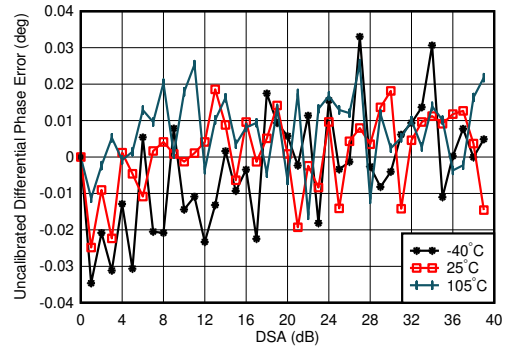

$f_{\text{DAC}} = 8847.36$ MSPS, straight mode, matching at 2.6 GHz, channel with the median variation over DSA setting at 25°C
Differential Phase Error = $\text{Phase}_{\text{OUT}}(\text{DSA Setting} - 1) - \text{Phase}_{\text{OUT}}(\text{DSA Setting})$

Figure 7-401. TX Uncalibrated Differential Phase Error vs DSA Setting and Temperature at 2.6 GHz

7.12.11 TX Typical Characteristics at 2.6 GHz (continued)

Typical values at $T_A = +25^\circ\text{C}$ with nominal supplies. Unless otherwise noted, TX input data rate = 491.52 MSPS, $f_{\text{DAC}} = 11796.48$ MSPS, interleave mode, $A_{\text{OUT}} = -1$ dBFS, 1st Nyquist zone output, Internal PLL, $f_{\text{REF}} = 491.52$ MSPS, 24x Interpolation, DSA = 0 dB, Sin(x)/x enabled, DSA calibrated.

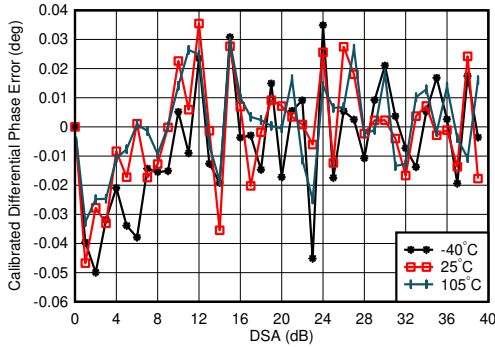

$f_{\text{DAC}} = 8847.36$ MSPS, straight mode, matching at 2.6 GHz, channel with the median variation over DSA setting at 25°C
 Differential Phase Error = $\text{Phase}_{\text{OUT}}(\text{DSA Setting} - 1) - \text{Phase}_{\text{OUT}}(\text{DSA Setting})$

Figure 7-402. TX Calibrated Differential Phase Error vs DSA Setting and Temperature at 2.6 GHz

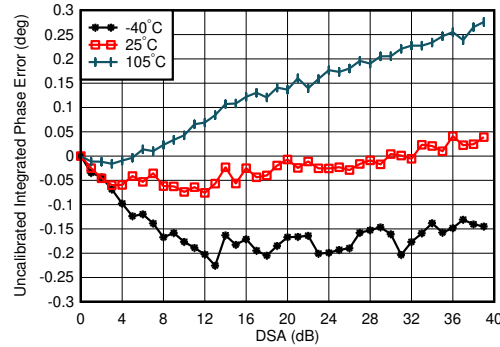

$f_{\text{DAC}} = 8847.36$ MSPS, straight mode, matching at 2.6 GHz, channel with the medium variation over DSA setting at 25°C
 Integrated Phase Error = $\text{Phase}(\text{DSA Setting}) - \text{Phase}(\text{DSA Setting} = 0)$

Figure 7-403. TX Uncalibrated Integrated Phase Error vs DSA Setting and Temperature at 2.6 GHz

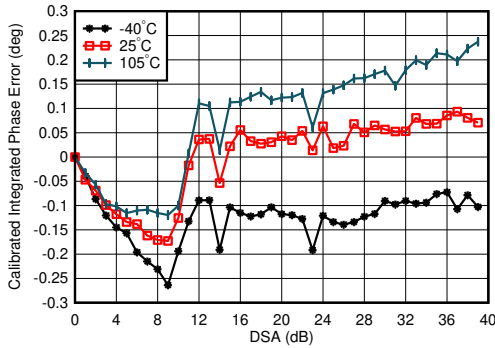

$f_{\text{DAC}} = 8847.36$ MSPS, straight mode, matching at 2.6 GHz, channel with the median variation over DSA setting at 25°C
 Integrated Phase Error = $\text{Phase}(\text{DSA Setting}) - \text{Phase}(\text{DSA Setting} = 0)$

Figure 7-404. TX Calibrated Integrated Phase Error vs DSA Setting and Temperature at 2.6 GHz

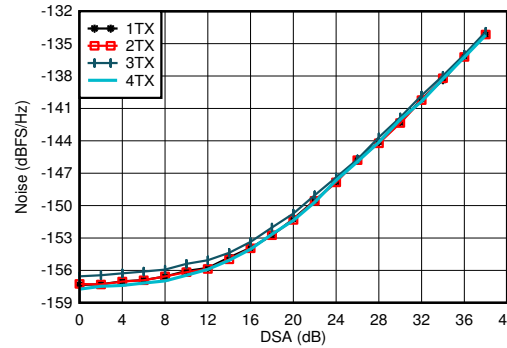

$f_{\text{DAC}} = 8847.36$ MSPS, straight mode, matching at 2.6 GHz, $P_{\text{OUT}} = -13$ dBFS

Figure 7-405. TX Output Noise vs Channel and Attenuation at 2.6 GHz

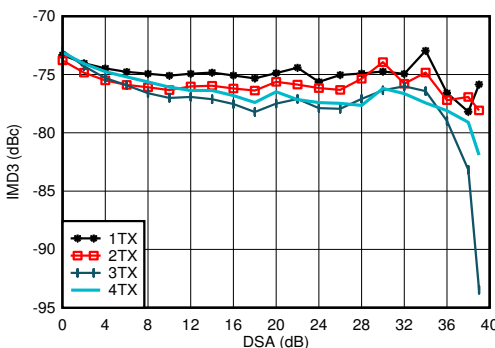

$f_{\text{DAC}} = 8847.36$ MSPS, straight mode, $f_{\text{CENTER}} = 2.6$ GHz, matching at 2.6 GHz, -13 dBFS each tone

Figure 7-406. TX IMD3 vs DSA Setting at 2.6 GHz

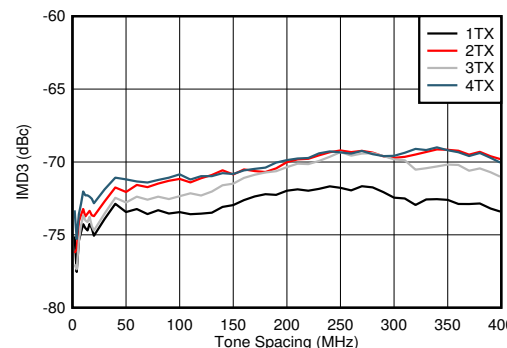

$f_{\text{DAC}} = 8847.36$ MSPS, straight mode, $f_{\text{CENTER}} = 2.6$ GHz, matching at 2.6 GHz, -13 dBFS each tone

Figure 7-407. TX IMD3 vs Tone Spacing and Channel at 2.6 GHz

7.12.11 TX Typical Characteristics at 2.6 GHz (continued)

Typical values at $T_A = +25^\circ\text{C}$ with nominal supplies. Unless otherwise noted, TX input data rate = 491.52 MSPS, $f_{\text{DAC}} = 11796.48$ MSPS, interleave mode, $A_{\text{OUT}} = -1$ dBFS, 1st Nyquist zone output, Internal PLL, $f_{\text{REF}} = 491.52$ MSPS, 24x Interpolation, DSA = 0 dB, Sin(x)/x enabled, DSA calibrated.

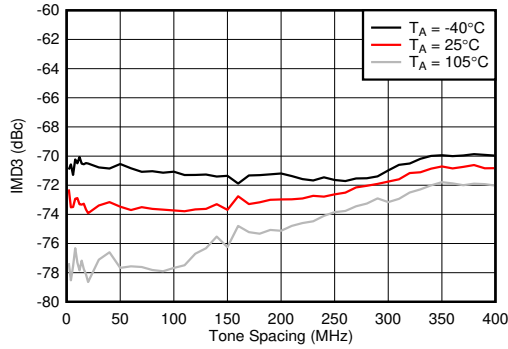

$f_{\text{DAC}} = 8847.36$ MSPS, straight mode, $f_{\text{CENTER}} = 2.6$ GHz, matching at 2.6 GHz, -13 dBFS each tone, worst channel.

Figure 7-408. TX IMD3 vs Tone Spacing and Temperature at 2.6 GHz

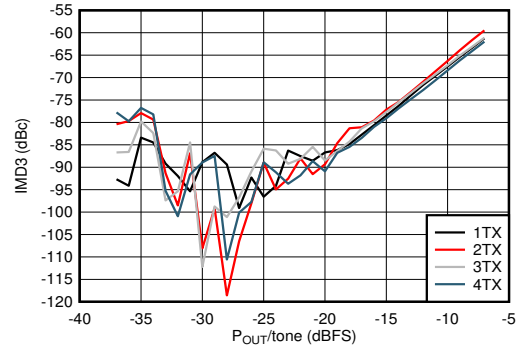

$f_{\text{DAC}} = 8847.36$ MSPS, straight mode, $f_{\text{CENTER}} = 2.6$ GHz, $f_{\text{SPACING}} = 20$ MHz, matching at 2.6 GHz

Figure 7-409. TX IMD3 vs Digital Level at 2.6 GHz

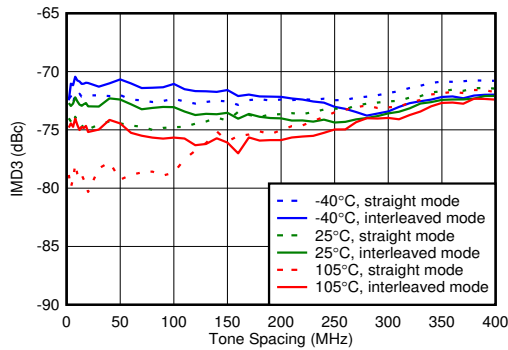

$f_{\text{DAC}} = 8847.36$ MSPS, straight mode, $f_{\text{CENTER}} = 2.6$ GHz, matching at 2.6 GHz, -13 dBFS each tone

Figure 7-410. TX IMD3 vs Tone Spacing and Temperature

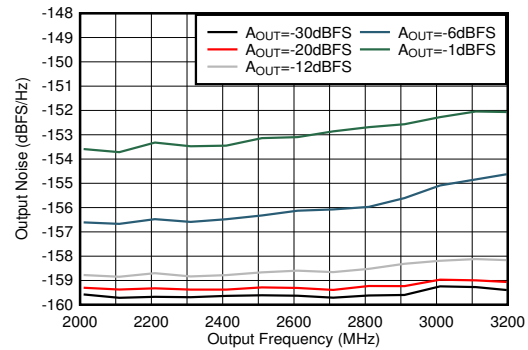

Matching at 2.6 GHz, Single tone, $f_{\text{DAC}} = 11.79648$ GSPPS, interleave mode, 40-MHz offset

Figure 7-411. TX Single Tone Output Noise vs Frequency and Amplitude at 2.6 GHz



TM1.1, $P_{\text{OUT_RMS}} = -13$ dBFS

Figure 7-412. TX 20-MHz LTE Output Spectrum at 2.6 GHz (Band 41)

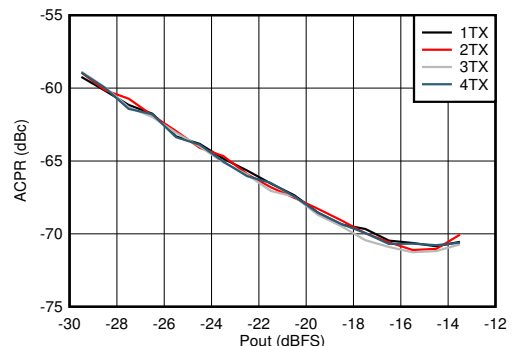

Matching at 2.6 GHz, single carrier 20-MHz BW TM1.1 LTE

Figure 7-413. TX 20-MHz LTE ACPR vs Digital Level at 2.6 GHz

7.12.11 TX Typical Characteristics at 2.6 GHz (continued)

Typical values at $T_A = +25^\circ\text{C}$ with nominal supplies. Unless otherwise noted, TX input data rate = 491.52 MSPS, $f_{DAC} = 11796.48$ MSPS, interleave mode, $A_{OUT} = -1$ dBFS, 1st Nyquist zone output, Internal PLL, $f_{REF} = 491.52$ MSPS, 24x Interpolation, DSA = 0 dB, Sin(x)/x enabled, DSA calibrated.

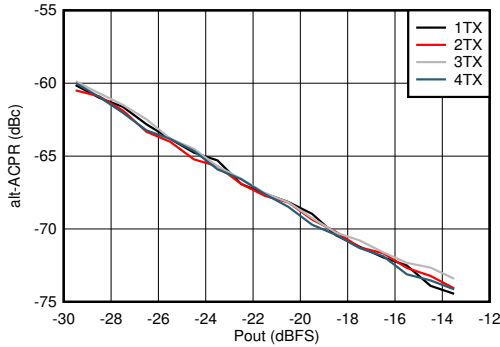

Matching at 2.6 GHz, single carrier 20-MHz BW TM1.1 LTE

Figure 7-414. TX 20-MHz LTE alt-ACPR vs Digital Level at 2.6 GHz

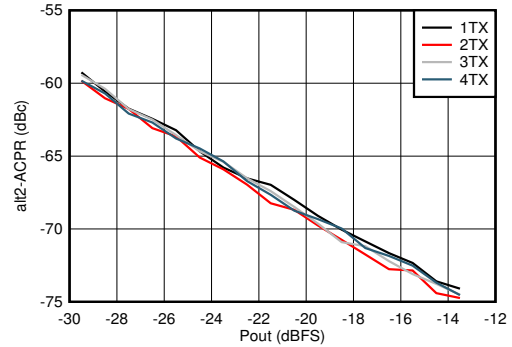

Matching at 2.6 GHz, single carrier 20-MHz BW TM1.1 LTE

Figure 7-415. TX 20-MHz LTE alt2-ACPR vs Digital Level at 2.6 GHz

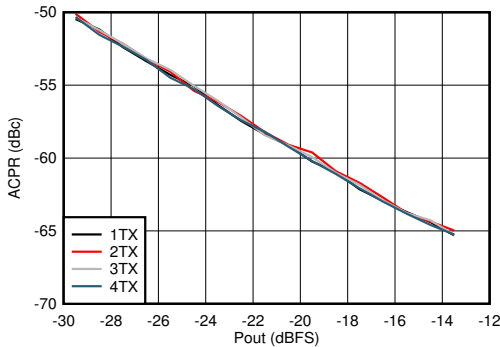

Matching at 2.6 GHz, single carrier 100-MHz BW TM1.1 NR

Figure 7-416. TX 100-MHz NR ACPR vs Digital Level at 2.6 GHz

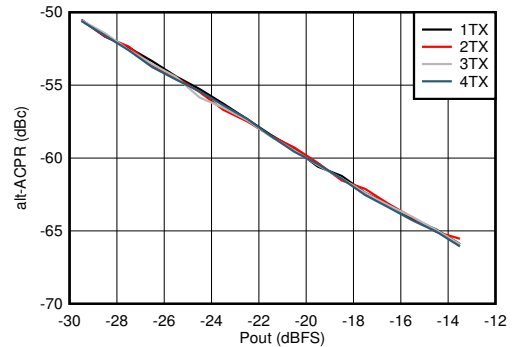

Matching at 2.6 GHz, single carrier 100-MHz BW TM1.1 NR

Figure 7-417. TX 100-MHz NR alt-ACPR vs Digital Level at 2.6 GHz

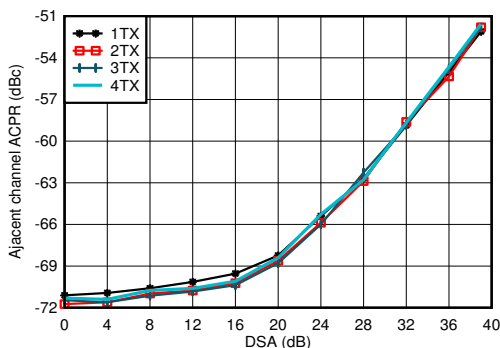

Matching at 2.6 GHz, single carrier 20-MHz BW TM1.1 LTE

Figure 7-418. TX 20-MHz LTE ACPR vs DSA at 2.6 GHz

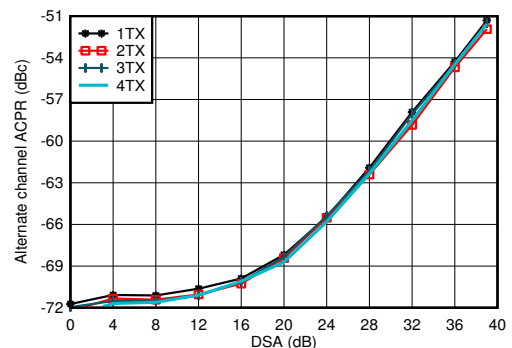

Matching at 2.6 GHz, single carrier 20-MHz BW TM1.1 LTE

Figure 7-419. TX 20-MHz LTE alt-ACPR vs DSA at 2.6 GHz

7.12.11 TX Typical Characteristics at 2.6 GHz (continued)

Typical values at $T_A = +25^\circ\text{C}$ with nominal supplies. Unless otherwise noted, TX input data rate = 491.52 MSPS, $f_{\text{DAC}} = 11796.48$ MSPS, interleave mode, $A_{\text{OUT}} = -1$ dBFS, 1st Nyquist zone output, Internal PLL, $f_{\text{REF}} = 491.52$ MSPS, 24x Interpolation, DSA = 0 dB, $\text{Sin}(x)/x$ enabled, DSA calibrated.

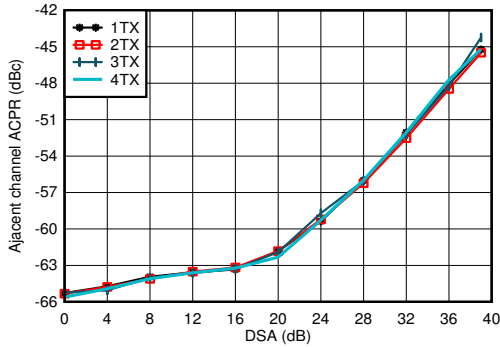

Matching at 2.6 GHz, single carrier 100-MHz BW TM1.1 NR

Figure 7-420. TX 100-MHz NR ACPR vs DSA at 2.6 GHz

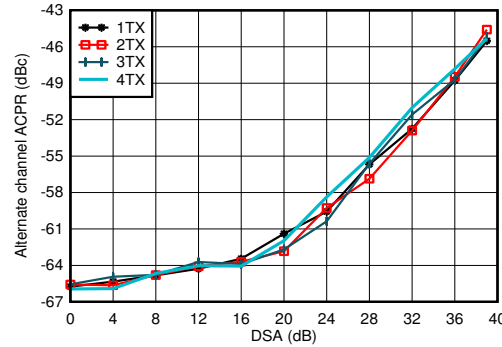

Matching at 2.6 GHz, single carrier 100-MHz BW TM1.1 NR

Figure 7-421. TX 100-MHz NR alt-ACPR vs DSA at 2.6 GHz

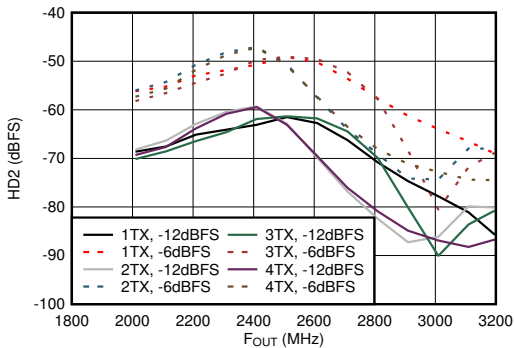

Matching at 2.6 GHz, $f_{\text{DAC}} = 11.79648$ GSPS, interleave mode, normalized to output power at harmonic frequency

Figure 7-422. TX HD2 vs Digital Amplitude and Output Frequency at 2.6 GHz

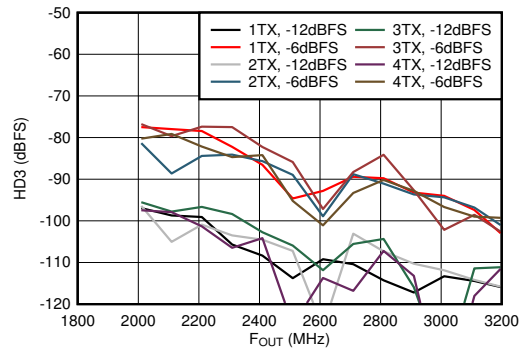

Matching at 2.6 GHz, $f_{\text{DAC}} = 11.79648$ GSPS, interleave mode, normalized to output power at harmonic frequency

Figure 7-423. TX HD3 vs Digital Amplitude and Output Frequency at 2.6 GHz

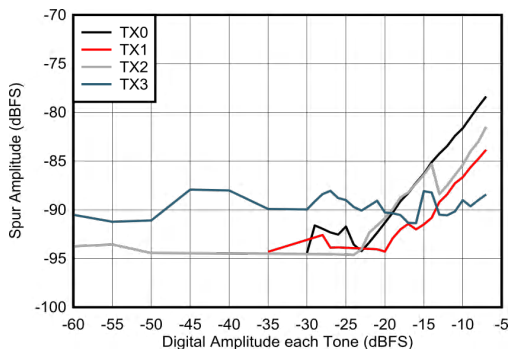

Inband = 2600 MHz \pm 600 MHz, $f_{\text{DAC}} = 12$ GSPS, not including $F_s/3$ and $F_s/4$, external clock mode, non-interleave mode

Figure 7-424. Two Tone Inband SFDR vs Digital Amplitude at 2.6 GHz

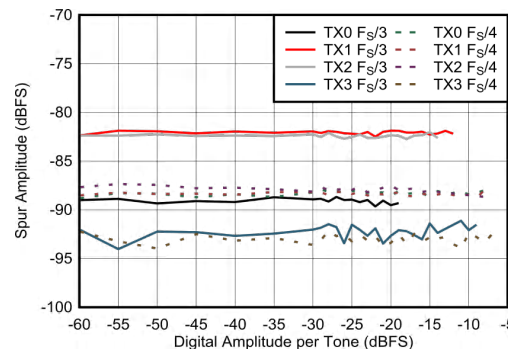

Inband = 2600 MHz \pm 600 MHz, $f_{\text{DAC}} = 12$ GSPS, external clock mode, non-interleave mode

Figure 7-425. Two Tone Inband Fixed Spurs vs Digital Amplitude at 2.6 GHz

7.12.11 TX Typical Characteristics at 2.6 GHz (continued)

Typical values at $T_A = +25^\circ\text{C}$ with nominal supplies. Unless otherwise noted, TX input data rate = 491.52 MSPS, $f_{\text{DAC}} = 11796.48$ MSPS, interleave mode, $A_{\text{OUT}} = -1$ dBFS, 1st Nyquist zone output, Internal PLL, $f_{\text{REF}} = 491.52$ MSPS, 24x Interpolation, DSA = 0 dB, Sin(x)/x enabled, DSA calibrated.

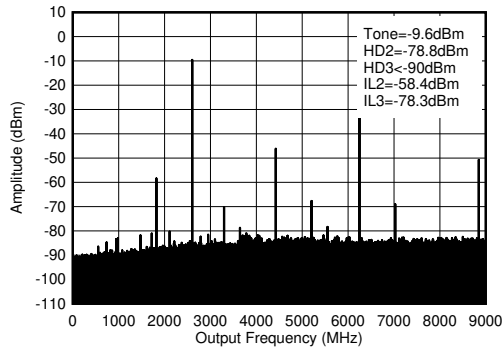

$f_{\text{DAC}} = 8847.36$ MSPS, interleave mode, 2.6 GHz matching, includes PCB and cable losses. $\text{IL}_n = f_s/n \pm f_{\text{OUT}}$.

Figure 7-426. TX Single Tone (-12 dBFS) Output Spectrum at 2.6 GHz ($0-f_{\text{DAC}}$)

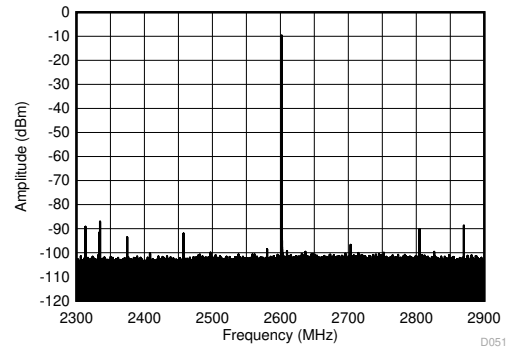

$f_{\text{DAC}} = 8847.36$ MSPS, interleave mode, 2.6 GHz matching, includes PCB and cable losses

Figure 7-427. TX Single Tone (-12 dBFS) Output Spectrum at 2.6 GHz (± 300 MHz)

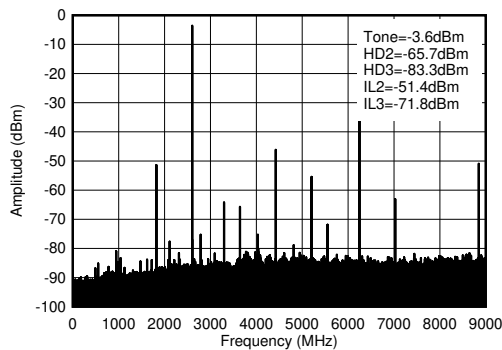

$f_{\text{DAC}} = 8847.36$ MSPS, interleave mode, 2.6 GHz matching, includes PCB and cable losses. $\text{IL}_n = f_s/n \pm f_{\text{OUT}}$.

Figure 7-428. TX Single Tone (-6 dBFS) Output Spectrum at 2.6 GHz ($0-f_{\text{DAC}}$)

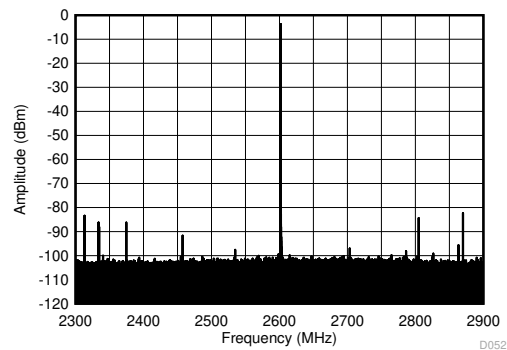

$f_{\text{DAC}} = 8847.36$ MSPS, interleave mode, 2.6 GHz matching, includes PCB and cable losses

Figure 7-429. TX Single Tone (-6 dBFS) Output Spectrum at 2.6 GHz (± 300 MHz)

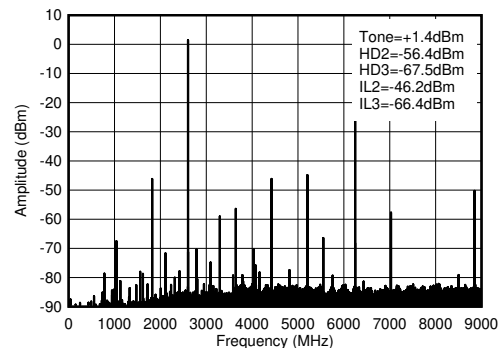

$f_{\text{DAC}} = 8847.36$ MSPS, interleave mode, 2.6 GHz matching, includes PCB and cable losses. $\text{IL}_n = f_s/n \pm f_{\text{OUT}}$.

Figure 7-430. TX Single Tone (-1 dBFS) Output Spectrum at 2.6 GHz ($0-f_{\text{DAC}}$)

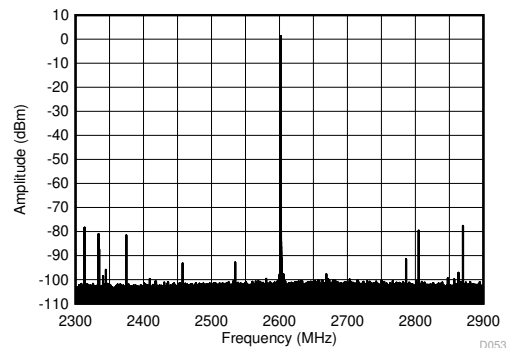

$f_{\text{DAC}} = 8847.36$ MSPS, interleave mode, 2.6 GHz matching, includes PCB and cable losses

Figure 7-431. TX Single Tone (-1 dBFS) Output Spectrum at 2.6 GHz (± 300 MHz)

7.12.11 TX Typical Characteristics at 2.6 GHz (continued)

Typical values at $T_A = +25^\circ\text{C}$ with nominal supplies. Unless otherwise noted, TX input data rate = 491.52 MSPS, $f_{\text{DAC}} = 11796.48$ MSPS, interleave mode, $A_{\text{OUT}} = -1$ dBFS, 1st Nyquist zone output, Internal PLL, $f_{\text{REF}} = 491.52$ MSPS, 24x Interpolation, DSA = 0 dB, Sin(x)/x enabled, DSA calibrated.

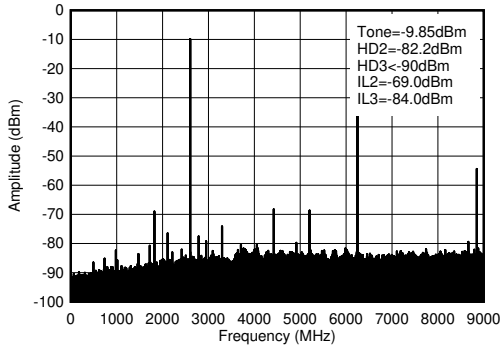

$f_{\text{DAC}} = 8847.36$ MSPS, straight mode, 2.6 GHz matching, includes PCB and cable losses. $\text{IL}_n = f_s/n \pm f_{\text{OUT}}$ and is due to mixing with digital clocks.

Figure 7-432. TX Single Tone (-12 dBFS) Output Spectrum at 2.6 GHz ($0-f_{\text{DAC}}$)

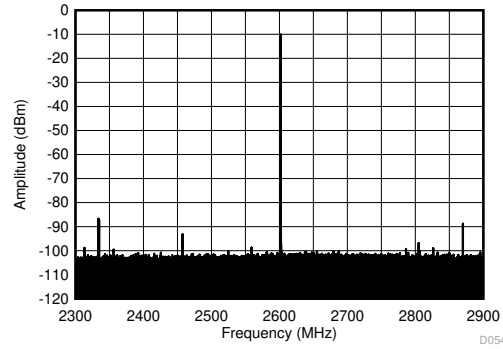

$f_{\text{DAC}} = 8847.36$ MSPS, straight mode, 2.6 GHz matching, includes PCB and cable losses

Figure 7-433. TX Single Tone (-12 dBFS) Output Spectrum at 2.6 GHz (± 300 MHz)

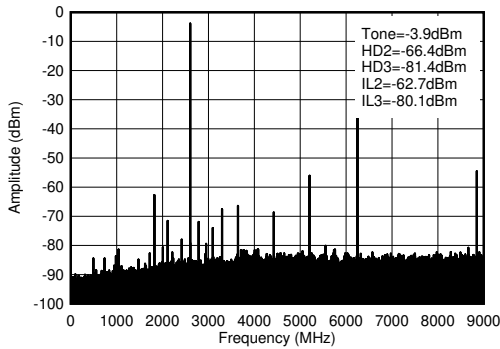

$f_{\text{DAC}} = 8847.36$ MSPS, straight mode, 2.6 GHz matching, includes PCB and cable losses. $\text{IL}_n = f_s/n \pm f_{\text{OUT}}$ and is due to mixing with digital clocks.

Figure 7-434. TX Single Tone (-6 dBFS) Output Spectrum at 2.6 GHz ($0-f_{\text{DAC}}$)

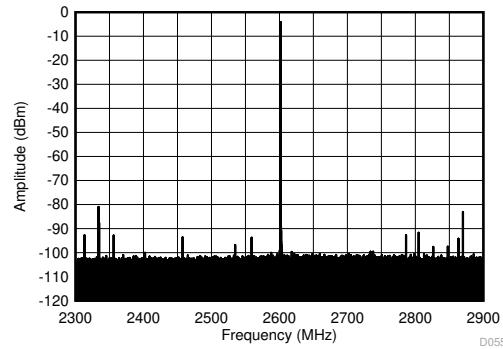

$f_{\text{DAC}} = 8847.36$ MSPS, straight mode, 2.6 GHz matching, includes PCB and cable losses

Figure 7-435. TX Single Tone (-6 dBFS) Output Spectrum at 2.6 GHz (± 300 MHz)

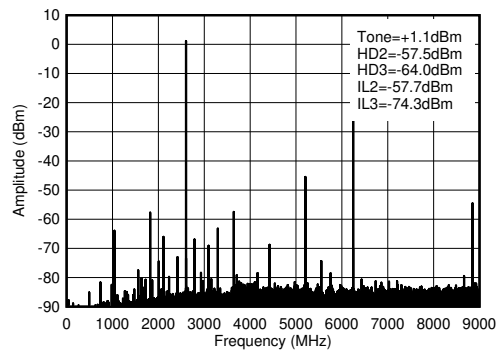

$f_{\text{DAC}} = 8847.36$ MSPS, straight mode, 2.6 GHz matching, includes PCB and cable losses. $\text{IL}_n = f_s/n \pm f_{\text{OUT}}$ and is due to mixing with digital clocks.

Figure 7-436. TX Single Tone (-1 dBFS) Output Spectrum at 2.6 GHz ($0-f_{\text{DAC}}$)

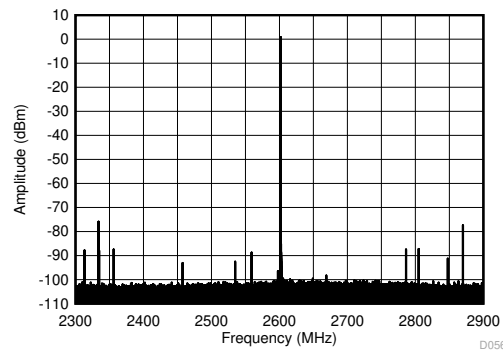

$f_{\text{DAC}} = 8847.36$ MSPS, straight mode, 2.6 GHz matching, includes PCB and cable losses

Figure 7-437. TX Single Tone (-1 dBFS) Output Spectrum at 2.6 GHz (± 300 MHz)

7.12.11 TX Typical Characteristics at 2.6 GHz (continued)

Typical values at $T_A = +25^\circ\text{C}$ with nominal supplies. Unless otherwise noted, TX input data rate = 491.52 MSPS, $f_{\text{DAC}} = 11796.48$ MSPS, interleave mode, $A_{\text{OUT}} = -1$ dBFS, 1st Nyquist zone output, Internal PLL, $f_{\text{REF}} = 491.52$ MSPS, 24x Interpolation, DSA = 0 dB, Sin(x)/x enabled, DSA calibrated.

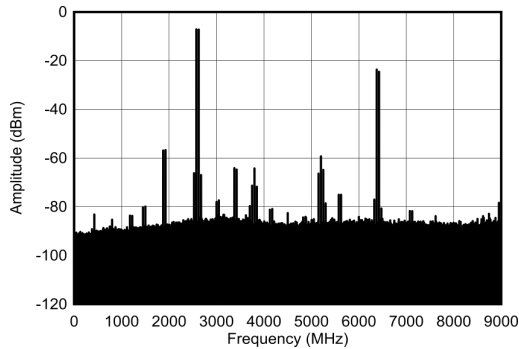

$f_{\text{DAC}} = 9000$ MSPS, external clock mode, non-interleave mode

Figure 7-438. TX Dual Tone Output Spectrum at 2.6 GHz, -7 dBFS each (0 - D_{DAC})

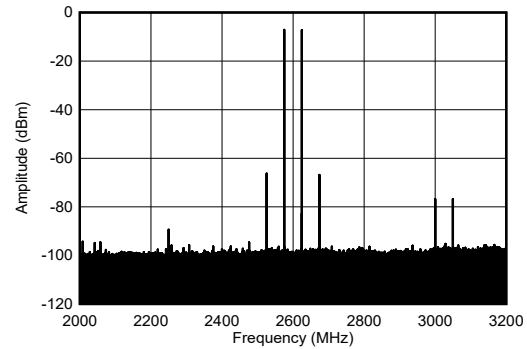

$f_{\text{DAC}} = 9000$ MSPS, external clock mode, non-interleave mode

Figure 7-439. TX Dual Tone Output Spectrum at 2.6 GHz, -7 dBFS each (± 600 MHz)

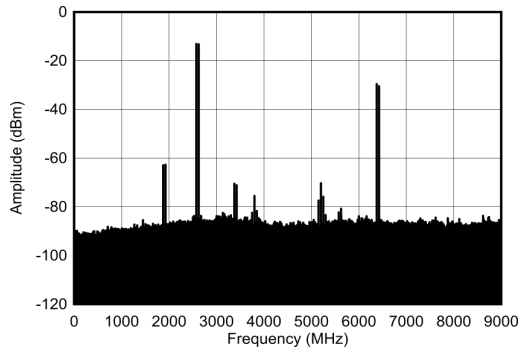

$f_{\text{DAC}} = 9000$ MSPS, external clock mode, non-interleave mode

Figure 7-440. TX Dual Tone Output Spectrum at 2.6 GHz, -13 dBFS each (0 - D_{DAC})

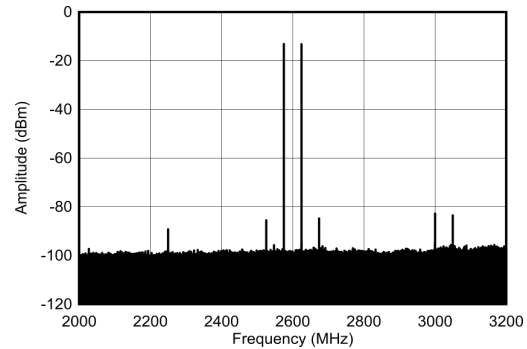

$f_{\text{DAC}} = 9000$ MSPS, external clock mode, non-interleave mode

Figure 7-441. TX Dual Tone Output Spectrum at 2.6 GHz, -13dBFS each (± 600 MHz)

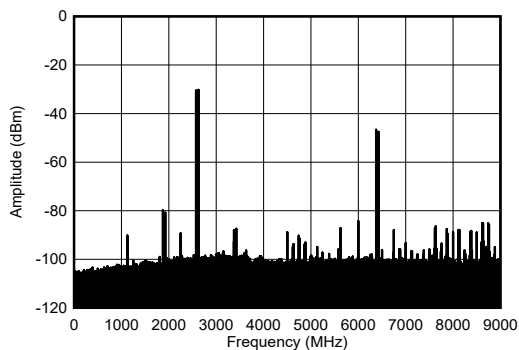

$f_{\text{DAC}} = 9000$ MSPS, external clock mode, non-interleave mode

Figure 7-442. TX Dual Tone Output Spectrum at 2.6 GHz, -30 dBFS each (0 - D_{DAC})

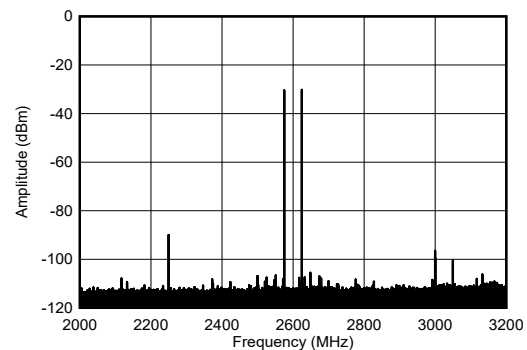

$f_{\text{DAC}} = 9000$ MSPS, external clock mode, non-interleave mode

Figure 7-443. TX Dual Tone Output Spectrum at 2.6 GHz, -30 dBFS each (± 600 MHz)

7.12.11 TX Typical Characteristics at 2.6 GHz (continued)

Typical values at $T_A = +25^\circ\text{C}$ with nominal supplies. Unless otherwise noted, TX input data rate = 491.52 MSPS, $f_{\text{DAC}} = 11796.48$ MSPS, interleave mode, $A_{\text{OUT}} = -1$ dBFS, 1st Nyquist zone output, Internal PLL, $f_{\text{REF}} = 491.52$ MSPS, 24x Interpolation, DSA = 0 dB, Sin(x)/x enabled, DSA calibrated.

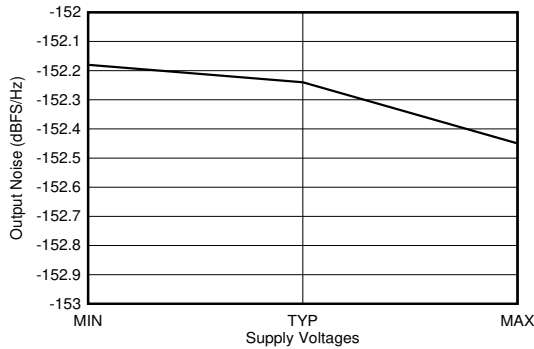

$f_{\text{DAC}} = 11796.48$ MSPS, interleave mode, 2.6 GHz matching. 40-MHz offset from tone. Output Power = -1 dBFS. All supplies simultaneously at MIN, TYP, or MAX voltages.

Figure 7-444. TX Output Noise vs Supply Voltage at 2.6 GHz

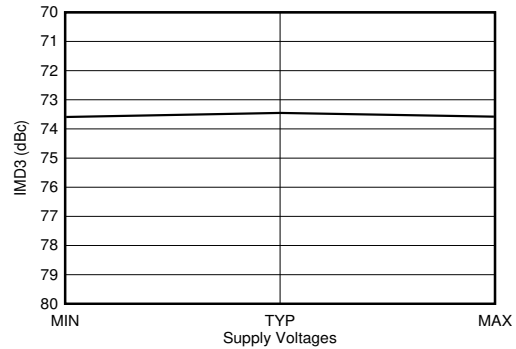

$f_{\text{DAC}} = 11796.48$ MSPS, interleave mode, 2.6 GHz matching. 40-MHz offset from tone. Output Power = -13 dBFS. All supplies simultaneously at MIN, TYP, or MAX voltages.

Figure 7-445. TX IMD3 vs Supply Voltage at 2.6 GHz

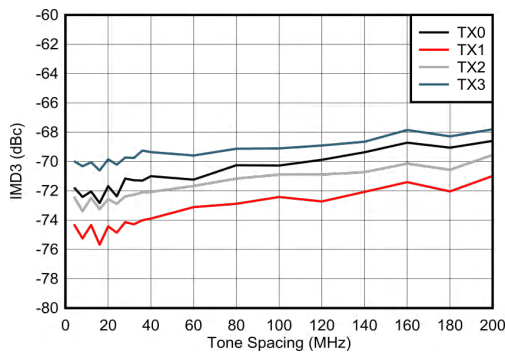

$f_{\text{DAC}} = 9000$ MSPS, non-interleave mode, external clock mode

Figure 7-446. IMD3 vs Tone Spacing and Channel at 2.6 GHz

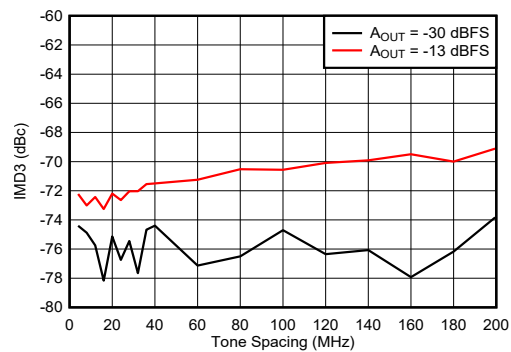

$f_{\text{DAC}} = 9000$ MSPS, non-interleave mode, external clock mode

Figure 7-447. IMD3 vs Tone Spacing and Amplitude at 2.6 GHz

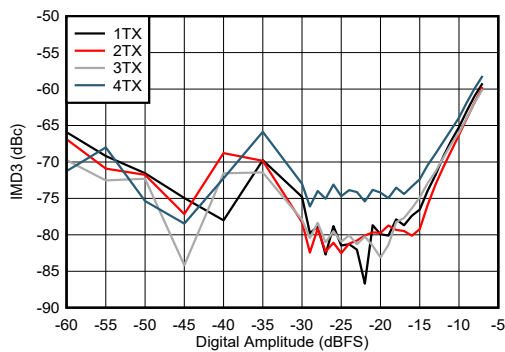

$f_{\text{DAC}} = 9000$ MSPS, non-interleave mode, external clock mode

Figure 7-448. IMD3 vs Digital Amplitude and Channel at 2.6 GHz

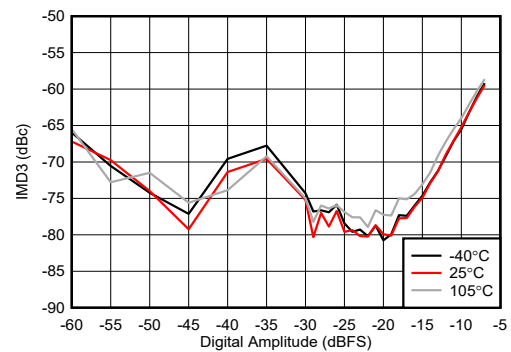

$f_{\text{DAC}} = 9000$ MSPS, non-interleave mode, external clock mode

Figure 7-449. IMD3 vs Digital Amplitude and Temperature at 2.6 GHz

7.12.11 TX Typical Characteristics at 2.6 GHz (continued)

Typical values at $T_A = +25^\circ\text{C}$ with nominal supplies. Unless otherwise noted, TX input data rate = 491.52 MSPS, $f_{\text{DAC}} = 11796.48$ MSPS, interleave mode, $A_{\text{OUT}} = -1$ dBFS, 1st Nyquist zone output, Internal PLL, $f_{\text{REF}} = 491.52$ MSPS, 24x Interpolation, DSA = 0 dB, $\text{Sin}(x)/x$ enabled, DSA calibrated.

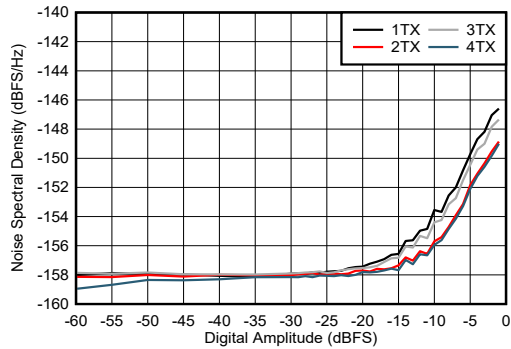

$f_{\text{DAC}} = 9000$ MSPS, non-interleave mode, external clock mode, 50MHz offset

Figure 7-450. NSD vs Digital Amplitude and Channel at 2.6 GHz

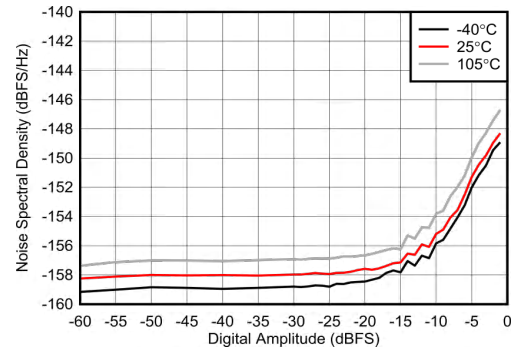

$f_{\text{DAC}} = 9000$ MSPS, non-interleave mode, external clock mode, 50MHz offset

Figure 7-451. NSD vs Digital Amplitude and Temperature at 2.6 GHz

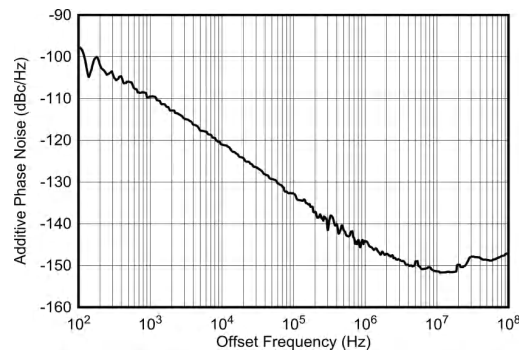

$f_{\text{DAC}} = f_{\text{CLK}} = 9000$ MSPS, non-interleave mode

Figure 7-452. External Clock Additive Phase Noise at 2.6 GHz

7.12.12 TX Typical Characteristics at 3.5 GHz

Typical values at $T_A = +25^\circ\text{C}$ with nominal supplies. Unless otherwise noted, TX input data rate = 491.52 MSPS, $f_{\text{DAC}} = 11796.48$ MSPS, interleave mode, $A_{\text{OUT}} = -1$ dBFS, 1st Nyquist zone output, Internal PLL, $f_{\text{REF}} = 491.52$ MSPS, 24x Interpolation, DSA = 0 dB, Sin(x)/x enabled, DSA calibrated.

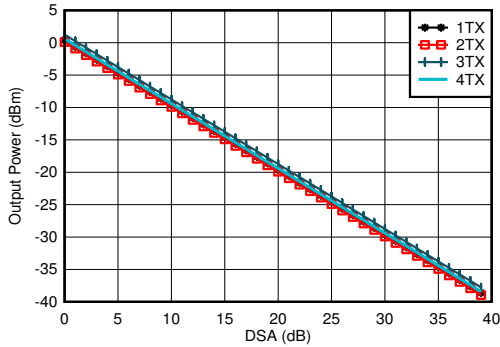

$A_{\text{out}} = -0.5$ dBFS, 3.5 GHz Matching, included PCB and cable losses

Figure 7-453. TX Output Power vs DSA Setting at 3.5 GHz

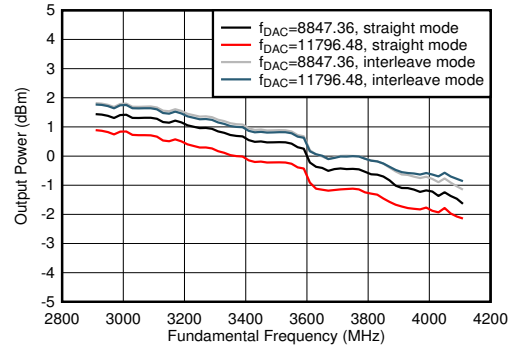

$A_{\text{out}} = -0.5$ dBFS, 3.5 GHz Matching, included PCB and cable losses

Figure 7-454. TX Output Power vs Frequency

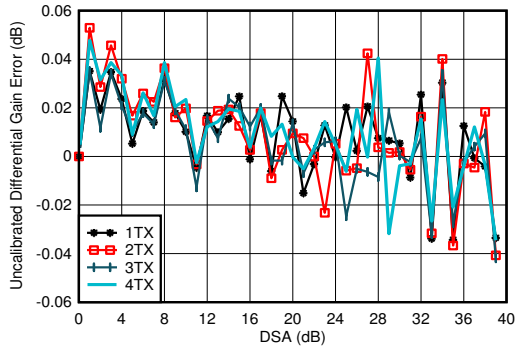

3.5 GHz Matching, included PCB and cable losses
Differential Gain Error = $P_{\text{OUT}}(\text{DSA Setting} - 1) - P_{\text{OUT}}(\text{DSA Setting}) + 1$

Figure 7-455. TX Uncalibrated Differential Gain Error vs DSA Setting and Channel at 3.5 GHz

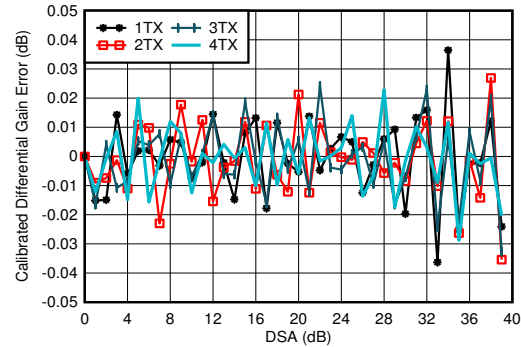

3.5 GHz Matching, included PCB and cable losses
Differential Gain Error = $P_{\text{OUT}}(\text{DSA Setting} - 1) - P_{\text{OUT}}(\text{DSA Setting}) + 1$

Figure 7-456. TX Calibrated Differential Gain Error vs DSA Setting and Channel at 3.5 GHz

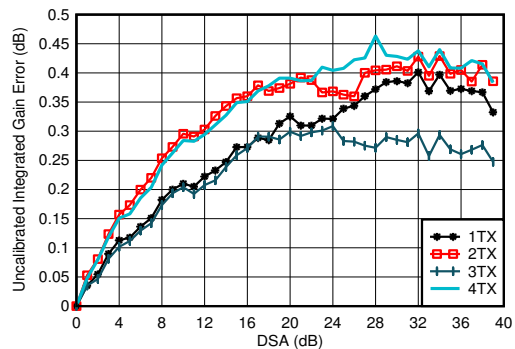

3.5 GHz Matching, included PCB and cable losses
Integrated Gain Error = $P_{\text{OUT}}(\text{DSA Setting}) - P_{\text{OUT}}(\text{DSA Setting} = 0) + (\text{DSA Setting})$

Figure 7-457. TX Uncalibrated Integrated Gain Error vs DSA Setting and Channel at 3.5 GHz

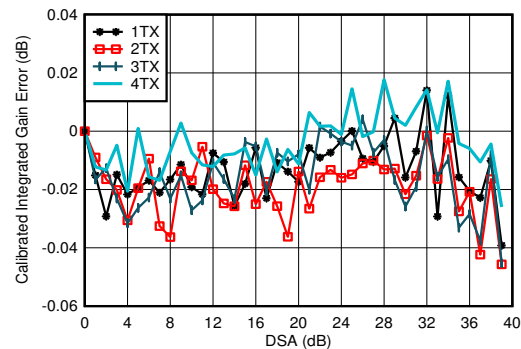

3.5 GHz Matching, included PCB and cable losses
Integrated Gain Error = $P_{\text{OUT}}(\text{DSA Setting}) - P_{\text{OUT}}(\text{DSA Setting} = 0) + (\text{DSA Setting})$

Figure 7-458. TX Calibrated Integrated Gain Error vs DSA Setting and Channel at 3.5 GHz

7.12.12 TX Typical Characteristics at 3.5 GHz (continued)

Typical values at $T_A = +25^\circ\text{C}$ with nominal supplies. Unless otherwise noted, TX input data rate = 491.52 MSPS, $f_{\text{DAC}} = 11796.48$ MSPS, interleave mode, $A_{\text{OUT}} = -1$ dBFS, 1st Nyquist zone output, Internal PLL, $f_{\text{REF}} = 491.52$ MSPS, 24x Interpolation, DSA = 0 dB, Sin(x)/x enabled, DSA calibrated.

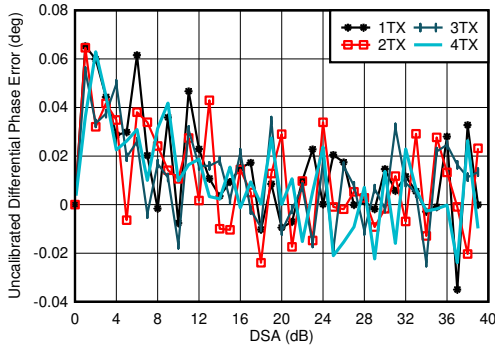

3.5 GHz Matching, included PCB and cable losses
 Differential Phase Error = $\text{Phase}_{\text{OUT}}(\text{DSA Setting} - 1) - \text{Phase}_{\text{OUT}}(\text{DSA Setting})$

Figure 7-459. TX Uncalibrated Differential Phase Error vs DSA Setting and Channel at 3.5 GHz

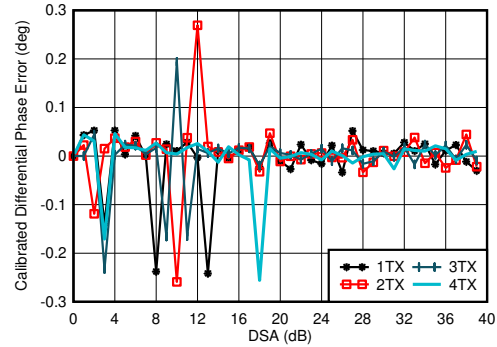

3.5 GHz Matching, included PCB and cable losses
 Differential Phase Error = $\text{Phase}_{\text{OUT}}(\text{DSA Setting} - 1) - \text{Phase}_{\text{OUT}}(\text{DSA Setting})$. Phase DNL spike may occur at any DSA setting.

Figure 7-460. TX Calibrated Differential Phase Error vs DSA Setting and Channel at 3.5 GHz

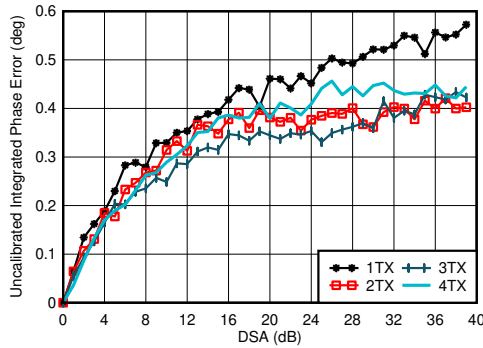

3.5 GHz Matching, included PCB and cable losses
 Integrated Phase Error = $\text{Phase}(\text{DSA Setting}) - \text{Phase}(\text{DSA Setting} = 0)$

Figure 7-461. TX Uncalibrated Integrated Phase Error vs DSA Setting and Channel at 3.5 GHz

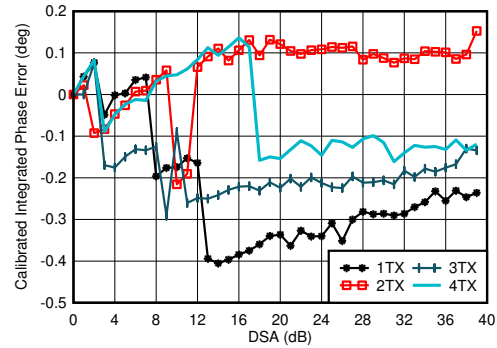

3.5 GHz Matching, included PCB and cable losses
 Integrated Phase Error = $\text{Phase}(\text{DSA Setting}) - \text{Phase}(\text{DSA Setting} = 0)$

Figure 7-462. TX Calibrated Integrated Phase Error vs DSA Setting and Channel at 3.5 GHz

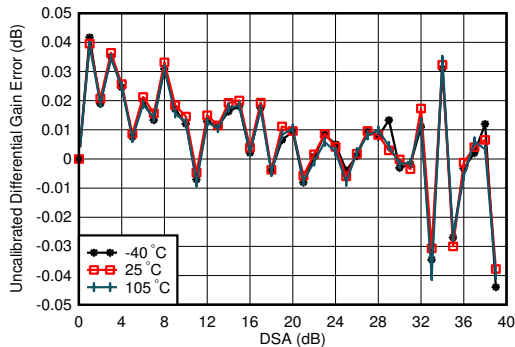

3.5 GHz Matching, 1TX
 Differential Phase Error = $\text{Phase}_{\text{OUT}}(\text{DSA Setting} - 1) - \text{Phase}_{\text{OUT}}(\text{DSA Setting})$

Figure 7-463. TX Uncalibrated Differential Gain Error vs DSA Setting and Temperature at 3.5 GHz

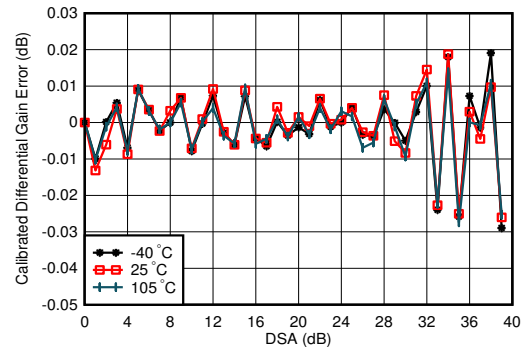

3.5 GHz Matching, 1TX, Calibrated at 25°C
 Differential Phase Error = $\text{Phase}_{\text{OUT}}(\text{DSA Setting} - 1) - \text{Phase}_{\text{OUT}}(\text{DSA Setting})$

Figure 7-464. TX Calibrated Differential Gain Error vs DSA Setting and Temperature at 3.5 GHz

7.12.12 TX Typical Characteristics at 3.5 GHz (continued)

Typical values at $T_A = +25^\circ\text{C}$ with nominal supplies. Unless otherwise noted, TX input data rate = 491.52 MSPS, $f_{\text{DAC}} = 11796.48$ MSPS, interleave mode, $A_{\text{OUT}} = -1$ dBFS, 1st Nyquist zone output, Internal PLL, $f_{\text{REF}} = 491.52$ MSPS, 24x Interpolation, DSA = 0 dB, Sin(x)/x enabled, DSA calibrated.

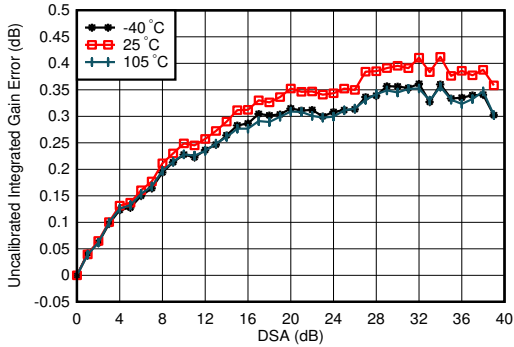

3.5 GHz Matching, 1TX
Integrated Phase Error = Phase(DSA Setting) – Phase(DSA Setting = 0)

Figure 7-465. TX Uncalibrated Integrated Gain Error vs DSA Setting and Temperature at 3.5 GHz

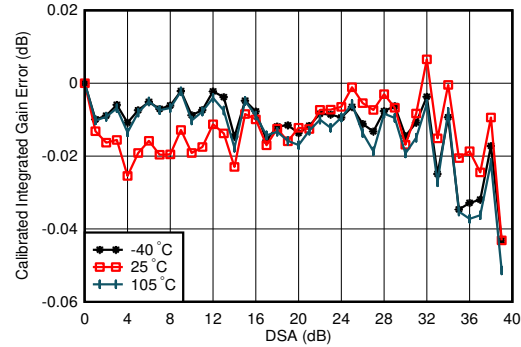

3.5 GHz Matching, 1TX, Calibrated at 25°C
Integrated Phase Error = Phase(DSA Setting) – Phase(DSA Setting = 0)

Figure 7-466. TX Calibrated Integrated Gain Error vs DSA Setting and Temperature at 3.5 GHz

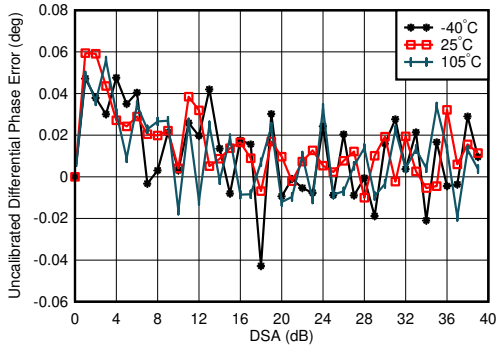

3.5 GHz Matching, 1TX
Differential Phase Error = Phase_{OUT}(DSA Setting – 1) – Phase_{OUT}(DSA Setting)

Figure 7-467. TX Uncalibrated Differential Phase Error vs DSA setting and Temperature at 3.5 GHz

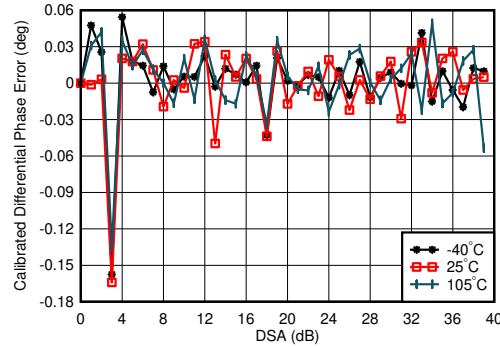

3.5 GHz Matching, 1TX, Calibrated at 25°C
Differential Phase Error = Phase_{OUT}(DSA Setting – 1) – Phase_{OUT}(DSA Setting)

Figure 7-468. TX Calibrated Differential Phase Error vs DSA Setting and Temperature at 3.5 GHz

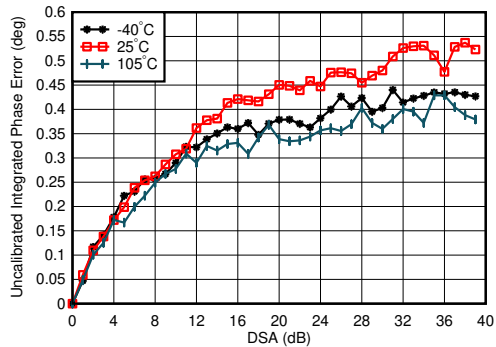

3.5 GHz Matching, 1TX
Integrated Phase Error = Phase(DSA Setting) – Phase(DSA Setting=0)

Figure 7-469. TX Uncalibrated Integrated Phase Error vs DSA Setting and Temperature at 3.5 GHz

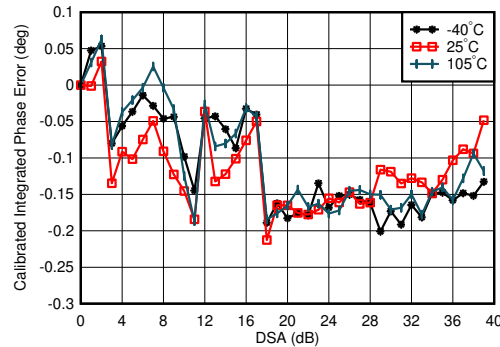

3.5 GHz Matching, 1TX, Calibrated at 25°C
Integrated Phase Error = Phase(DSA Setting) – Phase(DSA Setting = 0)

Figure 7-470. TX Calibrated Integrated Phase Error vs DSA Setting and Temperature at 3.5 GHz

7.12.12 TX Typical Characteristics at 3.5 GHz (continued)

Typical values at $T_A = +25^\circ\text{C}$ with nominal supplies. Unless otherwise noted, TX input data rate = 491.52 MSPS, $f_{\text{DAC}} = 11796.48$ MSPS, interleave mode, $A_{\text{OUT}} = -1$ dBFS, 1st Nyquist zone output, Internal PLL, $f_{\text{REF}} = 491.52$ MSPS, 24x Interpolation, DSA = 0 dB, Sin(x)/x enabled, DSA calibrated.

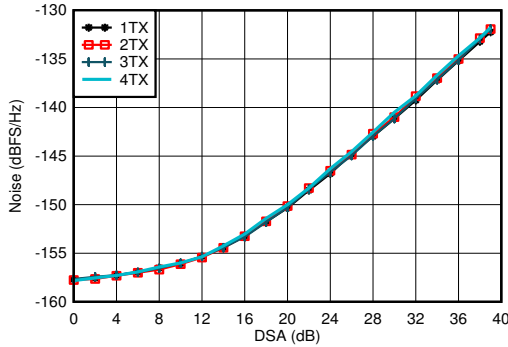

A. $f_{\text{DAC}} = 11796.48$ MSPS, interleave mode, matching at 3.5 GHz, $A_{\text{out}} = -13$ dBFS.

Figure 7-471. TX NSD vs DSA Setting at 3.5 GHz

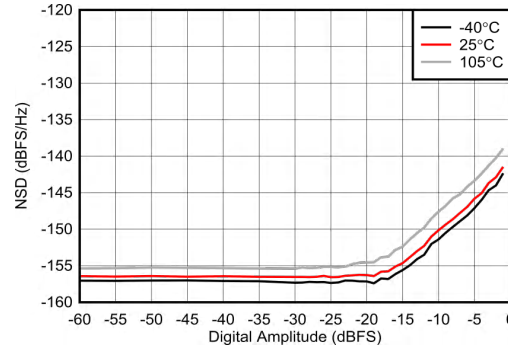

A. $f_{\text{DAC}} = 12$ MSPS, external clock mode, non-interleave mode

Figure 7-472. TX NSD vs Digital Amplitude and Temperature at 3.75 GHz

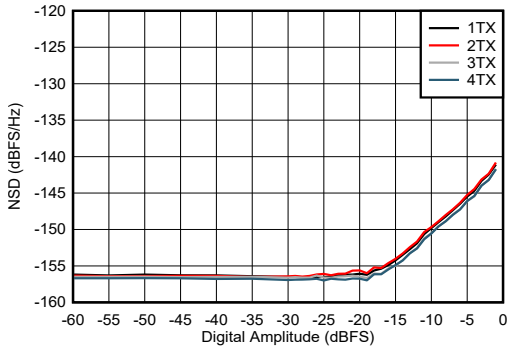

A. $f_{\text{DAC}} = 12$ MSPS, external clock mode, non-interleave mode

Figure 7-473. TX NSD vs Digital Amplitude and Channel at 3.75 GHz

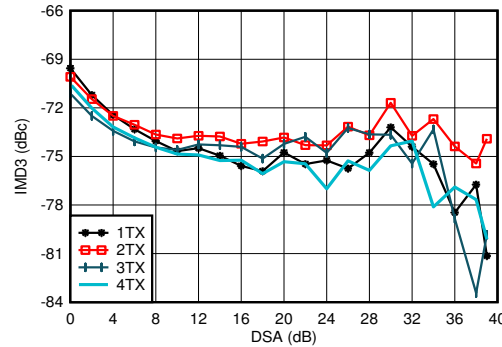

20-MHz tone spacing, 3.5 GHz Matching, -13 dBFS each tone, included PCB and cable losses

Figure 7-474. TX IMD3 vs DSA Setting at 3.5 GHz

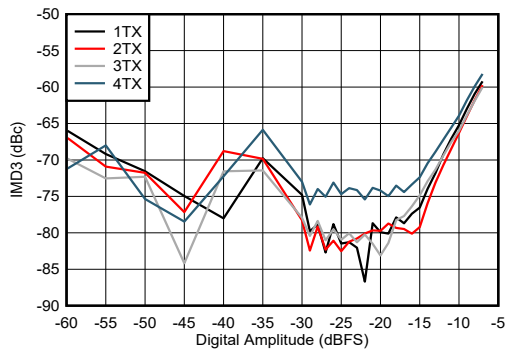

20-MHz tone spacing, 3.5 GHz Matching

Figure 7-475. TX IMD3 vs Digital Amplitude and Channel at 3.5 GHz

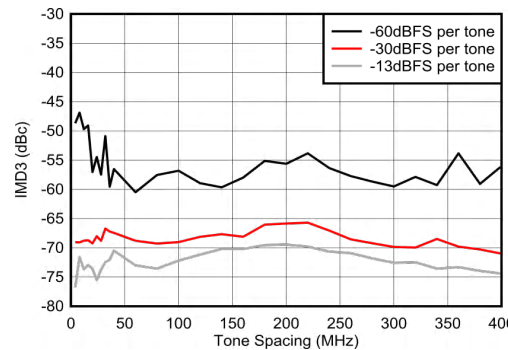

50-MHz tone spacing, external clock mode, non-interleave mode

Figure 7-476. TX IMD3 vs Tone Spacing and Amplitude at 3.75 GHz

7.12.12 TX Typical Characteristics at 3.5 GHz (continued)

Typical values at $T_A = +25^\circ\text{C}$ with nominal supplies. Unless otherwise noted, TX input data rate = 491.52 MSPS, $f_{DAC} = 11796.48$ MSPS, interleave mode, $A_{OUT} = -1$ dBFS, 1st Nyquist zone output, Internal PLL, $f_{REF} = 491.52$ MSPS, 24x Interpolation, DSA = 0 dB, Sin(x)/x enabled, DSA calibrated.

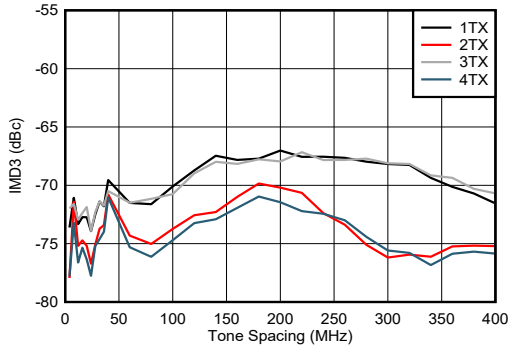

External clock mode, non-interleave mode

Figure 7-477. TX IMD3 vs Tone Spacing and Channel at 3.75 GHz

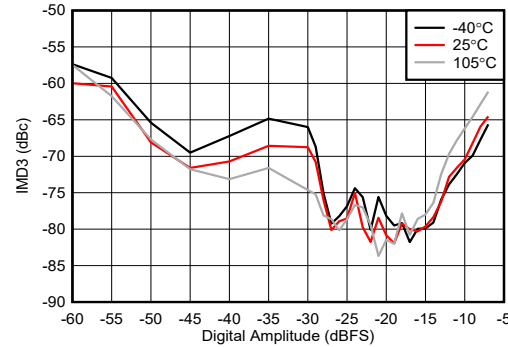

50-MHz tone spacing, external clock mode, non-interleave mode

Figure 7-478. TX IMD3 vs Digital Amplitude and Temperature at 3.75 GHz

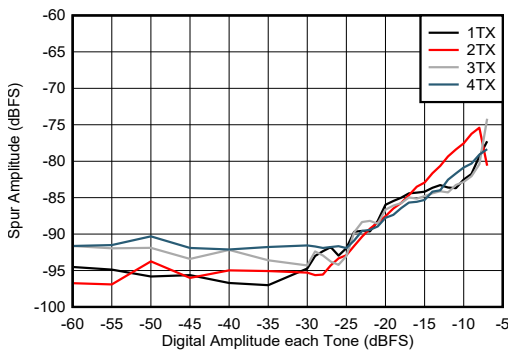

Inband = 3.75 GHz \pm 600 MHz, $f_{DAC} = 9$ GSPS, external clock mode, non-interleave mode.

Figure 7-479. Two Tone Inband SFDR vs Digital Amplitude at 3.75 GHz

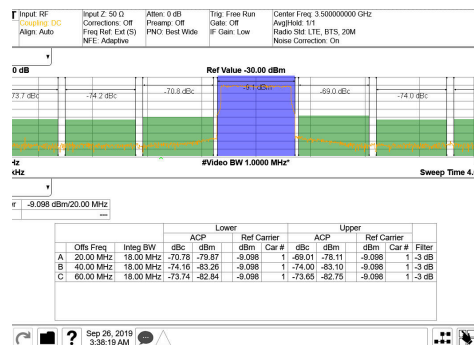

3.5 GHz Matching, single carrier 20-MHz BW TM1.1 LTE

Figure 7-480. TX 20-MHz LTE Output Spectrum at 3.5 GHz (Band 42)

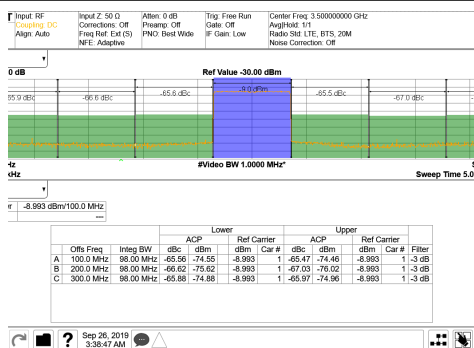

3.5 GHz Matching, single carrier 100-MHz BW NR TM1.1

Figure 7-481. TX 100-MHz NR Output Spectrum at 3.5 GHz (Band 42)

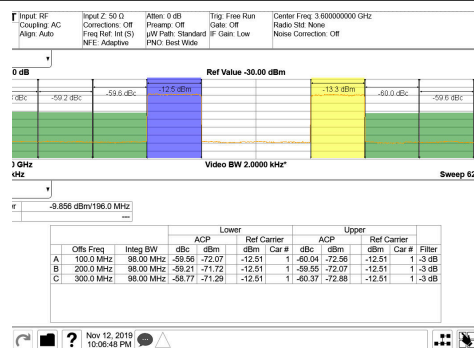

3.5 GHz Matching, single carrier 100-MHz BW NR TM1.1

Figure 7-482. TX 2 carrier 100-MHz NR Output Spectrum at 3.45 GHz and 3.75 GHz

7.12.12 TX Typical Characteristics at 3.5 GHz (continued)

Typical values at $T_A = +25^\circ\text{C}$ with nominal supplies. Unless otherwise noted, TX input data rate = 491.52 MSPS, $f_{\text{DAC}} = 11796.48$ MSPS, interleave mode, $A_{\text{OUT}} = -1$ dBFS, 1st Nyquist zone output, Internal PLL, $f_{\text{REF}} = 491.52$ MSPS, 24x Interpolation, DSA = 0 dB, Sin(x)/x enabled, DSA calibrated.

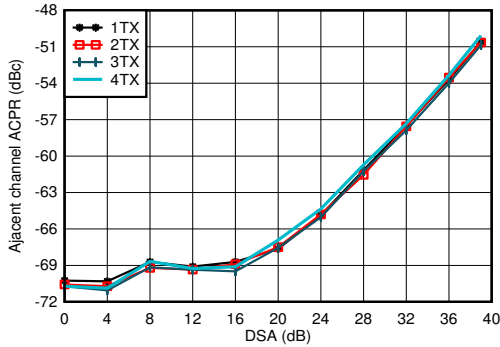

3.5 GHz Matching, single carrier 20-MHz BW NR TM1.1 LTE

Figure 7-483. TX 20-MHz LTE ACPR vs DSA Setting at 3.5 GHz

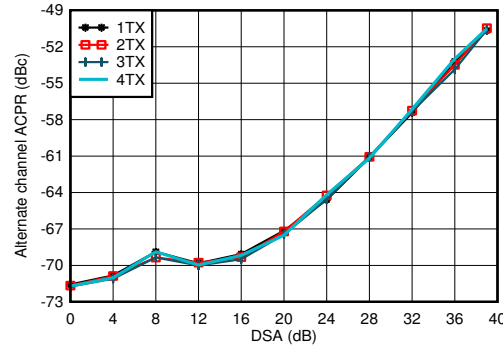

3.5 GHz Matching, single carrier 20-MHz BW NR TM1.1 LTE

Figure 7-484. TX 20-MHz LTE alt-ACPR vs DSA Setting at 3.5 GHz

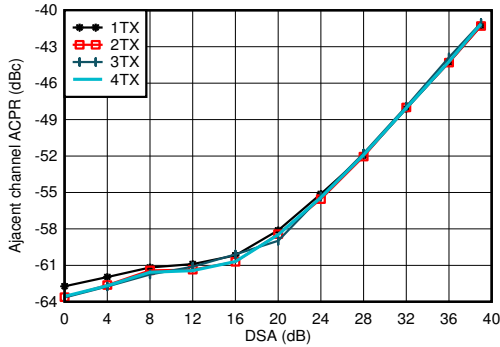

3.5 GHz Matching, single carrier 100-MHz BW NR TM1.1

Figure 7-485. TX 100-MHz NR ACPR vs DSA Setting at 3.5 GHz

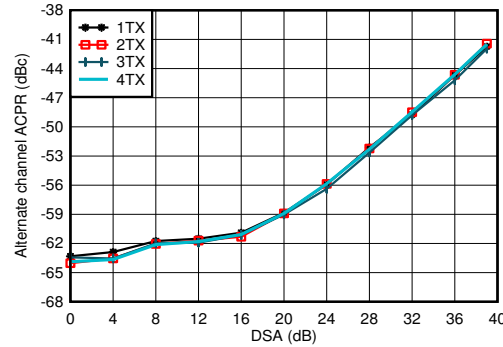

3.5 GHz Matching, single carrier 100-MHz BW NR TM1.1

Figure 7-486. TX 100-MHz NR alt-ACPR vs DSA Setting at 3.5 GHz

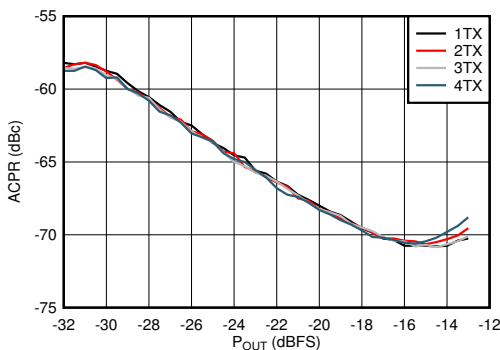

3.5 GHz Matching, single carrier 20-MHz BW TM1.1 LTE

Figure 7-487. TX 20-MHz LTE ACPR vs Digital Level at 3.5 GHz

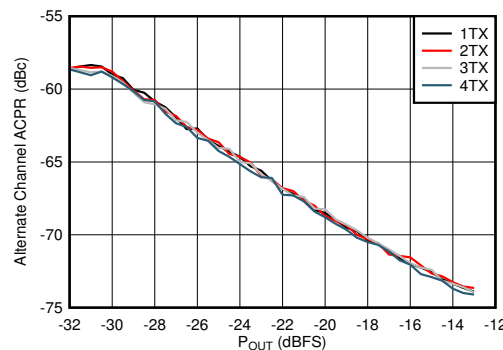

3.5 GHz Matching, single carrier 20-MHz BW TM1.1 LTE

Figure 7-488. TX 20-MHz LTE alt-ACPR vs Digital Level at 3.5 GHz

7.12.12 TX Typical Characteristics at 3.5 GHz (continued)

Typical values at $T_A = +25^\circ\text{C}$ with nominal supplies. Unless otherwise noted, TX input data rate = 491.52 MSPS, $f_{\text{DAC}} = 11796.48$ MSPS, interleave mode, $A_{\text{OUT}} = -1$ dBFS, 1st Nyquist zone output, Internal PLL, $f_{\text{REF}} = 491.52$ MSPS, 24x Interpolation, DSA = 0 dB, Sin(x)/x enabled, DSA calibrated.

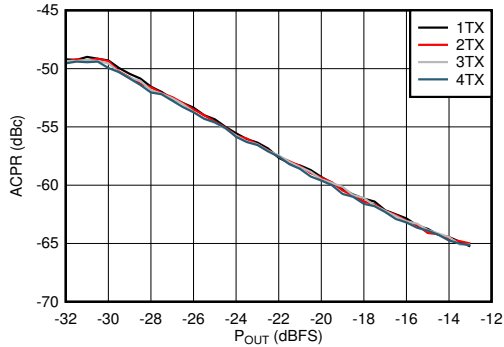

3.5 GHz Matching, single carrier 100-MHz BW NR TM1.1

Figure 7-489. TX 100-MHz NR ACPR vs Digital Level at 3.5 GHz

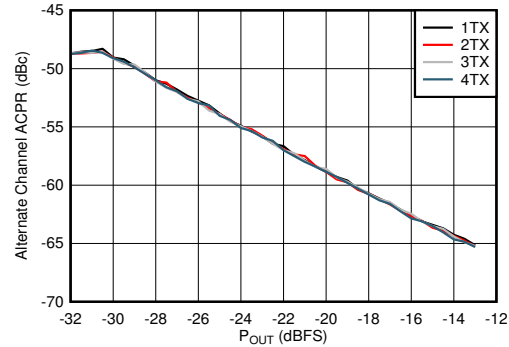

3.5 GHz Matching, single carrier 100-MHz BW NR TM1.1

Figure 7-490. TX 100-MHz NR alt-ACPR vs Digital Level at 3.5 GHz

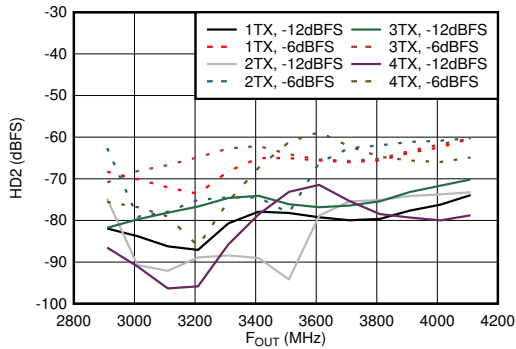

Matching at 3.5 GHz, $f_{\text{DAC}} = 11.79648$ GSPS, interleave mode, normalized to output power at harmonic frequency

Figure 7-491. TX Single Tone HD2 vs Frequency and Digital Level at 3.5 GHz

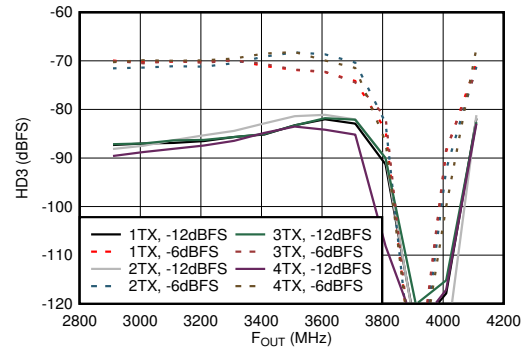

Matching at 3.5 GHz, $f_{\text{DAC}} = 11.79648$ GSPS, interleave mode, normalized to output power at harmonic frequency. Dip is due to HD3 falling near DC.

Figure 7-492. TX Single Tone HD3 vs Frequency and Digital Level at 3.5 GHz

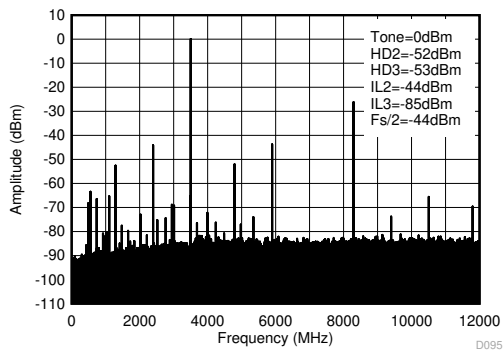

Matching at 3.5 GHz, $f_{\text{DAC}} = 11.79648$ GSPS, interleave mode.

Figure 7-493. TX Single Tone (-1 dBFS) Output Spectrum at 3.5 GHz (0 - f_{DAC})

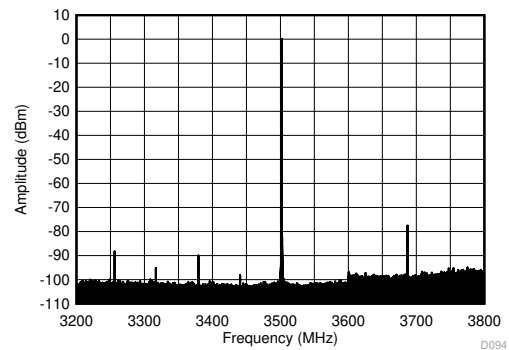

Matching at 3.5 GHz, $f_{\text{DAC}} = 11.79648$ GSPS, interleave mode.

Figure 7-494. TX Single Tone (-1 dBFS) Output Spectrum at 3.5 GHz (± 300 MHz)

7.12.12 TX Typical Characteristics at 3.5 GHz (continued)

Typical values at $T_A = +25^\circ\text{C}$ with nominal supplies. Unless otherwise noted, TX input data rate = 491.52 MSPS, $f_{\text{DAC}} = 11796.48$ MSPS, interleave mode, $A_{\text{OUT}} = -1$ dBFS, 1st Nyquist zone output, Internal PLL, $f_{\text{REF}} = 491.52$ MSPS, 24x Interpolation, DSA = 0 dB, Sin(x)/x enabled, DSA calibrated.

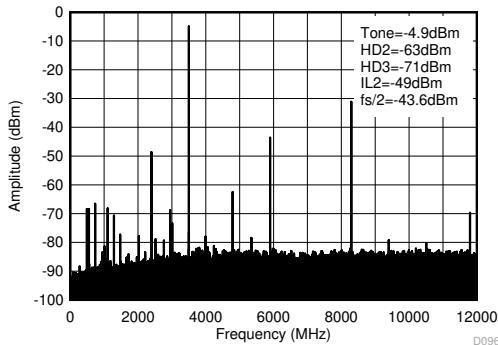

Matching at 3.5 GHz, $f_{\text{DAC}} = 11.79648$ GSPS, interleave mode.

Figure 7-495. TX Single Tone (-6 dBFS) Output Spectrum at 3.5 GHz (0- f_{DAC})

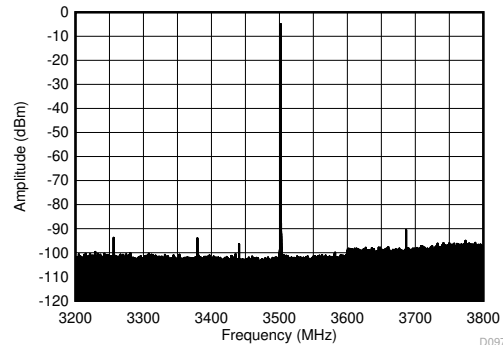

Matching at 3.5 GHz, $f_{\text{DAC}} = 11.79648$ GSPS, interleave mode.

Figure 7-496. TX Single Tone (-6 dBFS) Output Spectrum at 3.5 GHz (± 300 MHz)

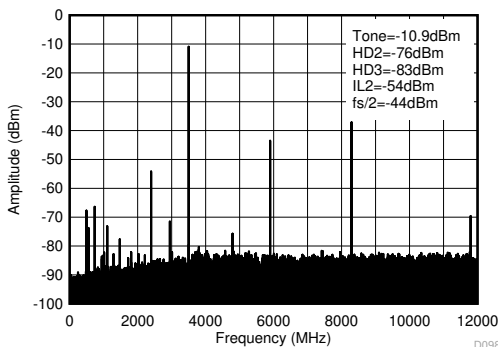

Matching at 3.5 GHz, $f_{\text{DAC}} = 11.79648$ GSPS, interleave mode.

Figure 7-497. TX Single Tone (-12 dBFS) Output Spectrum at 3.5 GHz (0- f_{DAC})

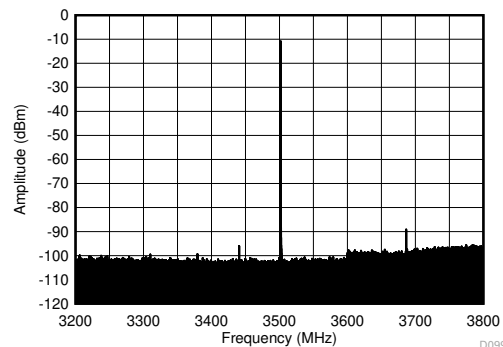

Matching at 3.5 GHz, $f_{\text{DAC}} = 11.79648$ GSPS, interleave mode.

Figure 7-498. TX Single Tone (-12 dBFS) Output Spectrum at 3.5 GHz (± 300 MHz)

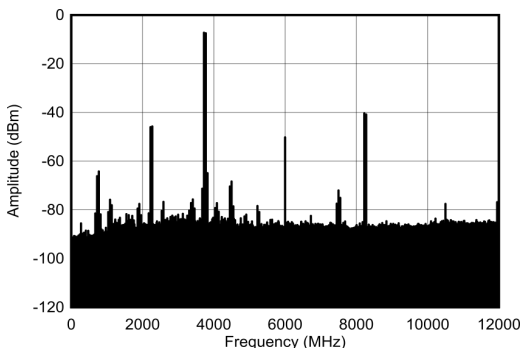

Matching at 3.5 GHz, 50 MHz tone spacing, $f_{\text{DAC}} = 12$ GSPS, non-interleave mode.

Figure 7-499. TX Dual Tone Output Spectrum at 3.75 GHz, -7 dBFS each (0 - f_{DAC})

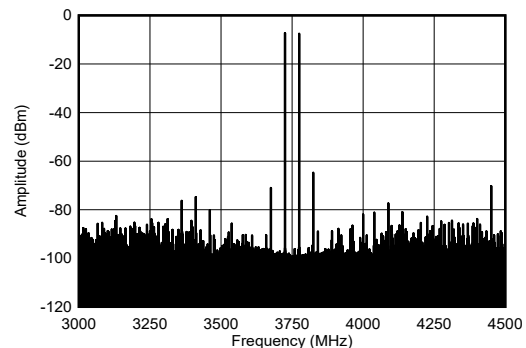

Matching at 3.5 GHz, 50 MHz tone spacing, $f_{\text{DAC}} = 12$ GSPS, non-interleave mode.

Figure 7-500. TX Dual Tone Output Spectrum at 3.75 GHz, -7 dBFS each (± 600 MHz)

7.12.12 TX Typical Characteristics at 3.5 GHz (continued)

Typical values at $T_A = +25^\circ\text{C}$ with nominal supplies. Unless otherwise noted, TX input data rate = 491.52 MSPS, $f_{\text{DAC}} = 11796.48$ MSPS, interleave mode, $A_{\text{OUT}} = -1$ dBFS, 1st Nyquist zone output, Internal PLL, $f_{\text{REF}} = 491.52$ MSPS, 24x Interpolation, DSA = 0 dB, Sin(x)/x enabled, DSA calibrated.

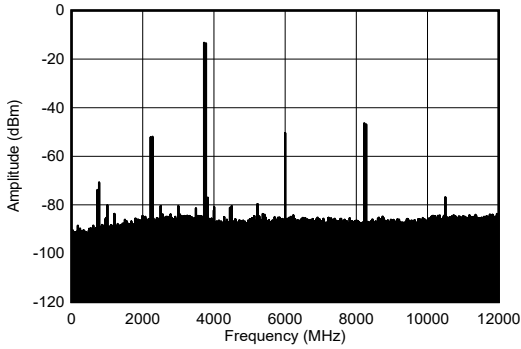

Matching at 3.5 GHz, 50 MHz tone spacing, $f_{\text{DAC}} = 12$ GSPS, non-interleave mode.

Figure 7-501. TX Dual Tone Output Spectrum at 3.75 GHz, -13 dBFS each ($0 - f_{\text{DAC}}$)

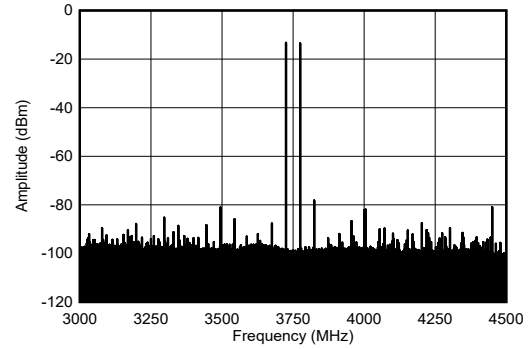

Matching at 3.5 GHz, 50 MHz tone spacing, $f_{\text{DAC}} = 12$ GSPS, non-interleave mode.

Figure 7-502. TX Dual Tone Output Spectrum at 3.75 GHz, -13 dBFS each (± 600 MHz)

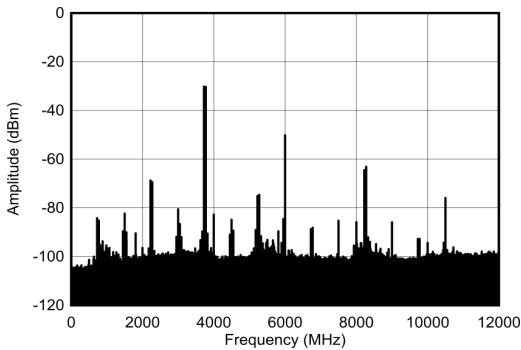

Matching at 3.5 GHz, 50 MHz tone spacing, $f_{\text{DAC}} = 12$ GSPS, non-interleave mode.

Figure 7-503. TX Dual Tone Output Spectrum at 3.75 GHz, -30 dBFS each ($0 - f_{\text{DAC}}$)

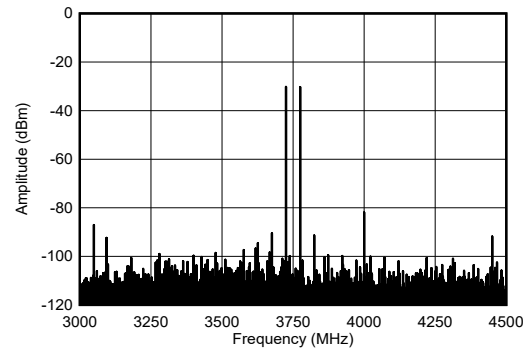

Matching at 3.5 GHz, 50 MHz tone spacing, $f_{\text{DAC}} = 12$ GSPS, non-interleave mode.

Figure 7-504. TX Dual Tone Output Spectrum at 3.75 GHz, -30 dBFS each (± 600 MHz)

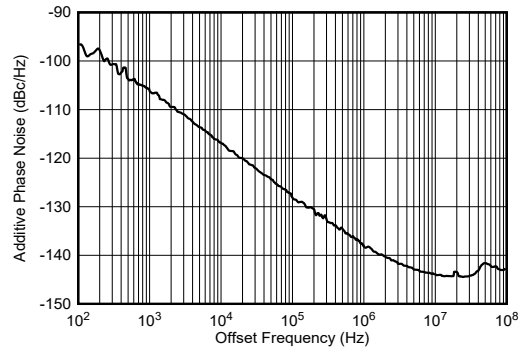

$f_{\text{DAC}} = f_{\text{CLK}} = 12$ GSPS, non-interleave mode.

Figure 7-505. External Clock Additive Phase Noise at 3.7 GHz

7.12.13 TX Typical Characteristics at 4.9 GHz

Typical values at $T_A = +25^\circ\text{C}$ with nominal supplies. Unless otherwise noted, TX input data rate = 491.52 MSPS, $f_{\text{DAC}} = 11796.48$ MSPS, interleave mode, $A_{\text{OUT}} = -1$ dBFS, 1st Nyquist zone output, Internal PLL, $f_{\text{REF}} = 491.52$ MSPS, 24x Interpolation, DSA = 0 dB, $\text{Sin}(x)/x$ enabled, DSA calibrated.

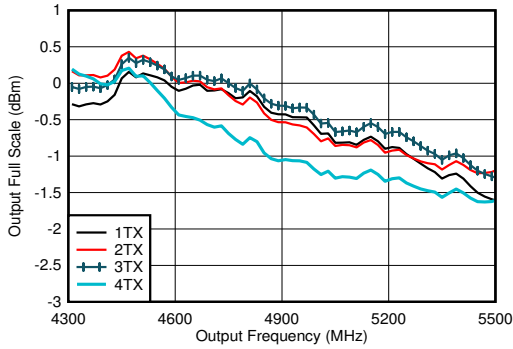

Excluding PCB and cable losses, $A_{\text{out}} = -0.5$ dBFS, DSA = 0, 4.9 GHz matching

Figure 7-506. TX Full Scale vs RF Frequency and Channel at 11796.48 MSPS

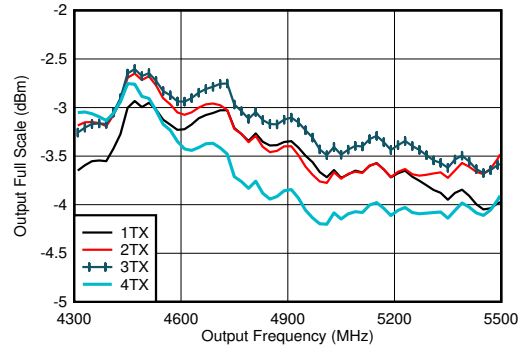

Excluding PCB and cable losses, $A_{\text{out}} = -0.5$ dBFS, DSA = 0, 4.9 GHz matching

Figure 7-507. TX Full Scale vs RF Frequency and Channel at 5898.24M SPS, Mix Mode, 2nd Nyquist Zone

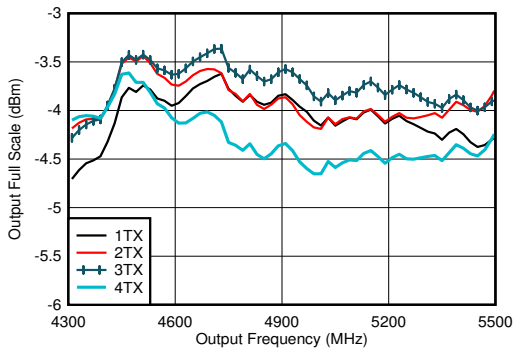

Excluding PCB and cable losses, $A_{\text{out}} = -0.5$ dBFS, DSA = 0, 4.9 GHz matching

Figure 7-508. TX Full Scale vs RF Frequency and Channel at 8847.36 MSPS, Mix Mode, 2nd Nyquist Zone

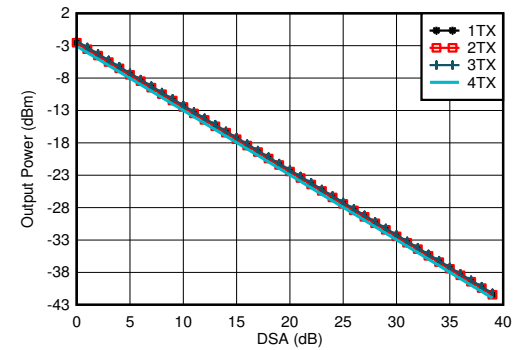

$f_{\text{DAC}} = 11796.48$ MSPS, $A_{\text{out}} = -0.5$ dBFS, matching 4.9 GHz

Figure 7-509. TX Output Power vs DSA Setting and Channel at 4.9 GHz

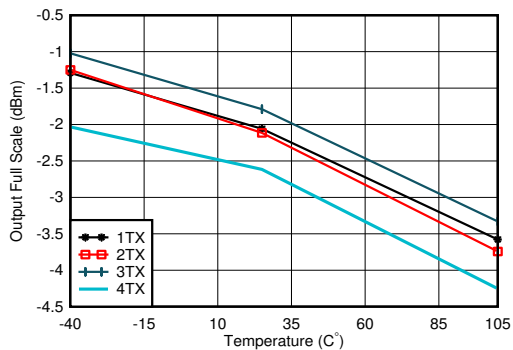

$A_{\text{out}} = -0.5$ dBFS, 4.9 GHz Matching, PCB and cable losses included.

Figure 7-510. TX Full Scale Output Power vs Temperature and Channel at 4.9 GHz

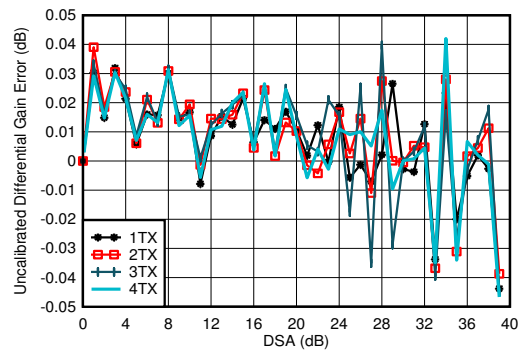

$f_{\text{DAC}} = 11796.48$ MSPS, interleave mode, matching at 4.9 GHz
Differential Gain Error = $P_{\text{OUT}}(\text{DSA Setting} - 1) - P_{\text{OUT}}(\text{DSA Setting}) + 1$

Figure 7-511. TX Uncalibrated Differential Gain Error vs DSA Setting and Channel at 4.9 GHz

7.12.13 TX Typical Characteristics at 4.9 GHz (continued)

Typical values at $T_A = +25^\circ\text{C}$ with nominal supplies. Unless otherwise noted, TX input data rate = 491.52 MSPS, $f_{\text{DAC}} = 11796.48$ MSPS, interleave mode, $A_{\text{OUT}} = -1$ dBFS, 1st Nyquist zone output, Internal PLL, $f_{\text{REF}} = 491.52$ MSPS, 24x Interpolation, DSA = 0 dB, Sin(x)/x enabled, DSA calibrated.

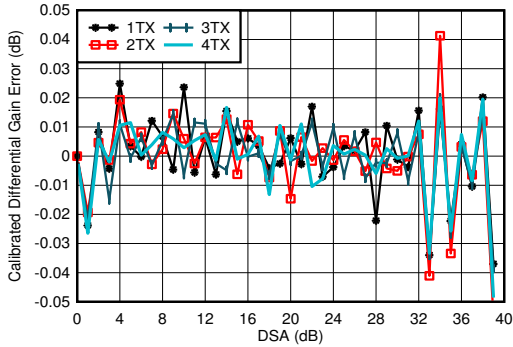

$f_{\text{DAC}} = 11796.48$ MSPS, interleave mode, matching at 4.9 GHz
Differential Gain Error = $P_{\text{OUT}}(\text{DSA Setting} - 1) - P_{\text{OUT}}(\text{DSA Setting}) + 1$

Figure 7-512. TX Calibrated Differential Gain Error vs DSA Setting and Channel at 4.9 GHz

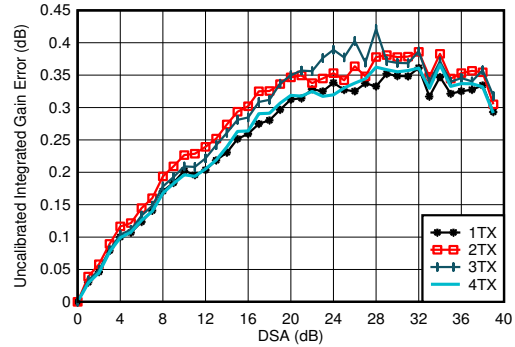

$f_{\text{DAC}} = 11796.48$ MSPS, interleave mode, matching at 4.9 GHz
Integrated Gain Error = $P_{\text{OUT}}(\text{DSA Setting}) - P_{\text{OUT}}(\text{DSA Setting} = 0) + (\text{DSA Setting})$

Figure 7-513. TX Uncalibrated Integrated Gain Error vs DSA Setting and Channel at 4.9 GHz

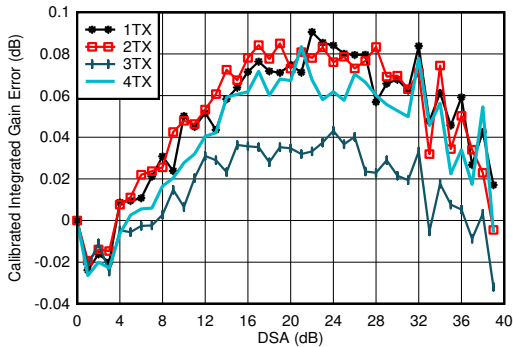

$f_{\text{DAC}} = 11796.48$ MSPS, interleave mode, matching at 4.9 GHz
Integrated Gain Error = $P_{\text{OUT}}(\text{DSA Setting}) - P_{\text{OUT}}(\text{DSA Setting} = 0) + (\text{DSA Setting})$

Figure 7-514. TX Calibrated Integrated Gain Error vs DSA Setting and Channel at 4.9 GHz

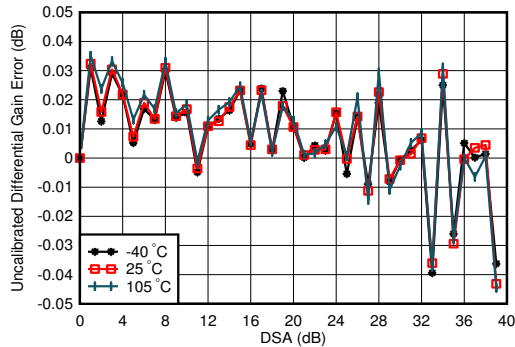

$f_{\text{DAC}} = 11796.48$ MSPS, interleaved mode, matching at 4.9 GHz
Differential Gain Error = $P_{\text{OUT}}(\text{DSA Setting} - 1) - P_{\text{OUT}}(\text{DSA Setting}) + 1$

Figure 7-515. TX Uncalibrated Differential Gain Error vs DSA Setting and Temperature at 4.9 GHz

7.12.13 TX Typical Characteristics at 4.9 GHz (continued)

Typical values at $T_A = +25^\circ\text{C}$ with nominal supplies. Unless otherwise noted, TX input data rate = 491.52 MSPS, $f_{\text{DAC}} = 11796.48$ MSPS, interleaved mode, $A_{\text{OUT}} = -1$ dBFS, 1st Nyquist zone output, Internal PLL, $f_{\text{REF}} = 491.52$ MSPS, 24x Interpolation, DSA = 0 dB, Sin(x)/x enabled, DSA calibrated.

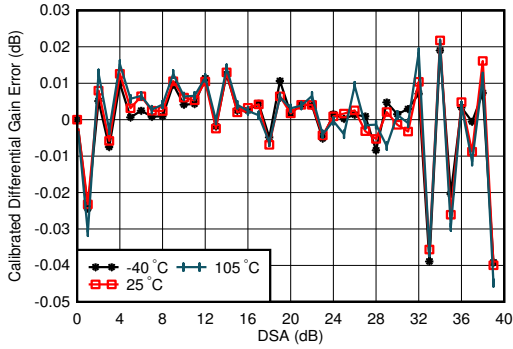

$f_{\text{DAC}} = 11796.48$ MSPS, interleaved mode, matching at 4.9 GHz
 Differential Gain Error = $P_{\text{OUT}}(\text{DSA Setting} - 1) - P_{\text{OUT}}(\text{DSA Setting}) + 1$

Figure 7-516. TX Calibrated Differential Gain Error vs DSA Setting and Temperature at 4.9 GHz

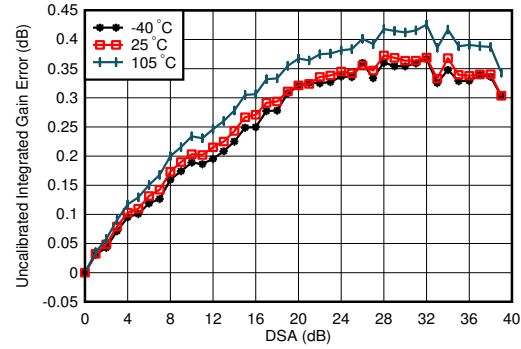

$f_{\text{DAC}} = 11796.48$ MSPS, interleaved mode, matching at 4.9 GHz
 Integrated Gain Error = $P_{\text{OUT}}(\text{DSA Setting}) - P_{\text{OUT}}(\text{DSA Setting} = 0) + (\text{DSA Setting})$

Figure 7-517. TX Uncalibrated Integrated Gain Error vs DSA Setting and Temperature at 4.9 GHz

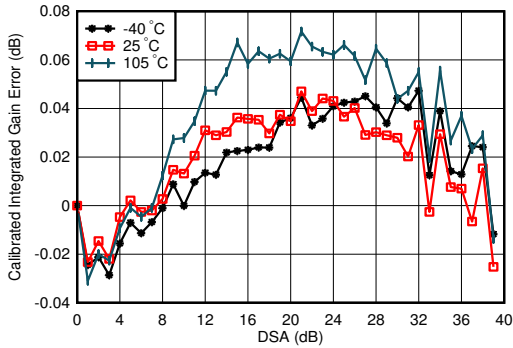

$f_{\text{DAC}} = 11796.48$ MSPS, interleaved mode, matching at 4.9 GHz
 Integrated Gain Error = $P_{\text{OUT}}(\text{DSA Setting}) - P_{\text{OUT}}(\text{DSA Setting} = 0) + (\text{DSA Setting})$

Figure 7-518. TX Calibrated Integrated Gain Error vs DSA Setting and Temperature at 4.9 GHz

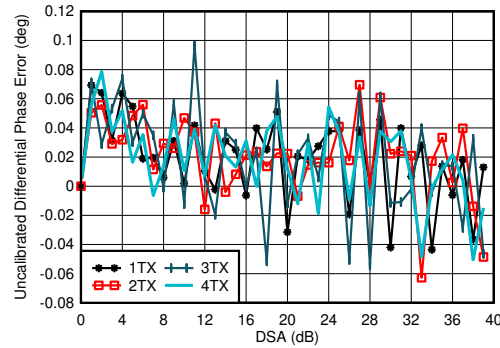

$f_{\text{DAC}} = 11796.48$ MSPS, interleaved mode, matching at 4.9 GHz
 Differential Phase Error = $\text{Phase}_{\text{OUT}}(\text{DSA Setting} - 1) - \text{Phase}_{\text{OUT}}(\text{DSA Setting})$

Figure 7-519. TX Uncalibrated Differential Phase Error vs DSA Setting and Channel at 4.9 GHz

7.12.13 TX Typical Characteristics at 4.9 GHz (continued)

Typical values at $T_A = +25^\circ\text{C}$ with nominal supplies. Unless otherwise noted, TX input data rate = 491.52 MSPS, $f_{\text{DAC}} = 11796.48$ MSPS, interleaved mode, $A_{\text{OUT}} = -1$ dBFS, 1st Nyquist zone output, Internal PLL, $f_{\text{REF}} = 491.52$ MSPS, 24x Interpolation, DSA = 0 dB, Sin(x)/x enabled, DSA calibrated.

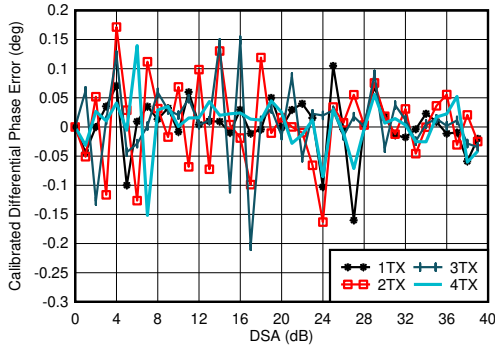

$f_{\text{DAC}} = 11796.48$ MSPS, interleaved mode, matching at 4.9 GHz
 Differential Phase Error = $\text{Phase}_{\text{OUT}}(\text{DSA Setting} - 1) - \text{Phase}_{\text{OUT}}(\text{DSA Setting})$
 Phase DNL spike may occur at any DSA setting.

Figure 7-520. TX Calibrated Differential Phase Error vs DSA Setting and Channel at 4.9 GHz

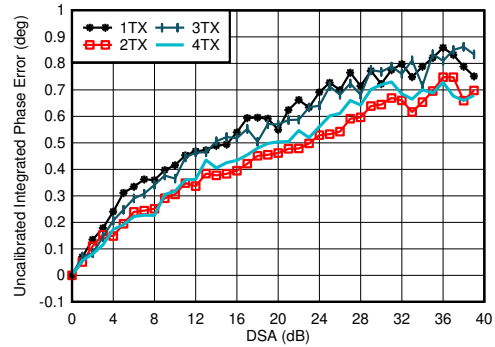

$f_{\text{DAC}} = 11796.48$ MSPS, interleaved mode, matching at 4.9 GHz
 Integrated Phase Error = $\text{Phase}(\text{DSA Setting}) - \text{Phase}(\text{DSA Setting} = 0)$

Figure 7-521. TX Uncalibrated Integrated Phase Error vs DSA Setting and Channel at 4.9 GHz

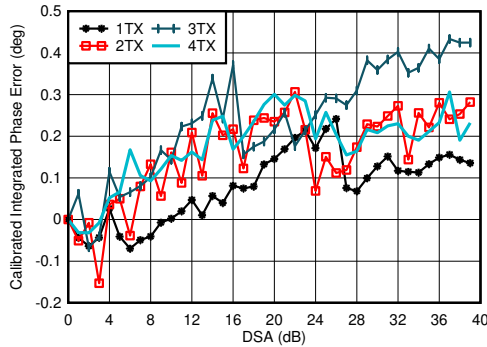

$f_{\text{DAC}} = 11796.48$ MSPS, interleaved mode, matching at 4.9 GHz
 Integrated Phase Error = $\text{Phase}(\text{DSA Setting}) - \text{Phase}(\text{DSA Setting} = 0)$

Figure 7-522. TX Calibrated Integrated Phase Error vs DSA Setting and Channel at 4.9 GHz

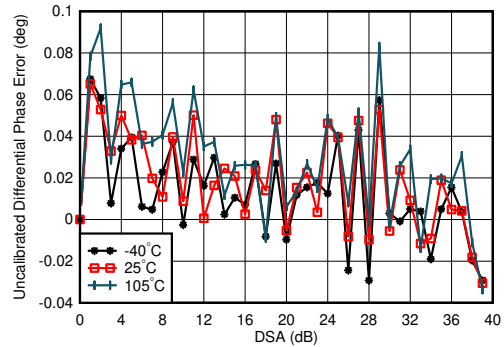

$f_{\text{DAC}} = 11796.48$ MSPS, interleaved mode, matching at 4.9 GHz
 Differential Phase Error = $\text{Phase}_{\text{OUT}}(\text{DSA Setting} - 1) - \text{Phase}_{\text{OUT}}(\text{DSA Setting})$

Figure 7-523. TX Uncalibrated Differential Phase Error vs DSA Setting and Temperature at 4.9 GHz

7.12.13 TX Typical Characteristics at 4.9 GHz (continued)

Typical values at $T_A = +25^\circ\text{C}$ with nominal supplies. Unless otherwise noted, TX input data rate = 491.52 MSPS, $f_{\text{DAC}} = 11796.48$ MSPS, interleaved mode, $A_{\text{OUT}} = -1$ dBFS, 1st Nyquist zone output, Internal PLL, $f_{\text{REF}} = 491.52$ MSPS, 24x Interpolation, DSA = 0 dB, Sin(x)/x enabled, DSA calibrated.

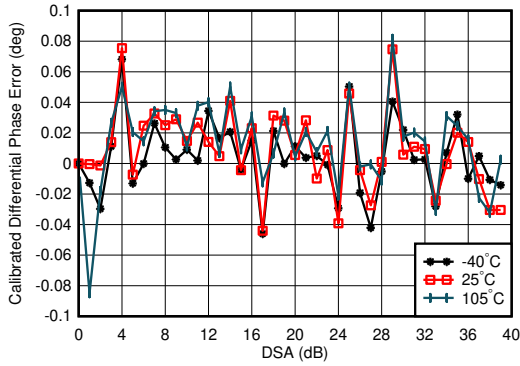

$f_{\text{DAC}} = 11796.48$ MSPS, interleaved mode, matching at 4.9 GHz
 Differential Phase Error = $\text{Phase}_{\text{OUT}}(\text{DSA Setting} - 1) - \text{Phase}_{\text{OUT}}(\text{DSA Setting})$

Figure 7-524. TX Calibrated Differential Phase Error vs DSA Setting and Temperature at 4.9 GHz

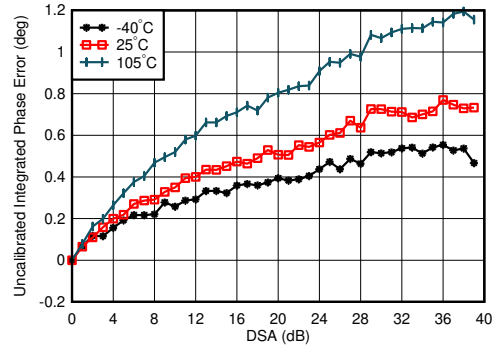

$f_{\text{DAC}} = 11796.48$ MSPS, interleaved mode, matching at 4.9 GHz
 Integrated Phase Error = $\text{Phase}(\text{DSA Setting}) - \text{Phase}(\text{DSA Setting} = 0)$

Figure 7-525. TX Uncalibrated Integrated Phase Error vs DSA Setting and Temperature at 4.9 GHz

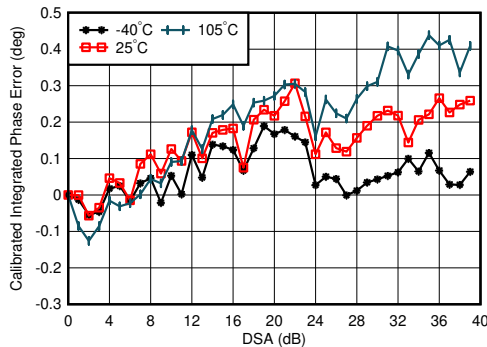

$f_{\text{DAC}} = 11796.48$ MSPS, interleaved mode, matching at 4.9 GHz
 Integrated Phase Error = $\text{Phase}(\text{DSA Setting}) - \text{Phase}(\text{DSA Setting} = 0)$

Figure 7-526. TX Calibrated Integrated Phase Error vs DSA Setting and Temperature at 4.9 GHz

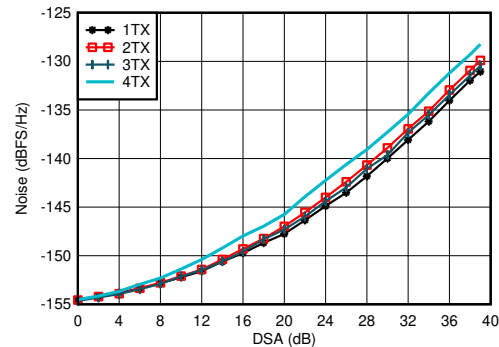

$f_{\text{DAC}} = 11796.48$ MSPS, interleaved mode, matching at 4.9 GHz, $P_{\text{OUT}} = -13$ dBFS

Figure 7-527. TX Output Noise vs Channel and Attenuation at 4.9 GHz

7.12.13 TX Typical Characteristics at 4.9 GHz (continued)

Typical values at $T_A = +25^\circ\text{C}$ with nominal supplies. Unless otherwise noted, TX input data rate = 491.52 MSPS, $f_{\text{DAC}} = 11796.48$ MSPS, interleave mode, $A_{\text{OUT}} = -1$ dBFS, 1st Nyquist zone output, Internal PLL, $f_{\text{REF}} = 491.52$ MSPS, 24x Interpolation, DSA = 0 dB, Sin(x)/x enabled, DSA calibrated.

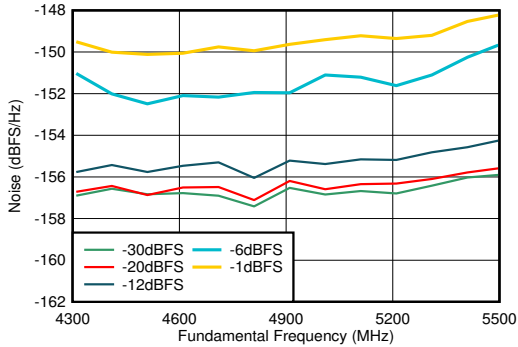

$f_{\text{DAC}} = 11796.48$ MSPS, interleave mode, matching at 4.9 GHz, $A_{\text{out}} = -13$ dBFS.

Figure 7-528. TX NSD vs Output Frequency and Digital Amplitude at 4.9 GHz (DSA = 0 dB)

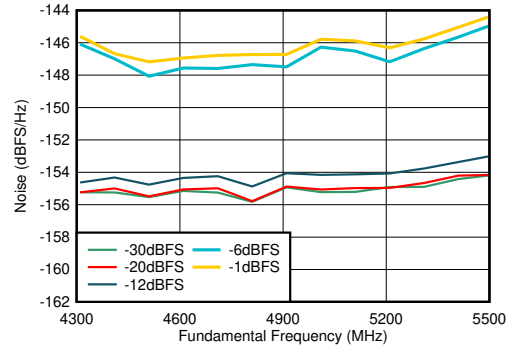

$f_{\text{DAC}} = 11796.48$ MSPS, interleave mode, matching at 4.9 GHz, $A_{\text{out}} = -13$ dBFS.

Figure 7-529. TX NSD vs Output Frequency and Digital Amplitude at 4.9 GHz (DSA = 6 dB)

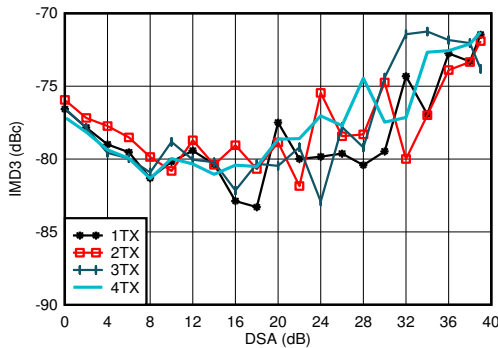

$f_{\text{DAC}} = 11796.48$ MSPS, interleaved mode, matching at 4.9 GHz, $f_{\text{CENTER}} = 4.9$ GHz, -13 dBFS each tone

Figure 7-530. TX IMD3 vs DSA Setting at 4.9 GHz

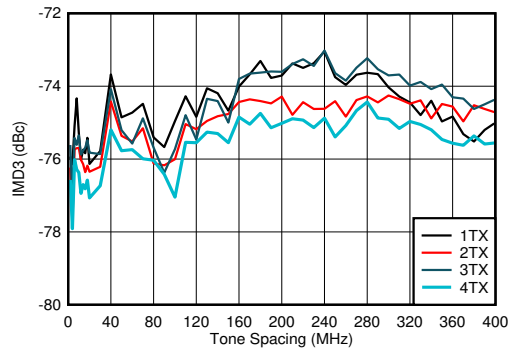

$f_{\text{DAC}} = 11796.48$ MSPS, interleaved mode, matching at 4.9 GHz, $f_{\text{CENTER}} = 4.9$ GHz, -13 dBFS each tone

Figure 7-531. TX IMD3 vs Tone Spacing and Channel at 4.9 GHz

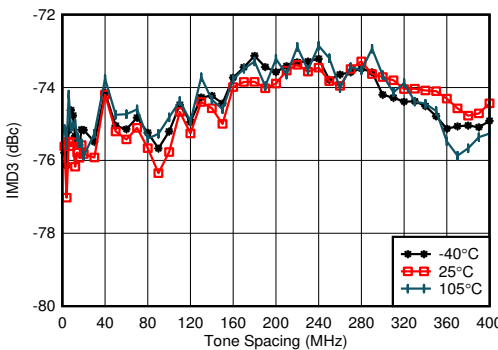

$f_{\text{DAC}} = 11796.48$ MSPS, interleaved mode, matching at 4.9 GHz, $f_{\text{CENTER}} = 4.9$ GHz, -13 dBFS each tone, worst channel

Figure 7-532. TX IMD3 vs Tone Spacing and Temperature at 4.9 GHz

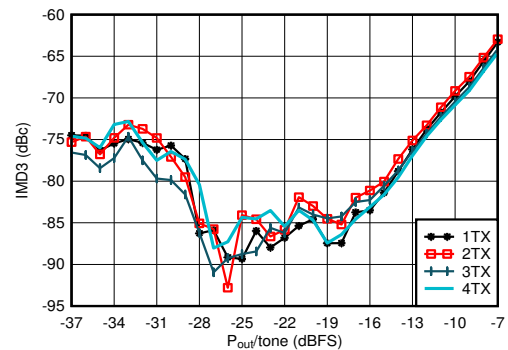

$f_{\text{DAC}} = 11796.48$ MSPS, interleaved mode, matching at 4.9 GHz, $f_{\text{CENTER}} = 4.9$ GHz, $f_{\text{SPACING}} = 20$ MHz

Figure 7-533. TX IMD3 vs Digital Level at 4.9 GHz

7.12.13 TX Typical Characteristics at 4.9 GHz (continued)

Typical values at $T_A = +25^\circ\text{C}$ with nominal supplies. Unless otherwise noted, TX input data rate = 491.52 MSPS, $f_{DAC} = 11796.48$ MSPS, interleave mode, $A_{OUT} = -1$ dBFS, 1st Nyquist zone output, Internal PLL, $f_{REF} = 491.52$ MSPS, 24x Interpolation, DSA = 0 dB, $\text{Sin}(x)/x$ enabled, DSA calibrated.

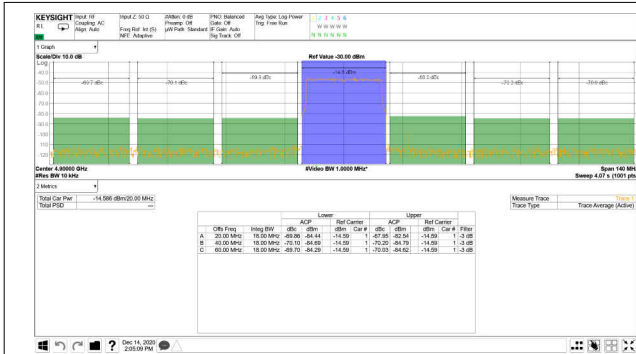

TM1.1, $P_{OUT_RMS} = -13$ dBFS

Figure 7-534. TX 20-MHz LTE Output Spectrum at 4.9 GHz

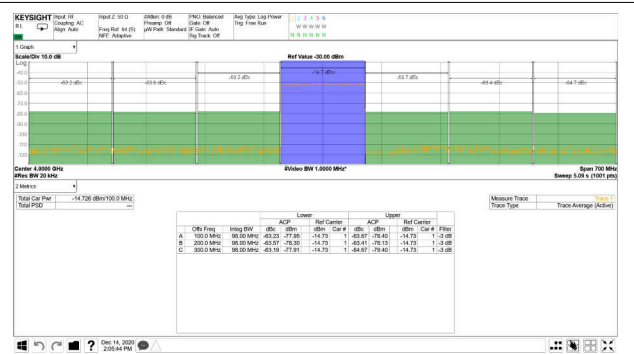

TM1.1, $P_{OUT_RMS} = -13$ dBFS

Figure 7-535. TX 100-MHz NR Output Spectrum at 4.9 GHz

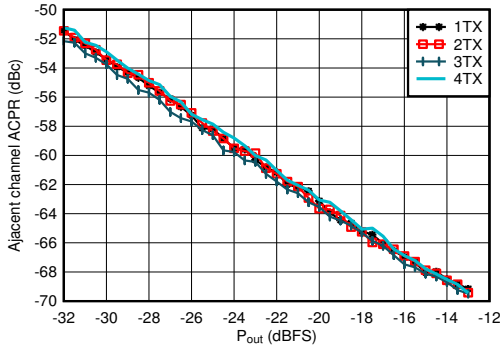

Matching at 4.9 GHz, single carrier 20-MHz BW TM1.1 LTE

Figure 7-536. TX 20-MHz LTE ACPR vs Digital Level at 4.9 GHz

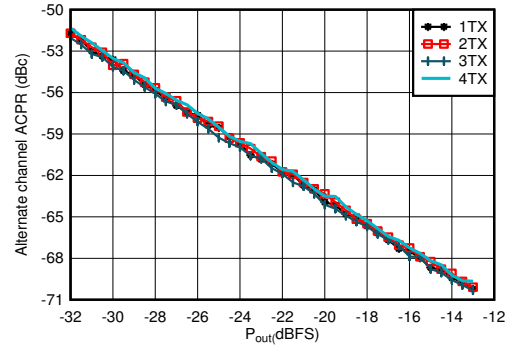

Matching at 4.9 GHz, single carrier 20-MHz BW TM1.1 LTE

Figure 7-537. TX 20-MHz LTE alt-ACPR vs Digital Level at 4.9 GHz

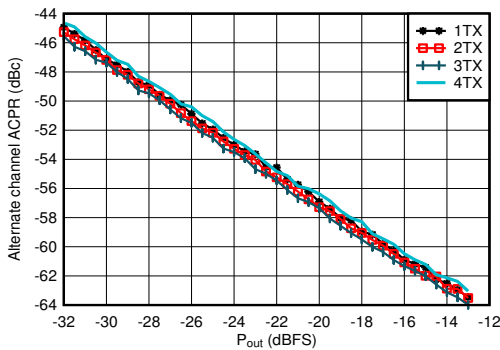

Matching at 4.9 GHz, single carrier 100-MHz BW TM1.1 NR

Figure 7-538. TX 100-MHz NR ACPR vs Digital Level at 4.9 GHz

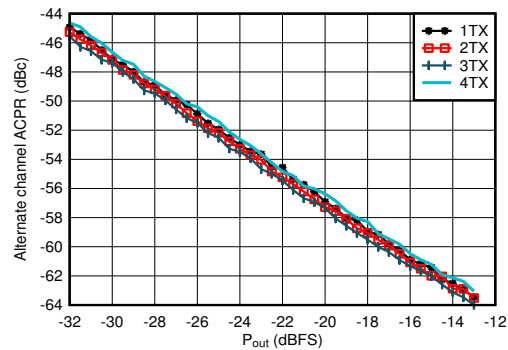

Matching at 4.9 GHz, single carrier 100-MHz BW TM1.1 NR

Figure 7-539. TX 100-MHz NR alt-ACPR vs Digital Level at 4.9 GHz

7.12.13 TX Typical Characteristics at 4.9 GHz (continued)

Typical values at $T_A = +25^\circ\text{C}$ with nominal supplies. Unless otherwise noted, TX input data rate = 491.52 MSPS, $f_{\text{DAC}} = 11796.48$ MSPS, interleave mode, $A_{\text{OUT}} = -1$ dBFS, 1st Nyquist zone output, Internal PLL, $f_{\text{REF}} = 491.52$ MSPS, 24x Interpolation, DSA = 0 dB, Sin(x)/x enabled, DSA calibrated.

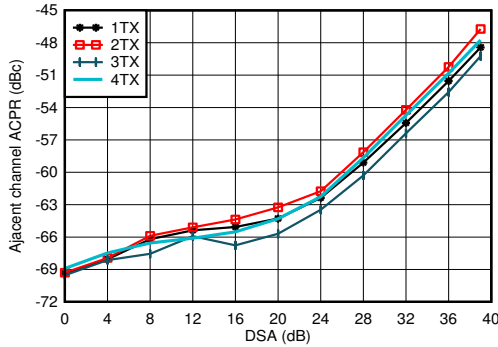

Matching at 4.9 GHz, single carrier 20-MHz BW TM1.1 LTE

Figure 7-540. TX 20-MHz LTE ACPR vs DSA at 4.9 GHz

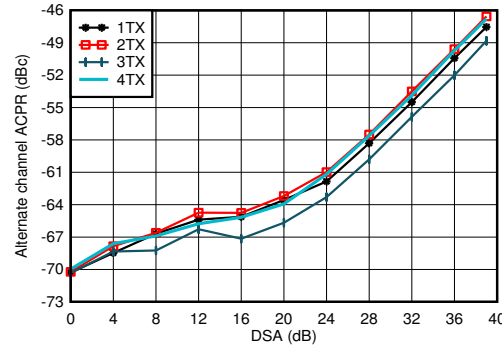

Matching at 4.9 GHz, single carrier 20-MHz BW TM1.1 LTE

Figure 7-541. TX 20-MHz LTE alt-ACPR vs DSA at 4.9 GHz

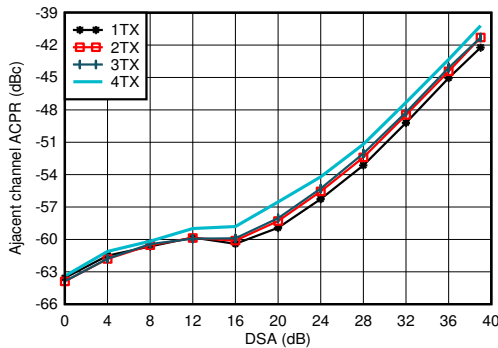

Matching at 4.9 GHz, single carrier 100-MHz BW TM1.1 NR

Figure 7-542. TX 100-MHz NR ACPR vs DSA at 4.9 GHz

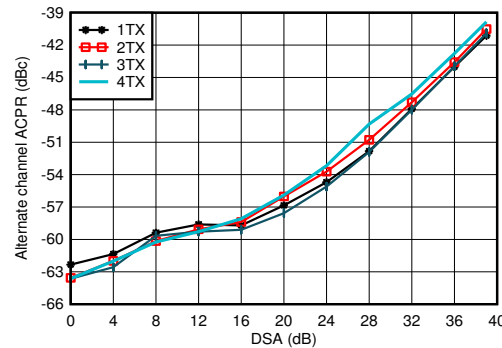

Matching at 4.9 GHz, single carrier 100-MHz BW TM1.1 NR

Figure 7-543. TX 100-MHz NR alt-ACPR vs DSA at 4.9 GHz

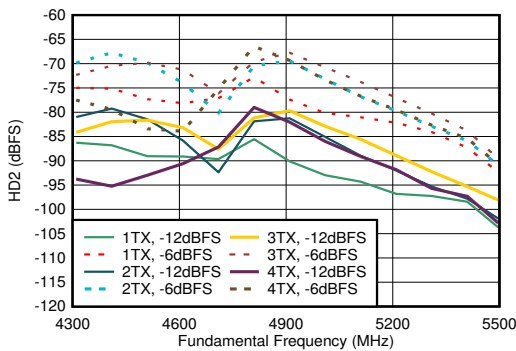

Matching at 4.9 GHz, $f_{\text{DAC}} = 11.79648$ GSPS, interleave mode, normalized to output power at harmonic frequency

Figure 7-544. TX HD2 vs Digital Amplitude and Output Frequency at 4.9 GHz

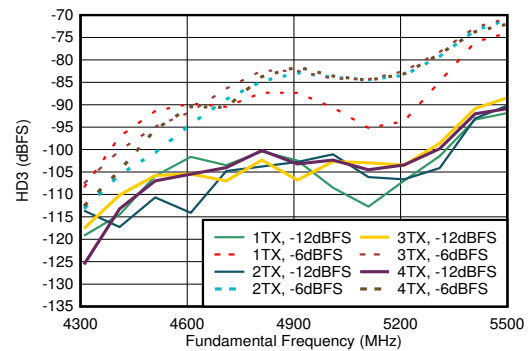

Matching at 4.9 GHz, $f_{\text{DAC}} = 11.79648$ GSPS, interleave mode, normalized to output power at harmonic frequency

Figure 7-545. TX HD3 vs Digital Amplitude and Output Frequency at 4.9 GHz

7.12.13 TX Typical Characteristics at 4.9 GHz (continued)

Typical values at $T_A = +25^\circ\text{C}$ with nominal supplies. Unless otherwise noted, TX input data rate = 491.52 MSPS, $f_{DAC} = 11796.48$ MSPS, interleave mode, $A_{OUT} = -1$ dBFS, 1st Nyquist zone output, Internal PLL, $f_{REF} = 491.52$ MSPS, 24x Interpolation, DSA = 0 dB, Sin(x)/x enabled, DSA calibrated.

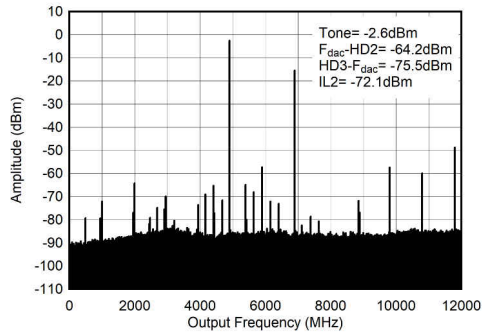

$f_{DAC} = 11796.48$ MSPS, interleave mode, 4.9 GHz matching, includes PCB and cable losses. $ILn = f_s/n \pm f_{OUT}$.

Figure 7-546. TX Single Tone (-1 dBFS) Output Spectrum at 4.9 GHz (0- f_{DAC})

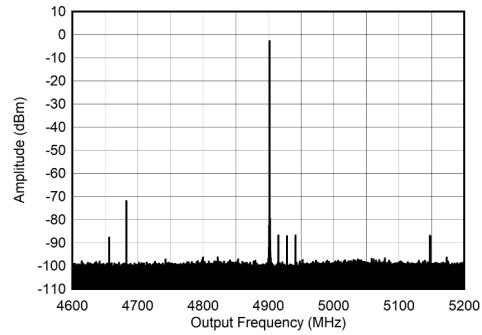

$f_{DAC} = 11796.48$ MSPS, interleave mode, 4.9 GHz matching, includes PCB and cable losses

Figure 7-547. TX Single Tone (-1 dBFS) Output Spectrum at 4.9 GHz (± 300 MHz)

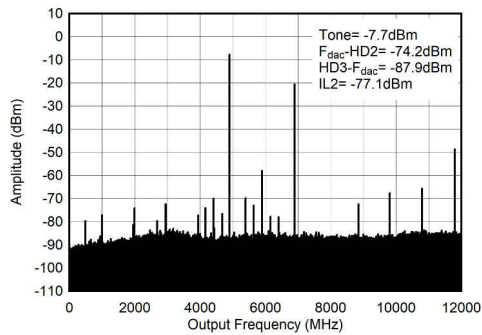

$f_{DAC} = 11796.48$ MSPS, interleave mode, 4.9 GHz matching, includes PCB and cable losses. $ILn = f_s/n \pm f_{OUT}$.

Figure 7-548. TX Single Tone (-6 dBFS) Output Spectrum at 4.9 GHz (0- f_{DAC})

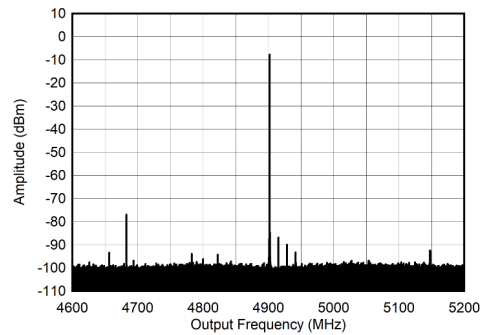

$f_{DAC} = 11796.48$ MSPS, interleave mode, 4.9 GHz matching, includes PCB and cable losses

Figure 7-549. TX Single Tone (-6 dBFS) Output Spectrum at 4.9 GHz (± 300 MHz)

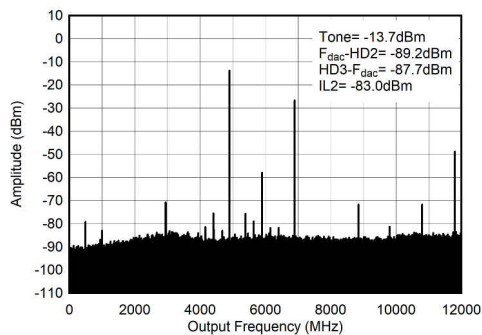

$f_{DAC} = 11796.48$ MSPS, interleave mode, 4.9 GHz matching, includes PCB and cable losses. $ILn = f_s/n \pm f_{OUT}$.

Figure 7-550. TX Single Tone (-12 dBFS) Output Spectrum at 4.9 GHz (0- f_{DAC})

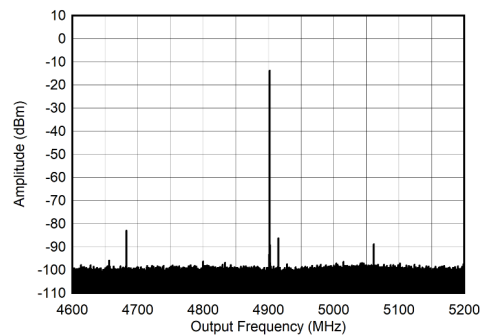

$f_{DAC} = 11796.48$ MSPS, interleave mode, 4.9 GHz matching, includes PCB and cable losses

Figure 7-551. TX Single Tone (-12 dBFS) Output Spectrum at 4.9 GHz (± 300 MHz)

7.12.13 TX Typical Characteristics at 4.9 GHz (continued)

Typical values at $T_A = +25^\circ\text{C}$ with nominal supplies. Unless otherwise noted, TX input data rate = 491.52 MSPS, $f_{DAC} = 11796.48$ MSPS, interleave mode, $A_{OUT} = -1$ dBFS, 1st Nyquist zone output, Internal PLL, $f_{REF} = 491.52$ MSPS, 24x Interpolation, DSA = 0 dB, Sin(x)/x enabled, DSA calibrated.

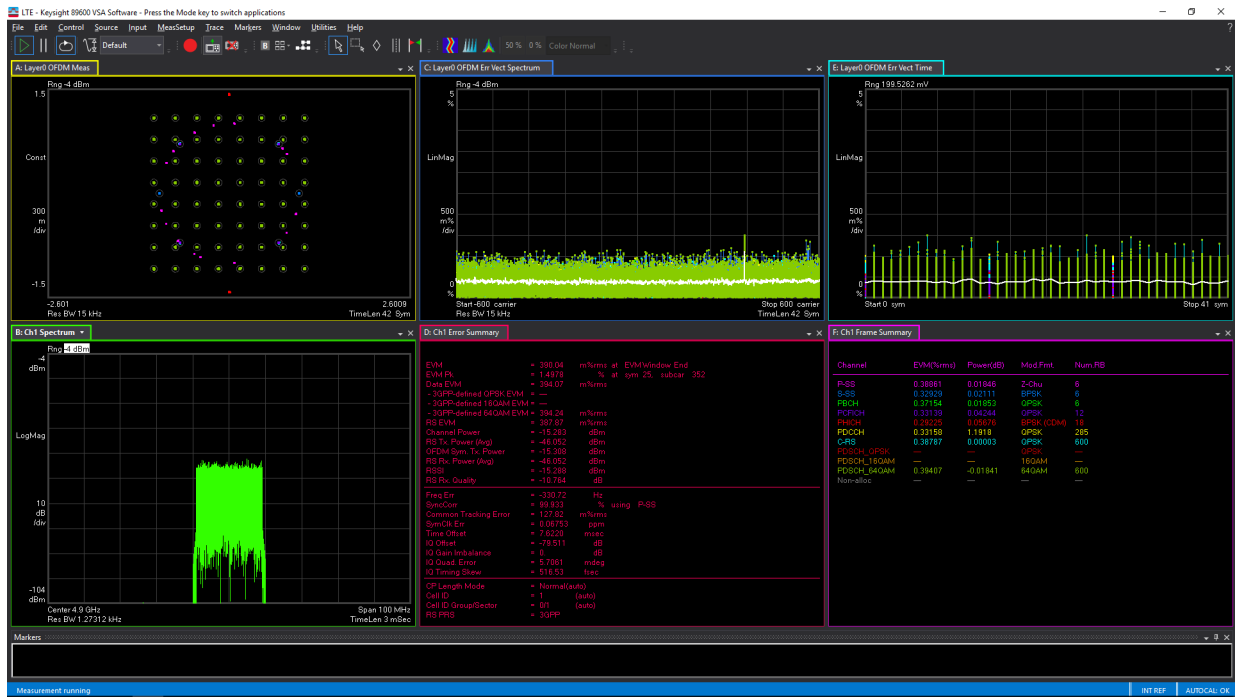

TM1.1, $P_{OUT_RMS} = -13$ dBFS

Figure 7-552. TX 20-MHz LTE Error Vector Magnitude at 4.9 GHz

7.12.14 TX Typical Characteristics at 7.1 GHz

Typical values at $T_A = +25^\circ\text{C}$ with nominal supplies. Unless otherwise noted, TX input data rate = 500 MSPS, $f_{\text{DAC}} = 9000$ MSPS, non-interleave mode, $A_{\text{OUT}} = -1$ dBFS, 2nd Nyquist zone output, External clock mode, 18x Interpolation, DSA = 0 dB, Sin(x)/x enabled, DSA calibrated, 7.1 GHz matching.

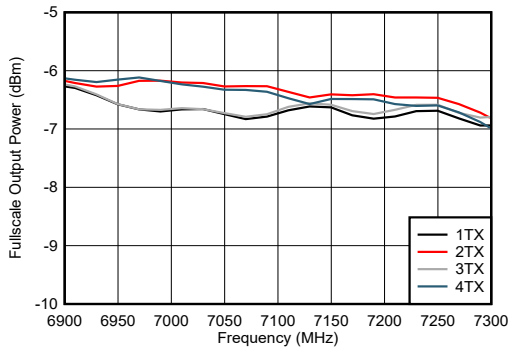

Excluding PCB and cable losses

Figure 7-553. TX Full Scale vs RF Frequency and Channel

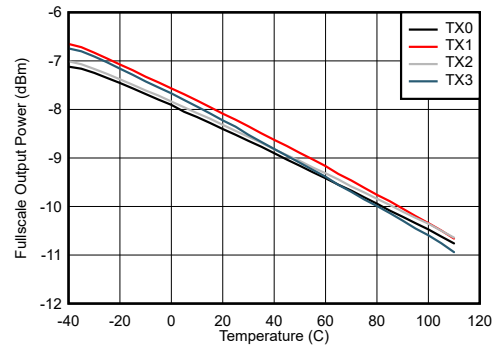

Excluding PCB and cable losses

Figure 7-554. TX Full Scale vs Temperature and Channel at 7.1 GHz

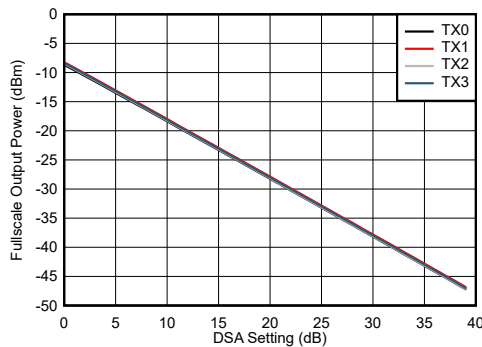

Excluding PCB and cable losses

Figure 7-555. TX Full Scale vs DSA Setting and Channel at 7.1 GHz

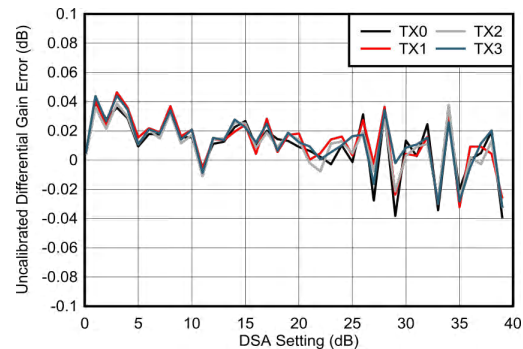

Differential Gain Error = Gain(DSA Setting – 1) – Gain(DSA Setting)

Figure 7-556. Uncalibrated Differential Gain Error vs Channel at 7.1 GHz

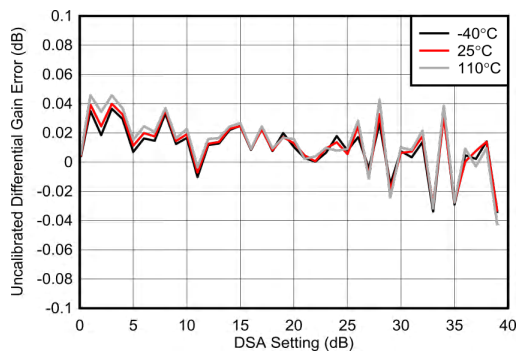

Differential Gain Error = Gain(DSA Setting – 1) – Gain(DSA Setting)

Figure 7-557. Uncalibrated Differential Gain Error vs Temperature at 7.1 GHz

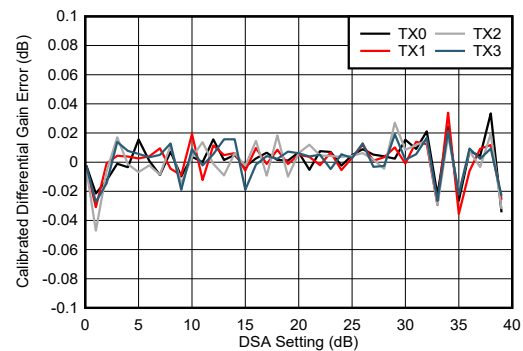

Differential Gain Error = Gain(DSA Setting – 1) – Gain(DSA Setting)

Figure 7-558. Calibrated Differential Gain Error vs Channel at 7.1 GHz

7.12.14 TX Typical Characteristics at 7.1 GHz (continued)

Typical values at $T_A = +25^\circ\text{C}$ with nominal supplies. Unless otherwise noted, TX input data rate = 500 MSPS, $f_{\text{DAC}} = 9000$ MSPS, non-interleave mode, $A_{\text{OUT}} = -1$ dBFS, 2nd Nyquist zone output, External clock mode, 18x Interpolation, DSA = 0 dB, $\text{Sin}(x)/x$ enabled, DSA calibrated, 7.1 GHz matching.

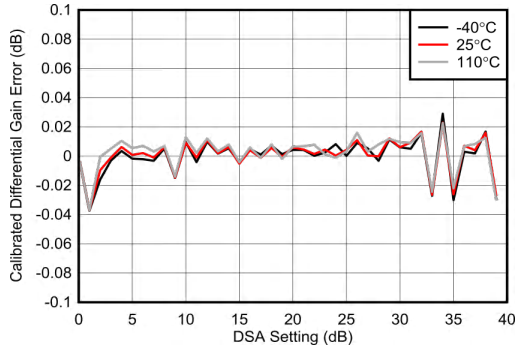

Differential Gain Error = $\text{Gain}(\text{DSA Setting} - 1) - \text{Gain}(\text{DSA Setting})$

Figure 7-559. Calibrated Differential Gain Error vs Temperature at 7.1 GHz

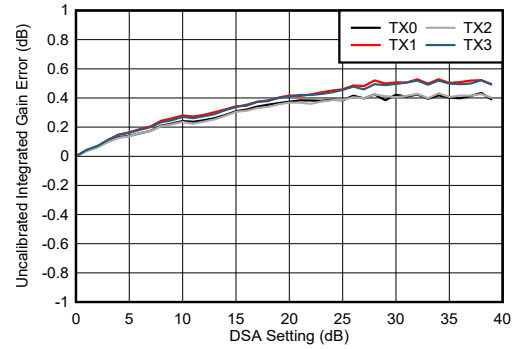

Integrated Gain Error = $\text{Gain}(\text{DSA Setting}) - \text{Gain}(\text{DSA Setting} = 0)$.

Figure 7-560. Uncalibrated Integrated Gain Error vs Channel at 7.1 GHz

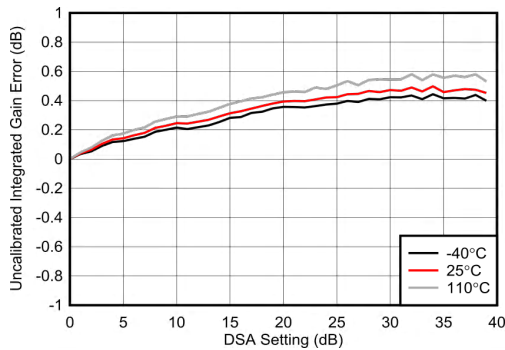

Integrated Gain Error = $\text{Gain}(\text{DSA Setting}) - \text{Gain}(\text{DSA Setting} = 0)$.

Figure 7-561. Uncalibrated Integrated Gain Error vs Temperature at 7.1 GHz

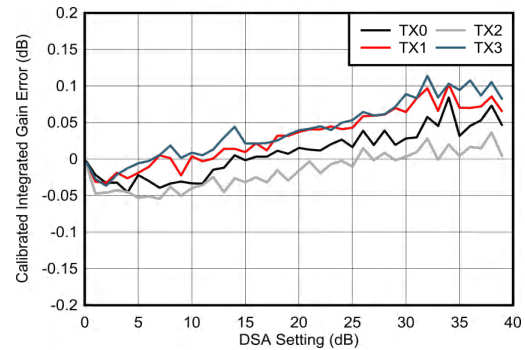

Integrated Gain Error = $\text{Gain}(\text{DSA Setting}) - \text{Gain}(\text{DSA Setting} = 0)$.

Figure 7-562. Calibrated Integrated Gain Error vs Channel at 7.1 GHz

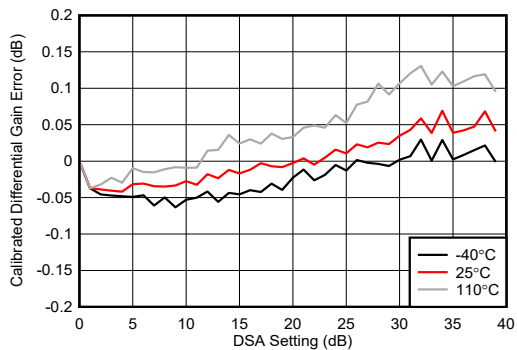

Integrated Gain Error = $\text{Gain}(\text{DSA Setting}) - \text{Gain}(\text{DSA Setting} = 0)$.

Figure 7-563. Calibrated Integrated Gain Error vs Temperature at 7.1 GHz

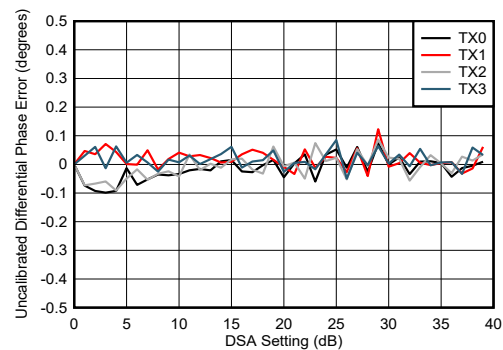

Differential Phase Error = $\text{Phase}(\text{DSA Setting} - 1) - \text{Phase}(\text{DSA Setting})$

Figure 7-564. Uncalibrated Differential Phase Error vs Channel at 7.1 GHz

7.12.14 TX Typical Characteristics at 7.1 GHz (continued)

Typical values at $T_A = +25^\circ\text{C}$ with nominal supplies. Unless otherwise noted, TX input data rate = 500 MSPS, $f_{\text{DAC}} = 9000$ MSPS, non-interleave mode, $A_{\text{OUT}} = -1$ dBFS, 2nd Nyquist zone output, External clock mode, 18x Interpolation, DSA = 0 dB, $\text{Sin}(x)/x$ enabled, DSA calibrated, 7.1 GHz matching.

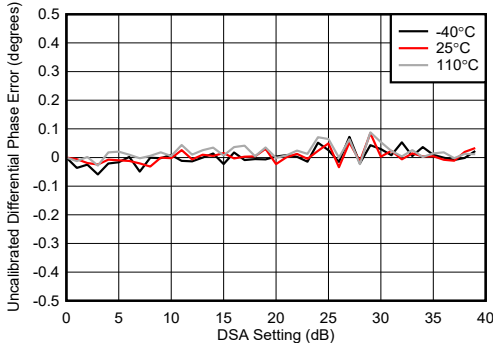

Differential Phase Error = $\text{Phase}(\text{DSA Setting} - 1) - \text{Phase}(\text{DSA Setting})$

Figure 7-565. Uncalibrated Differential Phase Error vs Temperature at 7.1 GHz

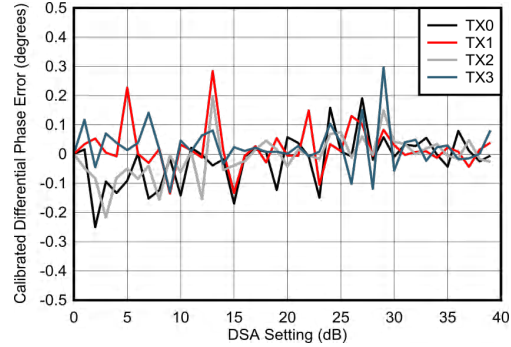

Differential Phase Error = $\text{Phase}(\text{DSA Setting} - 1) - \text{Phase}(\text{DSA Setting})$

Figure 7-566. Calibrated Differential Phase Error vs Channel at 7.1 GHz

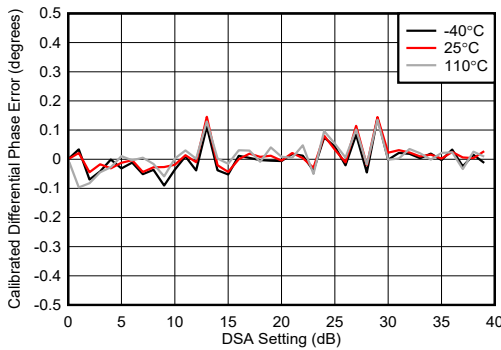

Differential Phase Error = $\text{Phase}(\text{DSA Setting} - 1) - \text{Phase}(\text{DSA Setting})$

Figure 7-567. Calibrated Differential Phase Error vs Temperature at 7.1 GHz

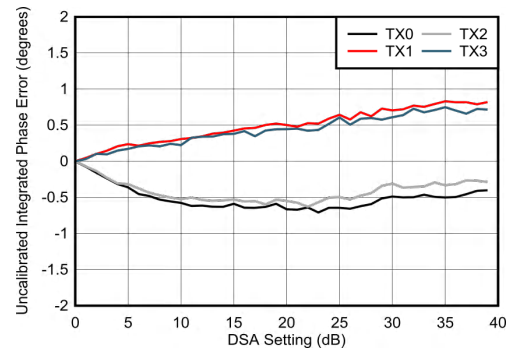

Integrated Phase Error = $\text{Phase}(\text{DSA Setting}) - \text{Phase}(\text{DSA Setting} = 0)$

Figure 7-568. Uncalibrated Integrated Phase Error vs Channel at 7.1 GHz

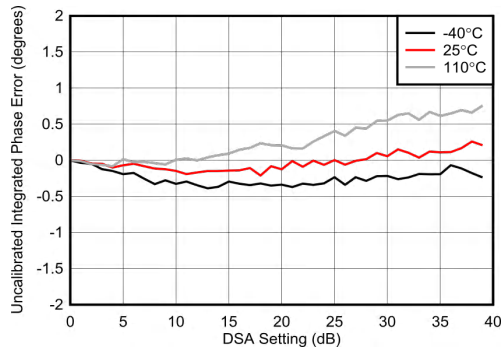

Integrated Phase Error = $\text{Phase}(\text{DSA Setting}) - \text{Phase}(\text{DSA Setting} = 0)$

Figure 7-569. Uncalibrated Integrated Phase Error vs Temperature at 7.1 GHz

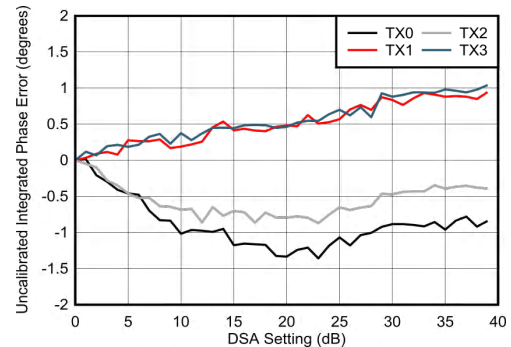

Integrated Phase Error = $\text{Phase}(\text{DSA Setting}) - \text{Phase}(\text{DSA Setting} = 0)$

Figure 7-570. Calibrated Integrated Phase Error vs Channel at 7.1 GHz

7.12.14 TX Typical Characteristics at 7.1 GHz (continued)

Typical values at $T_A = +25^\circ\text{C}$ with nominal supplies. Unless otherwise noted, TX input data rate = 500 MSPS, $f_{\text{DAC}} = 9000$ MSPS, non-interleave mode, $A_{\text{OUT}} = -1$ dBFS, 2nd Nyquist zone output, External clock mode, 18x Interpolation, DSA = 0 dB, $\text{Sin}(x)/x$ enabled, DSA calibrated, 7.1 GHz matching.

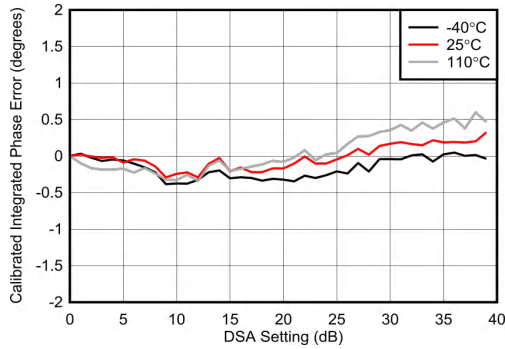

Integrated Phase Error = Phase(DSA Setting) – Phase(DSA Setting = 0)

Figure 7-571. Calibrated Integrated Phase Error vs Temperature at 7.1 GHz

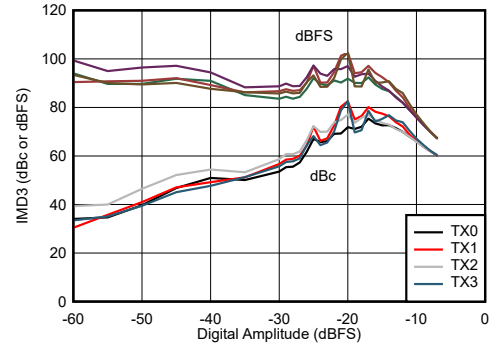

Tone spacing = 50 MHz

Figure 7-572. IMD3 vs Digital Amplitude and Channel at 7.1 GHz

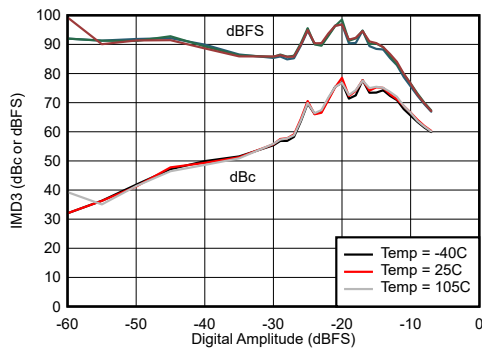

Tone spacing = 50 MHz

Figure 7-573. IMD3 vs Digital Amplitude and Temperature at 7.1 GHz

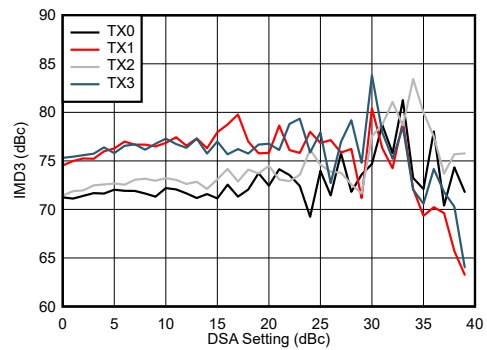

Tone spacing = 50 MHz

Figure 7-574. IMD3 vs DSA Setting and Channel at 7.1 GHz

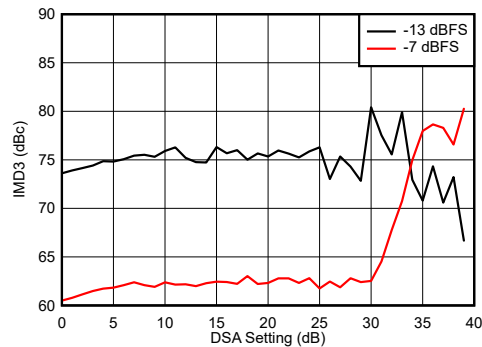

Tone spacing = 5 0MHz

Figure 7-575. IMD3 vs DSA Setting and Digital Amplitude at 7.1 GHz

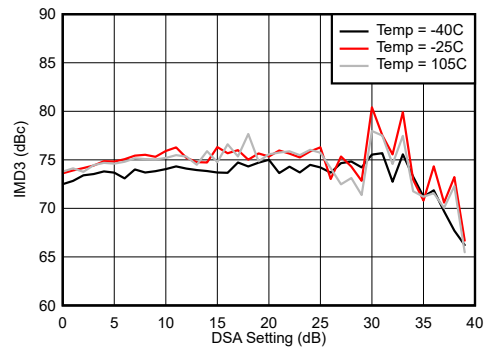

Tone spacing = 50 MHz

Figure 7-576. IMD3 vs DSA Setting and Temperature at 7.1 GHz

7.12.14 TX Typical Characteristics at 7.1 GHz (continued)

Typical values at $T_A = +25^\circ\text{C}$ with nominal supplies. Unless otherwise noted, TX input data rate = 500 MSPS, $f_{DAC} = 9000$ MSPS, non-interleave mode, $A_{OUT} = -1$ dBFS, 2nd Nyquist zone output, External clock mode, 18x Interpolation, DSA = 0 dB, $\text{Sin}(x)/x$ enabled, DSA calibrated, 7.1 GHz matching.

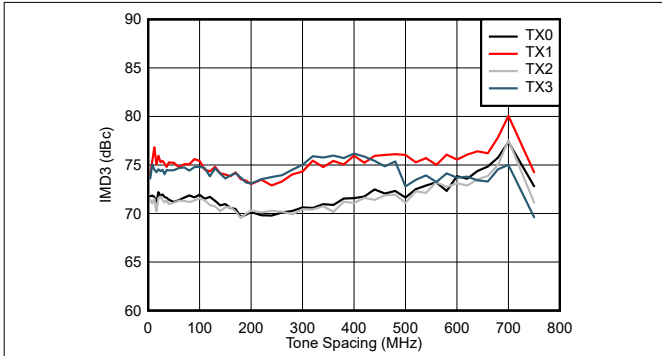

Figure 7-577. IMD3 vs Tone Spacing and Channel at 7.1 GHz

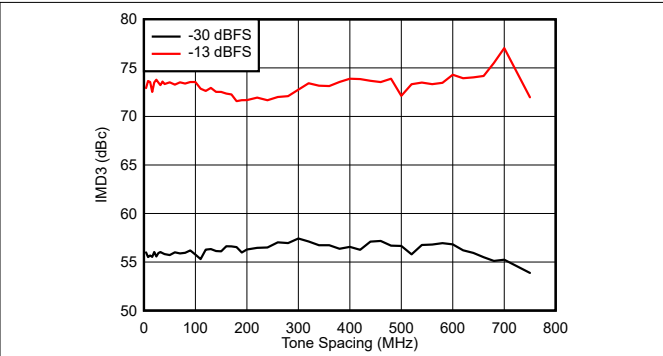

Figure 7-578. IMD3 vs Tone Spacing and Digital Amplitude at 7.1 GHz

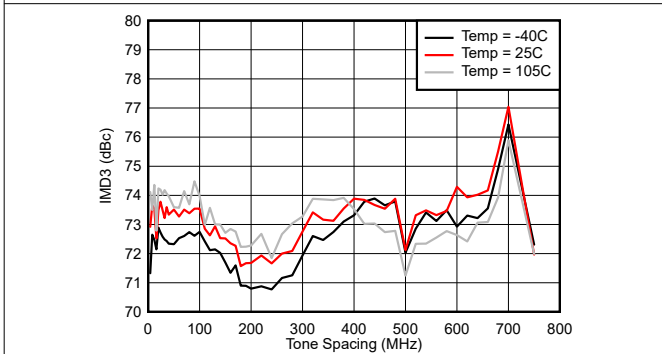
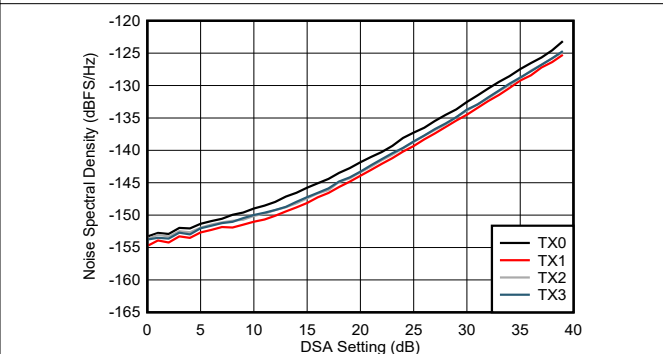
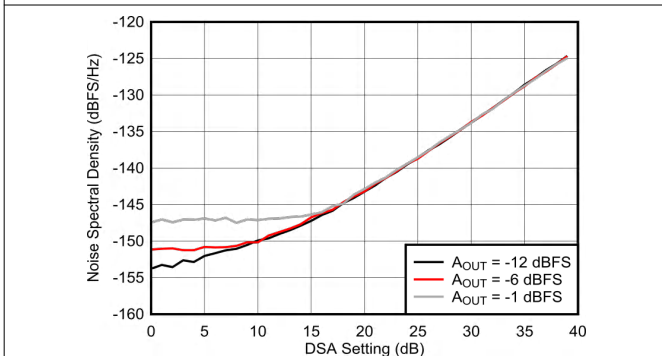

Figure 7-579. IMD3 vs Tone Spacing and Temperature at 7.1 GHz



Tone at -12 dBFS, 50 MHz offset from tone

Figure 7-580. NSD vs DSA Setting and Channel at 7.1 GHz



50 MHz offset from tone

Figure 7-581. NSD vs DSA Setting and Amplitude at 7.1 GHz

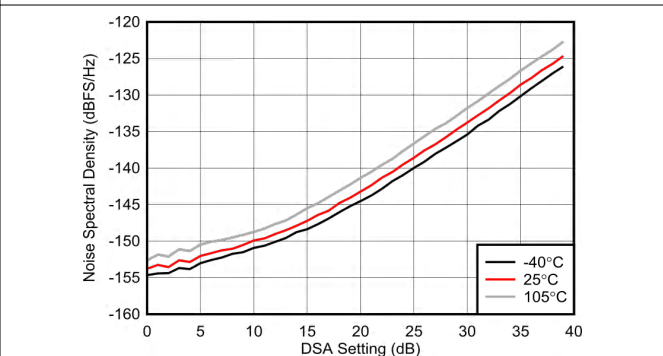

Tone at -12 dBFS, 50 MHz offset from tone

Figure 7-582. NSD vs DSA Setting and Temperature at 7.1 GHz

7.12.14 TX Typical Characteristics at 7.1 GHz (continued)

Typical values at $T_A = +25^\circ\text{C}$ with nominal supplies. Unless otherwise noted, TX input data rate = 500 MSPS, $f_{\text{DAC}} = 9000$ MSPS, non-interleave mode, $A_{\text{OUT}} = -1$ dBFS, 2nd Nyquist zone output, External clock mode, 18x Interpolation, DSA = 0 dB, $\text{Sin}(x)/x$ enabled, DSA calibrated, 7.1 GHz matching.

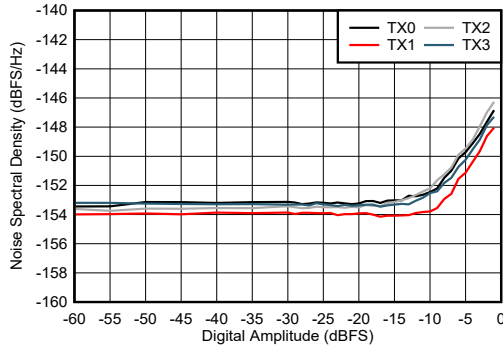

50MHz offset from tone

Figure 7-583. NSD vs Digital Amplitude and Channel at 7.1 GHz

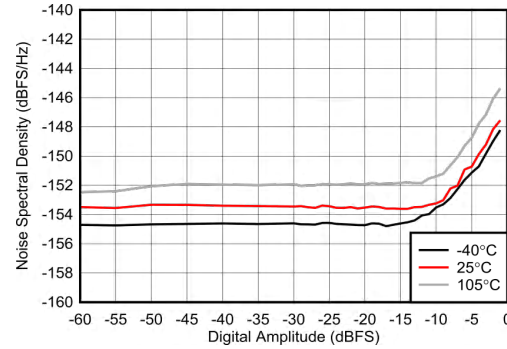

50MHz offset from tone

Figure 7-584. NSD vs Digital Amplitude and Temperature at 7.1 GHz

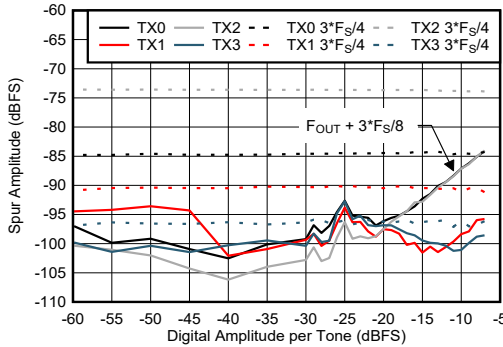

Inband = 7100 MHz \pm 600 MHz, excluding IMD3 components, 3 x $F_s/4$ spur not included and shown separately

Figure 7-585. Two Tone Inband SFDR vs Digital Amplitude at 7.1 GHz

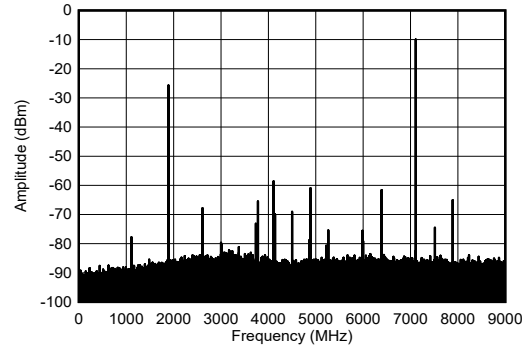

Figure 7-586. Single Tone Output Spectrum at 7.1 GHz, -1 dBFS (0 - F_{DAC})

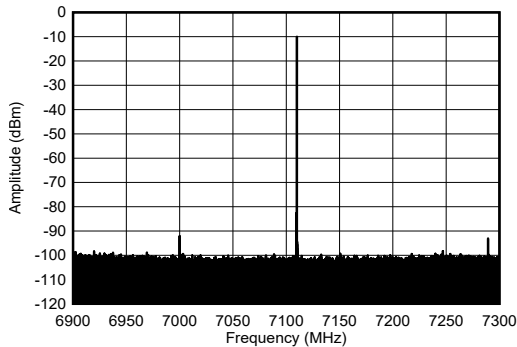

Figure 7-587. Single Tone Output Spectrum at 7.1 GHz, -1 dBFS (Inband)

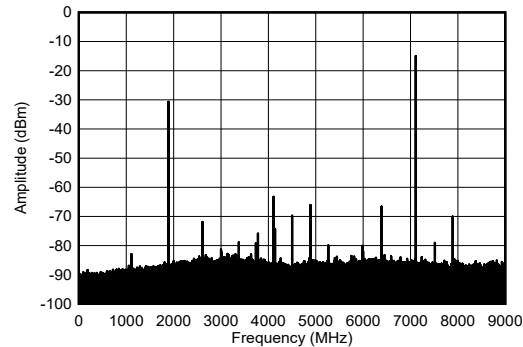

Figure 7-588. Single Tone Output Spectrum at 7.1 GHz, -6 dBFS (0 - F_{DAC})

7.12.14 TX Typical Characteristics at 7.1 GHz (continued)

Typical values at $T_A = +25^\circ\text{C}$ with nominal supplies. Unless otherwise noted, TX input data rate = 500 MSPS, $f_{\text{DAC}} = 9000$ MSPS, non-interleave mode, $A_{\text{OUT}} = -1$ dBFS, 2nd Nyquist zone output, External clock mode, 18x Interpolation, DSA = 0 dB, Sin(x)/x enabled, DSA calibrated, 7.1 GHz matching.

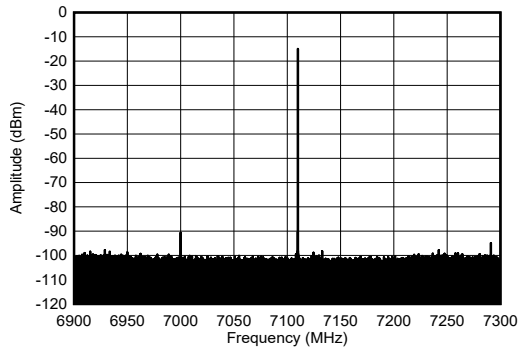

Figure 7-589. Single Tone Output Spectrum at 7.1 GHz, -6 dBFS (Inband)

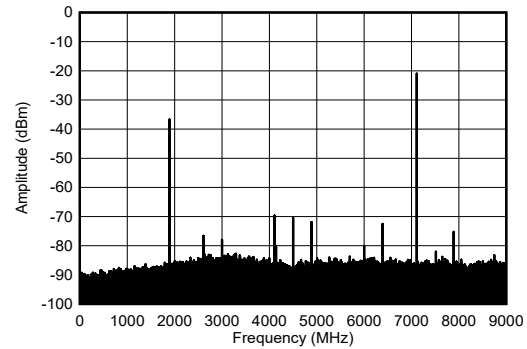

Figure 7-590. Single Tone Output Spectrum at 7.1 GHz, -12 dBFS (0 - F_{DAC})

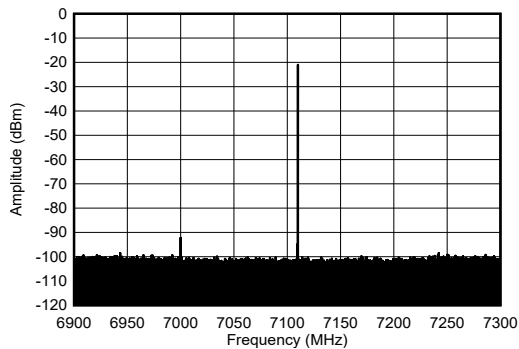
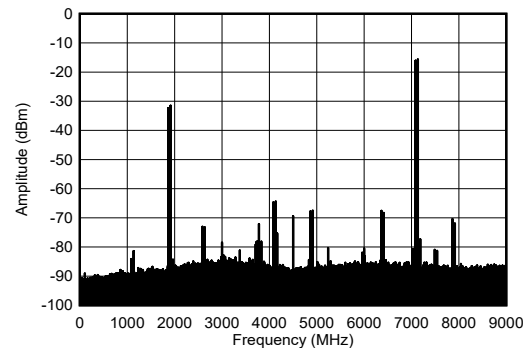
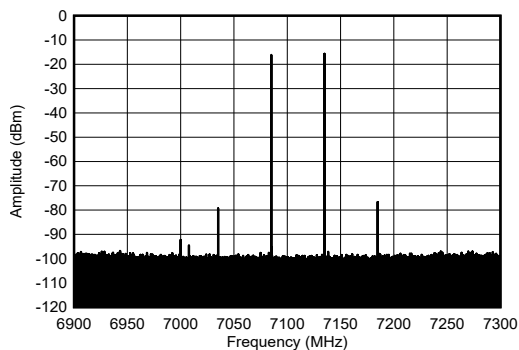

Figure 7-591. Single Tone Output Spectrum at 7.1 GHz, -12 dBFS (Inband)



50MHz Tone Spacing

Figure 7-592. Two Tone Output Spectrum at 7.1 GHz, -7 dBFS each (0 - F_{DAC})



50MHz Tone Spacing

Figure 7-593. Two Tone Output Spectrum at 7.1 GHz, -7 dBFS each (Inband)

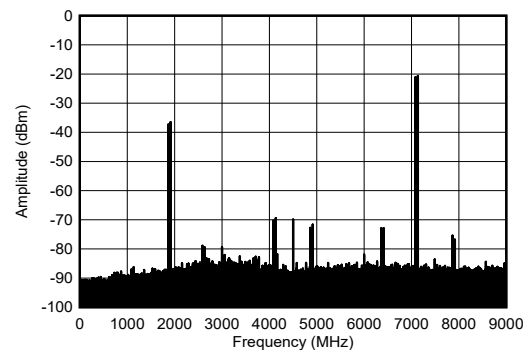

50 MHz Tone Spacing

Figure 7-594. Two Tone Output Spectrum at 7.1 GHz, -12 dBFS each (0 - F_{DAC})

7.12.14 TX Typical Characteristics at 7.1 GHz (continued)

Typical values at $T_A = +25^\circ\text{C}$ with nominal supplies. Unless otherwise noted, TX input data rate = 500 MSPS, $f_{\text{DAC}} = 9000$ MSPS, non-interleave mode, $A_{\text{OUT}} = -1$ dBFS, 2nd Nyquist zone output, External clock mode, 18x Interpolation, DSA = 0 dB, Sin(x)/x enabled, DSA calibrated, 7.1 GHz matching.

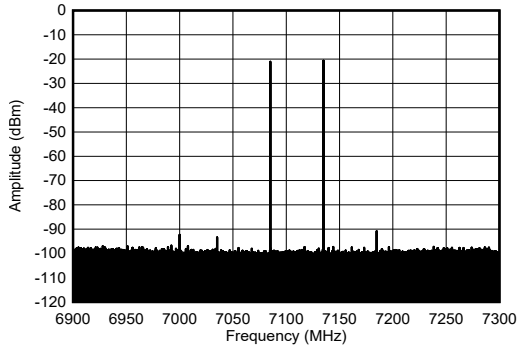

50MHz Tone Spacing

Figure 7-595. Two Tone Output Spectrum at 7.1 GHz, -12 dBFS each (Inband)

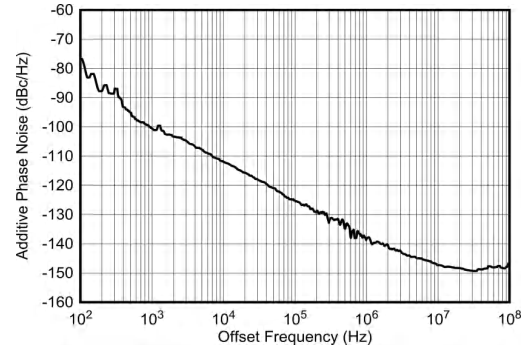
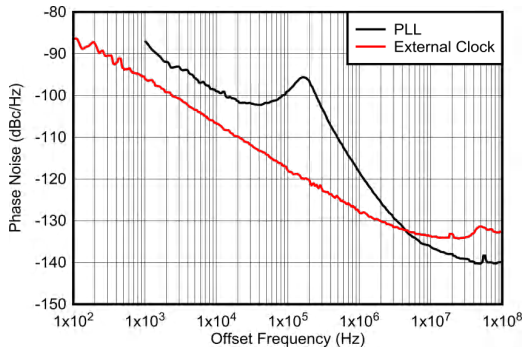

Figure 7-596. External Clock Additive Phase Noise at 7.1 GHz

7.12.15 PLL and Clock Typical Characteristics



measured at TX output, normalized to 12 GHz by $20 \times \log_{10}(12 \text{ GHz}/F_{\text{OUT}})$

Figure 7-597. Phase Noise vs Offset Frequency for PLL and External Clock at 12 GHz

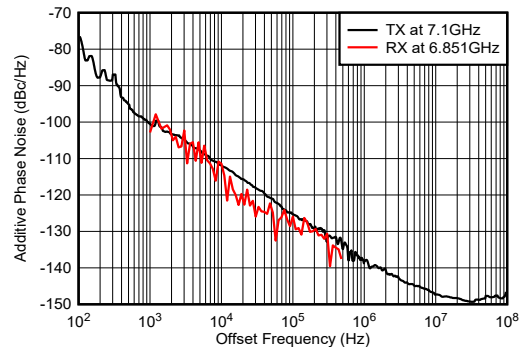
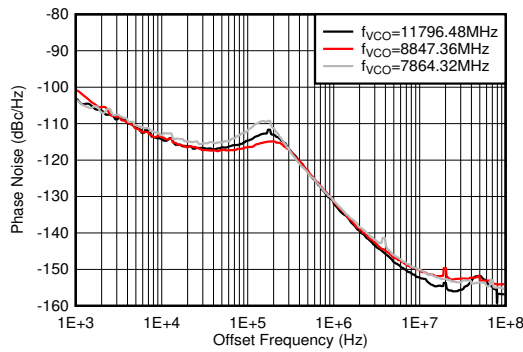
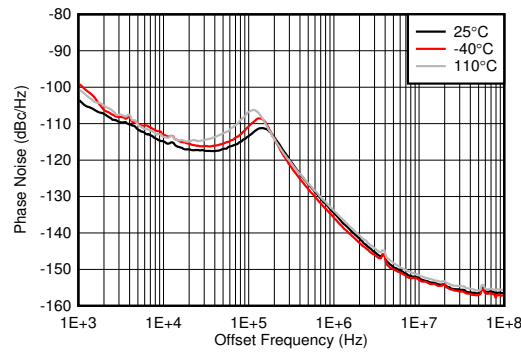

Figure 7-598. TX vs RX Additive Phase Noise at 7G Hz



PLL enabled, $f_{\text{REF}} = 491.52 \text{ MSPS}$, measured at 2TXOUT

Figure 7-599. Phase Noise vs Offset Frequency and f_{VCO} at $f_{\text{OUT}} = 2610 \text{ MHz}$



PLL enabled, $f_{\text{VCO}} = 11796.48 \text{ MHz}$, $f_{\text{REF}} = 491.52 \text{ MSPS}$, measured at 2TXOUT

Figure 7-600. Phase Noise for 12-GHz VCO vs Offset Frequency and Temperature at $f_{\text{OUT}} = 1910 \text{ MHz}$

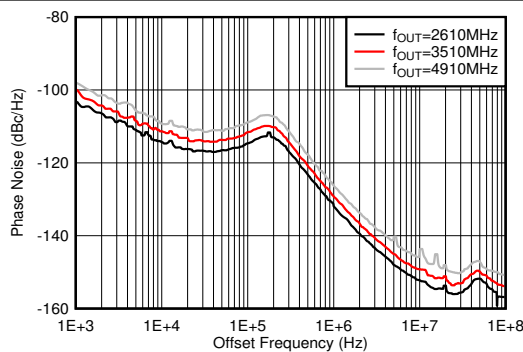

PLL enabled, $f_{\text{VCO}} = 11796.48 \text{ MHz}$, $f_{\text{REF}} = 491.52 \text{ MSPS}$, measured at 2TXOUT

Figure 7-601. Phase Noise for 12-GHz VCO vs Offset Frequency and f_{OUT} at 25°C

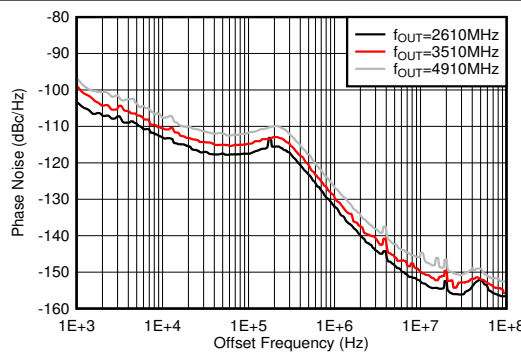

PLL enabled, $f_{\text{VCO}} = 11796.48 \text{ MHz}$, $f_{\text{REF}} = 491.52 \text{ MSPS}$, measured at 2TXOUT

Figure 7-602. Phase Noise for 12-GHz VCO vs Offset Frequency and f_{OUT} at -40°C

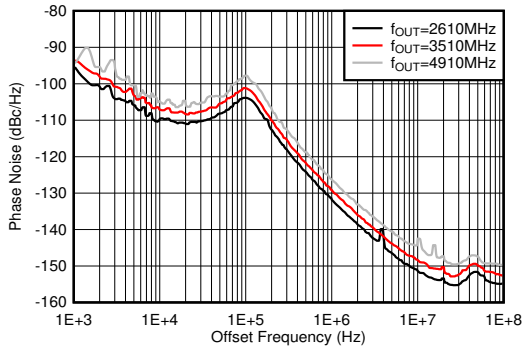

PLL enabled, $f_{VCO} = 11796.48$ MHz, $f_{REF} = 491.52$ MSPS, measured at 2TXOUT

Figure 7-603. Phase Noise for 12-GHz VCO vs Offset Frequency and f_{OUT} at 110°C

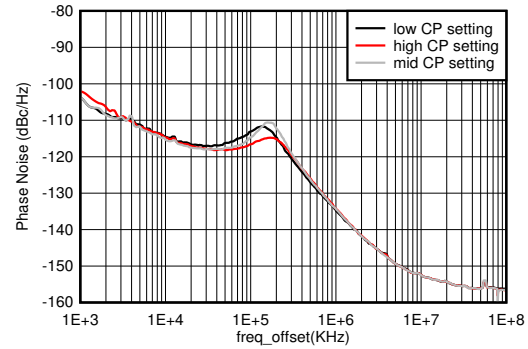

PLL enabled, $f_{VCO} = 11796.48$ MHz, $f_{REF} = 491.52$ MSPS, measured at 2TXOUT

Figure 7-604. Phase Noise for 12-GHz VCO vs Offset Frequency and CP Setting at $f_{OUT} = 2.6$ GHz

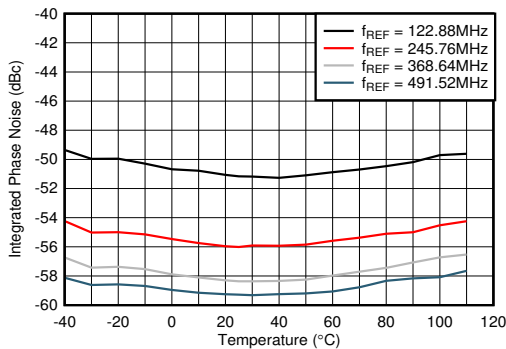

PLL enabled, $f_{VCO} = 11796.48$ MHz, 1-kHz to 100-MHz, single-sided integration bandwidth, measured at 2TXOUT

Figure 7-605. Integrated Phase Noise for 12-GHz VCO vs Temperature and f_{REF} at $f_{OUT} = 2.6$ GHz

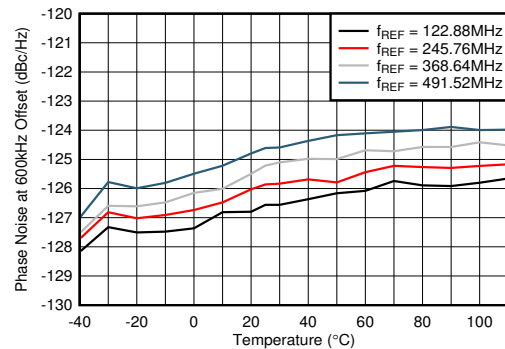

PLL enabled, $f_{VCO} = 11796.48$ MHz, measured at 2TXOUT

Figure 7-606. Phase Noise for 12-GHz VCO at 600 kHz Offset vs Temperature and f_{REF} at $f_{OUT} = 2.6$ GHz

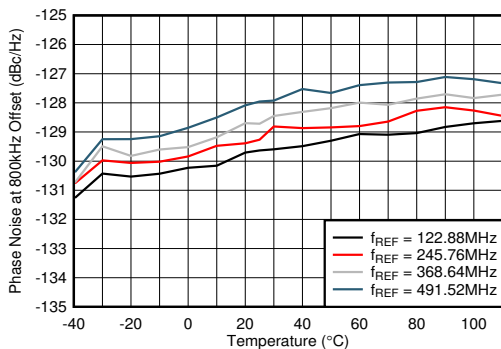

A. PLL enabled, $f_{VCO} = 11796.48$ MHz, measured at 2TXOUT

Figure 7-607. Phase Noise for 12-GHz VCO at 800-kHz Offset vs Temperature and f_{REF} at $f_{OUT} = 2.6$ GHz

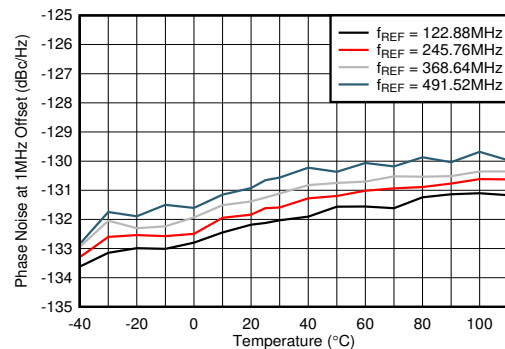

PLL enabled, $f_{VCO} = 11796.48$ MHz, measured at 2TXOUT

Figure 7-608. Phase Noise for 12-GHz VCO at 1-MHz Offset vs Temperature and f_{REF} at $f_{OUT} = 2.6$ GHz

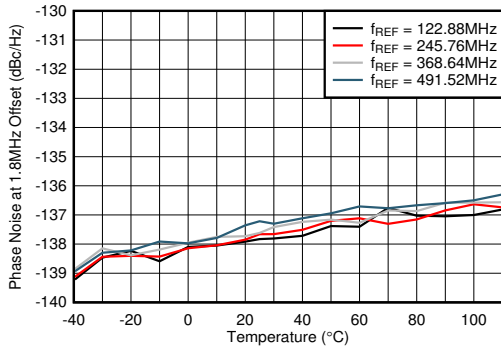

PLL enabled, $f_{VCO} = 11796.48$ MHz, measured at 2TXOUT

Figure 7-609. Phase Noise for 12-GHz VCO at 1.8-MHz Offset vs Temperature and f_{REF} at $f_{OUT} = 2.6$ GHz

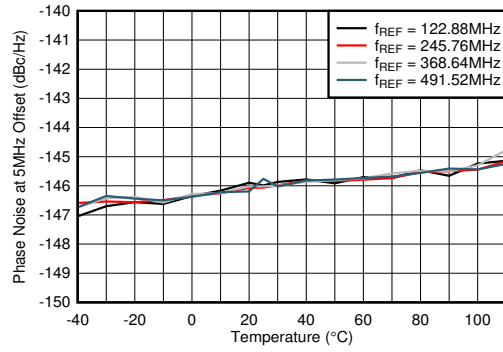

PLL enabled, $f_{VCO} = 11796.48$ MHz, measured at 2TXOUT

Figure 7-610. Phase Noise for 12-GHz VCO at 5-MHz Offset vs Temperature and f_{REF} at $f_{OUT} = 2.6$ GHz

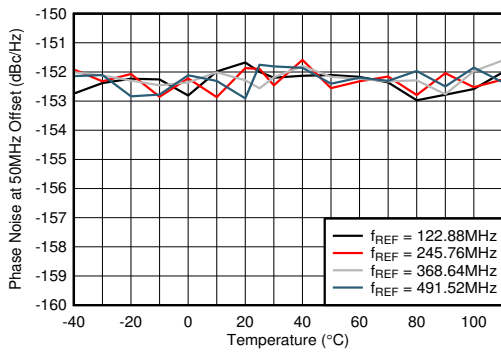

PLL enabled, $f_{VCO} = 11796.48$ MHz, measured at 2TXOUT

Figure 7-611. Phase Noise for 12-GHz VCO at 50-MHz Offset vs Temperature and f_{REF} at $f_{OUT} = 2.6$ GHz

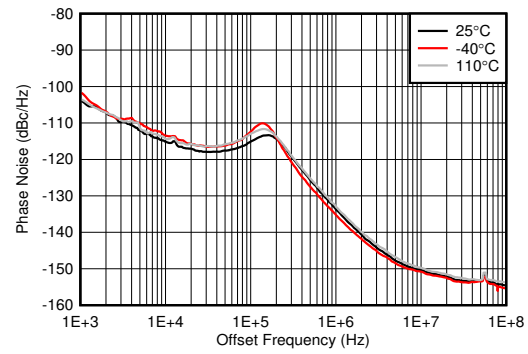

PLL enabled, $f_{VCO} = 9830.4$ MHz, $f_{REF} = 491.52$ MSPS, measured at 2TXOUT

Figure 7-612. Phase Noise for 10-GHz VCO vs Offset Frequency and Temperature at $f_{OUT} = 1910$ MHz

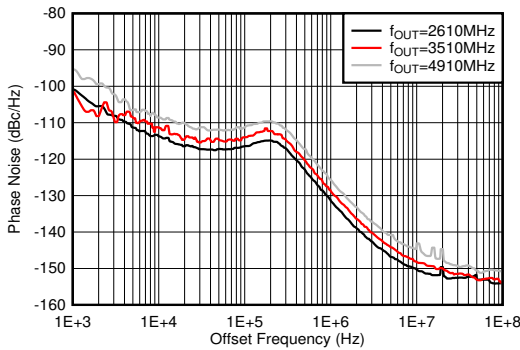

PLL enabled, $f_{VCO} = 9830.4$ MHz, $f_{REF} = 491.52$ MSPS, measured at 2TXOUT

Figure 7-613. Phase Noise for 10-GHz VCO vs Offset Frequency and f_{OUT} at 25°C

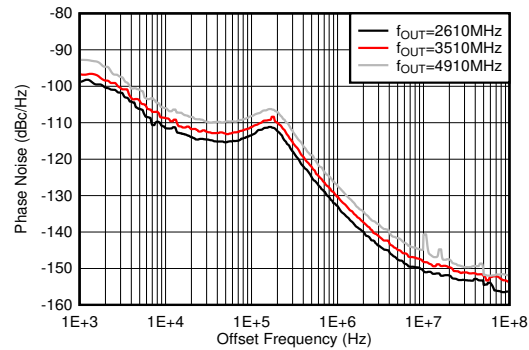

PLL enabled, $f_{VCO} = 9830.4$ MHz, $f_{REF} = 491.52$ MSPS, measured at 2TXOUT

Figure 7-614. Phase Noise for 10-GHz VCO vs Offset Frequency and f_{OUT} at -40°C

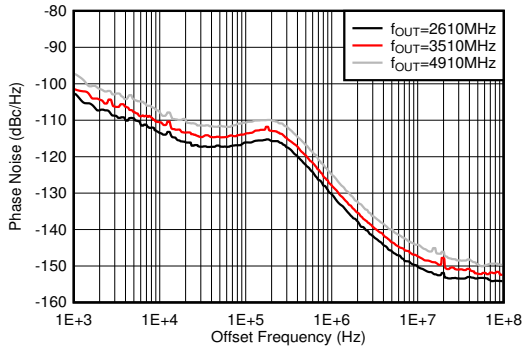

PLL enabled, $f_{VCO} = 9830.4$ MHz, $f_{REF} = 491.52$ MSPS, measured at 2TXOUT

Figure 7-615. Phase Noise for 10-GHz VCO vs Offset Frequency and f_{OUT} at 110°C

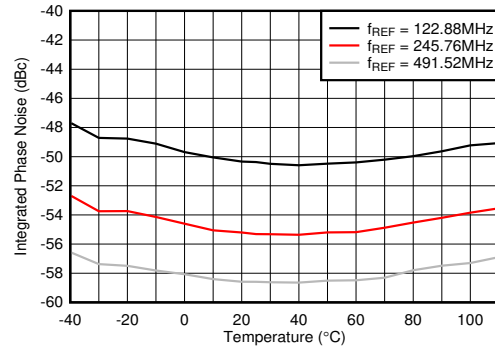

PLL enabled, $f_{VCO} = 9830.4$ MHz, 1-kHz to 100-MHz, single-sided integration bandwidth, measured at 2TXOUT

Figure 7-616. Integrated Phase Noise for 10-GHz VCO vs Temperature and f_{REF} at $f_{OUT} = 2.6$ GHz

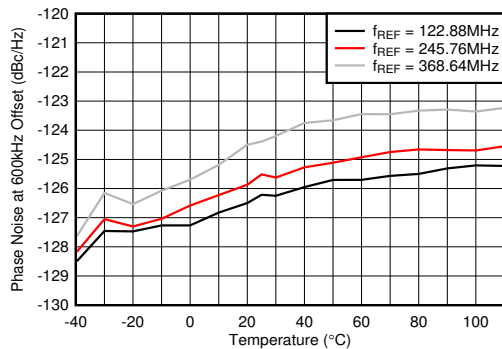

PLL enabled, $f_{VCO} = 9830.4$ MHz, measured at 2TXOUT

Figure 7-617. Phase Noise for 10-GHz VCO at 600 kHz vs Temperature and f_{REF} at $f_{OUT} = 2.6$ GHz

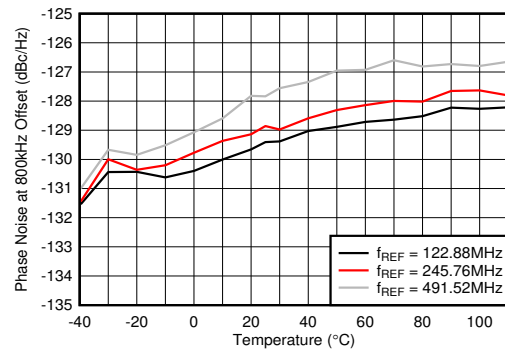

PLL enabled, $f_{VCO} = 9830.4$ MHz, measured at 2TXOUT

Figure 7-618. Phase Noise for 10-GHz VCO at 800 kHz vs Temperature and f_{REF} at $f_{OUT} = 2.6$ GHz

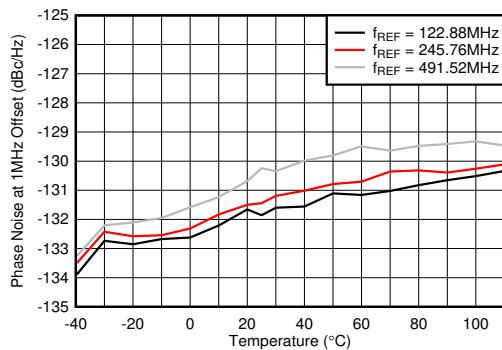

PLL enabled, $f_{VCO} = 9830.4$ MHz, measured at 2TXOUT

Figure 7-619. Phase Noise for 10-GHz VCO at 1 MHz vs Temperature and f_{REF} at $f_{OUT} = 2.6$ GHz

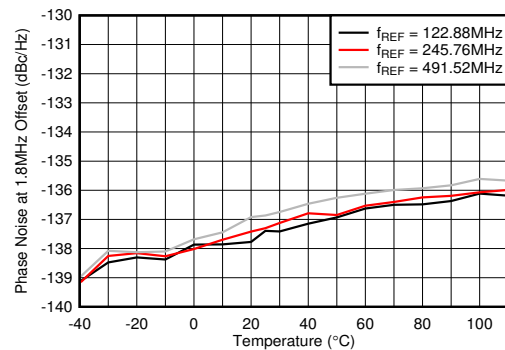

PLL enabled, $f_{VCO} = 9830.4$ MHz, measured at 2TXOUT

Figure 7-620. Phase Noise for 10-GHz VCO at 1.8 MHz vs Temperature and f_{REF} at $f_{OUT} = 2.6$ GHz

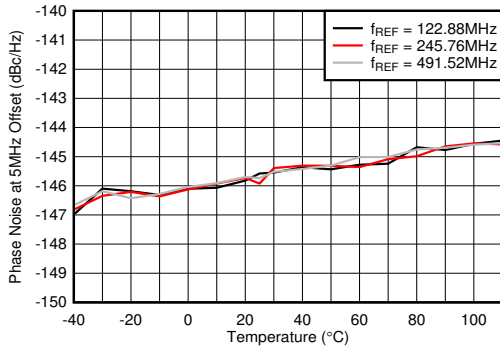

PLL enabled, $f_{VCO} = 9830.4$ MHz, measured at 2TXOUT

Figure 7-621. Phase Noise for 10-GHz VCO at 5 MHz vs Temperature and f_{REF} at $f_{OUT} = 2.6$ GHz

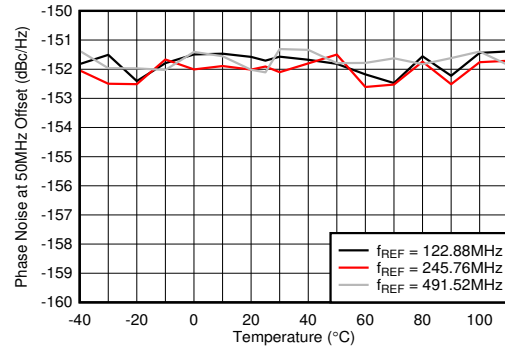

PLL enabled, $f_{VCO} = 9830.4$ MHz, measured at 2TXOUT

Figure 7-622. Phase Noise for 10-GHz VCO at 50 MHz vs Temperature and f_{REF} at $f_{OUT} = 2.6$ GHz

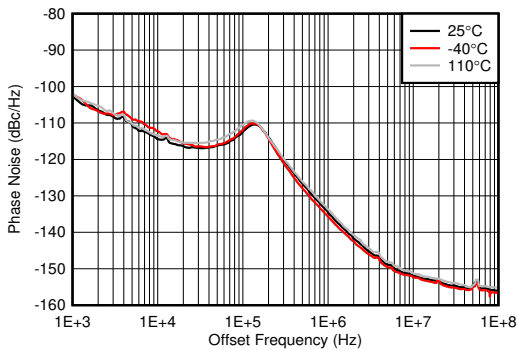

PLL enabled, $f_{VCO} = 8847.36$ MHz, $f_{REF} = 491.52$ MSPS, measured at 2TXOUT

Figure 7-623. Phase Noise for 9-GHz VCO vs Offset Frequency and Temperature at $f_{OUT} = 1910$ MHz

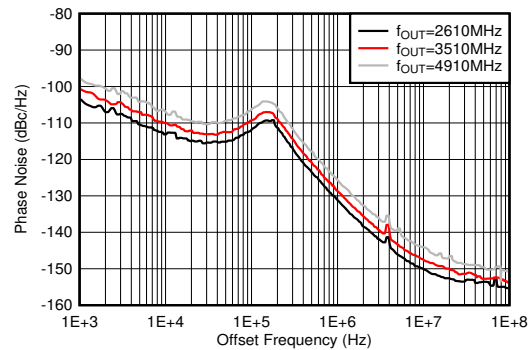

PLL enabled, $f_{VCO} = 8847.36$ MHz, $f_{REF} = 491.52$ MSPS, measured at 2TXOUT

Figure 7-624. Phase Noise for 9-GHz VCO vs Offset Frequency and f_{OUT} at 25°C

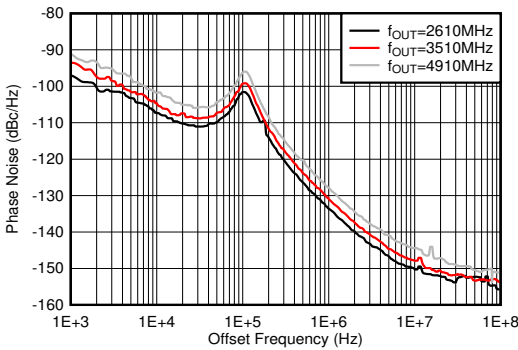

PLL enabled, $f_{VCO} = 8847.36$ MHz, $f_{REF} = 491.52$ MSPS, measured at 2TXOUT

Figure 7-625. Phase Noise for 9-GHz VCO vs Offset Frequency and f_{OUT} at -40°C

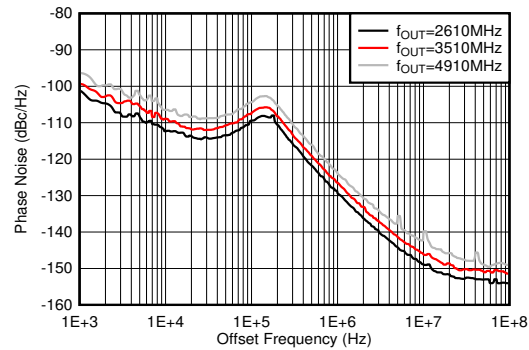

PLL enabled, $f_{VCO} = 8847.36$ MHz, $f_{REF} = 491.52$ MSPS, measured at 2TXOUT

Figure 7-626. Phase Noise for 9-GHz VCO vs Offset Frequency and f_{OUT} at 110°C

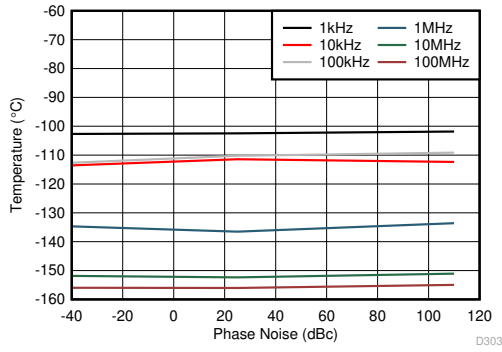

PLL enabled, $f_{VCO} = 8847.36$ MHz, $f_{REF} = 491.52$ MSPS, minimum LPF BW, measured at 2TXOUT

Figure 7-627. Phase Noise for 9-GHz VCO vs Temperature Over Offset Frequency at $f_{OUT} = 2.6$ GHz

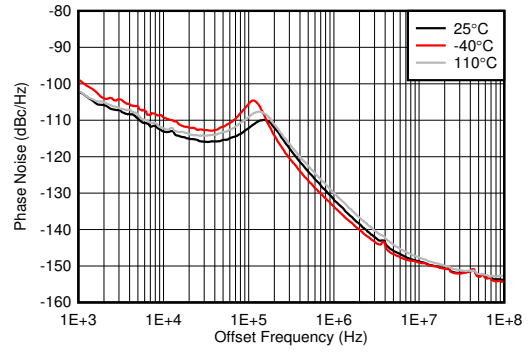

PLL enabled, $f_{VCO} = 7864.32$ MHz, $f_{REF} = 491.52$ MSPS, measured at 2TXOUT

Figure 7-628. Phase Noise for 8-GHz VCO vs Offset Frequency and Temperature at $f_{OUT} = 1910$ MHz

8 Device and Documentation Support

8.1 Receiving Notification of Documentation Updates

To receive notification of documentation updates, navigate to the device product folder on [ti.com](https://www.ti.com). Click on *Subscribe to updates* to register and receive a weekly digest of any product information that has changed. For change details, review the revision history included in any revised document.

8.2 Support Resources

TI E2E™ [support forums](#) are an engineer's go-to source for fast, verified answers and design help — straight from the experts. Search existing answers or ask your own question to get the quick design help you need.

Linked content is provided "AS IS" by the respective contributors. They do not constitute TI specifications and do not necessarily reflect TI's views; see TI's [Terms of Use](#).

8.3 Trademarks

TI E2E™ is a trademark of Texas Instruments.

All trademarks are the property of their respective owners.

8.4 Electrostatic Discharge Caution



This integrated circuit can be damaged by ESD. Texas Instruments recommends that all integrated circuits be handled with appropriate precautions. Failure to observe proper handling and installation procedures can cause damage.

ESD damage can range from subtle performance degradation to complete device failure. Precision integrated circuits may be more susceptible to damage because very small parametric changes could cause the device not to meet its published specifications.

8.5 Glossary

[TI Glossary](#) This glossary lists and explains terms, acronyms, and definitions.

9 Mechanical, Packaging, and Orderable Information

The following pages include mechanical, packaging, and orderable information. This information is the most current data available for the designated devices. This data is subject to change without notice and revision of this document. For browser-based versions of this data sheet, refer to the left-hand navigation.

PACKAGING INFORMATION

Orderable Device	Status (1)	Package Type	Package Drawing	Pins	Package Qty	Eco Plan (2)	Lead finish/ Ball material (6)	MSL Peak Temp (3)	Op Temp (°C)	Device Marking (4/5)	Samples
AFE7901IABJ	ACTIVE	FCBGA	ABJ	400	90	RoHS & Green	SNAGCU	Level-3-260C-168 HR	-40 to 85	AFE79011	Samples
AFE7901IALK	ACTIVE	FCBGA	ALK	400	90	Non-RoHS & Green	Call TI	Level-3-220C-168 HR	-40 to 85	AFE7901 SNPB	Samples

(1) The marketing status values are defined as follows:

ACTIVE: Product device recommended for new designs.

LIFEBUY: TI has announced that the device will be discontinued, and a lifetime-buy period is in effect.

NRND: Not recommended for new designs. Device is in production to support existing customers, but TI does not recommend using this part in a new design.

PREVIEW: Device has been announced but is not in production. Samples may or may not be available.

OBSOLETE: TI has discontinued the production of the device.

(2) **RoHS:** TI defines "RoHS" to mean semiconductor products that are compliant with the current EU RoHS requirements for all 10 RoHS substances, including the requirement that RoHS substance do not exceed 0.1% by weight in homogeneous materials. Where designed to be soldered at high temperatures, "RoHS" products are suitable for use in specified lead-free processes. TI may reference these types of products as "Pb-Free".

RoHS Exempt: TI defines "RoHS Exempt" to mean products that contain lead but are compliant with EU RoHS pursuant to a specific EU RoHS exemption.

Green: TI defines "Green" to mean the content of Chlorine (Cl) and Bromine (Br) based flame retardants meet JS709B low halogen requirements of <=1000ppm threshold. Antimony trioxide based flame retardants must also meet the <=1000ppm threshold requirement.

(3) MSL, Peak Temp. - The Moisture Sensitivity Level rating according to the JEDEC industry standard classifications, and peak solder temperature.

(4) There may be additional marking, which relates to the logo, the lot trace code information, or the environmental category on the device.

(5) Multiple Device Markings will be inside parentheses. Only one Device Marking contained in parentheses and separated by a "-" will appear on a device. If a line is indented then it is a continuation of the previous line and the two combined represent the entire Device Marking for that device.

(6) Lead finish/Ball material - Orderable Devices may have multiple material finish options. Finish options are separated by a vertical ruled line. Lead finish/Ball material values may wrap to two lines if the finish value exceeds the maximum column width.

Important Information and Disclaimer:The information provided on this page represents TI's knowledge and belief as of the date that it is provided. TI bases its knowledge and belief on information provided by third parties, and makes no representation or warranty as to the accuracy of such information. Efforts are underway to better integrate information from third parties. TI has taken and continues to take reasonable steps to provide representative and accurate information but may not have conducted destructive testing or chemical analysis on incoming materials and chemicals. TI and TI suppliers consider certain information to be proprietary, and thus CAS numbers and other limited information may not be available for release.

In no event shall TI's liability arising out of such information exceed the total purchase price of the TI part(s) at issue in this document sold by TI to Customer on an annual basis.

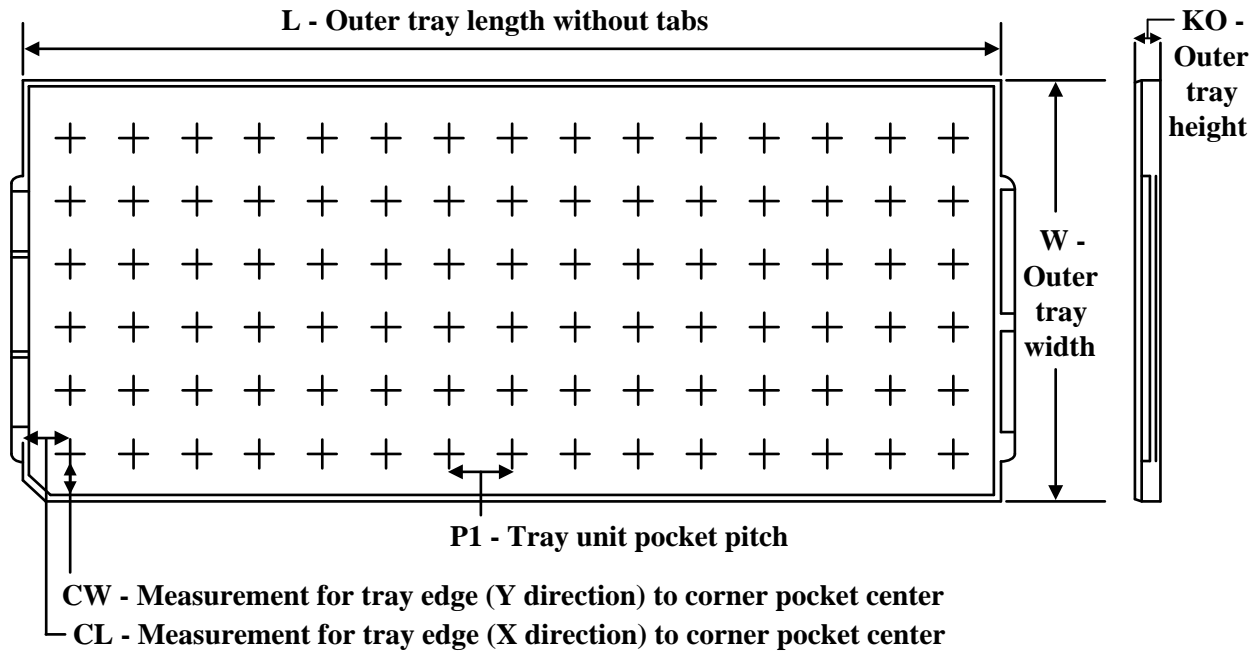
TRAY

Chamfer on Tray corner indicates Pin 1 orientation of packed units.

*All dimensions are nominal

Device	Package Name	Package Type	Pins	SPQ	Unit array matrix	Max temperature (°C)	L (mm)	W (mm)	K0 (µm)	P1 (mm)	CL (mm)	CW (mm)
AFE7901IABJ	ABJ	FCBGA	400	90	6 x 15	150	315	135.9	7620	19.5	21	19.2
AFE7901IABJ	ABJ	FCBGA	400	90	6 x 15	150	315	135.9	7620	19.5	21	19.2
AFE7901IALK	ALK	FCBGA	400	90	6 x 15	150	315	135.9	7620	19.5	21	19.2
AFE7901IALK	ALK	FCBGA	400	90	6 x 15	150	315	135.9	7620	19.5	21	19.2

ALK0400A

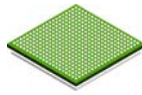

PACKAGE OUTLINE

FCBGA - 2.65 mm max height

BALL GRID ARRAY

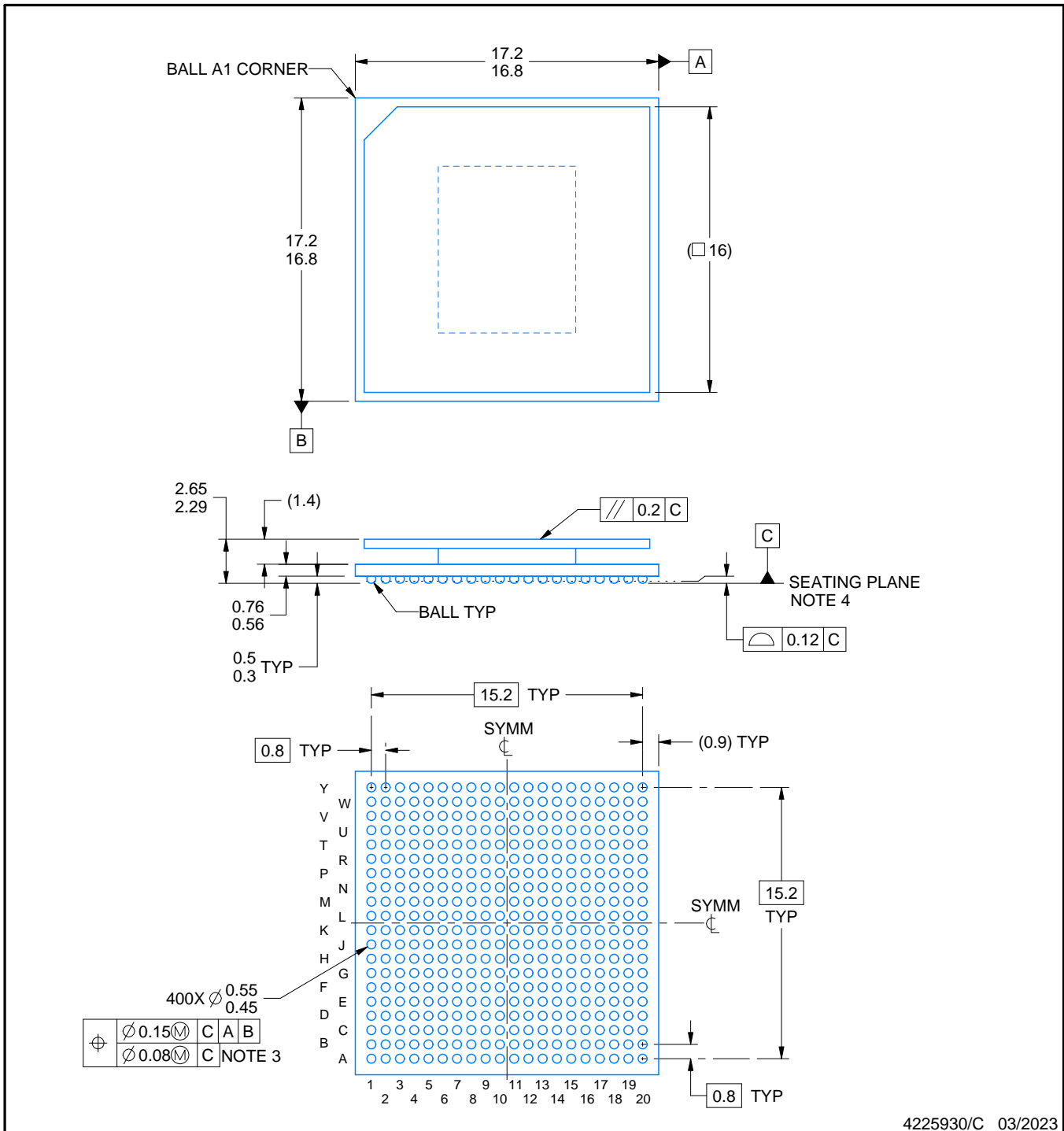

NOTES:

1. All linear dimensions are in millimeters. Any dimensions in parenthesis are for reference only. Dimensioning and tolerancing per ASME Y14.5M.
2. This drawing is subject to change without notice.
3. Dimension is measured at the maximum solder ball diameter, parallel to primary datum C.
4. Primary datum C and seating plane are defined by the spherical crowns of the solder balls.
5. Pb-Free die bump and SnPb solder ball.
6. The lids are electrically floating (e.g. not tied to GND).

EXAMPLE BOARD LAYOUT

ALK0400A

FCBGA - 2.65 mm max height

BALL GRID ARRAY

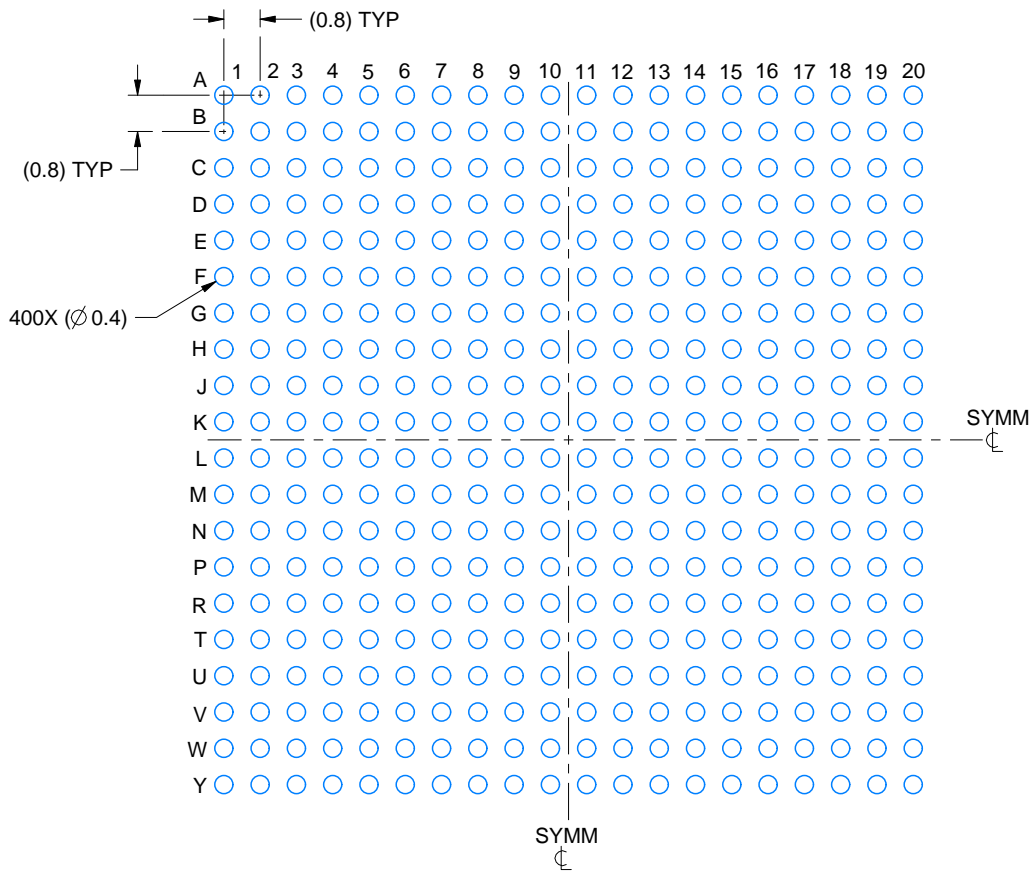

LAND PATTERN EXAMPLE
EXPOSED METAL SHOWN
SCALE:6X

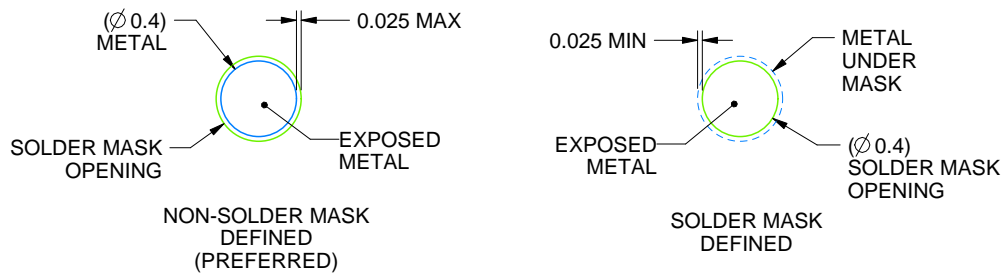

SOLDER MASK DETAILS
NOT TO SCALE

4225930/C 03/2023

NOTES: (continued)

- Final dimensions may vary due to manufacturing tolerance considerations and also routing constraints. For more information, see Texas Instruments literature number SPRU811 (www.ti.com/lit/spru811).

EXAMPLE STENCIL DESIGN

ALK0400A

FCBGA - 2.65 mm max height

BALL GRID ARRAY

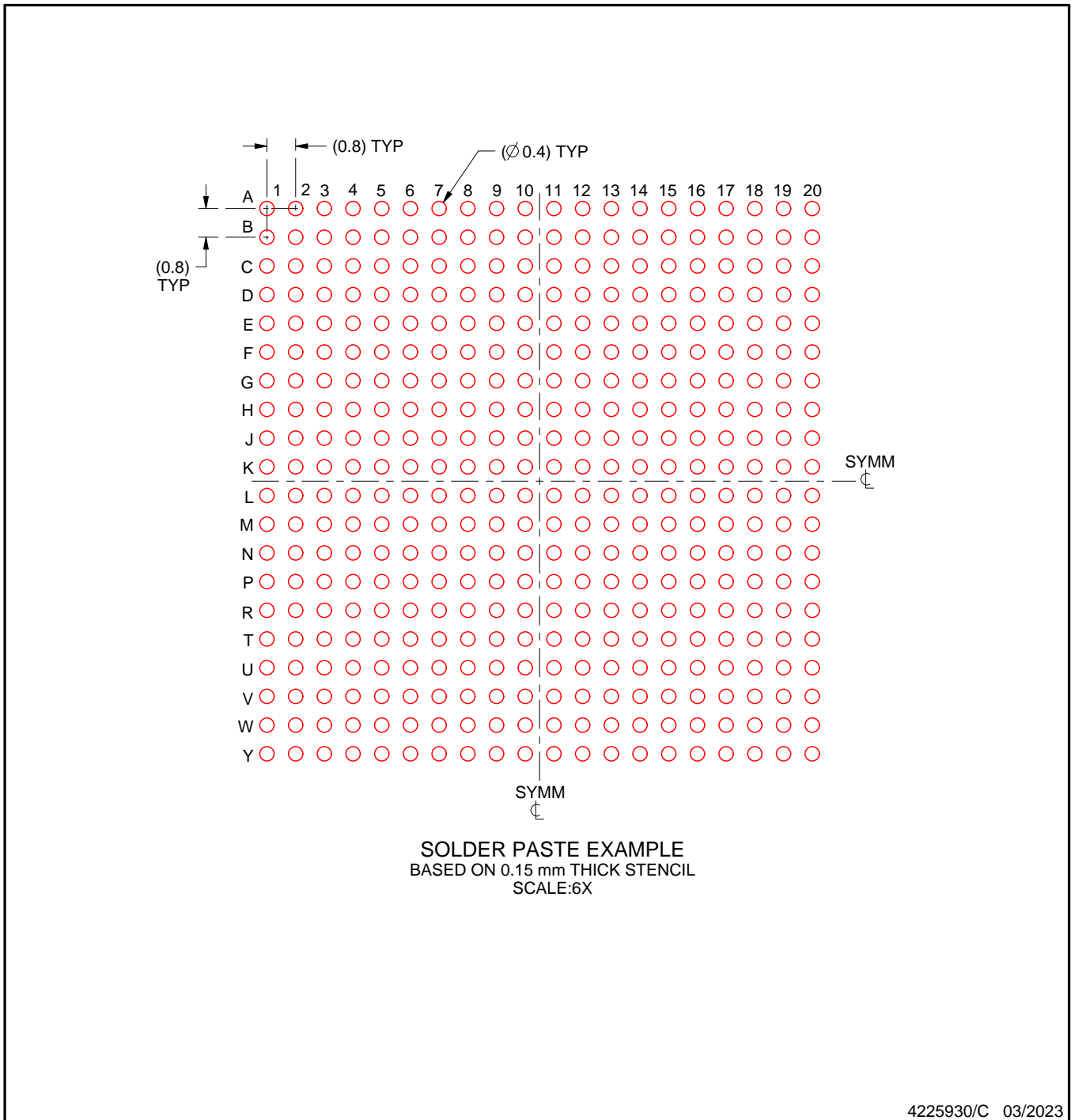

NOTES: (continued)

8. Laser cutting apertures with trapezoidal walls and rounded corners may offer better paste release.

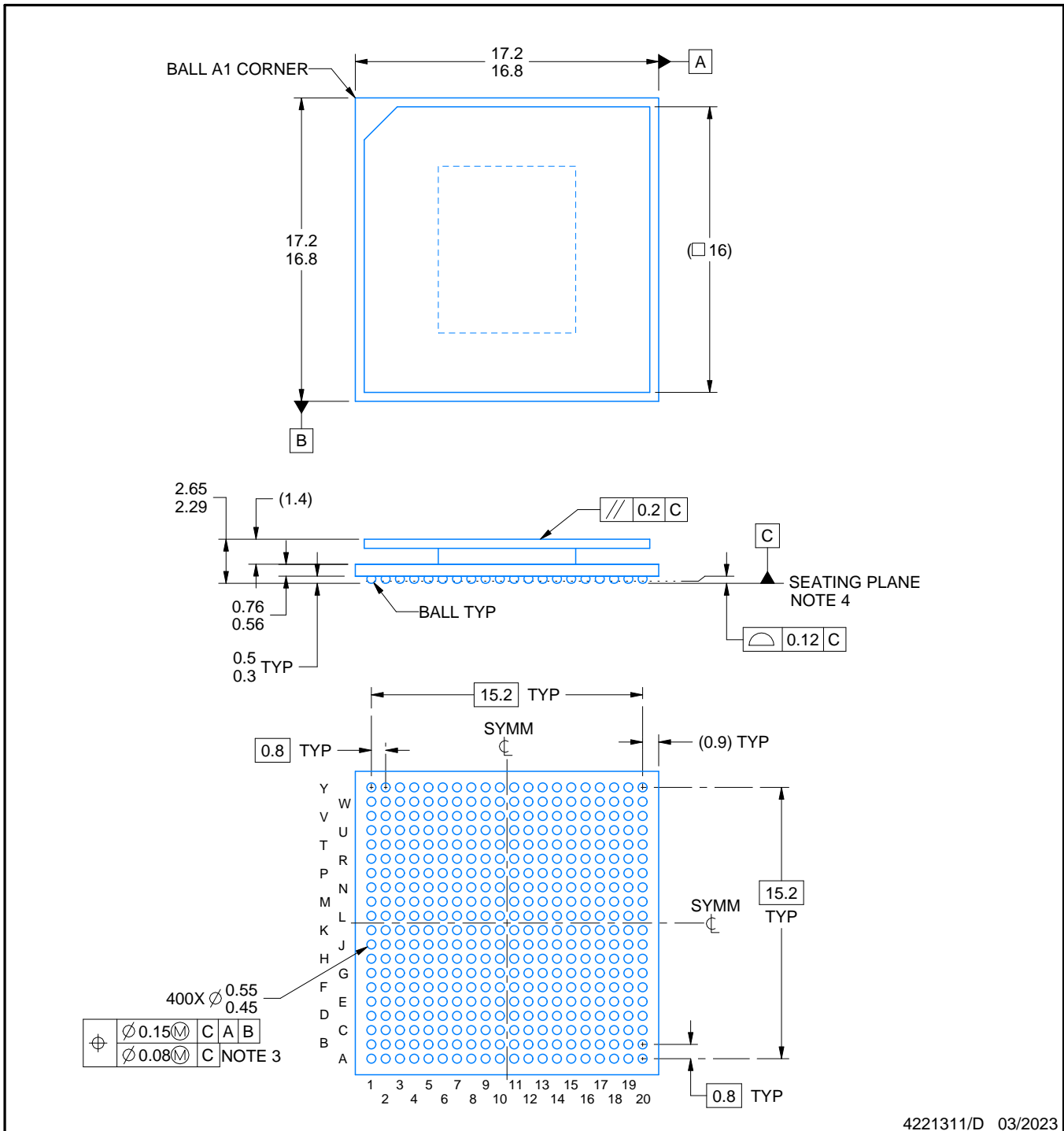
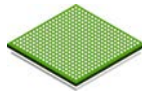

4221311/D 03/2023

NOTES:

1. All linear dimensions are in millimeters. Any dimensions in parenthesis are for reference only. Dimensioning and tolerancing per ASME Y14.5M.
2. This drawing is subject to change without notice.
3. Dimension is measured at the maximum solder ball diameter, parallel to primary datum C.
4. Primary datum C and seating plane are defined by the spherical crowns of the solder balls.
5. The lids are electrically floating (e.g. not tied to GND).

EXAMPLE BOARD LAYOUT

ABJ0400A

FCBGA - 2.65 mm max height

BALL GRID ARRAY

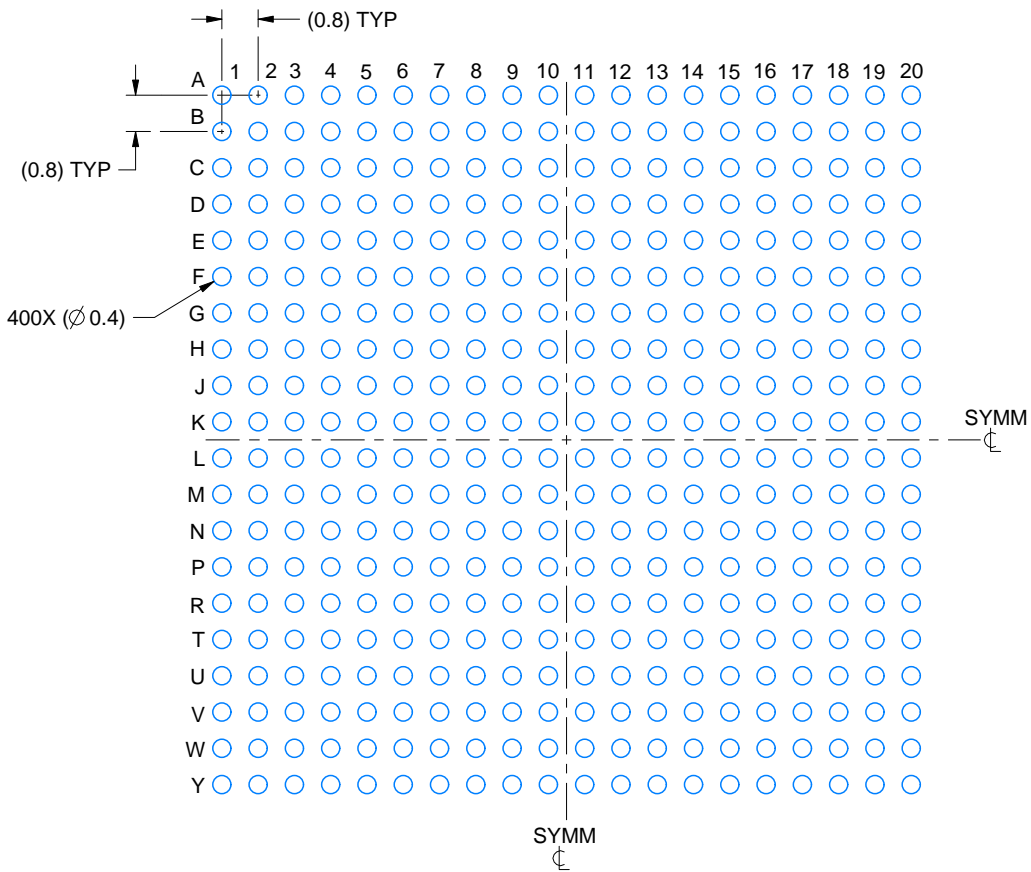

LAND PATTERN EXAMPLE
EXPOSED METAL SHOWN
SCALE:6X

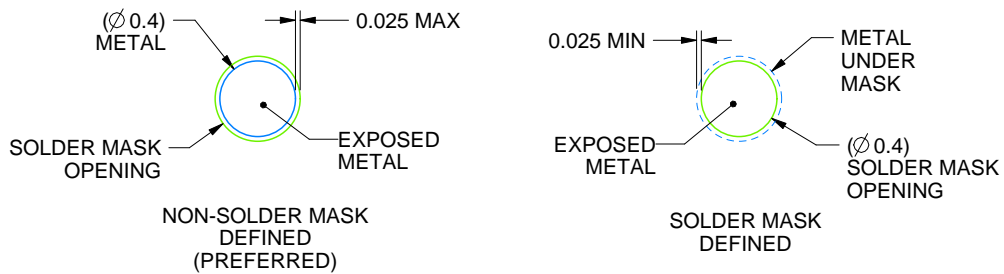

SOLDER MASK DETAILS
NOT TO SCALE

4221311/D 03/2023

NOTES: (continued)

- Final dimensions may vary due to manufacturing tolerance considerations and also routing constraints. For more information, see Texas Instruments literature number SPRU811 (www.ti.com/lit/spru811).

EXAMPLE STENCIL DESIGN

ABJ0400A

FCBGA - 2.65 mm max height

BALL GRID ARRAY

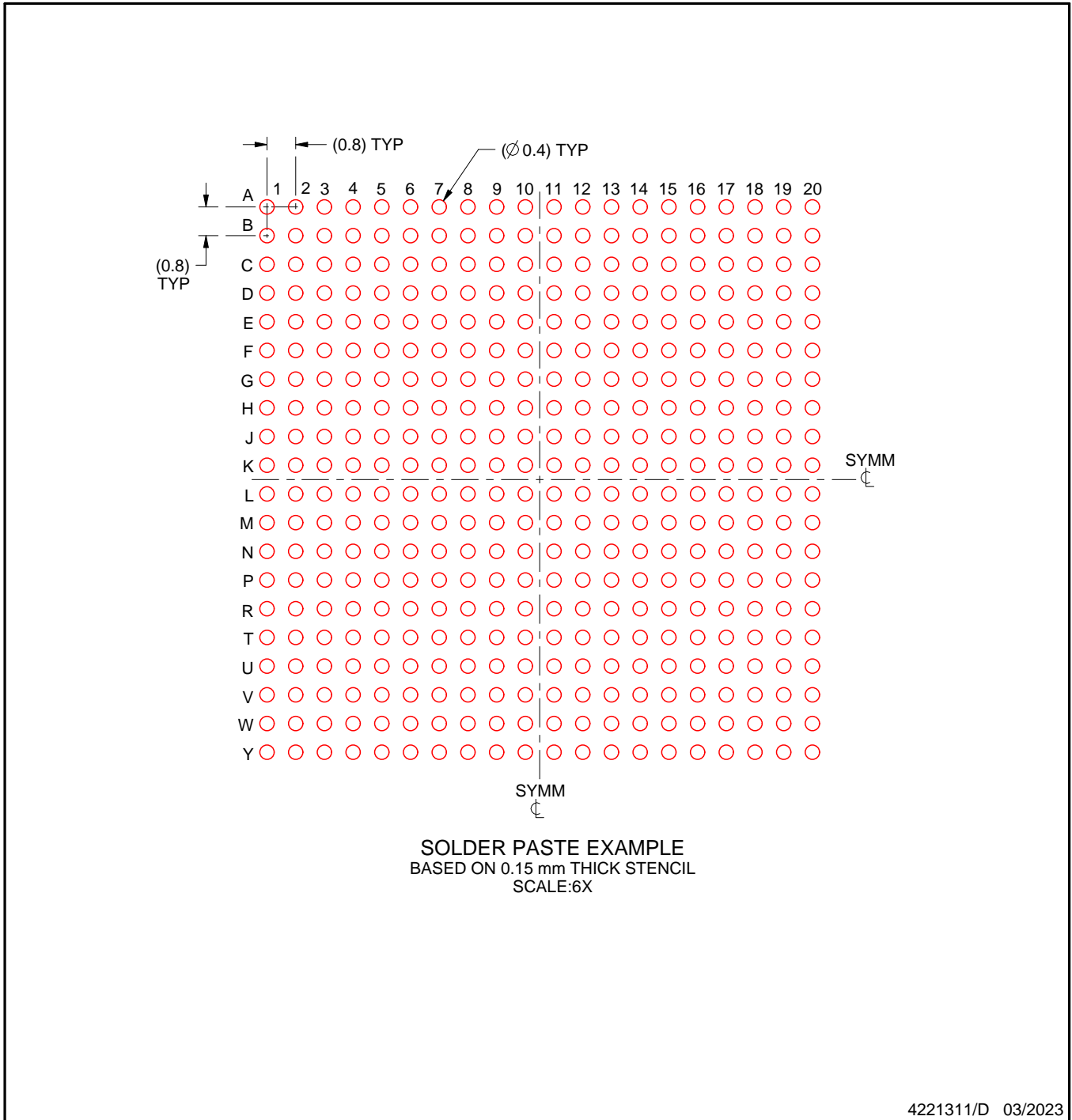

NOTES: (continued)

7. Laser cutting apertures with trapezoidal walls and rounded corners may offer better paste release.

IMPORTANT NOTICE AND DISCLAIMER

TI PROVIDES TECHNICAL AND RELIABILITY DATA (INCLUDING DATA SHEETS), DESIGN RESOURCES (INCLUDING REFERENCE DESIGNS), APPLICATION OR OTHER DESIGN ADVICE, WEB TOOLS, SAFETY INFORMATION, AND OTHER RESOURCES "AS IS" AND WITH ALL FAULTS, AND DISCLAIMS ALL WARRANTIES, EXPRESS AND IMPLIED, INCLUDING WITHOUT LIMITATION ANY IMPLIED WARRANTIES OF MERCHANTABILITY, FITNESS FOR A PARTICULAR PURPOSE OR NON-INFRINGEMENT OF THIRD PARTY INTELLECTUAL PROPERTY RIGHTS.

These resources are intended for skilled developers designing with TI products. You are solely responsible for (1) selecting the appropriate TI products for your application, (2) designing, validating and testing your application, and (3) ensuring your application meets applicable standards, and any other safety, security, regulatory or other requirements.

These resources are subject to change without notice. TI grants you permission to use these resources only for development of an application that uses the TI products described in the resource. Other reproduction and display of these resources is prohibited. No license is granted to any other TI intellectual property right or to any third party intellectual property right. TI disclaims responsibility for, and you will fully indemnify TI and its representatives against, any claims, damages, costs, losses, and liabilities arising out of your use of these resources.

TI's products are provided subject to [TI's Terms of Sale](#) or other applicable terms available either on [ti.com](https://www.ti.com) or provided in conjunction with such TI products. TI's provision of these resources does not expand or otherwise alter TI's applicable warranties or warranty disclaimers for TI products.

TI objects to and rejects any additional or different terms you may have proposed.

Mailing Address: Texas Instruments, Post Office Box 655303, Dallas, Texas 75265
Copyright © 2024, Texas Instruments Incorporated