

AFE7950 4T6R RF Sampling AFE with 12 GSPS DACs and 3 GSPS ADCs

1 Features

- [Request full data sheet](#)
- Quad RF sampling 12-GSPS transmit DACs
- Quad RF sampling 3-GSPS receive ADCs
- Dual RF sampling 3-GSPS feedback (auxiliary RX) ADCs
- Maximum RF signal bandwidth:
 - 4TX or 2FB: 1200 MHz or 2TX: 2400 MHz
 - RX): 1200 MHz (no FB), 600 MHz (with FB)
- RF frequency range:
 - TX: 600MHz - 12GHz
 - RX/FB: 600MHz -12GHz
- Digital step attenuators (DSA):
 - TX: 40 dB range, 0.125-dB steps
 - RX or FB: 25 dB range, 0.5-dB steps
- Single or dual-band DUC or DDCs for TX and RX
- 16x NCOs per TX or RX and FB
- Optional Internal PLL or VCO for DAC or ADC clocks or external clock at DAC or ADC sample rate
- SerDes data interface:
 - JESD204B and JESD204C compatible
 - 8 SerDes transceivers up to 29.5 Gbps
 - Subclass 1 multi-device synchronization
- Package: 17-mm × 17-mm FCBGA, 0.8-mm pitch

2 Applications

- [Radar](#)
- [Seeker front end](#)
- [Defense radio](#)
- Tactical communications infrastructure
- [Wireless communications test](#)

3 Description

The AFE7950 is a high performance, wide bandwidth multi-channel transceiver, integrating four RF sampling transmitter chains, four RF sampling receiver chains and two RF sampling feedback chains (six RF sampling ADCs total). With operation up to 12 GHz, this device enables direct RF sampling in the L, S, C and X-band frequency ranges without the need for additional frequency conversions stages. This improvement in density and flexibility enables high-channel-count, multi-mission systems.

The TX signal paths support interpolation and digital up conversion options that deliver up to 1200 MHz of signal bandwidth for four TX or 2400 MHz for two TX. The output of the DUCs drives a 12-GSPS DAC (digital to analog converter) with a mixed mode output option to enhance 2nd Nyquist operation. The DAC output includes a variable gain amplifier (TX DSA) with 40-dB range and 1-dB analog and 0.125-dB digital steps.

Package Information

PART NUMBER	PACKAGE ⁽¹⁾	PACKAGE SIZE ⁽²⁾
AFE7950	FC-BGA	17 mm × 17 mm

- (1) For more information, see *Mechanical, Packaging, and Orderable Information*.
- (2) The package size (length × width) is a nominal value and includes pins, where applicable.

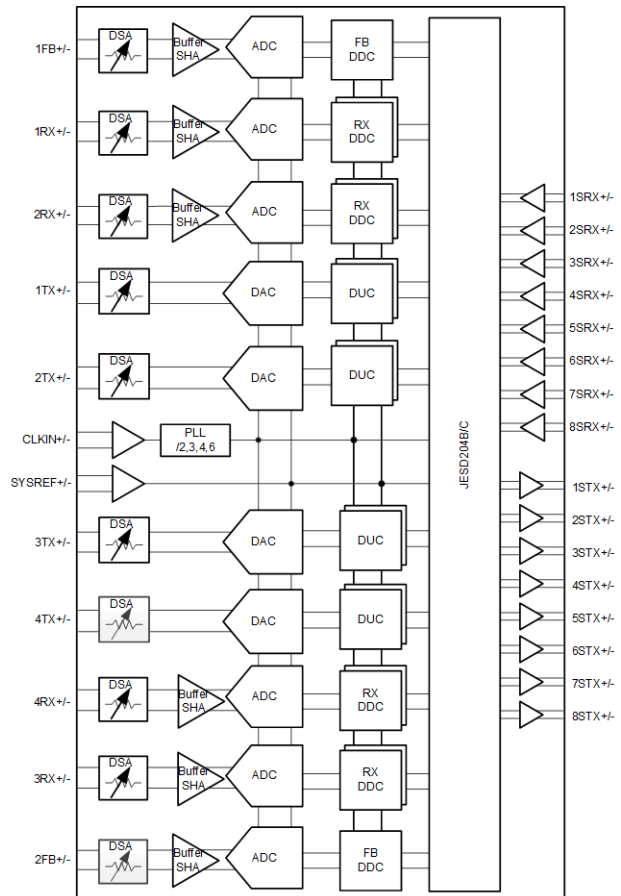

Functional Block Diagram



Table of Contents

1 Features	1	6.8 Digital Electrical Characteristics.....	19
2 Applications	1	6.9 Power Supply Electrical Characteristics.....	20
3 Description	1	6.10 Timing Requirements.....	26
4 Description (continued)	3	6.11 Switching Characteristics.....	27
5 Revision History	3	6.12 Typical Characteristics.....	28
6 Specifications	4	7 Device and Documentation Support	125
6.1 Absolute Maximum Ratings.....	4	7.1 Receiving Notification of Documentation Updates..	125
6.2 ESD Ratings.....	4	7.2 Support Resources.....	125
6.3 Recommended Operating Conditions.....	5	7.3 Trademarks.....	125
6.4 Thermal Information.....	5	7.4 Electrostatic Discharge Caution.....	125
6.5 Transmitter Electrical Characteristics.....	6	7.5 Glossary.....	125
6.6 RF ADC Electrical Characteristics.....	13	8 Mechanical, Packaging, and Orderable Information	125
6.7 PLL/VCO/Clock Electrical Characteristics.....	17		

4 Description (continued)

Each receiver chain includes a 25-dB range DSA (Digital Step Attenuator), followed by a 3-GSPS ADC (analog-to-digital converter). Each receiver channel has an analog peak power detector and various digital power detectors to assist an external or internal autonomous automatic gain controller, and RF overload detectors for device reliability protection. Flexible decimation options provide optimization of data bandwidth up to 1200 MHz for four RX without FB paths or 600 MHz with two FB paths (1200 MHz BW each).

5 Revision History

NOTE: Page numbers for previous revisions may differ from page numbers in the current version.

Changes from July 12, 2022 to June 12, 2023 (from Revision C (July 2022) to Revision D (June 2023))

	Page
• Changed the Packaging Information table to include note 2.....	1
• Changed I_{IH} and I_{IL} units to μA	19
• Removed dither from conditions.....	28
• Changed captions to read 1.8 GHz in 1.8 GHz section and removed dither from conditions.....	36
• Removed dither from conditions.....	42
• Changed 0TX to 1TX in plot notes and removed dither from conditions and dither plot.....	50
• Removed dither from conditions.....	55
• Changed 0TX - 3TX to 1TX - 4TX in plot legends.....	63
• Removed TX dither plot and TX dither in conditions.....	63
• Removed dither from conditions.....	73
• Changed 0RX - 3RX to 1RX - 4RX in plot captions and notes.....	100

Changes from March 9, 2022 to July 12, 2022 (from Revision B (March 2022) to Revision C (July 2022))

	Page
• Removed dither from conditions.....	28
• Changed captions to read 1.8 GHz in 1.8 GHz section and removed dither from conditions.....	36
• Removed dither from conditions.....	42
• Changed 0TX to 1TX in plot notes and removed dither from conditions and dither plot.....	50
• Removed dither from conditions.....	55
• Changed 0TX - 3TX to 1TX - 4TX in plot legends.....	63
• Removed TX dither plot and TX dither in conditions.....	63
• Removed dither from conditions.....	73
• Changed 0RX - 3RX to 1RX - 4RX in plot captions and notes.....	100

Changes from Revision A (August 2021) to Revision B (March 2022)

	Page
• Added <i>Feature</i> to Request the full data sheet.....	1
• Added the Specification tables to the data sheet.....	4

Changes from Revision * (February 2021) to Revision A (August 2021)

	Page
• Changed the data sheet status From: <i>Advanced Information</i> To: <i>Production</i> data.....	1

6 Specifications

6.1 Absolute Maximum Ratings

over operating free-air temperature range (unless otherwise noted)⁽¹⁾

		MIN	MAX	UNIT
Supply Voltage Range	DVDD0P9, VDDT0P9	-0.3	1.2	V
	VDD1P2RX, VDD1P2TXCLK, VDD1P2TXENC, VDD1P2PLL, VDD1P2PLLCLKREF, VDD1P2FB, VDD1P2FBCML, VDD1P2RXCML	-0.3	1.4	V
	VDD1P8RX, VDD1P8RXCLK, VDD1P8TX, VDD1P8TXDAC, VDD1P8TXENC, VDD1P8PLL, VDD1P8PLLVC0, VDD1P8FB, VDD1P8FBCLK, VDD1P8GPIO, VDDA1P8	-0.5	2.1	V
Pin Voltage Range	{1/2/3/4}RXIN+/-	-0.5	VDDR1P8+0.3	V
	1FBIN+/-, 2FB+/-	-0.5	VDDFB1P8+0.3	V
	{1/2/3/4}TXOUT+/-	-0.5	VDDTX1P8+0.3	V
	REFCLK+/-, SYSREF+/-	-0.3	1.4	V
	{1:8}SRX+/-	-0.3	1.4	V
	{1:8}STX+/-	-0.3	1.4	V
	GPIO{B/C/D/E}x, SPICLK, SPISDIO, SPISDO, SPISEN, RESETZ, BISTB0, BISTB1	-0.5	VDD1P8GPIO + 0.3	V
	IFORCE, VSENSE	-0.3	VDDCLK1P8 + 0.3	V
SRDAMUX1, SRDAMUX2	-0.3	VDDA1P8+0.3	V	
Peak Input Current	any input		20	mA
T _J	Junction temperature		150	°C
T _{stg}	Storage temperature	-65	150	°C

- (1) Stresses beyond those listed under *Absolute Maximum Rating* may cause permanent damage to the device. These are stress ratings only, which do not imply functional operation of the device at these or any other conditions beyond those indicated under *Recommended Operating Condition*. Exposure to absolute-maximum-rated conditions for extended periods may affect device reliability.

6.2 ESD Ratings

			VALUE	UNIT
V _(ESD)	Electrostatic discharge	Human body model (HBM), per ANSI/ESDA/ JEDEC JS-001, all pins ⁽¹⁾	1000	V
		Charged device model (CDM), per ANSI/ESDA/ JEDEC JS-002, all pins	150	

- (1) JEDEC document JEP155 states that 500-V HBM allows safe manufacturing with a standard ESD control process.

6.3 Recommended Operating Conditions

over operating free-air temperature range (unless otherwise noted)

		MIN	NOM	MAX	UNIT
DVDD0P9, VDDT0P9	Supply voltage 0.9V	0.9	0.925	0.95	V
VDD1P2{RX/TXCLK/TXENC/FB/PLL/ PLLCLKREF/FBCML/RXCML}	Supply voltage 1.2V	1.15	1.2	1.25	V
VDD1P8{RX/RXCLK/TX/TXDAC/ TXENC/PLL/PLLVCO/FB/FBCLK/ GPIO}, VDDA1P8	Supply voltage 1.8V	1.75	1.8	1.85	V
T _A	Ambient temperature	-40		85	°C
T _J	Operating Junction Temperature			110 ⁽¹⁾	°C
	Maximum Operating Junction Temperature	125			°C

- (1) Prolonged use at or above this junction temperature can increase the device failure-in-time (FIT) rate. Refer to [SBAA403 application note](#) for additional details

6.4 Thermal Information

THERMAL METRIC ⁽¹⁾		AFE7950	UNIT
		ABJ or ALK (FC-BGA)	
		400 PINS	
R _{θJA}	Junction-to-ambient thermal resistance	16.2	°C/W
R _{θJC(top)}	Junction-to-case (top) thermal resistance	0.42	°C/W
R _{θJB}	Junction-to-board thermal resistance	4.85	°C/W
Ψ _{JT}	Junction-to-top characterization parameter	0.12	°C/W
Ψ _{JB}	Junction-to-board characterization parameter	4.6	°C/W

- (1) For more information about traditional and new thermal metrics, see the [Semiconductor and IC Package Thermal Metrics](#) application report.

6.5 Transmitter Electrical Characteristics

Typical values at $T_A = +25^\circ\text{C}$, full temperature range is $T_{A,\text{MIN}} = -40^\circ\text{C}$ to $T_{J,\text{MAX}} = +110^\circ\text{C}$; TX Input Rate = 491.52MSPS below 6GHz and 1474.56MSPS above 6GHz, $f_{\text{DAC}} = 11796.48\text{MSPS}$; PLL clock mode below 6GHz output frequency and External clock mode above 6GHz output frequency; interleave mode for 1st Nyquist, non-interleave mix mode for 2nd Nyquist, nominal power supplies; 1 tone at -1 dBFS; DSA Attenuation = 0dB; SerDes rate = 16.22Gbps; TX clock dither enabled, unless otherwise noted.

PARAMETER		TEST CONDITIONS	MIN	TYP	MAX	UNIT
DAC _{RES}	DAC resolution			14		bits
f _{RFout}	RF output frequency range	f _{DAC} = 12 GSPS, 1 st Nyquist	600		6000	MHz
		f _{DAC} = 12 GSPS, 2 nd Nyquist	6000		12000	
		f _{DAC} = 9 GSPS, 1 st Nyquist	600		4500	
		f _{DAC} = 9 GSPS, 2 nd Nyquist	4500		9000	
		f _{DAC} = 6 GSPS, 1 st Nyquist	600		3000	
		f _{DAC} = 6 GSPS, 2 nd Nyquist	3000		6000	
P _{max_FS}	Max Full Scale Output Power, max gain 1 tone, at device pins	f _{out} = 850 MHz, f _{DAC} = 5898.24 MSPS, -0.5dBFS		4.2		dBm
		f _{out} = 1800 MHz, f _{DAC} = 5898.24 MSPS, -0.5dBFS		4.6		dBm
		f _{out} = 2600 MHz, f _{DAC} = 8847.36 MSPS, -0.5dBFS		4.0		dBm
		f _{out} = 3500 MHz, -0.5dBFS		3.9		dBm
		f _{out} = 4900 MHz, -0.5dBFS		3.1		dBm
		f _{out} = 3500 MHz, f _{DAC} = 5898.24 MSPS, -0.5dBFS, straight mode		1.0		dBm
		f _{out} = 4900 MHz, f _{DAC} = 5898.24 MSPS, -0.5dBFS, straight mode		0.1		dBm
		f _{out} = 4900 MHz, f _{DAC} = 8847.36 MSPS, -0.5dBFS, straight mode		-0.7		dBm
		f _{out} = 8100 MHz, -0.1dBFS, mixed mode		-2.8		dBm
f _{out} = 9600 MHz, -0.1dBFS, mixed mode		-4.3		dBm		
R _{TERM}	Output termination resistor	Default setting		50		Ω
ATT _{range}	DSA Attenuation range			40		dB
ATT _{step}	DSA Analog Attenuation step			1.0		dB
	DSA Attenuation step accuracy (DNL)	0 < Atten < 40dB, before calibration		±0.2		dB
	DSA Attenuation step accuracy (DNL)	0 < Atten < 40dB, after calibration		±0.1		dB
ATT _{phase-err}	DSA Gain Steps Phase accuracy, any 8dB range	f _{out} = 850MHz ⁽²⁾		±1		deg
		f _{out} = 1800MHz ⁽²⁾		±1		deg
		f _{out} = 2600MHz ⁽²⁾		±1		deg
		f _{out} = 3500MHz ⁽²⁾		±1		deg
		f _{out} = 4900MHz ⁽²⁾		±1		deg
		f _{out} = 8100MHz ⁽²⁾		±2		deg
G _{flat}	Gain flatness	any 20MHz		0.1		dB
		600MHz BW, F _{out} < 4.9G		1.2		

6.5 Transmitter Electrical Characteristics (continued)

Typical values at $T_A = +25^\circ\text{C}$, full temperature range is $T_{A,\text{MIN}} = -40^\circ\text{C}$ to $T_{J,\text{MAX}} = +110^\circ\text{C}$; TX Input Rate = 491.52MSPS below 6GHz and 1474.56MSPS above 6GHz, $f_{\text{DAC}} = 11796.48\text{MSPS}$; PLL clock mode below 6GHz output frequency and External clock mode above 6GHz output frequency; interleave mode for 1st Nyquist, non-interleave mix mode for 2nd Nyquist, nominal power supplies; 1 tone at -1 dBFS; DSA Attenuation = 0dB; SerDes rate = 16.22Gbps; TX clock dither enabled, unless otherwise noted.

PARAMETER		TEST CONDITIONS	MIN	TYP	MAX	UNIT
IMD3	3rd Order Intermodulation distortion, 2 tones at $f_{\text{IF}} \pm 10\text{ MHz}$	$f_{\text{out}} = 850\text{MHz}$, -7dBFS each tone		-66		dBc
		$f_{\text{out}} = 1800\text{MHz}$, -7dBFS each tone		-63		dBc
		$f_{\text{out}} = 2600\text{MHz}$, -7dBFS each tone		-62		dBc
		$f_{\text{out}} = 3500\text{MHz}$, -7dBFS each tone		-61		dBc
		$f_{\text{out}} = 4900\text{MHz}$, -7dBFS each tone		-57		dBc
		$f_{\text{out}} = 8100\text{MHz}$, -7dBFS each tone		-55		dBc
		$f_{\text{out}} = 9600\text{MHz}$, -7dBFS each tone		-52		dBc
		$f_{\text{out}} = 850\text{MHz}$, -13dBFS each tone		-74.4		dBc
		$f_{\text{out}} = 1800\text{MHz}$, -13dBFS each tone		-71.1		dBc
		$f_{\text{out}} = 2600\text{MHz}$, -13dBFS each tone		-73		dBc
		$f_{\text{out}} = 3500\text{MHz}$, -13dBFS each tone		-72		dBc
		$f_{\text{out}} = 4900\text{MHz}$, -13dBFS each tone		-67.8		dBc
		$f_{\text{out}} = 8100\text{MHz}$, -13dBFS each tone		-64		dBc
		$f_{\text{out}} = 9600\text{MHz}$, -13dBFS each tone		-68		dBc
SFDR	Spurious Free Dynamic Range (within Nyquist zone)	$f_{\text{out}} = 850\text{ MHz}$		50.8		dBc
		$f_{\text{out}} = 1800\text{ MHz}$		51.9		dBc
		$f_{\text{out}} = 2600\text{ MHz}$		42		dBc
		$f_{\text{out}} = 3500\text{ MHz}$		44		dBc
		$f_{\text{out}} = 4900\text{ MHz}$		46.1		dBc
$f_s/2 - f_{\text{OUT}}$	Interleaving Image	$f_{\text{DAC}} = 5898.24\text{MSPS}$, interleave mode		-51.9		dBc
		$f_{\text{DAC}} = 8847.36\text{ MSPS}$, interleave mode		-46.0		dBc
		$f_{\text{DAC}} = 11796.48\text{MSPS}$, interleave mode		-41		dBc
HD2	2nd Harmonic Distortion (within Nyquist zone)	$f_{\text{out}} = 850\text{ MHz}$		-49		dBc
		$f_{\text{out}} = 1800\text{ MHz}$		-53		dBc
		$f_{\text{out}} = 2600\text{ MHz}$		-50		dBc
		$f_{\text{out}} = 3500\text{ MHz}$		-48		dBc
		$f_{\text{out}} = 4900\text{ MHz}$		-47		dBc
		$f_{\text{out}} = 8100\text{ MHz}$		-50		dBc
		$f_{\text{out}} = 9600\text{ MHz}$		-53		dBc
		$f_{\text{out}} = 850\text{ MHz}$, $A_{\text{OUT}} = -12\text{dBFS}$		-60		dBc
		$f_{\text{out}} = 1800\text{ MHz}$, $A_{\text{OUT}} = -12\text{dBFS}$		-64		dBc
		$f_{\text{out}} = 2600\text{ MHz}$, $A_{\text{OUT}} = -12\text{dBFS}$		-45		dBc
		$f_{\text{out}} = 3500\text{ MHz}$, $A_{\text{OUT}} = -12\text{dBFS}$		-57		dBc
		$f_{\text{out}} = 4900\text{ MHz}$, $A_{\text{OUT}} = -12\text{dBFS}$		-58		dBc
		$f_{\text{out}} = 8100\text{ MHz}$, $A_{\text{OUT}} = -12\text{dBFS}$		-60		dBc
		$f_{\text{out}} = 9600\text{ MHz}$, $A_{\text{OUT}} = -12\text{dBFS}$		-62		dBc

6.5 Transmitter Electrical Characteristics (continued)

Typical values at $T_A = +25^\circ\text{C}$, full temperature range is $T_{A,\text{MIN}} = -40^\circ\text{C}$ to $T_{J,\text{MAX}} = +110^\circ\text{C}$; TX Input Rate = 491.52MSPS below 6GHz and 1474.56MSPS above 6GHz, $f_{\text{DAC}} = 11796.48\text{MSPS}$; PLL clock mode below 6GHz output frequency and External clock mode above 6GHz output frequency; interleave mode for 1st Nyquist, non-interleave mix mode for 2nd Nyquist, nominal power supplies; 1 tone at -1 dBFS; DSA Attenuation = 0dB; SerDes rate = 16.22Gbps; TX clock dither enabled, unless otherwise noted.

PARAMETER		TEST CONDITIONS	MIN	TYP	MAX	UNIT
HD3	3rd Harmonic Distortion (within Nyquist zone)	$f_{\text{out}} = 850\text{ MHz}$		-62		dBc
		$f_{\text{out}} = 1800\text{ MHz}$		-55		dBc
		$f_{\text{out}} = 2600\text{ MHz}$		-57		dBc
		$f_{\text{out}} = 3500\text{ MHz}$		-60		dBc
		$f_{\text{out}} = 4900\text{ MHz}$		-54		dBc
		$f_{\text{out}} = 8100\text{ MHz}$		-54		dBc
		$f_{\text{out}} = 9600\text{ MHz}$		-56		dBc
		$f_{\text{out}} = 850\text{ MHz}, A_{\text{OUT}} = -12\text{dBFS}$		-80		dBc
		$f_{\text{out}} = 1800\text{ MHz}, A_{\text{OUT}} = -12\text{dBFS}$		-79		dBc
		$f_{\text{out}} = 2600\text{ MHz}, A_{\text{OUT}} = -12\text{dBFS}$		-77		dBc
		$f_{\text{out}} = 3500\text{ MHz}, A_{\text{OUT}} = -12\text{dBFS}$		-77		dBc
		$f_{\text{out}} = 4900\text{ MHz}, A_{\text{OUT}} = -12\text{dBFS}$		-78		dBc
		$f_{\text{out}} = 8100\text{ MHz}, A_{\text{OUT}} = -12\text{dBFS}$		-82		dBc
		$f_{\text{out}} = 9600\text{ MHz}, A_{\text{OUT}} = -12\text{dBFS}$		-80		dBc
HDn, n >= 4	Harmonic Distortion n >= 4 (within Nyquist zone)	$f_{\text{out}} = 850\text{ MHz}$		-81		dBc
		$f_{\text{out}} = 1800\text{ MHz}$		-88		dBc
		$f_{\text{out}} = 2600\text{ MHz}$		-86		dBc
		$f_{\text{out}} = 3500\text{ MHz}$		-79		dBc
		$f_{\text{out}} = 4900\text{ MHz}$		-86		dBc
		$f_{\text{out}} = 8100\text{ MHz}$		-87		dBc
		$f_{\text{out}} = 9600\text{ MHz}$		-85		dBc
		$f_{\text{out}} = 850\text{ MHz}, A_{\text{OUT}} = -12\text{dBFS}$		-93		dBc
		$f_{\text{out}} = 1800\text{ MHz}, A_{\text{OUT}} = -12\text{dBFS}$		-98		dBc
		$f_{\text{out}} = 2600\text{ MHz}, A_{\text{OUT}} = -12\text{dBFS}$		-84		dBc
		$f_{\text{out}} = 3500\text{ MHz}, A_{\text{OUT}} = -12\text{dBFS}$		-87		dBc
		$f_{\text{out}} = 4900\text{ MHz}, A_{\text{OUT}} = -12\text{dBFS}$		-87		dBc
		$f_{\text{out}} = 8100\text{ MHz}, A_{\text{OUT}} = -12\text{dBFS}$		-87		dBc
		$f_{\text{out}} = 9600\text{ MHz}, A_{\text{OUT}} = -12\text{dBFS}$		-87		dBc
SFDR +/- 250 MHz	Spurious Free Dynamic Range within +/- 250 MHz	$f_{\text{out}} = 850\text{ MHz}$		68.5		dBc
		$f_{\text{out}} = 1800\text{ MHz}$		79.4		dBc
		$f_{\text{out}} = 2600\text{ MHz}$		77		dBc
		$f_{\text{out}} = 3500\text{ MHz}$		75		dBc
		$f_{\text{out}} = 4900\text{ MHz}$		76		dBc
		$f_{\text{out}} = 8100\text{ MHz}$		61		dBc
		$f_{\text{out}} = 9600\text{ MHz}$		64		dBc
$f_s/4$	Fixed Spur	$f_{\text{DAC}} = 5898.24\text{MSPS}$		-64		dBFS
		$f_{\text{DAC}} = 8847.36\text{MSPS}$		-75		dBFS
		$f_{\text{DAC}} = 11796.48\text{MSPS}$		-67		dBFS
$f_s/2$	Fixed Spur	$f_{\text{DAC}} = 5898.24\text{MSPS}$		-49		dBFS
		$f_{\text{DAC}} = 8847.36\text{MSPS}$		-48		dBFS
		$f_{\text{DAC}} = 11796.48\text{MSPS}$		-48		dBFS

6.5 Transmitter Electrical Characteristics (continued)

Typical values at $T_A = +25^\circ\text{C}$, full temperature range is $T_{A,\text{MIN}} = -40^\circ\text{C}$ to $T_{J,\text{MAX}} = +110^\circ\text{C}$; TX Input Rate = 491.52MSPS below 6GHz and 1474.56MSPS above 6GHz, $f_{\text{DAC}} = 11796.48\text{MSPS}$; PLL clock mode below 6GHz output frequency and External clock mode above 6GHz output frequency; interleave mode for 1st Nyquist, non-interleave mix mode for 2nd Nyquist, nominal power supplies; 1 tone at -1 dBFS; DSA Attenuation = 0dB; SerDes rate = 16.22Gbps; TX clock dither enabled, unless otherwise noted.

PARAMETER		TEST CONDITIONS	MIN	TYP	MAX	UNIT
3*f _S /4	Fixed Spur	2nd Nyquist, f _{DAC} = 5898.24MSPS		-76		dBFS
		2nd Nyquist, f _{DAC} = 8847.36MSPS		-89		dBFS
		2nd Nyquist, f _{DAC} = 11796.48MSPS		-63		dBFS
ACPR _{1xcarr}	ACPR - 1 carrier, LTE 20MHz E-TM1.1 carrier f _{out} = 0.85 GHz	Atten=0dB, Pout=-13dBFS		-68.5		dBc
		Atten=20dB, Pout=-13dBFS		-67.2		dBc
		Atten=28dB, Pout=-13dBFS		-64.5		dBc
		Atten=39dB, Pout=-13dBFS		-53.9		dBc
ACPR _{1xcarr}	ACPR - 1 carrier, LTE 20MHz E-TM1.1 carrier f _{out} = 1.8425 GHz	Atten=0dB, Pout=-13dBFS		-70.7		dBc
		Atten=20dB, Pout=-13dBFS		-68.3		dBc
		Atten=28dB, Pout=-13dBFS		-62.9		dBc
		Atten=39dB, Pout=-13dBFS		-52.0		dBc
ACPR _{1xcarr}	ACPR - 1 carrier, LTE 20MHz E-TM1.1 carrier f _{out} = 2.6 GHz	Atten=0dB, Pout=-13dBFS		-71		dBc
		Atten=20dB, Pout=-13dBFS		-68		dBc
		Atten=28dB, Pout=-13dBFS		-62		dBc
		Atten=39dB, Pout=-13dBFS		-51.3		dBc
ACPR _{1xcarr}	ACPR - 1 carrier, LTE 20MHz E-TM1.1 carrier f _{out} = 3.5 GHz	Atten=0dB, Pout=-13dBFS		-70		dBc
		Atten=20dB, Pout=-13dBFS		-67		dBc
		Atten=28dB, Pout=-13dBFS		-60		dBc
		Atten=39dB, Pout=-13dBFS		-49.8		dBc
ACPR _{1xcarr}	ACPR - 1 carrier, LTE 20MHz E-TM1.1 carrier f _{out} = 4.9 GHz	Atten=0dB, Pout=-13dBFS		-68.8		dBc
		Atten=20dB, Pout=-13dBFS		-65.9		dBc
		Atten=28dB, Pout=-13dBFS		-60.6		dBc
		Atten=39dB, Pout=-13dBFS		-49.5		dBc
ACPR _{1xcarr}	ACPR - 1 carrier, NR 100MHz E-TM1.1 carrier f _{out} = 2.6 GHz	Atten=0dB, Pout=-13dBFS		-65		dBc
		Atten=20dB, Pout=-13dBFS		-62		dBc
		Atten=20dB, Pout=-13dBFS		-55		dBc
		Atten=39dB, Pout=-13dBFS		-44.3		dBc
ACPR _{1xcarr}	ACPR - 1 carrier, NR 100MHz E-TM1.1 carrier f _{out} = 3.5 GHz	Atten=0dB, Pout=-13dBFS		-64		dBc
		Atten=20dB, Pout=-13dBFS		-59		dBc
		Atten=28dB, Pout=-13dBFS		-52		dBc
		Atten=39dB, Pout=-13dBFS		-41.1		dBc
ACPR _{1xcarr}	ACPR - 1 carrier, NR 100MHz E-TM1.1 carrier f _{out} = 4.9 GHz	Atten=0dB, Pout=-13dBFS		-64.1		dBc
		Atten=20dB, Pout=-13dBFS		-60.4		dBc
		Atten=28dB, Pout=-13dBFS		-53.5		dBc
		Atten=39dB, Pout=-13dBFS		-42.5		dBc
ACPR _{1xcarr}	ACPR - 1 carrier, NR 100MHz E-TM1.1 carrier f _{out} = 8.1 GHz	Atten=0dB, Pout=-13dBFS		-58		dBc
		Atten=20dB, Pout=-13dBFS		-53		dBc
		Atten=28dB, Pout=-13dBFS		-46		dBc
		Atten=39dB, Pout=-13dBFS		-36		dBc

6.5 Transmitter Electrical Characteristics (continued)

Typical values at $T_A = +25^\circ\text{C}$, full temperature range is $T_{A,\text{MIN}} = -40^\circ\text{C}$ to $T_{J,\text{MAX}} = +110^\circ\text{C}$; TX Input Rate = 491.52MSPS below 6GHz and 1474.56MSPS above 6GHz, $f_{\text{DAC}} = 11796.48\text{MSPS}$; PLL clock mode below 6GHz output frequency and External clock mode above 6GHz output frequency; interleave mode for 1st Nyquist, non-interleave mix mode for 2nd Nyquist, nominal power supplies; 1 tone at -1 dBFS; DSA Attenuation = 0dB; SerDes rate = 16.22Gbps; TX clock dither enabled, unless otherwise noted.

PARAMETER		TEST CONDITIONS	MIN	TYP	MAX	UNIT
ACPR _{1xcarr}	ACPR - 1 carrier, NR 100MHz E-TM1.1 carrier $f_{\text{out}} = 9.6\text{ GHz}$	Atten=0dB, Pout=-13dBFS		-57		dBc
		Atten=20dB, Pout=-13dBFS		-50		dBc
		Atten=28dB, Pout=-13dBFS		-42		dBc
		Atten=39dB, Pout=-13dBFS		-31		dBc
EVM	Error Vector Magnitude, 1x 20MHz E-TM3.1/3.1a, no ref. clock noise	$F_{\text{out}} = 0.85\text{ GHz}$, $P_{\text{OUT}} = -13\text{dBFS}$		0.2		%
		$F_{\text{out}} = 1.8425\text{ GHz}$, $P_{\text{OUT}} = -13\text{dBFS}$		0.3		%
		$F_{\text{out}} = 2.6\text{ GHz}$, $P_{\text{OUT}} = -13\text{dBFS}$		0.28		%
		$F_{\text{out}} = 3.5\text{ GHz}$, $P_{\text{OUT}} = -13\text{dBFS}$		0.38		%
		$F_{\text{out}} = 4.9\text{ GHz}$, $P_{\text{OUT}} = -13\text{dBFS}$		0.4		%
NSD _{dBFS}	Noise Spectral Density 20MHz offset $f_{\text{OUT}} = 0.85\text{ GHz}$	Atten=0dB, $f_{\text{DAC}} = 5898.24\text{MSPS}$, Pout=-13dBFS		-157.6		dBFS/Hz
		Atten=20dB, $f_{\text{DAC}} = 5898.24\text{MSPS}$, Pout=-13dBFS		-153.3		dBFS/Hz
		Atten=28dB, $f_{\text{DAC}} = 5898.24\text{MSPS}$, Pout=-13dBFS		-147.9		dBFS/Hz
		Atten=39dB, $f_{\text{DAC}} = 5898.24\text{MSPS}$, Pout=-13dBFS		-136.9		dBFS/Hz
NSD _{dBFS}	Noise Spectral Density 20MHz offset $f_{\text{OUT}} = 1.8\text{ GHz}$	Atten=0dB, $f_{\text{DAC}} = 5898.24\text{MSPS}$, Pout=-13dBFS		-158.4		dBFS/Hz
		Atten=20dB, $f_{\text{DAC}} = 5898.24\text{MSPS}$, Pout=-13dBFS		-152.2		dBFS/Hz
		Atten=28dB, $f_{\text{DAC}} = 5898.24\text{MSPS}$, Pout=-13dBFS		-145.6		dBFS/Hz
		Atten=39dB, $f_{\text{DAC}} = 5898.24\text{MSPS}$, Pout=-13dBFS		-134.6		dBFS/Hz
NSD _{dBFS}	Noise Spectral Density 20MHz offset $f_{\text{OUT}} = 2.6\text{ GHz}$	Atten=0dB, $f_{\text{DAC}} = 8847.36\text{MSPS}$, Pout=-13dBFS		-157		dBFS/Hz
		Atten=20dB, $f_{\text{DAC}} = 8847.36\text{MSPS}$, Pout=-13dBFS		-151		dBFS/Hz
		Atten=28dB, $f_{\text{DAC}} = 8847.36\text{MSPS}$, Pout=-13dBFS		-144		dBFS/Hz
		Atten=39dB, $f_{\text{DAC}} = 8847.36\text{MSPS}$, Pout=-13dBFS		-133.0		dBFS/Hz
NSD _{dBFS}	Noise Spectral Density 20MHz offset $F_{\text{out}} = 3.5\text{ GHz}$	Atten=0dB, Pout=-13dBFS		-158		dBFS/Hz
		Atten=20dB, Pout=-13dBFS		-150		dBFS/Hz
		Atten=28dB, Pout=-13dBFS		-143		dBFS/Hz
		Atten=39dB, Pout=-13dBFS		-131.8		dBFS/Hz

6.5 Transmitter Electrical Characteristics (continued)

Typical values at $T_A = +25^\circ\text{C}$, full temperature range is $T_{A,MIN} = -40^\circ\text{C}$ to $T_{J,MAX} = +110^\circ\text{C}$; TX Input Rate = 491.52MSPS below 6GHz and 1474.56MSPS above 6GHz, $f_{DAC} = 11796.48\text{MSPS}$; PLL clock mode below 6GHz output frequency and External clock mode above 6GHz output frequency; interleave mode for 1st Nyquist, non-interleave mix mode for 2nd Nyquist, nominal power supplies; 1 tone at -1 dBFS; DSA Attenuation = 0dB; SerDes rate = 16.22Gbps; TX clock dither enabled, unless otherwise noted.

PARAMETER		TEST CONDITIONS	MIN	TYP	MAX	UNIT
NSD _{dBFS}	Noise Spectral Density 20MHz offset $F_{out} = 4.9\text{ GHz}$	Atten=0dB, Pout=-13dBFS		-155.5		dBFS/ Hz
		Atten=20dB, Pout=-13dBFS		-147.8		dBFS/ Hz
		Atten=28dB, Pout=-13dBFS		-140.8		dBFS/ Hz
		Atten=39dB, Pout=-13dBFS		-129.6		dBFS/ Hz
NSD _{dBFS}	Noise Spectral Density 50MHz offset $F_{out} = 8.1\text{ GHz}$	Atten=0dB, Pout=-13dBFS		-153		dBFS/ Hz
		Atten=20dB, Pout=-13dBFS		-147		dBFS/ Hz
		Atten=28dB, Pout=-13dBFS		-140		dBFS/ Hz
		Atten=39dB, Pout=-13dBFS		-129		dBFS/ Hz
NSD _{dBFS}	Noise Spectral Density 50MHz offset $F_{out} = 9.6\text{ GHz}$	Atten=0dB, Pout=-13dBFS		-152		dBFS/ Hz
		Atten=20dB, Pout=-13dBFS		-147		dBFS/ Hz
		Atten=28dB, Pout=-13dBFS		-140		dBFS/ Hz
		Atten=39dB, Pout=-13dBFS		-129		dBFS/ Hz
S22	Output Return Loss, <6GHz, +/- fc * 10%	with matching		-17		dB
	Output Return Loss, >8GHz, +/- fc * 10%	with matching		-10		dB
Isolation	Near Channel: 1TXOUT to 2TXOUT or 3TXOUT to 4TXOUT ⁽¹⁾	$f_{out} = 900\text{ MHz}$, $f_{DAC} = 8847.36\text{MSPS}$, straight mode		-49		dB
		$f_{out} = 1850\text{ MHz}$, $f_{DAC} = 8847.36\text{MSPS}$, straight mode		-59		dB
		$f_{out} = 2600\text{ MHz}$, $f_{DAC} = 8847.36\text{MSPS}$, straight mode		-65		dB
		$f_{out} = 3500\text{ MHz}$, $f_{DAC} = 8847.36\text{MSPS}$, straight mode		-66		dB
		$f_{out} = 4900\text{ MHz}$, $f_{DAC} = 8847.36\text{MSPS}$, straight mode		-60		dB
		$f_{out} = 900\text{ MHz}$, $f_{DAC} = 8847.36\text{MSPS}$, straight mode		-90		dB
		$f_{out} = 1850\text{ MHz}$, $f_{DAC} = 8847.36\text{MSPS}$, straight mode		-91		dB
		$f_{out} = 2600\text{ MHz}$, $f_{DAC} = 8847.36\text{MSPS}$, straight mode		-93		dB
		$f_{out} = 3500\text{ MHz}$, $f_{DAC} = 8847.36\text{MSPS}$, straight mode		-94		dB
		$f_{out} = 4900\text{ MHz}$, $f_{DAC} = 8847.36\text{MSPS}$, straight mode		-83		dB

6.5 Transmitter Electrical Characteristics (continued)

Typical values at $T_A = +25^\circ\text{C}$, full temperature range is $T_{A,\text{MIN}} = -40^\circ\text{C}$ to $T_{J,\text{MAX}} = +110^\circ\text{C}$; TX Input Rate = 491.52MSPS below 6GHz and 1474.56MSPS above 6GHz, $f_{\text{DAC}} = 11796.48\text{MSPS}$; PLL clock mode below 6GHz output frequency and External clock mode above 6GHz output frequency; interleave mode for 1st Nyquist, non-interleave mix mode for 2nd Nyquist, nominal power supplies; 1 tone at -1 dBFS; DSA Attenuation = 0dB; SerDes rate = 16.22Gbps; TX clock dither enabled, unless otherwise noted.

PARAMETER		TEST CONDITIONS	MIN	TYP	MAX	UNIT
PN _{TXADD}	Additive Phase Noise External Clock Mode ⁽³⁾	$f_{\text{out}} = 9.6\text{GHz}$, $f_{\text{OFFSET}} = 100\text{Hz}$		-88		dBc/Hz
		$f_{\text{out}} = 9.6\text{GHz}$, $f_{\text{OFFSET}} = 1\text{kHz}$		-102		dBc/Hz
		$f_{\text{out}} = 9.6\text{GHz}$, $f_{\text{OFFSET}} = 10\text{kHz}$		-110		dBc/Hz
		$f_{\text{out}} = 9.6\text{GHz}$, $f_{\text{OFFSET}} = 100\text{kHz}$		-123		dBc/Hz
		$f_{\text{out}} = 9.6\text{GHz}$, $f_{\text{OFFSET}} = 1\text{MHz}$		-136		dBc/Hz
		$f_{\text{out}} = 9.6\text{GHz}$, $f_{\text{OFFSET}} = 10\text{MHz}$		-143		dBc/Hz
		$f_{\text{out}} = 9.6\text{GHz}$, $f_{\text{OFFSET}} = 100\text{MHz}$		-146		dBc/Hz

- (1) Measured with differential 50 ohm across TxP/M. The DC bias to 1.8V to each TxP/M at each pin remains and is not removed. Other external components on the TX paths are disconnected.
- (2) After DSA calibration procedure
- (3) Single side band, input clock phase noise subtracted.

6.6 RF ADC Electrical Characteristics

Typical values at $T_A = +25^\circ\text{C}$, full temperature range is $T_{A,MIN} = -40^\circ\text{C}$ to $T_{J,MAX} = +110^\circ\text{C}$; RX Output Rate = 491.52MSPS below 6GHz input frequency and 1474.56MSPS above 6GHz input frequency, $f_{ADC} = 2949.12\text{MSPS}$; PLL clock mode with $f_{REF} = 491.52\text{MHz}$ below 6GHz input frequency and External clock mode with $f_{CLK} = 11796.48\text{MHz}$ above 6GHz input frequency; nominal power supplies; DSA Setting = 4dB below 6GHz and 3dB above 6GHz; SerDes rate = 24.33Gbps; unless otherwise noted.

PARAMETER		TEST CONDITIONS	MIN	TYP	MAX	UNIT
ADC _{RES}	ADC resolution			14		bits
F _{RFIn}	RF input frequency range		600		12000	MHz
P _{FS,CW,min}	Min Full scale input power, at device pins (1)	f _{IN} = 830 MHz, DSA=0dB		-2.9		dBm
		f _{IN} = 1760 MHz, DSA=0dB		-2.8		dBm
		f _{IN} = 2610 MHz, DSA=0dB		-1.8		dBm
		f _{IN} = 3610 MHz, DSA=0dB		-0.4		dBm
		f _{IN} = 4910 MHz, DSA=0dB		0.1		dBm
		f _{IN} = 8150 MHz, DSA=0dB		2.1		dBm
		f _{IN} = 9610 MHz, DSA=0dB		4.3		dBm
P _{FS,CW,MAX}	MAX Full scale input power - reliability limited, at device pins	f _{IN} = 830 MHz, DSA = 20dB		16.7		dBm
		f _{IN} = 1760 MHz, DSA = 20dB		17.0		dBm
		f _{IN} = 2610 MHz, DSA = 20dB		18		dBm
		f _{IN} = 3610 MHz, DSA = 20dB		18.5		dBm
		f _{IN} = 4910 MHz, DSA = 20dB		19.3		dBm
		f _{IN} = 8150 MHz, DSA = 20dB		21.3		dBm
		f _{IN} = 9610 MHz, DSA = 20dB		23.5		dBm
S11	Input Return Loss	with matching network		-12.0		dB
ATT _{range}	DSA Attenuation range			25.0		dB
ATT _{step}	DSA Attenuation step			0.5		dB
	DSA Attenuation step accuracy	Delta=Gatt(X)-Gatt(X-1), F _{in} =3610MHz, after calibration		±0.1		dB
	DSA Gain Steps Phase accuracy any 8dB range	F _{in} =3610MHz, after calibration		±0.9		deg
	DSA Gain Steps Phase accuracy any 8dB range	F _{in} =4910MHz, after calibration		±1.8		deg
NSD	Noise Density (small signal)	f _{IN} = 830 MHz, DSA = 3dB(3)		-155.2		dBFS/Hz
		f _{IN} = 1760 MHz, DSA = 3dB(3)		-155.0		dBFS/Hz
		f _{IN} = 2610 MHz, DSA = 3dB(3)		-154.4		dBFS/Hz
		f _{IN} = 3610 MHz, DSA = 3dB(3)		-154.1		dBFS/Hz
		f _{IN} = 4910 MHz, DSA = 3dB(3)		-155.1		dBFS/Hz
		f _{IN} = 8150 MHz, DSA = 3dB(3)		-150		dBFS/Hz
		f _{IN} = 9610 MHz, DSA = 3dB(3)		-151		dBFS/Hz
		f _{IN} = 830 MHz, 3<=Atten<=22		-156.0		dBFS/Hz
		f _{IN} = 1760 MHz, 3<=Atten<=25		-155.8		dBFS/Hz
		f _{IN} = 2610 MHz, 3<=Atten<=25		-155.7		dBFS/Hz
		f _{IN} = 3610 MHz, 3<=Atten<=25		-155.4		dBFS/Hz
		f _{IN} = 4910 MHz, 3<=Atten<=25		-155.8		dBFS/Hz
		f _{IN} = 8150 MHz, 3<=Atten<=25		-152.5		dBFS/Hz
		f _{IN} = 9610 MHz, 3<=Atten<=25		-152.5		dBFS/Hz

6.6 RF ADC Electrical Characteristics (continued)

Typical values at $T_A = +25^\circ\text{C}$, full temperature range is $T_{A,\text{MIN}} = -40^\circ\text{C}$ to $T_{J,\text{MAX}} = +110^\circ\text{C}$; RX Output Rate = 491.52MSPS below 6GHz input frequency and 1474.56MSPS above 6GHz input frequency, $f_{\text{ADC}} = 2949.12\text{MSPS}$; PLL clock mode with $f_{\text{REF}} = 491.52\text{MHz}$ below 6GHz input frequency and External clock mode with $f_{\text{CLK}} = 11796.48\text{MHz}$ above 6GHz input frequency; nominal power supplies; DSA Setting = 4dB below 6GHz and 3dB above 6GHz; SerDes rate = 24.33Gbps; unless otherwise noted.

PARAMETER		TEST CONDITIONS	MIN	TYP	MAX	UNIT
NF _{min}	Noise Figure min DSA Atten=0 - 3dB	$f_{\text{IN}} = 830 \text{ MHz}$		19.1		dB
		$f_{\text{IN}} = 1760 \text{ MHz}$		19.0		dB
		$f_{\text{IN}} = 2610 \text{ MHz}$		20.9		dB
		$f_{\text{IN}} = 3610 \text{ MHz}$		22.8		dB
		$f_{\text{IN}} = 4910 \text{ MHz}$		22.4		dB
		$f_{\text{IN}} = 8150 \text{ MHz}$		27.3		dB
		$f_{\text{IN}} = 9610 \text{ MHz}$		30		dB
NF	Noise Figure DSA Atten=4dB	$f_{\text{IN}} = 830 \text{ MHz}^{(4)}$		20.0		dB
		$f_{\text{IN}} = 1760 \text{ MHz}^{(4)}$		20.6		dB
		$f_{\text{IN}} = 2610 \text{ MHz}^{(4)}$		21.9		dB
		$f_{\text{IN}} = 3610 \text{ MHz}^{(4)}$		23.5		dB
		$f_{\text{IN}} = 4910 \text{ MHz}^{(4)}$		22.3		dB
		$f_{\text{IN}} = 8150 \text{ MHz}^{(4)}$		27.9		dB
		$f_{\text{IN}} = 9610 \text{ MHz}^{(4)}$		30.7		dB
NF _{max}	Noise Figure DSA Atten=20dB	$f_{\text{IN}} = 830 \text{ MHz}$		34.7		dB
		$f_{\text{IN}} = 1760 \text{ MHz}$		35.2		dB
		$f_{\text{IN}} = 2610 \text{ MHz}$		36.0		dB
		$f_{\text{IN}} = 3610 \text{ MHz}$		37.3		dB
		$f_{\text{IN}} = 4910 \text{ MHz}$		37.6		dB
		$f_{\text{IN}} = 8150 \text{ MHz}$		42.8		dB
		$f_{\text{IN}} = 9610 \text{ MHz}$		45		dB
IMD3	3 rd order intermodulation 2 tones at $f_{\text{IN}} \pm 10\text{MHz}$ -7dBFS each tone	$f_{\text{IN}} = 840 \text{ MHz}, 3 \leq \text{Atten} \leq 12$		-82.4		dBc
		$f_{\text{IN}} = 1770 \text{ MHz}, 3 \leq \text{Atten} \leq 12$		-84.1		dBc
		$f_{\text{IN}} = 2610 \text{ MHz}, 3 \leq \text{Atten} \leq 12$		-74		dBc
		$f_{\text{IN}} = 3610 \text{ MHz}, 3 \leq \text{Atten} \leq 12$		-77		dBc
		$f_{\text{IN}} = 4920 \text{ MHz}, 3 \leq \text{Atten} \leq 12$		-75.9		dBc
		$f_{\text{IN}} = 8150 \text{ MHz}, 3 \leq \text{Atten} \leq 12$, 25MHz tone spacing		-55		dBc
		$f_{\text{IN}} = 9610 \text{ MHz}, 3 \leq \text{Atten} \leq 12$, 25MHz tone spacing		-60		dBc
SFDR	Spurious Free Dynamic Range within output bandwidth, $A_{\text{IN}} = -3$ dBFS	$f_{\text{IN}} = 830 \text{ MHz}$		88.2		dBFS
		$f_{\text{IN}} = 1760 \text{ MHz}$		80.6		dBFS
		$f_{\text{IN}} = 2610 \text{ MHz}$		88		dBFS
		$f_{\text{IN}} = 3610 \text{ MHz}$		84		dBFS
		$f_{\text{IN}} = 4910 \text{ MHz}$		78.9		dBFS
		$f_{\text{IN}} = 8150 \text{ MHz}$		78		dBFS
		$f_{\text{IN}} = 9610 \text{ MHz}$		71		dBFS

6.6 RF ADC Electrical Characteristics (continued)

Typical values at $T_A = +25^\circ\text{C}$, full temperature range is $T_{A,\text{MIN}} = -40^\circ\text{C}$ to $T_{J,\text{MAX}} = +110^\circ\text{C}$; RX Output Rate = 491.52MSPS below 6GHz input frequency and 1474.56MSPS above 6GHz input frequency, $f_{\text{ADC}} = 2949.12\text{MSPS}$; PLL clock mode with $f_{\text{REF}} = 491.52\text{MHz}$ below 6GHz input frequency and External clock mode with $f_{\text{CLK}} = 11796.48\text{MHz}$ above 6GHz input frequency; nominal power supplies; DSA Setting = 4dB below 6GHz and 3dB above 6GHz; SerDes rate = 24.33Gbps; unless otherwise noted.

PARAMETER		TEST CONDITIONS	MIN	TYP	MAX	UNIT
HD2	2nd Harmonic Distortion $A_{\text{IN}} = -3 \text{ dBFS}^{(2)}$	$f_{\text{IN}} = 830 \text{ MHz}$		-85.5		dBFS
		$f_{\text{IN}} = 1760 \text{ MHz}$		-90.5		dBFS
		$f_{\text{IN}} = 2610 \text{ MHz}$		-88		dBFS
		$f_{\text{IN}} = 3610 \text{ MHz}$		-87		dBFS
		$f_{\text{IN}} = 4910 \text{ MHz}$		-84.2		dBFS
		$f_{\text{IN}} = 8150 \text{ MHz}$		-70		dBFS
		$f_{\text{IN}} = 9610 \text{ MHz}$		-70		dBFS
HD3	3rd Harmonic Distortion $A_{\text{IN}} = -3 \text{ dBFS}$	$f_{\text{IN}} = 830 \text{ MHz}$		-80.2		dBFS
		$f_{\text{IN}} = 1760 \text{ MHz}$		-85.3		dBFS
		$f_{\text{IN}} = 2610 \text{ MHz}$		-86		dBFS
		$f_{\text{IN}} = 3610 \text{ MHz}$		-78		dBFS
		$f_{\text{IN}} = 4910 \text{ MHz}$		-75.4		dBFS
		$f_{\text{IN}} = 8150 \text{ MHz}$		-70		dBFS
		$f_{\text{IN}} = 9610 \text{ MHz}$		-70		dBFS
HDn, n>3	SFDR excl. HD2 and HD3 $A_{\text{IN}} = -3 \text{ dBFS}$	$f_{\text{IN}} = 830 \text{ MHz}$		-88.2		dBFS
		$f_{\text{IN}} = 1760 \text{ MHz}$		-80.6		dBFS
		$f_{\text{IN}} = 2610 \text{ MHz}$		-88		dBFS
		$f_{\text{IN}} = 3610 \text{ MHz}$		-84		dBFS
		$f_{\text{IN}} = 4910 \text{ MHz}$		-81.7		dBFS
		$f_{\text{IN}} = 8150 \text{ MHz}$		-78		dBFS
		$f_{\text{IN}} = 9610 \text{ MHz}$		-78		dBFS
SFDR	Spurious Free Dynamic Range $A_{\text{IN}} = -13 \text{ dBFS}$ $0 \leq \text{Atten} \leq 16$	$f_{\text{IN}} = 830 \text{ MHz}$		89.2		dBFS
		$f_{\text{IN}} = 1760 \text{ MHz}$		88.8		dBFS
		$f_{\text{IN}} = 2610 \text{ MHz}$		95		dBFS
		$f_{\text{IN}} = 3610 \text{ MHz}$		90		dBFS
		$f_{\text{IN}} = 4910 \text{ MHz}$		89.8		dBFS
		$f_{\text{IN}} = 8150 \text{ MHz}$		83		dBFS
		$f_{\text{IN}} = 9610 \text{ MHz}$		80		dBFS
HD2	2nd Harmonic Distortion $A_{\text{IN}} = -13 \text{ dBFS}$ $0 \leq \text{Atten} \leq 16$	$f_{\text{IN}} = 830 \text{ MHz, with board trim}$		-79.0		dBFS
		$f_{\text{IN}} = 1760 \text{ MHz, with board trim}$		-101.6		dBFS
		$f_{\text{IN}} = 2610 \text{ MHz, with board trim}$		-100		dBFS
		$f_{\text{IN}} = 3610 \text{ MHz, with board trim}$		-101		dBFS
		$f_{\text{IN}} = 4910 \text{ MHz, with board trim}$		-99.1		dBFS
		$f_{\text{IN}} = 8150 \text{ MHz, with board trim}$		-107		dBFS
		$f_{\text{IN}} = 9610 \text{ MHz, with board trim}$		-107		dBFS

6.6 RF ADC Electrical Characteristics (continued)

Typical values at $T_A = +25^\circ\text{C}$, full temperature range is $T_{A,\text{MIN}} = -40^\circ\text{C}$ to $T_{J,\text{MAX}} = +110^\circ\text{C}$; RX Output Rate = 491.52MSPS below 6GHz input frequency and 1474.56MSPS above 6GHz input frequency, $f_{\text{ADC}} = 2949.12\text{MSPS}$; PLL clock mode with $f_{\text{REF}} = 491.52\text{MHz}$ below 6GHz input frequency and External clock mode with $f_{\text{CLK}} = 11796.48\text{MHz}$ above 6GHz input frequency; nominal power supplies; DSA Setting = 4dB below 6GHz and 3dB above 6GHz; SerDes rate = 24.33Gbps; unless otherwise noted.

PARAMETER		TEST CONDITIONS	MIN	TYP	MAX	UNIT
HD3	3rd Harmonic Distortion $A_{\text{IN}} = -13\text{ dBFS}$ $0 \leq \text{Atten} \leq 16$	$f_{\text{IN}} = 830\text{ MHz}$		-95.4		dBFS
		$f_{\text{IN}} = 1760\text{ MHz}$		-95.2		dBFS
		$f_{\text{IN}} = 2610\text{ MHz}$		-98		dBFS
		$f_{\text{IN}} = 3610\text{ MHz}$		-97		dBFS
		$f_{\text{IN}} = 4910\text{ MHz}$		-94		dBFS
		$f_{\text{IN}} = 8150\text{ MHz}$		-100		dBFS
		$f_{\text{IN}} = 9610\text{ MHz}$		-102		dBFS
HDn, n>3	SFDR excl. HD2 and HD3 $A_{\text{IN}} = -13\text{ dBFS}$ $0 \leq \text{Atten} \leq 16$	$f_{\text{IN}} = 830\text{ MHz}$		-89.2		dBFS
		$f_{\text{IN}} = 1760\text{ MHz}$		-88.8		dBFS
		$f_{\text{IN}} = 2610\text{ MHz}$		-95		dBFS
		$f_{\text{IN}} = 3610\text{ MHz}$		-90		dBFS
		$f_{\text{IN}} = 4910\text{ MHz}$		-90		dBFS
		$f_{\text{IN}} = 8150\text{ MHz}$		-83		dBFS
		$f_{\text{IN}} = 9610\text{ MHz}$		-80		dBFS
RX-RX Isolation	Near Channel: 1RXIN to 2RXIN 3RXIN to 4RXIN	$f_{\text{IN}} = 830\text{ MHz}$		-76.6		dBc
		$f_{\text{IN}} = 1760\text{ MHz}$		-70.9		dBc
		$f_{\text{IN}} = 2610\text{ MHz}$		-73.5		dBc
		$f_{\text{IN}} = 3610\text{ MHz}$		-76.9		dBc
		$f_{\text{IN}} = 4910\text{ MHz}$		-65.3		dBc
		$f_{\text{IN}} = 8150\text{ MHz}$		-64		dBc
		$f_{\text{IN}} = 9610\text{ MHz}$		-60		dBc
TX-FB Isolation	Near Channel: 2TXOUT to 1FBIN 4TXOUT to 2FBIN	$f_{\text{IN}} = 830\text{ MHz}$		-84.3		dBc
		$f_{\text{IN}} = 1760\text{ MHz}$		-87.7		dBc
		$f_{\text{IN}} = 2610\text{ MHz}$		-85		dBc
		$f_{\text{IN}} = 3610\text{ MHz}$		-75		dBc
		$f_{\text{IN}} = 4910\text{ MHz}$		-81.5		dBc
		$f_{\text{IN}} = 8150\text{ MHz}$		-71		dBc
		$f_{\text{IN}} = 9610\text{ MHz}$		-69		dBc
TX-RX Isolation	Far Channel: 2TXOUT to 1RXIN 4TXOUT to 3RXIN	$f_{\text{IN}} = 830\text{ MHz}$		-85.9		dBc
		$f_{\text{IN}} = 1760\text{ MHz}$		-86.9		dBc
		$f_{\text{IN}} = 2610\text{ MHz}$		-91		dBc
		$f_{\text{IN}} = 3610\text{ MHz}$		-83		dBc
		$f_{\text{IN}} = 4910\text{ MHz}$		-81.9		dBc
		$f_{\text{IN}} = 8150\text{ MHz}$		-68		dBc
		$f_{\text{IN}} = 9610\text{ MHz}$		-68		dBc

- (1) The input fullscale at minimum attenuation can be reduce by adding a digital gain range to the DSA, extending the useful range of the DSA. The noise figure remains constant over the digital gain range.
- (2) NLE correction of HD2
- (3) From DSA = 3dB down to 0dB, NSD increases 1dB per DSA dB
- (4) NF increase 1dB per DSA 1dB above DSA = 3dB

6.7 PLL/VCO/Clock Electrical Characteristics

Typical values at TA = +25°C, full temperature range is T_{A,MIN} = -40°C to T_{J,MAX} = +110°C; Reference clock input frequency 491.52MHz (unless otherwise noted), f_{DAC} = f_{VCO}, f_{OUT} = f_{DAC}/4, normalized to f_{VCO}.

PARAMETER		TEST CONDITIONS	MIN	TYP	MAX	UNIT
f _{VCO1}	VCO1 min frequency				7.2	GHz
	VCO1 max frequency		7.68			GHz
f _{VCO2}	VCO2 min frequency				8.8	GHz
	VCO2 max frequency		9.1			GHz
f _{VCO3}	VCO3 min frequency				9.7	GHz
	VCO3 max frequency		10.24			GHz
f _{VCO4}	VCO4 min frequency				11.6	GHz
	VCO4 max frequency		12.08			GHz
DIV _{DAC}	DAC sample rate divider			1, 2 or 3		
DIV _{FBAD} C	ADC sample rate divider from DAC sample rate			1, 2, 3, 4, 6 or 8		
DIV _{RXAD} C	ADC sample rate divider			1, 2, 3, 4, 6 or 8		
PN _{VCO}	Closed Loop Phase Noise F _{PLL} = 11.79848 GHz F _{REF} =491.52MHz	600kHz		-113		dBc/Hz
		800kHz		-116		dBc/Hz
		1MHz		-119		dBc/Hz
		1.8MHz		-125		dBc/Hz
		5MHz		-133		dBc/Hz
		50MHz		-141		dBc/Hz
	Closed Loop Phase Noise F _{PLL} =8.84736 GHz F _{REF} =491.52MHz	600kHz		-114		dBc/Hz
		800kHz		-118		dBc/Hz
		1MHz		-120		dBc/Hz
		1.8MHz		-127		dBc/Hz
		5MHz		-135		dBc/Hz
		50MHz		-142		dBc/Hz
	Closed Loop Phase Noise F _{PLL} = 9.8403 GHz F _{REF} =491.52MHz	600kHz		-113		dBc/Hz
		800kHz		-116		dBc/Hz
		1MHz		-119		dBc/Hz
		1.8MHz		-125		dBc/Hz
		5MHz		-134		dBc/Hz
		50MHz		-140		dBc/Hz
	Closed Loop Phase Noise F _{PLL} = 7.86432GHz F _{REF} =491.52MHz	600kHz		-116		dBc/Hz
		800kHz		-119		dBc/Hz
		1MHz		-122		dBc/Hz
		1.8MHz		-127		dBc/Hz
		5MHz		-136		dBc/Hz
		50MHz		-143		dBc/Hz
F _{rms}	Clock PLL integrated phase error ⁽¹⁾	f _{PLL} =11.79848 GHz, [1KHz, 100MHz]		-43.4		dBc/Hz
		f _{PLL} =8.8536 GHz, [1KHz, 100MHz]		-47.6		dBc/Hz
		f _{PLL} =9.8304 GHz, [1KHz, 100MHz]		-46.2		dBc/Hz
f _{PFD}	PFD frequency		100		500	MHz
PN _{pll_flat}	Normalized PLL flat Noise	f _{VCO} = 11796.48MHz		-226.5		dBc/Hz
F _{REF}	Input Clock frequency		0.1		12	GHz
V _{SS}	Input Clock level		0.6		1.8	Vppdiff

6.7 PLL/VCO/Clock Electrical Characteristics (continued)

Typical values at $T_A = +25^\circ\text{C}$, full temperature range is $T_{A,\text{MIN}} = -40^\circ\text{C}$ to $T_{J,\text{MAX}} = +110^\circ\text{C}$; Reference clock input frequency 491.52MHz (unless otherwise noted), $f_{\text{DAC}} = f_{\text{VCO}}$, $f_{\text{OUT}} = f_{\text{DAC}}/4$, normalized to f_{VCO} .

PARAMETER		TEST CONDITIONS	MIN	TYP	MAX	UNIT
Coupling				AC Coupling Only		
	REFCLK input impedance ⁽²⁾	Parallel resistance		100		Ω
		Parallel capacitance		0.5		pF

- (1) Single Sideband, not including the reference clock contribution
(2) Refer to S11 data available from TI for impedance vs frequency

6.8 Digital Electrical Characteristics

Typical values at TA = +25°C, full temperature range is T_{A,MIN} = -40°C to T_{J,MAX} = +110°C (unless otherwise noted)

PARAMETER		TEST CONDITIONS	MIN	TYP	MAX	UNIT
CML SerDes Inputs [8:1]SRX+/-						
V _{SRDIFF}	SerDes Receiver Input Amplitude	differential	100		1200	mVpp
V _{SRCOM}	SerDes Input Common Mode		0.4	0.5	0.6	V
Z _{SRdiff}	SerDes Internal Differential Termination ⁽¹⁾			100		Ω
F _{SerDes}	SerDes Bit Rate	Full rate mode	19		29.5	Gbps
		Half rate mode	9.5		16.25	Gbps
		Quarter rate mode	4.75		8.125	Gbps
	Insertion Loss Tolerance ⁽²⁾	Serdes supply = 1.8V		25		dB
TJ	Total Jitter Tolerance				0.42	UI
CML SerDes Outputs [8:1]STX+/-						
V _{STDIFF}	SerDes Transmitter Output Amplitude	differential	500		1000	mVpp
V _{STCOM}	SerDes Output Common Mode		0.4	0.45	0.55	V
Z _{STdiff}	SerDes Output Impedance			100		Ω
TRF	Output rise and fall time	20-80%	8			ps
TEQS	Equalization range				7	dB
TTJ	Output total jitter				0.21	UI
CMOS I/O: GPIO{B/C/D/E}x, SPICLK, SPISDIO, SPISDO, SPISEN, RESETZ, BISTB0, BISTB1						
V _{IH}	High-Level Input Voltage		0.6×VDD1 P8GPIO			V
V _{IL}	Low-Level Input Voltage				0.4×VDD1 P8GPIO	V
I _{IH}	High-Level Input Current		-250		250	μA
I _{IL}	Low-Level Input Current		-250		250	μA
C _L	CMOS input capacitance			2		pF
V _{OH}	High-Level Output Voltage		VDD1P8G PIO-0.2			V
V _{OL}	Low-Level Output Voltage				0.2	V
Differential Inputs: SYSREF+/- Mode A						
Clock _{MODE}				PLL Clock Mode Only		
F _{SYSREFMAX}	SYSREF Input Frequency Maximum			40		MHz
V _{SWINGSRMAX}	SYSREF Input Swing Maximum			1.8		Vppdiff ⁽³⁾
V _{SWINGSRMIN}	SYSREF Input Swing Minimum	f _{REF} < 500MHz		0.3		Vppdiff ⁽³⁾
V _{SWINGSRMIN}	SYSREF Input Swing Minimum	f _{REF} > 500MHz		0.6		Vppdiff ⁽³⁾
V _{COMSRMAX}	SYSREF Input Common Mode Voltage Maximum			0.8		V
V _{COMSRMIN}	SYSREF Input Common Mode Voltage Minimum			0.6		V
Z _T	Input termination	differential		100 ⁽¹⁾		Ω
C _L	Input capacitance	Each pin to GND		0.5		pF
LVDS Inputs: 0SYNCIN+/- and 1SYNCIN+/-						
V _{ICOM}	Input Common Voltage			1.2		V
V _{ID}	Differential Input Voltage swing			450		Vppdiff ⁽³⁾
Z _T	Input termination	differential		100		Ω

6.8 Digital Electrical Characteristics (continued)

Typical values at $T_A = +25^\circ\text{C}$, full temperature range is $T_{A,\text{MIN}} = -40^\circ\text{C}$ to $T_{J,\text{MAX}} = +110^\circ\text{C}$ (unless otherwise noted)

PARAMETER		TEST CONDITIONS	MIN	TYP	MAX	UNIT
LVDS Outputs: 0SYNCOUT+/- and 1SYNCOUT+/-						
V_{OCOM}	Output Common Voltage			1.2		V
V_{OD}	Differential Output Voltage swing			500		$V_{\text{ppdiff}}^{(3)}$
Z_T	Internal Termination			100		Ω

- (1) SYSREF termination is programmable between 100 Ω , 150 Ω and 300 Ω
- (2) Loss tolerance is bump to bump from STX to SRX
- (3) V_{ppdiff} is the difference between the maximum differential voltage (positive value) and minimum differential voltage (negative value).

6.9 Power Supply Electrical Characteristics

Typical values at $T_A = +25^\circ\text{C}$, full temperature range is $T_{A,\text{MIN}} = -40^\circ\text{C}$ to $T_{J,\text{MAX}} = +110^\circ\text{C}$; TX Input Rate = 491.52MSPS, $f_{\text{DAC}} = 8847.36\text{MSPS}$ interleave mode; $f_{\text{ADC}} = 2949.12\text{MSPS}$; nominal power supplies; 1 tone at -1 dBFS; DSA Attenuation = 0dB; SerDes rate = 24.33Gbps; unless otherwise noted.

PARAMETER		TEST CONDITIONS	MIN	TYP	MAX	UNIT
I_{VDD1P8}	Group 3A: VDD1P8FB + VDD1P8RX + VDD1P8TX	Mode 1: 4T2F - FDD FB 100% on, no RX TX/FB Rate: 491.52 Msps Single Band: 12x Int, FB 6x Dec $f_{\text{DAC}} = 5898.24$ SPS $f_{\text{ADC}} = 2949.12\text{MSPS}$ $f_{\text{TX}} = 1.85$ GHz 64/66 coding, 16.22Gbps TX: 4-8-4-1, FB: 2-4-4-1		948.2		mA
	Group 3B: VDD1P8FBCLK + VDD1P8RXCLK + VDD1P8TXDAC+ VDD1P8GPIO + VDDA1P8			533.7		mA
	Group 3C: VDD1P8PLL + VDD1P8PLLVC0			77.3		mA
I_{VDD1P2}	Group 2A: VDD1P2FB + VDD1P2RX			299.4		mA
	Group 2B: VDD1P2TXCLK + VDD1P2TXENC			804.5		mA
	Group 2C: VDD1P2FBCML + VDD1P2RXCML + VDD1P2PLLCLKREF			49.1		mA
I_{VDD0P9}	Group 1A: DVDD0P9 + VDDT0P9			2041.3		mA
P_{diss}	Power Dissipation			6027.1		mW
I_{VDD1P8}	Group 3A: VDD1P8FB + VDD1P8RX + VDD1P8TX		Mode 2: 4T4R - TDD 1F shared with RX TX 75%, RX 25%, FB 75% Dual Band: 12x Int, FB 6x Dec, RX 24x Dec TX/FB Rate 491.52 Msps RX Rate 122.88 Msps $f_{\text{DAC}} = 8847.36\text{MSPS}$ $f_{\text{ADC}} = 2949.12\text{MSPS}$ $f_{\text{OUT}}=f_{\text{IN}}= 1.9, 2.6$ GHz 64/66 coding, 16.22Gbps TX: 8-16-4-1, FB: 2-4-4-1, RX: 2-16-16-1		820.4	
	Group 3B: VDD1P8FBCLK + VDD1P8RXCLK + VDD1P8TXDAC+ VDD1P8GPIO + VDDA1P8			735.2		mA
	Group 3C: VDD1P8PLL + VDD1P8PLLVC0			74.4		mA
I_{VDD1P2}	Group 2A: VDD1P2FB + VDD1P2RX			289.0		mA
	Group 2B: VDD1P2TXCLK + VDD1P2TXENC			822.0		mA
	Group 2C: VDD1P2FBCML + VDD1P2RXCML + VDD1P2PLLCLKREF			45.6		mA
I_{VDD0P9}	Group 1A: DVDD0P9 + VDDT0P9			2263.8		mA
P_{diss}	Power Dissipation			6359.2		mW

6.9 Power Supply Electrical Characteristics (continued)

Typical values at $T_A = +25^\circ\text{C}$, full temperature range is $T_{A,MIN} = -40^\circ\text{C}$ to $T_{J,MAX} = +110^\circ\text{C}$; TX Input Rate = 491.52MSPS, $f_{DAC} = 8847.36\text{MSPS}$ interleave mode; $f_{ADC} = 2949.12\text{MSPS}$; nominal power supplies; 1 tone at -1 dBFS; DSA Attenuation = 0dB; SerDes rate = 24.33Gbps; unless otherwise noted.

PARAMETER		TEST CONDITIONS	MIN	TYP	MAX	UNIT
I_{VDD1P8}	Group 3A: VDD1P8FB + VDD1P8RX + VDD1P8TX	Mode 3: 4T4R2F - FDD FB 100% on TX Dual Band: 12x Int, FB 6x Dec RX Dual Band: RX 24x TX/FB Rate 491.52 Msps RX Rate 122.88 Msps $f_{DAC} = 11796.48\text{ MSPS}$ $f_{ADC} = 2949.12\text{ MSPS}$ $f_{TX} = 1.85 + 2.15\text{ GHz}$ $f_{RX} = 1.75 + 1.88\text{ GHz}$ 64/66 coding, 16.22Gbps TX: 8-16-4-1, FB: 2-4-4-1, RX: 2-16-16-1	1668.6			mA
	Group 3B: VDD1P8FBCLK + VDD1P8RXCLK + VDD1P8TXDAC+ VDD1P8GPIO + VDDA1P8		965.1			mA
	Group 3C: VDD1P8PLL + VDD1P8PLLCO		77.6			mA
I_{VDD1P2}	Group 2A: VDD1P2FB + VDD1P2RX		893.4			mA
	Group 2B: VDD1P2TXCLK + VDD1P2TXENC		879.5			mA
	Group 2C: VDD1P2FBCML + VDD1P2RXCML + VDD1P2PLLCLKREF		50.7			mA
I_{VDD0P9}	Group 1A: DVDD0P9 + VDDT0P9		3826.9			mA
P_{diss}	Power Dissipation		10513.0			mW
I_{VDD1P8}	Group 3A: VDD1P8FB + VDD1P8RX + VDD1P8TX		Mode 4: 4T4R2F - FDD FB 100% on 7.5 GSPS DAC, 2.5 GSPS ADC Single Band: 15x Int, FB 5x Dec Dual Band: RX 20x TX/FB Rate 491.52 Msps RX Rate 122.88 Msps $f_{DAC} = 7372.8\text{ MSPS}$ $f_{ADC} = 2457.6\text{ MSPS}$ $f_{TX} = 1.85 + 2.15\text{ GHz}$ $f_{RX} = 1.75 + 1.88\text{ GHz}$ 64/66 coding, 16.22Gbps TX: 4-8-4-1, FB: 2-4-4-1, RX: 2-16-16-1	1611.5		
	Group 3B: VDD1P8FBCLK + VDD1P8RXCLK + VDD1P8TXDAC+ VDD1P8GPIO + VDDA1P8	694.5				mA
	Group 3C: VDD1P8PLL + VDD1P8PLLCO	72.8				mA
I_{VDD1P2}	Group 2A: VDD1P2FB + VDD1P2RX	768.5				mA
	Group 2B: VDD1P2TXCLK + VDD1P2TXENC	940.5				mA
	Group 2C: VDD1P2FBCML + VDD1P2RXCML + VDD1P2PLLCLKREF	45.5				mA
I_{VDD0P9}	Group 1A: DVDD0P9 + VDDT0P9	3000.5				mA
P_{diss}	Power Dissipation	9087.4				mW
I_{VDD1P8}	Group 3A: VDD1P8FB + VDD1P8RX + VDD1P8TX	Mode 5: 4T4R - TDD 1F shared with RX TX 75%, RX 25%, FB 75% Single Band: 12x Int, FB 3x Dec, RX 6x Dec TX/FB Rate = 983.04 Msps RX Rate 491.52 Msps $f_{DAC} = 11796.48\text{ MSPS}$ $f_{ADC} = 2949.12\text{ MSPS}$ $f_{TX} = 3.5\text{ GHz}$ $f_{RX} = 3.5\text{ GHz}$ 64/66 coding, 16.22Gbps TX: 8-8-2-1, FB: 4-4-4-2, RX: 4-8-4-1		821.8		
	Group 3B: VDD1P8FBCLK + VDD1P8RXCLK + VDD1P8TXDAC+ VDD1P8GPIO + VDDA1P8		808.5			mA
	Group 3C: VDD1P8PLL + VDD1P8PLLCO		77.4			mA
I_{VDD1P2}	Group 2A: VDD1P2FB + VDD1P2RX		289.5			mA
	Group 2B: VDD1P2TXCLK + VDD1P2TXENC		682.0			mA
	Group 2C: VDD1P2FBCML + VDD1P2RXCML + VDD1P2PLLCLKREF		49.0			mA
I_{VDD0P9}	Group 1A: DVDD0P9 + VDDT0P9		2123.3			mA
P_{diss}	Power Dissipation		6209.3			mW

6.9 Power Supply Electrical Characteristics (continued)

Typical values at $T_A = +25^\circ\text{C}$, full temperature range is $T_{A,\text{MIN}} = -40^\circ\text{C}$ to $T_{J,\text{MAX}} = +110^\circ\text{C}$; TX Input Rate = 491.52MSPS, $f_{\text{DAC}} = 8847.36\text{MSPS}$ interleave mode; $f_{\text{ADC}} = 2949.12\text{MSPS}$; nominal power supplies; 1 tone at -1 dBFS; DSA Attenuation = 0dB; SerDes rate = 24.33Gbps; unless otherwise noted.

PARAMETER		TEST CONDITIONS	MIN	TYP	MAX	UNIT
I_{VDD1P8}	Group 3A: VDD1P8FB + VDD1P8RX + VDD1P8TX	Mode 7a: TDD 4T1FB (RX in Standby) TX 9G and FB 3G -16bit: 368.64M; DSA = 6dB, non-interleave mode RX 3G : 368.64M. 16 bit, Standby Serdes: 25gbps) -> 2 lanes for Rx/FB (lane shared) and 2lanes for Tx		658.1		mA
	Group 3B: VDD1P8FBCLK + VDD1P8RXCLK + VDD1P8TXDAC+ VDD1P8GPIO + VDDA1P8			431.1		mA
	Group 3C: VDD1P8PLL + VDD1P8PLLVC0			75.3		mA
I_{VDD1P2}	Group 2A: VDD1P2FB + VDD1P2RX			189.2		mA
	Group 2B: VDD1P2TXCLK + VDD1P2TXENC			1041.1		mA
	Group 2C: VDD1P2FBCML + VDD1P2RXCML + VDD1P2PLLCLKREF			39.0		mA
I_{VDD0P9}	Group 1A: DVDD0P9 + VDDT0P9			2208.7		mA
P_{diss}	Power Dissipation			5607.0		mW
I_{VDD1P8}	Group 3A: VDD1P8FB + VDD1P8RX + VDD1P8TX		Mode 7b: TDD 4R (TX in Standby) TX 9G and FB 3G -16bit: 368.64M; DSA = 6dB, , non-interleave mode, Standby RX 3G : 368.64M. 16 bit Serdes: 25gbps) -> 2 lanes for Rx/FB (lane shared) and 2lanes for Tx		789.5	
	Group 3B: VDD1P8FBCLK + VDD1P8RXCLK + VDD1P8TXDAC+ VDD1P8GPIO + VDDA1P8			471.3		mA
	Group 3C: VDD1P8PLL + VDD1P8PLLVC0			73.4		mA
I_{VDD1P2}	Group 2A: VDD1P2FB + VDD1P2RX			599.3		mA
	Group 2B: VDD1P2TXCLK + VDD1P2TXENC			169.6		mA
	Group 2C: VDD1P2FBCML + VDD1P2RXCML + VDD1P2PLLCLKREF			39.1		mA
I_{VDD0P9}	Group 1A: DVDD0P9 + VDDT0P9			1645.3		mA
P_{diss}	Power Dissipation			4851.9		mW
I_{VDD1P8}	Group 3A: VDD1P8FB + VDD1P8RX + VDD1P8TX	Mode 7c: TDD 4T4R1FB TX 9G and FB 3G -16bit: 368.64M; DSA = 6dB, , non-interleave mode, 75% on RX 3G : 368.64M. 16 bit 25% on Serdes: 25gbps) -> 2 lanes for Rx/FB (lane shared) and 2lanes for Tx			691.0	
I_{VDD1P8}	Group 3B: VDD1P8FBCLK + VDD1P8RXCLK + VDD1P8TXDAC+ VDD1P8GPIO + VDDA1P8			441.2		mA
I_{VDD1P8}	Group 3C: VDD1P8PLL + VDD1P8PLLVC0			74.8		mA
I_{VDD1P2}	Group 2A: VDD1P2FB + VDD1P2RX			291.7		mA
I_{VDD1P2}	Group 2B: VDD1P2TXCLK + VDD1P2TXENC			823.2		mA
I_{VDD1P2}	Group 2C: VDD1P2FBCML + VDD1P2RXCML + VDD1P2PLLCLKREF			39.0		mA
I_{VDD0P9}	Group 1A: DVDD0P9 + VDDT0P9			2067.9		mA
P_{diss}	Power Dissipation			5418.2		mW

6.9 Power Supply Electrical Characteristics (continued)

Typical values at $T_A = +25^\circ\text{C}$, full temperature range is $T_{A,MIN} = -40^\circ\text{C}$ to $T_{J,MAX} = +110^\circ\text{C}$; TX Input Rate = 491.52MSPS, $f_{DAC} = 8847.36\text{MSPS}$ interleave mode; $f_{ADC} = 2949.12\text{MSPS}$; nominal power supplies; 1 tone at -1 dBFS; DSA Attenuation = 0dB; SerDes rate = 24.33Gbps; unless otherwise noted.

PARAMETER		TEST CONDITIONS	MIN	TYP	MAX	UNIT	
I_{VDD1P8}	Group 3A: VDD1P8FB + VDD1P8RX + VDD1P8TX	Mode 7d: FDD 4T4R1FB TX 9G and FB 3G -16bit: 368.64M; DSA = 6dB, , non-interleave mode, RX 3G : 368.64M. 16 bit Serdes: 25gbps) -> 2 lanes for Rx/FB (lane shared) and 2lanes for Tx		1283.8		mA	
I_{VDD1P8}	Group 3B: VDD1P8FBCLK + VDD1P8RXCLK + VDD1P8TXDAC+ VDD1P8GPIO + VDDA1P8			752.0		mA	
I_{VDD1P8}	Group 3C: VDD1P8PLL + VDD1P8PLLCO			74.6		mA	
I_{VDD1P2}	Group 2A: VDD1P2FB + VDD1P2RX			750.5		mA	
I_{VDD1P2}	Group 2B: VDD1P2TXCLK + VDD1P2TXENC			1077.6		mA	
I_{VDD1P2}	Group 2C: VDD1P2FBCML + VDD1P2RXCML + VDD1P2PLLCLKREF			47.7		mA	
I_{VDD0P9}	Group 1A: DVDD0P9 + VDDT0P9			2695.5		mA	
P_{diss}	Power Dissipation			8475.5		mW	
I_{VDD1P8}	Group 3A: VDD1P8FB + VDD1P8RX + VDD1P8TX	Mode 8: same configuration as mode 7, Sleep Mode. SLEEP pin is pull high.		20.3		mA	
	Group 3B: VDD1P8FBCLK + VDD1P8RXCLK + VDD1P8TXDAC+ VDD1P8GPIO + VDDA1P8			292.8		mA	
	Group 3C: VDD1P8PLL + VDD1P8PLLCO			12.6		mA	
I_{VDD1P2}	Group 2A: VDD1P2FB + VDD1P2RX			4.6		mA	
	Group 2B: VDD1P2TXCLK + VDD1P2TXENC			54.3		mA	
	Group 2C: VDD1P2FBCML + VDD1P2RXCML + VDD1P2PLLCLKREF			15.3		mA	
I_{VDD0P9}	Group 1A: DVDD0P9 + VDDT0P9			313.1		mA	
P_{diss}	Power Dissipation			956.8		mW	
I_{VDD1P8}	Group 3A: VDD1P8FB + VDD1P8RX + VDD1P8TX		Mode 9: 4T4R2F - FDD FB 100% on TX Single Band: 24x Int, FB 12x Dec RX Single Band: RX 24x TX/FB Rate 245.76 Msp RX Rate 122.88 Msp $f_{DAC} = 5898.24\text{ MSPS}$ $f_{ADC} = 2949.12\text{ MSPS}$ $f_{TX} = 0.85\text{ GHz}$ $f_{RX} = 0.8\text{ GHz}$ 8/10 coding, 9.8304Gbps TX: 4-8-4-1, FB: 2-4-4-1, RX: 2-8-8-1		1593.2		mA
	Group 3B: VDD1P8FBCLK + VDD1P8RXCLK + VDD1P8TXDAC+ VDD1P8GPIO + VDDA1P8				840.6		mA
	Group 3C: VDD1P8PLL + VDD1P8PLLCO			77.3		mA	
I_{VDD1P2}	Group 2A: VDD1P2FB + VDD1P2RX			905.0		mA	
	Group 2B: VDD1P2TXCLK + VDD1P2TXENC			817.7		mA	
	Group 2C: VDD1P2FBCML + VDD1P2RXCML + VDD1P2PLLCLKREF			52.1		mA	
I_{VDD0P9}	Group 1A: DVDD0P9 + VDDT0P9			2405.2		mA	
P_{diss}	Power Dissipation			8814.3		mW	

6.9 Power Supply Electrical Characteristics (continued)

Typical values at $T_A = +25^\circ\text{C}$, full temperature range is $T_{A,\text{MIN}} = -40^\circ\text{C}$ to $T_{J,\text{MAX}} = +110^\circ\text{C}$; TX Input Rate = 491.52MSPS, $f_{\text{DAC}} = 8847.36\text{MSPS}$ interleave mode; $f_{\text{ADC}} = 2949.12\text{MSPS}$; nominal power supplies; 1 tone at -1 dBFS; DSA Attenuation = 0dB; SerDes rate = 24.33Gbps; unless otherwise noted.

PARAMETER		TEST CONDITIONS	MIN	TYP	MAX	UNIT
I_{VDD1P8}	Group 3A: VDD1P8FB + VDD1P8RX + VDD1P8TX	Mode 10: 4T4R2F - FDD FB 100% on TX Single Band: 18x Int, FB 6x Dec RX Single Band: RX 12x TX/FB Rate 491.52 MSPS RX Rate 245.76 MSPS $f_{\text{DAC}} =$ 8847.36 MSPS $f_{\text{ADC}} = 2949.12\text{MSPS}$ $f_{\text{TX}} = 1.85\text{GHz}$ $f_{\text{RX}} = 1.75\text{GHz}$ 8/10 coding, 9.8304Gbps TX: 8-8-2-1, FB: 4-4-2-1, RX: 4-8-4-1		1626.2		mA
	Group 3B: VDD1P8FBCLK + VDD1P8RXCLK + VDD1P8TXDAC+ VDD1P8GPIO + VDDA1P8			976.4		mA
	Group 3C: VDD1P8PLL + VDD1P8PLLVC0			74.6		mA
I_{VDD1P2}	Group 2A: VDD1P2FB + VDD1P2RX			902.7		mA
	Group 2B: VDD1P2TXCLK + VDD1P2TXENC			1111.9		mA
	Group 2C: VDD1P2FBCML + VDD1P2RXCML + VDD1P2PLLCLKREF			48.0		mA
I_{VDD0P9}	Group 1A: DVDD0P9 + VDDT0P9			3578.9		mA
P_{diss}	Power Dissipation			10515.0		mW
I_{VDD1P8}	Group 3A: VDD1P8FB + VDD1P8RX + VDD1P8TX		Mode 11a: TDD 4T1FB (RX in Standby) Single Band: 8x Int, FB 2x Dec, RX uses FB TX/FB/RX Rate = 1474.56 MSPS f_{DAC} = 11796.48 MSPS $f_{\text{ADC}} = 2949.12\text{MSPS}$ $f_{\text{TX}} = f_{\text{RX}} = 8\text{GHz}$ 64/66 coding, 24.33 Gbps TX: 8-8-2-1, FB/RX: 4-4-4-2		800	
	Group 3B: VDD1P8FBCLK + VDD1P8RXCLK + VDD1P8TXDAC+ VDD1P8GPIO + VDDA1P8			840		mA
	Group 3C: VDD1P8PLL + VDD1P8PLLVC0			73		mA
I_{VDD1P2}	Group 2A: VDD1P2FB + VDD1P2RX			190		mA
	Group 2B: VDD1P2TXCLK + VDD1P2TXENC			1440		mA
	Group 2C: VDD1P2FBCML + VDD1P2RXCML + VDD1P2PLLCLKREF			75		mA
I_{VDD0P9}	Group 1A: DVDD0P9 + VDDT0P9			3070		mA
P_{diss}	Power Dissipation			8010		mW
I_{VDD1P8}	Group 3A: VDD1P8FB + VDD1P8RX + VDD1P8TX	Mode 11b: TDD 4R (TX in Standby) Single Band: 8x Int, FB 2x Dec, RX uses FB TX/FB/RX Rate = 1474.56 MSPS f_{DAC} = 11796.48 MSPS $f_{\text{ADC}} = 2949.12\text{MSPS}$ $f_{\text{TX}} = f_{\text{RX}} = 8\text{GHz}$ 64/66 coding, 24.33 Gbps TX: 8-8-2-1, FB/RX: 4-4-4-2			750	
	Group 3B: VDD1P8FBCLK + VDD1P8RXCLK + VDD1P8TXDAC+ VDD1P8GPIO + VDDA1P8			890		mA
	Group 3C: VDD1P8PLL + VDD1P8PLLVC0			72		mA
I_{VDD1P2}	Group 2A: VDD1P2FB + VDD1P2RX			610		mA
	Group 2B: VDD1P2TXCLK + VDD1P2TXENC			280		mA
	Group 2C: VDD1P2FBCML + VDD1P2RXCML + VDD1P2PLLCLKREF			72		mA
I_{VDD0P9}	Group 1A: DVDD0P9 + VDDT0P9			2360		mA
P_{diss}	Power Dissipation			6460		mW

6.9 Power Supply Electrical Characteristics (continued)

Typical values at $T_A = +25^\circ\text{C}$, full temperature range is $T_{A,\text{MIN}} = -40^\circ\text{C}$ to $T_{J,\text{MAX}} = +110^\circ\text{C}$; TX Input Rate = 491.52MSPS, $f_{\text{DAC}} = 8847.36\text{MSPS}$ interleave mode; $f_{\text{ADC}} = 2949.12\text{MSPS}$; nominal power supplies; 1 tone at -1 dBFS; DSA Attenuation = 0dB; SerDes rate = 24.33Gbps; unless otherwise noted.

PARAMETER		TEST CONDITIONS	MIN	TYP	MAX	UNIT
I_{VDD1P8}	Group 3A: VDD1P8FB + VDD1P8RX + VDD1P8TX	Mode 11c: TDD 4T4R1FB average TX/FB: 75%, RX 25% Single Band: 8x Int, FB 2x Dec, RX uses FB TX/FB/RX Rate = 1474.56 Msps $f_{\text{DAC}} = 11796.48\text{ MSPS}$ $f_{\text{ADC}} = 2949.12\text{ MSPS}$ $f_{\text{TX}} = f_{\text{RX}} = 8\text{ GHz}$ 64/66 coding, 24.33 Gbps TX: 8-8-2-1, FB/RX: 4-4-4-2		790		mA
	Group 3B: VDD1P8FBCLK + VDD1P8RXCLK + VDD1P8TXDAC+ VDD1P8GPIO + VDDA1P8			850		mA
	Group 3C: VDD1P8PLL + VDD1P8PLLCO			73		mA
I_{VDD1P2}	Group 2A: VDD1P2FB + VDD1P2RX			300		mA
	Group 2B: VDD1P2TXCLK + VDD1P2TXENC			1150		mA
	Group 2C: VDD1P2FBCML + VDD1P2RXCML + VDD1P2PLLCLKREF			75		mA
I_{VDD0P9}	Group 1A: DVDD0P9 + VDDT0P9			2890		mA
P_{diss}	Power Dissipation			7620		mW
I_{VDD1P8}	Group 3A: VDD1P8FB + VDD1P8RX + VDD1P8TX		Mode 11d: FDD 4T4R Single Band: 8x Int, RX uses FB TX/FB/RX Rate = 1474.56 Msps $f_{\text{DAC}} = 11796.48\text{ MSPS}$ $f_{\text{ADC}} = 2949.12\text{ MSPS}$ $f_{\text{TX}} = f_{\text{RX}} = 8\text{ GHz}$ 64/66 coding, 24.33 Gbps TX: 8-8-2-1, FB/RX: 4-4-4-2		1260	
	Group 3B: VDD1P8FBCLK + VDD1P8RXCLK + VDD1P8TXDAC+ VDD1P8GPIO + VDDA1P8			940		mA
	Group 3C: VDD1P8PLL + VDD1P8PLLCO			73		mA
I_{VDD1P2}	Group 2A: VDD1P2FB + VDD1P2RX			630		mA
	Group 2B: VDD1P2TXCLK + VDD1P2TXENC			1480		mA
	Group 2C: VDD1P2FBCML + VDD1P2RXCML + VDD1P2PLLCLKREF			78		mA
I_{VDD0P9}	Group 1A: DVDD0P9 + VDDT0P9			4200		mA
P_{diss}	Power Dissipation			10640		mW

6.10 Timing Requirements

Typical values at $T_A = +25^\circ\text{C}$, full temperature range is $T_{A,\text{MIN}} = -40^\circ\text{C}$ to $T_{J,\text{MAX}} = +110^\circ\text{C}$; TX Input Rate = 491.52MSPS, $f_{\text{DAC}} = 8847.36\text{MSPS}$; $f_{\text{ADC}} = 2949.12\text{MSPS}$; nominal power supplies; 1 tone at -1 dBFS; DSA Attenuation = 0dB; SerDes rate = 24.33Gbps; unless otherwise noted.

		MIN	NOM	MAX	UNIT
Timing: SYSREF+/-					
$t_{\text{s}}(\text{SYSREF})$	Setup Time, SYSREF+/- Valid to Rising Edge of CLK+/-		50		ps
$t_{\text{h}}(\text{SYSREF})$	Hold Time, SYSREF+/- Valid after Rising Edge of CLK+/-		50		ps
Timing: Serial ports					
$t_{\text{s}}(\text{SENB})$	Setup Time, SENB to Rising Edge of SCLK		15		ns
$t_{\text{h}}(\text{SENB})$	Hold Time, SENB after last Rising Edge of SCLK ⁽¹⁾		$5 + t_{\text{sCLK}}$		ns
$t_{\text{s}}(\text{SDIO})$	Setup Time, SDIO valid to Rising Edge of SCLK		15		ns
$t_{\text{h}}(\text{SDIO})$	Hold Time, SDIO valid after Rising Edge of SCLK		5		ns
$t_{\text{s}}(\text{SCLK_W})$	Minimum SCLK period: registers write		25		ns
$t_{\text{s}}(\text{SCLK_R})$	Minimum SCLK period: registers read		50		ns
$t_{\text{d}}(\text{data_out})$	Minimum Data Output delay after Falling Edge of SCLK		0		ns
	Maximum Data Output delay after Falling Edge of SCLK		15		ns
t_{RESET}	Minimum RESETZ Pulse Width		1		ms

(1) SDEN\ need to be held one more extra clock cycle with the last SCLK edge

6.11 Switching Characteristics

Typical values at $T_A = +25^\circ\text{C}$, full temperature range is $T_{A,\text{MIN}} = -40^\circ\text{C}$ to $T_{J,\text{MAX}} = +110^\circ\text{C}$; TX Input Rate = 491.52MSPS, $f_{\text{DAC}} = 8847.36\text{MSPS}$; $f_{\text{ADC}} = 2949.12\text{MSPS}$; nominal power supplies; 1 tone at -1 dBFS; DSA Attenuation = 0dB; SerDes rate = 24.33Gbps; unless otherwise noted.

PARAMETER		TEST CONDITIONS	MIN	TYP	MAX	UNIT
TX Channel Latency						
	SerDes Receiver Analog Delay	Full rate		2.8		ns
$t_{\text{JESD TX}}$	JESD to TX output Latency	LMFSHd=2-8-8-1, 368.64 MSPS input rate, 24x Interpolation, Serdes rate = 16.22Gbps (JESD204C)		152		interface clock cycles ⁽¹⁾
		LMFSHd=8-16-4-1, 491.52 MSPS 24x Interpolation, Serdes rate = 16.22Gbps (JESD204C)		176		
		LMFSHd=4-16-8-1, 245.76 MSPS 48x Interpolation, Serdes rate = 16.22Gbps (JESD204C)		124		
		LMFSHd=2-16-16-1, 122.88 MSPS 96x Interpolation, Serdes rate = 16.22Gbps (JESD204C)		97		
RX Channel Latency						
	SerDes Transmitter Analog Delay			3.6		ns
$t_{\text{JESD RX}}$	RX input to JESD output Latency	LMFS=2-16-16-1, 122.88 MSPS, 24x Decimation, Serdes rate = 16.22Gbps (JESD204C)		92		interface clock cycles ⁽¹⁾
		LMFS=4-16-8-1, 245.76 MSPS, 12x Decimation, Serdes rate = 16.22Gbps (JESD204C)		108		
		LMFS=4-8-4-1, 491.52 MSPS, 6x Decimation, Serdes rate = 16.22Gbps (JESD204C)		153		
FB Channel Latency						
	SerDes Transmitter Analog Delay			3.6		ns
$t_{\text{JESD FB}}$	FB input to JESD output Latency	LMFS=1-2-8-1, 368.64 MSPS, 8x Decimation		151		interface clock cycles ⁽¹⁾
		LMFS=2-4-4-1, 491.52 MSPS, 6x Decimation		177		

(1) Interface clock cycles is the period of the digital interface sample rate, e.g. 1GSPS = 1ns.

6.12 Typical Characteristics

6.12.1 TX Typical Characteristics 800 MHz

Typical values at $T_A = +25^\circ\text{C}$ with nominal supplies. Default conditions: TX input data rate = 491.52MSPS, $f_{DAC} = 11796.48\text{MSPS}$ (24x interpolation), interleave mode, 1st Nyquist zone output, PLL clock mode with $f_{REF} = 491.52\text{ MHz}$, $A_{OUT} = -1\text{ dBFS}$, DSA = 0 dB, Sin(x)/x enabled, DSA calibrated, TX Clock Dither Enabled

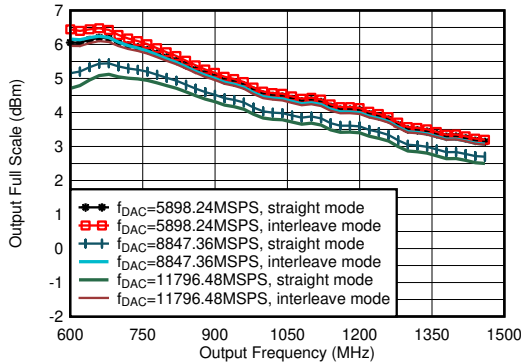

including PCB and cable losses, $A_{out} = -0.5\text{dBFS}$, DSA = 0, 0.8 GHz matching

Figure 6-1. TX Output Fullscale vs Output Frequency

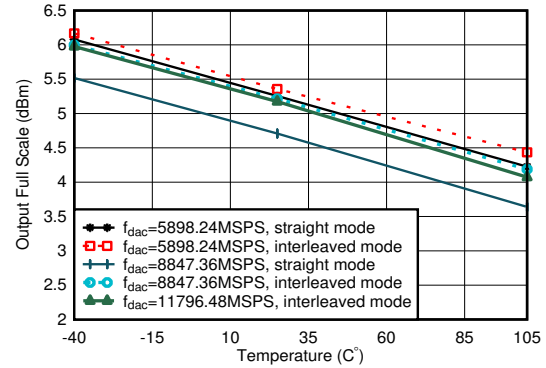

including PCB and cable losses, $A_{out} = -0.5\text{dBFS}$, DSA = 0, 0.8 GHz matching

Figure 6-2. TX Output Fullscale vs Temperature

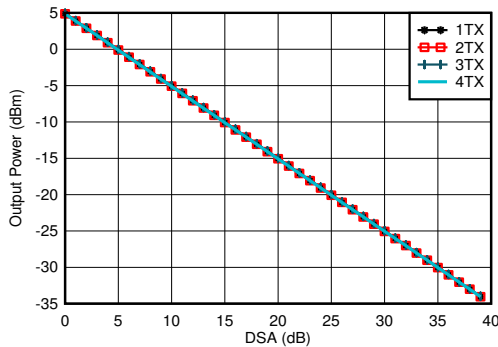

$f_{DAC} = 11796.48\text{ MSPS}$, interleave mode, $A_{out} = -0.5\text{dBFS}$, matching 0.8 GHz

Figure 6-3. TX Output Power vs DSA Setting and Channel at 0.85 GHz

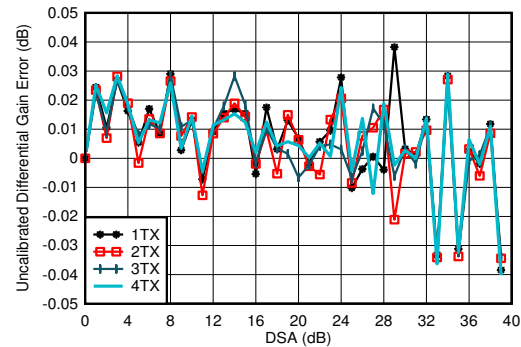

$f_{DAC} = 5898.24\text{MSPS}$, interleave mode, matching at 0.8 GHz
Differential Gain Error = $P_{OUT}(\text{DSA Setting} - 1) - P_{OUT}(\text{DSA Setting}) + 1$

Figure 6-4. TX Uncalibrated Differential Gain Error vs DSA Setting and Channel at 0.85 GHz

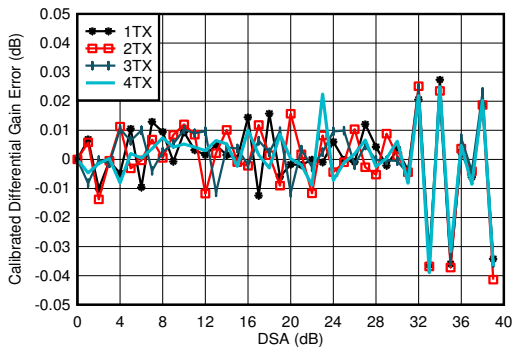

$f_{DAC} = 5898.24\text{MSPS}$, interleave mode, matching at 0.8 GHz
Differential Gain Error = $P_{OUT}(\text{DSA Setting} - 1) - P_{OUT}(\text{DSA Setting}) + 1$

Figure 6-5. TX Calibrated Differential Gain Error vs DSA Setting and Channel at 0.85 GHz

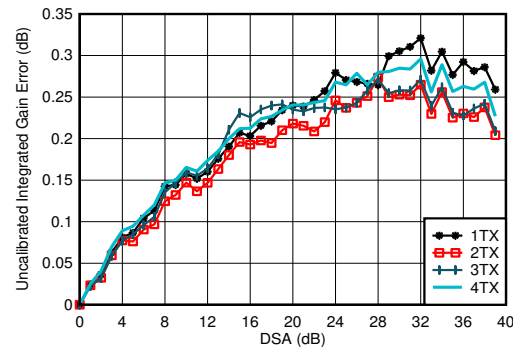

$f_{DAC} = 5898.24\text{MSPS}$, interleave mode, matching at 0.8 GHz
Integrated Gain Error = $P_{OUT}(\text{DSA Setting}) - P_{OUT}(\text{DSA Setting} = 0) + \text{DSA Settings}$

Figure 6-6. TX Uncalibrated Integrated Gain Error vs DSA Setting and Channel at 0.85 GHz

6.12.1 TX Typical Characteristics 800 MHz (continued)

Typical values at $T_A = +25^\circ\text{C}$ with nominal supplies. Default conditions: TX input data rate = 491.52MSPS, $f_{\text{DAC}} = 11796.48\text{MSPS}$ (24x interpolation), interleave mode, 1st Nyquist zone output, PLL clock mode with $f_{\text{REF}} = 491.52\text{ MHz}$, $A_{\text{OUT}} = -1\text{ dBFS}$, DSA = 0 dB, Sin(x)/x enabled, DSA calibrated, TX Clock Dither Enabled

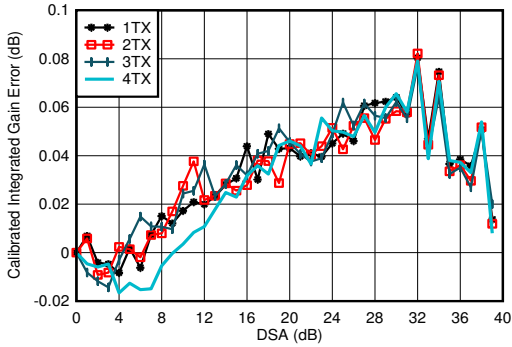

$f_{\text{DAC}} = 5898.24\text{MSPS}$, interleave mode, matching at 0.8 GHz
Integrated Gain Error = $P_{\text{OUT}}(\text{DSA Setting}) - P_{\text{OUT}}(\text{DSA Setting} = 0) + \text{DSA Setting}$

Figure 6-7. TX Calibrated Integrated Gain Error vs DSA Setting and Channel at 0.85 GHz

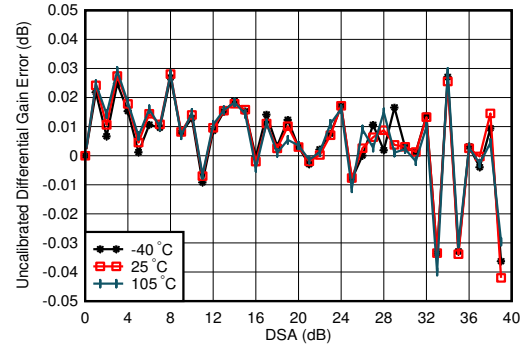

$f_{\text{DAC}} = 5898.24\text{MSPS}$, interleave mode, matching at 0.8 GHz
Differential Gain Error = $P_{\text{OUT}}(\text{DSA Setting} - 1) - P_{\text{OUT}}(\text{DSA Setting}) + 1$

Figure 6-8. TX Uncalibrated Differential Gain Error vs DSA Setting and Temperature at 0.85 GHz

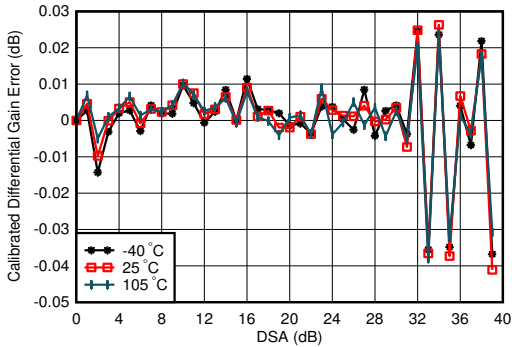

$f_{\text{DAC}} = 5898.24\text{MSPS}$, interleave mode, matching at 0.8 GHz
Differential Gain Error = $P_{\text{OUT}}(\text{DSA Setting} - 1) - P_{\text{OUT}}(\text{DSA Setting}) + 1$

Figure 6-9. TX Calibrated Differential Gain Error vs DSA Setting and Temperature at 0.85 GHz

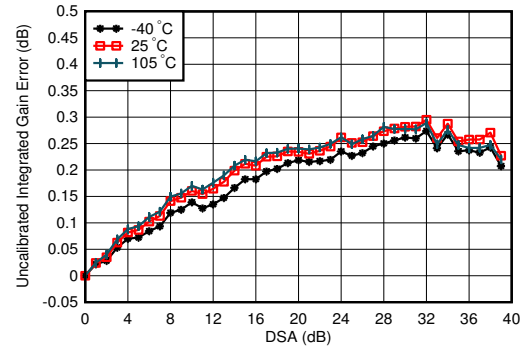

$f_{\text{DAC}} = 5898.24\text{MSPS}$, interleave mode, matching at 0.8 GHz
Integrated Gain Error = $P_{\text{OUT}}(\text{DSA Setting}) - P_{\text{OUT}}(\text{DSA Setting} = 0) + \text{DSA Setting}$

Figure 6-10. TX Uncalibrated Integrated Gain Error vs DSA Setting and Temperature at 0.85 GHz

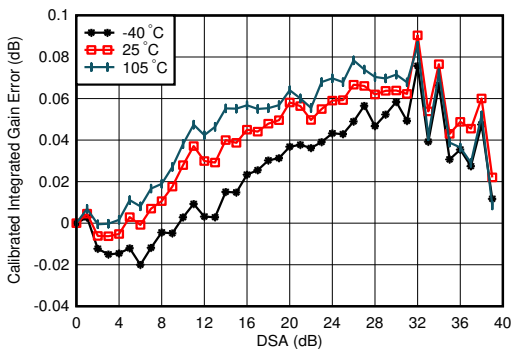

$f_{\text{DAC}} = 5898.24\text{MSPS}$, interleave mode, matching at 0.8 GHz
Integrated Gain Error = $P_{\text{OUT}}(\text{DSA Setting}) - P_{\text{OUT}}(\text{DSA Setting} = 0) + \text{DSA Setting}$

Figure 6-11. TX Calibrated Integrated Gain Error vs DSA Setting and Temperature at 0.85 GHz

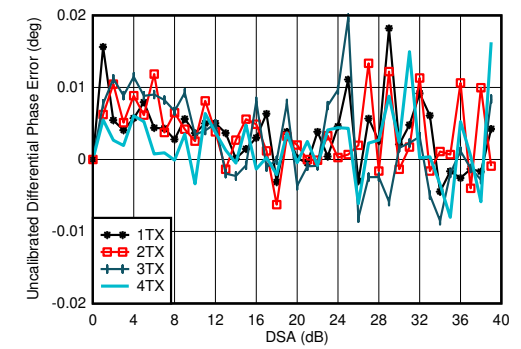

$f_{\text{DAC}} = 5898.24\text{MSPS}$, interleave mode, matching at 0.8 GHz
Differential Phase Error = $\text{Phase}_{\text{OUT}}(\text{DSA Setting} - 1) - \text{Phase}_{\text{OUT}}(\text{DSA Setting})$

Figure 6-12. TX Uncalibrated Differential Phase Error vs DSA Setting and Channel at 0.85 GHz

6.12.1 TX Typical Characteristics 800 MHz (continued)

Typical values at $T_A = +25^\circ\text{C}$ with nominal supplies. Default conditions: TX input data rate = 491.52MSPS, $f_{\text{DAC}} = 11796.48\text{MSPS}$ (24x interpolation), interleave mode, 1st Nyquist zone output, PLL clock mode with $f_{\text{REF}} = 491.52\text{ MHz}$, $A_{\text{OUT}} = -1\text{ dBFS}$, DSA = 0 dB, Sin(x)/x enabled, DSA calibrated, TX Clock Dither Enabled

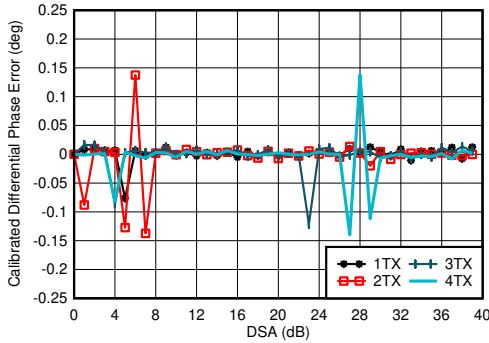

$f_{\text{DAC}} = 5898.24\text{MSPS}$, interleave mode, matching at 0.8 GHz
 Differential Phase Error = $\text{Phase}_{\text{OUT}}(\text{DSA Setting} - 1) - \text{Phase}_{\text{OUT}}(\text{DSA Setting})$
 Phase DNL spike may occur at any DSA setting.

Figure 6-13. TX Calibrated Differential Phase Error vs DSA Setting and Channel at 0.85 GHz

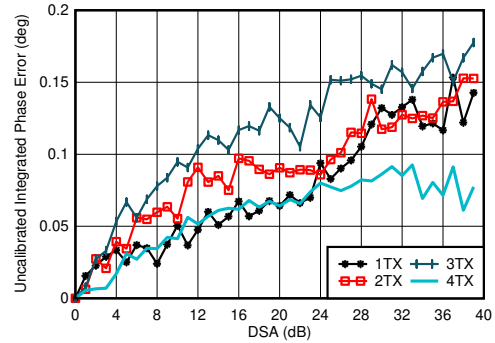

$f_{\text{DAC}} = 5898.24\text{MSPS}$, interleave mode, matching at 0.8 GHz
 Integrated Phase Error = $\text{Phase}_{\text{OUT}}(\text{DSA Setting}) - \text{Phase}_{\text{OUT}}(\text{DSA Setting} = 0)$

Figure 6-14. TX Uncalibrated Integrated Phase Error vs DSA Setting and Channel at 0.85 GHz

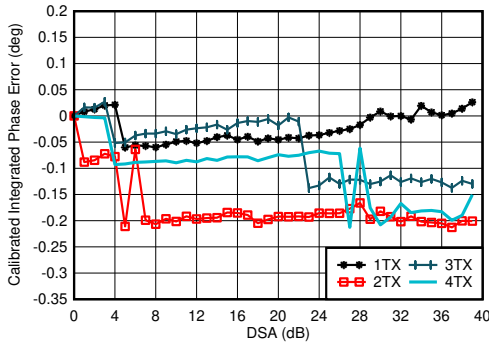

$f_{\text{DAC}} = 5898.24\text{MSPS}$, interleave mode, matching at 0.8 GHz
 Integrated Phase Error = $\text{Phase}_{\text{OUT}}(\text{DSA Setting}) - \text{Phase}_{\text{OUT}}(\text{DSA Setting} = 0)$

Figure 6-15. TX Calibrated Integrated Phase Error vs DSA Setting and Channel at 0.85 GHz

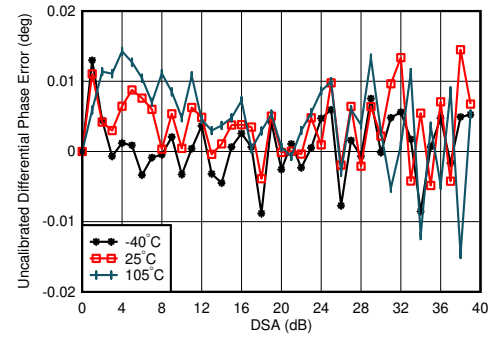

$f_{\text{DAC}} = 5898.24\text{MSPS}$, interleave mode, matching at 0.8 GHz
 Differential Phase Error = $\text{Phase}_{\text{OUT}}(\text{DSA Setting} - 1) - \text{Phase}_{\text{OUT}}(\text{DSA Setting}) + 1$

Figure 6-16. TX Uncalibrated Differential Phase Error vs DSA Setting and Temperature at 0.85 GHz

6.12.1 TX Typical Characteristics 800 MHz (continued)

Typical values at $T_A = +25^\circ\text{C}$ with nominal supplies. Default conditions: TX input data rate = 491.52MSPS, $f_{\text{DAC}} = 11796.48\text{MSPS}$ (24x interpolation), interleave mode, 1st Nyquist zone output, PLL clock mode with $f_{\text{REF}} = 491.52\text{ MHz}$, $A_{\text{OUT}} = -1\text{ dBFS}$, DSA = 0 dB, Sin(x)/x enabled, DSA calibrated, TX Clock Dither Enabled

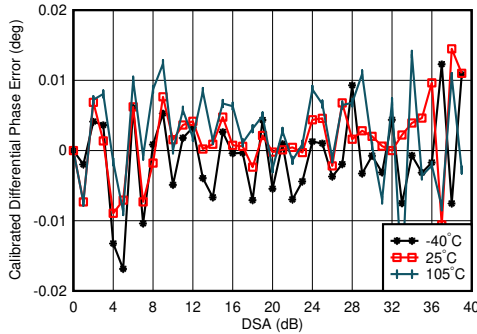

$f_{\text{DAC}} = 5898.24\text{MSPS}$, interleave mode, matching at 0.8 GHz, channel with the median variation over DSA setting at 25°C
Differential Phase Error = $\text{Phase}_{\text{OUT}}(\text{DSA Setting} - 1) - \text{Phase}_{\text{OUT}}(\text{DSA Setting}) + 1$

Figure 6-17. TX Calibrated Differential Phase Error vs DSA Setting and Temperature at 0.85 GHz

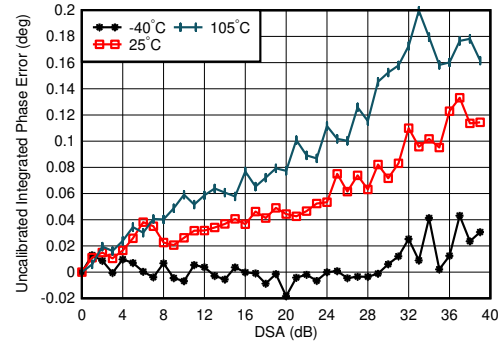

$f_{\text{DAC}} = 5898.24\text{MSPS}$, interleave mode, matching at 0.8 GHz
Integrated Phase Error = $\text{Phase}_{\text{OUT}}(\text{DSA Setting}) - \text{Phase}_{\text{OUT}}(\text{DSA Setting} = 0)$

Figure 6-18. TX Uncalibrated Integrated Phase Error vs DSA Setting and Temperature at 0.85 GHz

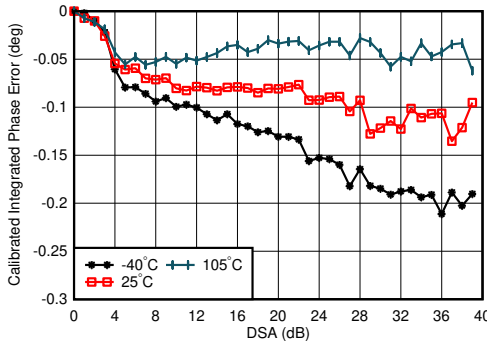

$f_{\text{DAC}} = 5898.24\text{MSPS}$, interleave mode, matching at 0.8 GHz
Integrated Phase Error = $\text{Phase}_{\text{OUT}}(\text{DSA Setting}) - \text{Phase}_{\text{OUT}}(\text{DSA Setting} = 0)$

Figure 6-19. TX Calibrated Integrated Phase Error vs DSA Setting and Temperature at 0.85 GHz

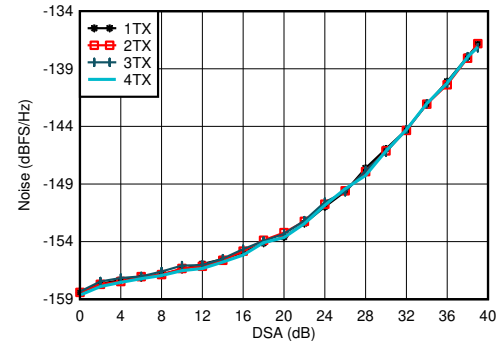

$f_{\text{DAC}} = 5898.24\text{MSPS}$, interleave mode, matching at 0.8 GHz, $P_{\text{OUT}} = -13\text{ dBFS}$

Figure 6-20. TX Output Noise vs Channel and Attenuation at 0.85 GHz

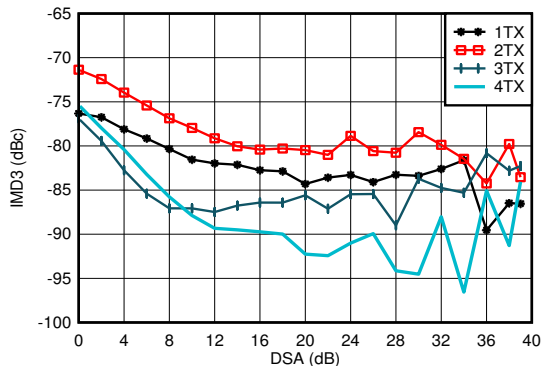

$f_{\text{DAC}} = 11796.48\text{MSPS}$, interleave mode, $f_{\text{CENTER}} = 0.85\text{ GHz}$, matching at 0.8 GHz, -13 dBFS each tone

Figure 6-21. TX IMD3 vs DSA Setting at 0.85 GHz

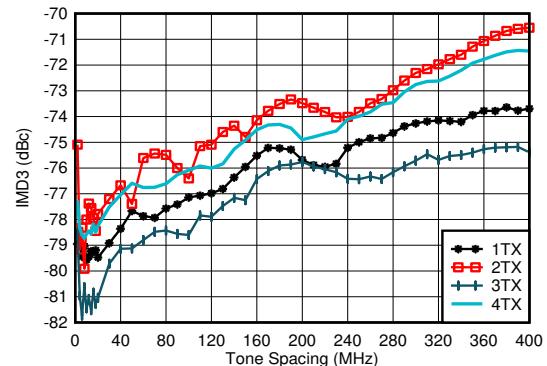

$f_{\text{DAC}} = 5898.24\text{MSPS}$, straight mode, $f_{\text{CENTER}} = 0.85\text{ GHz}$, matching at 0.8 GHz, -13 dBFS each tone

Figure 6-22. TX IMD3 vs Tone Spacing and Channel at 0.85 GHz

6.12.1 TX Typical Characteristics 800 MHz (continued)

Typical values at $T_A = +25^\circ\text{C}$ with nominal supplies. Default conditions: TX input data rate = 491.52MSPS, $f_{\text{DAC}} = 11796.48\text{MSPS}$ (24x interpolation), interleave mode, 1st Nyquist zone output, PLL clock mode with $f_{\text{REF}} = 491.52\text{ MHz}$, $A_{\text{OUT}} = -1\text{ dBFS}$, DSA = 0 dB, Sin(x)/x enabled, DSA calibrated, TX Clock Dither Enabled

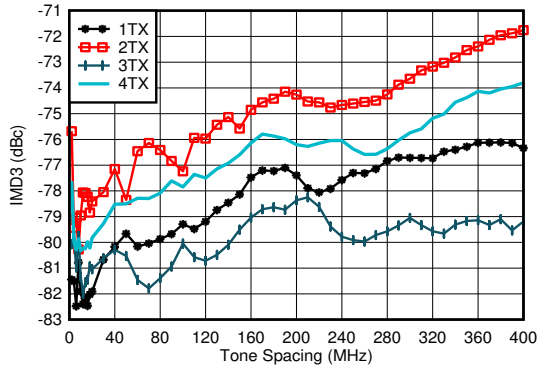

$f_{\text{DAC}} = 8847.36\text{MSPS}$, straight mode, $f_{\text{CENTER}} = 0.85\text{ GHz}$, matching at 0.8 GHz, -13 dBFS each tone

Figure 6-23. TX IMD3 vs Tone Spacing and Channel at 0.85 GHz

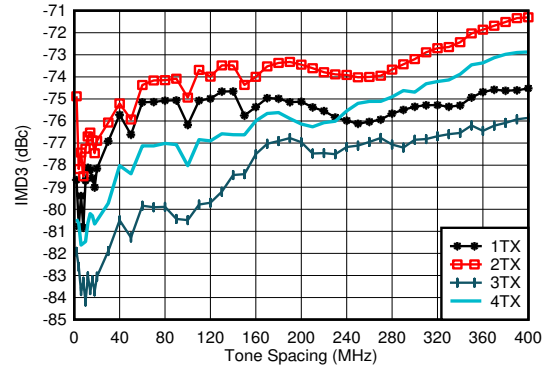

$f_{\text{DAC}} = 11796.48\text{MSPS}$, interleave mode, $f_{\text{CENTER}} = 0.85\text{ GHz}$, matching at 0.8 GHz, -13 dBFS each tone

Figure 6-24. TX IMD3 vs Tone Spacing and Channel at 0.85 GHz

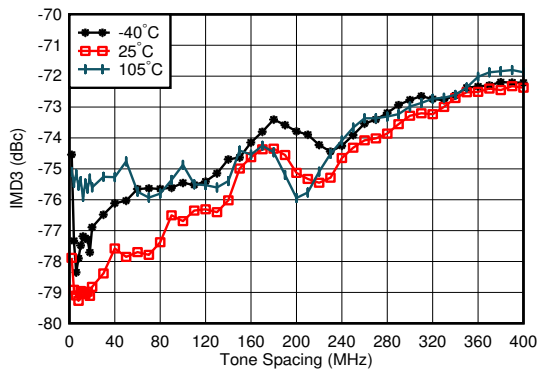

$f_{\text{DAC}} = 5898.24\text{MSPS}$, straight mode, $f_{\text{CENTER}} = 0.85\text{ GHz}$, matching at 0.8 GHz, -13 dBFS each tone, worst channel

Figure 6-25. TX IMD3 vs Tone Spacing and Temperature at 0.85 GHz

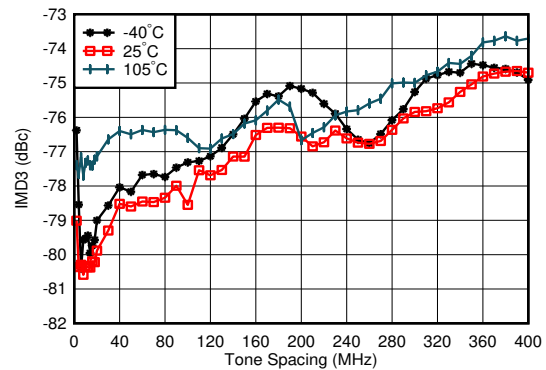

$f_{\text{DAC}} = 8847.36\text{MSPS}$, straight mode, $f_{\text{CENTER}} = 0.85\text{ GHz}$, matching at 0.8 GHz, -13 dBFS each tone, worst channel

Figure 6-26. TX IMD3 vs Tone Spacing and Temperature at 0.85 GHz

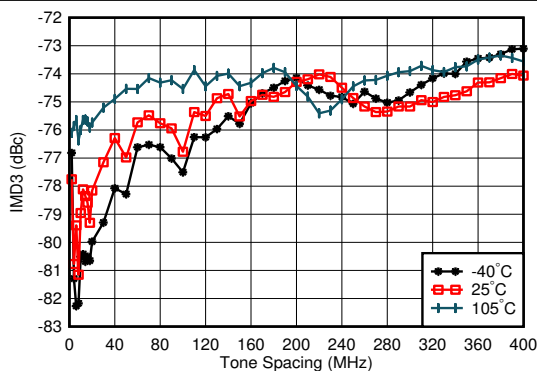

$f_{\text{DAC}} = 11796.48\text{MSPS}$, straight mode, $f_{\text{CENTER}} = 0.85\text{ GHz}$, matching at 0.8 GHz, -13 dBFS each tone, worst channel

Figure 6-27. TX IMD3 vs Tone Spacing and Temperature at 0.85 GHz

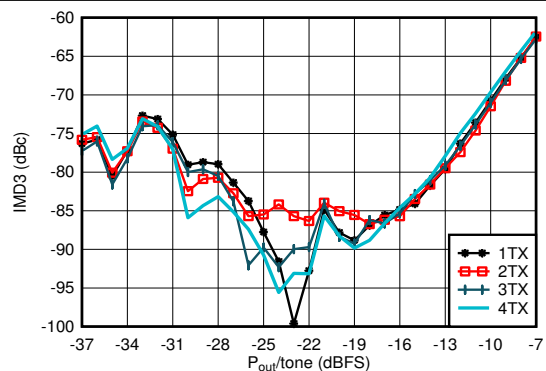

$f_{\text{DAC}} = 5898.24\text{MSPS}$, straight mode, $f_{\text{CENTER}} = 0.85\text{ GHz}$, $f_{\text{SPACING}} = 20\text{ MHz}$, matching at 0.8 GHz

Figure 6-28. TX IMD3 vs Digital Level at 0.85 GHz

6.12.1 TX Typical Characteristics 800 MHz (continued)

Typical values at $T_A = +25^\circ\text{C}$ with nominal supplies. Default conditions: TX input data rate = 491.52MSPS, $f_{DAC} = 11796.48\text{MSPS}$ (24x interpolation), interleave mode, 1st Nyquist zone output, PLL clock mode with $f_{REF} = 491.52\text{ MHz}$, $A_{OUT} = -1\text{ dBFS}$, DSA = 0 dB, Sin(x)/x enabled, DSA calibrated, TX Clock Dither Enabled

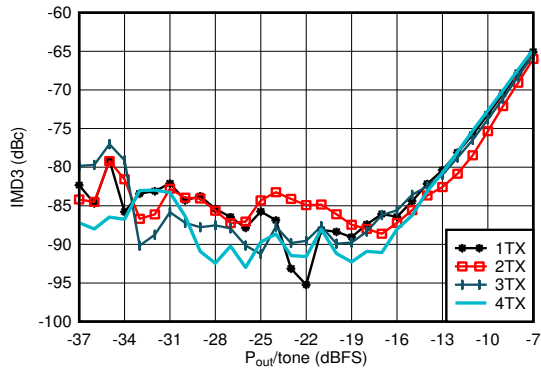

$f_{DAC} = 8847.36\text{MSPS}$, straight mode, $f_{CENTER} = 0.85\text{ GHz}$,
 $f_{SPACING} = 20\text{ MHz}$, matching at 0.8 GHz

Figure 6-29. TX IMD3 vs Digital Level at 0.85 GHz

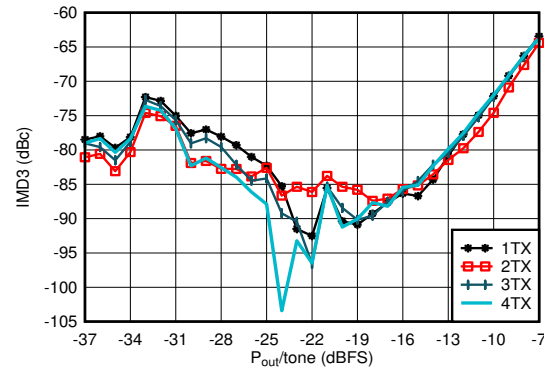

$f_{DAC} = 11796.48\text{MSPS}$, interleave mode, $f_{CENTER} = 0.85\text{ GHz}$,
 $f_{SPACING} = 20\text{ MHz}$, matching at 0.8 GHz

Figure 6-30. TX IMD3 vs Digital Level at 0.85 GHz

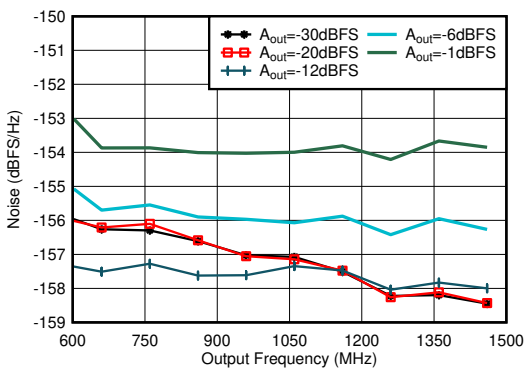

Matching at 2.6 GHz, Single tone, $f_{DAC} = 11.79648\text{GSPS}$,
interleave mode, 40-MHz offset, DSA = 0dB

Figure 6-31. TX Single Tone Output Noise vs Frequency and Amplitude at 0.85 GHz

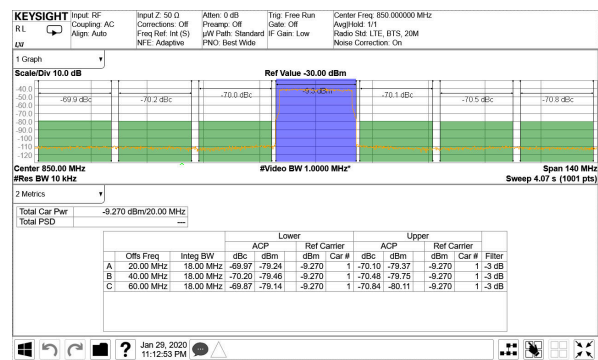

TM1.1, $P_{OUT_RMS} = -13\text{ dBFS}$

Figure 6-32. TX 20-MHz LTE Output Spectrum at 0.85 GHz

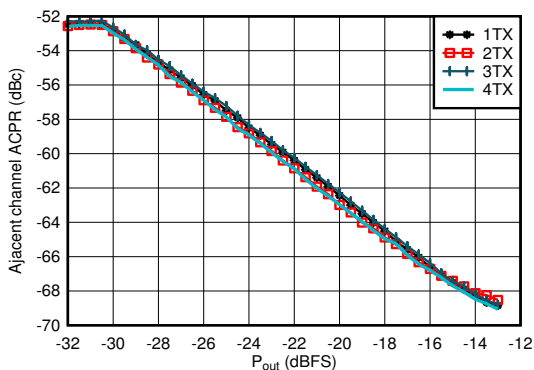

Matching at 0.8 GHz, single carrier 20-MHz BW TM1.1 LTE

Figure 6-33. TX 20-MHz LTE ACPR vs Digital Level at 0.85 GHz

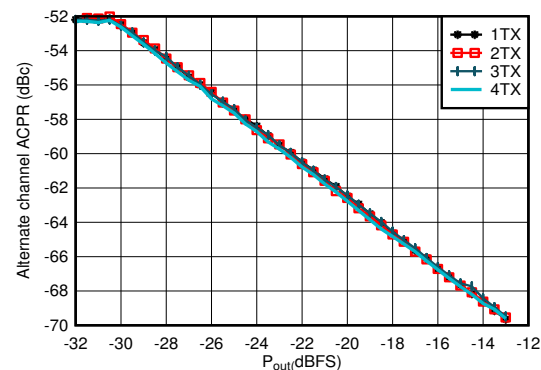

Matching at 0.8 GHz, single carrier 20-MHz BW TM1.1 LTE

Figure 6-34. TX 20-MHz LTE alt-ACPR vs Digital Level at 0.85 GHz

6.12.1 TX Typical Characteristics 800 MHz (continued)

Typical values at $T_A = +25^\circ\text{C}$ with nominal supplies. Default conditions: TX input data rate = 491.52MSPS, $f_{DAC} = 11796.48\text{MSPS}$ (24x interpolation), interleave mode, 1st Nyquist zone output, PLL clock mode with $f_{REF} = 491.52\text{ MHz}$, $A_{OUT} = -1\text{ dBFS}$, DSA = 0 dB, Sin(x)/x enabled, DSA calibrated, TX Clock Dither Enabled

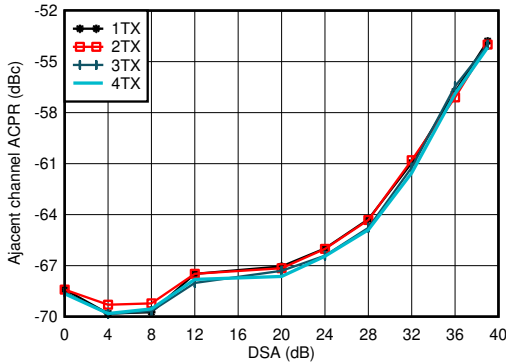

Matching at 0.8 GHz, single carrier 20-MHz BW TM1.1 LTE

Figure 6-35. TX 20-MHz LTE ACPR vs DSA at 0.85 GHz

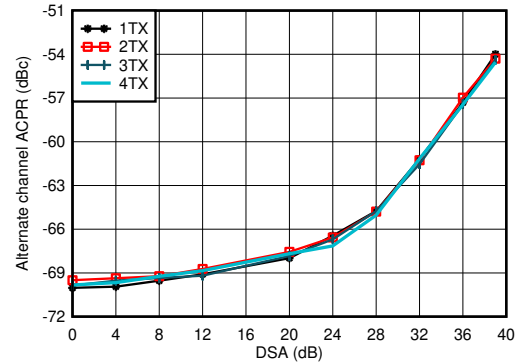

Matching at 0.8 GHz, single carrier 20-MHz BW TM1.1 LTE

Figure 6-36. TX 20-MHz LTE alt-ACPR vs DSA at 0.85 GHz

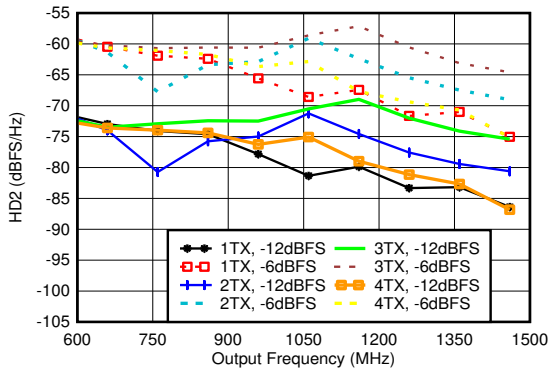

Matching at 0.8 GHz, $f_{DAC} = 5898.24\text{GSPS}$, straight mode

Figure 6-37. TX HD2 vs Digital Amplitude and Output Frequency at 0.85 GHz

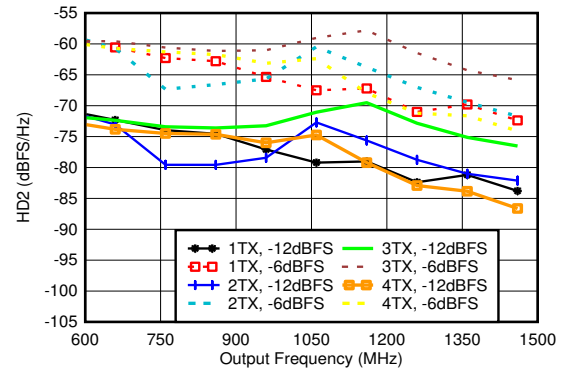

Matching at 0.8 GHz, $f_{DAC} = 8847.36\text{GSPS}$, straight mode

Figure 6-38. TX HD2 vs Digital Amplitude and Output Frequency at 0.85 GHz

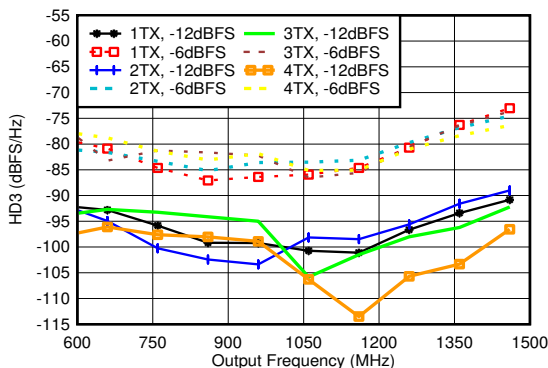

Matching at 0.8 GHz, $f_{DAC} = 5898.24\text{MSPS}$, straight mode, normalized to output power at harmonic frequency

Figure 6-39. TX HD3 vs Digital Amplitude and Output Frequency at 0.85 GHz

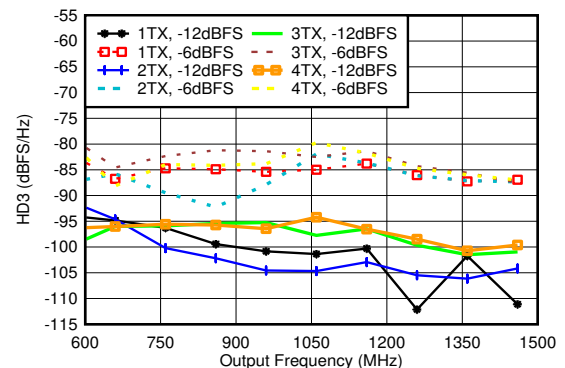

Matching at 0.8 GHz, $f_{DAC} = 8847.36\text{MSPS}$, straight mode, normalized to output power at harmonic frequency

Figure 6-40. TX HD3 vs Digital Amplitude and Output Frequency at 0.85 GHz

6.12.1 TX Typical Characteristics 800 MHz (continued)

Typical values at $T_A = +25^\circ\text{C}$ with nominal supplies. Default conditions: TX input data rate = 491.52MSPS, $f_{\text{DAC}} = 11796.48\text{MSPS}$ (24x interpolation), interleave mode, 1st Nyquist zone output, PLL clock mode with $f_{\text{REF}} = 491.52\text{ MHz}$, $A_{\text{OUT}} = -1\text{ dBFS}$, DSA = 0 dB, Sin(x)/x enabled, DSA calibrated, TX Clock Dither Enabled

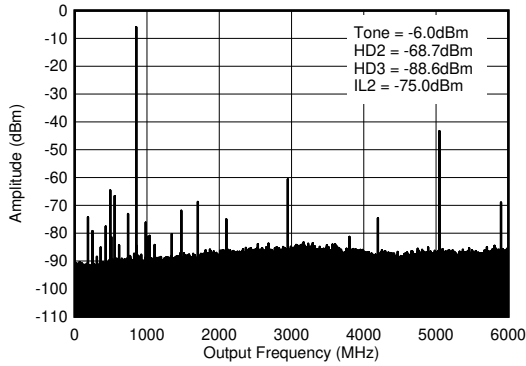

$f_{\text{DAC}} = 5898.24\text{MSPS}$, interleave mode, 0.8 GHz matching, includes PCB and cable losses. $\text{ILn} = f_{\text{S}}/\text{n} \pm f_{\text{OUT}}$.

Figure 6-41. TX Single Tone (-12 dBFS) Output Spectrum at 0.85 GHz (0- f_{DAC})

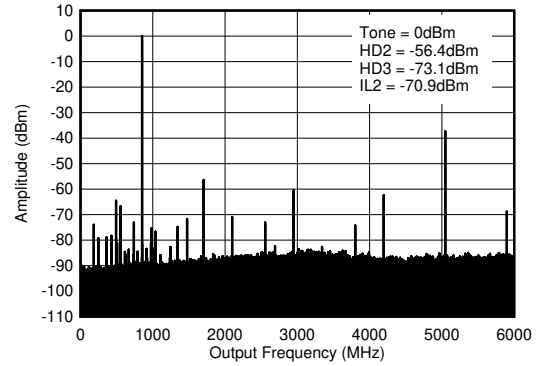

$f_{\text{DAC}} = 5898.24\text{MSPS}$, interleave mode, 0.8 GHz matching, includes PCB and cable losses. $\text{ILn} = f_{\text{S}}/\text{n} \pm f_{\text{OUT}}$.

Figure 6-42. TX Single Tone (-6 dBFS) Output Spectrum at 0.85 GHz (0- f_{DAC})

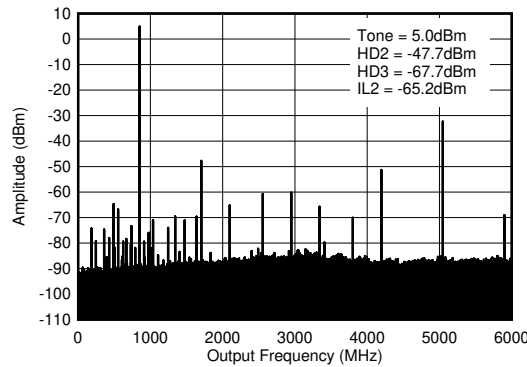

$f_{\text{DAC}} = 5898.24\text{MSPS}$, interleave mode, 0.8 GHz matching, includes PCB and cable losses. $\text{ILn} = f_{\text{S}}/\text{n} \pm f_{\text{OUT}}$.

Figure 6-43. TX Single Tone (-1 dBFS) Output Spectrum at 0.85 GHz (0- f_{DAC})

6.12.2 TX Typical Characteristics at 1.8 GHz

Typical values at $T_A = +25^\circ\text{C}$ with nominal supplies. Default conditions: TX input data rate = 491.52MSPS, $f_{\text{DAC}} = 11796.48\text{MSPS}$ (24x interpolation), interleave mode, 1st Nyquist zone output, PLL clock mode with $f_{\text{REF}} = 491.52\text{MHz}$, $A_{\text{OUT}} = -1\text{dBFS}$, DSA = 0 dB, Sin(x)/x enabled, DSA calibrated, TX Clock Dither Enabled

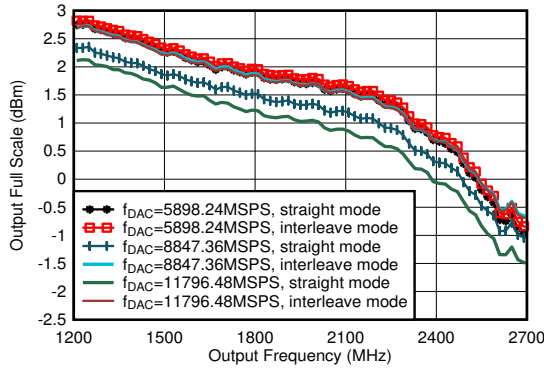

including PCB and cable losses, $A_{\text{out}} = -0.5\text{dBFS}$, DSA = 0, 1.8 GHz matching

Figure 6-44. TX Output Fullscale vs Output Frequency

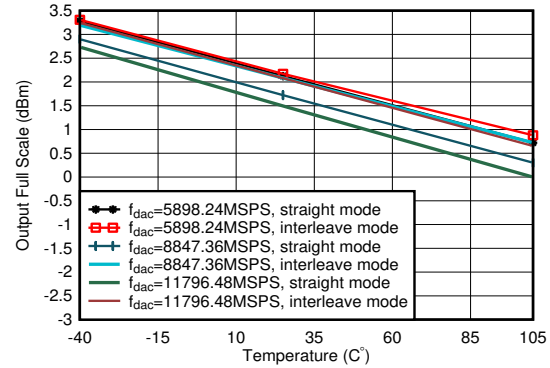

$A_{\text{out}} = -0.5\text{dBFS}$, matching 1.8 GHz

Figure 6-45. TX Output Power vs Temperature at 1.8 GHz

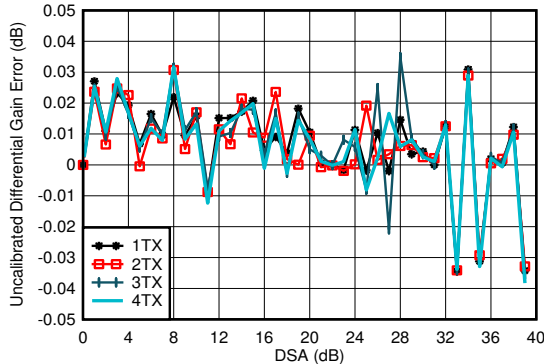

$f_{\text{DAC}} = 5898.24\text{MSPS}$, interleave mode, matching at 1.8 GHz
 Differential Gain Error = $P_{\text{OUT}}(\text{DSA Setting} - 1) - P_{\text{OUT}}(\text{DSA Setting}) + 1$

Figure 6-46. TX Uncalibrated Differential Gain Error vs DSA Setting and Channel at 1.8 GHz

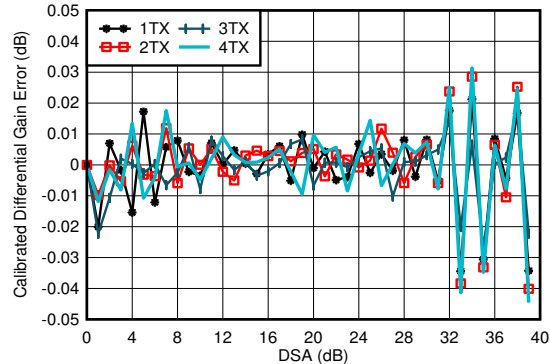

$f_{\text{DAC}} = 5898.24\text{MSPS}$, interleave mode, matching at 1.8 GHz
 Differential Gain Error = $P_{\text{OUT}}(\text{DSA Setting} - 1) - P_{\text{OUT}}(\text{DSA Setting}) + 1$

Figure 6-47. TX Calibrated Differential Gain Error vs DSA Setting and Channel at 1.8 GHz

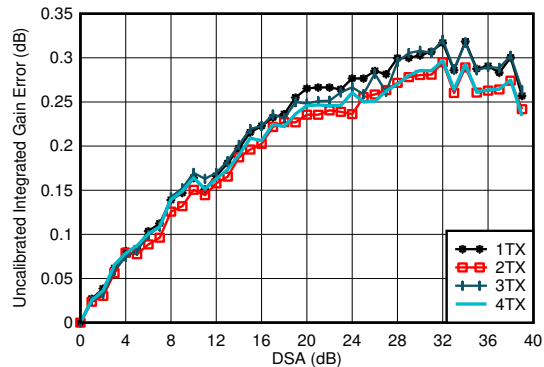

$f_{\text{DAC}} = 5898.24\text{MSPS}$, interleave mode, matching at 1.8 GHz
 Integrated Gain Error = $P_{\text{OUT}}(\text{DSA Setting}) - P_{\text{OUT}}(\text{DSA Setting} = 0) + (\text{DSA Setting})$

Figure 6-48. TX Uncalibrated Integrated Gain Error vs DSA Setting and Channel at 1.8 GHz

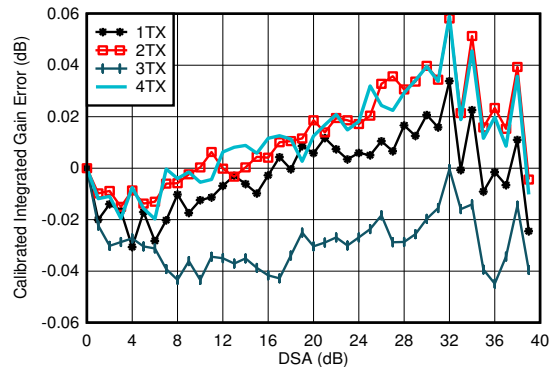

$f_{\text{DAC}} = 5898.24\text{MSPS}$, interleave mode, matching at 1.8 GHz
 Integrated Gain Error = $P_{\text{OUT}}(\text{DSA Setting}) - P_{\text{OUT}}(\text{DSA Setting} = 0) + (\text{DSA Setting})$

Figure 6-49. TX Calibrated Integrated Gain Error vs DSA Setting and Channel at 1.8 GHz

6.12.2 TX Typical Characteristics at 1.8 GHz (continued)

Typical values at $T_A = +25^\circ\text{C}$ with nominal supplies. Default conditions: TX input data rate = 491.52MSPS, $f_{\text{DAC}} = 11796.48\text{MSPS}$ (24x interpolation), interleave mode, 1st Nyquist zone output, PLL clock mode with $f_{\text{REF}} = 491.52\text{ MHz}$, $A_{\text{OUT}} = -1\text{ dBFS}$, DSA = 0 dB, Sin(x)/x enabled, DSA calibrated, TX Clock Dither Enabled

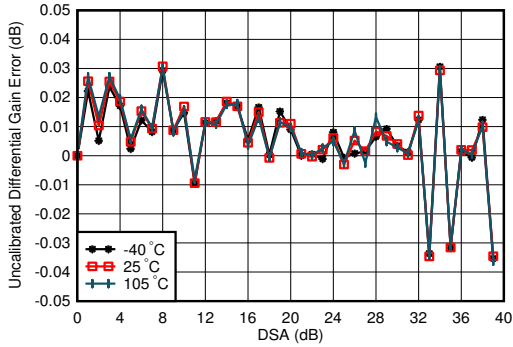

$f_{\text{DAC}} = 5898.24\text{MSPS}$, interleave mode, matching at 1.8 GHz
Differential Gain Error = $P_{\text{OUT}}(\text{DSA Setting} - 1) - P_{\text{OUT}}(\text{DSA Setting}) + 1$

Figure 6-50. TX Uncalibrated Differential Gain Error vs DSA Setting and Temperature at 1.8 GHz

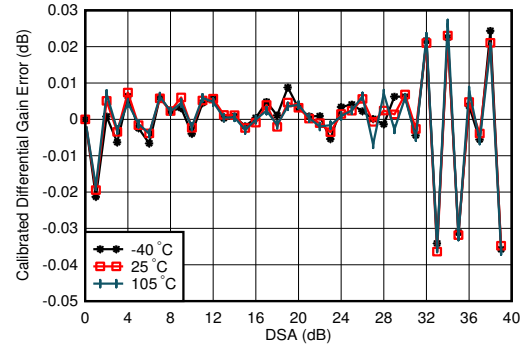

$f_{\text{DAC}} = 5898.24\text{MSPS}$, interleave mode, matching at 1.8 GHz
Differential Gain Error = $P_{\text{OUT}}(\text{DSA Setting} - 1) - P_{\text{OUT}}(\text{DSA Setting}) + 1$

Figure 6-51. TX Calibrated Differential Gain Error vs DSA Setting and Temperature at 1.8 GHz

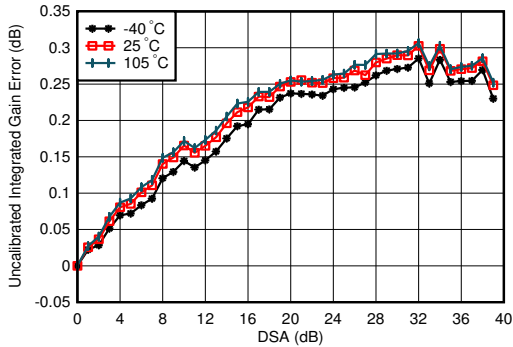

$f_{\text{DAC}} = 5898.24\text{MSPS}$, interleave mode, matching at 1.8 GHz
Integrated Gain Error = $P_{\text{OUT}}(\text{DSA Setting}) - P_{\text{OUT}}(\text{DSA Setting} = 0) + (\text{DSA Setting})$

Figure 6-52. TX Uncalibrated Integrated Gain Error vs DSA Setting and Temperature at 1.8 GHz

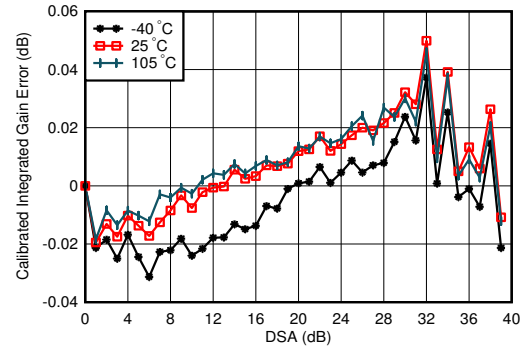

$f_{\text{DAC}} = 5898.24\text{MSPS}$, interleave mode, matching at 1.8 GHz
Integrated Gain Error = $P_{\text{OUT}}(\text{DSA Setting}) - P_{\text{OUT}}(\text{DSA Setting} = 0) + (\text{DSA Setting})$

Figure 6-53. TX Calibrated Integrated Gain Error vs DSA Setting and Temperature at 1.8 GHz

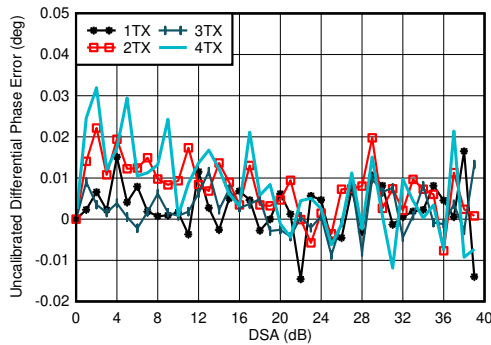

$f_{\text{DAC}} = 5898.24\text{MSPS}$, interleave mode, matching at 1.8 GHz
Differential Phase Error = $\text{Phase}_{\text{OUT}}(\text{DSA Setting} - 1) - \text{Phase}_{\text{OUT}}(\text{DSA Setting})$

Figure 6-54. TX Uncalibrated Differential Phase Error vs DSA Setting and Channel at 1.8 GHz

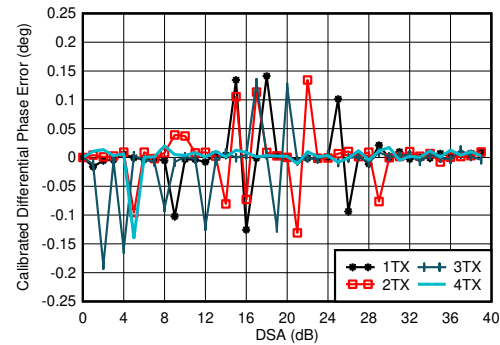

$f_{\text{DAC}} = 8847.36\text{MSPS}$, straight mode, matching at 2.6 GHz
Differential Phase Error = $\text{Phase}_{\text{OUT}}(\text{DSA Setting} - 1) - \text{Phase}_{\text{OUT}}(\text{DSA Setting})$
Phase DNL spike may occur at any DSA setting.

Figure 6-55. TX Calibrated Differential Phase Error vs DSA Setting and Channel at 1.8 GHz

6.12.2 TX Typical Characteristics at 1.8 GHz (continued)

Typical values at $T_A = +25^\circ\text{C}$ with nominal supplies. Default conditions: TX input data rate = 491.52MSPS, $f_{\text{DAC}} = 11796.48\text{MSPS}$ (24x interpolation), interleave mode, 1st Nyquist zone output, PLL clock mode with $f_{\text{REF}} = 491.52\text{ MHz}$, $A_{\text{OUT}} = -1\text{ dBFS}$, DSA = 0 dB, Sin(x)/x enabled, DSA calibrated, TX Clock Dither Enabled

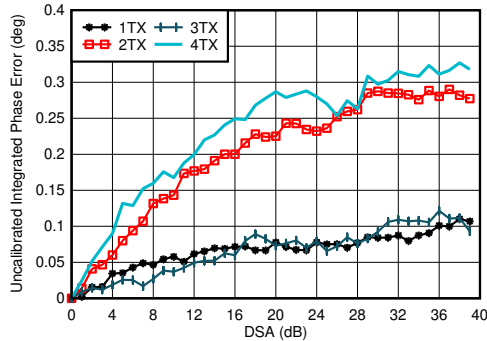

$f_{\text{DAC}} = 5898.24\text{MSPS}$, interleave mode, matching at 1.8 GHz
 Integrated Phase Error = Phase(DSA Setting) – Phase(DSA Setting = 0)

Figure 6-56. TX Uncalibrated Integrated Phase Error vs DSA Setting and Channel at 1.8 GHz

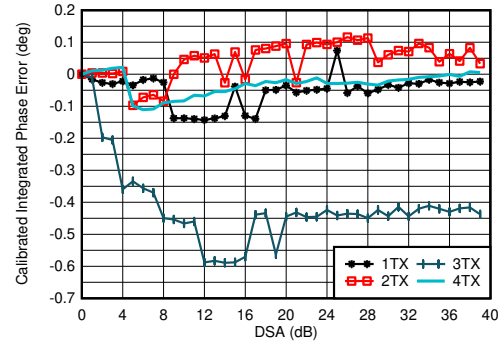

$f_{\text{DAC}} = 5898.24\text{MSPS}$, interleave mode, matching at 1.8 GHz
 Integrated Phase Error = Phase(DSA Setting) – Phase(DSA Setting = 0)

Figure 6-57. TX Calibrated Integrated Phase Error vs DSA Setting and Channel at 1.8 GHz

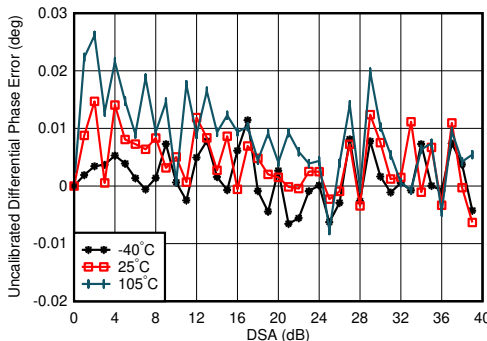

$f_{\text{DAC}} = 5898.24\text{MSPS}$, interleave mode, matching at 1.8 GHz
 Differential Phase Error = $\text{Phase}_{\text{OUT}}(\text{DSA Setting} - 1) - \text{Phase}_{\text{OUT}}(\text{DSA Setting})$

Figure 6-58. TX Uncalibrated Differential Phase Error vs DSA Setting and Temperature at 1.8 GHz

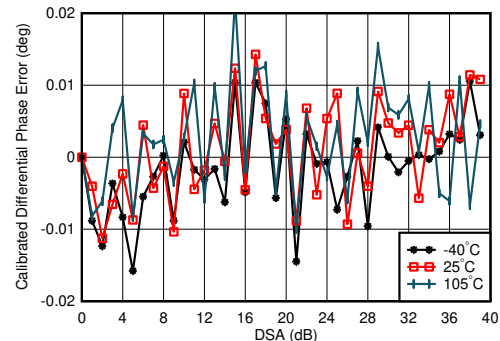

$f_{\text{DAC}} = 5898.24\text{MSPS}$, interleave mode, matching at 1.8 GHz, channel with the median variation over DSA setting at 25°C
 Differential Phase Error = $\text{Phase}_{\text{OUT}}(\text{DSA Setting} - 1) - \text{Phase}_{\text{OUT}}(\text{DSA Setting})$

Figure 6-59. TX Calibrated Differential Phase Error vs DSA Setting and Temperature at 1.8 GHz

6.12.2 TX Typical Characteristics at 1.8 GHz (continued)

Typical values at $T_A = +25^\circ\text{C}$ with nominal supplies. Default conditions: TX input data rate = 491.52MSPS, $f_{\text{DAC}} = 11796.48\text{MSPS}$ (24x interpolation), interleave mode, 1st Nyquist zone output, PLL clock mode with $f_{\text{REF}} = 491.52\text{ MHz}$, $A_{\text{OUT}} = -1\text{ dBFS}$, DSA = 0 dB, Sin(x)/x enabled, DSA calibrated, TX Clock Dither Enabled

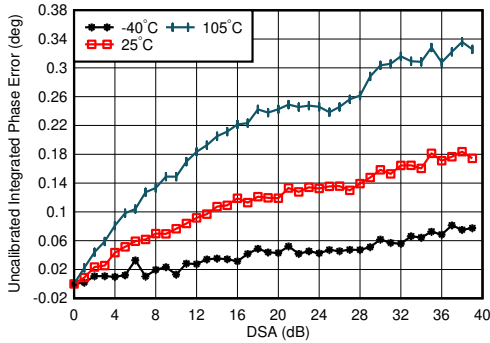

$f_{\text{DAC}} = 5898.24\text{MSPS}$, interleave mode, matching at 1.8 GHz, channel with the median variation over DSA setting at 25°C
Integrated Phase Error = Phase(DSA Setting) – Phase(DSA Setting = 0)

Figure 6-60. TX Uncalibrated Integrated Phase Error vs DSA Setting and Temperature at 1.8 GHz

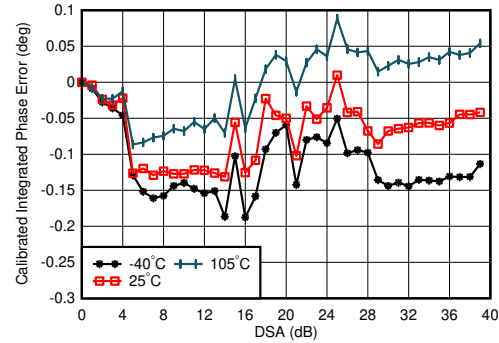

$f_{\text{DAC}} = 5898.24\text{MSPS}$, interleave mode, matching at 1.8 GHz, channel with the median variation over DSA setting at 25°C
Integrated Phase Error = Phase(DSA Setting) – Phase(DSA Setting = 0)

Figure 6-61. TX Calibrated Integrated Phase Error vs DSA Setting and Temperature at 1.8 GHz

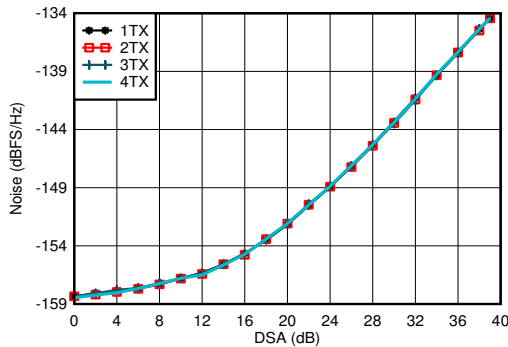

$f_{\text{DAC}} = 5898.24\text{MSPS}$, interleave mode, matching at 1.8 GHz, $P_{\text{OUT}} = -13\text{ dBFS}$

Figure 6-62. TX Output Noise vs Channel and Attenuation at 1.8 GHz

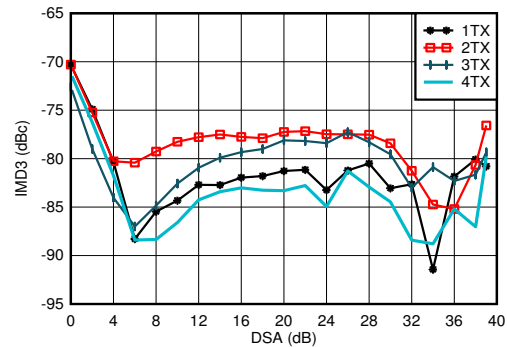

$f_{\text{DAC}} = 11796.48\text{MSPS}$, interleave mode, $f_{\text{CENTER}} = 1.8\text{ GHz}$, matching at 1.8 GHz, -13 dBFS each tone

Figure 6-63. TX IMD3 vs DSA Setting at 1.8 GHz

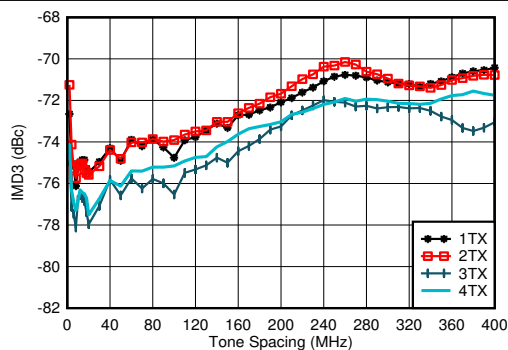

$f_{\text{DAC}} = 11796.48\text{MSPS}$, interleave mode, $f_{\text{CENTER}} = 1.8\text{ GHz}$, matching at 1.8 GHz, -13 dBFS each tone

Figure 6-64. TX IMD3 vs Tone Spacing and Channel at 1.8 GHz

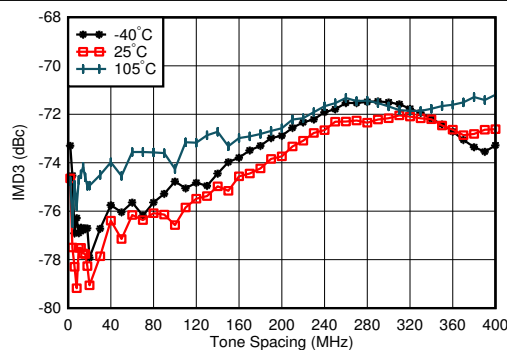

$f_{\text{DAC}} = 11796.48\text{MSPS}$, interleave mode, $f_{\text{CENTER}} = 1.8\text{ GHz}$, matching at 1.8 GHz, -13 dBFS each tone, worst channel

Figure 6-65. TX IMD3 vs Tone Spacing and Temperature at 1.8 GHz

6.12.2 TX Typical Characteristics at 1.8 GHz (continued)

Typical values at $T_A = +25^\circ\text{C}$ with nominal supplies. Default conditions: TX input data rate = 491.52MSPS, $f_{\text{DAC}} = 11796.48\text{MSPS}$ (24x interpolation), interleave mode, 1st Nyquist zone output, PLL clock mode with $f_{\text{REF}} = 491.52\text{ MHz}$, $A_{\text{OUT}} = -1\text{ dBFS}$, DSA = 0 dB, Sin(x)/x enabled, DSA calibrated, TX Clock Dither Enabled

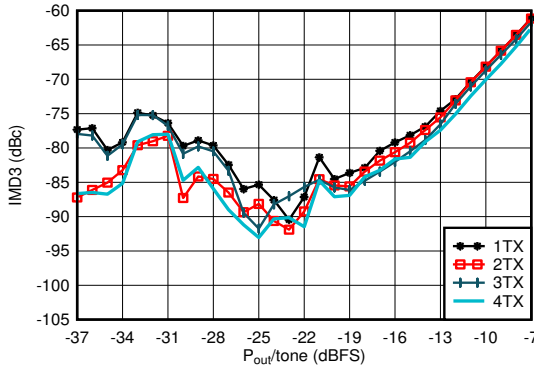

$f_{\text{DAC}} = 11796.48\text{MSPS}$, interleave mode, $f_{\text{CENTER}} = 1.8\text{ GHz}$,
 $f_{\text{SPACING}} = 20\text{ MHz}$, matching at 1.8 GHz

Figure 6-66. TX IMD3 vs Digital Level at 1.8 GHz

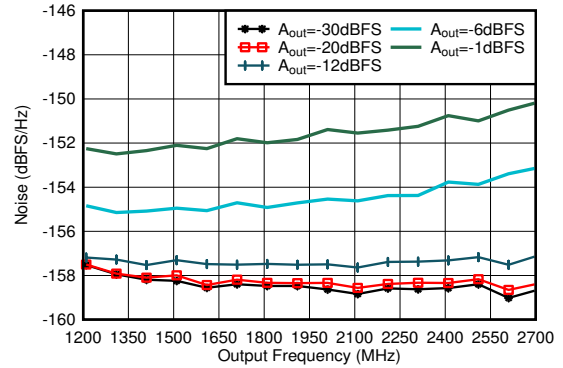

Matching at 2.6 GHz, Single tone, $f_{\text{DAC}} = 11.79648\text{GSPS}$,
 interleave mode, 40-MHz offset

Figure 6-67. TX Single Tone Output Noise vs Frequency and Amplitude at 1.8 GHz

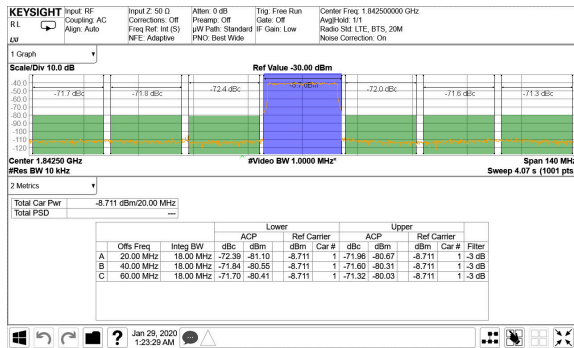

TM1.1, $P_{\text{OUT_RMS}} = -13\text{ dBFS}$

Figure 6-68. TX 20-MHz LTE Output Spectrum at 1.8425 GHz

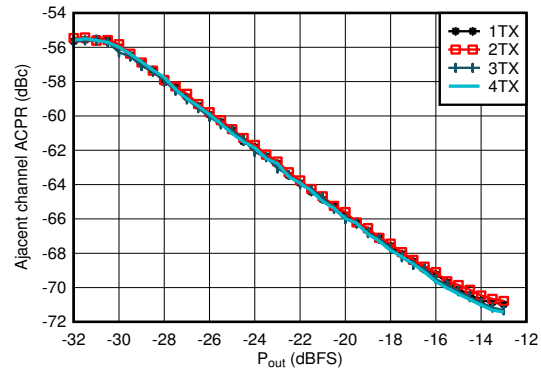

Matching at 1.8 GHz, single carrier 20-MHz BW TM1.1 LTE

Figure 6-69. TX 20-MHz LTE ACPR vs Digital Level at 1.8425 GHz

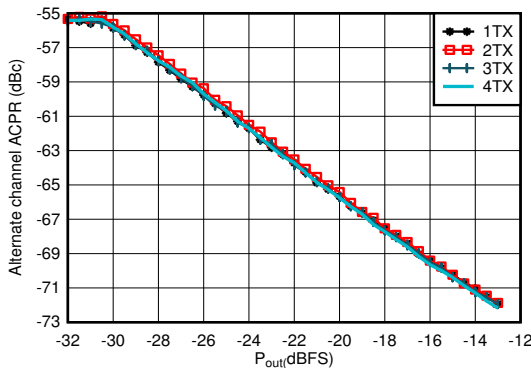

Matching at 1.8 GHz, single carrier 20-MHz BW TM1.1 LTE

Figure 6-70. TX 20-MHz LTE alt-ACPR vs Digital Level at 1.8425 GHz

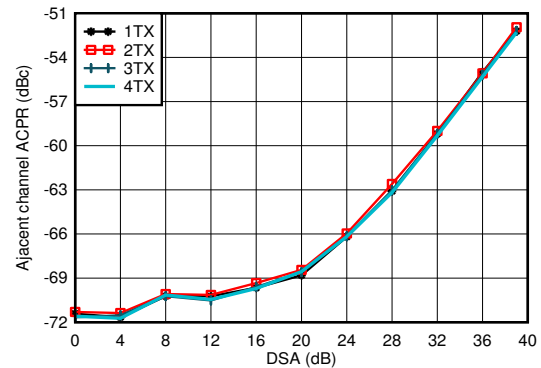

Matching at 1.8 GHz, single carrier 20-MHz BW TM1.1 LTE

Figure 6-71. TX 20-MHz LTE ACPR vs DSA at 1.8 GHz

6.12.2 TX Typical Characteristics at 1.8 GHz (continued)

Typical values at $T_A = +25^\circ\text{C}$ with nominal supplies. Default conditions: TX input data rate = 491.52MSPS, $f_{\text{DAC}} = 11796.48\text{MSPS}$ (24x interpolation), interleave mode, 1st Nyquist zone output, PLL clock mode with $f_{\text{REF}} = 491.52\text{ MHz}$, $A_{\text{OUT}} = -1\text{ dBFS}$, DSA = 0 dB, Sin(x)/x enabled, DSA calibrated, TX Clock Dither Enabled

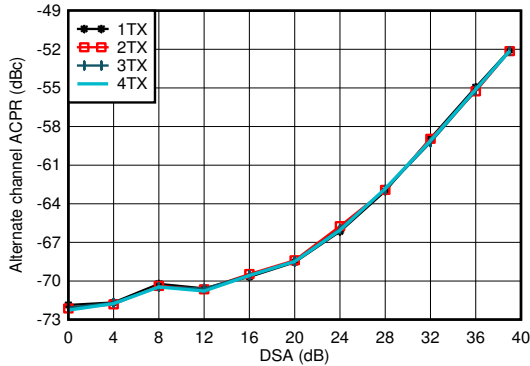

Matching at 1.8 GHz, single carrier 20-MHz BW TM1.1 LTE

Figure 6-72. TX 20-MHz LTE alt-ACPR vs DSA at 1.8 GHz

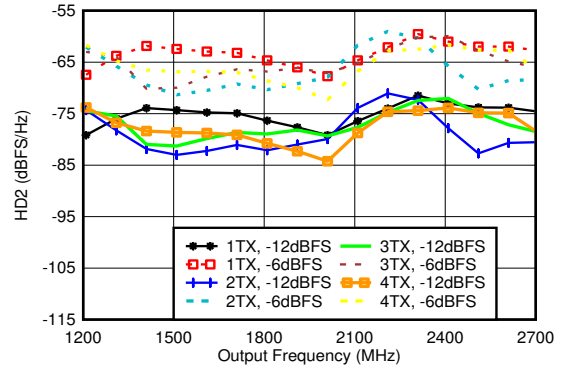

Matching at 1.8 GHz, $f_{\text{DAC}} = 11.79648\text{GSPS}$, interleave mode, normalized to output power at harmonic frequency

Figure 6-73. TX HD2 vs Digital Amplitude and Output Frequency at 1.8 GHz

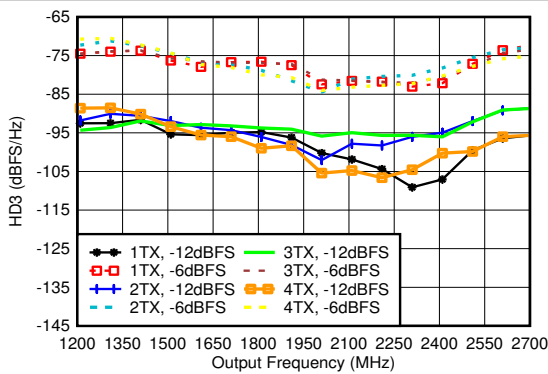

Matching at 1.8 GHz, $f_{\text{DAC}} = 11.79648\text{GSPS}$, interleave mode, normalized to output power at harmonic frequency

Figure 6-74. TX HD3 vs Digital Amplitude and Output Frequency at 1.8 GHz

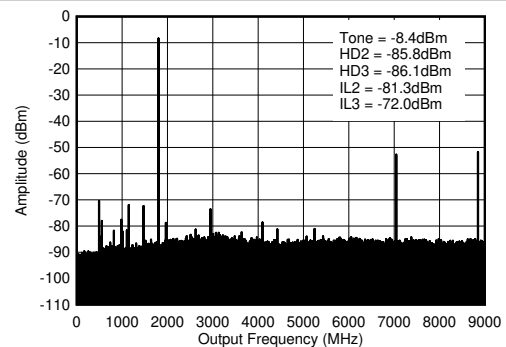

$f_{\text{DAC}} = 8847.36\text{MSPS}$, straight mode, 1.8 GHz matching, includes PCB and cable losses. $\text{IL}_n = f_s/n \pm f_{\text{OUT}}$ and is due to mixing with digital clocks.

Figure 6-75. TX Single Tone (-12 dBFS) Output Spectrum at 1.8 GHz ($0-f_{\text{DAC}}$)

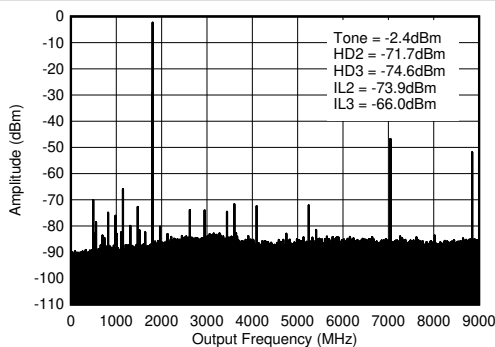

$f_{\text{DAC}} = 8847.36\text{MSPS}$, straight mode, 1.8 GHz matching, includes PCB and cable losses. $\text{IL}_n = f_s/n \pm f_{\text{OUT}}$ and is due to mixing with digital clocks.

Figure 6-76. TX Single Tone (-6 dBFS) Output Spectrum at 1.8 GHz ($0-f_{\text{DAC}}$)

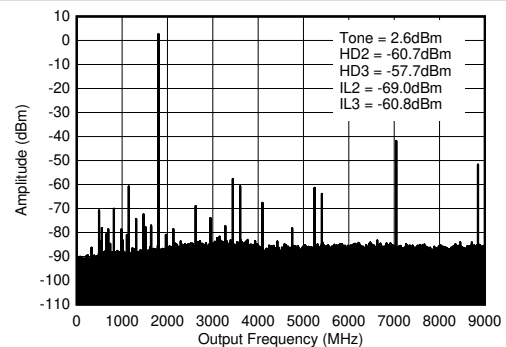

$f_{\text{DAC}} = 8847.36\text{MSPS}$, straight mode, 1.8 GHz matching, includes PCB and cable losses. $\text{IL}_n = f_s/n \pm f_{\text{OUT}}$ and is due to mixing with digital clocks.

Figure 6-77. TX Single Tone (-1 dBFS) Output Spectrum at 1.8 GHz ($0-f_{\text{DAC}}$)

6.12.3 TX Typical Characteristics at 2.6 GHz

Typical values at $T_A = +25^\circ\text{C}$ with nominal supplies. Default conditions: TX input data rate = 491.52MSPS, $f_{\text{DAC}} = 11796.48\text{MSPS}$ (24x interpolation), interleave mode, 1st Nyquist zone output, PLL clock mode with $f_{\text{REF}} = 491.52\text{ MHz}$, $A_{\text{OUT}} = -1\text{ dBFS}$, DSA = 0 dB, Sin(x)/x enabled, DSA calibrated, TX Clock Dither Enabled

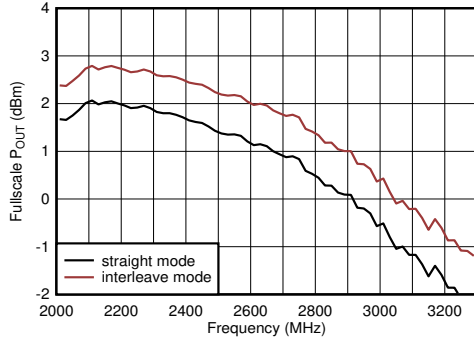

Including PCB and cable losses, $A_{\text{out}} = -0.5\text{dBFS}$, DSA = 0, 2.6 GHz matching

Figure 6-78. TX Full Scale vs RF Frequency at 11796.48MSPS

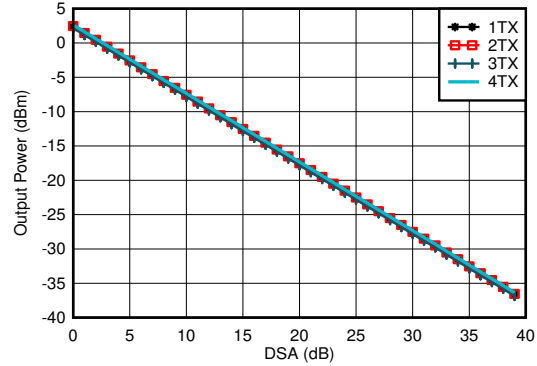

$f_{\text{DAC}} = 8847.36\text{ MSPS}$, $A_{\text{out}} = -0.5\text{dBFS}$, matching 2.6 GHz

Figure 6-79. TX Output Power vs DSA Setting and Channel at 2.6 GHz

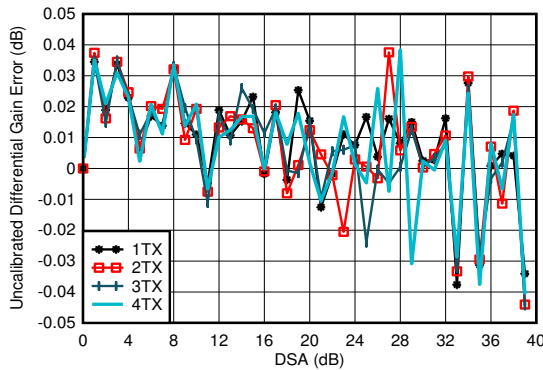

$f_{\text{DAC}}=8847.36\text{MSPS}$, straight mode, matching at 2.6 GHz
Differential Gain Error = $P_{\text{OUT}}(\text{DSA Setting} - 1) - P_{\text{OUT}}(\text{DSA Setting}) + 1$

Figure 6-80. TX Uncalibrated Differential Gain Error vs DSA Setting and Channel at 2.6 GHz

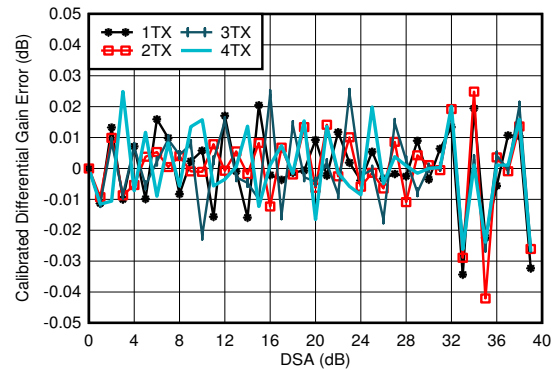

$f_{\text{DAC}}=8847.36\text{MSPS}$, straight mode, matching at 2.6 GHz
Differential Gain Error = $P_{\text{OUT}}(\text{DSA Setting} - 1) - P_{\text{OUT}}(\text{DSA Setting}) + 1$

Figure 6-81. TX Calibrated Differential Gain Error vs DSA Setting and Channel at 2.6 GHz

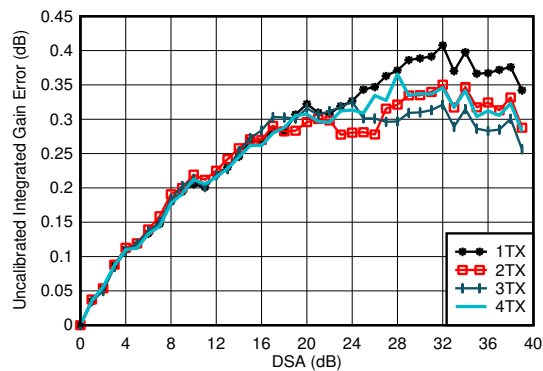

$f_{\text{DAC}}=8847.36\text{MSPS}$, straight mode, matching at 2.6 GHz
Integrated Gain Error = $P_{\text{OUT}}(\text{DSA Setting}) - P_{\text{OUT}}(\text{DSA Setting} = 0) + (\text{DSA Setting})$

Figure 6-82. TX Uncalibrated Integrated Gain Error vs DSA Setting and Channel at 2.6 GHz

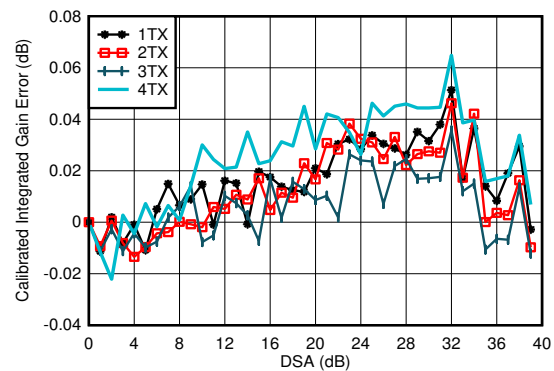

$f_{\text{DAC}} = 8847.36\text{MSPS}$, straight mode, matching at 2.6 GHz
Integrated Gain Error = $P_{\text{OUT}}(\text{DSA Setting}) - P_{\text{OUT}}(\text{DSA Setting} = 0) + (\text{DSA Setting})$

Figure 6-83. TX Calibrated Integrated Gain Error vs DSA Setting and Channel at 2.6 GHz

6.12.3 TX Typical Characteristics at 2.6 GHz (continued)

Typical values at $T_A = +25^\circ\text{C}$ with nominal supplies. Default conditions: TX input data rate = 491.52MSPS, $f_{\text{DAC}} = 11796.48\text{MSPS}$ (24x interpolation), interleave mode, 1st Nyquist zone output, PLL clock mode with $f_{\text{REF}} = 491.52\text{ MHz}$, $A_{\text{OUT}} = -1\text{ dBFS}$, DSA = 0 dB, Sin(x)/x enabled, DSA calibrated, TX Clock Dither Enabled

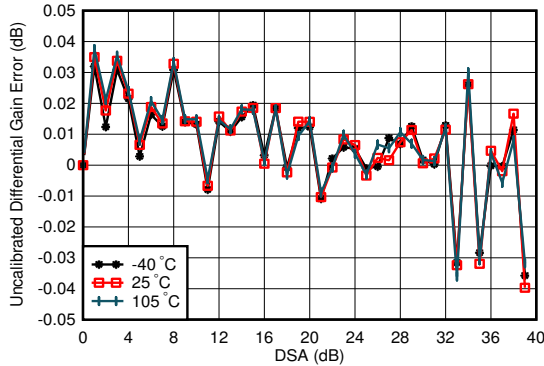

$f_{\text{DAC}} = 8847.36\text{MSPS}$, straight mode, matching at 2.6 GHz, channel with the median variation over DSA setting at 25°C
 Differential Gain Error = $P_{\text{OUT}}(\text{DSA Setting} - 1) - P_{\text{OUT}}(\text{DSA Setting}) + 1$

Figure 6-84. TX Uncalibrated Differential Gain Error vs DSA Setting and Temperature at 2.6 GHz

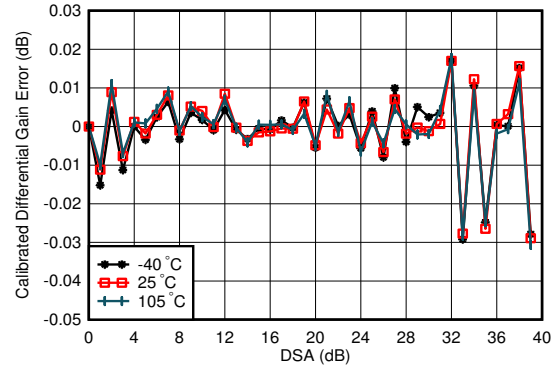

$f_{\text{DAC}} = 8847.36\text{MSPS}$, straight mode, matching at 2.6 GHz, channel with the median variation over DSA setting at 25°C
 Differential Gain Error = $P_{\text{OUT}}(\text{DSA Setting} - 1) - P_{\text{OUT}}(\text{DSA Setting}) + 1$

Figure 6-85. TX Calibrated Differential Gain Error vs DSA Setting and Temperature at 2.6 GHz

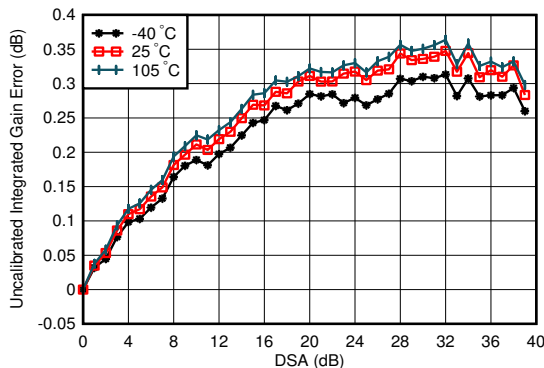

$f_{\text{DAC}} = 8847.36\text{MSPS}$, straight mode, matching at 2.6 GHz, channel with the median variation over DSA setting at 25°C
 Integrated Gain Error = $P_{\text{OUT}}(\text{DSA Setting}) - P_{\text{OUT}}(\text{DSA Setting} = 0) + (\text{DSA Setting})$

Figure 6-86. TX Uncalibrated Integrated Gain Error vs DSA Setting and Temperature at 2.6 GHz

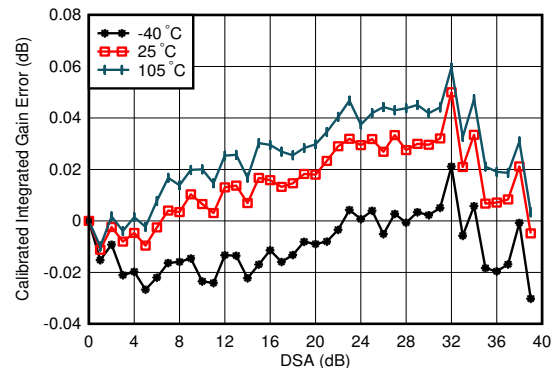

$f_{\text{DAC}} = 8847.36\text{MSPS}$, straight mode, matching at 2.6 GHz, channel with the median variation over DSA setting at 25°C
 Integrated Gain Error = $P_{\text{OUT}}(\text{DSA Setting}) - P_{\text{OUT}}(\text{DSA Setting} = 0) + (\text{DSA Setting})$

Figure 6-87. TX Calibrated Integrated Gain Error vs DSA Setting and Temperature at 2.6 GHz

6.12.3 TX Typical Characteristics at 2.6 GHz (continued)

Typical values at $T_A = +25^\circ\text{C}$ with nominal supplies. Default conditions: TX input data rate = 491.52MSPS, $f_{\text{DAC}} = 11796.48\text{MSPS}$ (24x interpolation), interleave mode, 1st Nyquist zone output, PLL clock mode with $f_{\text{REF}} = 491.52\text{ MHz}$, $A_{\text{OUT}} = -1\text{ dBFS}$, DSA = 0 dB, Sin(x)/x enabled, DSA calibrated, TX Clock Dither Enabled

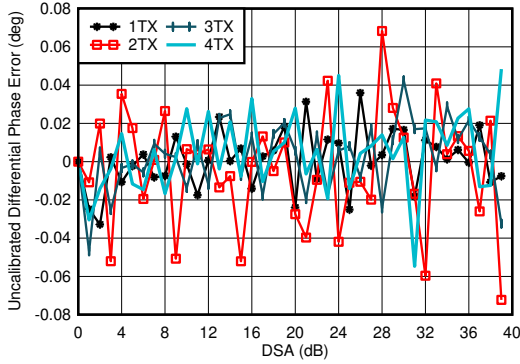

$f_{\text{DAC}} = 8847.36\text{MSPS}$, straight mode, matching at 2.6 GHz
 Differential Phase Error = $\text{Phase}_{\text{OUT}}(\text{DSA Setting} - 1) - \text{Phase}_{\text{OUT}}(\text{DSA Setting})$

Figure 6-88. TX Uncalibrated Differential Phase Error vs DSA Setting and Channel at 2.6 GHz

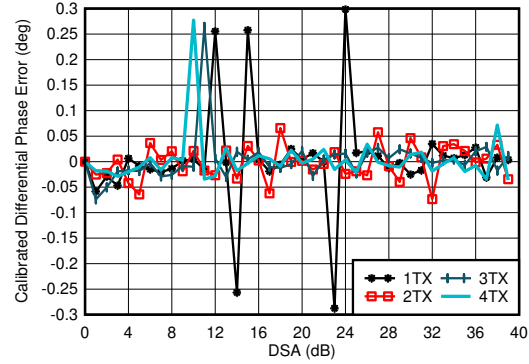

$f_{\text{DAC}} = 8847.36\text{MSPS}$, straight mode, matching at 2.6 GHz
 Differential Phase Error = $\text{Phase}_{\text{OUT}}(\text{DSA Setting} - 1) - \text{Phase}_{\text{OUT}}(\text{DSA Setting})$
 Phase DNL spike may occur at any DSA setting.

Figure 6-89. TX Calibrated Differential Phase Error vs DSA Setting and Channel at 2.6 GHz

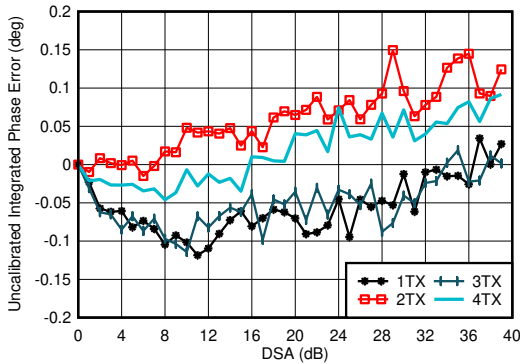

$f_{\text{DAC}} = 8847.36\text{MSPS}$, straight mode, matching at 2.6 GHz
 Integrated Phase Error = $\text{Phase}(\text{DSA Setting}) - \text{Phase}(\text{DSA Setting} = 0)$

Figure 6-90. TX Uncalibrated Integrated Phase Error vs DSA Setting and Channel at 2.6 GHz

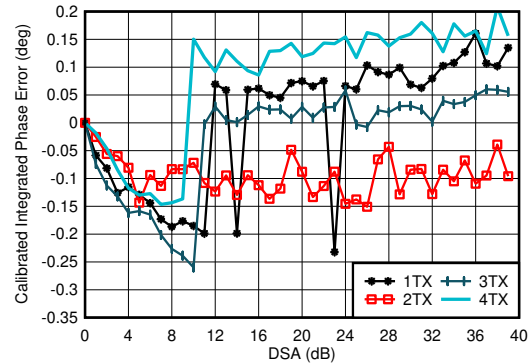

$f_{\text{DAC}} = 8847.36\text{MSPS}$, straight mode, matching at 2.6 GHz
 Integrated Phase Error = $\text{Phase}(\text{DSA Setting}) - \text{Phase}(\text{DSA Setting} = 0)$

Figure 6-91. TX Calibrated Integrated Phase Error vs DSA Setting and Channel at 2.6 GHz

6.12.3 TX Typical Characteristics at 2.6 GHz (continued)

Typical values at $T_A = +25^\circ\text{C}$ with nominal supplies. Default conditions: TX input data rate = 491.52MSPS, $f_{\text{DAC}} = 11796.48\text{MSPS}$ (24x interpolation), interleave mode, 1st Nyquist zone output, PLL clock mode with $f_{\text{REF}} = 491.52\text{ MHz}$, $A_{\text{OUT}} = -1\text{ dBFS}$, DSA = 0 dB, Sin(x)/x enabled, DSA calibrated, TX Clock Dither Enabled

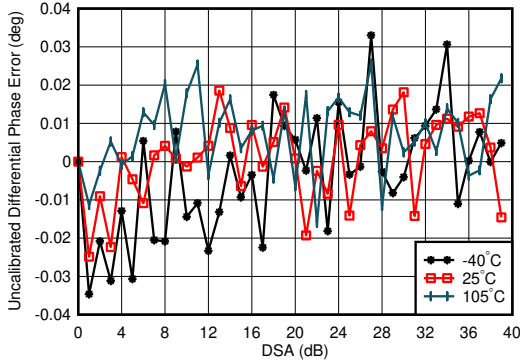

$f_{\text{DAC}} = 8847.36\text{MSPS}$, straight mode, matching at 2.6 GHz, channel with the median variation over DSA setting at 25°C
 Differential Phase Error = $\text{Phase}_{\text{OUT}}(\text{DSA Setting} - 1) - \text{Phase}_{\text{OUT}}(\text{DSA Setting})$

Figure 6-92. TX Uncalibrated Differential Phase Error vs DSA Setting and Temperature at 2.6 GHz

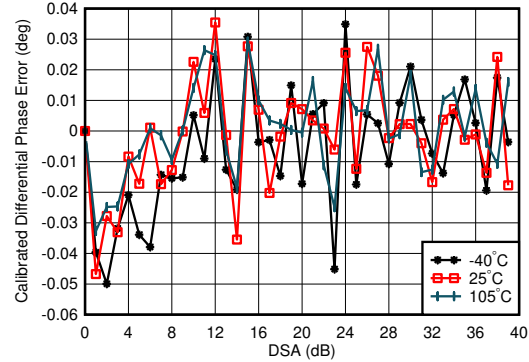

$f_{\text{DAC}} = 8847.36\text{MSPS}$, straight mode, matching at 2.6 GHz, channel with the median variation over DSA setting at 25°C
 Differential Phase Error = $\text{Phase}_{\text{OUT}}(\text{DSA Setting} - 1) - \text{Phase}_{\text{OUT}}(\text{DSA Setting})$

Figure 6-93. TX Calibrated Differential Phase Error vs DSA Setting and Temperature at 2.6 GHz

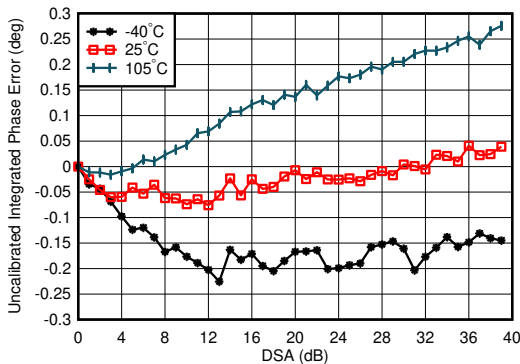

$f_{\text{DAC}} = 8847.36\text{MSPS}$, straight mode, matching at 2.6 GHz, channel with the medium variation over DSA setting at 25°C
 Integrated Phase Error = $\text{Phase}(\text{DSA Setting}) - \text{Phase}(\text{DSA Setting} = 0)$

Figure 6-94. TX Uncalibrated Integrated Phase Error vs DSA Setting and Temperature at 2.6 GHz

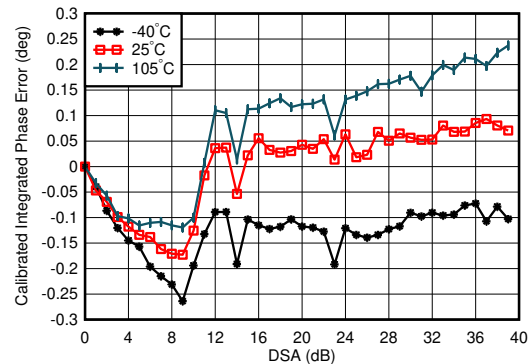

$f_{\text{DAC}} = 8847.36\text{MSPS}$, straight mode, matching at 2.6 GHz, channel with the median variation over DSA setting at 25°C
 Integrated Phase Error = $\text{Phase}(\text{DSA Setting}) - \text{Phase}(\text{DSA Setting} = 0)$

Figure 6-95. TX Calibrated Integrated Phase Error vs DSA Setting and Temperature at 2.6 GHz

6.12.3 TX Typical Characteristics at 2.6 GHz (continued)

Typical values at $T_A = +25^\circ\text{C}$ with nominal supplies. Default conditions: TX input data rate = 491.52MSPS, $f_{\text{DAC}} = 11796.48\text{MSPS}$ (24x interpolation), interleave mode, 1st Nyquist zone output, PLL clock mode with $f_{\text{REF}} = 491.52\text{ MHz}$, $A_{\text{OUT}} = -1\text{ dBFS}$, DSA = 0 dB, Sin(x)/x enabled, DSA calibrated, TX Clock Dither Enabled

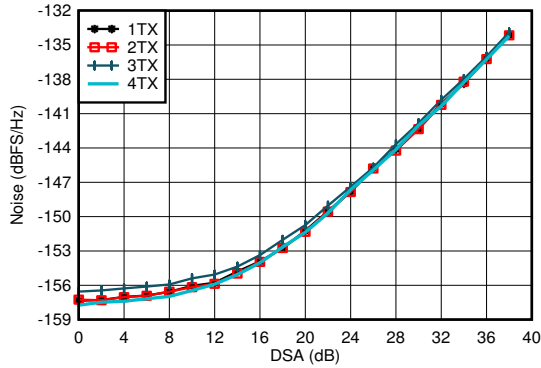

$f_{\text{DAC}} = 8847.36\text{MSPS}$, straight mode, matching at 2.6 GHz, $P_{\text{OUT}} = -13\text{ dBFS}$

Figure 6-96. TX Output Noise vs Channel and Attenuation at 2.6 GHz

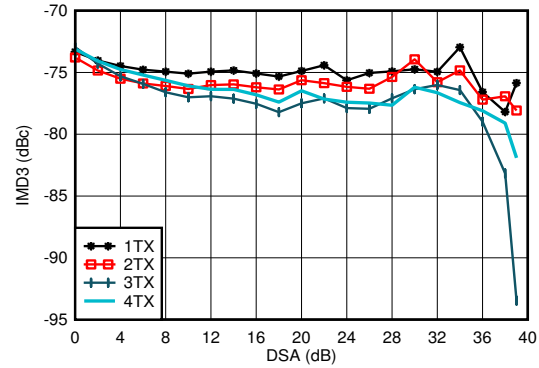

$f_{\text{DAC}} = 8847.36\text{MSPS}$, straight mode, $f_{\text{CENTER}} = 2.6\text{ GHz}$, matching at 2.6 GHz, -13 dBFS each tone

Figure 6-97. TX IMD3 vs DSA Setting at 2.6 GHz

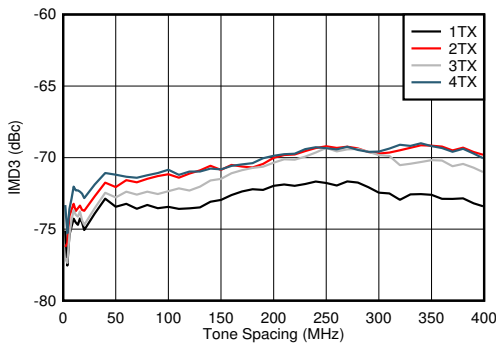

$f_{\text{DAC}} = 8847.36\text{MSPS}$, straight mode, $f_{\text{CENTER}} = 2.6\text{ GHz}$, matching at 2.6 GHz, -13 dBFS each tone

Figure 6-98. TX IMD3 vs Tone Spacing and Channel at 2.6 GHz

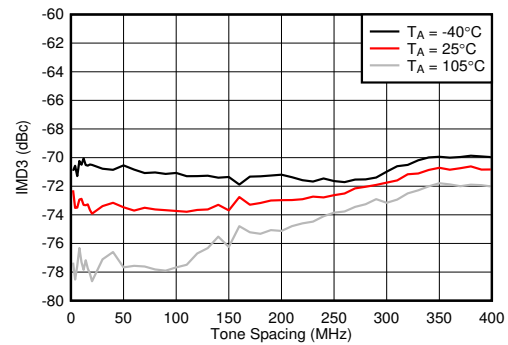

$f_{\text{DAC}} = 8847.36\text{MSPS}$, straight mode, $f_{\text{CENTER}} = 2.6\text{ GHz}$, matching at 2.6 GHz, -13 dBFS each tone, worst channel.

Figure 6-99. TX IMD3 vs Tone Spacing and Temperature at 2.6 GHz

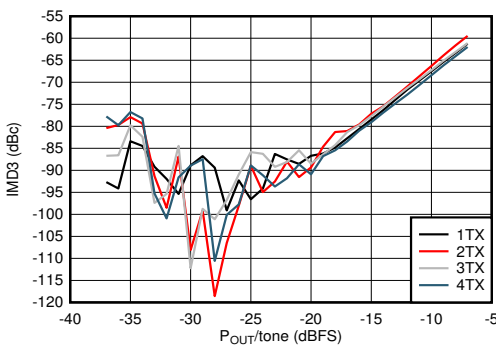

$f_{\text{DAC}} = 8847.36\text{MSPS}$, straight mode, $f_{\text{CENTER}} = 2.6\text{ GHz}$, $f_{\text{SPACING}} = 20\text{ MHz}$, matching at 2.6 GHz

Figure 6-100. TX IMD3 vs Digital Level at 2.6 GHz

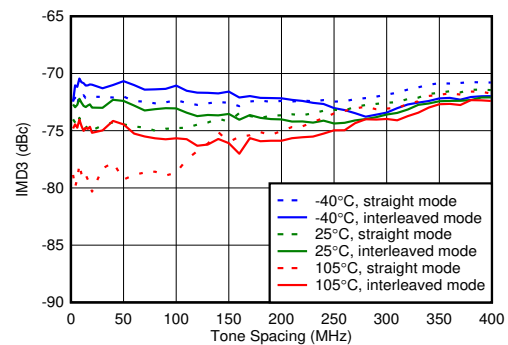

$f_{\text{DAC}} = 8847.36\text{MSPS}$, straight mode, $f_{\text{CENTER}} = 2.6\text{ GHz}$, matching at 2.6 GHz, -13 dBFS each tone

Figure 6-101. TX IMD3 vs Tone Spacing and Temperature

6.12.3 TX Typical Characteristics at 2.6 GHz (continued)

Typical values at $T_A = +25^\circ\text{C}$ with nominal supplies. Default conditions: TX input data rate = 491.52MSPS, $f_{\text{DAC}} = 11796.48\text{MSPS}$ (24x interpolation), interleave mode, 1st Nyquist zone output, PLL clock mode with $f_{\text{REF}} = 491.52\text{ MHz}$, $A_{\text{OUT}} = -1\text{ dBFS}$, DSA = 0 dB, Sin(x)/x enabled, DSA calibrated, TX Clock Dither Enabled

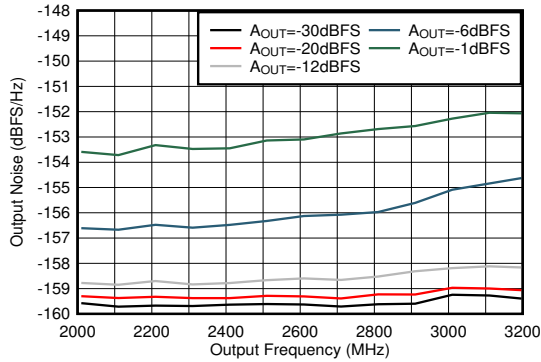

Matching at 2.6 GHz, Single tone, $f_{\text{DAC}} = 11.79648\text{GSPS}$, interleave mode, 40-MHz offset

Figure 6-102. TX Single Tone Output Noise vs Frequency and Amplitude at 2.6 GHz

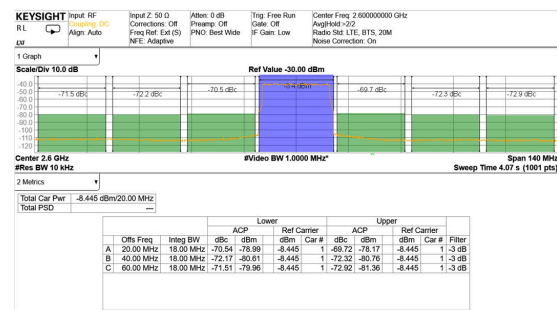

TM1.1, $P_{\text{OUT_RMS}} = -13\text{ dBFS}$

Figure 6-103. TX 20-MHz LTE Output Spectrum at 2.6 GHz (Band 41)

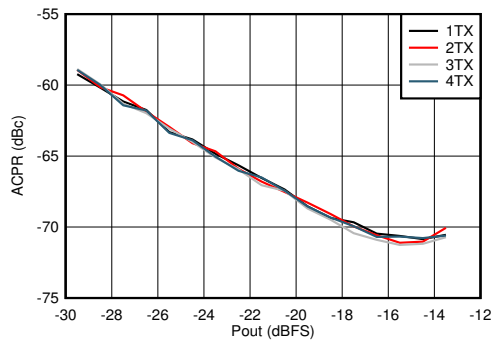

Matching at 2.6 GHz, single carrier 20-MHz BW TM1.1 LTE

Figure 6-104. TX 20-MHz LTE ACPR vs Digital Level at 2.6 GHz

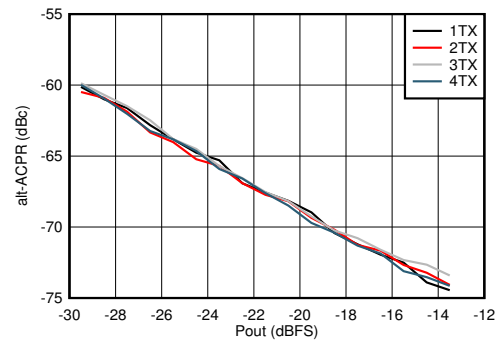

Matching at 2.6 GHz, single carrier 20-MHz BW TM1.1 LTE

Figure 6-105. TX 20-MHz LTE alt-ACPR vs Digital Level at 2.6 GHz

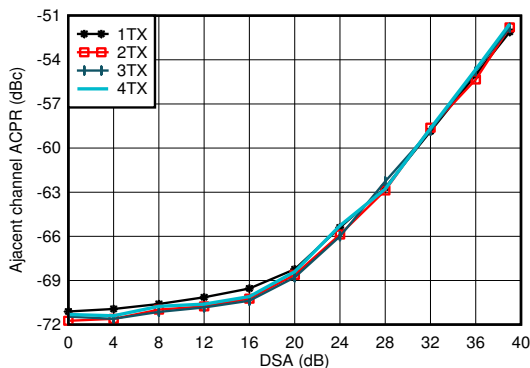

Matching at 2.6 GHz, single carrier 20-MHz BW TM1.1 LTE

Figure 6-106. TX 20-MHz LTE ACPR vs DSA at 2.6 GHz

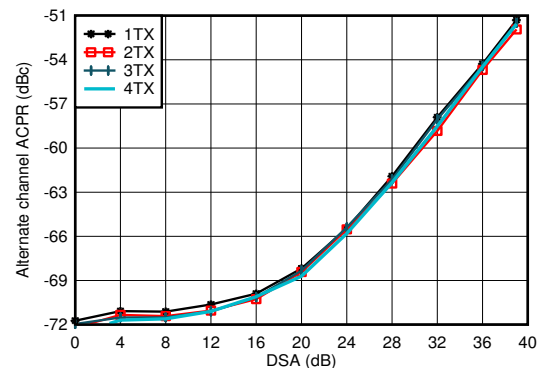

Matching at 2.6 GHz, single carrier 20-MHz BW TM1.1 LTE

Figure 6-107. TX 20-MHz LTE alt-ACPR vs DSA at 2.6 GHz

6.12.3 TX Typical Characteristics at 2.6 GHz (continued)

Typical values at $T_A = +25^\circ\text{C}$ with nominal supplies. Default conditions: TX input data rate = 491.52MSPS, $f_{DAC} = 11796.48\text{MSPS}$ (24x interpolation), interleave mode, 1st Nyquist zone output, PLL clock mode with $f_{REF} = 491.52\text{ MHz}$, $A_{OUT} = -1\text{ dBFS}$, DSA = 0 dB, Sin(x)/x enabled, DSA calibrated, TX Clock Dither Enabled

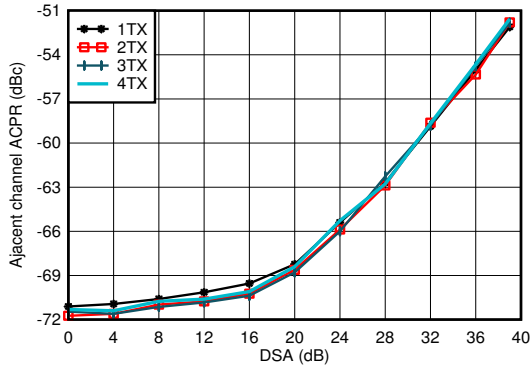

Matching at 2.6 GHz, single carrier 20-MHz BW TM1.1 LTE
Figure 6-108. TX 20-MHz LTE ACPR vs DSA at 2.6 GHz

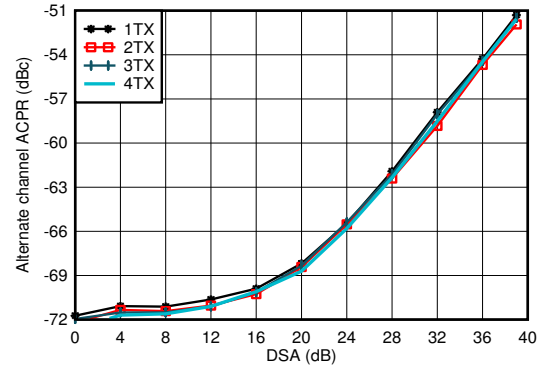

Matching at 2.6 GHz, single carrier 20-MHz BW TM1.1 LTE
Figure 6-109. TX 20-MHz LTE alt-ACPR vs DSA at 2.6 GHz

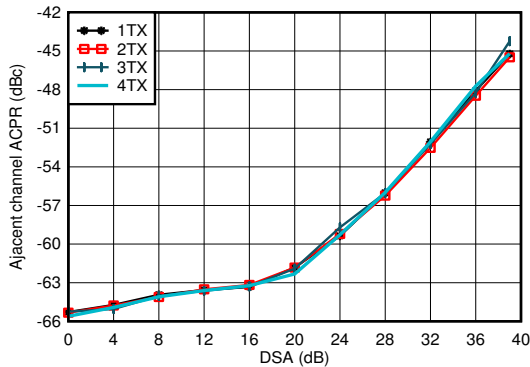

Matching at 2.6 GHz, single carrier 100-MHz BW TM1.1 NR
Figure 6-110. TX 100-MHz NR ACPR vs DSA at 2.6 GHz

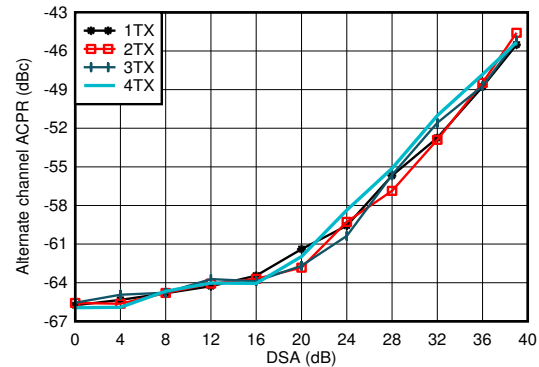

Matching at 2.6 GHz, single carrier 100-MHz BW TM1.1 NR
Figure 6-111. TX 100-MHz NR alt-ACPR vs DSA at 2.6 GHz

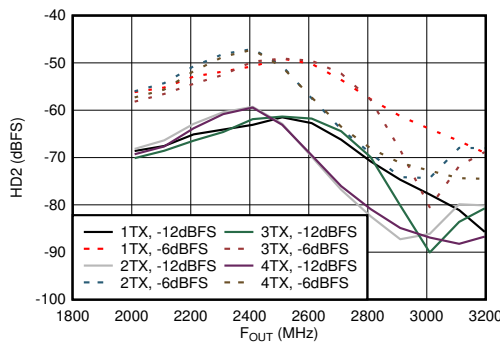

Matching at 2.6 GHz, $f_{DAC} = 11.79648\text{GSPS}$, interleave mode, normalized to output power at harmonic frequency
Figure 6-112. TX HD2 vs Digital Amplitude and Output Frequency at 2.6 GHz

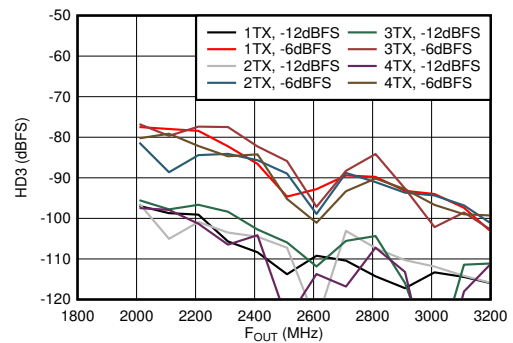

Matching at 2.6 GHz, $f_{DAC} = 11.79648\text{GSPS}$, interleave mode, normalized to output power at harmonic frequency
Figure 6-113. TX HD3 vs Digital Amplitude and Output Frequency at 2.6 GHz

6.12.3 TX Typical Characteristics at 2.6 GHz (continued)

Typical values at $T_A = +25^\circ\text{C}$ with nominal supplies. Default conditions: TX input data rate = 491.52MSPS, $f_{\text{DAC}} = 11796.48\text{MSPS}$ (24x interpolation), interleave mode, 1st Nyquist zone output, PLL clock mode with $f_{\text{REF}} = 491.52\text{ MHz}$, $A_{\text{OUT}} = -1\text{ dBFS}$, DSA = 0 dB, Sin(x)/x enabled, DSA calibrated, TX Clock Dither Enabled

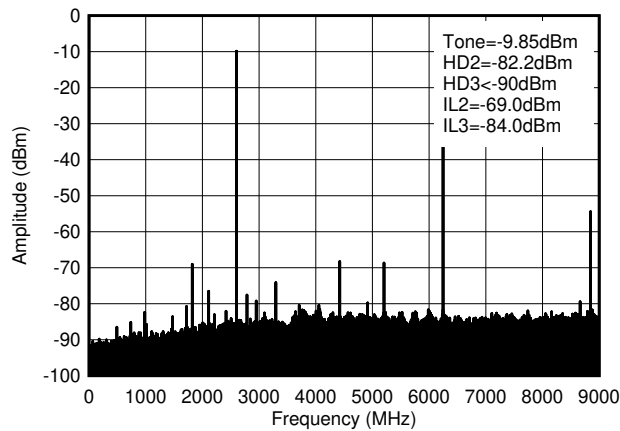

$f_{\text{DAC}} = 8847.36\text{MSPS}$, straight mode, 2.6 GHz matching, includes PCB and cable losses. $\text{IL}_n = f_s/n \pm f_{\text{OUT}}$ and is due to mixing with digital clocks.

Figure 6-114. TX Single Tone (-12 dBFS) Output Spectrum at 2.6 GHz ($0-f_{\text{DAC}}$)

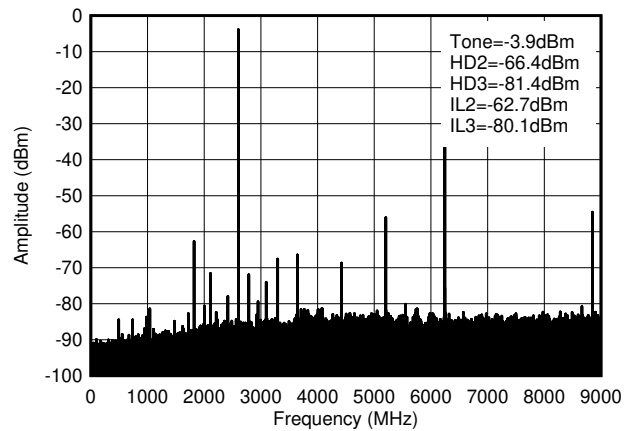

$f_{\text{DAC}} = 8847.36\text{MSPS}$, straight mode, 2.6 GHz matching, includes PCB and cable losses. $\text{IL}_n = f_s/n \pm f_{\text{OUT}}$ and is due to mixing with digital clocks.

Figure 6-115. TX Single Tone (-6 dBFS) Output Spectrum at 2.6 GHz ($0-f_{\text{DAC}}$)

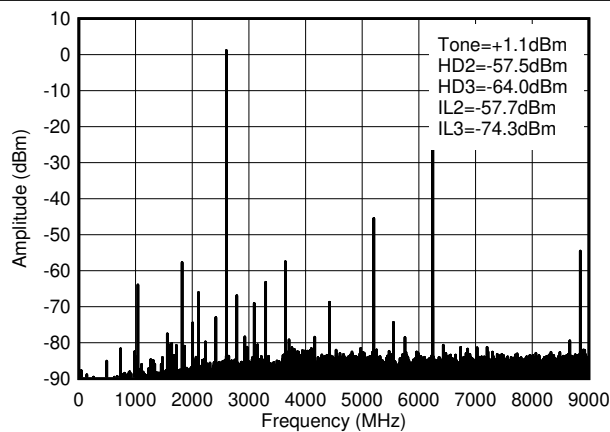

$f_{\text{DAC}} = 8847.36\text{MSPS}$, straight mode, 2.6 GHz matching, includes PCB and cable losses. $\text{IL}_n = f_s/n \pm f_{\text{OUT}}$ and is due to mixing with digital clocks.

Figure 6-116. TX Single Tone (-1 dBFS) Output Spectrum at 2.6 GHz ($0-f_{\text{DAC}}$)

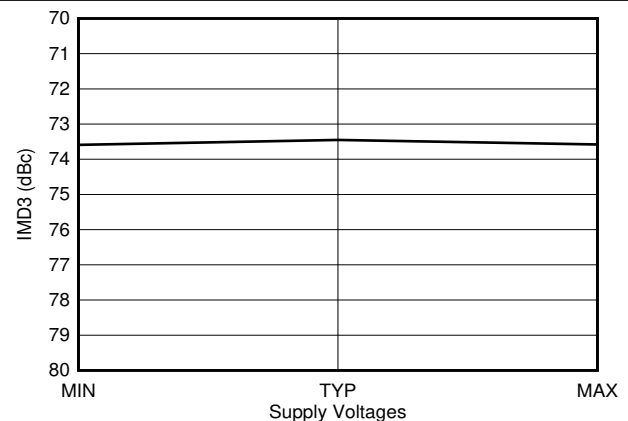

$f_{\text{DAC}} = 11796.48\text{MSPS}$, interleave mode, 2.6 GHz matching. 40-MHz offset from tone. Output Power = -13 dBFS. All supplies simultaneously at MIN, TYP, or MAX voltages.

Figure 6-117. TX IMD3 vs Supply Voltage at 2.6 GHz

6.12.4 TX Typical Characteristics at 3.5 GHz

Typical values at $T_A = +25^\circ\text{C}$ with nominal supplies. Default conditions: TX input data rate = 491.52MSPS, $f_{\text{DAC}} = 11796.48\text{MSPS}$ (24x interpolation), interleave mode, 1st Nyquist zone output, PLL clock mode with $f_{\text{REF}} = 491.52\text{ MHz}$, $A_{\text{OUT}} = -1\text{ dBFS}$, DSA = 0 dB, Sin(x)/x enabled, DSA calibrated, TX Clock Dither Enabled

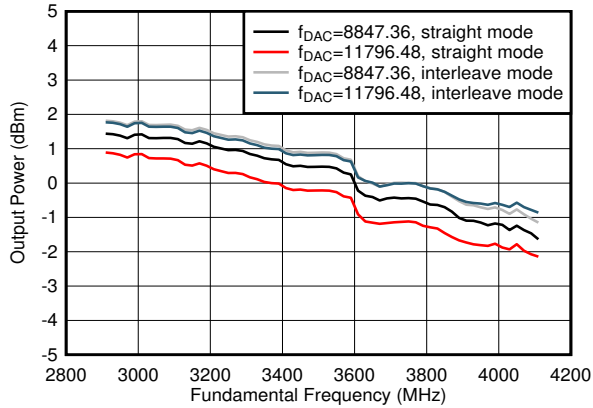

$A_{\text{out}} = -0.5\text{dBFS}$, 3.5 GHz Matching, included PCB and cable losses

Figure 6-118. TX Output Power vs Frequency

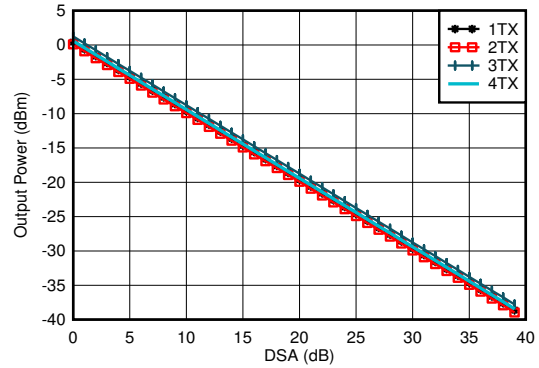

$A_{\text{out}} = -0.5\text{dBFS}$, 3.5 GHz Matching, included PCB and cable losses

Figure 6-119. TX Output Power vs DSA Setting at 3.5 GHz

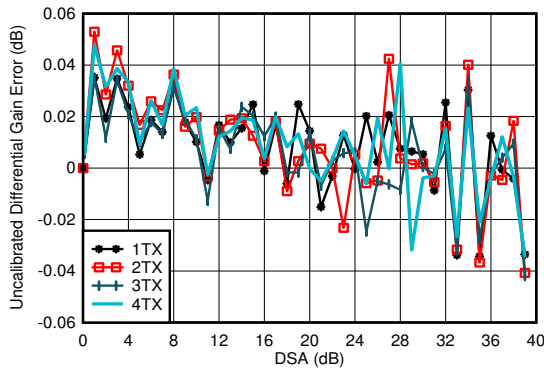

3.5 GHz Matching, included PCB and cable losses
Differential Gain Error = $P_{\text{OUT}}(\text{DSA Setting} - 1) - P_{\text{OUT}}(\text{DSA Setting}) + 1$

Figure 6-120. TX Uncalibrated Differential Gain Error vs DSA Setting and Channel at 3.5 GHz

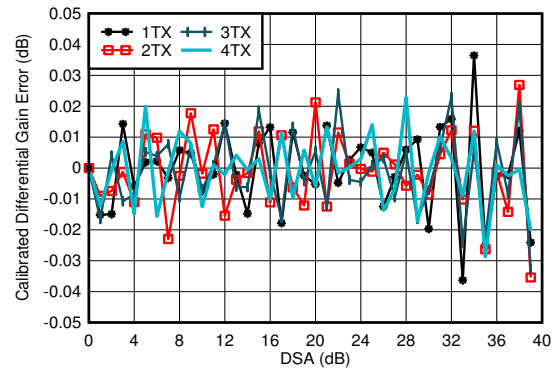

3.5 GHz Matching, included PCB and cable losses
Differential Gain Error = $P_{\text{OUT}}(\text{DSA Setting} - 1) - P_{\text{OUT}}(\text{DSA Setting}) + 1$

Figure 6-121. TX Calibrated Differential Gain Error vs DSA Setting and Channel at 3.5 GHz

6.12.4 TX Typical Characteristics at 3.5 GHz (continued)

Typical values at $T_A = +25^\circ\text{C}$ with nominal supplies. Default conditions: TX input data rate = 491.52MSPS, $f_{\text{DAC}} = 11796.48\text{MSPS}$ (24x interpolation), interleave mode, 1st Nyquist zone output, PLL clock mode with $f_{\text{REF}} = 491.52\text{ MHz}$, $A_{\text{OUT}} = -1\text{ dBFS}$, DSA = 0 dB, Sin(x)/x enabled, DSA calibrated, TX Clock Dither Enabled

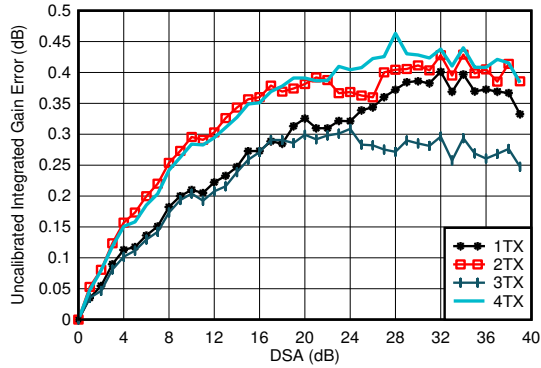

3.5 GHz Matching, included PCB and cable losses
Integrated Gain Error = $P_{\text{OUT}}(\text{DSA Setting}) - P_{\text{OUT}}(\text{DSA Setting} = 0) + (\text{DSA Setting})$

Figure 6-122. TX Uncalibrated Integrated Gain Error vs DSA Setting and Channel at 3.5 GHz

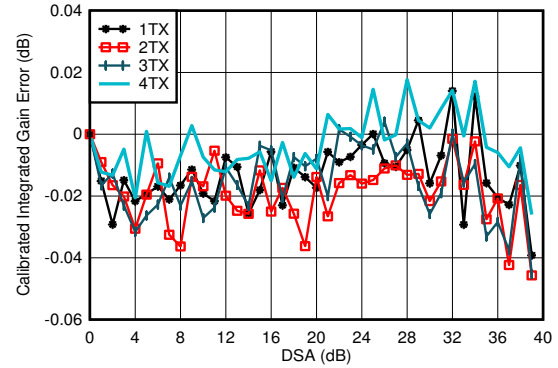

3.5 GHz Matching, included PCB and cable losses
Integrated Gain Error = $P_{\text{OUT}}(\text{DSA Setting}) - P_{\text{OUT}}(\text{DSA Setting} = 0) + (\text{DSA Setting})$

Figure 6-123. TX Calibrated Integrated Gain Error vs DSA Setting and Channel at 3.5 GHz

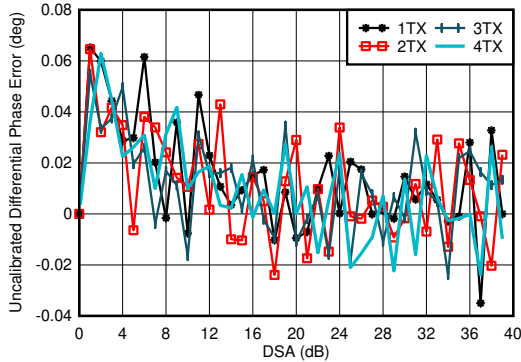

3.5 GHz Matching, included PCB and cable losses

Figure 6-124. TX Uncalibrated Differential Phase Error vs DSA Setting and Channel at 3.5 GHz

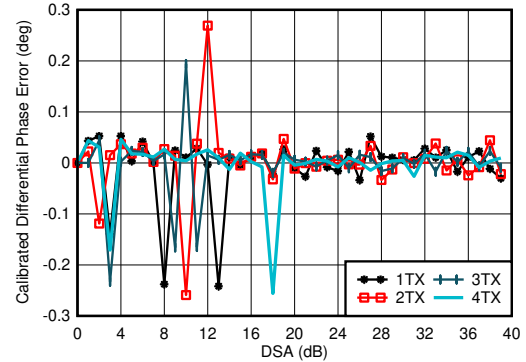

3.5 GHz Matching, included PCB and cable losses
Phase DNL spike may occur at any DSA setting.

Figure 6-125. TX Calibrated Differential Phase Error vs DSA Setting and Channel at 3.5 GHz

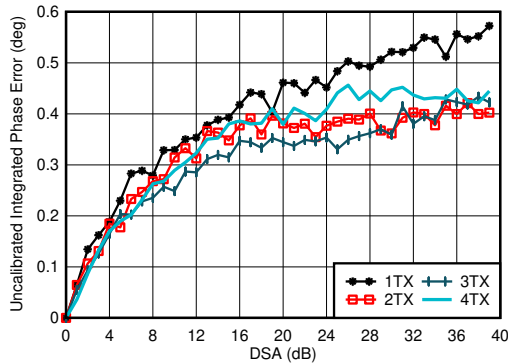

3.5 GHz Matching, included PCB and cable losses

Figure 6-126. TX Uncalibrated Integrated Phase Error vs DSA Setting and Channel at 3.5 GHz

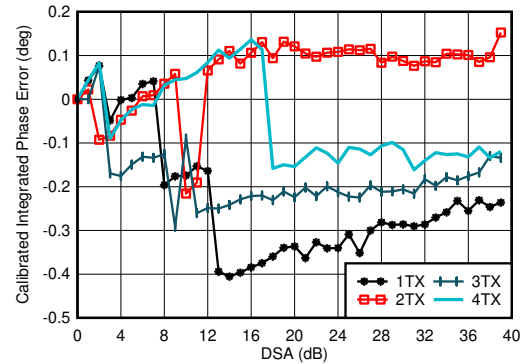

3.5 GHz Matching, included PCB and cable losses

Figure 6-127. TX Calibrated Integrated Phase Error vs DSA Setting and Channel at 3.5 GHz

6.12.4 TX Typical Characteristics at 3.5 GHz (continued)

Typical values at $T_A = +25^\circ\text{C}$ with nominal supplies. Default conditions: TX input data rate = 491.52MSPS, $f_{\text{DAC}} = 11796.48\text{MSPS}$ (24x interpolation), interleave mode, 1st Nyquist zone output, PLL clock mode with $f_{\text{REF}} = 491.52\text{ MHz}$, $A_{\text{OUT}} = -1\text{ dBFS}$, DSA = 0 dB, Sin(x)/x enabled, DSA calibrated, TX Clock Dither Enabled

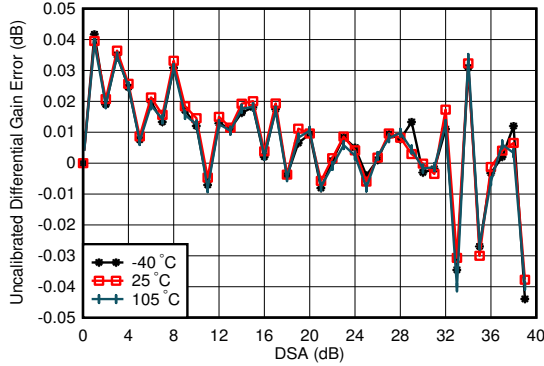

3.5 GHz Matching, 1TX

Figure 6-128. TX Uncalibrated Differential Gain Error vs DSA Setting and Temperature at 3.5 GHz

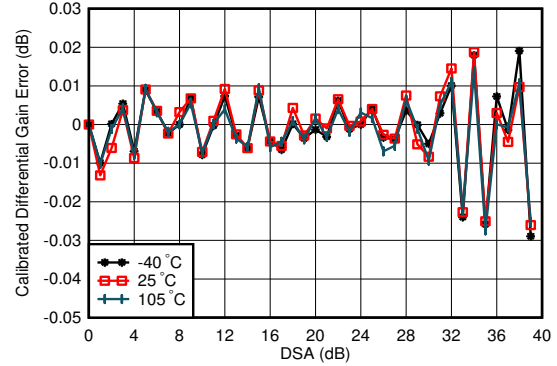

3.5 GHz Matching, 1TX, Calibrated at 25°C

Figure 6-129. TX Calibrated Differential Gain Error vs DSA Setting and Temperature at 3.5 GHz

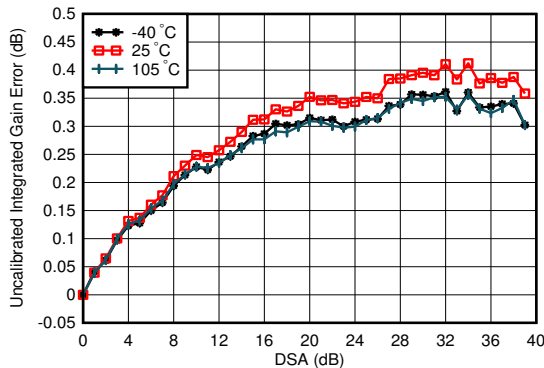

3.5 GHz Matching, 1TX

Figure 6-130. TX Uncalibrated Integrated Gain Error vs DSA Setting and Temperature at 3.5 GHz

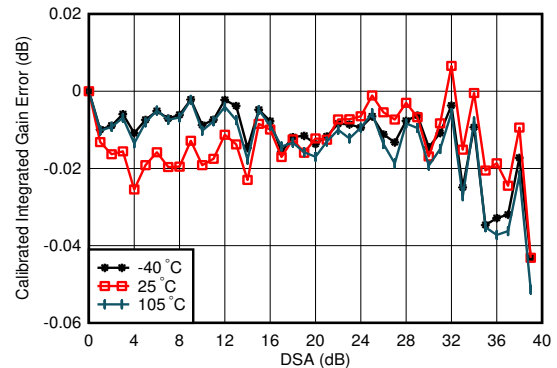

3.5 GHz Matching, 1TX, Calibrated at 25°C

Figure 6-131. TX Calibrated Integrated Gain Error vs DSA Setting and Temperature at 3.5 GHz

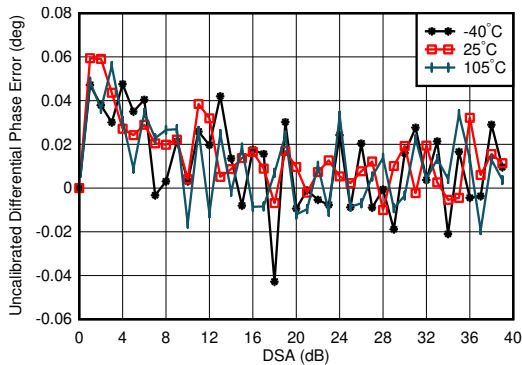

3.5 GHz Matching, 1TX

$$\text{Differential Phase Error} = \text{Phase}_{\text{OUT}}(\text{DSA Setting} - 1) - \text{Phase}_{\text{OUT}}(\text{DSA Setting})$$

Figure 6-132. TX Uncalibrated Differential Phase Error vs DSA setting and Temperature at 3.5 GHz

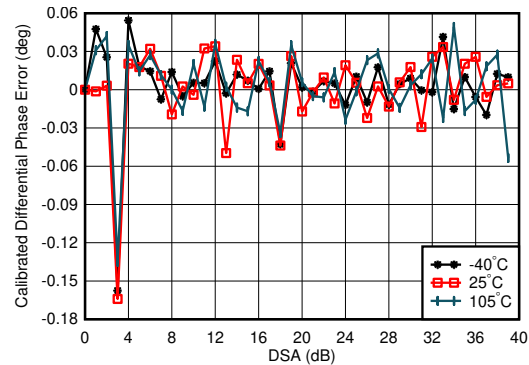

3.5 GHz Matching, 1TX, Calibrated at 25°C

$$\text{Differential Phase Error} = \text{Phase}_{\text{OUT}}(\text{DSA Setting} - 1) - \text{Phase}_{\text{OUT}}(\text{DSA Setting})$$

Figure 6-133. TX Calibrated Differential Phase Error vs DSA Setting and Temperature at 3.5 GHz

6.12.4 TX Typical Characteristics at 3.5 GHz (continued)

Typical values at $T_A = +25^\circ\text{C}$ with nominal supplies. Default conditions: TX input data rate = 491.52MSPS, $f_{\text{DAC}} = 11796.48\text{MSPS}$ (24x interpolation), interleave mode, 1st Nyquist zone output, PLL clock mode with $f_{\text{REF}} = 491.52\text{ MHz}$, $A_{\text{OUT}} = -1\text{ dBFS}$, DSA = 0 dB, Sin(x)/x enabled, DSA calibrated, TX Clock Dither Enabled

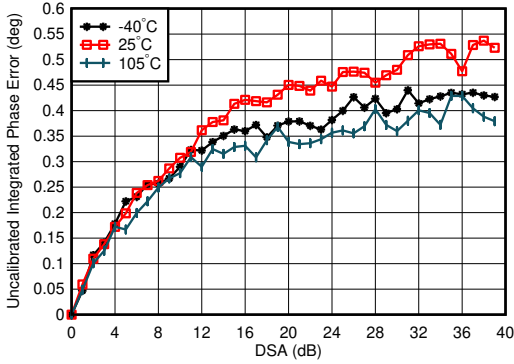

3.5 GHz Matching, 1TX
Integrated Phase Error = Phase(DSA Setting) – Phase(DSA Setting=0)

Figure 6-134. TX Uncalibrated Integrated Phase Error vs DSA Setting and Temperature at 3.5 GHz

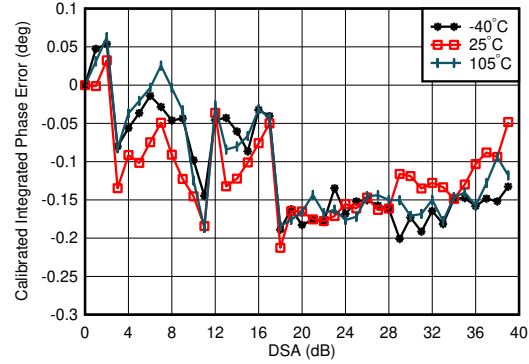

3.5 GHz Matching, 1TX, Calibrated at 25°C
Integrated Phase Error = Phase(DSA Setting) – Phase(DSA Setting = 0)

Figure 6-135. TX Calibrated Integrated Phase Error vs DSA Setting and Temperature at 3.5 GHz

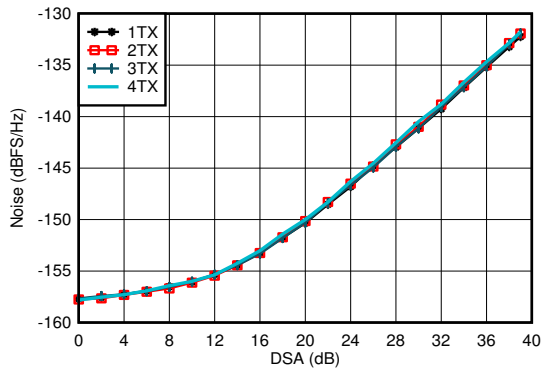

$f_{\text{DAC}}=11796.48\text{MSPS}$, interleave mode, matching at 3.5GHz,
 $A_{\text{out}} = -13\text{ dBFS}$.

Figure 6-136. TX NSD vs DSA Setting at 3.5 GHz

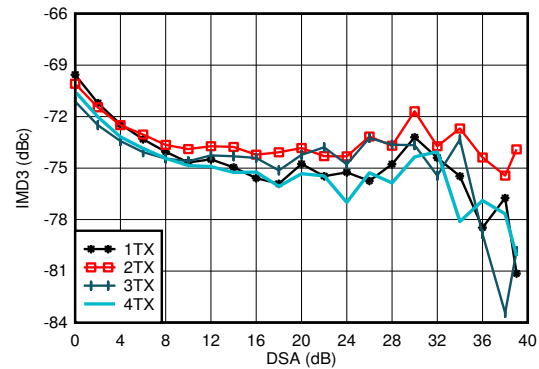

20-MHz tone spacing, 3.5 GHz Matching, -13 dBFS each tone, included PCB and cable losses

Figure 6-137. TX IMD3 vs DSA Setting at 3.5 GHz

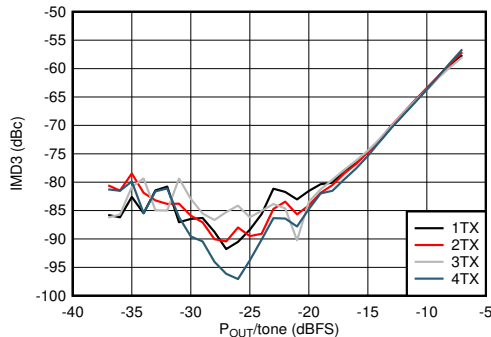

20-MHz tone spacing, 3.5 GHz Matching

Figure 6-138. TX IMD3 vs Digital Amplitude and Channel at 3.5 GHz

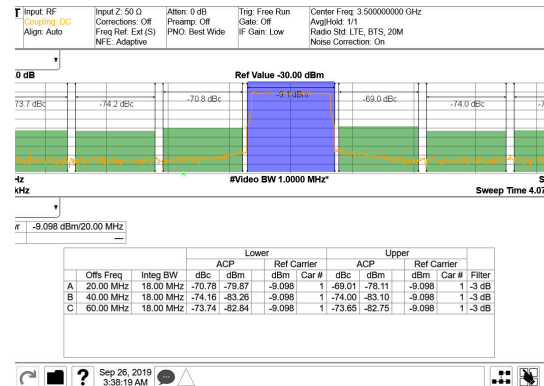

3.5 GHz Matching, single carrier 20-MHz BW TM1.1 LTE

Figure 6-139. TX 20-MHz LTE Output Spectrum at 3.5 GHz (Band 42)

6.12.4 TX Typical Characteristics at 3.5 GHz (continued)

Typical values at $T_A = +25^\circ\text{C}$ with nominal supplies. Default conditions: TX input data rate = 491.52MSPS, $f_{\text{DAC}} = 11796.48\text{MSPS}$ (24x interpolation), interleave mode, 1st Nyquist zone output, PLL clock mode with $f_{\text{REF}} = 491.52\text{ MHz}$, $A_{\text{OUT}} = -1\text{ dBFS}$, DSA = 0 dB, Sin(x)/x enabled, DSA calibrated, TX Clock Dither Enabled

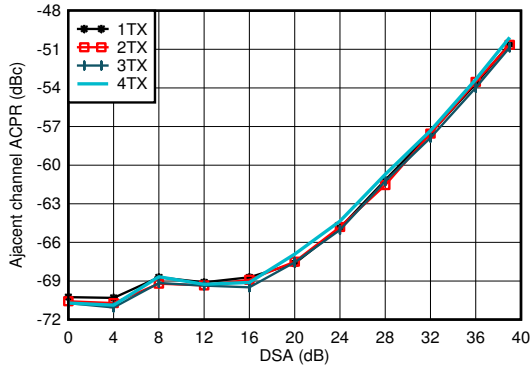

3.5 GHz Matching, single carrier 20-MHz BW TM1.1 LTE

Figure 6-140. TX 20-MHz LTE ACPR vs DSA Setting at 3.5 GHz

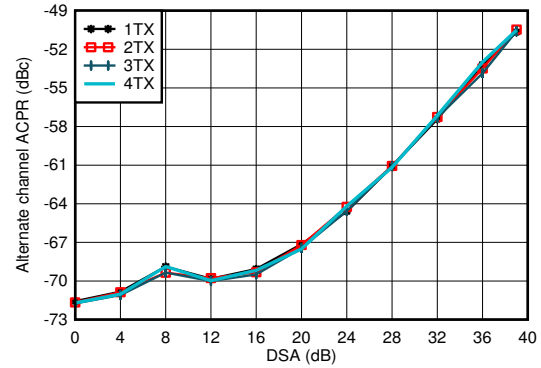

3.5 GHz Matching, single carrier 20-MHz BW TM1.1 LTE

Figure 6-141. TX 20-MHz LTE alt-ACPR vs DSA Setting at 3.5 GHz

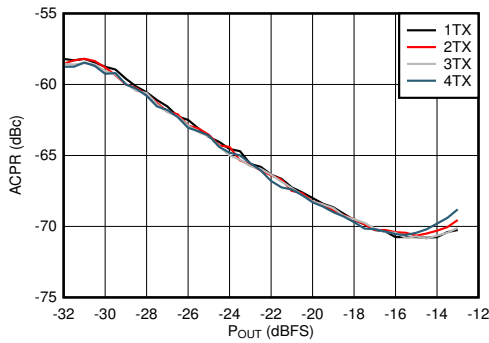

3.5 GHz Matching, single carrier 20-MHz BW TM1.1 LTE

Figure 6-142. TX 20-MHz LTE ACPR vs Digital Level at 3.5 GHz

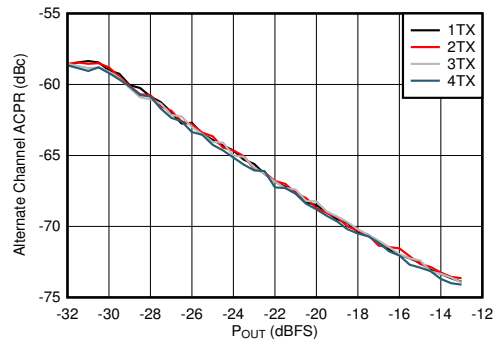

3.5 GHz Matching, single carrier 20-MHz BW TM1.1 LTE

Figure 6-143. TX 20-MHz LTE alt-ACPR vs Digital Level at 3.5 GHz

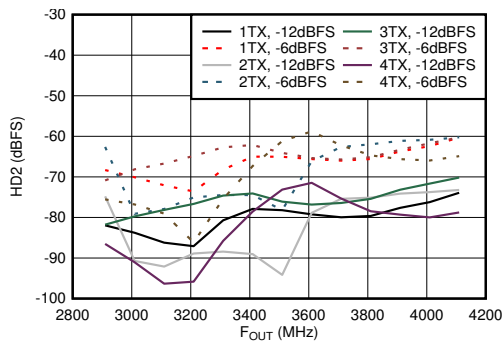

Matching at 3.5 GHz, $f_{\text{DAC}} = 11.79648\text{GSPS}$, interleave mode, normalized to output power at harmonic frequency

Figure 6-144. TX Single Tone HD2 vs Frequency and Digital Level at 3.5 GHz

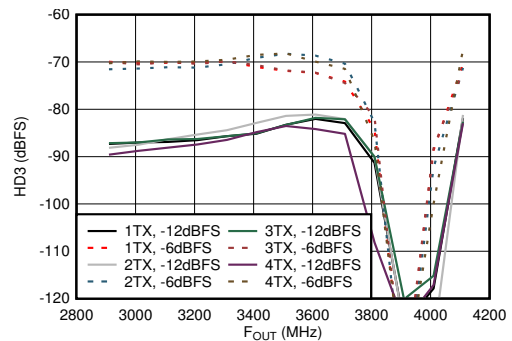

Matching at 3.5 GHz, $f_{\text{DAC}} = 11.79648\text{GSPS}$, interleave mode, normalized to output power at harmonic frequency. Dip is due to HD3 falling near DC.

Figure 6-145. TX Single Tone HD3 vs Frequency and Digital Level at 3.5 GHz

6.12.4 TX Typical Characteristics at 3.5 GHz (continued)

Typical values at $T_A = +25^\circ\text{C}$ with nominal supplies. Default conditions: TX input data rate = 491.52MSPS, $f_{\text{DAC}} = 11796.48\text{MSPS}$ (24x interpolation), interleave mode, 1st Nyquist zone output, PLL clock mode with $f_{\text{REF}} = 491.52\text{ MHz}$, $A_{\text{OUT}} = -1\text{ dBFS}$, DSA = 0 dB, Sin(x)/x enabled, DSA calibrated, TX Clock Dither Enabled

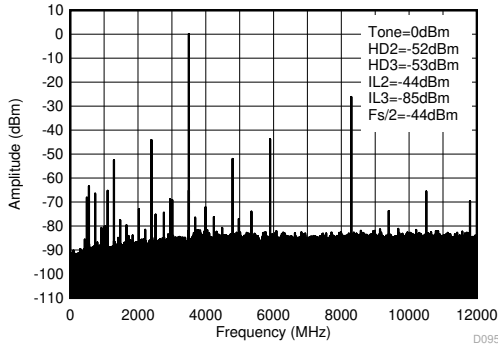

Matching at 3.5 GHz, $f_{\text{DAC}} = 11.79648\text{GSPS}$, interleave mode.

Figure 6-146. TX Single Tone (-1 dBFS) Output Spectrum at 3.5 GHz (0 - f_{DAC})

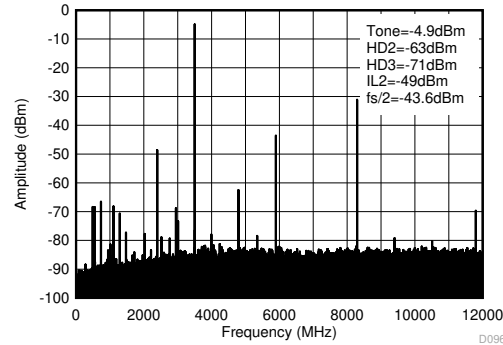

Matching at 3.5 GHz, $f_{\text{DAC}} = 11.79648\text{GSPS}$, interleave mode.

Figure 6-147. TX Single Tone (-6 dBFS) Output Spectrum at 3.5 GHz (0 - f_{DAC})

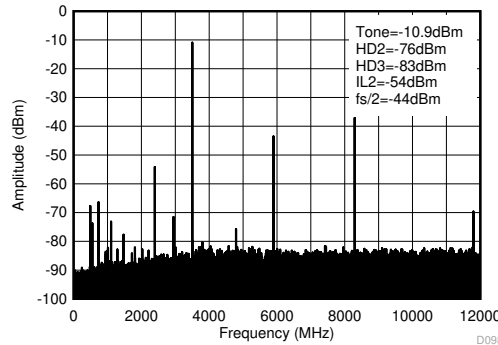

Matching at 3.5 GHz, $f_{\text{DAC}} = 11.79648\text{GSPS}$, interleave mode.

Figure 6-148. TX Single Tone (-12 dBFS) Output Spectrum at 3.5 GHz (0 - f_{DAC})

6.12.5 TX Typical Characteristics at 4.9 GHz

Typical values at $T_A = +25^\circ\text{C}$ with nominal supplies. Default conditions: TX input data rate = 491.52MSPS, $f_{\text{DAC}} = 11796.48\text{MSPS}$ (24x interpolation), interleave mode, 1st Nyquist zone output, PLL clock mode with $f_{\text{REF}} = 491.52\text{ MHz}$, $A_{\text{OUT}} = -1\text{ dBFS}$, DSA = 0 dB, Sin(x)/x enabled, DSA calibrated, TX Clock Dither Enabled

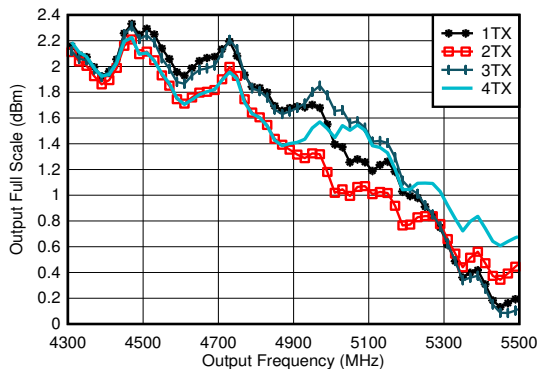

Excluding PCB and cable losses, $A_{\text{out}} = -0.5\text{dBFS}$, DSA = 0, 4.9 GHz matching

Figure 6-149. TX Full Scale vs RF Frequency and Channel at 11796.48MSPS

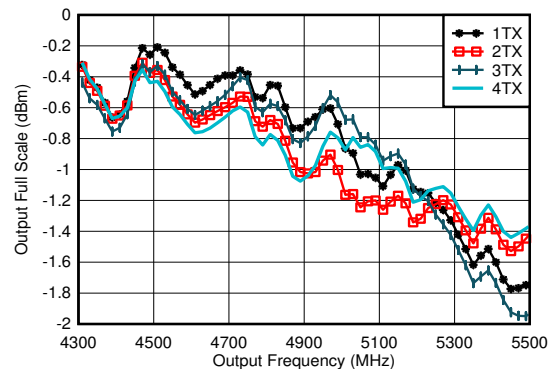

Excluding PCB and cable losses, $A_{\text{out}} = -0.5\text{dBFS}$, DSA = 0, 4.9 GHz matching

Figure 6-150. TX Full Scale vs RF Frequency and Channel at 5898.24MSPS, Straight Mode, 2nd Nyquist Zone

6.12.5 TX Typical Characteristics at 4.9 GHz (continued)

Typical values at $T_A = +25^\circ\text{C}$ with nominal supplies. Default conditions: TX input data rate = 491.52MSPS, $f_{\text{DAC}} = 11796.48\text{MSPS}$ (24x interpolation), interleave mode, 1st Nyquist zone output, PLL clock mode with $f_{\text{REF}} = 491.52\text{ MHz}$, $A_{\text{OUT}} = -1\text{ dBFS}$, DSA = 0 dB, Sin(x)/x enabled, DSA calibrated, TX Clock Dither Enabled

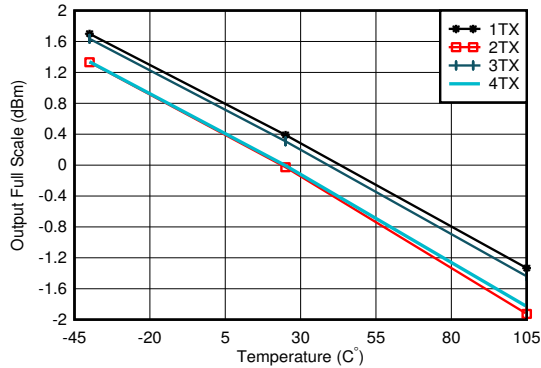

$f_{\text{DAC}} = 11796.48\text{ MSPS}$, $A_{\text{out}} = -0.5\text{dBFS}$, matching 4.9 GHz

Figure 6-151. TX Output Power vs DSA Setting and Channel at 4.9 GHz

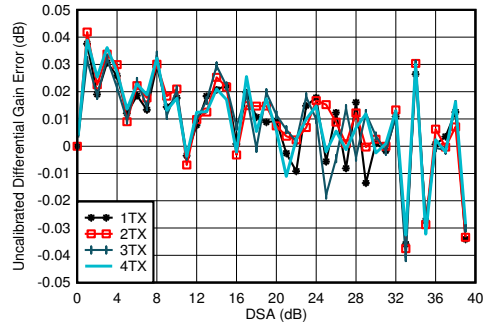

$f_{\text{DAC}}=11796.48\text{MSPS}$, interleave mode, matching at 4.9 GHz
 Differential Gain Error = $P_{\text{OUT}}(\text{DSA Setting} - 1) - P_{\text{OUT}}(\text{DSA Setting}) + 1$

Figure 6-152. TX Uncalibrated Differential Gain Error vs DSA Setting and Channel at 4.9 GHz

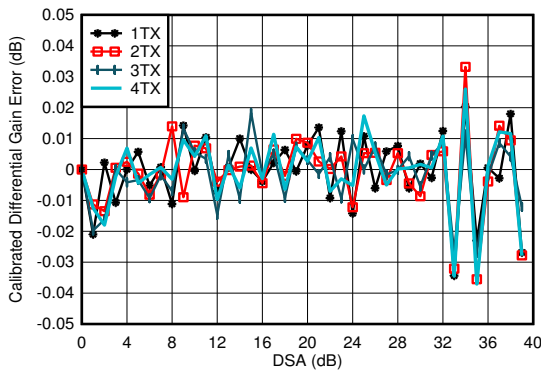

$f_{\text{DAC}}=11796.48\text{MSPS}$, interleave mode, matching at 4.9 GHz
 Differential Gain Error = $P_{\text{OUT}}(\text{DSA Setting} - 1) - P_{\text{OUT}}(\text{DSA Setting}) + 1$

Figure 6-153. TX Calibrated Differential Gain Error vs DSA Setting and Channel at 4.9 GHz

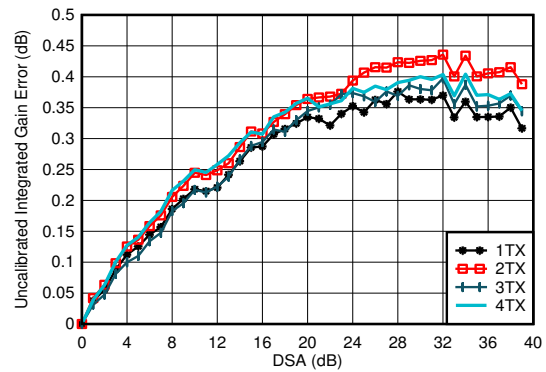

$f_{\text{DAC}}=11796.48\text{MSPS}$, interleave mode, matching at 4.9 GHz
 Integrated Gain Error = $P_{\text{OUT}}(\text{DSA Setting}) - P_{\text{OUT}}(\text{DSA Setting} = 0) + (\text{DSA Setting})$

Figure 6-154. TX Uncalibrated Integrated Gain Error vs DSA Setting and Channel at 4.9 GHz

6.12.5 TX Typical Characteristics at 4.9 GHz (continued)

Typical values at $T_A = +25^\circ\text{C}$ with nominal supplies. Default conditions: TX input data rate = 491.52MSPS, $f_{\text{DAC}} = 11796.48\text{MSPS}$ (24x interpolation), interleave mode, 1st Nyquist zone output, PLL clock mode with $f_{\text{REF}} = 491.52\text{ MHz}$, $A_{\text{OUT}} = -1\text{ dBFS}$, DSA = 0 dB, Sin(x)/x enabled, DSA calibrated, TX Clock Dither Enabled

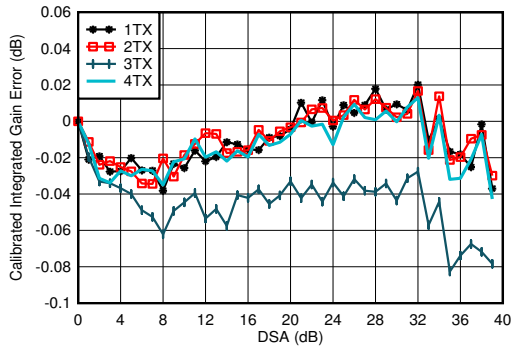

$f_{\text{DAC}} = 11796.48\text{MSPS}$, interleave mode, matching at 4.9 GHz
Integrated Gain Error = $P_{\text{OUT}}(\text{DSA Setting}) - P_{\text{OUT}}(\text{DSA Setting} = 0) + (\text{DSA Setting})$

Figure 6-155. TX Calibrated Integrated Gain Error vs DSA Setting and Channel at 4.9 GHz

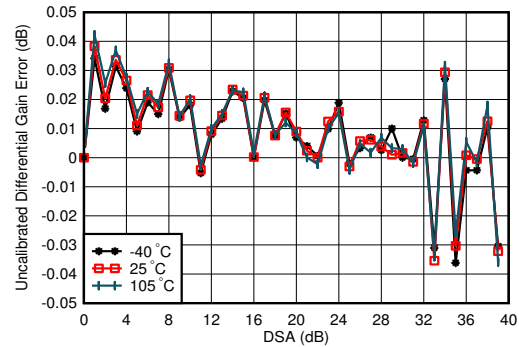

$f_{\text{DAC}} = 11796.48\text{MSPS}$, interleaved mode, matching at 4.9 GHz
Differential Gain Error = $P_{\text{OUT}}(\text{DSA Setting} - 1) - P_{\text{OUT}}(\text{DSA Setting}) + 1$

Figure 6-156. TX Uncalibrated Differential Gain Error vs DSA Setting and Temperature at 4.9 GHz

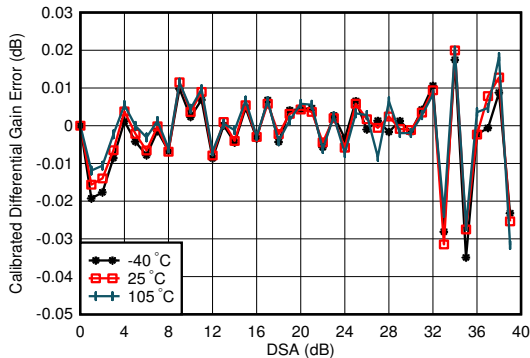

$f_{\text{DAC}} = 11796.48\text{MSPS}$, interleaved mode, matching at 4.9 GHz
Differential Gain Error = $P_{\text{OUT}}(\text{DSA Setting} - 1) - P_{\text{OUT}}(\text{DSA Setting}) + 1$

Figure 6-157. TX Calibrated Differential Gain Error vs DSA Setting and Temperature at 4.9 GHz

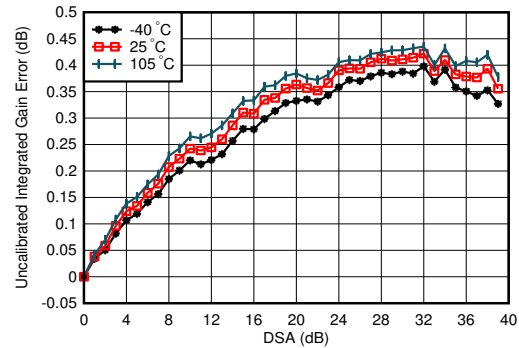

$f_{\text{DAC}} = 11796.48\text{MSPS}$, interleaved mode, matching at 4.9 GHz
Integrated Gain Error = $P_{\text{OUT}}(\text{DSA Setting}) - P_{\text{OUT}}(\text{DSA Setting} = 0) + (\text{DSA Setting})$

Figure 6-158. TX Uncalibrated Integrated Gain Error vs DSA Setting and Temperature at 4.9 GHz

6.12.5 TX Typical Characteristics at 4.9 GHz (continued)

Typical values at $T_A = +25^\circ\text{C}$ with nominal supplies. Default conditions: TX input data rate = 491.52MSPS, $f_{\text{DAC}} = 11796.48\text{MSPS}$ (24x interpolation), interleave mode, 1st Nyquist zone output, PLL clock mode with $f_{\text{REF}} = 491.52\text{ MHz}$, $A_{\text{OUT}} = -1\text{ dBFS}$, DSA = 0 dB, Sin(x)/x enabled, DSA calibrated, TX Clock Dither Enabled

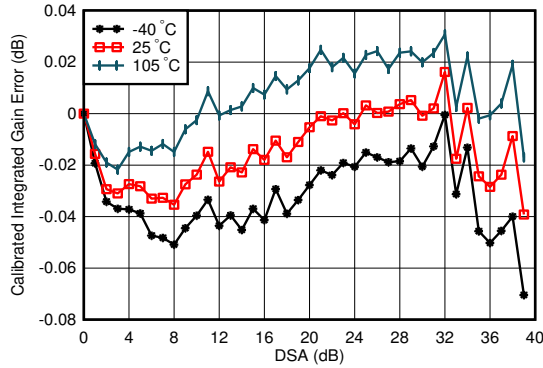

$f_{\text{DAC}} = 11796.48\text{MSPS}$, interleaved mode, matching at 4.9 GHz
 Integrated Gain Error = $P_{\text{OUT}}(\text{DSA Setting}) - P_{\text{OUT}}(\text{DSA Setting} = 0) + (\text{DSA Setting})$

Figure 6-159. TX Calibrated Integrated Gain Error vs DSA Setting and Temperature at 4.9 GHz

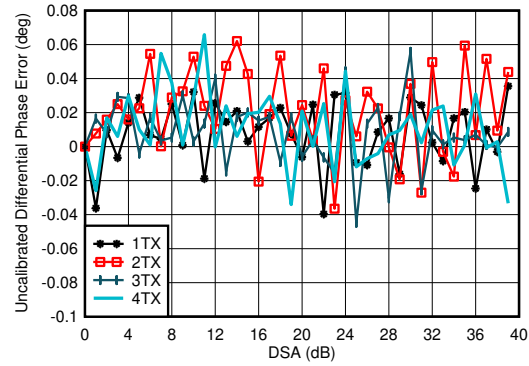

$f_{\text{DAC}} = 11796.48\text{MSPS}$, interleaved mode, matching at 4.9 GHz
 Differential Phase Error = $\text{Phase}_{\text{OUT}}(\text{DSA Setting} - 1) - \text{Phase}_{\text{OUT}}(\text{DSA Setting})$

Figure 6-160. TX Uncalibrated Differential Phase Error vs DSA Setting and Channel at 4.9 GHz

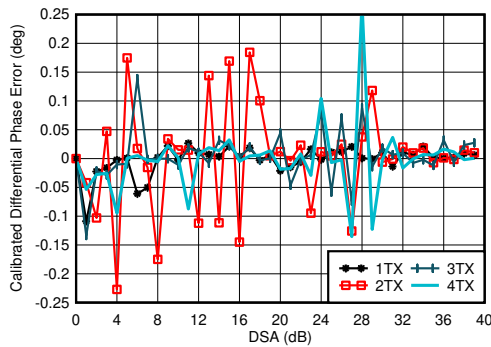

$f_{\text{DAC}} = 11796.48\text{MSPS}$, interleaved mode, matching at 4.9 GHz
 Differential Phase Error = $\text{Phase}_{\text{OUT}}(\text{DSA Setting} - 1) - \text{Phase}_{\text{OUT}}(\text{DSA Setting})$
 Phase DNL spike may occur at any DSA setting.

Figure 6-161. TX Calibrated Differential Phase Error vs DSA Setting and Channel at 4.9 GHz

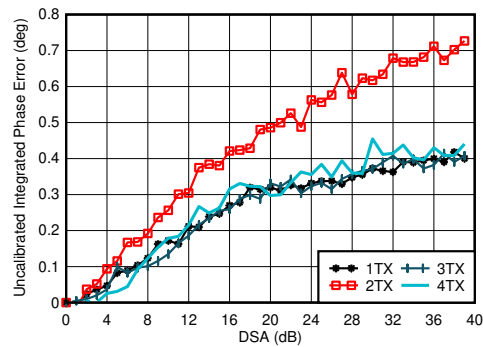

$f_{\text{DAC}} = 11796.48\text{MSPS}$, interleaved mode, matching at 4.9 GHz
 Integrated Phase Error = $\text{Phase}(\text{DSA Setting}) - \text{Phase}(\text{DSA Setting} = 0)$

Figure 6-162. TX Uncalibrated Integrated Phase Error vs DSA Setting and Channel at 4.9 GHz

6.12.5 TX Typical Characteristics at 4.9 GHz (continued)

Typical values at $T_A = +25^\circ\text{C}$ with nominal supplies. Default conditions: TX input data rate = 491.52MSPS, $f_{\text{DAC}} = 11796.48\text{MSPS}$ (24x interpolation), interleaved mode, 1st Nyquist zone output, PLL clock mode with $f_{\text{REF}} = 491.52\text{ MHz}$, $A_{\text{OUT}} = -1\text{ dBFS}$, DSA = 0 dB, Sin(x)/x enabled, DSA calibrated, TX Clock Dither Enabled

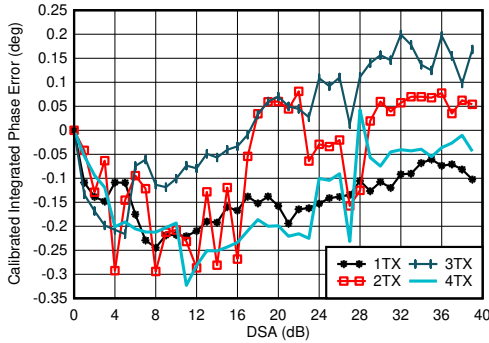

$f_{\text{DAC}} = 11796.48\text{MSPS}$, interleaved mode, matching at 4.9 GHz
Integrated Phase Error = Phase(DSA Setting) – Phase(DSA Setting = 0)

Figure 6-163. TX Calibrated Integrated Phase Error vs DSA Setting and Channel at 4.9 GHz

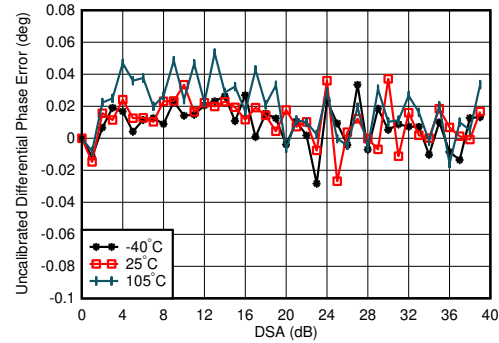

$f_{\text{DAC}} = 11796.48\text{MSPS}$, interleaved mode, matching at 4.9 GHz
Differential Phase Error = Phase_{OUT}(DSA Setting – 1) – Phase_{OUT}(DSA Setting)

Figure 6-164. TX Uncalibrated Differential Phase Error vs DSA Setting and Temperature at 4.9 GHz

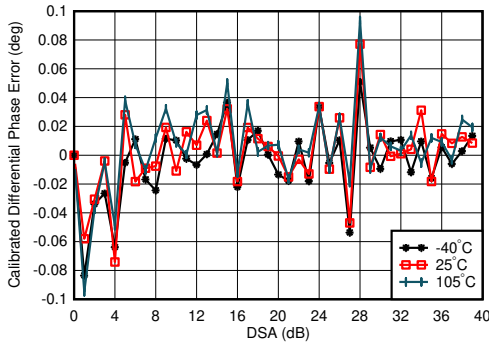

$f_{\text{DAC}} = 11796.48\text{MSPS}$, interleaved mode, matching at 4.9 GHz
Differential Phase Error = Phase_{OUT}(DSA Setting – 1) – Phase_{OUT}(DSA Setting)

Figure 6-165. TX Calibrated Differential Phase Error vs DSA Setting and Temperature at 4.9 GHz

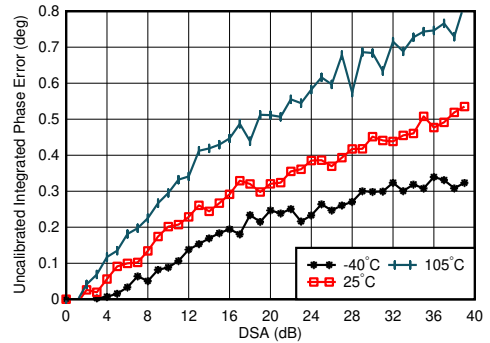

$f_{\text{DAC}} = 11796.48\text{MSPS}$, interleaved mode, matching at 4.9 GHz
Integrated Phase Error = Phase(DSA Setting) – Phase(DSA Setting = 0)

Figure 6-166. TX Uncalibrated Integrated Phase Error vs DSA Setting and Temperature at 4.9 GHz

6.12.5 TX Typical Characteristics at 4.9 GHz (continued)

Typical values at $T_A = +25^\circ\text{C}$ with nominal supplies. Default conditions: TX input data rate = 491.52MSPS, $f_{\text{DAC}} = 11796.48\text{MSPS}$ (24x interpolation), interleaved mode, 1st Nyquist zone output, PLL clock mode with $f_{\text{REF}} = 491.52\text{ MHz}$, $A_{\text{OUT}} = -1\text{ dBFS}$, DSA = 0 dB, Sin(x)/x enabled, DSA calibrated, TX Clock Dither Enabled

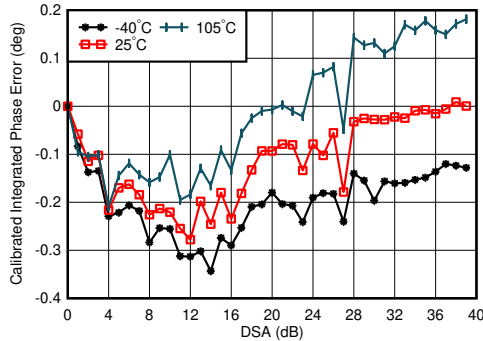

$f_{\text{DAC}} = 11796.48\text{MSPS}$, interleaved mode, matching at 4.9 GHz, channel with the median variation over DSA setting at 25°C
Integrated Phase Error = Phase(DSA Setting) – Phase(DSA Setting = 0)

Figure 6-167. TX Calibrated Integrated Phase Error vs DSA Setting and Temperature at 4.9 GHz

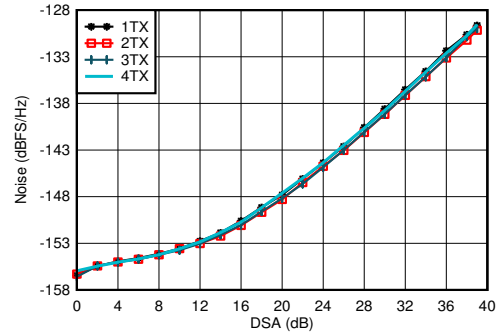

$f_{\text{DAC}} = 11796.48\text{MSPS}$, interleaved mode, matching at 4.9 GHz, $P_{\text{OUT}} = -13\text{ dBFS}$

Figure 6-168. TX Output Noise vs Channel and Attenuation at 2.6 GHz

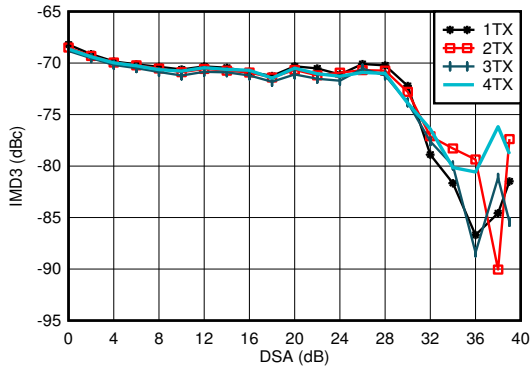

$f_{\text{DAC}} = 11796.48\text{MSPS}$, interleaved mode, matching at 4.9 GHz, $f_{\text{CENTER}} = 4.9\text{GHz}$, -13 dBFS each tone

Figure 6-169. TX IMD3 vs DSA Setting at 4.9 GHz

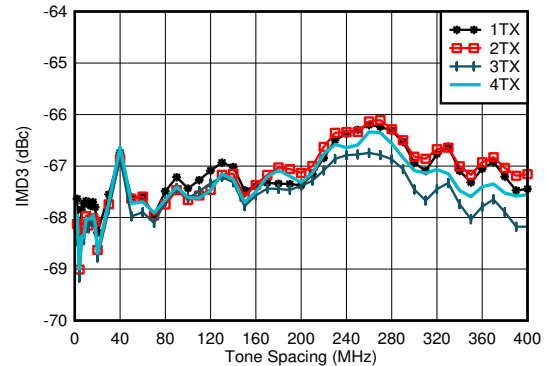

$f_{\text{DAC}} = 11796.48\text{MSPS}$, interleaved mode, matching at 4.9 GHz, $f_{\text{CENTER}} = 4.9\text{GHz}$, -13 dBFS each tone

Figure 6-170. TX IMD3 vs Tone Spacing and Channel at 4.9 GHz

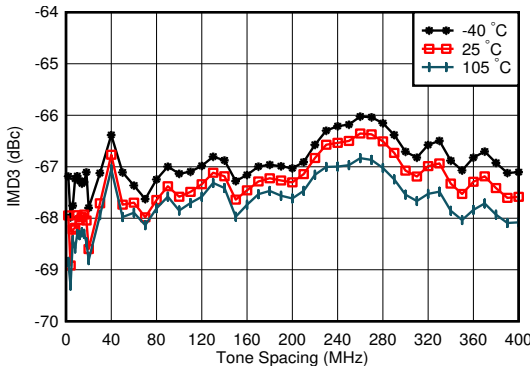

$f_{\text{DAC}} = 11796.48\text{MSPS}$, interleaved mode, matching at 4.9 GHz, $f_{\text{CENTER}} = 4.9\text{GHz}$, -13 dBFS each tone, worst channel

Figure 6-171. TX IMD3 vs Tone Spacing and Temperature at 4.9 GHz

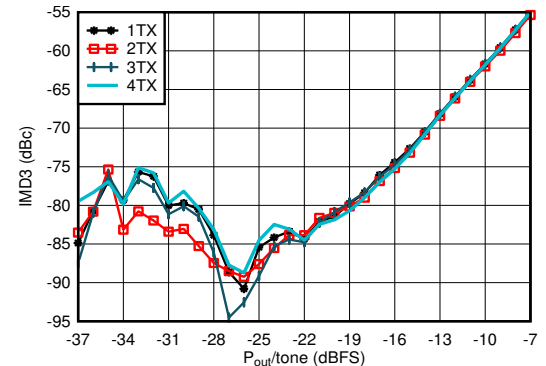

$f_{\text{DAC}} = 11796.48\text{MSPS}$, interleaved mode, matching at 4.9 GHz, $f_{\text{CENTER}} = 4.9\text{GHz}$, $f_{\text{SPACING}} = 20\text{ MHz}$

Figure 6-172. TX IMD3 vs Digital Level at 4.9 GHz

6.12.5 TX Typical Characteristics at 4.9 GHz (continued)

Typical values at $T_A = +25^\circ\text{C}$ with nominal supplies. Default conditions: TX input data rate = 491.52MSPS, $f_{\text{DAC}} = 11796.48\text{MSPS}$ (24x interpolation), interleave mode, 1st Nyquist zone output, PLL clock mode with $f_{\text{REF}} = 491.52\text{ MHz}$, $A_{\text{OUT}} = -1\text{ dBFS}$, DSA = 0 dB, Sin(x)/x enabled, DSA calibrated, TX Clock Dither Enabled

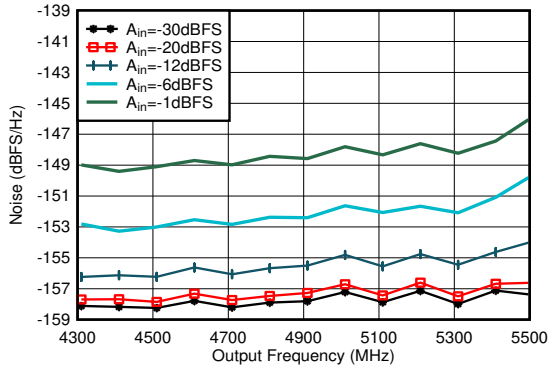

Matching at 4.9 GHz, Single tone, $f_{\text{DAC}} = 11.79648\text{GSPS}$, interleave mode, 40-MHz offset, DSA=0dB

Figure 6-173. TX Single Tone Output Noise vs Frequency and Amplitude at 4.9 GHz

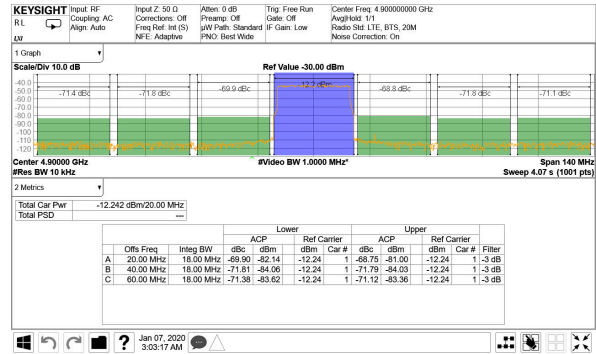

TM1.1, $P_{\text{OUT_RMS}} = -13\text{ dBFS}$

Figure 6-174. TX 20-MHz LTE Output Spectrum at 4.9 GHz

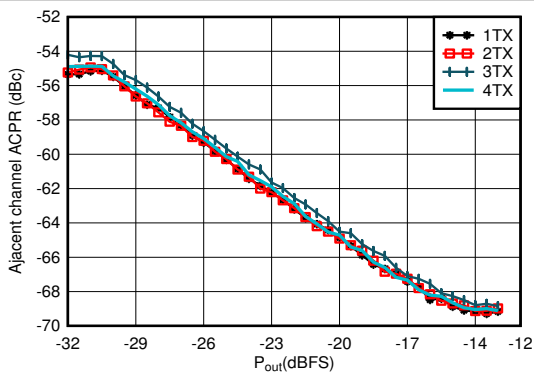

Matching at 4.9 GHz, single carrier 20-MHz BW TM1.1 LTE

Figure 6-175. TX 20-MHz LTE ACPR vs Digital Level at 4.9 GHz

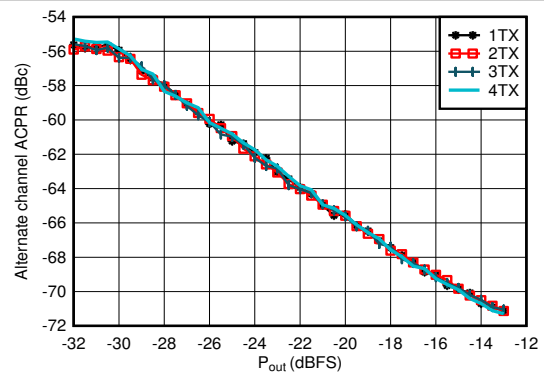

Matching at 4.9 GHz, single carrier 20-MHz BW TM1.1 LTE

Figure 6-176. TX 20-MHz LTE alt-ACPR vs Digital Level at 4.9 GHz

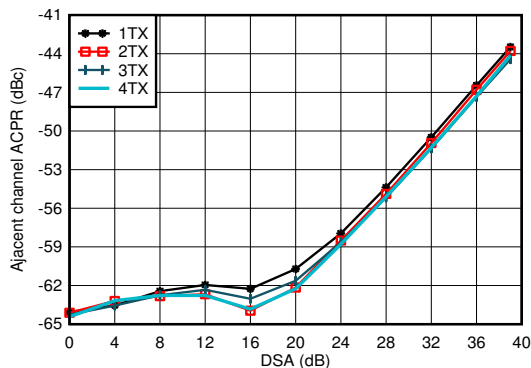

Matching at 4.9 GHz, single carrier 20-MHz BW TM1.1 LTE

Figure 6-177. TX 20-MHz LTE ACPR vs DSA at 4.9 GHz

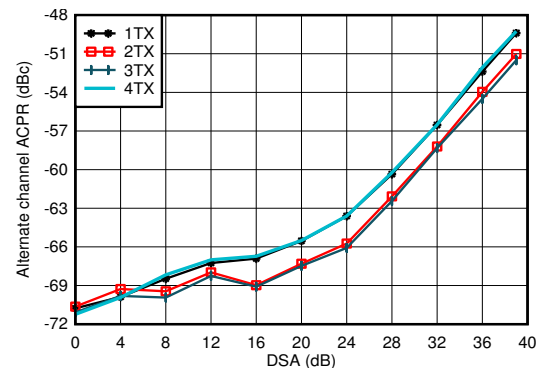

Matching at 4.9 GHz, single carrier 20-MHz BW TM1.1 LTE

Figure 6-178. TX 20-MHz LTE alt-ACPR vs DSA at 4.9 GHz

6.12.5 TX Typical Characteristics at 4.9 GHz (continued)

Typical values at $T_A = +25^\circ\text{C}$ with nominal supplies. Default conditions: TX input data rate = 491.52MSPS, $f_{\text{DAC}} = 11796.48\text{MSPS}$ (24x interpolation), interleave mode, 1st Nyquist zone output, PLL clock mode with $f_{\text{REF}} = 491.52\text{MHz}$, $A_{\text{OUT}} = -1\text{dBFS}$, DSA = 0 dB, Sin(x)/x enabled, DSA calibrated, TX Clock Dither Enabled

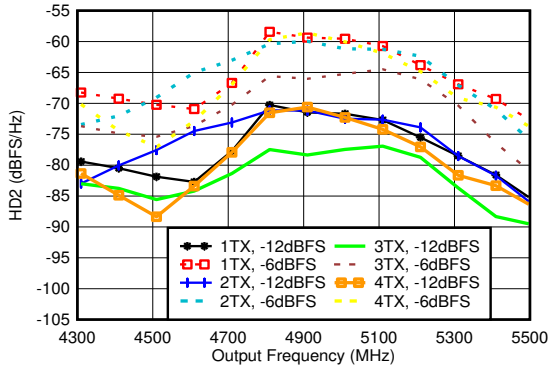

Matching at 4.9 GHz, $f_{\text{DAC}} = 11.79648\text{GSPPS}$, interleave mode, normalized to output power at harmonic frequency

Figure 6-179. TX HD2 vs Digital Amplitude and Output Frequency at 4.9 GHz

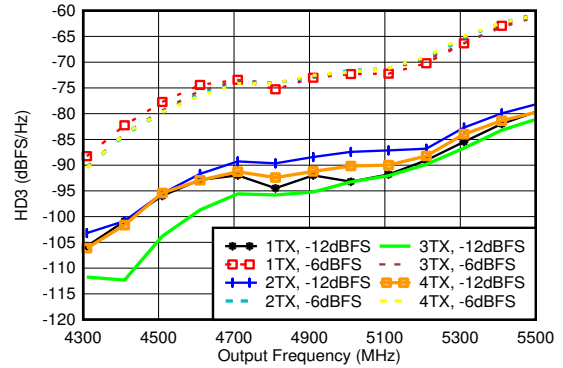

Matching at 4.9 GHz, $f_{\text{DAC}} = 11.79648\text{GSPPS}$, interleave mode, normalized to output power at harmonic frequency

Figure 6-180. TX HD3 vs Digital Amplitude and Output Frequency at 4.9 GHz

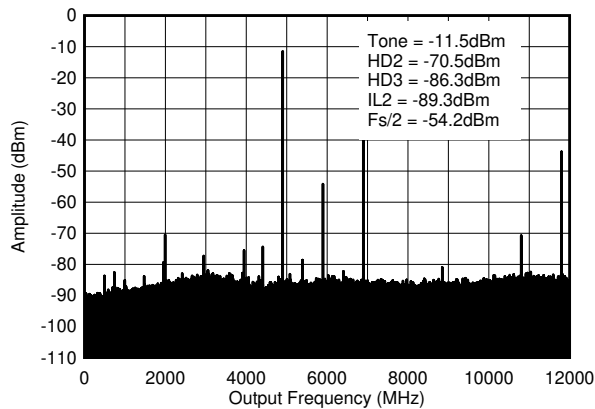

$f_{\text{DAC}} = 11796.48\text{MSPS}$, interleave mode, 4.9 GHz matching, includes PCB and cable losses. $IL_n = f_s/n \pm f_{\text{OUT}}$.

Figure 6-181. TX Single Tone (-12 dBFS) Output Spectrum at 4.9 GHz ($0-f_{\text{DAC}}$)

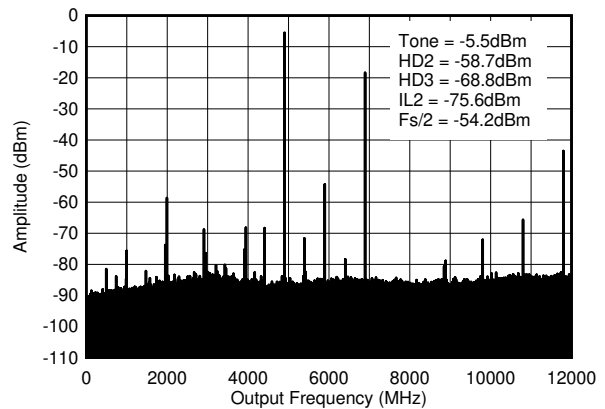

$f_{\text{DAC}} = 11796.48\text{MSPS}$, interleave mode, 4.9 GHz matching, includes PCB and cable losses. $IL_n = f_s/n \pm f_{\text{OUT}}$.

Figure 6-182. TX Single Tone (-6 dBFS) Output Spectrum at 4.9 GHz ($0-f_{\text{DAC}}$)

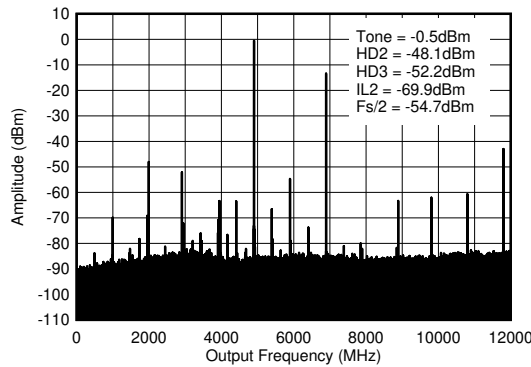

$f_{\text{DAC}} = 11796.48\text{MSPS}$, interleave mode, 4.9 GHz matching, includes PCB and cable losses. $IL_n = f_s/n \pm f_{\text{OUT}}$.

Figure 6-183. TX Single Tone (-1 dBFS) Output Spectrum at 4.9 GHz ($0-f_{\text{DAC}}$)

6.12.6 TX Typical Characteristics at 8.1 GHz

Typical values at $T_A = +25^\circ\text{C}$ with nominal supplies. Default conditions: TX input data rate = 491.52MSPS, $f_{\text{DAC}} = 11796.48\text{MSPS}$ (24x interpolation), mixed mode, 1st Nyquist zone output, PLL clock mode with $f_{\text{REF}} = 491.52\text{ MHz}$, $A_{\text{OUT}} = -1\text{ dBFS}$, DSA = 0 dB, Sin(x)/x enabled, DSA calibrated, TX Clock Dither Enabled, 8.1 GHz matching

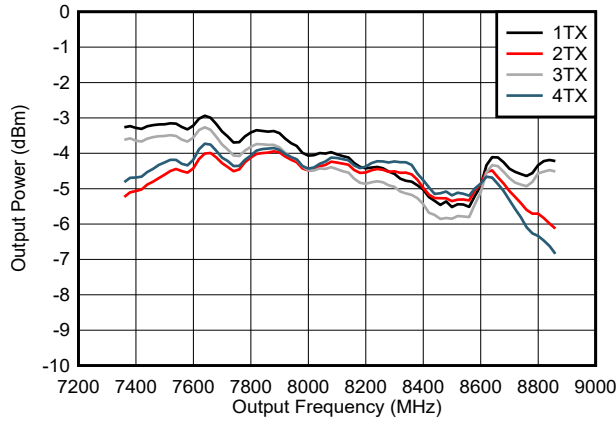

includes PCB and cable losses.

Figure 6-184. TX Output Power vs Frequency at 8.11 GHz

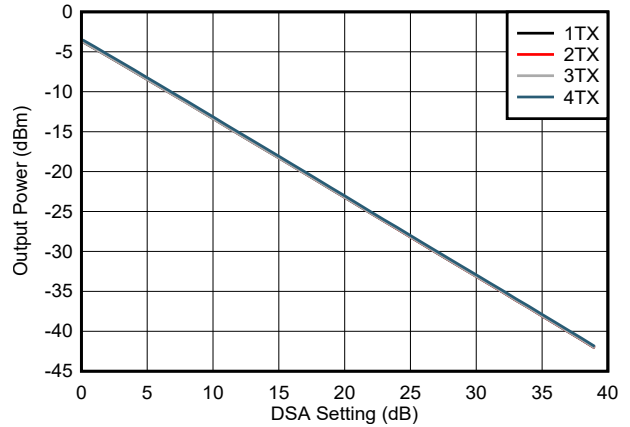

includes PCB and cable losses.

Figure 6-185. TX Output Power vs DSA Setting at 8.11 GHz

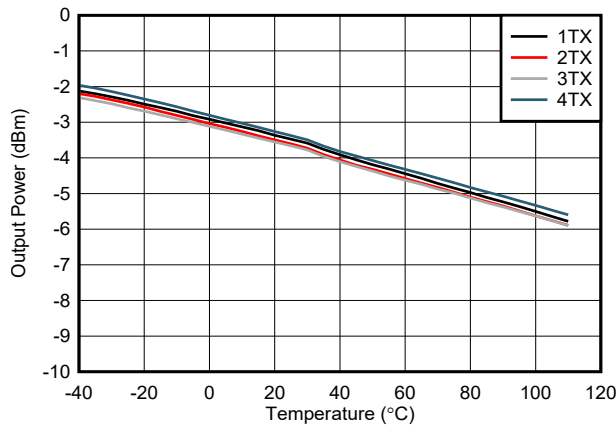

includes PCB and cable losses.

Figure 6-186. TX Output Power vs Temperature at 8.11 GHz

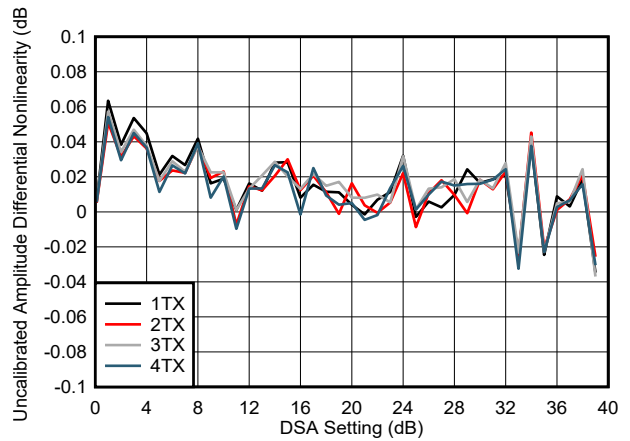

Figure 6-187. TX DSA Uncalibrated Amplitude Differential Nonlinearity at 8.11 GHz

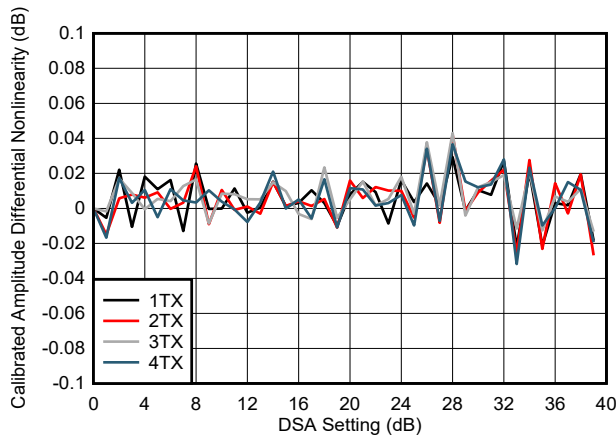

Figure 6-188. TX DSA Calibrated Amplitude Differential Nonlinearity at 8.11 GHz

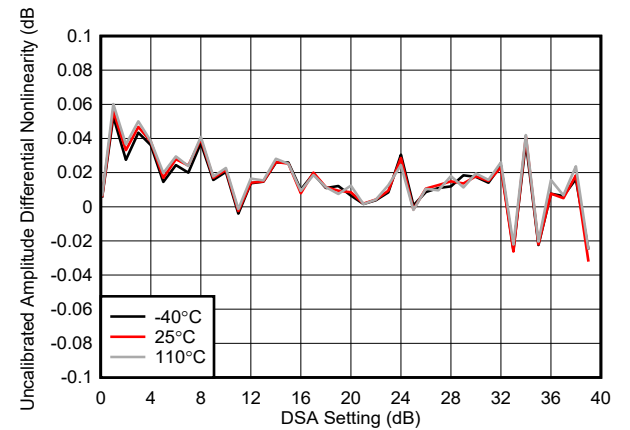

Figure 6-189. TX DSA Uncalibrated Amplitude Differential Nonlinearity at 8.11 GHz

6.12.6 TX Typical Characteristics at 8.1 GHz (continued)

Typical values at $T_A = +25^\circ\text{C}$ with nominal supplies. Default conditions: TX input data rate = 491.52MSPS, $f_{\text{DAC}} = 11796.48\text{MSPS}$ (24x interpolation), mixed mode, 1st Nyquist zone output, PLL clock mode with $f_{\text{REF}} = 491.52\text{ MHz}$, $A_{\text{OUT}} = -1\text{ dBFS}$, DSA = 0 dB, Sin(x)/x enabled, DSA calibrated, TX Clock Dither Enabled, 8.1 GHz matching

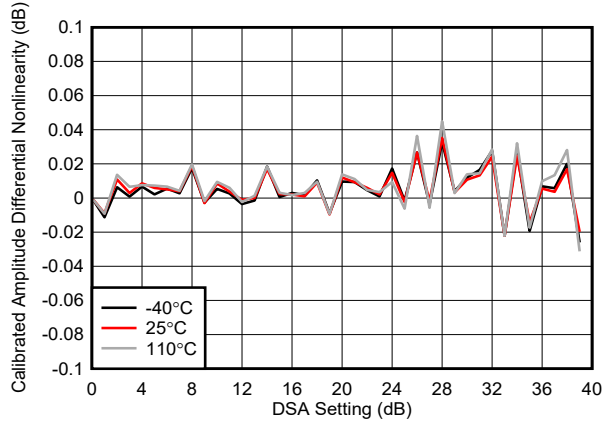

Figure 6-190. TX DSA Calibrated Amplitude Differential Nonlinearity at 8.11 GHz

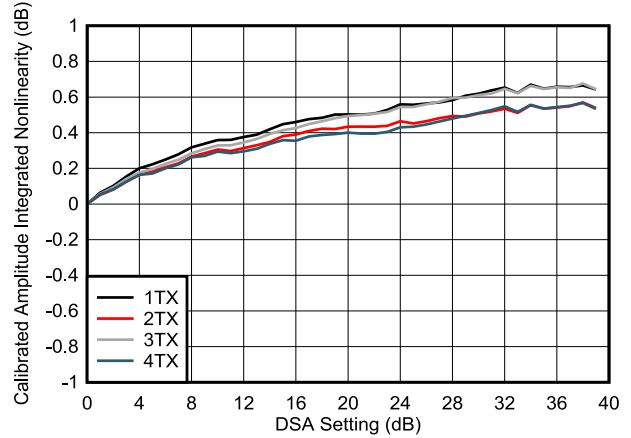

Figure 6-191. TX DSA Uncalibrated Amplitude Integrated Nonlinearity at 8.11 GHz

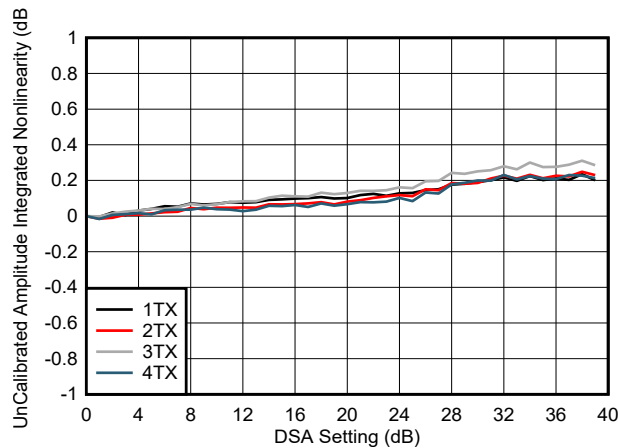

Figure 6-192. TX DSA Calibrated Amplitude Integrated Nonlinearity at 8.11 GHz

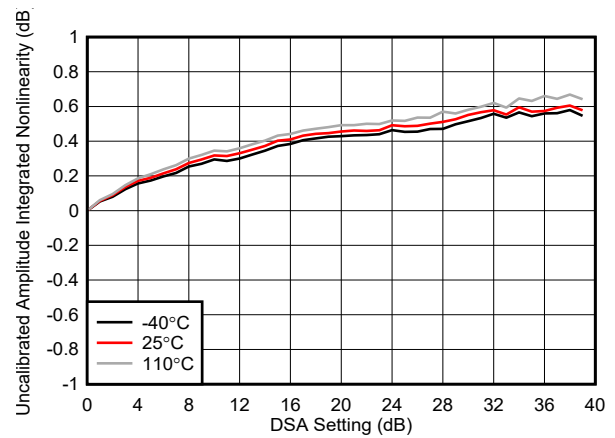

Figure 6-193. TX DSA Uncalibrated Amplitude Integrated Nonlinearity at 8.11 GHz

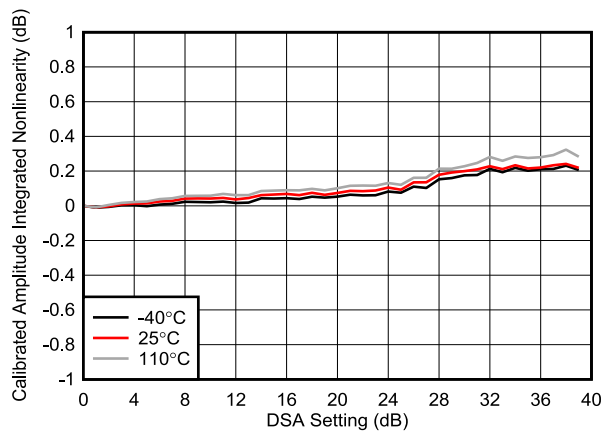

Figure 6-194. TX DSA Calibrated Amplitude Integrated Nonlinearity at 8.11 GHz

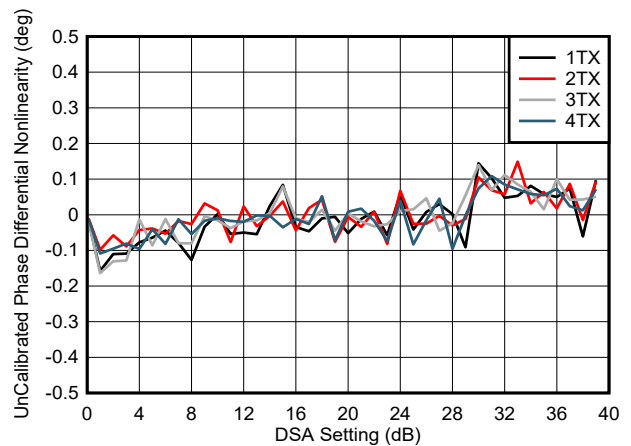

Figure 6-195. TX DSA Uncalibrated Phase Differential Nonlinearity at 8.11 GHz

6.12.6 TX Typical Characteristics at 8.1 GHz (continued)

Typical values at $T_A = +25^\circ\text{C}$ with nominal supplies. Default conditions: TX input data rate = 491.52MSPS, $f_{\text{DAC}} = 11796.48\text{MSPS}$ (24x interpolation), mixed mode, 1st Nyquist zone output, PLL clock mode with $f_{\text{REF}} = 491.52\text{ MHz}$, $A_{\text{OUT}} = -1\text{ dBFS}$, DSA = 0 dB, Sin(x)/x enabled, DSA calibrated, TX Clock Dither Enabled, 8.1 GHz matching

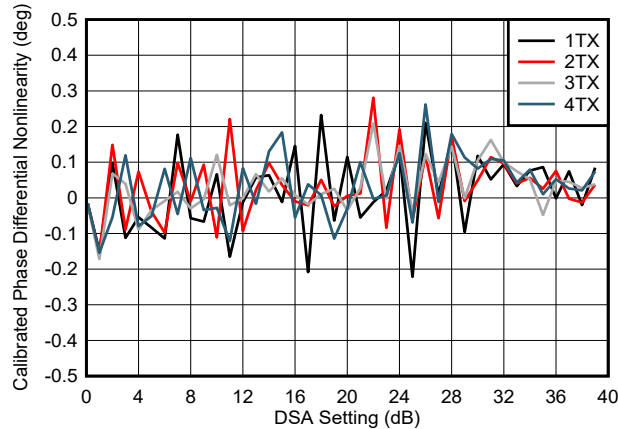

Figure 6-196. TX DSA Calibrated Phase Differential Nonlinearity at 8.11 GHz

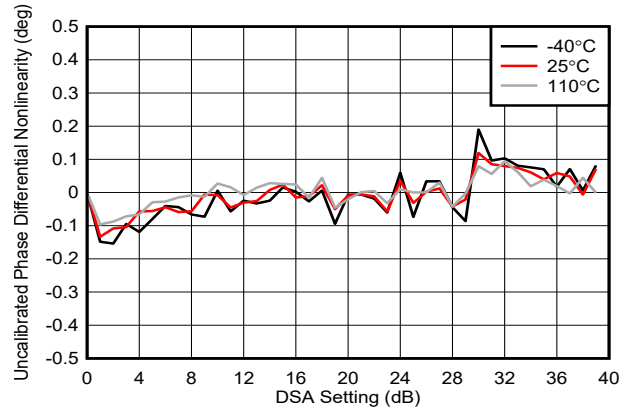

Figure 6-197. TX DSA Uncalibrated Phase Differential Nonlinearity at 8.11 GHz

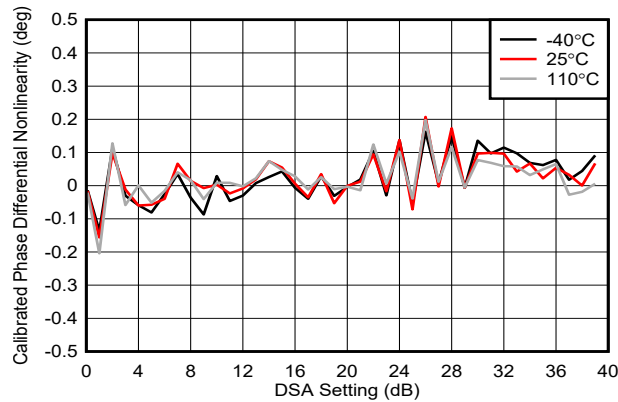

Figure 6-198. TX DSA Calibrated Phase Differential Nonlinearity at 8.11 GHz

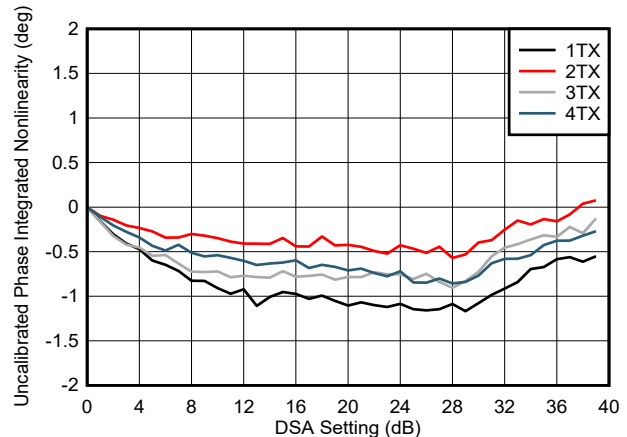

Figure 6-199. TX DSA Uncalibrated Phase Integrated Nonlinearity at 8.11 GHz

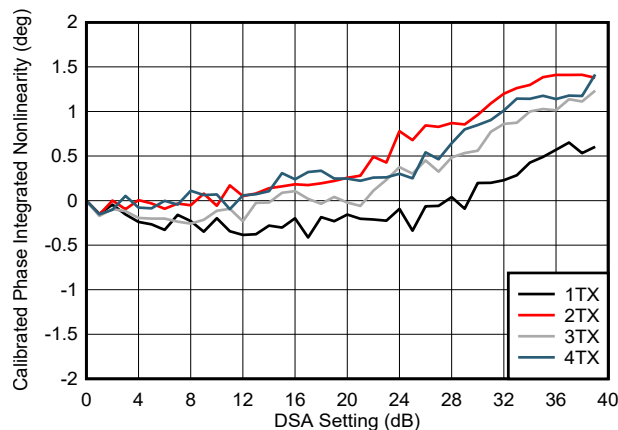

Figure 6-200. TX DSA Calibrated Phase Integrated Nonlinearity at 8.11 GHz

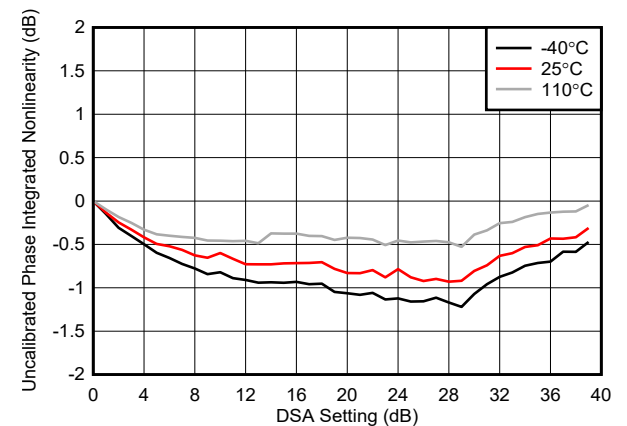

Figure 6-201. TX DSA Uncalibrated Phase Integrated Nonlinearity at 8.11 GHz

6.12.6 TX Typical Characteristics at 8.1 GHz (continued)

Typical values at $T_A = +25^\circ\text{C}$ with nominal supplies. Default conditions: TX input data rate = 491.52MSPS, $f_{\text{DAC}} = 11796.48\text{MSPS}$ (24x interpolation), mixed mode, 1st Nyquist zone output, PLL clock mode with $f_{\text{REF}} = 491.52\text{ MHz}$, $A_{\text{OUT}} = -1\text{ dBFS}$, DSA = 0 dB, Sin(x)/x enabled, DSA calibrated, TX Clock Dither Enabled, 8.1 GHz matching

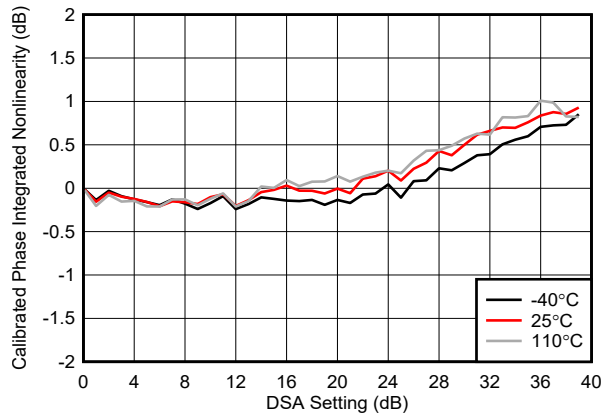

Figure 6-202. TX DSA Calibrated Phase Integrated Nonlinearity at 8.11 GHz

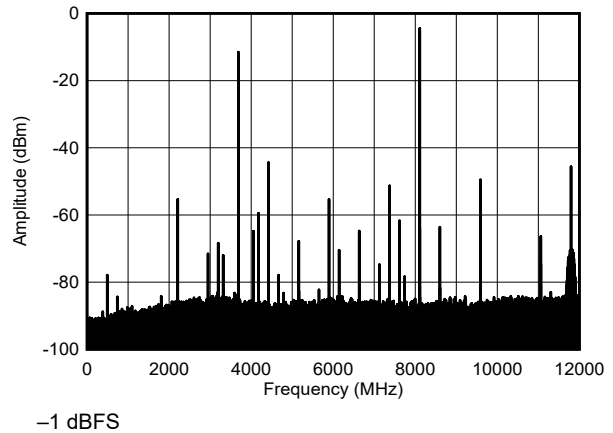

Figure 6-203. TX Single Tone Output Spectrum at 8.11 GHz

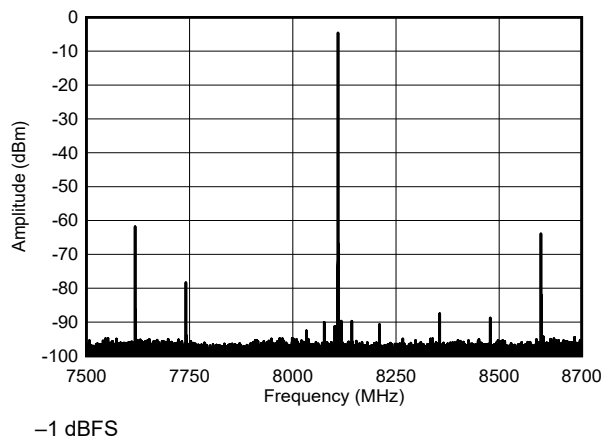

Figure 6-204. TX Single Tone Output Spectrum at 8.11 GHz

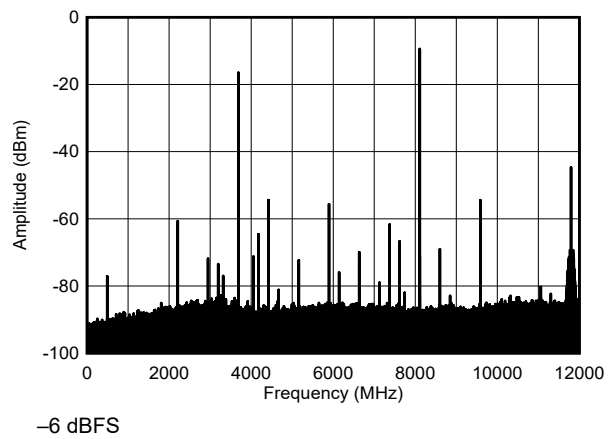

Figure 6-205. TX Single Tone Output Spectrum at 8.11 GHz

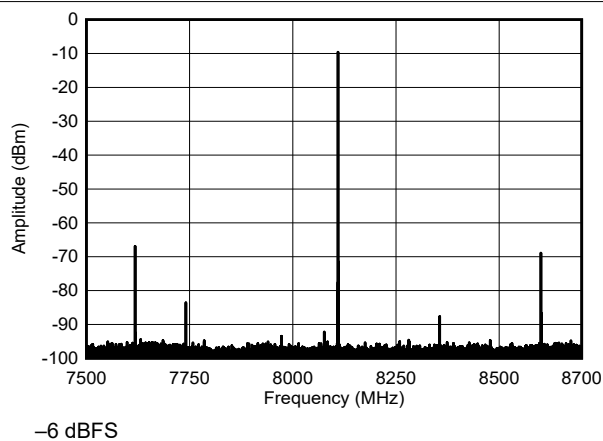

Figure 6-206. TX Single Tone Output Spectrum at 8.11 GHz

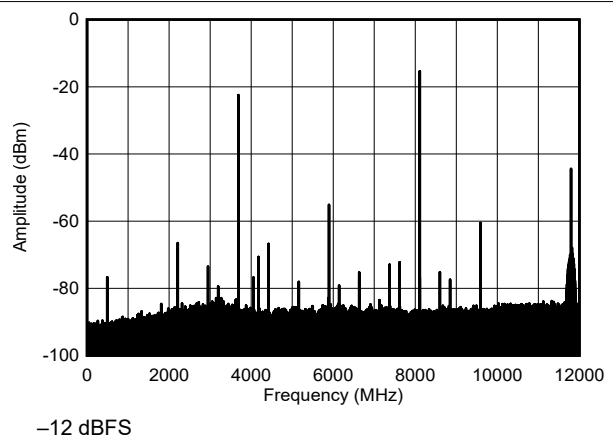
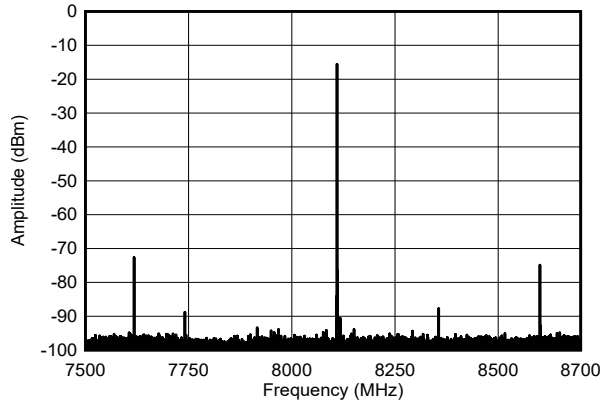

Figure 6-207. TX Single Tone Output Spectrum at 8.11 GHz

6.12.6 TX Typical Characteristics at 8.1 GHz (continued)

Typical values at $T_A = +25^\circ\text{C}$ with nominal supplies. Default conditions: TX input data rate = 491.52MSPS, $f_{\text{DAC}} = 11796.48\text{MSPS}$ (24x interpolation), mixed mode, 1st Nyquist zone output, PLL clock mode with $f_{\text{REF}} = 491.52\text{ MHz}$, $A_{\text{OUT}} = -1\text{ dBFS}$, DSA = 0 dB, Sin(x)/x enabled, DSA calibrated, TX Clock Dither Enabled, 8.1 GHz matching



-12 dBFS

Figure 6-208. TX Single Tone Output Spectrum at 8.11 GHz

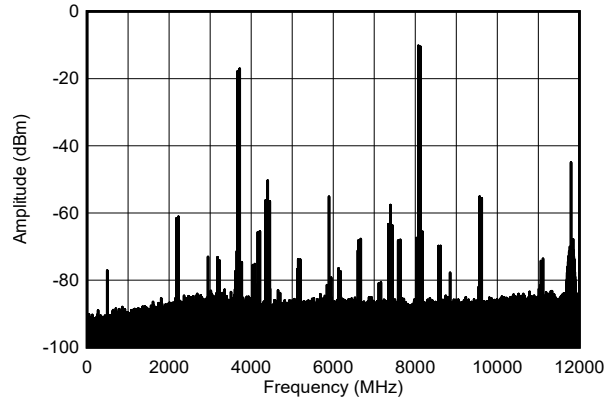

50-MHz tone spacing, -7 dBFS each tone

Figure 6-209. TX Dual Tone Output Spectrum at 8.11 GHz

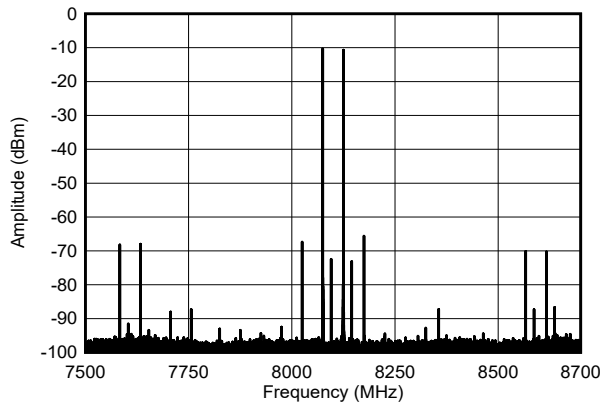

50-MHz tone spacing, -7 dBFS each tone

Figure 6-210. TX Dual Tone Output Spectrum at 8.11 GHz

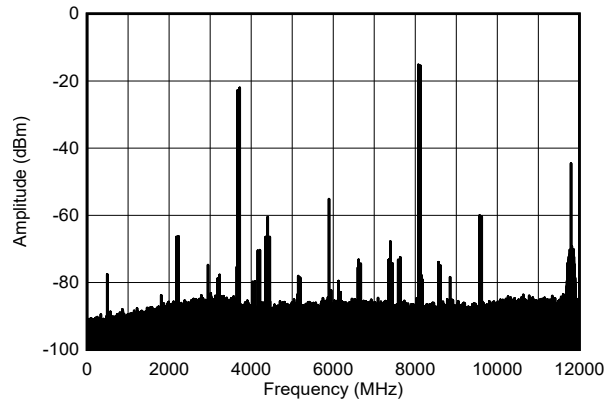

50-MHz tone spacing, -12 dBFS each tone

Figure 6-211. TX Dual Tone Output Spectrum at 8.11 GHz

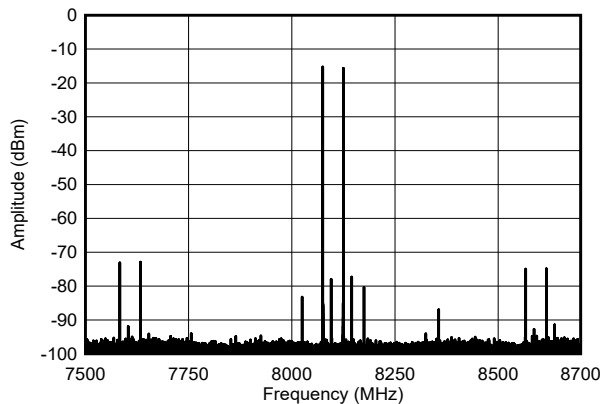

50-MHz tone spacing, -12 dBFS each tone

Figure 6-212. TX Dual Tone Output Spectrum at 8.11 GHz

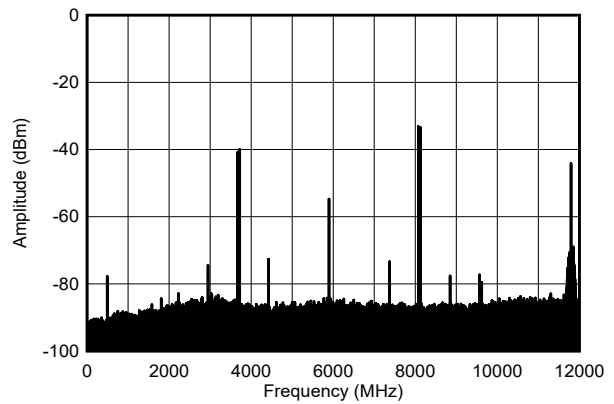

50-MHz tone spacing, -30 dBFS each tone

Figure 6-213. TX Dual Tone Output Spectrum at 8.11 GHz

6.12.6 TX Typical Characteristics at 8.1 GHz (continued)

Typical values at $T_A = +25^\circ\text{C}$ with nominal supplies. Default conditions: TX input data rate = 491.52MSPS, $f_{\text{DAC}} = 11796.48\text{MSPS}$ (24x interpolation), mixed mode, 1st Nyquist zone output, PLL clock mode with $f_{\text{REF}} = 491.52\text{ MHz}$, $A_{\text{OUT}} = -1\text{ dBFS}$, DSA = 0 dB, Sin(x)/x enabled, DSA calibrated, TX Clock Dither Enabled, 8.1 GHz matching

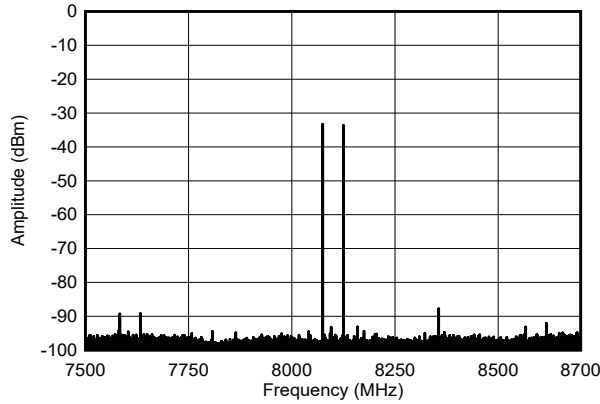

50-MHz tone spacing, -30 dBFS each tone

Figure 6-214. TX Dual Tone Output Spectrum at 8.11 GHz

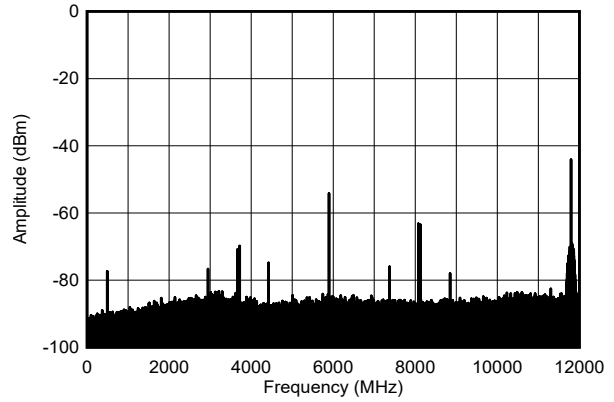

50-MHz tone spacing, -60 dBFS each tone

Figure 6-215. TX Dual Tone Output Spectrum at 8.11 GHz

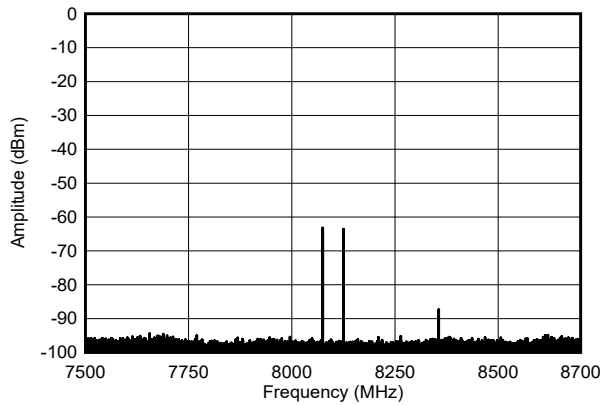

50-MHz tone spacing, -60 dBFS each tone

Figure 6-216. TX Dual Tone Output Spectrum at 8.11 GHz

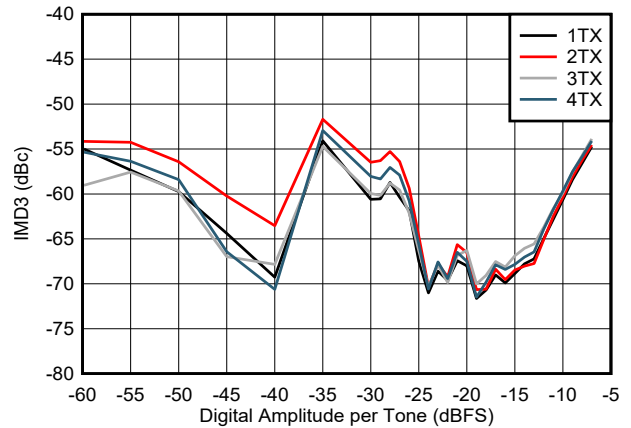

50-MHz tone spacing

Figure 6-217. TX IMD3 vs Digital Amplitude at 8.11 GHz

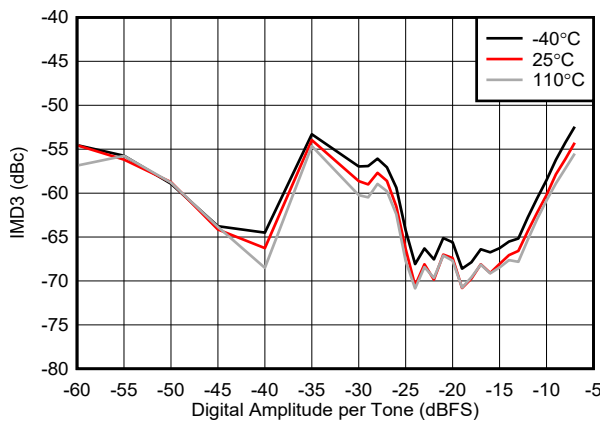

50-MHz tone spacing

Figure 6-218. TX IMD3 vs Digital Amplitude at 8.11 GHz

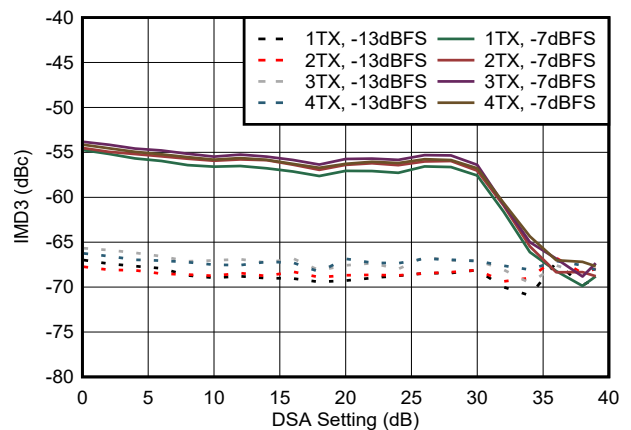

50-MHz tone spacing

Figure 6-219. TX IMD3 vs DSA Setting at 8.11 GHz

6.12.6 TX Typical Characteristics at 8.1 GHz (continued)

Typical values at $T_A = +25^\circ\text{C}$ with nominal supplies. Default conditions: TX input data rate = 491.52MSPS, $f_{\text{DAC}} = 11796.48\text{MSPS}$ (24x interpolation), mixed mode, 1st Nyquist zone output, PLL clock mode with $f_{\text{REF}} = 491.52\text{ MHz}$, $A_{\text{OUT}} = -1\text{ dBFS}$, DSA = 0 dB, Sin(x)/x enabled, DSA calibrated, TX Clock Dither Enabled, 8.1 GHz matching

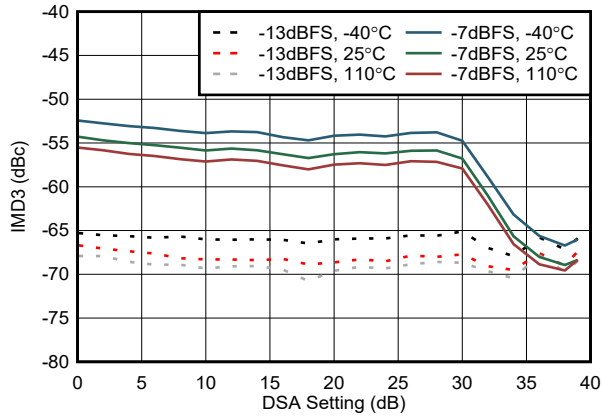

50-MHz tone spacing

Figure 6-220. TX IMD3 vs DSA Setting at 8.1 GHz

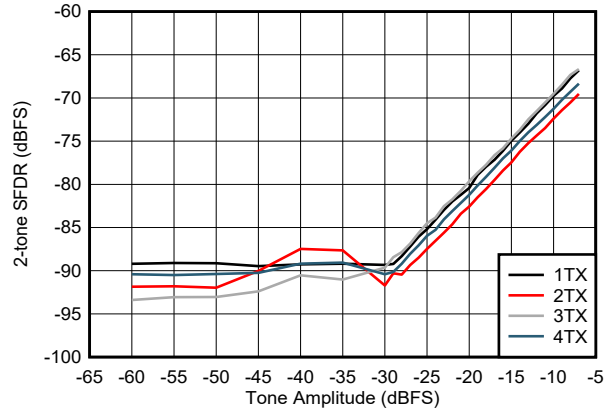

50-MHz tone spacing

Figure 6-221. TX 2-Tone SFDR vs Digital Amplitude at 8.1 GHz

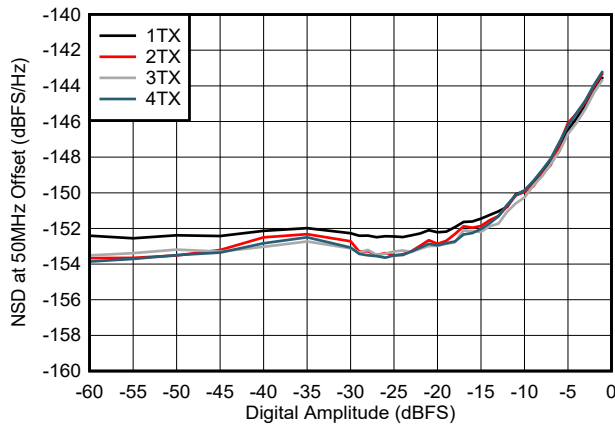

50-MHz offset

Figure 6-222. TX NSD vs Digital Amplitude at 8.1 GHz

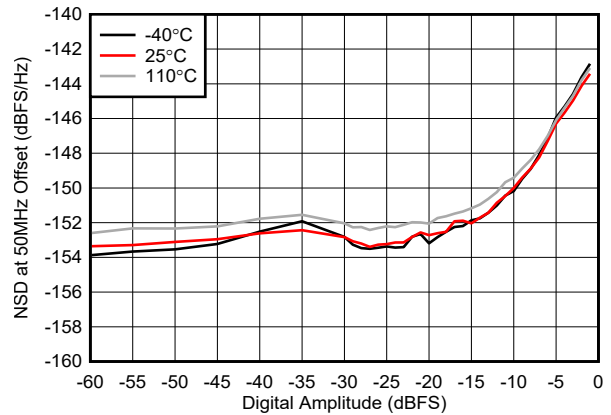

50-MHz offset

Figure 6-223. TX NSD vs Digital Amplitude at 8.1 GHz

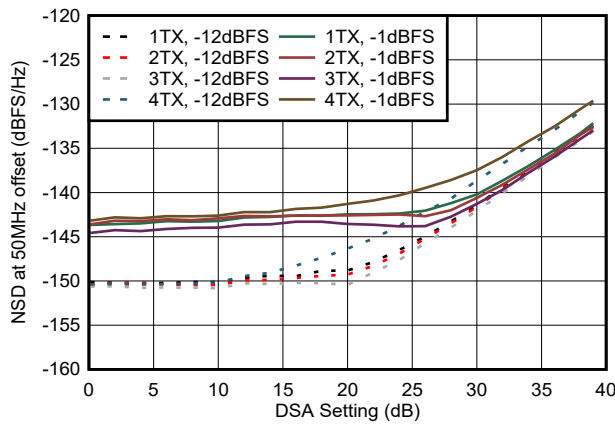

50-MHz offset

Figure 6-224. TX NSD vs DSA Setting at 8.1 GHz

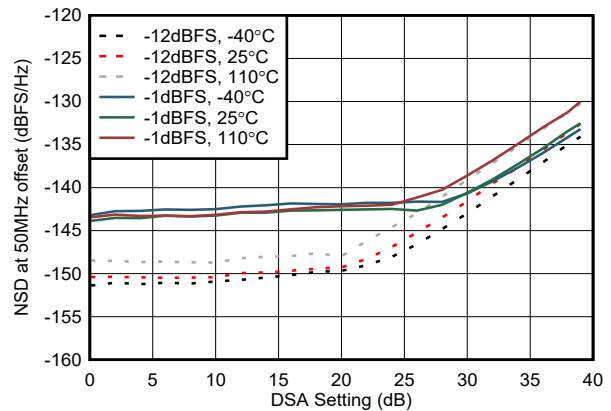

50-MHz offset

Figure 6-225. TX NSD vs DSA Setting at 8.1 GHz

6.12.6 TX Typical Characteristics at 8.1 GHz (continued)

Typical values at $T_A = +25^\circ\text{C}$ with nominal supplies. Default conditions: TX input data rate = 491.52MSPS, $f_{\text{DAC}} = 11796.48\text{MSPS}$ (24x interpolation), mixed mode, 1st Nyquist zone output, PLL clock mode with $f_{\text{REF}} = 491.52\text{ MHz}$, $A_{\text{OUT}} = -1\text{ dBFS}$, DSA = 0 dB, Sin(x)/x enabled, DSA calibrated, TX Clock Dither Enabled, 8.1 GHz matching

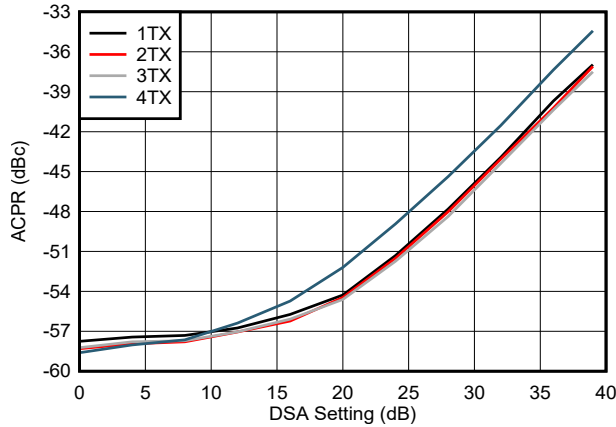

Figure 6-226. TX NR100MHz ACPR vs DSA Setting 8.11 GHz

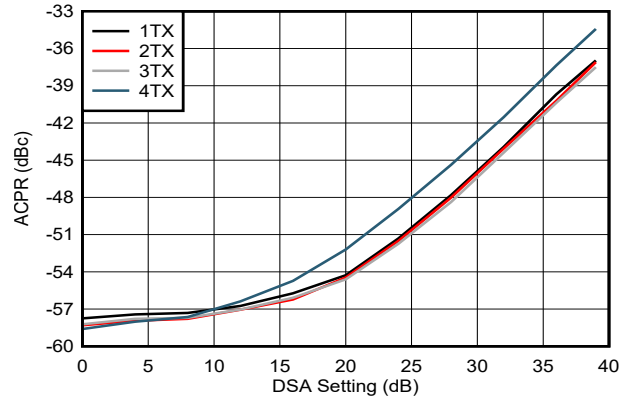

Figure 6-227. TX NR100MHz alt-ACPR vs DSA Setting 8.11 GHz

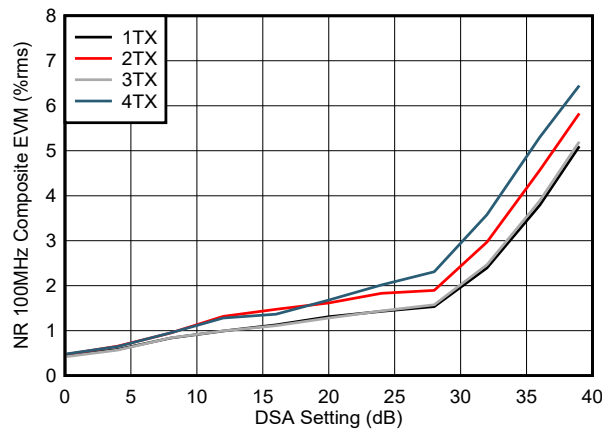

Figure 6-228. TX NR100MHz EVM vs DSA Setting 8.11 GHz

6.12.6 TX Typical Characteristics at 8.1 GHz (continued)

Typical values at $T_A = +25^\circ\text{C}$ with nominal supplies. Default conditions: TX input data rate = 491.52MSPS, $f_{DAC} = 11796.48\text{MSPS}$ (24x interpolation), mixed mode, 1st Nyquist zone output, PLL clock mode with $f_{REF} = 491.52\text{ MHz}$, $A_{OUT} = -1\text{ dBFS}$, DSA = 0 dB, Sin(x)/x enabled, DSA calibrated, TX Clock Dither Enabled, 8.1 GHz matching

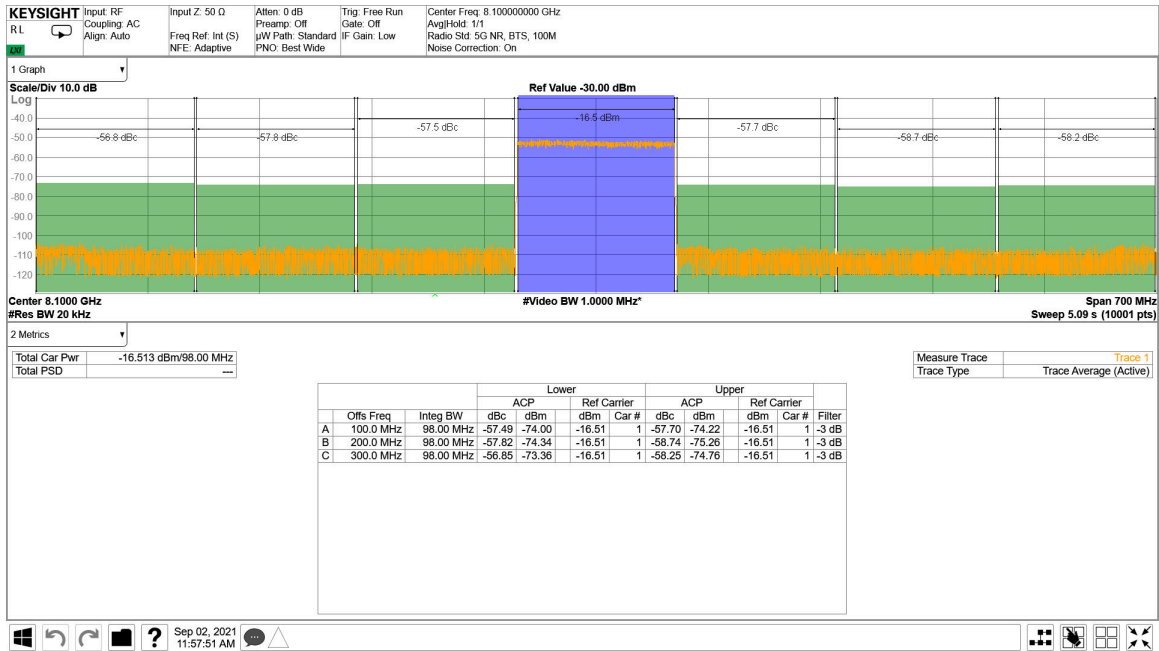

Figure 6-229. TX 100MHz NR Output Spectrum at 8.11 GHz

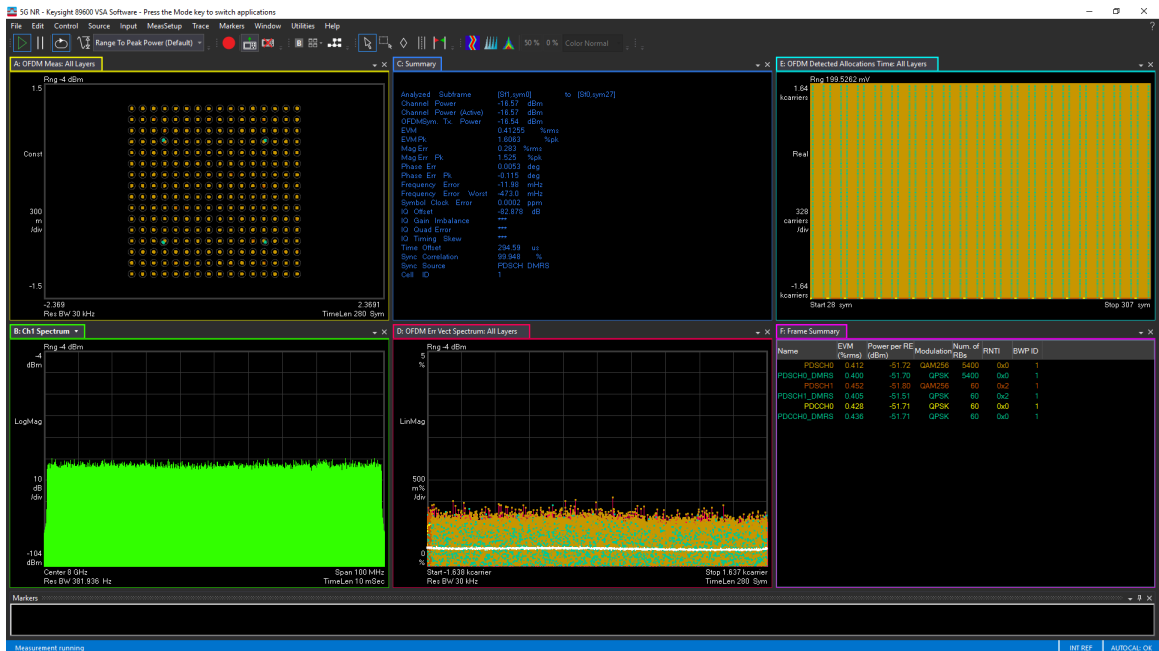

Figure 6-230. TX 100MHz NR EVM at 8.11 GHz

6.12.6 TX Typical Characteristics at 8.1 GHz (continued)

Typical values at $T_A = +25^\circ\text{C}$ with nominal supplies. Default conditions: TX input data rate = 491.52MSPS, $f_{DAC} = 11796.48\text{MSPS}$ (24x interpolation), mixed mode, 1st Nyquist zone output, PLL clock mode with $f_{REF} = 491.52\text{ MHz}$, $A_{OUT} = -1\text{ dBFS}$, DSA = 0 dB, Sin(x)/x enabled, DSA calibrated, TX Clock Dither Enabled, 8.1 GHz matching

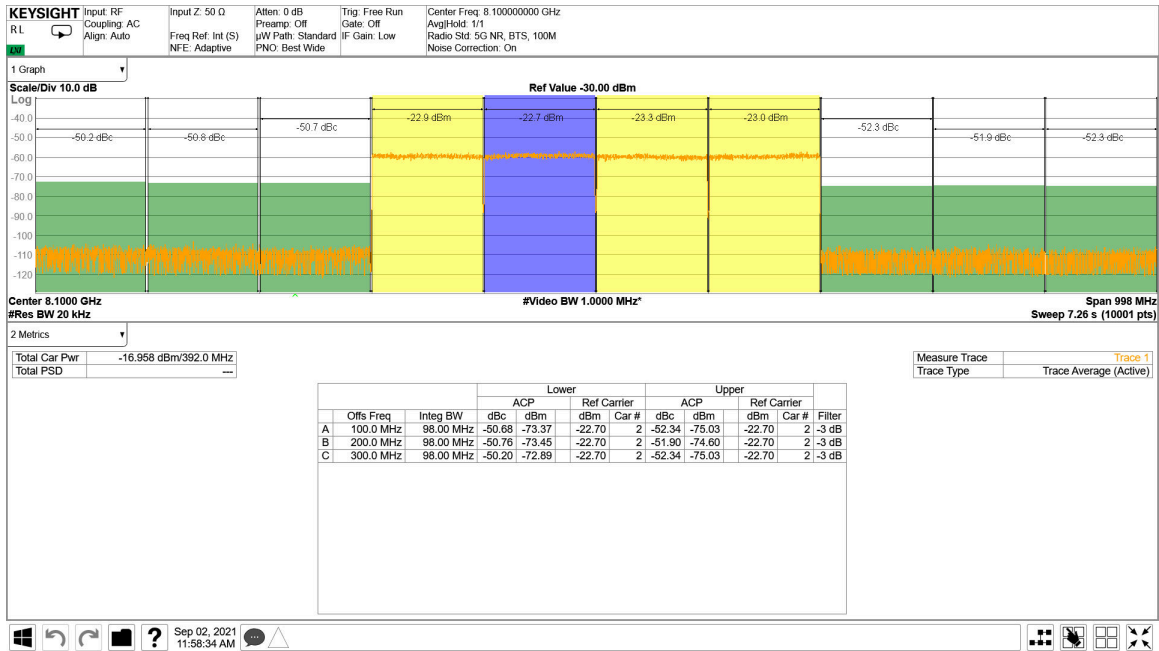

Figure 6-231. TX 4x100MHz NR Output Spectrum 8.11 GHz

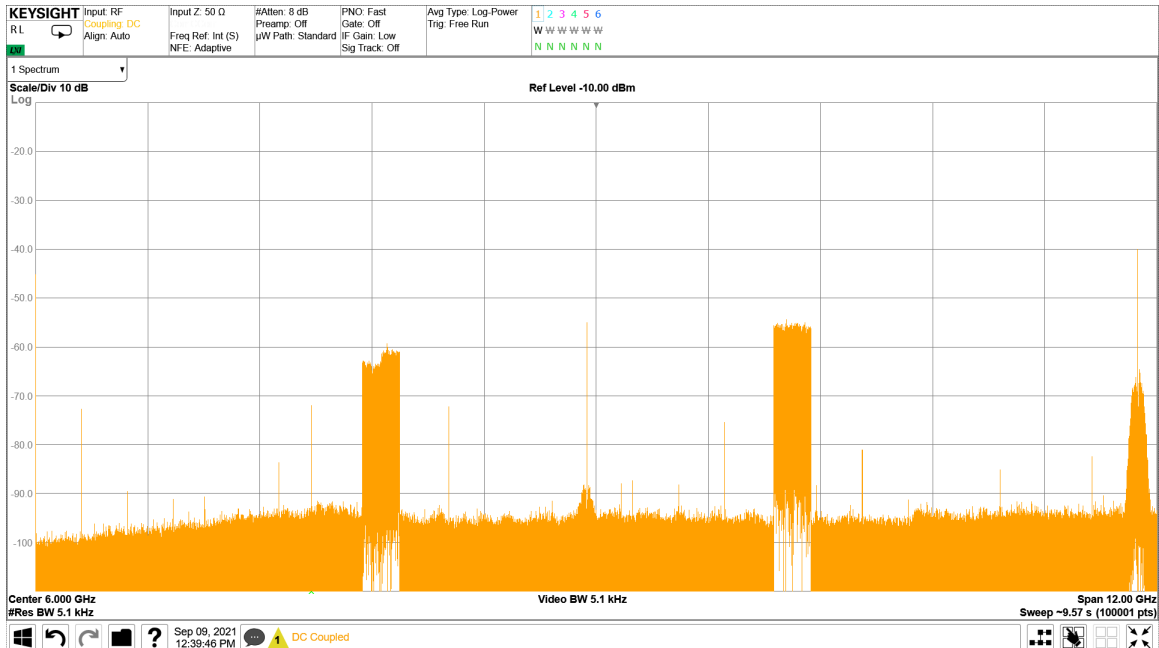
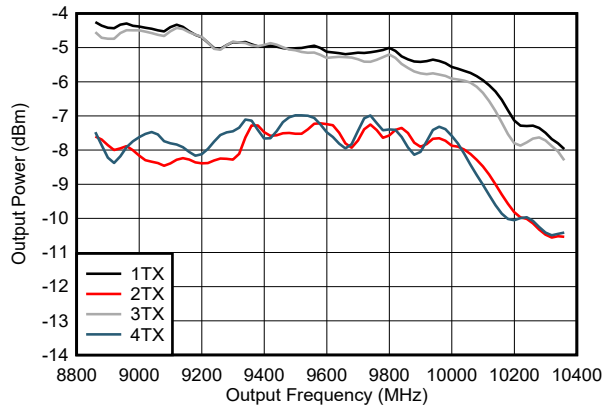

Figure 6-232. TX 4x100MHz NR Output Spectrum 8.11 GHz

6.12.7 TX Typical Characteristics at 9.6 GHz

Typical values at $T_A = +25^\circ\text{C}$ with nominal supplies. Default conditions: TX input data rate = 491.52MSPS, $f_{\text{DAC}} = 11796.48\text{MSPS}$ (8x interpolation), Mixed mode, 1st Nyquist zone output, PLL clock mode with $f_{\text{REF}} = 1474.56\text{ MHz}$, $A_{\text{OUT}} = -1\text{ dBFS}$, DSA = 0 dB, Sin(x)/x enabled, DSA calibrated, TX Clock Dither Enabled, 9.6 GHz matching



Includes PCB and cable losses.

Figure 6-233. TX Output Power vs Frequency at 9.61 GHz

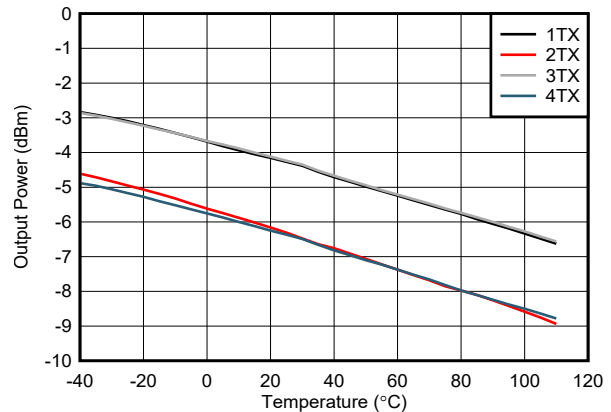

Includes PCB and cable losses.

Figure 6-234. TX Output Power vs Frequency at 9.61 GHz

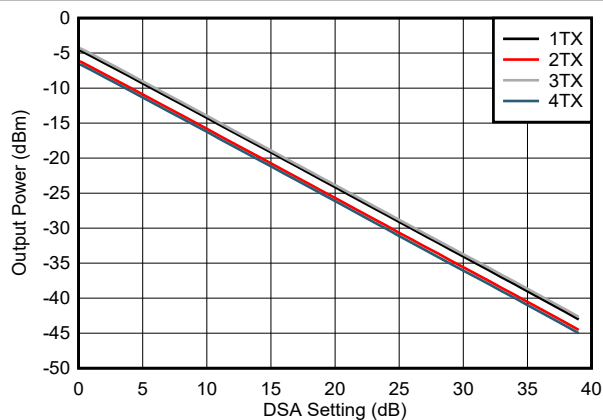

Includes PCB and cable losses.

Figure 6-235. TX Output Power vs DSA Setting at 9.61 GHz

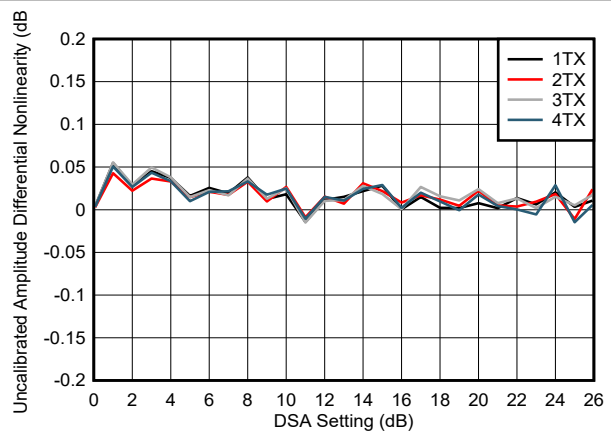

Figure 6-236. TX DSA Uncalibrated Amplitude Differential Nonlinearity

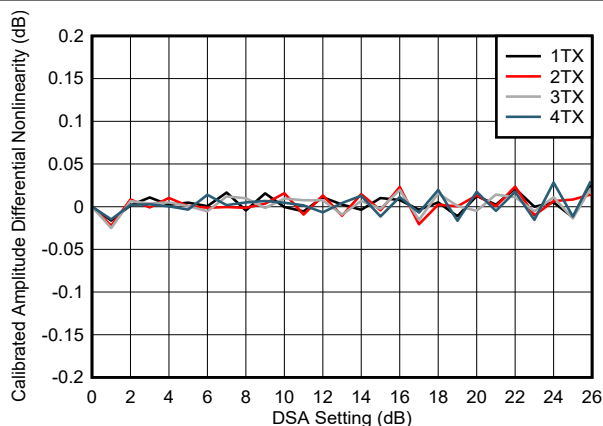

Figure 6-237. TX DSA Calibrated Amplitude Differential Nonlinearity

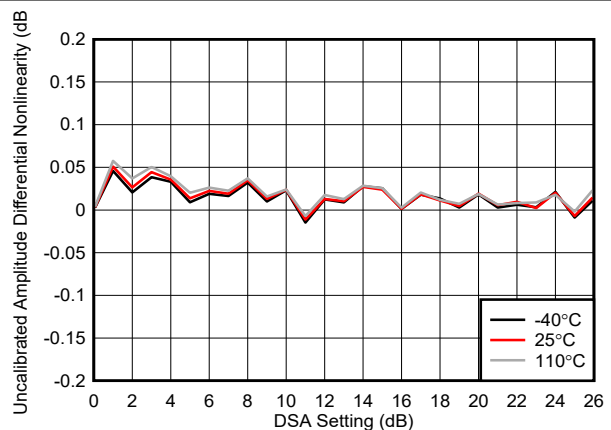

Figure 6-238. TX DSA Uncalibrated Amplitude Differential Nonlinearity

6.12.7 TX Typical Characteristics at 9.6 GHz (continued)

Typical values at $T_A = +25^\circ\text{C}$ with nominal supplies. Default conditions: TX input data rate = 491.52MSPS, $f_{\text{DAC}} = 11796.48\text{MSPS}$ (8x interpolation), Mixed mode, 1st Nyquist zone output, PLL clock mode with $f_{\text{REF}} = 1474.56\text{ MHz}$, $A_{\text{OUT}} = -1\text{ dBFS}$, DSA = 0 dB, Sin(x)/x enabled, DSA calibrated, TX Clock Dither Enabled, 9.6 GHz matching

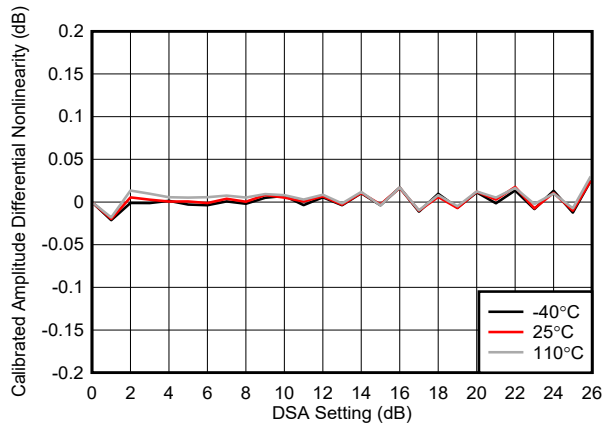

Figure 6-239. TX DSA Calibrated Amplitude Differential Nonlinearity

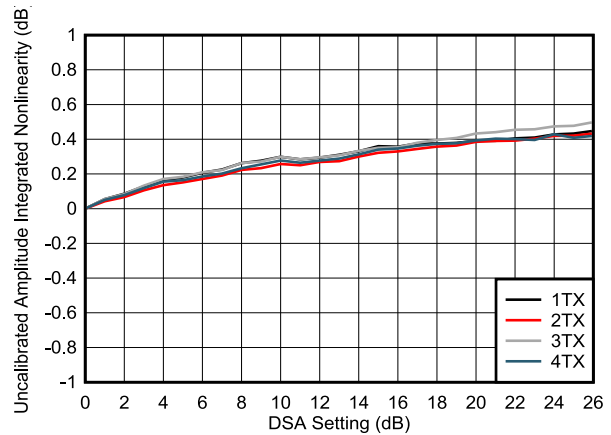

Figure 6-240. TX DSA Uncalibrated Amplitude Integrated Nonlinearity

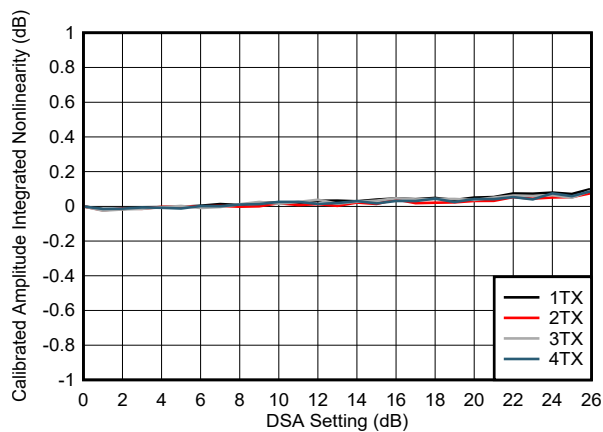

Figure 6-241. TX DSA Calibrated Amplitude Integrated Nonlinearity

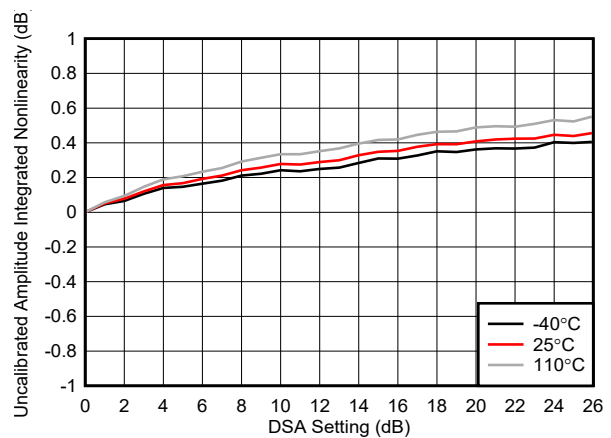

Figure 6-242. TX DSA Uncalibrated Amplitude Integrated Nonlinearity

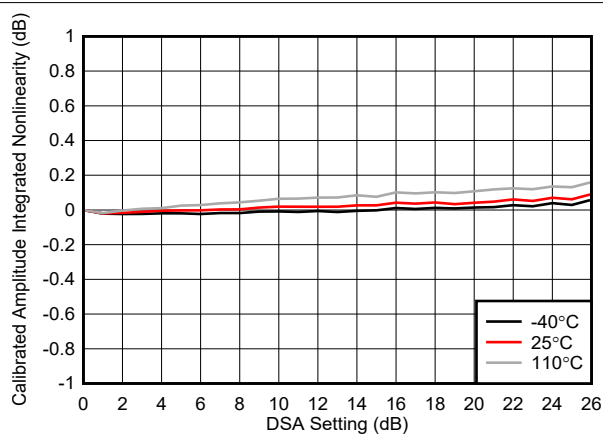

Figure 6-243. TX DSA Calibrated Amplitude Integrated Nonlinearity

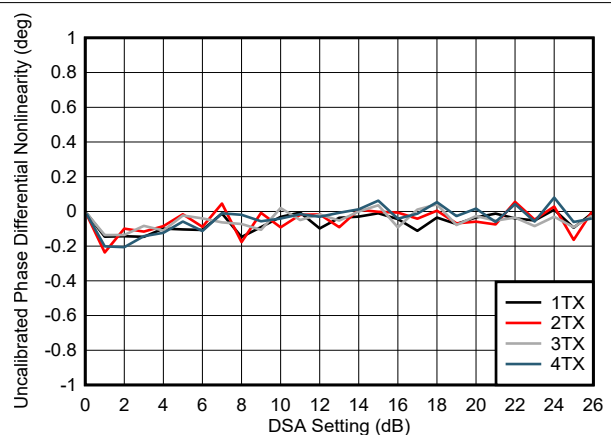

Figure 6-244. TX DSA Uncalibrated Phase Differential Nonlinearity

6.12.7 TX Typical Characteristics at 9.6 GHz (continued)

Typical values at $T_A = +25^\circ\text{C}$ with nominal supplies. Default conditions: TX input data rate = 491.52MSPS, $f_{\text{DAC}} = 11796.48\text{MSPS}$ (8x interpolation), Mixed mode, 1st Nyquist zone output, PLL clock mode with $f_{\text{REF}} = 1474.56\text{ MHz}$, $A_{\text{OUT}} = -1\text{ dBFS}$, DSA = 0 dB, Sin(x)/x enabled, DSA calibrated, TX Clock Dither Enabled, 9.6 GHz matching

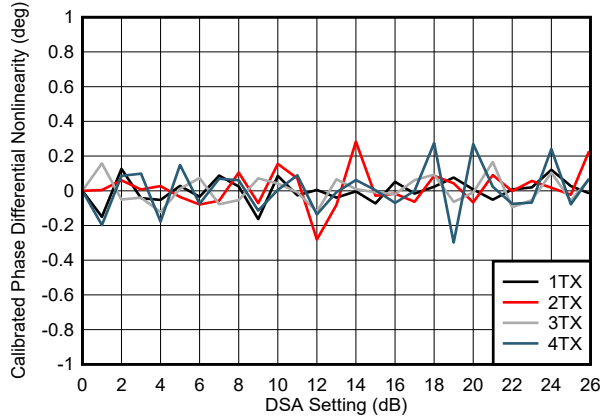

Figure 6-245. TX DSA Calibrated Phase Differential Nonlinearity

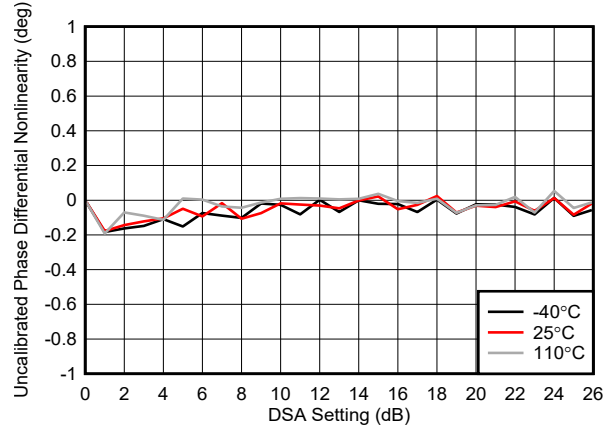

Figure 6-246. TX DSA Uncalibrated Phase Differential Nonlinearity

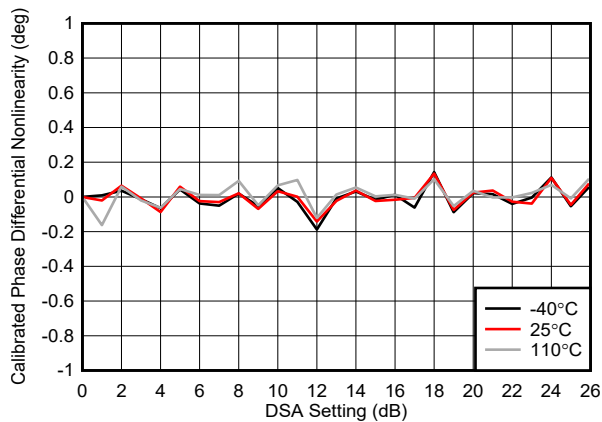

Figure 6-247. TX DSA Calibrated Phase Differential Nonlinearity

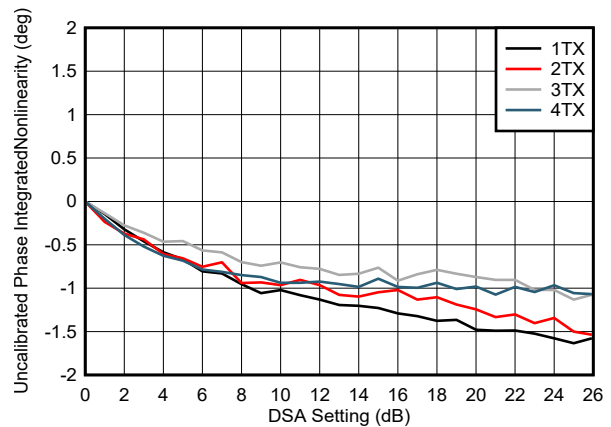

Figure 6-248. TX DSA Uncalibrated Phase Integrated Nonlinearity

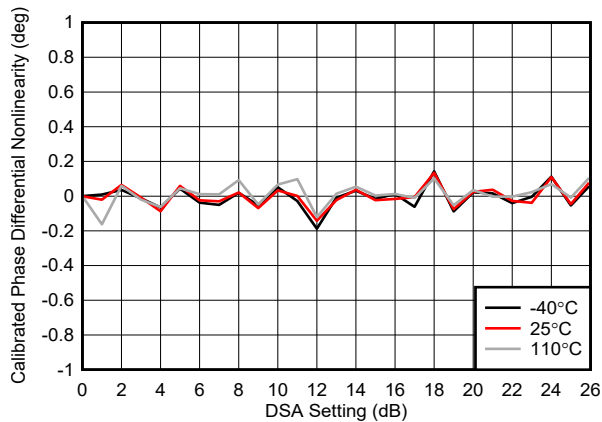

Figure 6-249. TX DSA Calibrated Phase Integrated Nonlinearity

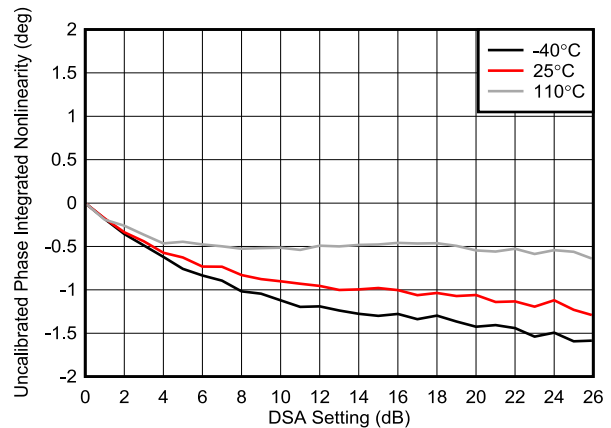

Figure 6-250. TX DSA Uncalibrated Phase Integrated Nonlinearity

6.12.7 TX Typical Characteristics at 9.6 GHz (continued)

Typical values at $T_A = +25^\circ\text{C}$ with nominal supplies. Default conditions: TX input data rate = 491.52MSPS, $f_{\text{DAC}} = 11796.48\text{MSPS}$ (8x interpolation), Mixed mode, 1st Nyquist zone output, PLL clock mode with $f_{\text{REF}} = 1474.56\text{ MHz}$, $A_{\text{OUT}} = -1\text{ dBFS}$, DSA = 0 dB, $\text{Sin}(x)/x$ enabled, DSA calibrated, TX Clock Dither Enabled, 9.6 GHz matching

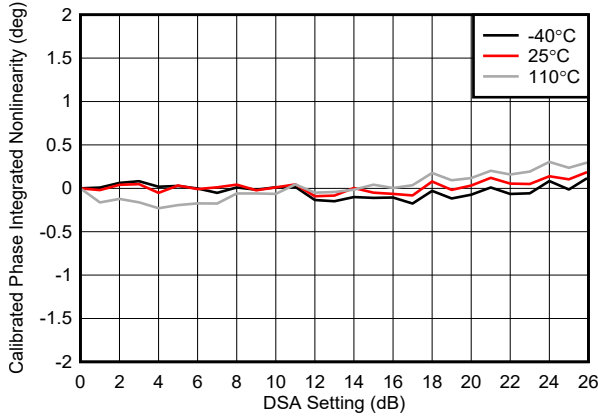
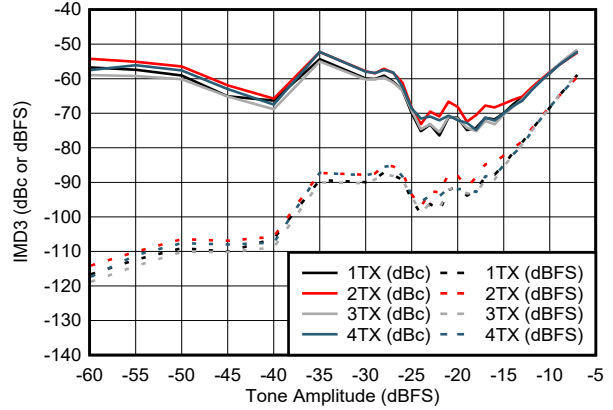
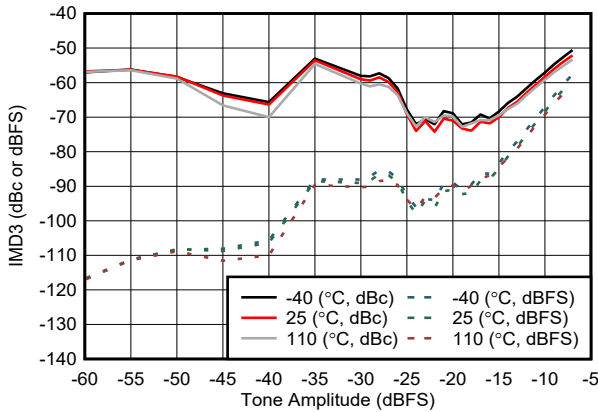

Figure 6-251. TX DSA Calibrated Amplitude Integrated Nonlinearity



50-MHz tone spacing

Figure 6-252. TX IMD3 vs Digital Amplitude at 9.61 GHz



50-MHz tone spacing

Figure 6-253. TX IMD3 vs Digital Amplitude at 9.61 GHz

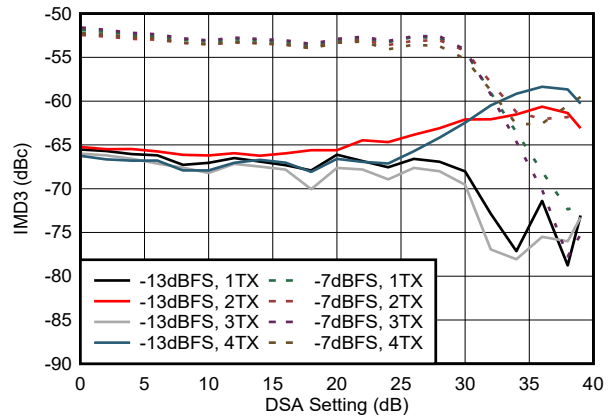

50-MHz tone spacing

Figure 6-254. TX IMD3 vs DSA Setting at 9.61 GHz

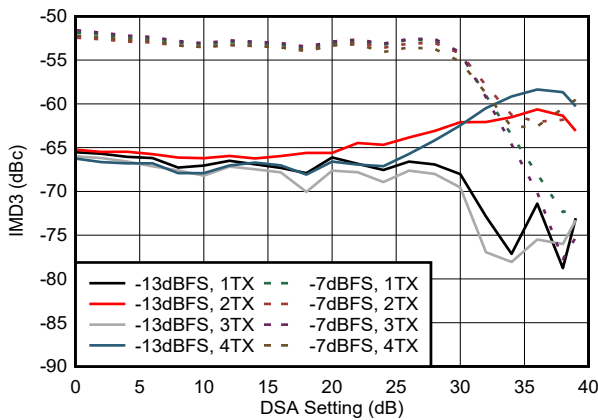

50-MHz tone spacing

Figure 6-255. TX IMD3 vs DSA Setting at 9.61 GHz

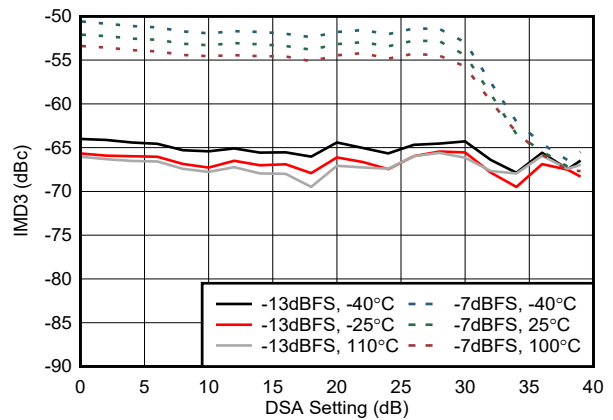

50-MHz tone spacing

Figure 6-256. TX IMD3 vs DSA Setting at 9.61 GHz

6.12.7 TX Typical Characteristics at 9.6 GHz (continued)

Typical values at $T_A = +25^\circ\text{C}$ with nominal supplies. Default conditions: TX input data rate = 491.52MSPS, $f_{\text{DAC}} = 11796.48\text{MSPS}$ (8x interpolation), Mixed mode, 1st Nyquist zone output, PLL clock mode with $f_{\text{REF}} = 1474.56\text{ MHz}$, $A_{\text{OUT}} = -1\text{ dBFS}$, DSA = 0 dB, Sin(x)/x enabled, DSA calibrated, TX Clock Dither Enabled, 9.6 GHz matching

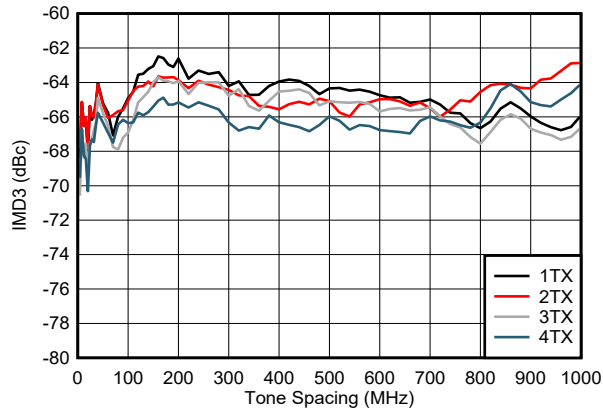

Figure 6-257. TX IMD3 vs Tone Spacing at 9.61 GHz

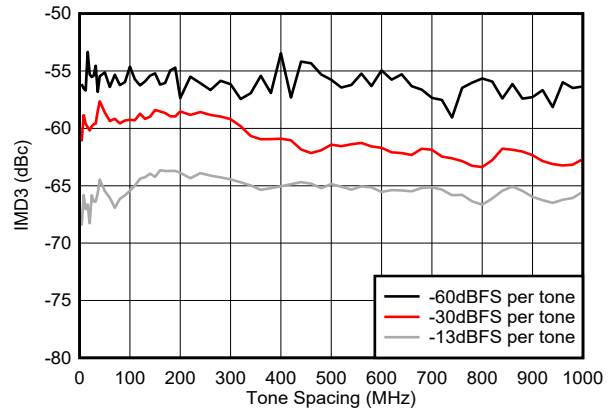

Figure 6-258. TX IMD3 vs Tone Spacing at 9.61 GHz

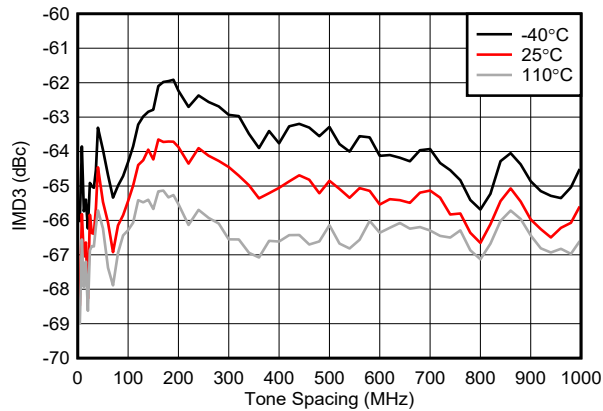

Figure 6-259. TX IMD3 vs Tone Spacing at 9.61 GHz

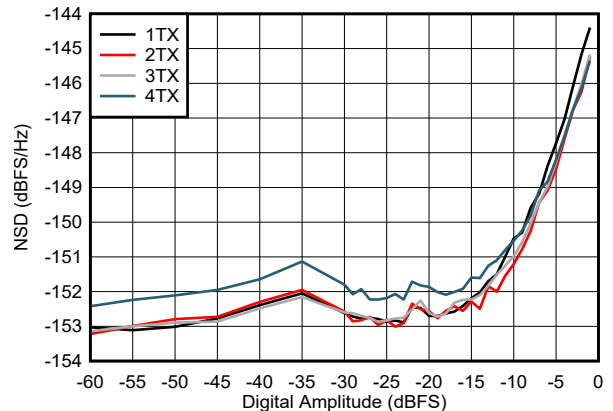

Figure 6-260. TX NSD vs Digital Amplitude at 9.61 GHz

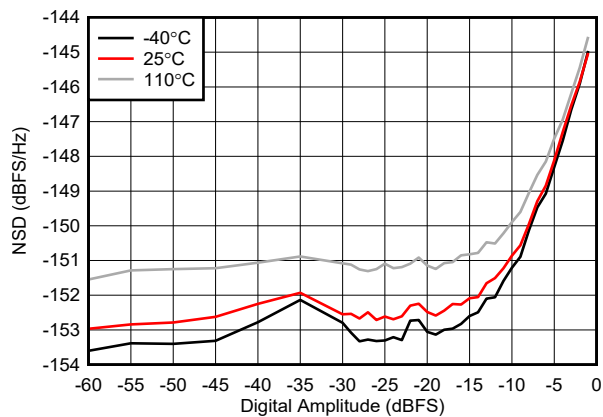

Figure 6-261. TX NSD vs Digital Amplitude at 9.61 GHz

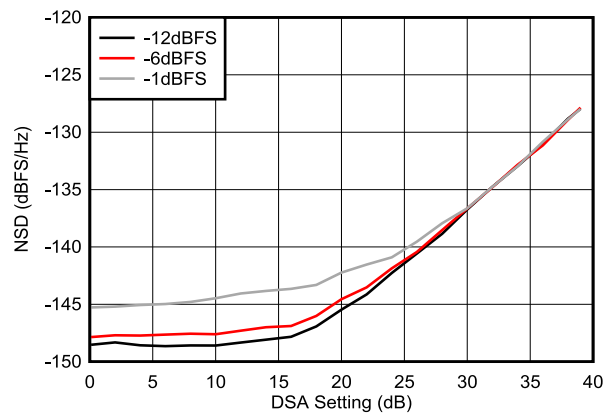

Figure 6-262. TX NSD vs DSA Setting at 9.61 GHz

6.12.7 TX Typical Characteristics at 9.6 GHz (continued)

Typical values at $T_A = +25^\circ\text{C}$ with nominal supplies. Default conditions: TX input data rate = 491.52MSPS, $f_{\text{DAC}} = 11796.48\text{MSPS}$ (8x interpolation), Mixed mode, 1st Nyquist zone output, PLL clock mode with $f_{\text{REF}} = 1474.56\text{ MHz}$, $A_{\text{OUT}} = -1\text{ dBFS}$, DSA = 0 dB, Sin(x)/x enabled, DSA calibrated, TX Clock Dither Enabled, 9.6 GHz matching

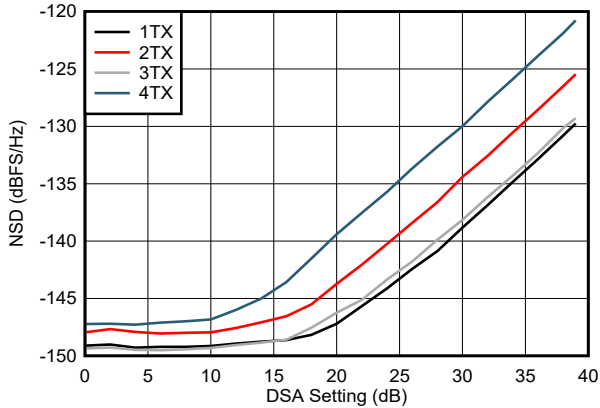

Figure 6-263. TX NSD vs DSA Setting at 9.6 GHz

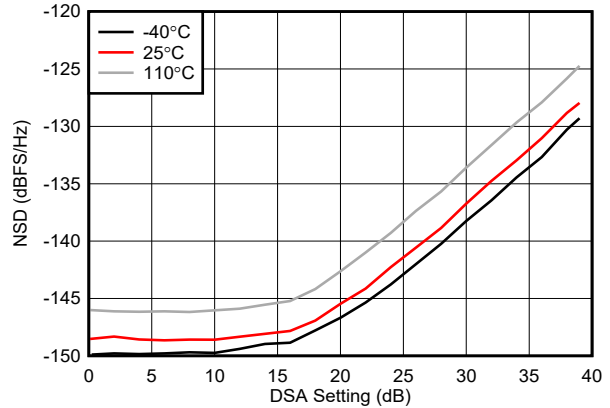
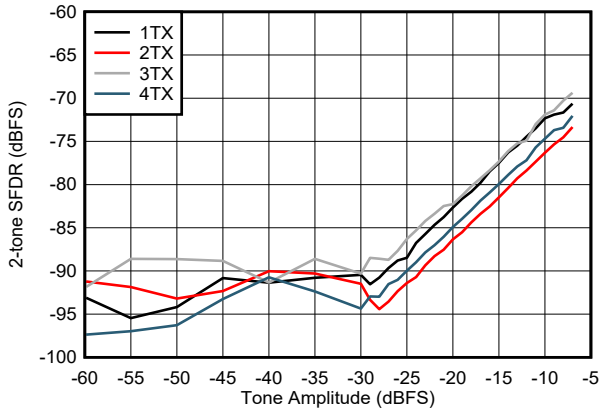
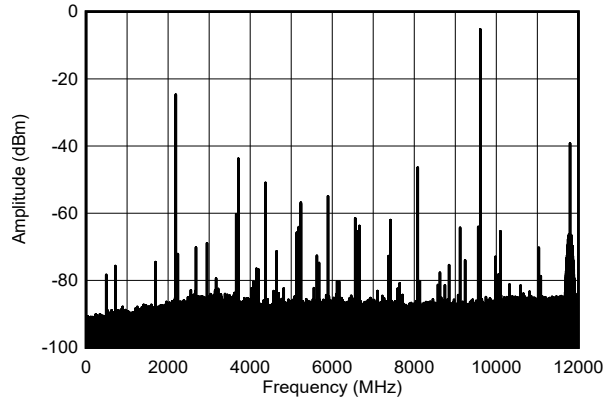

Figure 6-264. TX NSD vs DSA Setting at 9.6 GHz



50-MHz tone spacing

Figure 6-265. TX 2-tone SFDR vs Digital Amplitude at 9.6 GHz



Includes PCB and cable losses.

Figure 6-266. TX Single Tone Spectrum at 9.61 GHz and -1dBFS (wideband)

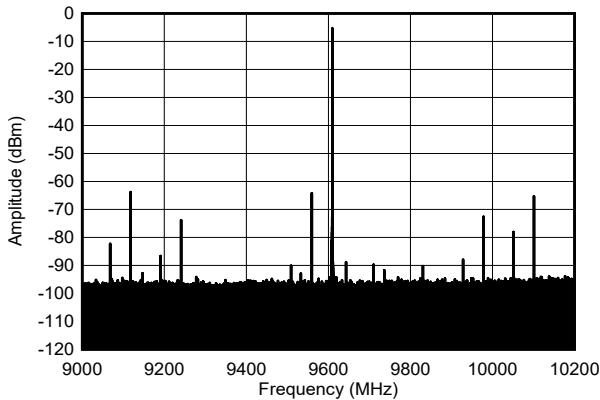

Includes PCB and cable losses.

Figure 6-267. TX Single Tone Spectrum at 9.61 GHz and -1dBFS (1.2GHz BW)

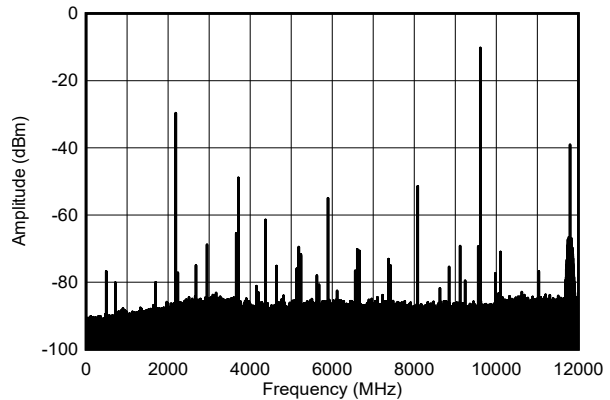

Includes PCB and cable losses.

Figure 6-268. TX Single Tone Spectrum at 9.61 GHz and -6dBFS (wideband)

6.12.7 TX Typical Characteristics at 9.6 GHz (continued)

Typical values at $T_A = +25^\circ\text{C}$ with nominal supplies. Default conditions: TX input data rate = 491.52MSPS, $f_{\text{DAC}} = 11796.48\text{MSPS}$ (8x interpolation), Mixed mode, 1st Nyquist zone output, PLL clock mode with $f_{\text{REF}} = 1474.56\text{ MHz}$, $A_{\text{OUT}} = -1\text{ dBFS}$, DSA = 0 dB, Sin(x)/x enabled, DSA calibrated, TX Clock Dither Enabled, 9.6 GHz matching

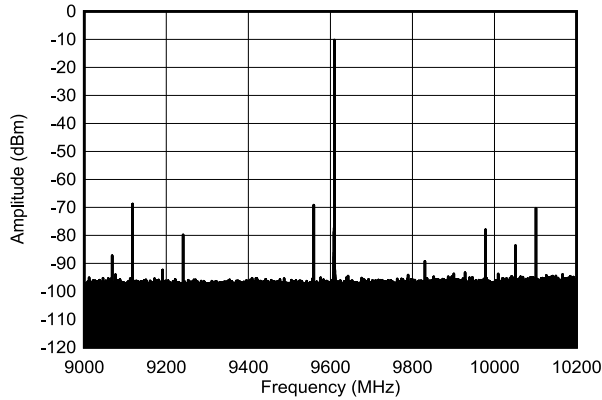

Includes PCB and cable losses.

Figure 6-269. TX Single Tone Spectrum at 9.61 GHz and -6dBFS (1.2GHz BW)

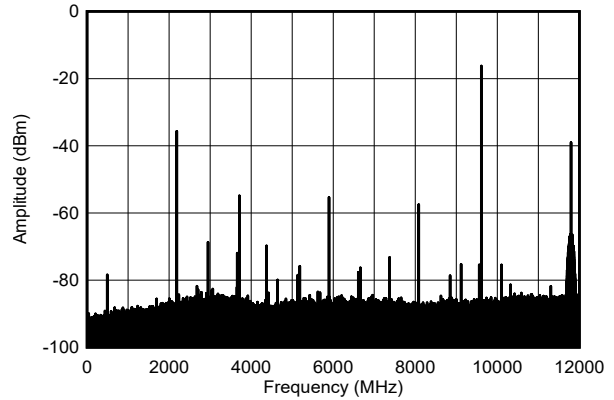

Includes PCB and cable losses.

Figure 6-270. TX Single Tone Spectrum at 9.61 GHz and -12dBFS (wideband)

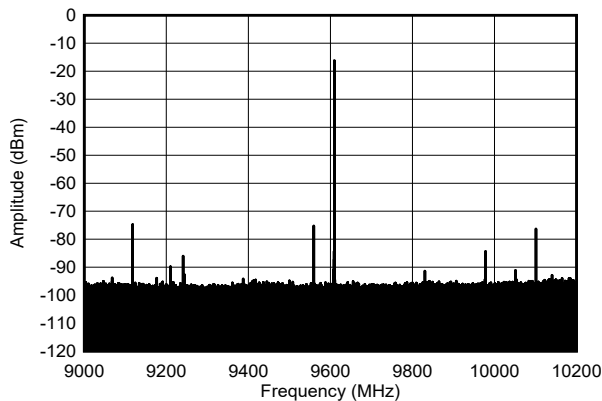

Includes PCB and cable losses.

Figure 6-271. TX Single Tone Spectrum at 9.61 GHz and -12dBFS (1.2GHz BW)

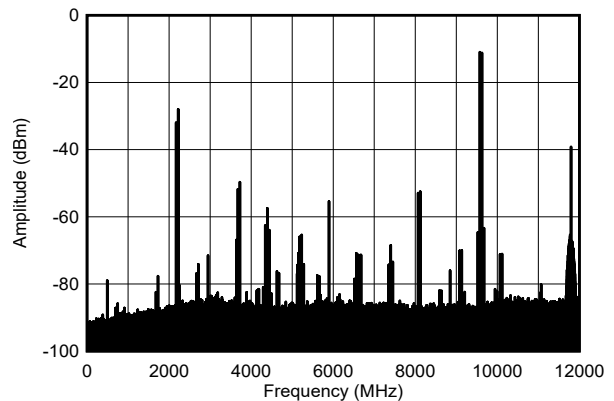

Includes PCB and cable losses, 50-MHz tone spacing.

Figure 6-272. TX 2-Tone Spectrum at 9.61 GHz and -7dBFS (wideband)

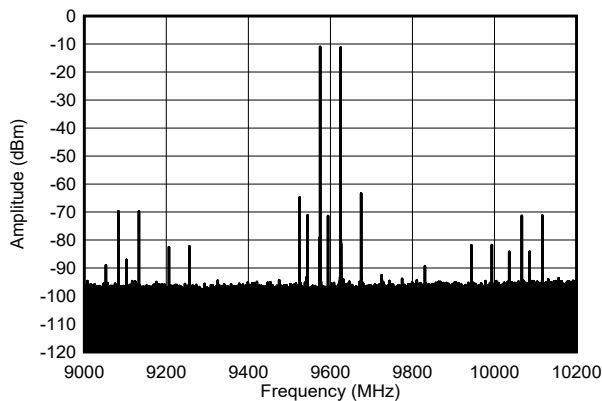

Includes PCB and cable losses, 50-MHz tone spacing.

Figure 6-273. TX 2-Tone Spectrum at 9.61 GHz and -7dBFS (1.2GHz BW)

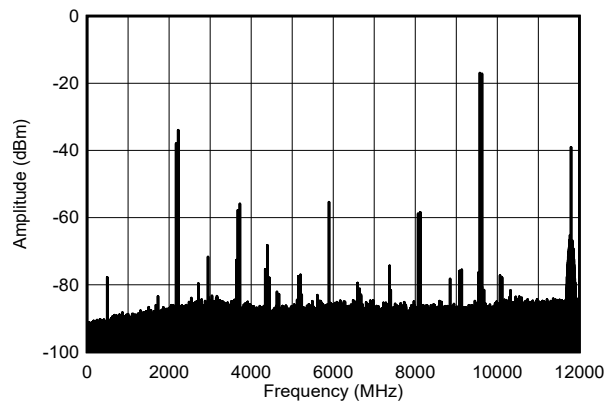

Includes PCB and cable losses, 50-MHz tone spacing.

Figure 6-274. TX 2-Tone Spectrum at 9.61 GHz and -13dBFS (wideband)

6.12.7 TX Typical Characteristics at 9.6 GHz (continued)

Typical values at $T_A = +25^\circ\text{C}$ with nominal supplies. Default conditions: TX input data rate = 491.52MSPS, $f_{\text{DAC}} = 11796.48\text{MSPS}$ (8x interpolation), Mixed mode, 1st Nyquist zone output, PLL clock mode with $f_{\text{REF}} = 1474.56\text{ MHz}$, $A_{\text{OUT}} = -1\text{ dBFS}$, DSA = 0 dB, Sin(x)/x enabled, DSA calibrated, TX Clock Dither Enabled, 9.6 GHz matching

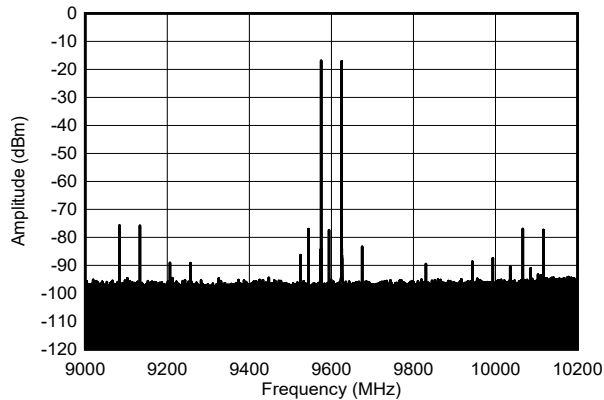

Includes PCB and cable losses, 50-MHz tone spacing.

Figure 6-275. TX 2-Tone Spectrum at 9.61 GHz and -13dBFS Each (1.2GHz BW)

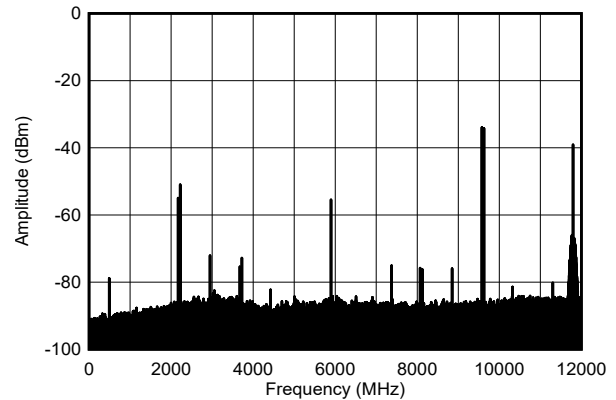

Includes PCB and cable losses, 50-MHz tone spacing.

Figure 6-276. TX 2-Tone Spectrum at 9.61 GHz and -30dBFS Each (wideband)

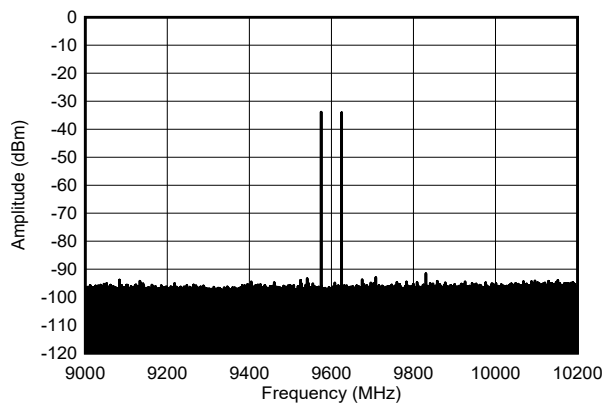

Includes PCB and cable losses, 50-MHz tone spacing.

Figure 6-277. TX 2-Tone Spectrum at 9.61 GHz and -30dBFS Each (1.2GHz BW)

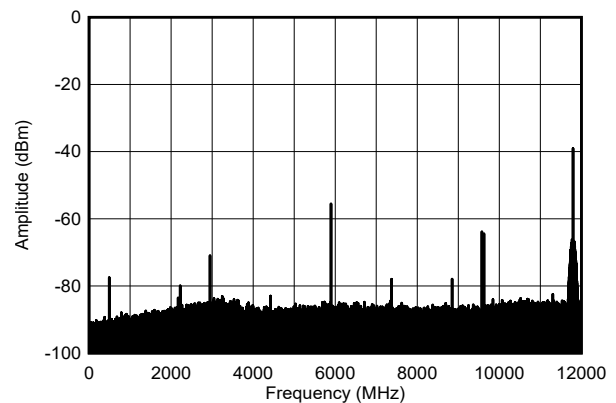

Includes PCB and cable losses, 50-MHz tone spacing.

Figure 6-278. TX 2-Tone Spectrum at 9.61 GHz and -60dBFS Each (wideband)

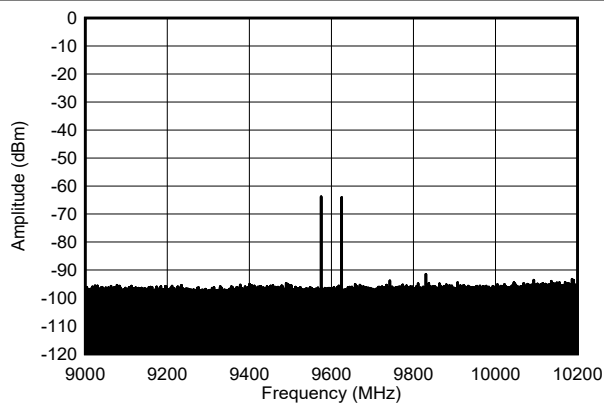

Includes PCB and cable losses, 50-MHz tone spacing.

Figure 6-279. TX 2-Tone Spectrum at 9.61 GHz and -60dBFS Each (1.2GHz BW)

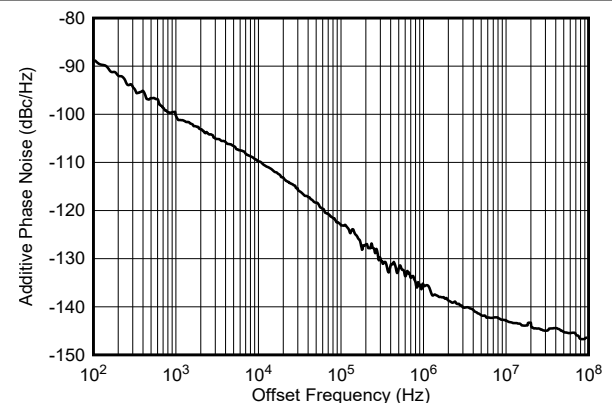

Single sideband, external clock mode, input clock phase noise removed

Figure 6-280. TX Additive Phase Noise vs Offset Frequency at 9.61 GHz

6.12.7 TX Typical Characteristics at 9.6 GHz (continued)

Typical values at $T_A = +25^\circ\text{C}$ with nominal supplies. Default conditions: TX input data rate = 491.52MSPS, $f_{\text{DAC}} = 11796.48\text{MSPS}$ (8x interpolation), Mixed mode, 1st Nyquist zone output, PLL clock mode with $f_{\text{REF}} = 1474.56\text{ MHz}$, $A_{\text{OUT}} = -1\text{ dBFS}$, DSA = 0 dB, Sin(x)/x enabled, DSA calibrated, TX Clock Dither Enabled, 9.6 GHz matching

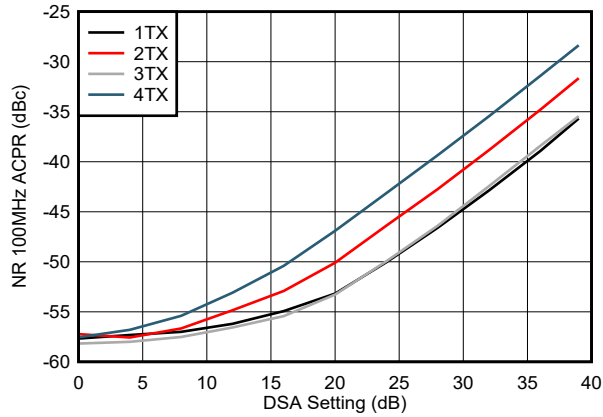

Figure 6-281. TX NR100MHz ACPR vs DSA Setting at 9.61 GHz

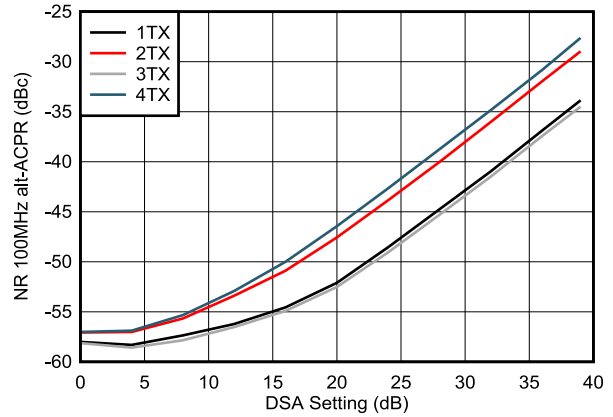

Figure 6-282. TX NR100MHz alt-ACPR vs DSA Setting at 9.61 GHz

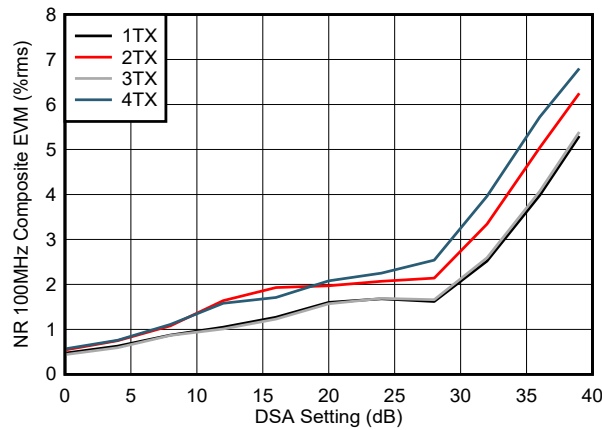
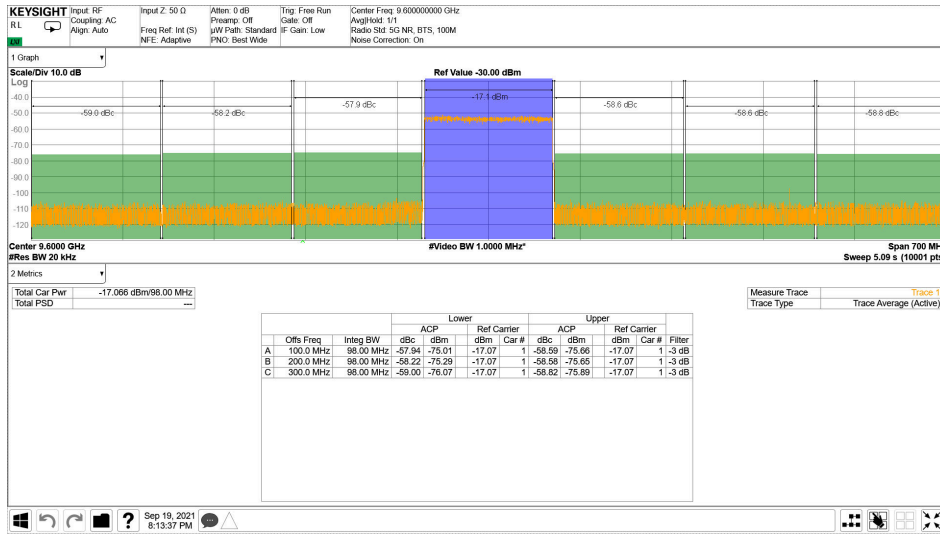

Figure 6-283. TX NR100MHz EVM vs DSA Setting at 9.61 GHz

6.12.7 TX Typical Characteristics at 9.6 GHz (continued)

Typical values at $T_A = +25^\circ\text{C}$ with nominal supplies. Default conditions: TX input data rate = 491.52MSPS, $f_{DAC} = 11796.48\text{MSPS}$ (8x interpolation), Mixed mode, 1st Nyquist zone output, PLL clock mode with $f_{REF} = 1474.56\text{ MHz}$, $A_{OUT} = -1\text{ dBFS}$, DSA = 0 dB, Sin(x)/x enabled, DSA calibrated, TX Clock Dither Enabled, 9.6 GHz matching



Includes PCB and cable losses.

Figure 6-284. TX NR100MHz Output Spectrum at 9.61 GHz

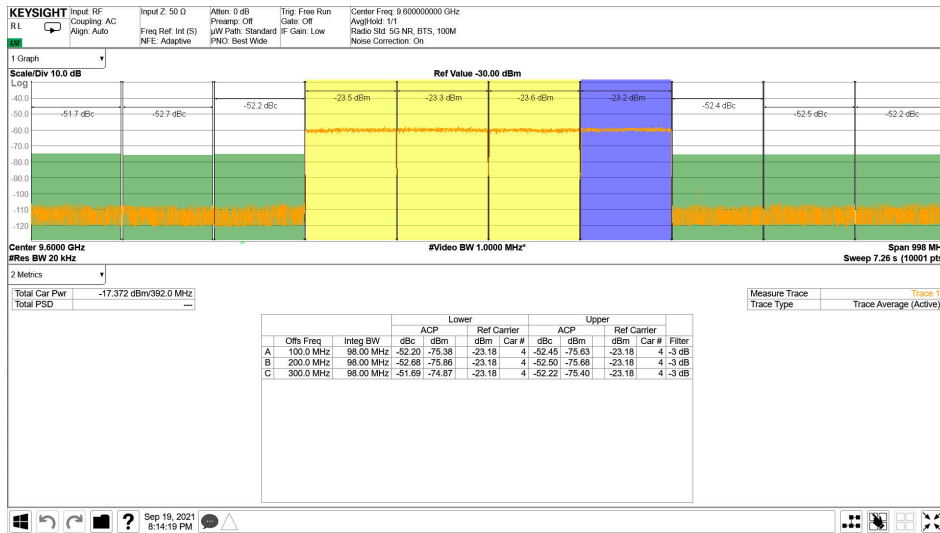

Includes PCB and cable losses.

Figure 6-285. TX 4xNR100MHz Output Spectrum at 9.61 GHz

6.12.8 RX Typical Characteristics at 800 MHz (continued)

Typical values at $T_A = +25^\circ\text{C}$, ADC Sampling Rate = 2949.12 GHz. Default conditions: output sample rate = 491.52MSPS (decimate by 6), PLL clock mode with $f_{REF} = 491.52\text{ MHz}$, $A_{IN} = -3\text{ dBFS}$, DSA setting = 4 dB.

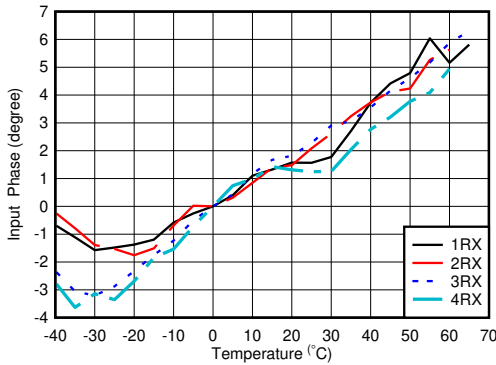

With 0.8 GHz matching, normalized to phase at 25°C

Figure 6-289. RX Input Phase vs Temperature and DSA at $f_{OUT} = 0.8\text{ GHz}$

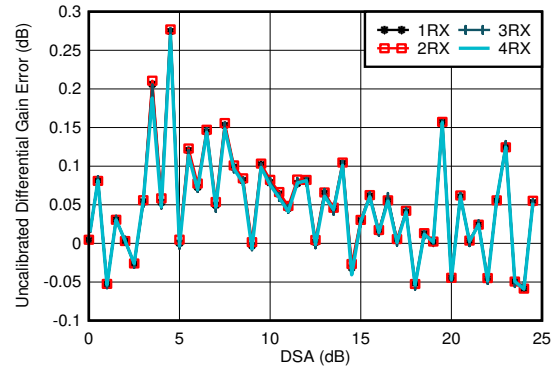

With 0.8 GHz matching

$$\text{Differential Amplitude Error} = P_{IN}(\text{DSA Setting} - 1) - P_{IN}(\text{DSA Setting}) + 1$$

Figure 6-290. RX Uncalibrated Differential Amplitude Error vs DSA Setting at 0.8 GHz

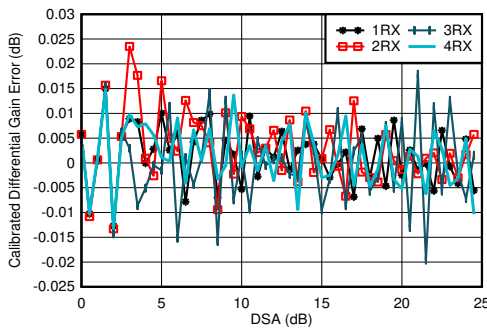

With 0.8 GHz matching

$$\text{Differential Amplitude Error} = P_{IN}(\text{DSA Setting} - 1) - P_{IN}(\text{DSA Setting}) + 1$$

Figure 6-291. RX Calibrated Differential Amplitude Error vs DSA Setting at 0.8 GHz

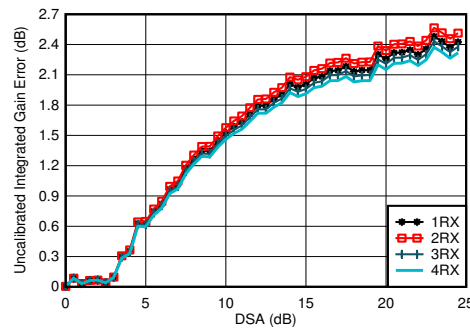

With 0.8 GHz matching

$$\text{Integrated Amplitude Error} = P_{IN}(\text{DSA Setting}) - P_{IN}(\text{DSA Setting} = 0) + (\text{DSA Setting})$$

Figure 6-292. RX Uncalibrated Integrated Amplitude Error vs DSA Setting at 0.8 GHz

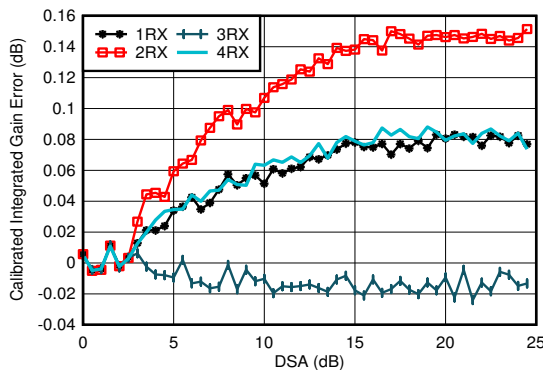

With 0.8 GHz matching

$$\text{Integrated Amplitude Error} = P_{IN}(\text{DSA Setting}) - P_{IN}(\text{DSA Setting} = 0) + (\text{DSA Setting})$$

Figure 6-293. RX Calibrated Integrated Amplitude Error vs DSA Setting at 2.6 GHz

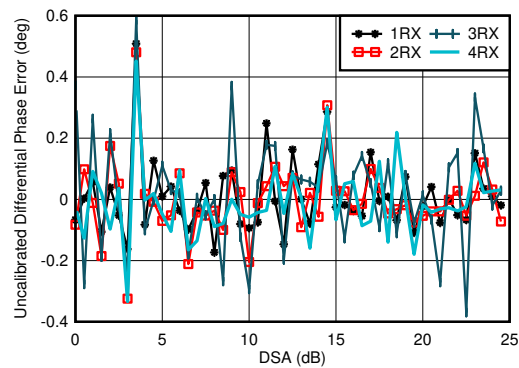

With 0.8 GHz matching

$$\text{Differential Phase Error} = \text{Phase}_{IN}(\text{DSA Setting} - 1) - \text{Phase}_{IN}(\text{DSA Setting})$$

Figure 6-294. RX Uncalibrated Differential Phase Error vs DSA Setting at 0.8 GHz

6.12.8 RX Typical Characteristics at 800 MHz (continued)

Typical values at $T_A = +25^\circ\text{C}$, ADC Sampling Rate = 2949.12 GHz. Default conditions: output sample rate = 491.52MSPS (decimate by 6), PLL clock mode with $f_{\text{REF}} = 491.52 \text{ MHz}$, $A_{\text{IN}} = -3 \text{ dBFS}$, DSA setting = 4 dB.

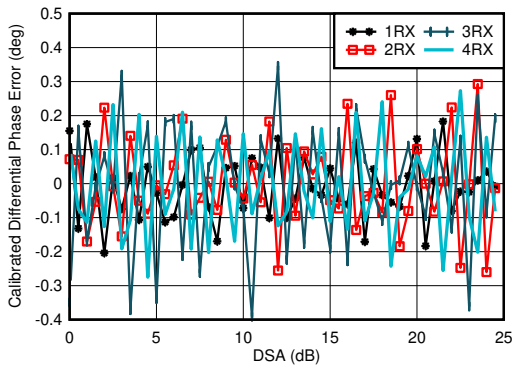

With 0.8 GHz matching
Differential Phase Error = $\text{Phase}_{\text{IN}}(\text{DSA Setting} - 1) - \text{Phase}_{\text{IN}}(\text{DSA Setting})$

Figure 6-295. RX Calibrated Differential Phase Error vs DSA Setting at 0.8 GHz

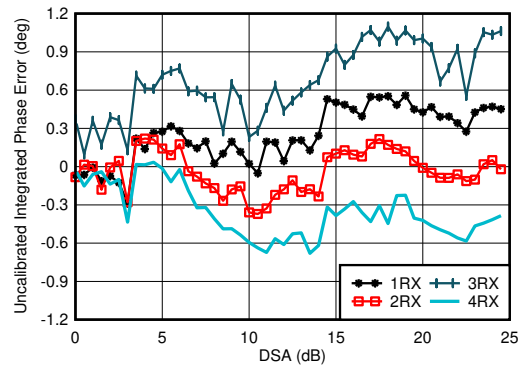

With 0.8 GHz matching
Integrated Phase Error = $\text{Phase}(\text{DSA Setting}) - \text{Phase}(\text{DSA Setting} = 0)$

Figure 6-296. RX Uncalibrated Integrated Phase Error vs DSA Setting at 0.8 GHz

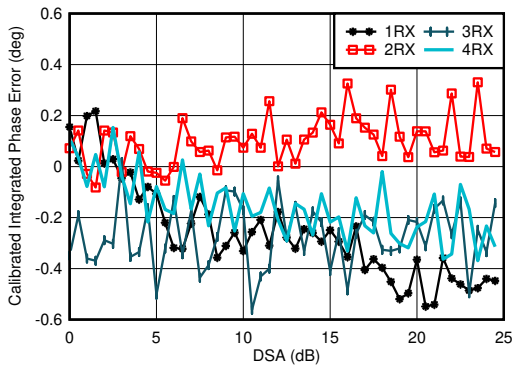

With 0.8 GHz matching
Integrated Phase Error = $\text{Phase}(\text{DSA Setting}) - \text{Phase}(\text{DSA Setting} = 0)$

Figure 6-297. RX Calibrated Integrated Phase Error vs DSA Setting at 0.8 GHz

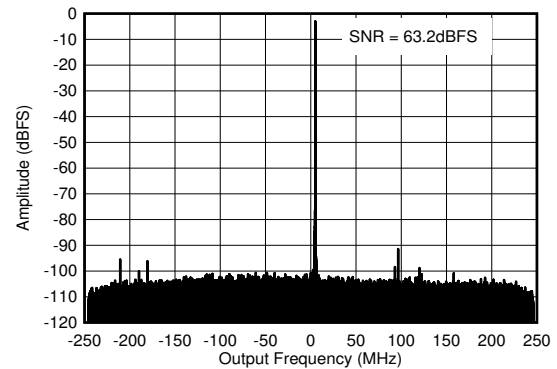

With 0.8 GHz matching, $f_{\text{IN}} = 840 \text{ MHz}$, $A_{\text{IN}} = -3 \text{ dBFS}$

Figure 6-298. RX Output FFT at 0.8 GHz

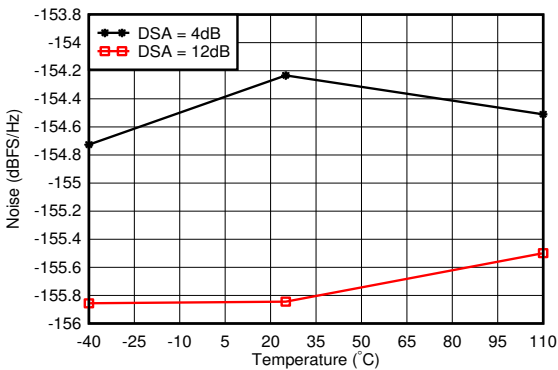

With 0.8 GHz matching, 12.5-MHz offset from tone

Figure 6-299. RX Noise Spectral Density vs Temperature at 0.8 GHz

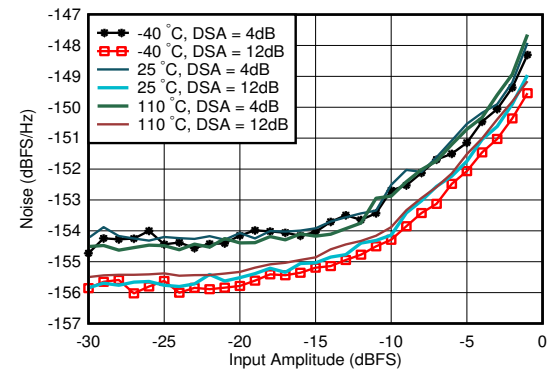

With 0.8 GHz matching, DSA Setting = 12 dB, 12.5-MHz offset from tone

Figure 6-300. RX Noise Spectral Density vs Input Amplitude and Temperature at 0.8 GHz

6.12.8 RX Typical Characteristics at 800 MHz (continued)

Typical values at $T_A = +25^\circ\text{C}$, ADC Sampling Rate = 2949.12 GHz. Default conditions: output sample rate = 491.52MSPS (decimate by 6), PLL clock mode with $f_{REF} = 491.52\text{ MHz}$, $A_{IN} = -3\text{ dBFS}$, DSA setting = 4 dB.

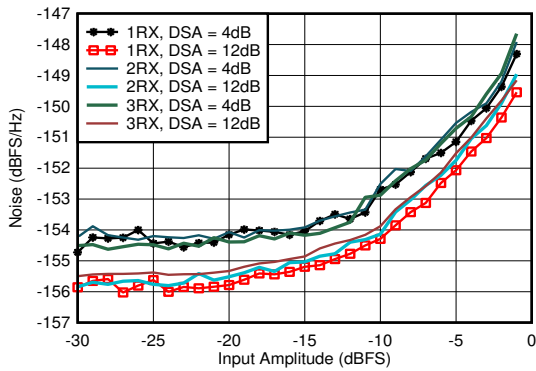

With 0.8 GHz matching, 12.5-MHz offset from tone

Figure 6-301. RX Noise Spectral Density vs Input Amplitude and Channel at 0.8 GHz

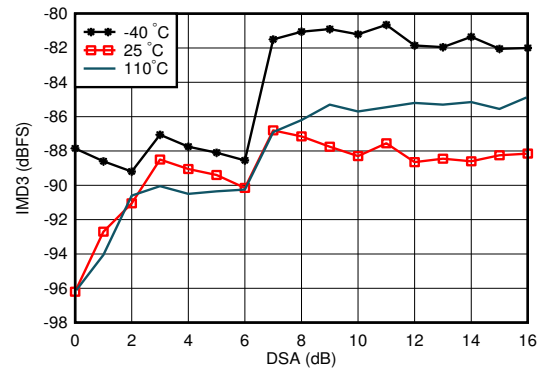

With 0.8 GHz matching, each tone -7 dBFS , tone spacing = 20 MHz

Figure 6-302. RX IMD3 vs DSA Setting and Temperature at 0.8 GHz

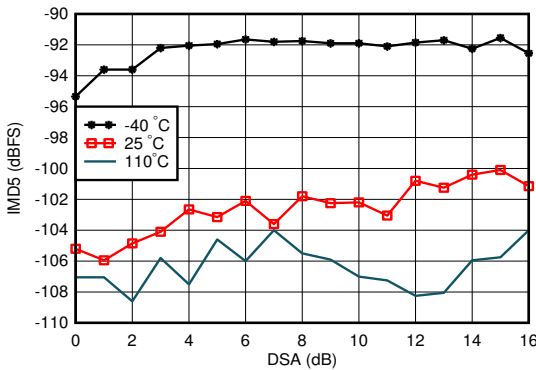

With 0.8 GHz matching, each tone -7 dBFS , tone spacing = 20 MHz

Figure 6-303. RX IMD5 vs DSA Setting and Temperature at 0.8 GHz

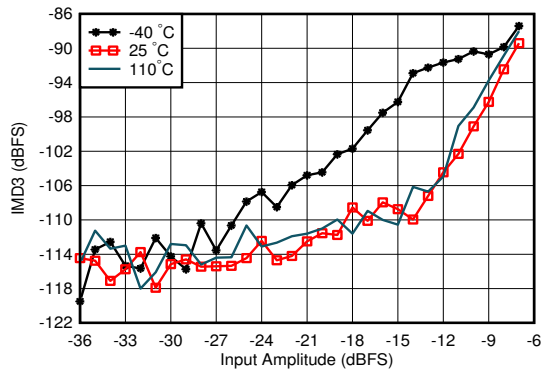

With 0.8 GHz matching, tone spacing = 20 MHz, DSA = 4 dB

Figure 6-304. RX IMD3 vs Input Level and Temperature at 0.8 GHz

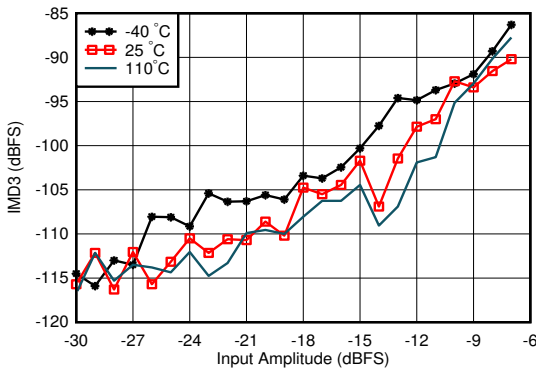

With 0.8 GHz matching, tone spacing = 20 MHz, DSA = 12 dB

Figure 6-305. RX IMD3 vs Input Level and Temperature at 0.8 GHz

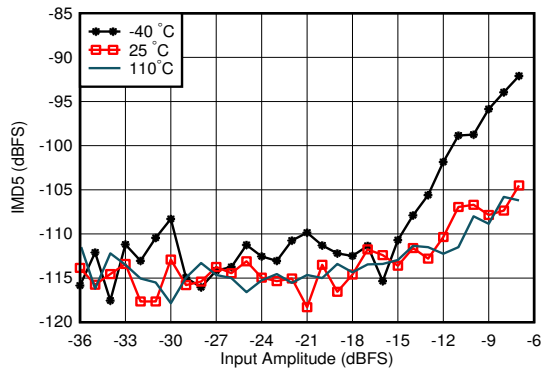

With 0.8 GHz matching, tone spacing = 20 MHz, DSA = 12 dB

Figure 6-306. RX IMD5 vs Input Level and Temperature at 0.8 GHz

6.12.8 RX Typical Characteristics at 800 MHz (continued)

Typical values at $T_A = +25^\circ\text{C}$, ADC Sampling Rate = 2949.12 GHz. Default conditions: output sample rate = 491.52MSPS (decimate by 6), PLL clock mode with $f_{REF} = 491.52\text{ MHz}$, $A_{IN} = -3\text{ dBFS}$, DSA setting = 4 dB.

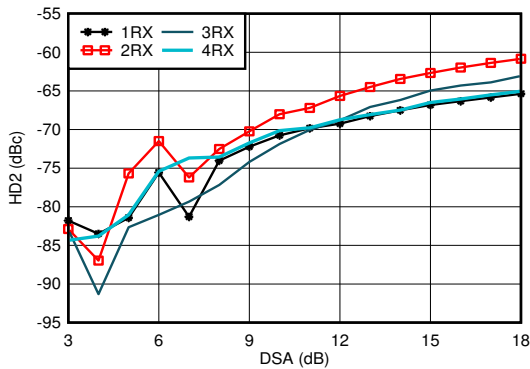

With 0.8 GHz matching, measured after HD2 trim, DDC bypass mode (TI only mode for characterization)

Figure 6-307. RX HD2 vs DSA Setting and Channel at 0.8 GHz

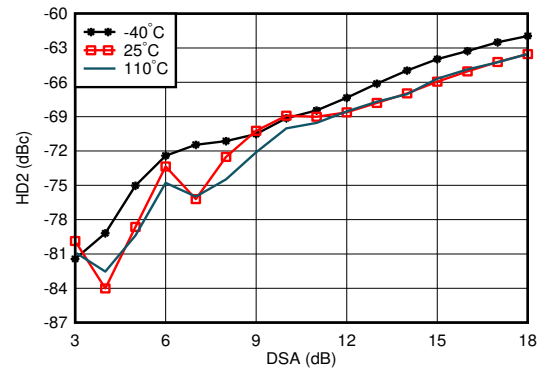

With 0.8 GHz matching, measured after HD2 trim, DDC bypass mode (TI only mode for characterization)

Figure 6-308. RX HD2 vs DSA Setting and Temperature at 0.8 GHz

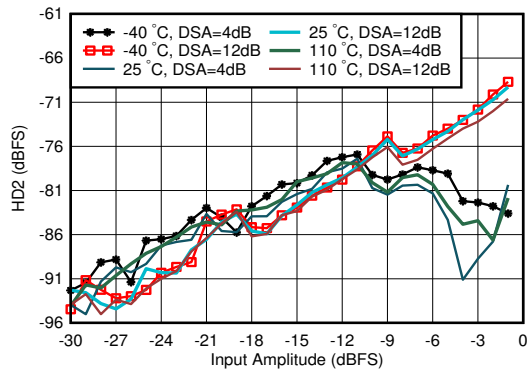

With 0.8 GHz matching, measured after HD2 trim, DDC bypass mode (TI only mode for characterization)

Figure 6-309. RX HD2 vs Input Level and Temperature at 0.8 GHz

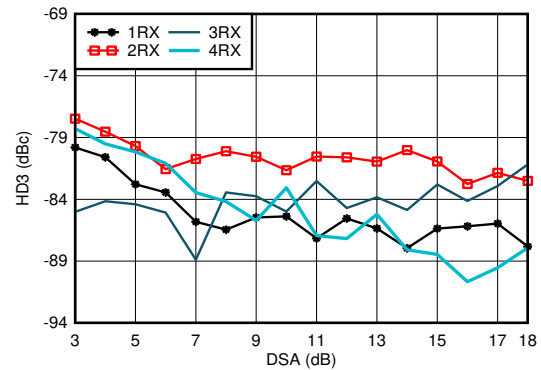

With 0.8 GHz matching, DDC bypass mode (TI only mode for characterization)

Figure 6-310. RX HD3 vs DSA Setting and Channel at 0.8 GHz

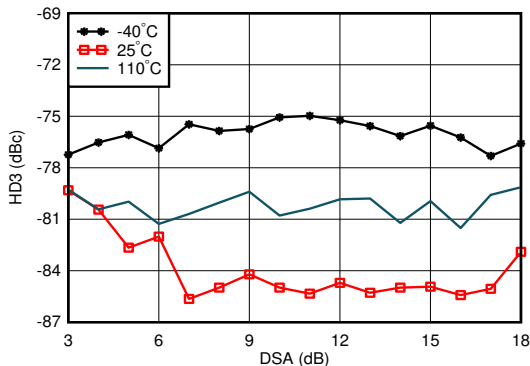

With 0.8 GHz matching, DDC bypass mode (TI only mode for characterization)

Figure 6-311. RX HD3 vs DSA Setting and Temperature at 0.8 GHz

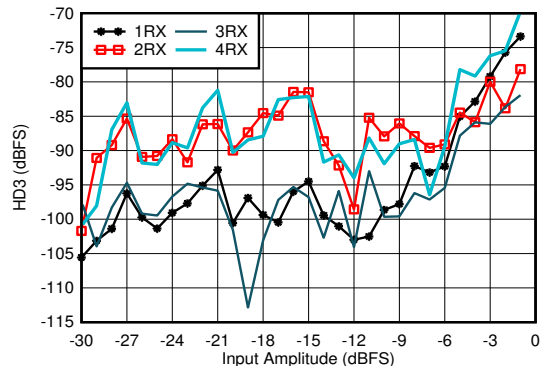

With 0.8 GHz matching, DDC bypass mode (TI only mode for characterization)

Figure 6-312. RX HD3 vs Input Level and Channel at 0.8 GHz

6.12.8 RX Typical Characteristics at 800 MHz (continued)

Typical values at $T_A = +25^\circ\text{C}$, ADC Sampling Rate = 2949.12 GHz. Default conditions: output sample rate = 491.52MSPS (decimate by 6), PLL clock mode with $f_{REF} = 491.52\text{ MHz}$, $A_{IN} = -3\text{ dBFS}$, DSA setting = 4 dB.

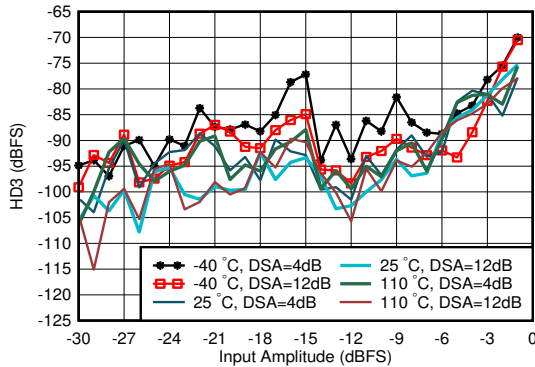

With 0.8 GHz matching, DDC bypass mode (TI only mode for characterization)

Figure 6-313. RX HD3 vs Input Level and Temperature at 0.8 GHz

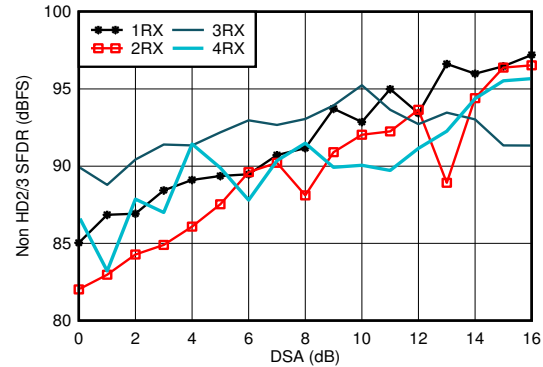

With 0.8 GHz matching

Figure 6-314. RX Non-HD2/3 vs DSA Setting at 0.8 GHz

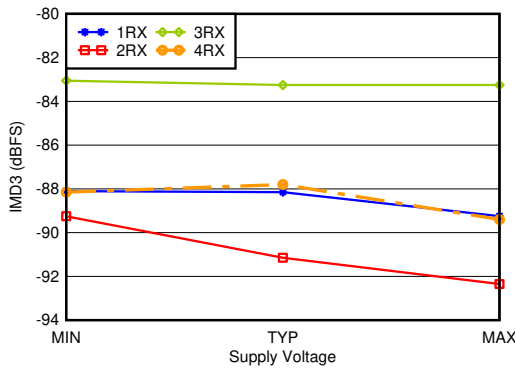

With 0.8 GHz matching, -7 dBFS each tone, 20-MHz tone spacing, all supplies at MIN, TYP, or MAX recommended operating voltages

Figure 6-315. RX IMD3 vs Supply and Channel at 0.8 GHz

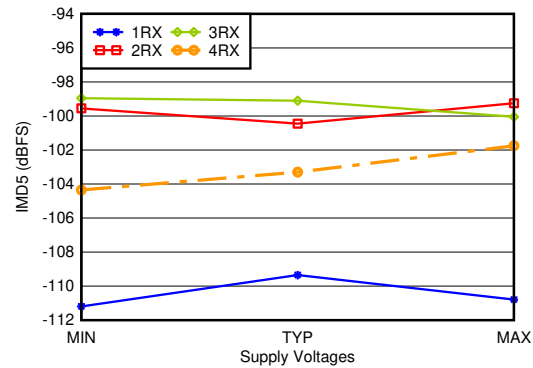

With 0.8 GHz matching, -7 dBFS each tone, 20-MHz tone spacing, all supplies at MIN, TYP, or MAX recommended operating voltages

Figure 6-316. RX IMD5 vs Supply and Channel at 0.8 GHz

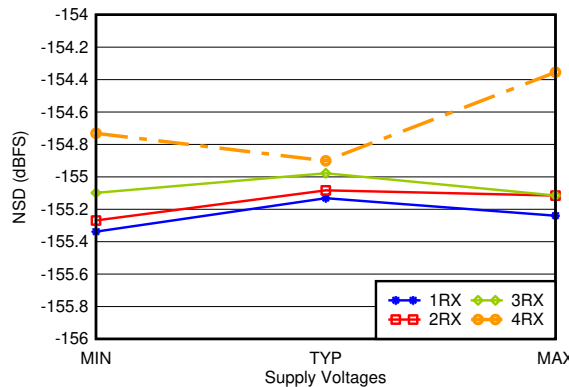

With 0.8 GHz matching, 12.5-MHz offset, all supplies at MIN, TYP, or MAX recommended operating voltages

Figure 6-317. RX Noise Spectral Density vs Supply and Channel at 0.8 GHz

6.12.9 RX Typical Characteristics at 1.75 GHz – 1.9 GHz

Typical values at $T_A = +25^\circ\text{C}$, ADC Sampling Rate = 2949.12 MHz. Default conditions: output sample rate = 491.52MSPS (decimate by 6), PLL clock mode with $f_{REF} = 491.52\text{ MHz}$, $A_{IN} = -3\text{ dBFS}$, DSA setting = 4 dB.

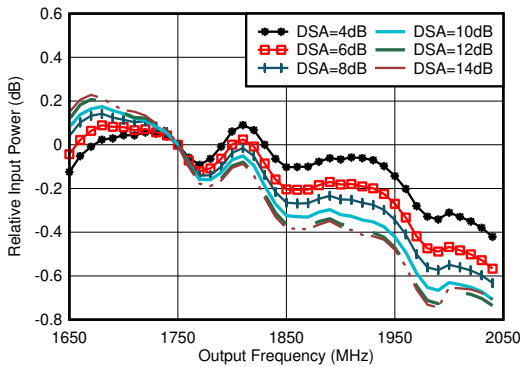

With 1.8 GHz matching, normalized to 1.75 GHz

Figure 6-318. RX In-Band Gain Flatness, $f_{IN} = 1750\text{ MHz}$

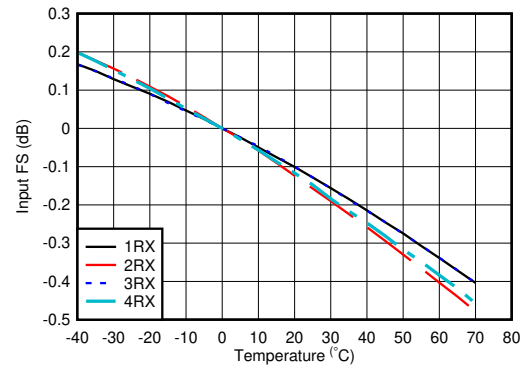

With 1.8 GHz matching, normalized to fullscale at 25°C for each channel

Figure 6-319. RX Input Fullscale vs Temperature and Channel at 1.75 GHz

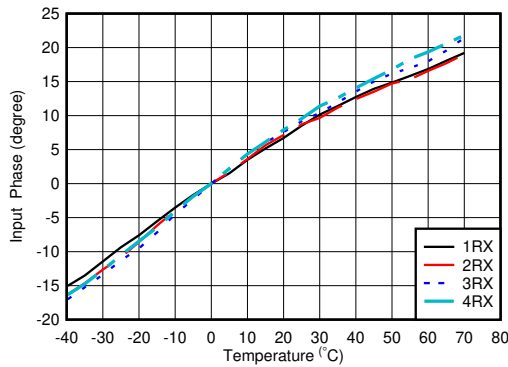

With 2.6 GHz matching, normalized to phase at 25°C

Figure 6-320. RX Input Phase vs Temperature and DSA at $f_{IN} = 1.75\text{ GHz}$

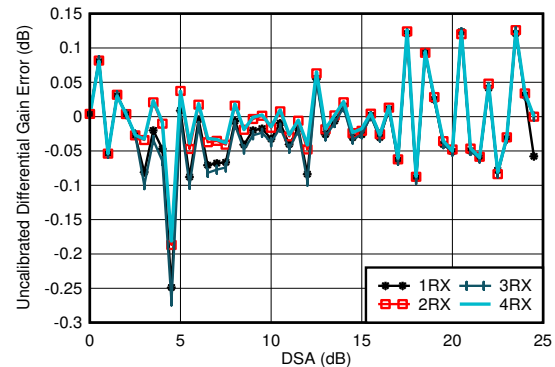

With 1.8 GHz matching
Differential Amplitude Error = $P_{IN}(\text{DSA Setting} - 1) - P_{IN}(\text{DSA Setting}) + 1$

Figure 6-321. RX Uncalibrated Differential Amplitude Error vs DSA Setting at 1.75 GHz

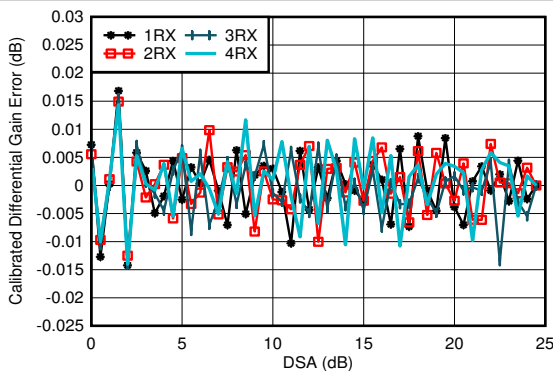

With 1.8 GHz matching
Differential Amplitude Error = $P_{IN}(\text{DSA Setting} - 1) - P_{IN}(\text{DSA Setting}) + 1$

Figure 6-322. RX Calibrated Differential Amplitude Error vs DSA Setting at 1.75 GHz

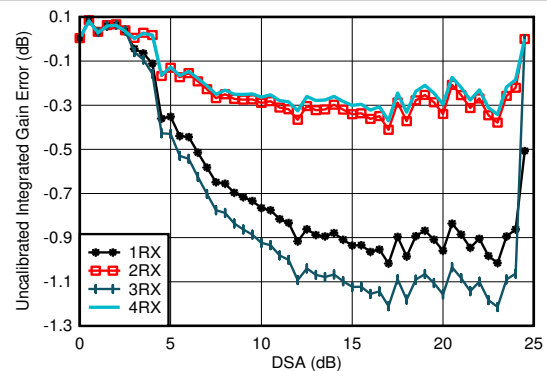

With 1.8 GHz matching
Integrated Amplitude Error = $P_{IN}(\text{DSA Setting}) - P_{IN}(\text{DSA Setting} = 0) + (\text{DSA Setting})$

Figure 6-323. RX Uncalibrated Integrated Amplitude Error vs DSA Setting at 1.75 GHz

6.12.9 RX Typical Characteristics at 1.75 GHz – 1.9 GHz (continued)

Typical values at $T_A = +25^\circ\text{C}$, ADC Sampling Rate = 2949.12 MHz. Default conditions: output sample rate = 491.52MSPS (decimate by 6), PLL clock mode with $f_{REF} = 491.52\text{ MHz}$, $A_{IN} = -3\text{ dBFS}$, DSA setting = 4 dB.

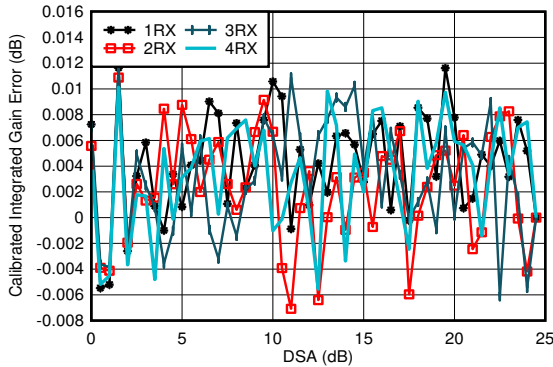

With 1.8 GHz matching
 Integrated Amplitude Error = $P_{IN}(\text{DSA Setting}) - P_{IN}(\text{DSA Setting} = 0) + (\text{DSA Setting})$

Figure 6-324. RX Calibrated Integrated Amplitude Error vs DSA Setting at 1.75 GHz

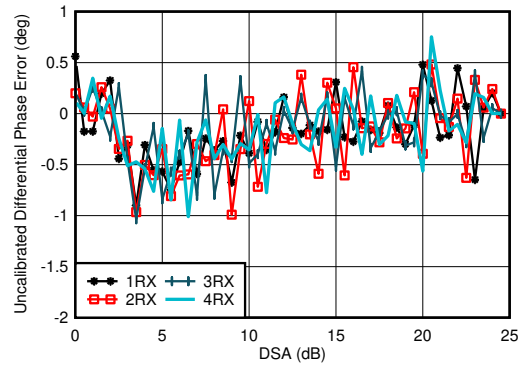

With 1.8 GHz matching
 Differential Phase Error = $\text{Phase}_{IN}(\text{DSA Setting} - 1) - \text{Phase}_{IN}(\text{DSA Setting})$

Figure 6-325. RX Uncalibrated Differential Phase Error vs DSA Setting at 1.75 GHz

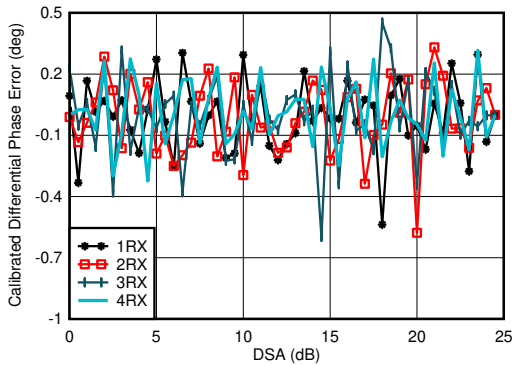

With 1.8 GHz matching
 Differential Phase Error = $\text{Phase}_{IN}(\text{DSA Setting} - 1) - \text{Phase}_{IN}(\text{DSA Setting})$

Figure 6-326. RX Calibrated Differential Phase Error vs DSA Setting at 1.75 GHz

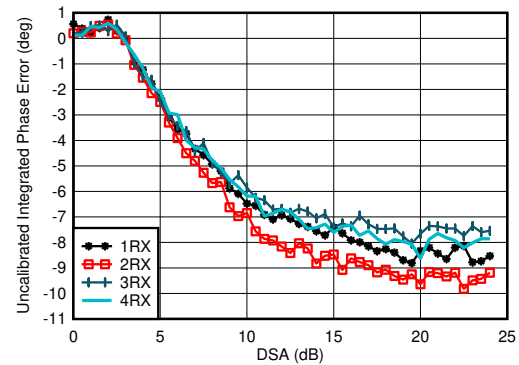

With 1.8 GHz matching
 Integrated Phase Error = $\text{Phase}(\text{DSA Setting}) - \text{Phase}(\text{DSA Setting} = 0)$

Figure 6-327. RX Uncalibrated Integrated Phase Error vs DSA Setting at 1.75 GHz

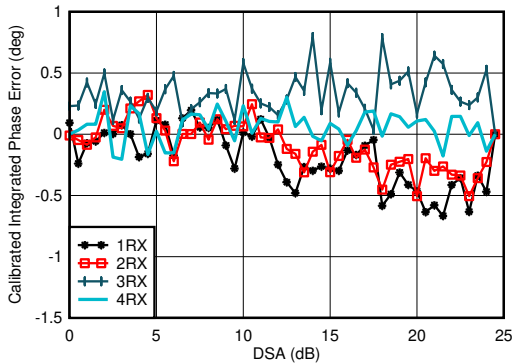

With 1.8 GHz matching
 Integrated Phase Error = $\text{Phase}(\text{DSA Setting}) - \text{Phase}(\text{DSA Setting} = 0)$

Figure 6-328. RX Calibrated Integrated Phase Error vs DSA Setting at 1.75 GHz

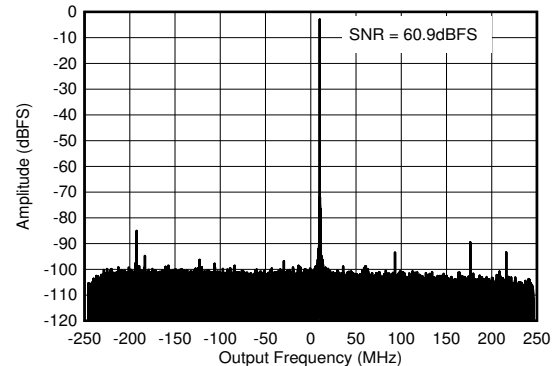

With 1.8 GHz matching, $f_{IN} = 2610\text{ MHz}$, $A_{IN} = -3\text{ dBFS}$

Figure 6-329. RX Output FFT at 1.75 GHz

6.12.9 RX Typical Characteristics at 1.75 GHz – 1.9 GHz (continued)

Typical values at $T_A = +25^\circ\text{C}$, ADC Sampling Rate = 2949.12 MHz. Default conditions: output sample rate = 491.52MSPS (decimate by 6), PLL clock mode with $f_{REF} = 491.52\text{ MHz}$, $A_{IN} = -3\text{ dBFS}$, DSA setting = 4 dB.

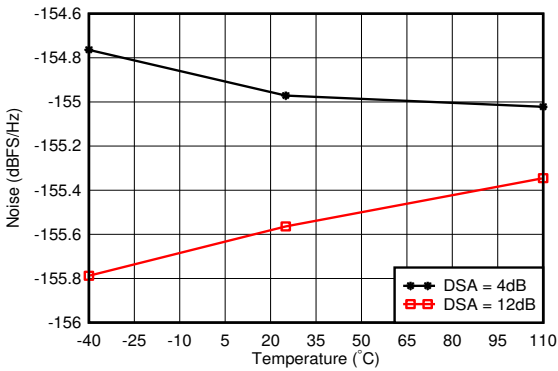

With 1.8 GHz matching, 12.5-MHz offset from tone

Figure 6-330. RX Noise Spectral Density vs Temperature at 1.75 GHz

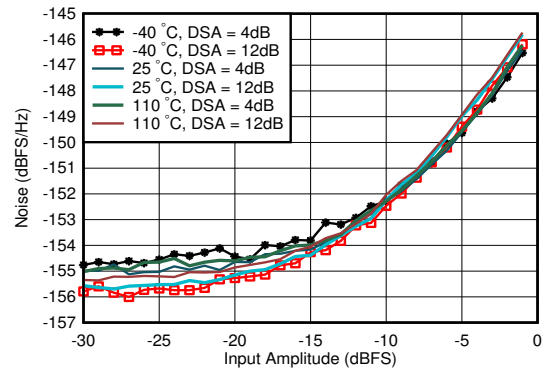

With 1.8 GHz matching, DSA Setting = 12 dB, 12.5-MHz offset from tone

Figure 6-331. RX Noise Spectral Density vs Input Amplitude and Temperature at 1.75 GHz

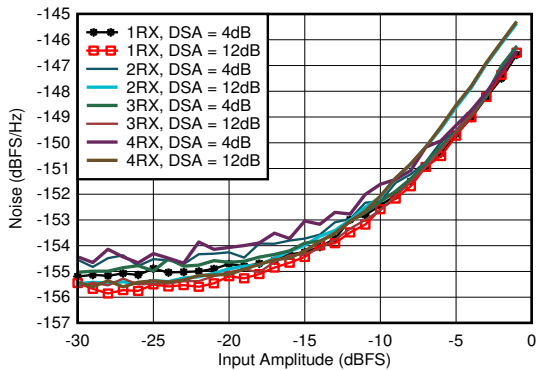

With 1.8 GHz matching, 12.5-MHz offset from tone

Figure 6-332. RX Noise Spectral Density vs Input Amplitude and Channel at 1.75 GHz

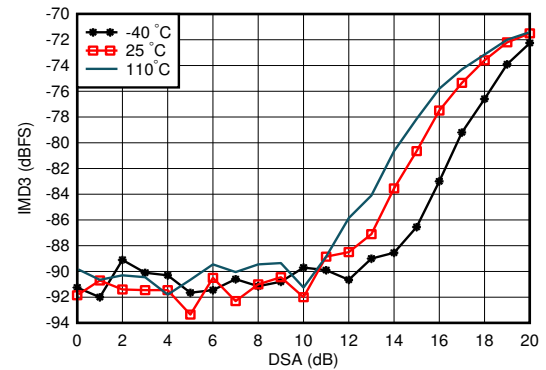

With 1.8 GHz matching, each tone -7 dBFS , tone spacing = 20 MHz

Figure 6-333. RX IMD3 vs DSA Setting and Temperature at 1.75 GHz

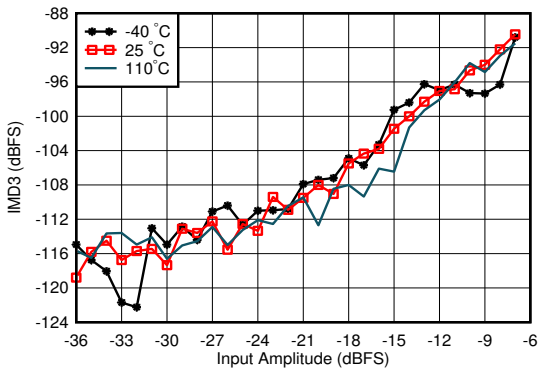

With 1.8 GHz matching, tone spacing = 20 MHz, DSA = 4 dB

Figure 6-334. RX IMD3 vs Input Level and Temperature at 1.75 GHz

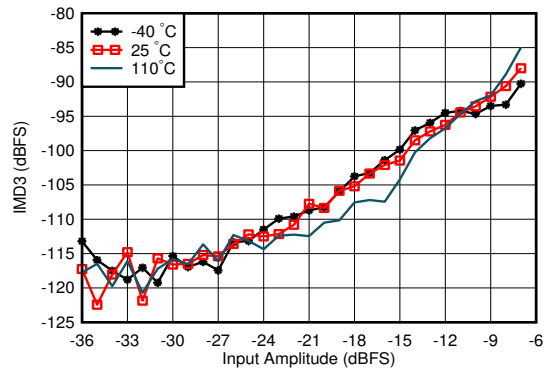

With 1.8 GHz matching, tone spacing = 20 MHz, DSA = 12 dB

Figure 6-335. RX IMD3 vs Input Level and Temperature at 1.75 GHz

6.12.9 RX Typical Characteristics at 1.75 GHz – 1.9 GHz (continued)

Typical values at $T_A = +25^\circ\text{C}$, ADC Sampling Rate = 2949.12 MHz. Default conditions: output sample rate = 491.52MSPS (decimate by 6), PLL clock mode with $f_{REF} = 491.52\text{ MHz}$, $A_{IN} = -3\text{ dBFS}$, DSA setting = 4 dB.

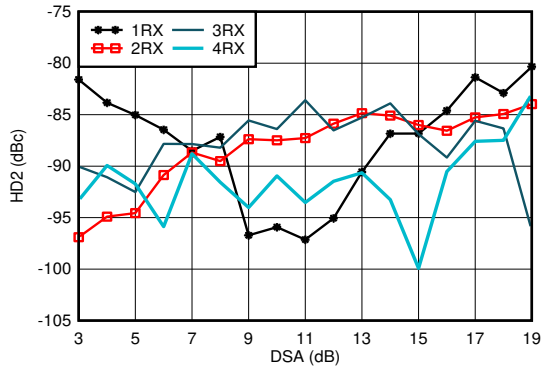

With 1.8 GHz matching, $f_{in} = 1900\text{MHz}$, measured after HD2 trim, DDC bypass mode (TI only mode for characterization)

Figure 6-336. RX HD2 vs DSA Setting and Channel at 1.9 GHz

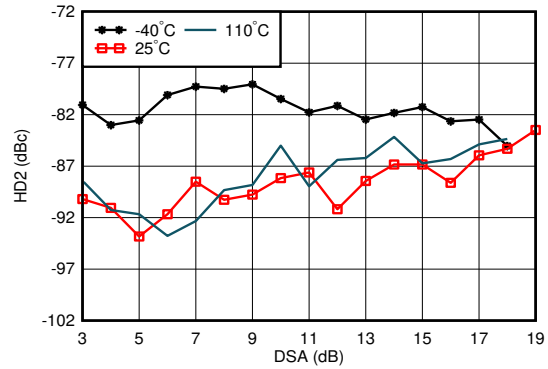

With 1.8 GHz matching, $f_{in} = 1900\text{MHz}$, measured after HD2 trim, DDC bypass mode (TI only mode for characterization)

Figure 6-337. RX HD2 vs DSA Setting and Temperature at 1.9 GHz

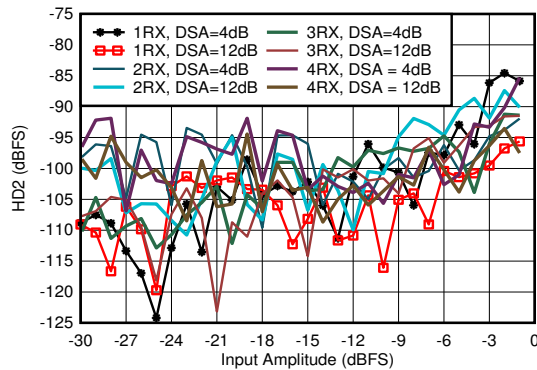

With 1.8 GHz matching, $f_{in} = 1900\text{MHz}$, measured after HD2 trim, DDC bypass mode (TI only mode for characterization)

Figure 6-338. RX HD2 vs Input Amplitude and Channel at 1.9 GHz

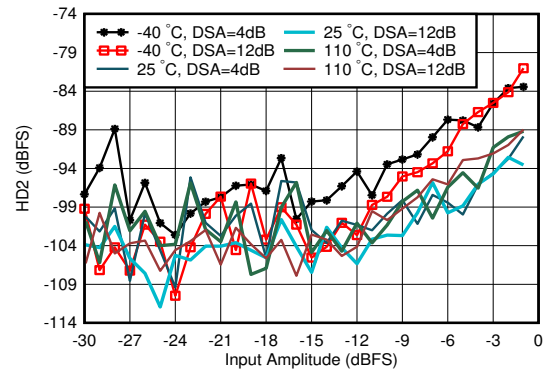

With 1.8 GHz matching, $f_{in} = 1900\text{MHz}$, measured after HD2 trim, DDC bypass mode (TI only mode for characterization)

Figure 6-339. RX HD2 vs Input Amplitude and Temperature at 1.9 GHz

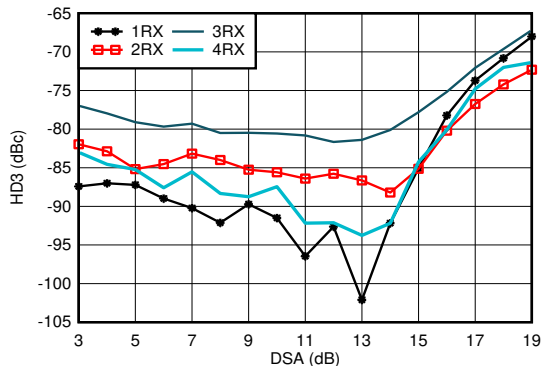

With 1.8 GHz matching, $f_{in} = 1900\text{MHz}$, DDC bypass mode (TI only mode for characterization)

Figure 6-340. RX HD3 vs DSA Setting and Channel at 1.9 GHz

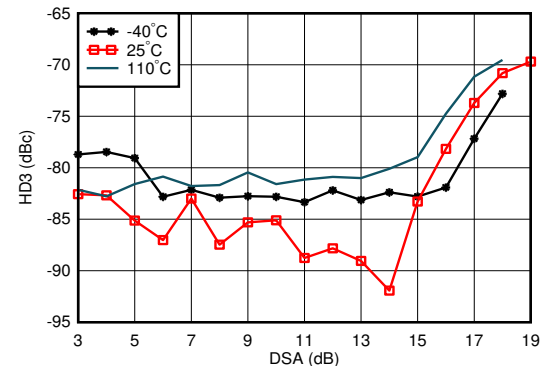

With 1.8 GHz matching, $f_{in} = 1900\text{MHz}$, DDC bypass mode (TI only mode for characterization)

Figure 6-341. RX HD3 vs DSA Setting and Temperature at 1.9 GHz

6.12.9 RX Typical Characteristics at 1.75 GHz – 1.9 GHz (continued)

Typical values at $T_A = +25^\circ\text{C}$, ADC Sampling Rate = 2949.12 MHz. Default conditions: output sample rate = 491.52MSPS (decimate by 6), PLL clock mode with $f_{REF} = 491.52\text{ MHz}$, $A_{IN} = -3\text{ dBFS}$, DSA setting = 4 dB.

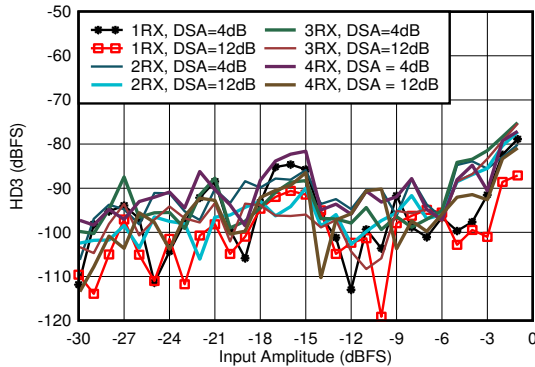

With 1.8 GHz matching, $f_{in} = 1900\text{MHz}$, DDC bypass mode (TI only mode for characterization)

Figure 6-342. RX HD3 vs Input Level and Channel at 1.9 GHz

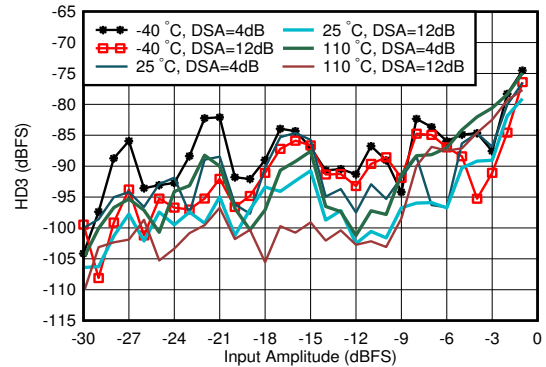

With 1.8 GHz matching, $f_{in} = 1900\text{MHz}$, DDC bypass mode (TI only mode for characterization)

Figure 6-343. RX HD3 vs Input Level and Temperature at 1.9 GHz

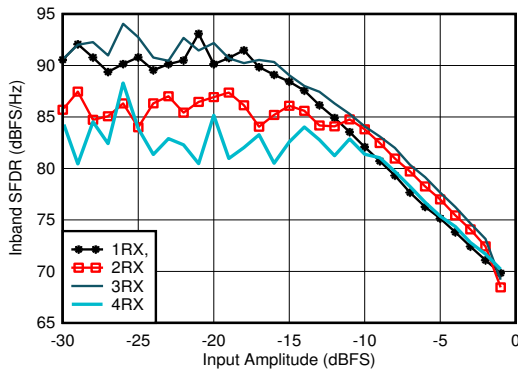

With 1.8 GHz matching, decimated by 3

Figure 6-344. RX In-Band SFDR ($\pm 400\text{ MHz}$) vs Input Amplitude at 1.75 GHz

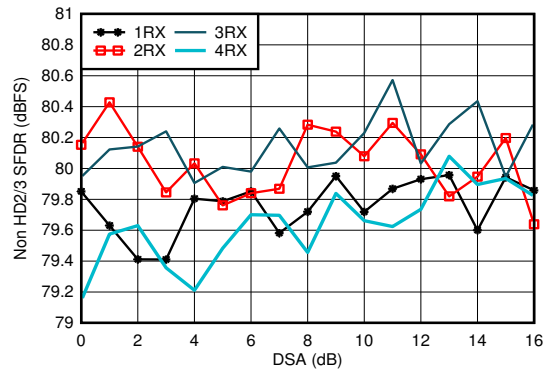

With 1.8 GHz matching

Figure 6-345. RX Non-HD2/3 vs DSA Setting at 1.75 GHz

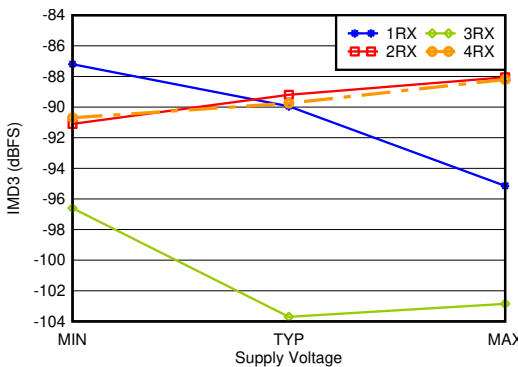

With 1.8 GHz matching, -7 dBFS each tone, 20-MHz tone spacing, all supplies at MIN, TYP, or MAX recommended operating voltages

Figure 6-346. RX IMD3 vs Supply and Channel at 1.75 GHz

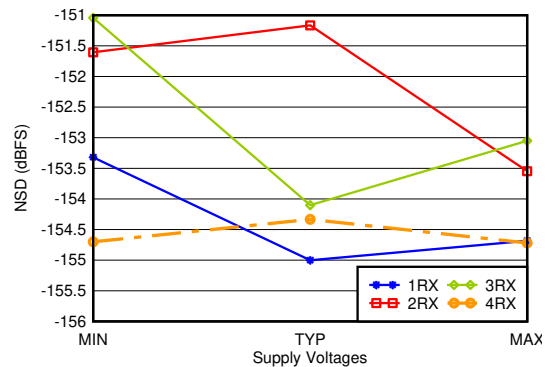

With 1.8 GHz matching, 12.5-MHz offset, all supplies at MIN, TYP, or MAX recommended operating voltages

Figure 6-347. RX Noise Spectral Density vs Supply and Channel at 1.75 GHz

6.12.10 RX Typical Characteristics at 2.6 GHz

Typical values at $T_A = +25^\circ\text{C}$, ADC Sampling Rate = 2949.12 MHz. Default conditions: output sample rate = 491.52MSPS (decimate by 6), PLL clock mode with $f_{REF} = 491.52\text{ MHz}$, $A_{IN} = -3\text{ dBFS}$, DSA setting = 4 dB.

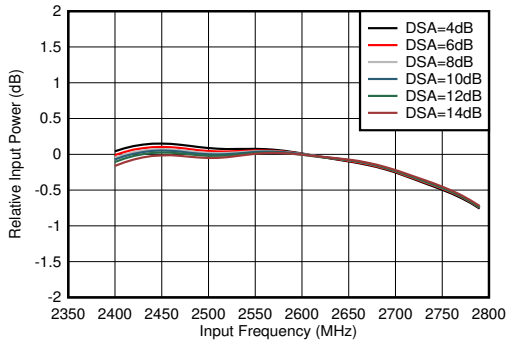

With matching, normalized to power at 2.6 GHz for each DSA setting

Figure 6-348. RX Inband Gain Flatness, $f_{IN} = 2600\text{ MHz}$

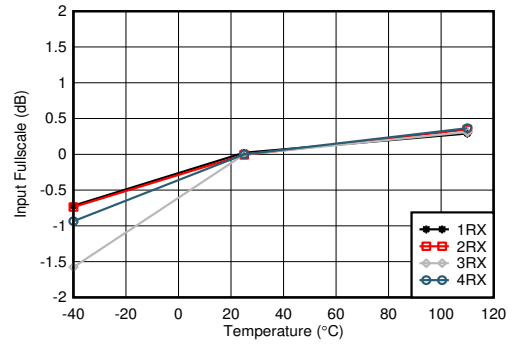

With 2.6 GHz matching, normalized to fullscale at 25°C for each channel

Figure 6-349. RX Input Fullscale vs Temperature and Channel at 2.6 GHz

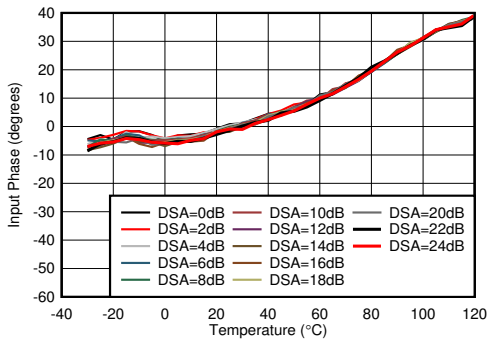

With 2.6 GHz matching, normalized to phase at 25°C

Figure 6-350. RX Input Phase vs Temperature and DSA at $f_{OUT} = 2.6\text{ GHz}$

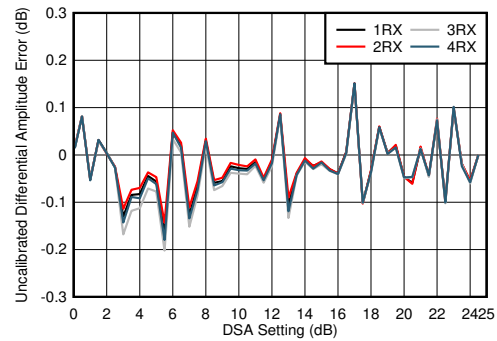

With 2.6 GHz matching

$$\text{Differential Amplitude Error} = P_{IN}(\text{DSA Setting} - 1) - P_{IN}(\text{DSA Setting}) + 1$$

Figure 6-351. RX Uncalibrated Differential Amplitude Error vs DSA Setting at 2.6 GHz

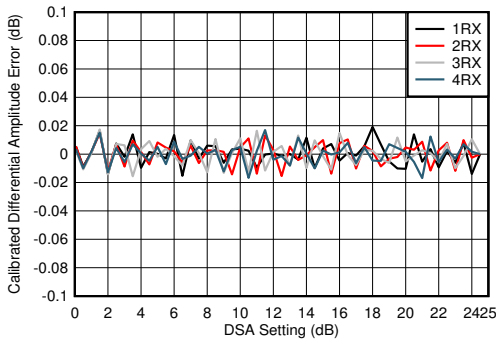

With 2.6 GHz matching

$$\text{Differential Amplitude Error} = P_{IN}(\text{DSA Setting} - 1) - P_{IN}(\text{DSA Setting}) + 1$$

Figure 6-352. RX Calibrated Differential Amplitude Error vs DSA Setting at 2.6 GHz

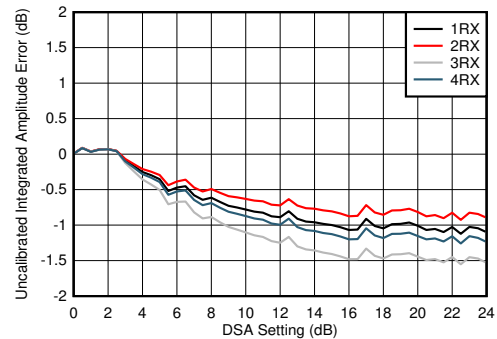

With 2.6 GHz matching

$$\text{Integrated Amplitude Error} = P_{IN}(\text{DSA Setting}) - P_{IN}(\text{DSA Setting} = 0) + (\text{DSA Setting})$$

Figure 6-353. RX Uncalibrated Integrated Amplitude Error vs DSA Setting at 2.6 GHz

6.12.10 RX Typical Characteristics at 2.6 GHz (continued)

Typical values at $T_A = +25^\circ\text{C}$, ADC Sampling Rate = 2949.12 GHz. Default conditions: output sample rate = 491.52MSPS (decimate by 6), PLL clock mode with $f_{REF} = 491.52\text{ MHz}$, $A_{IN} = -3\text{ dBFS}$, DSA setting = 4 dB.

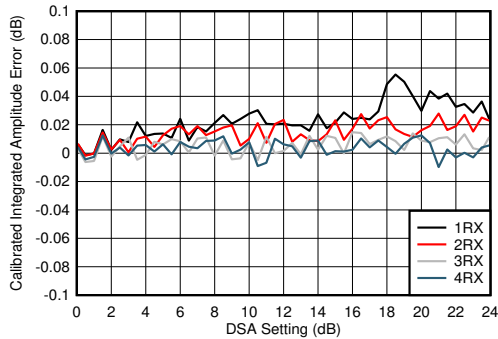

With 2.6 GHz matching
Integrated Amplitude Error = $P_{IN}(\text{DSA Setting}) - P_{IN}(\text{DSA Setting} = 0) + (\text{DSA Setting})$

Figure 6-354. RX Calibrated Integrated Amplitude Error vs DSA Setting at 2.6 GHz

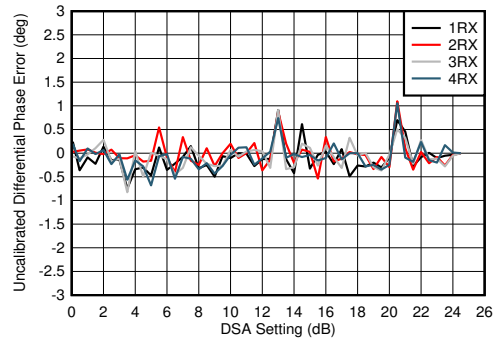

With 2.6 GHz matching
Differential Phase Error = $\text{Phase}_{IN}(\text{DSA Setting} - 1) - \text{Phase}_{IN}(\text{DSA Setting})$

Figure 6-355. RX Uncalibrated Differential Phase Error vs DSA Setting at 2.6 GHz

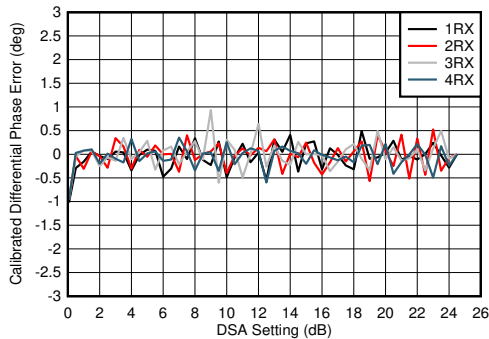

With 2.6 GHz matching
Differential Phase Error = $\text{Phase}_{IN}(\text{DSA Setting} - 1) - \text{Phase}_{IN}(\text{DSA Setting})$

Figure 6-356. RX Calibrated Differential Phase Error vs DSA Setting at 2.6 GHz

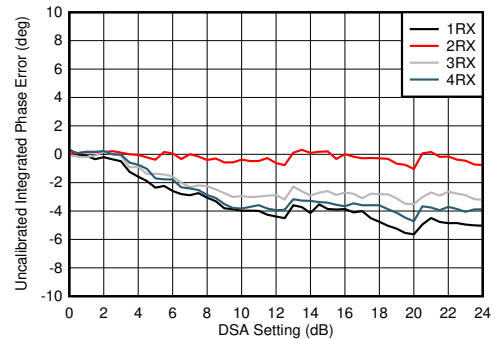

With 2.6 GHz matching
Integrated Phase Error = $\text{Phase}(\text{DSA Setting}) - \text{Phase}(\text{DSA Setting} = 0)$

Figure 6-357. RX Uncalibrated Integrated Phase Error vs DSA Setting at 2.6 GHz

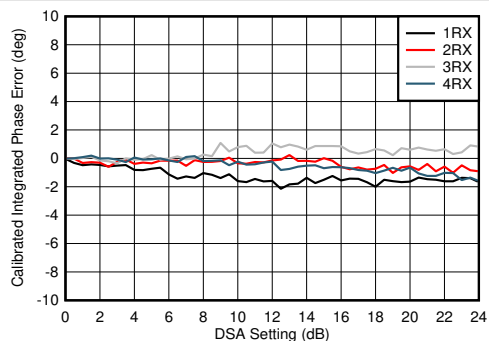

With 2.6 GHz matching
Integrated Phase Error = $\text{Phase}(\text{DSA Setting}) - \text{Phase}(\text{DSA Setting} = 0)$

Figure 6-358. RX Calibrated Integrated Phase Error vs DSA Setting at 2.6 GHz

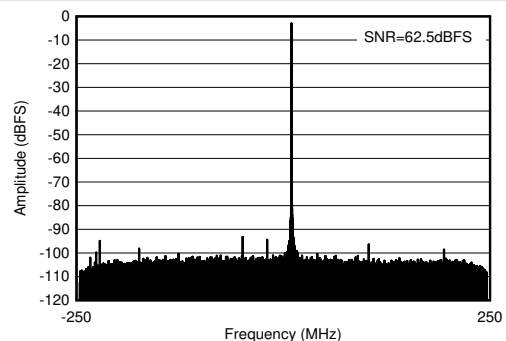

With 2.6 GHz matching, $f_{IN} = 2610\text{ MHz}$, $A_{IN} = -3\text{ dBFS}$

Figure 6-359. RX Output FFT at 2.6 GHz

6.12.10 RX Typical Characteristics at 2.6 GHz (continued)

Typical values at $T_A = +25^\circ\text{C}$, ADC Sampling Rate = 2949.12 GHz. Default conditions: output sample rate = 491.52MSPS (decimate by 6), PLL clock mode with $f_{REF} = 491.52\text{ MHz}$, $A_{IN} = -3\text{ dBFS}$, DSA setting = 4 dB.

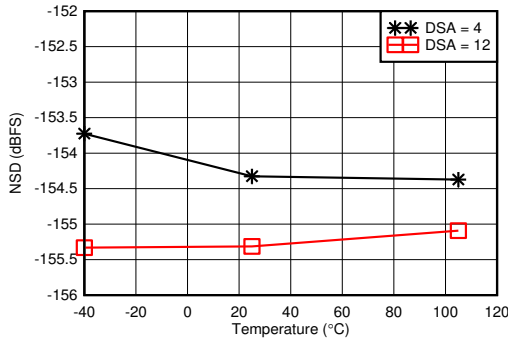

With 2.6 GHz matching, 12.5-MHz offset from tone

Figure 6-360. RX Noise Spectral Density vs Temperature at 2.6 GHz

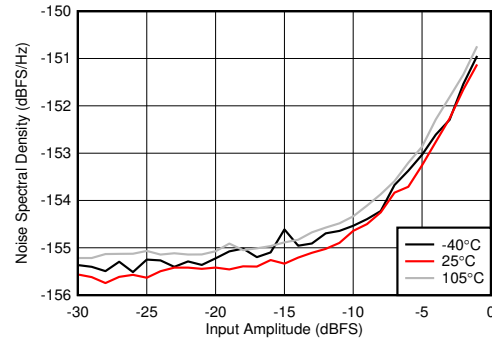

With 2.6 GHz matching, DSA Setting = 12 dB, 12.5-MHz offset from tone

Figure 6-361. RX Noise Spectral Density vs Input Amplitude and Temperature at 2.6 GHz

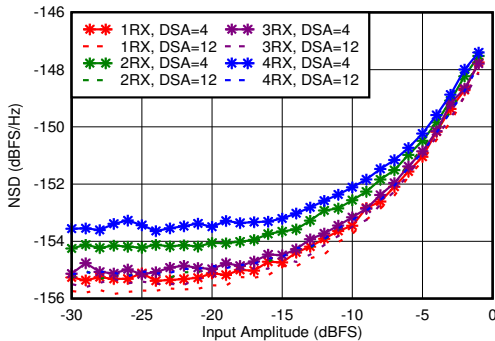

With 2.6 GHz matching, 12.5-MHz offset from tone

Figure 6-362. RX Noise Spectral Density vs Input Amplitude and Channel at 2.6 GHz

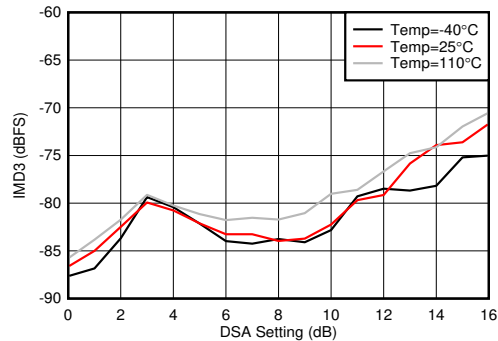

With 2.6 GHz matching, each tone -7 dBFS , tone spacing = 20 MHz

Figure 6-363. RX IMD3 vs DSA Setting and Temperature at 2.6 GHz

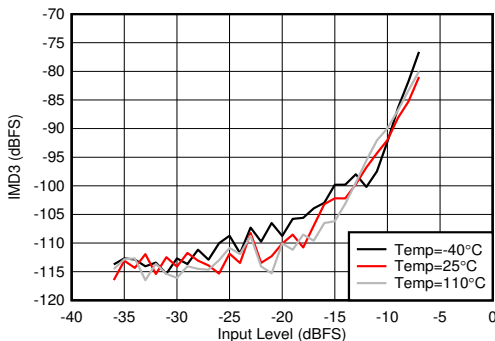

With 2.6 GHz matching, tone spacing = 20 MHz, DSA = 4 dB

Figure 6-364. RX IMD3 vs Input Level and Temperature at 2.6 GHz

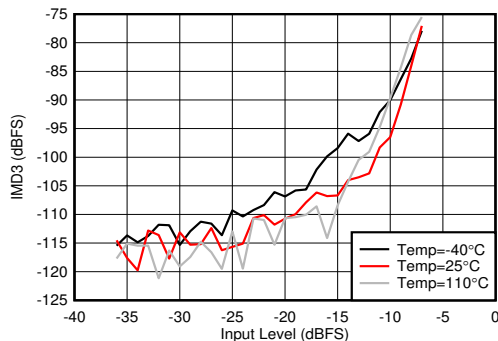

With 2.6 GHz matching, tone spacing = 20 MHz, DSA = 12 dB

Figure 6-365. RX IMD3 vs Input Level and Temperature at 2.6 GHz

6.12.10 RX Typical Characteristics at 2.6 GHz (continued)

Typical values at $T_A = +25^\circ\text{C}$, ADC Sampling Rate = 2949.12 GHz. Default conditions: output sample rate = 491.52MSPS (decimate by 6), PLL clock mode with $f_{REF} = 491.52\text{ MHz}$, $A_{IN} = -3\text{ dBFS}$, DSA setting = 4 dB.

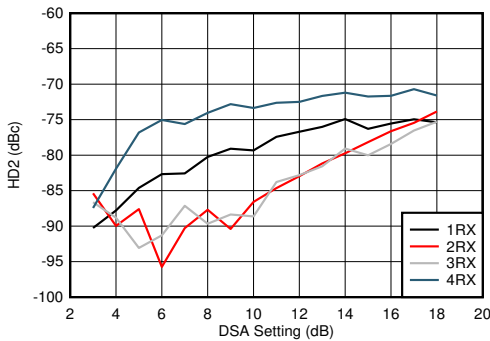

With 2.6 GHz matching, DDC bypass mode (TI only mode for characterization)

Figure 6-366. RX HD2 vs DSA Setting and Channel at 2.6 GHz

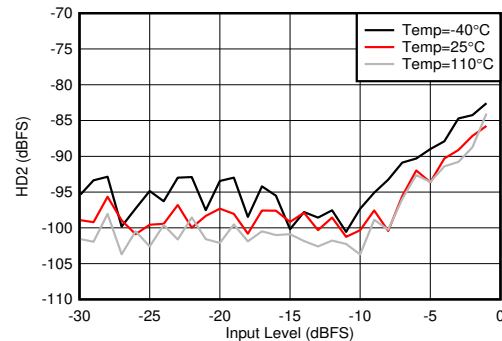

With 2.6 GHz matching, DDC bypass mode (TI only mode for characterization)

Figure 6-367. RX HD2 vs Input Level and Temperature at 2.6 GHz

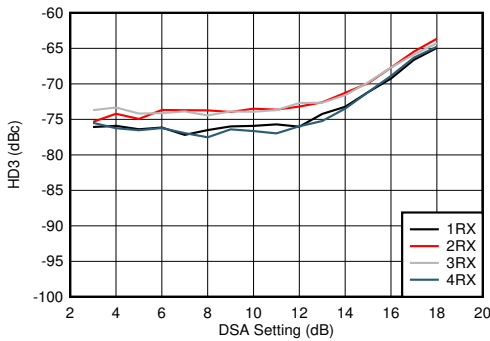

With 2.6 GHz matching, DDC bypass mode (TI only mode for characterization)

Figure 6-368. RX HD3 vs DSA Setting and Channel at 2.6 GHz

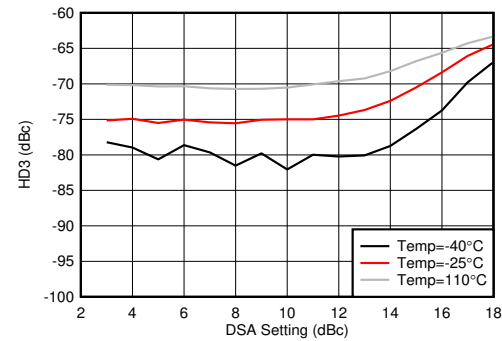

With 2.6 GHz matching, DDC bypass mode (TI only mode for characterization)

Figure 6-369. RX HD3 vs DSA Setting and Temperature at 2.6 GHz

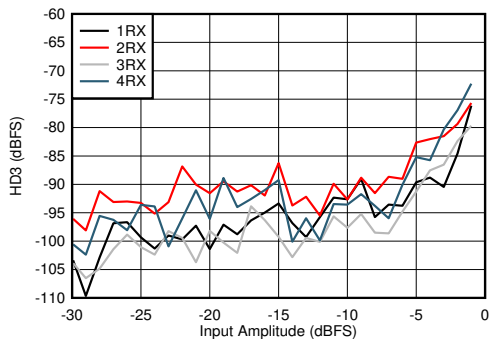

With 2.6 GHz matching, DDC bypass mode (TI only mode for characterization)

Figure 6-370. RX HD3 vs Input Level and Channel at 2.6 GHz

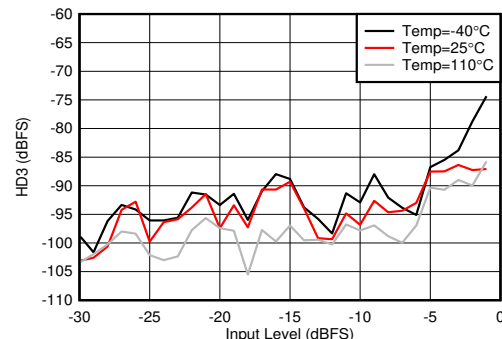

With 2.6 GHz matching, DDC bypass mode (TI only mode for characterization)

Figure 6-371. RX HD3 vs Input Level and Temperature at 2.6 GHz

6.12.10 RX Typical Characteristics at 2.6 GHz (continued)

Typical values at $T_A = +25^\circ\text{C}$, ADC Sampling Rate = 2949.12 MHz. Default conditions: output sample rate = 491.52MSPS (decimate by 6), PLL clock mode with $f_{REF} = 491.52\text{ MHz}$, $A_{IN} = -3\text{ dBFS}$, DSA setting = 4 dB.

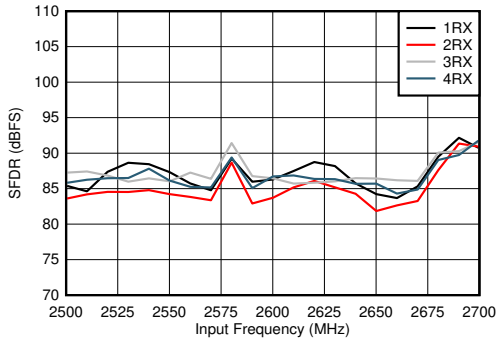

With 2.6 GHz matching

Figure 6-372. RX In-Band SFDR ($\pm 200\text{ MHz}$) vs Frequency With $A_{IN} = -1\text{ dBFS}$ at 2.6 GHz

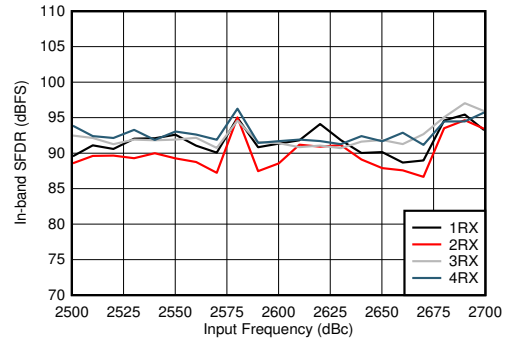

With 2.6 GHz matching

Figure 6-373. RX In-Band SFDR ($\pm 200\text{ MHz}$) vs Frequency With $A_{IN} = -6\text{ dBFS}$ at 2.6 GHz

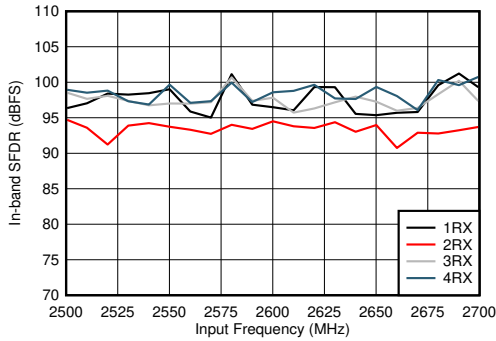

With 2.6 GHz matching

Figure 6-374. RX In-Band SFDR ($\pm 200\text{ MHz}$) vs Frequency With $A_{IN} = -12\text{ dBFS}$ at 2.6 GHz

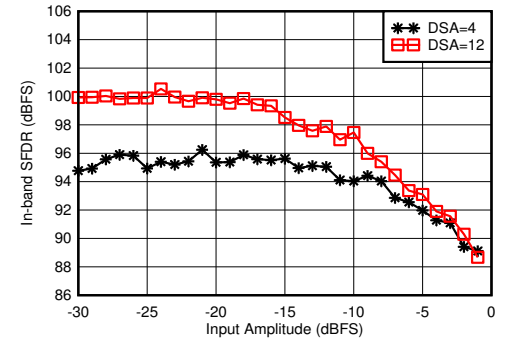

With 2.6 GHz matching

Figure 6-375. RX In-Band SFDR ($\pm 200\text{ MHz}$) vs Input Amplitude at 2.6 GHz

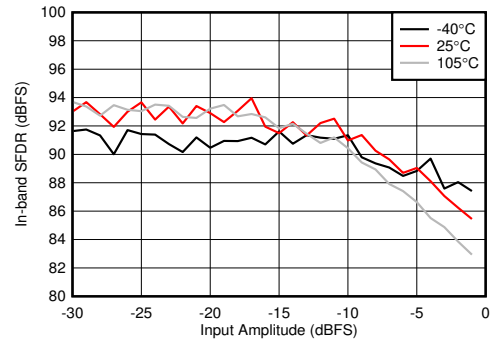

With 2.6 GHz matching

Figure 6-376. RX In-Band SFDR ($\pm 200\text{ MHz}$) vs Input Amplitude and Temperature at 2.6 GHz

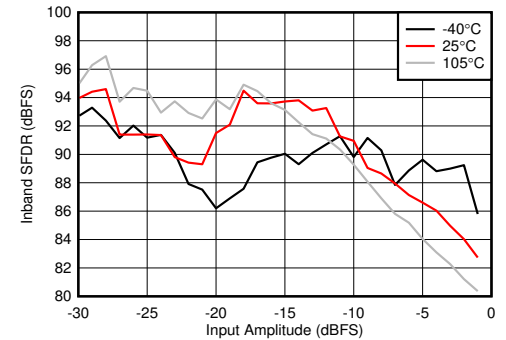

With 2.6 GHz matching, decimate by 8, DSA Setting = 12 dB

Figure 6-377. RX Inband SFDR ($\pm 150\text{ MHz}$) vs Input Amplitude and Temperature at 2.6 GHz

6.12.10 RX Typical Characteristics at 2.6 GHz (continued)

Typical values at $T_A = +25^\circ\text{C}$, ADC Sampling Rate = 2949.12 GHz. Default conditions: output sample rate = 491.52MSPS (decimate by 6), PLL clock mode with $f_{REF} = 491.52\text{ MHz}$, $A_{IN} = -3\text{ dBFS}$, DSA setting = 4 dB.

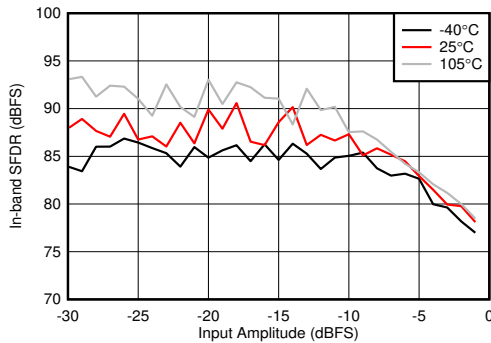

With 2.6 GHz matching, decimate by 4

Figure 6-378. RX In-Band SFDR ($\pm 300\text{ MHz}$) vs Input Amplitude and Temperature at 2.6 GHz

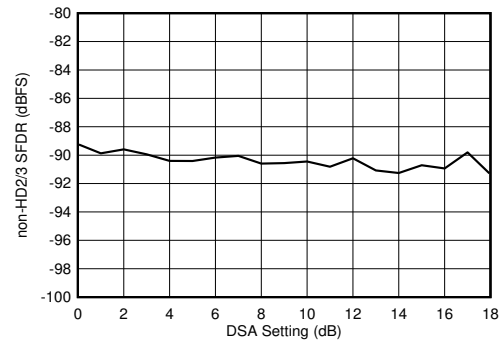

With 2.6 GHz matching

Figure 6-379. RX Non-HD2/3 vs DSA Setting at 2.6 GHz

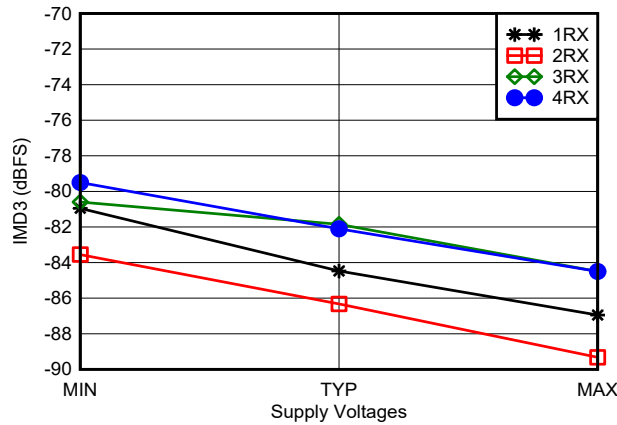

With 2.6 GHz matching, -7 dBFS each tone, 20-MHz tone spacing, all supplies at MIN, TYP, or MAX recommended operating voltages

Figure 6-380. RX IMD3 vs Supply and Channel at 2.6 GHz

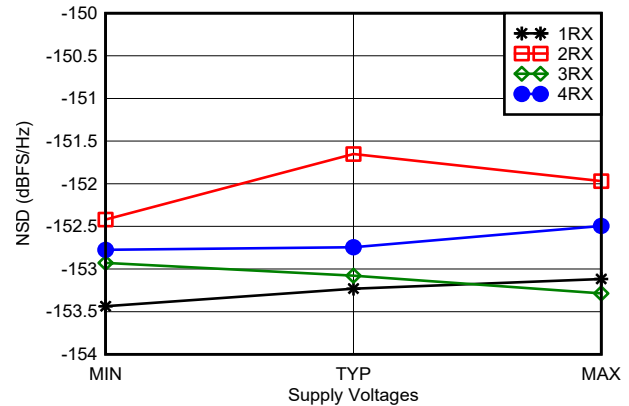

With 2.6 GHz matching, 12.5-MHz offset, all supplies at MIN, TYP, or MAX recommended operating voltages

Figure 6-381. RX Noise Spectral Density vs Supply and Channel at 2.6 GHz

6.12.11 RX Typical Characteristics at 3.5 GHz

Typical values at $T_A = +25^\circ\text{C}$, ADC Sampling Rate = 2949.12 GHz. Default conditions: output sample rate = 491.52MSPS (decimate by 6), PLL clock mode with $f_{REF} = 491.52\text{ MHz}$, $A_{IN} = -3\text{ dBFS}$, DSA setting = 4 dB.

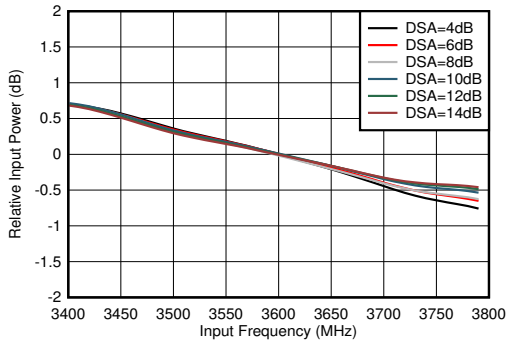

With 3.6 GHz matching, normalized to 3.6 GHz

Figure 6-382. RX In-Band Gain Flatness, $f_{IN} = 3600\text{ MHz}$

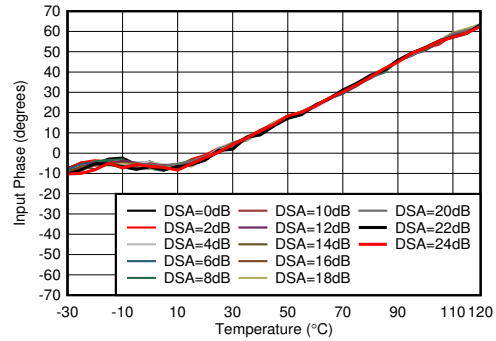

With 3.6 GHz matching, normalized to phase at 25°C

Figure 6-383. RX Input Phase vs Temperature at 3.6 GHz

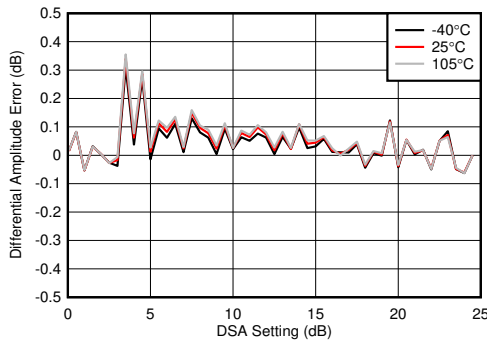

With 3.6 GHz matching

$$\text{Differential Amplitude Error} = P_{IN}(\text{DSA Setting} - 1) - P_{IN}(\text{DSA Setting}) + 1$$

Figure 6-384. RX Uncalibrated Differential Amplitude Error vs DSA Setting at 3.6 GHz

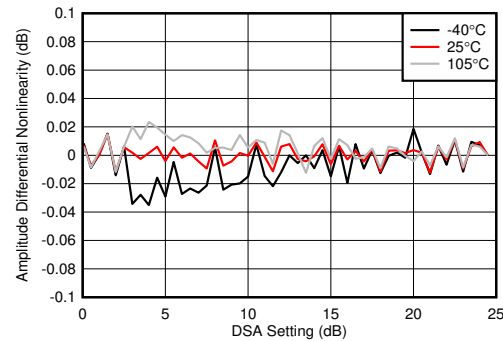

With 3.6 GHz matching

$$\text{Differential Amplitude Error} = P_{IN}(\text{DSA Setting} - 1) - P_{IN}(\text{DSA Setting}) + 1$$

Figure 6-385. RX Calibrated Differential Amplitude Error vs DSA Setting at 3.6 GHz

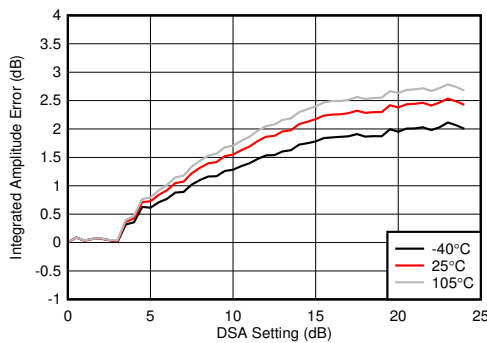

With 3.6 GHz matching

$$\text{Integrated Amplitude Error} = P_{IN}(\text{DSA Setting}) - P_{IN}(\text{DSA Setting} = 0) + (\text{DSA Setting})$$

Figure 6-386. RX Uncalibrated Integrated Amplitude Error vs DSA Setting at 3.6 GHz

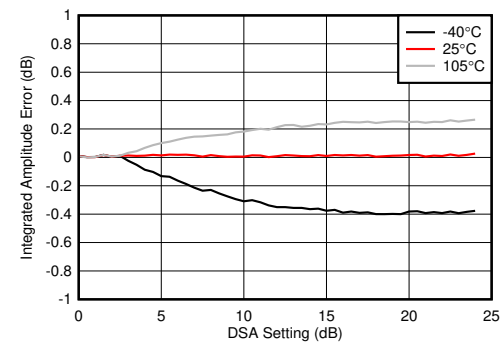

With 3.6 GHz matching

$$\text{Integrated Amplitude Error} = P_{IN}(\text{DSA Setting}) - P_{IN}(\text{DSA Setting} = 0) + (\text{DSA Setting})$$

Figure 6-387. RX Calibrated Integrated Amplitude Error vs DSA Setting at 3.6 GHz

6.12.11 RX Typical Characteristics at 3.5 GHz (continued)

Typical values at $T_A = +25^\circ\text{C}$, ADC Sampling Rate = 2949.12 MHz. Default conditions: output sample rate = 491.52MSPS (decimate by 6), PLL clock mode with $f_{REF} = 491.52\text{ MHz}$, $A_{IN} = -3\text{ dBFS}$, DSA setting = 4 dB.

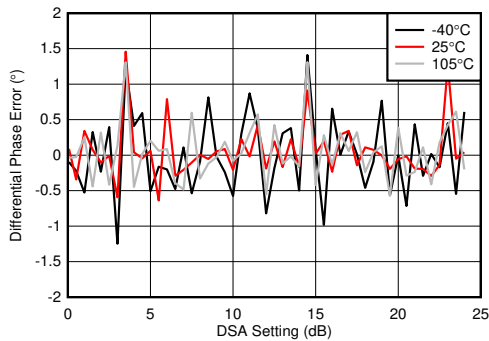

With 3.6 GHz matching
Differential Phase Error = $\text{Phase}_{IN}(\text{DSA Setting} - 1) - \text{Phase}_{IN}(\text{DSA Setting})$

Figure 6-388. RX Uncalibrated Phase Error vs DSA Setting at 3.6 GHz

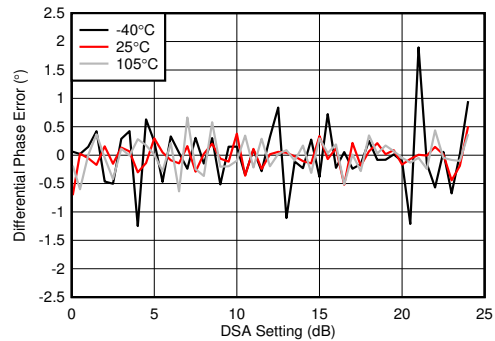

With 3.6 GHz matching
Differential Phase Error = $\text{Phase}_{IN}(\text{DSA Setting} - 1) - \text{Phase}_{IN}(\text{DSA Setting})$

Figure 6-389. RX Calibrated Differential Phase Error vs DSA Setting at 3.6 GHz

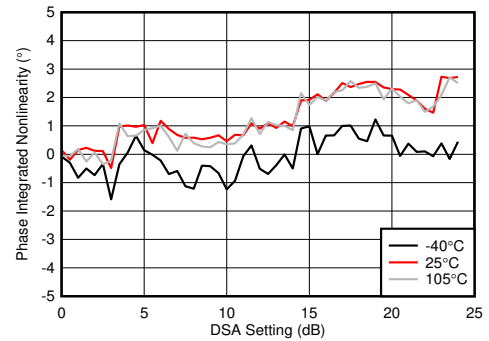

With 3.6 GHz matching
Integrated Phase Error = $\text{Phase}(\text{DSA Setting}) - \text{Phase}(\text{DSA Setting} = 0)$

Figure 6-390. RX Uncalibrated Integrated Phase Error vs DSA Setting at 3.6 GHz

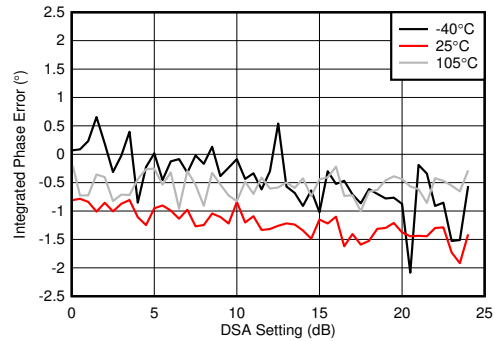

With 3.6 GHz matching
Integrated Phase Error = $\text{Phase}(\text{DSA Setting}) - \text{Phase}(\text{DSA Setting} = 0)$

Figure 6-391. RX Calibrated Integrated Phase Error vs DSA Setting at 3.6 GHz

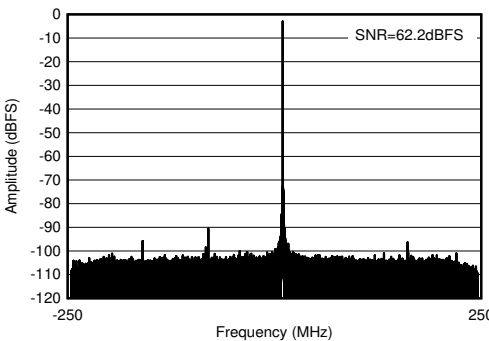

With 3.6 GHz matching, $f_{IN} = 3610\text{ MHz}$, $A_{IN} = -3\text{ dBFS}$

Figure 6-392. RX Output FFT at 3.6 GHz

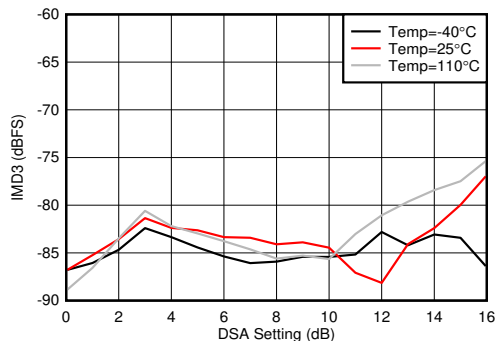

With 3.5 GHz matching, each tone at -7 dBFS , 20-MHz tone spacing

Figure 6-393. RX IMD3 vs DSA Setting and Temperature at 3.6 GHz

6.12.11 RX Typical Characteristics at 3.5 GHz (continued)

Typical values at $T_A = +25^\circ\text{C}$, ADC Sampling Rate = 2949.12 MHz. Default conditions: output sample rate = 491.52MSPS (decimate by 6), PLL clock mode with $f_{REF} = 491.52\text{ MHz}$, $A_{IN} = -3\text{ dBFS}$, DSA setting = 4 dB.

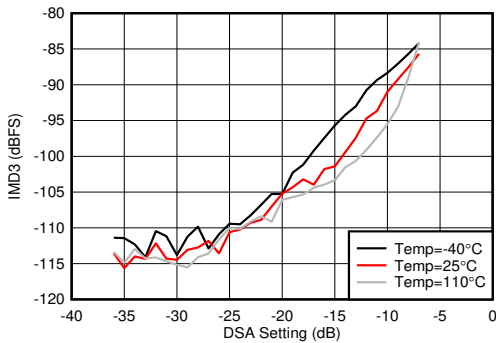

With 3.5 GHz matching, 20-MHz tone spacing

Figure 6-394. RX IMD3 vs Input Level and Temperature at 3.6 GHz

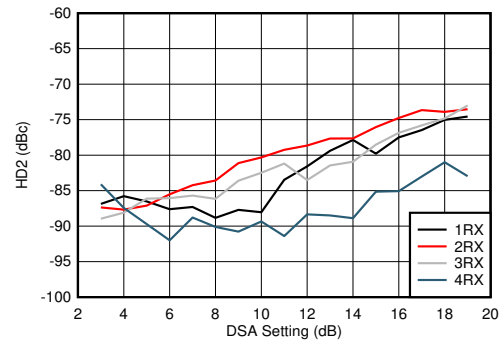

With 3.5 GHz matching, DDC bypass mode (TI only mode for characterization)

Figure 6-395. RX HD2 vs DSA Setting and Channel at 3.6 GHz

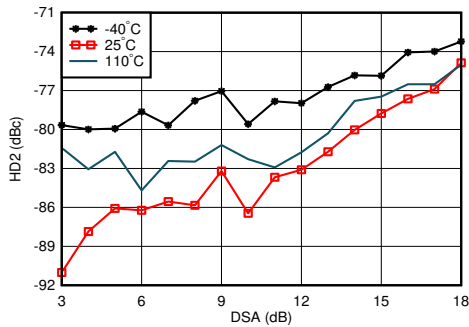

With 3.5 GHz matching, DDC bypass mode (TI only mode for characterization)

Figure 6-396. RX HD2 vs DSA Setting and Temperature at 3.6 GHz

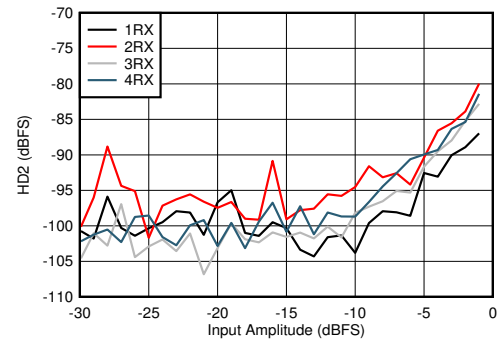

With 3.5 GHz matching, DDC bypass mode (TI only mode for characterization)

Figure 6-397. RX HD2 vs Input Level and Channel at 3.6 GHz

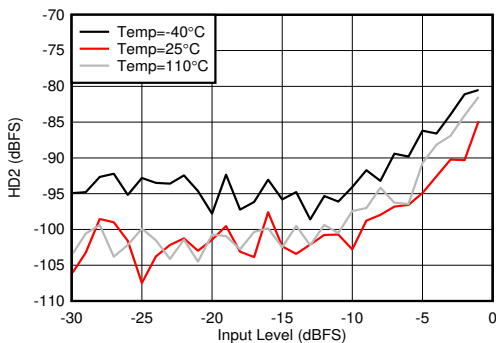

With 3.5 GHz matching, DDC bypass mode (TI only mode for characterization)

Figure 6-398. RX HD2 vs Input Level and Temperature at 3.6 GHz

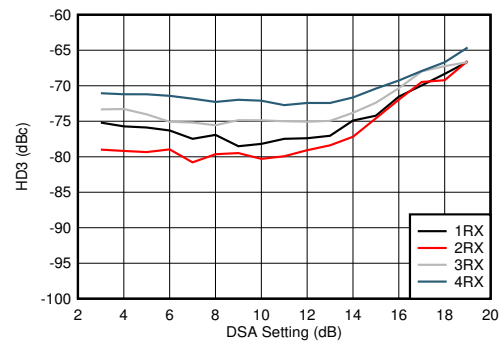

With 3.5 GHz matching, DDC bypass mode (TI only mode for characterization)

Figure 6-399. RX HD3 vs DSA Setting and Channel at 3.6 GHz

6.12.11 RX Typical Characteristics at 3.5 GHz (continued)

Typical values at $T_A = +25^\circ\text{C}$, ADC Sampling Rate = 2949.12 MHz. Default conditions: output sample rate = 491.52MSPS (decimate by 6), PLL clock mode with $f_{REF} = 491.52\text{ MHz}$, $A_{IN} = -3\text{ dBFS}$, DSA setting = 4 dB.

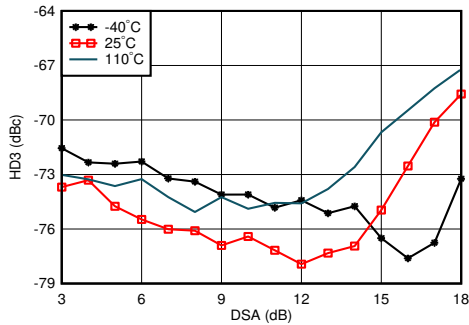

With 3.5 GHz matching, DDC bypass mode (TI only mode for characterization)

Figure 6-400. RX HD3 vs DSA Setting and Temperature at 3.6 GHz

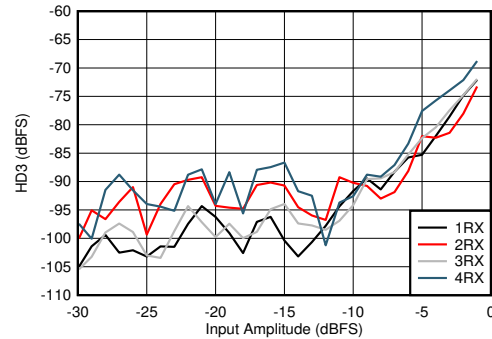

With 3.5 GHz matching, DDC bypass mode (TI only mode for characterization)

Figure 6-401. RX HD3 vs Input Level and Channel at 3.6 GHz

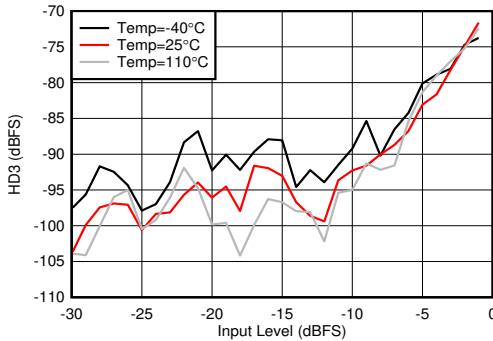

With 3.5 GHz matching, DDC bypass mode (TI only mode for characterization)

Figure 6-402. RX HD3 vs Input Level and Temperature at 3.6 GHz

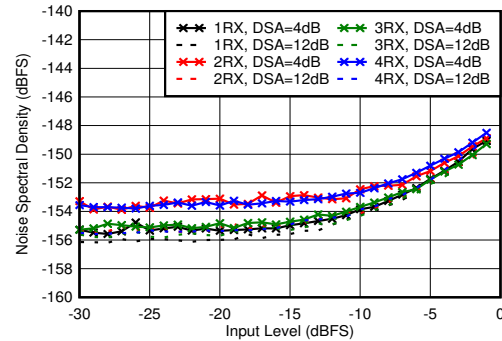

With 3.5 GHz matching, 12.5-MHz offset from tone

Figure 6-403. RX Noise Spectral Density vs Input Level and DSA Setting at 3.6 GHz

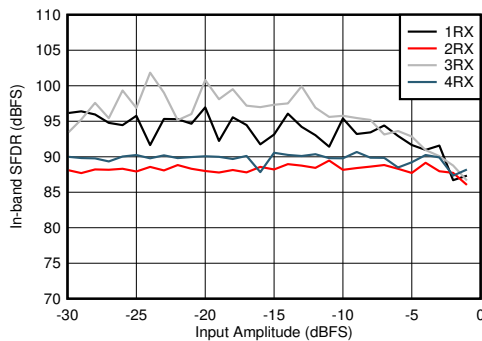

With 3.5 GHz matching

Figure 6-404. RX In-Band SFDR ($\pm 200\text{ MHz}$) vs Input Level and Channel at 3.6 GHz

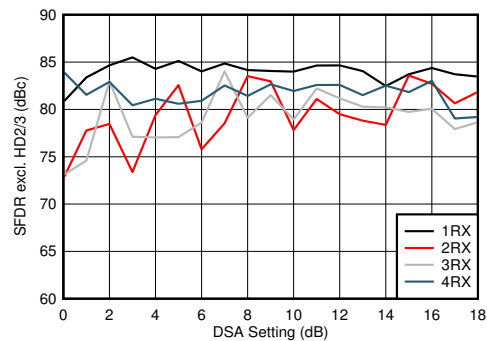

With 3.5 GHz matching

Figure 6-405. RX SFDR Excluding HD2/3 vs DSA Setting and Channel at 3.6 GHz

6.12.11 RX Typical Characteristics at 3.5 GHz (continued)

Typical values at $T_A = +25^\circ\text{C}$, ADC Sampling Rate = 2949.12 MHz. Default conditions: output sample rate = 491.52MSPS (decimate by 6), PLL clock mode with $f_{REF} = 491.52\text{ MHz}$, $A_{IN} = -3\text{ dBFS}$, DSA setting = 4 dB.

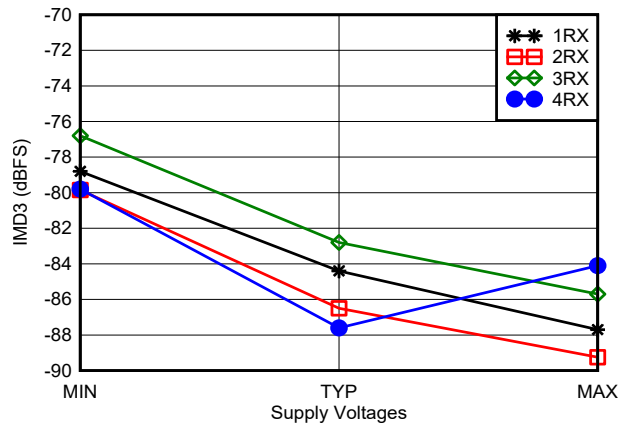

With 3.6 GHz matching, -7 dBFS each tone, 20-MHz tone spacing, all supplies at MIN, TYP, or MAX recommended operating voltages

Figure 6-406. RX IMD3 vs Supply Voltage and Channel at 3.6 GHz

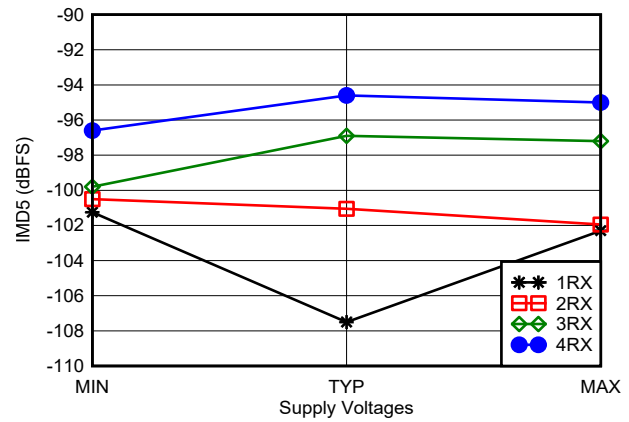

With 3.6 GHz matching, -7 dBFS each tone, 20-MHz tone spacing, all supplies at MIN, TYP, or MAX recommended operating voltages

Figure 6-407. RX IMD5 vs Supply Voltage and Channel at 3.6 GHz

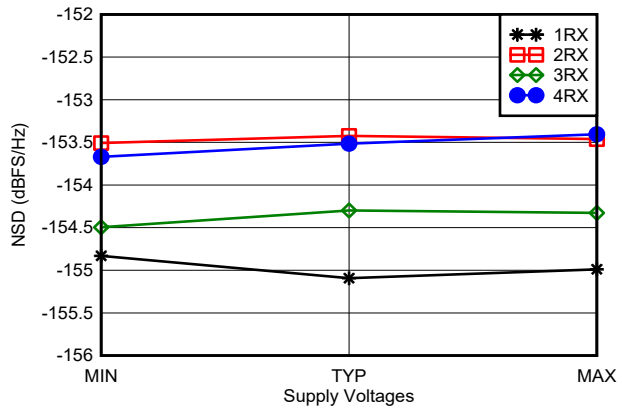

With 3.6 GHz matching, tone at -20 dBFS, 12.5-MHz offset frequency, all supplies at MIN, TYP, or MAX recommended operating voltages

Figure 6-408. RX Noise Spectral Density vs Supply Voltage and Channel at 3.6 GHz

6.12.12 RX Typical Characteristics at 4.9 GHz

Typical values at $T_A = +25^\circ\text{C}$, ADC Sampling Rate = 2949.12 MHz. Default conditions: output sample rate = 491.52MSPS (decimate by 6), PLL clock mode with $f_{REF} = 491.52\text{ MHz}$, $A_{IN} = -3\text{ dBFS}$, DSA setting = 4 dB.

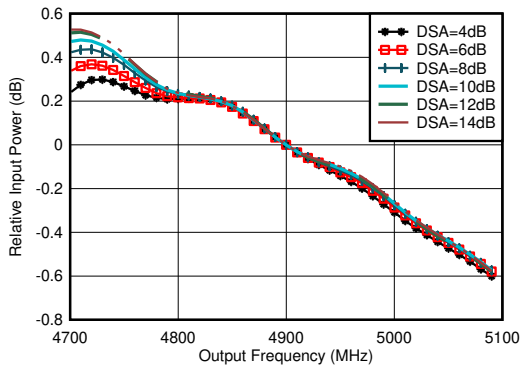

With matching, normalized to power at 4.9GHz for each DSA setting

Figure 6-409. RX Inband Gain Flatness, $f_{IN} = 4900\text{ MHz}$

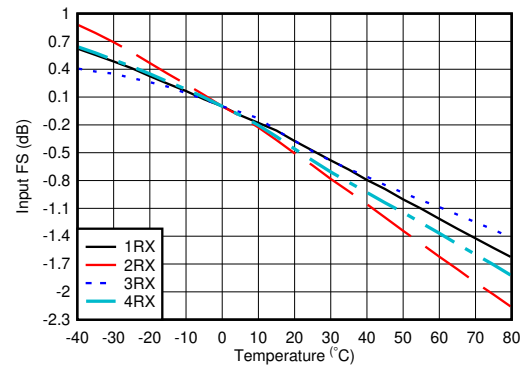

With 4.9 GHz matching, normalized to fullscale at 25°C for each channel

Figure 6-410. RX Input Fullscale vs Temperature and Channel at 4.9 GHz

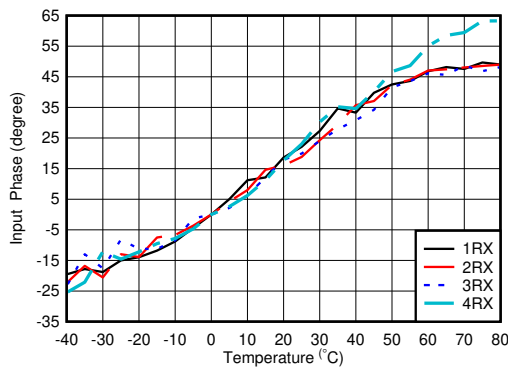

With 4.9 GHz matching, normalized to phase at 25°C

Figure 6-411. RX Input Phase vs Temperature and DSA at $f_{OUT} = 4.9\text{ GHz}$

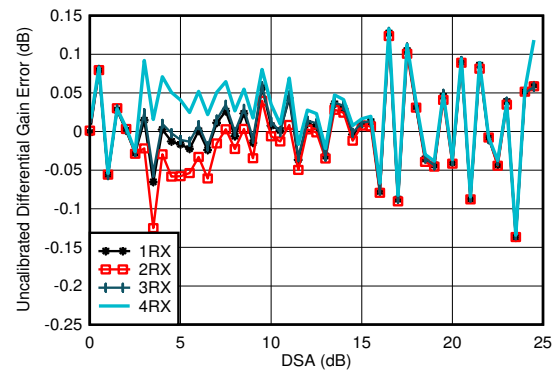

With 4.9 GHz matching

$$\text{Differential Amplitude Error} = P_{IN}(\text{DSA Setting} - 1) - P_{IN}(\text{DSA Setting}) + 1$$

Figure 6-412. RX Uncalibrated Differential Amplitude Error vs DSA Setting at 4.9 GHz

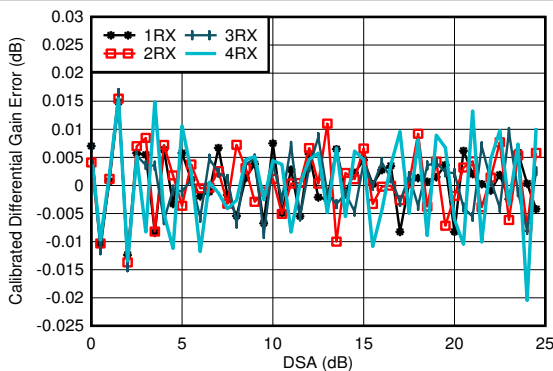

With 4.9 GHz matching

$$\text{Differential Amplitude Error} = P_{IN}(\text{DSA Setting} - 1) - P_{IN}(\text{DSA Setting}) + 1$$

Figure 6-413. RX Calibrated Differential Amplitude Error vs DSA Setting at 4.9 GHz

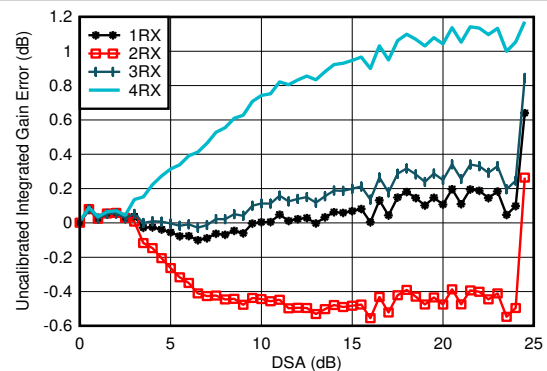

With 4.9 GHz matching

$$\text{Integrated Amplitude Error} = P_{IN}(\text{DSA Setting}) - P_{IN}(\text{DSA Setting} = 0) + (\text{DSA Setting})$$

Figure 6-414. RX Uncalibrated Integrated Amplitude Error vs DSA Setting at 4.9 GHz

6.12.12 RX Typical Characteristics at 4.9 GHz (continued)

Typical values at $T_A = +25^\circ\text{C}$, ADC Sampling Rate = 2949.12 MHz. Default conditions: output sample rate = 491.52MSPS (decimate by 6), PLL clock mode with $f_{REF} = 491.52\text{ MHz}$, $A_{IN} = -3\text{ dBFS}$, DSA setting = 4 dB.

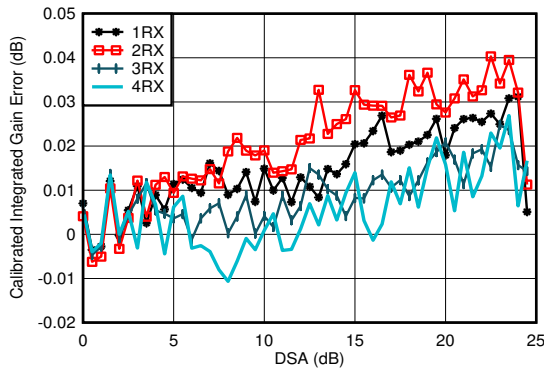

With 4.9 GHz matching
 Integrated Amplitude Error = $P_{IN}(\text{DSA Setting}) - P_{IN}(\text{DSA Setting} = 0) + (\text{DSA Setting})$

Figure 6-415. RX Calibrated Integrated Amplitude Error vs DSA Setting at 4.9 GHz

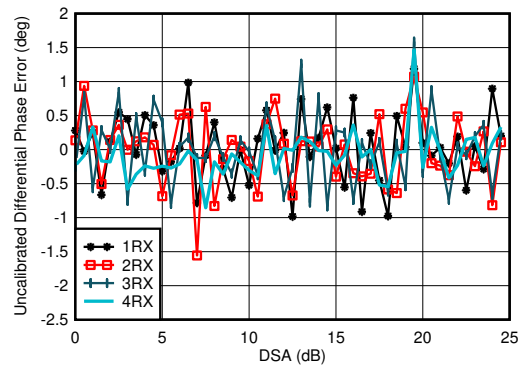

With 4.9 GHz matching
 Differential Phase Error = $\text{Phase}_{IN}(\text{DSA Setting} - 1) - \text{Phase}_{IN}(\text{DSA Setting})$

Figure 6-416. RX Uncalibrated Differential Phase Error vs DSA Setting at 4.9 GHz

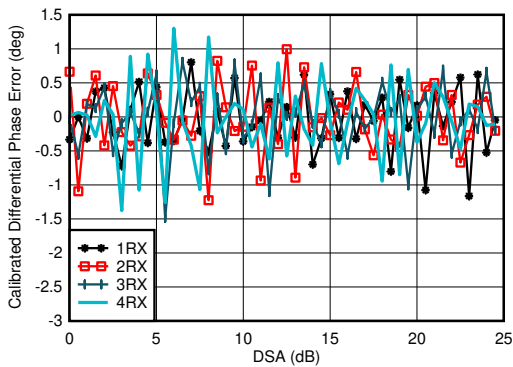

With 4.9 GHz matching
 Differential Phase Error = $\text{Phase}_{IN}(\text{DSA Setting} - 1) - \text{Phase}_{IN}(\text{DSA Setting})$

Figure 6-417. RX Calibrated Differential Phase Error vs DSA Setting at 4.9 GHz

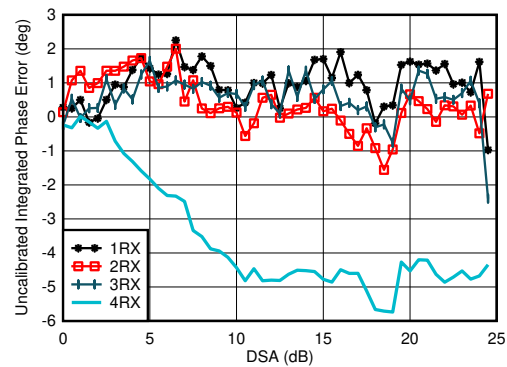

With 4.9 GHz matching
 Integrated Phase Error = $\text{Phase}(\text{DSA Setting}) - \text{Phase}(\text{DSA Setting} = 0)$

Figure 6-418. RX Uncalibrated Integrated Phase Error vs DSA Setting at 4.9 GHz

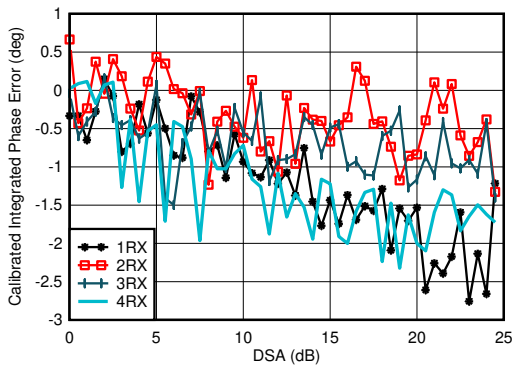

With 4.9 GHz matching
 Integrated Phase Error = $\text{Phase}(\text{DSA Setting}) - \text{Phase}(\text{DSA Setting} = 0)$

Figure 6-419. RX Calibrated Integrated Phase Error vs DSA Setting at 4.9 GHz

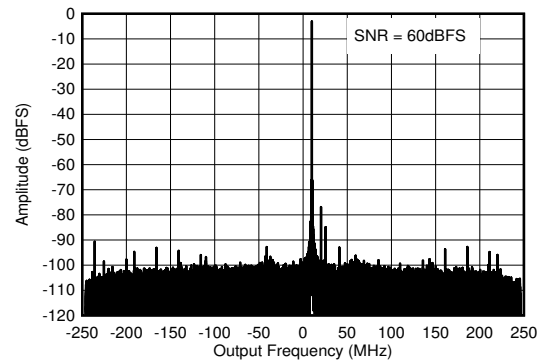

With 4.9 GHz matching, $f_{IN} = 4910\text{ MHz}$, $A_{IN} = -3\text{ dBFS}$

Figure 6-420. RX Output FFT at 4.9 GHz

6.12.12 RX Typical Characteristics at 4.9 GHz (continued)

Typical values at $T_A = +25^\circ\text{C}$, ADC Sampling Rate = 2949.12 GHz. Default conditions: output sample rate = 491.52MSPS (decimate by 6), PLL clock mode with $f_{REF} = 491.52\text{ MHz}$, $A_{IN} = -3\text{ dBFS}$, DSA setting = 4 dB.

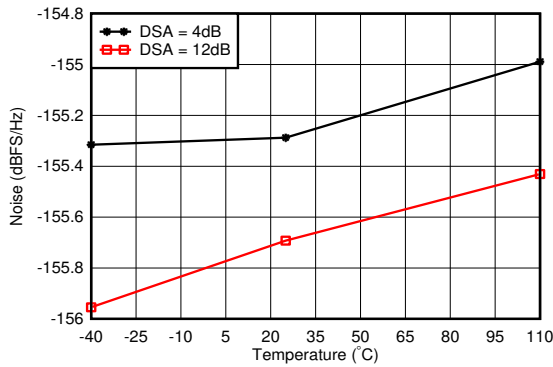

With 4.9 GHz matching, 12.5-MHz offset from tone

Figure 6-421. RX Noise Spectral Density vs Temperature at 4.9 GHz

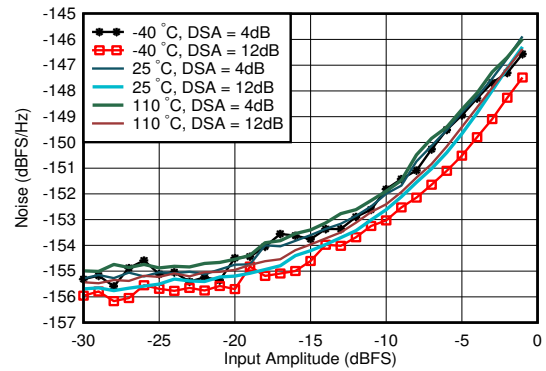

With 4.9 GHz matching, DSA Setting = 12 dB, 12.5-MHz offset from tone

Figure 6-422. RX Noise Spectral Density vs Input Amplitude and Temperature at 4.9 GHz

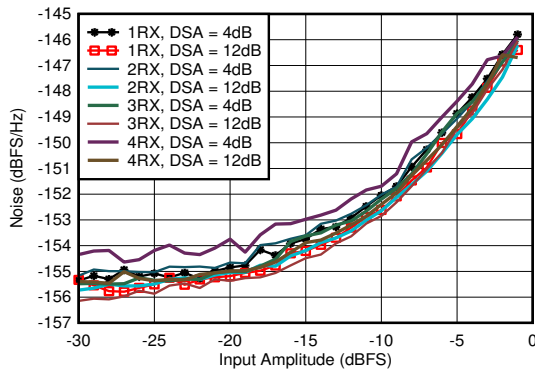

With 4.9 GHz matching, 12.5-MHz offset from tone

Figure 6-423. RX Noise Spectral Density vs Input Amplitude and Channel at 4.9 GHz

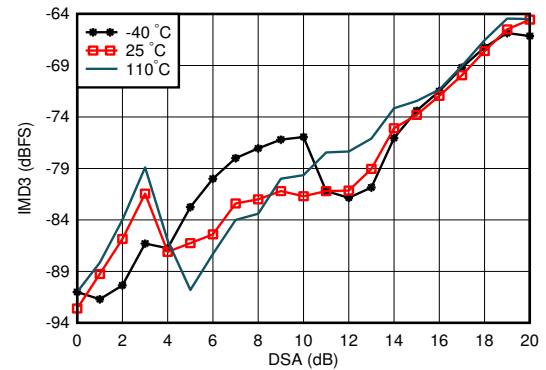

With 4.9 GHz matching, each tone -7 dBFS , tone spacing = 20 MHz

Figure 6-424. RX IMD3 vs DSA Setting and Temperature at 4.9 GHz

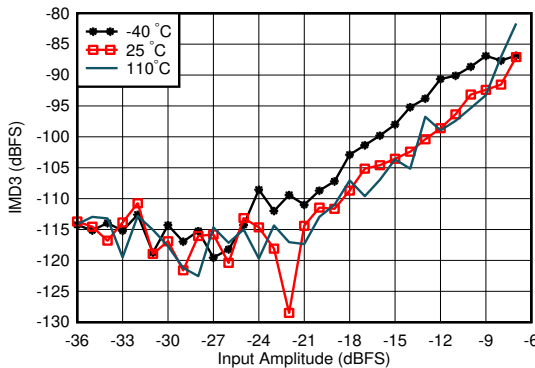

With 4.9 GHz matching, tone spacing = 20 MHz, DSA = 4 dB

Figure 6-425. RX IMD3 vs Input Level and Temperature at 4.9 GHz

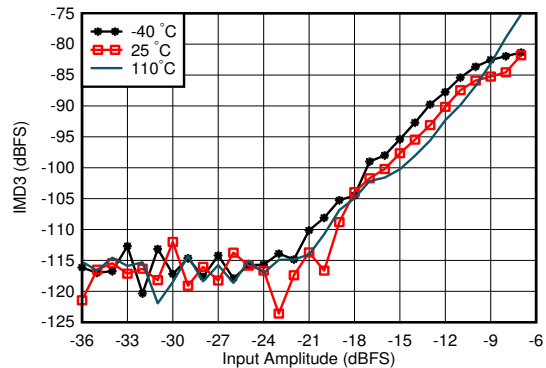

With 4.9 GHz matching, tone spacing = 20 MHz, DSA = 12 dB

Figure 6-426. RX IMD3 vs Input Level and Temperature at 4.9 GHz

6.12.12 RX Typical Characteristics at 4.9 GHz (continued)

Typical values at $T_A = +25^\circ\text{C}$, ADC Sampling Rate = 2949.12 GHz. Default conditions: output sample rate = 491.52MSPS (decimate by 6), PLL clock mode with $f_{REF} = 491.52\text{ MHz}$, $A_{IN} = -3\text{ dBFS}$, DSA setting = 4 dB.

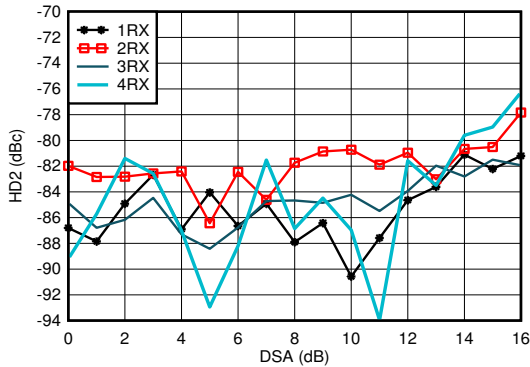

With 4.9 GHz matching, measured after HD2 trim, DDC bypass mode (TI only mode for characterization)

Figure 6-427. RX HD2 vs DSA Setting and Channel at 4.9 GHz

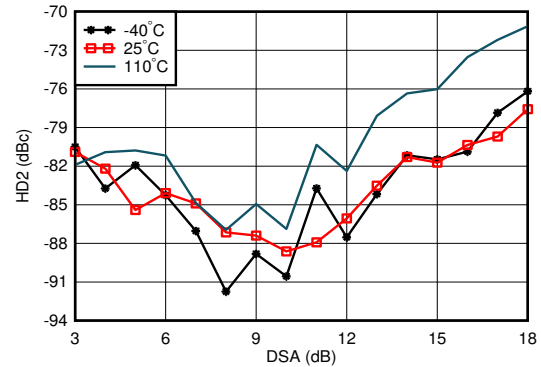

With 4.9 GHz matching, measured after HD2 trim, DDC bypass mode (TI only mode for characterization)

Figure 6-428. RX HD2 vs DSA and Temperature at 4.9 GHz

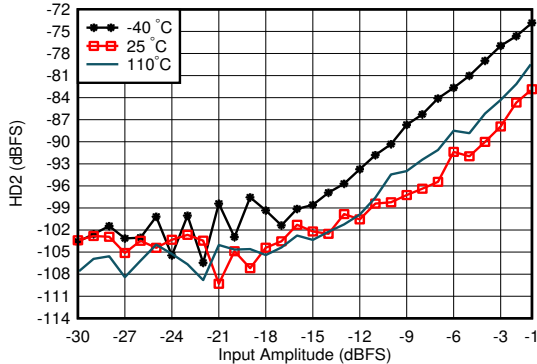

With 4.9 GHz matching, measured after HD2 trim, DDC bypass mode (TI only mode for characterization)

Figure 6-429. RX HD2 vs Input Level and Temperature at 4.9 GHz

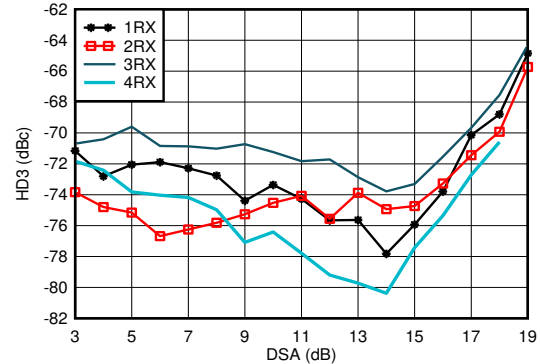

With 4.9 GHz matching, DDC bypass mode (TI only mode for characterization)

Figure 6-430. RX HD3 vs DSA Setting and Channel at 4.9 GHz

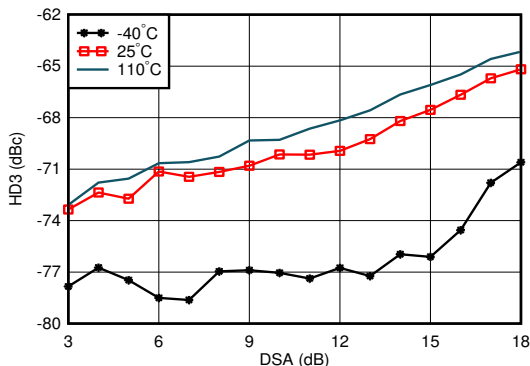

With 4.9 GHz matching, DDC bypass mode (TI only mode for characterization)

Figure 6-431. RX HD3 vs DSA Setting and Temperature at 4.9 GHz

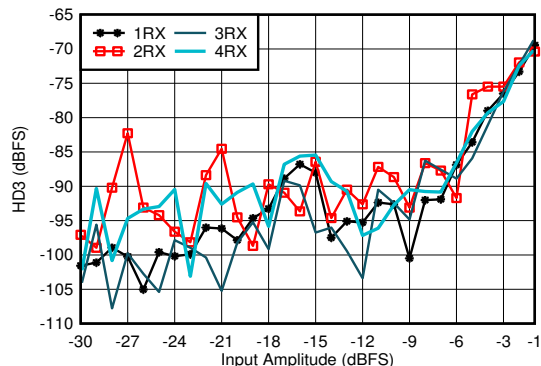

With 4.9 GHz matching, DDC bypass mode (TI only mode for characterization)

Figure 6-432. RX HD3 vs Input Level and Channel at 4.9 GHz

6.12.12 RX Typical Characteristics at 4.9 GHz (continued)

Typical values at $T_A = +25^\circ\text{C}$, ADC Sampling Rate = 2949.12 GHz. Default conditions: output sample rate = 491.52MSPS (decimate by 6), PLL clock mode with $f_{REF} = 491.52\text{ MHz}$, $A_{IN} = -3\text{ dBFS}$, DSA setting = 4 dB.

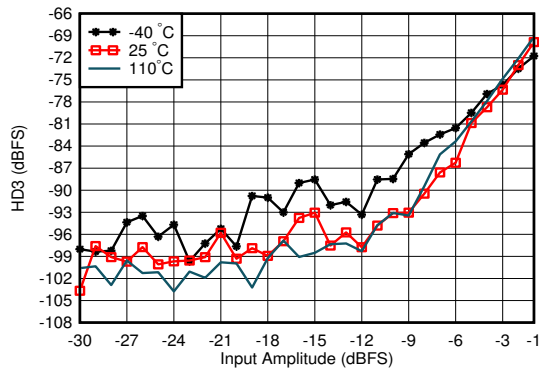

With 4.9 GHz matching, DDC bypass mode (TI only mode for characterization)

Figure 6-433. RX HD3 vs Input Level and Temperature at 4.9 GHz

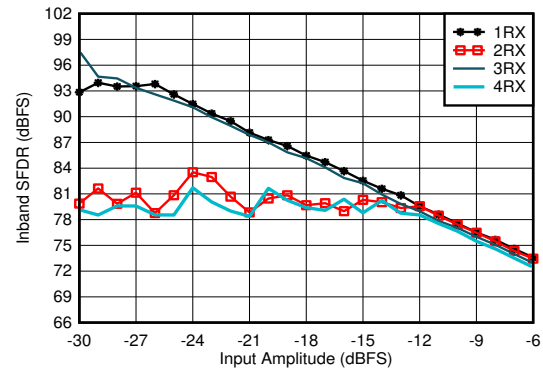

With 4.9 GHz matching, decimate by 3

Figure 6-434. RX In-Band SFDR ($\pm 400\text{ MHz}$) vs Input Amplitude and Channel at 4.9 GHz

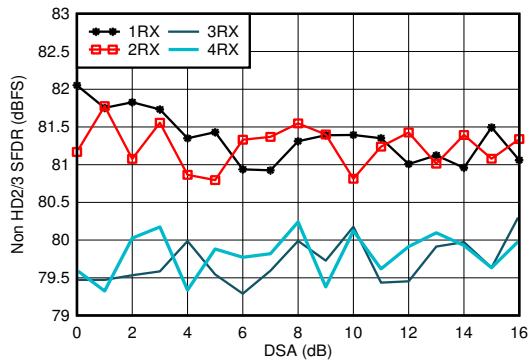

With 4.9 GHz matching

Figure 6-435. RX Non-HD2/3 vs DSA Setting at 4.9 GHz

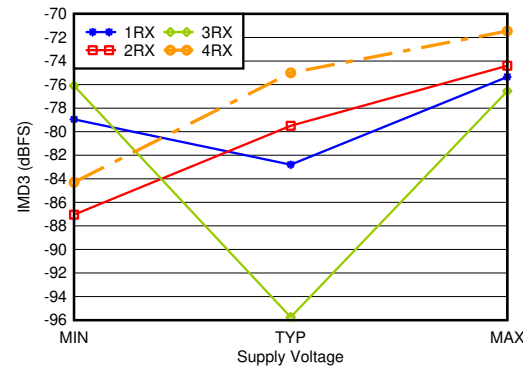

With 4.9 GHz matching, -7 dBFS each tone, 20-MHz tone spacing, all supplies at MIN, TYP, or MAX recommended operating voltages

Figure 6-436. RX IMD3 vs Supply and Channel at 4.9 GHz

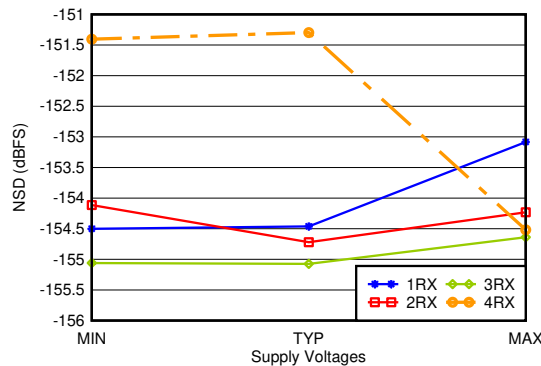

With 4.9 GHz matching, 12.5-MHz offset, all supplies at MIN, TYP, or MAX recommended operating voltages

Figure 6-437. RX Noise Spectral Density vs Supply and Channel at 4.9 GHz

6.12.13 RX Typical Characteristics at 8.1GHz

Typical values at $T_A = +25^\circ\text{C}$, ADC Sampling Rate = 2949.12 MHz. Default conditions: output sample rate = 1474.56MSPS (decimate by 2), External clock mode with $f_{\text{CLK}} = 11796.48\text{MHz}$, $A_{\text{IN}} = -3\text{ dBFS}$, DSA setting = 3 dB, 8.1GHz matching.

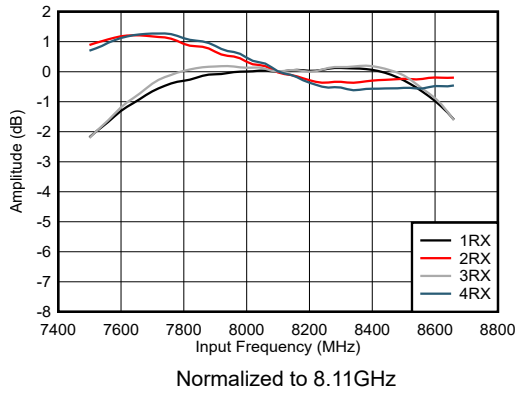

Figure 6-438. RX Amplitude vs Frequency and Channel

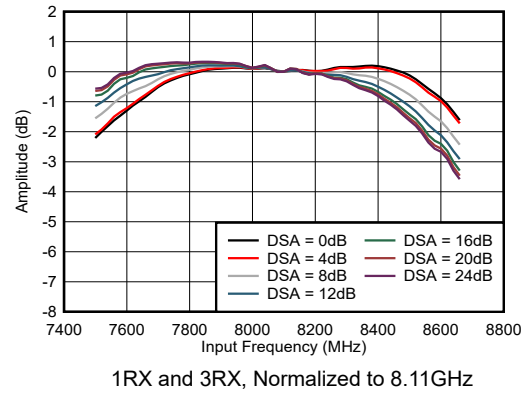

Figure 6-439. RX Amplitude vs Frequency and DSA Setting

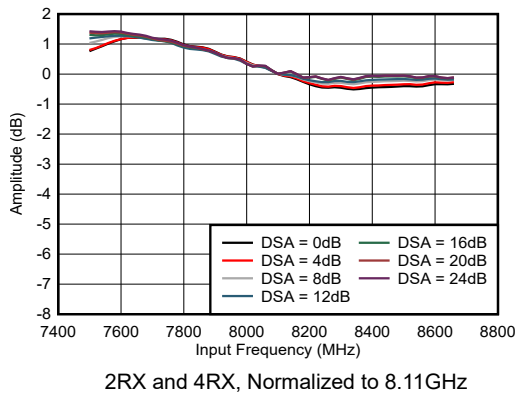

Figure 6-440. RX Amplitude vs Frequency and DSA Setting

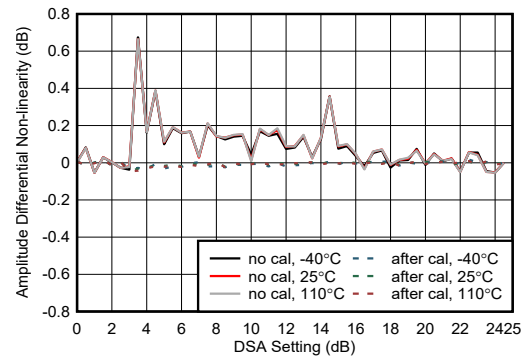

Figure 6-441. RX Amplitude Differential Nonlinearity at 8.11GHz

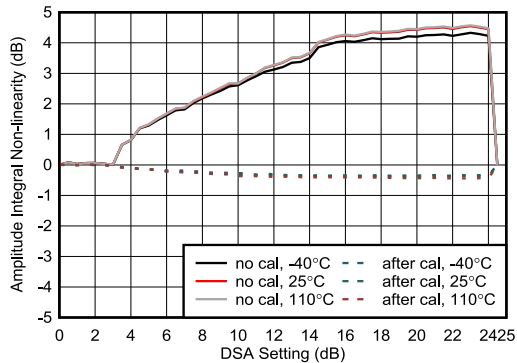

Figure 6-442. RX Amplitude Integrated Nonlinearity at 8.11GHz

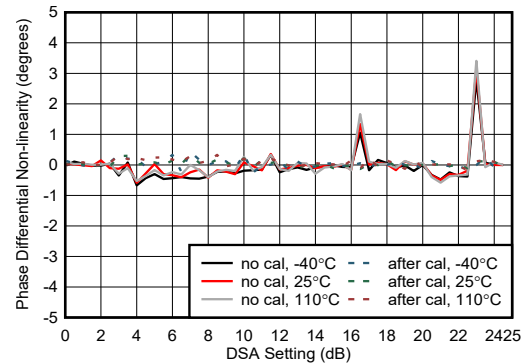

Figure 6-443. RX Phase Differential Nonlinearity at 8.11GHz

6.12.13 RX Typical Characteristics at 8.1GHz (continued)

Typical values at $T_A = +25^\circ\text{C}$, ADC Sampling Rate = 2949.12 MHz. Default conditions: output sample rate = 1474.56MSPS (decimate by 2), External clock mode with $f_{\text{CLK}} = 11796.48\text{MHz}$, $A_{\text{IN}} = -3\text{ dBFS}$, DSA setting = 3 dB, 8.1GHz matching.

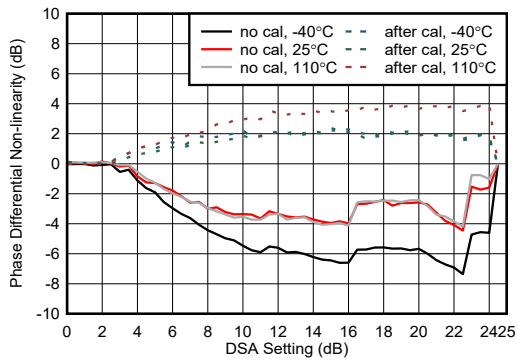

Figure 6-444. RX Phase Differential Nonlinearity at 8.1GHz

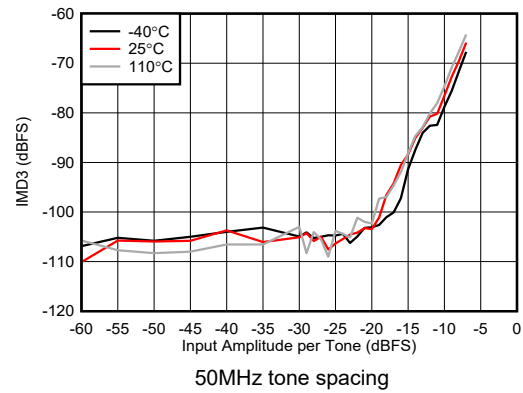

Figure 6-445. RX IMD3 vs Input Amplitude at 8.1GHz

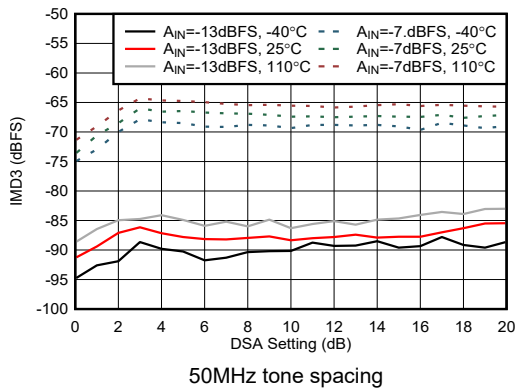

Figure 6-446. RX IMD3 vs DSA Setting at 8.1GHz

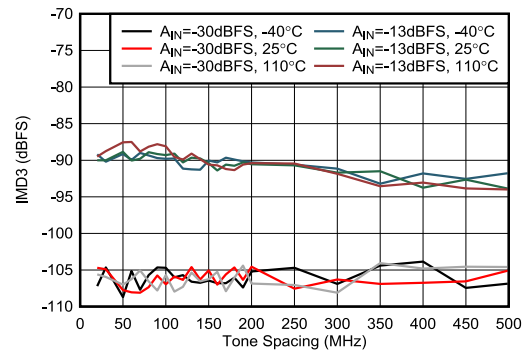

Figure 6-447. RX IMD3 vs Tone Spacing at 8.1GHz

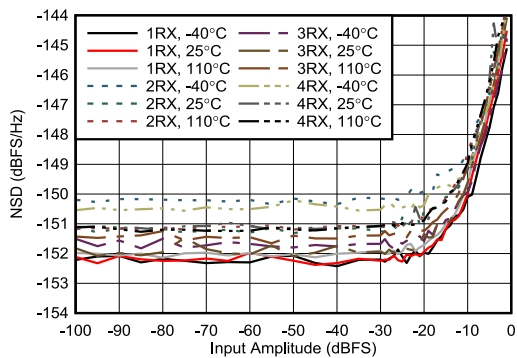

Figure 6-448. RX NSD vs Digital Amplitude at 8.1GHz

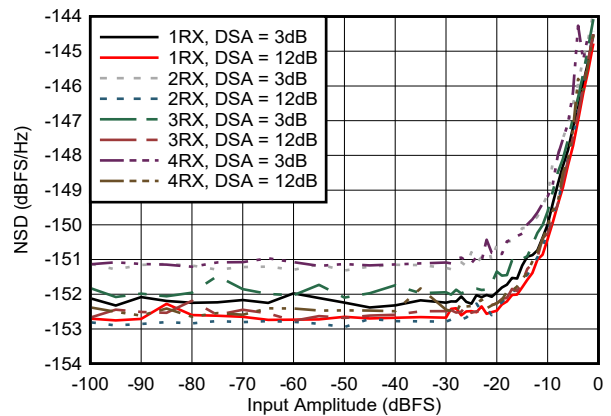

Figure 6-449. RX NSD vs Digital Amplitude at 8.1GHz

6.12.13 RX Typical Characteristics at 8.1GHz (continued)

Typical values at $T_A = +25^\circ\text{C}$, ADC Sampling Rate = 2949.12 MHz. Default conditions: output sample rate = 1474.56MSPS (decimate by 2), External clock mode with $f_{\text{CLK}} = 11796.48\text{MHz}$, $A_{\text{IN}} = -3 \text{ dBFS}$, DSA setting = 3 dB, 8.1GHz matching.

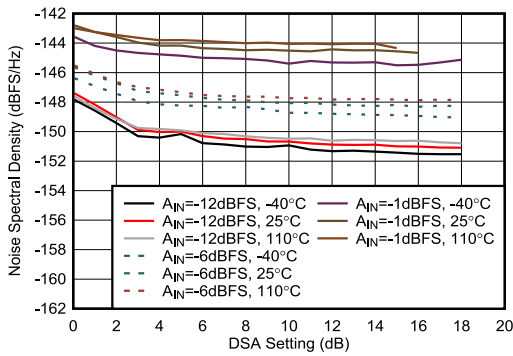

Figure 6-450. RX NSD vs DSA Setting at 8.1GHz

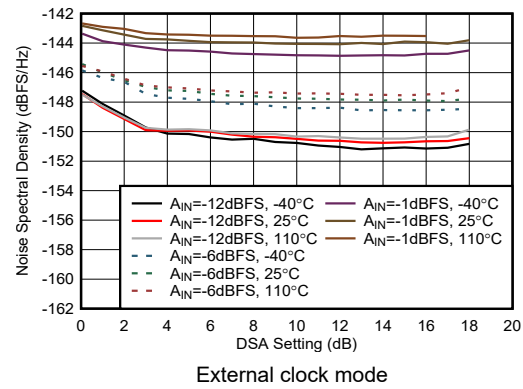

Figure 6-451. RX NSD vs DSA Setting at 8.1GHz

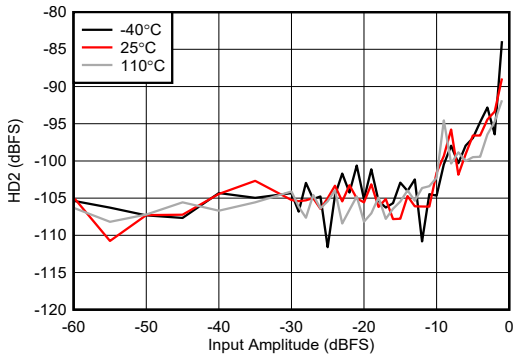

Figure 6-452. RX HD2 vs Digital Amplitude at 8.1GHz

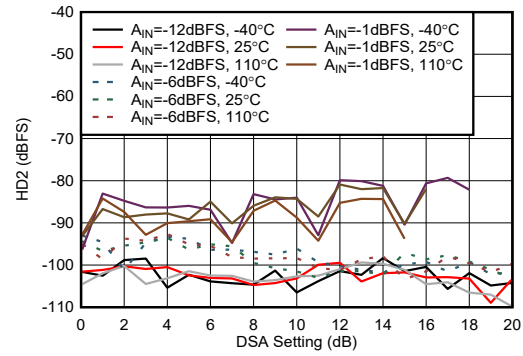

Figure 6-453. RX HD2 vs DSA Setting at 8.1GHz

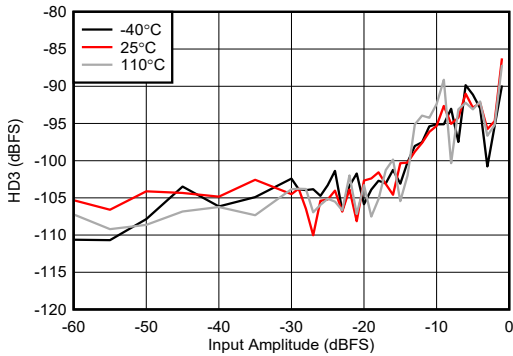

Figure 6-454. RX HD3 vs Digital Amplitude at 8.1GHz

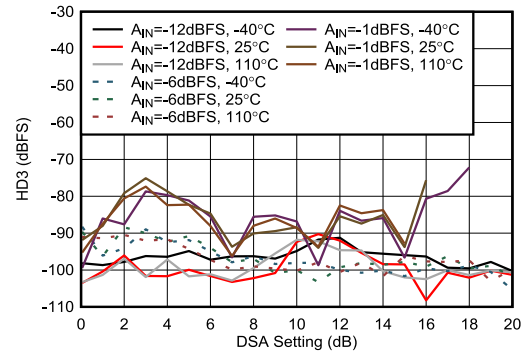

Figure 6-455. RX HD3 vs DSA Setting at 8.1GHz

6.12.13 RX Typical Characteristics at 8.1GHz (continued)

Typical values at $T_A = +25^\circ\text{C}$, ADC Sampling Rate = 2949.12 MHz. Default conditions: output sample rate = 1474.56MSPS (decimate by 2), External clock mode with $f_{\text{CLK}} = 11796.48\text{MHz}$, $A_{\text{IN}} = -3\text{ dBFS}$, DSA setting = 3 dB, 8.1GHz matching.

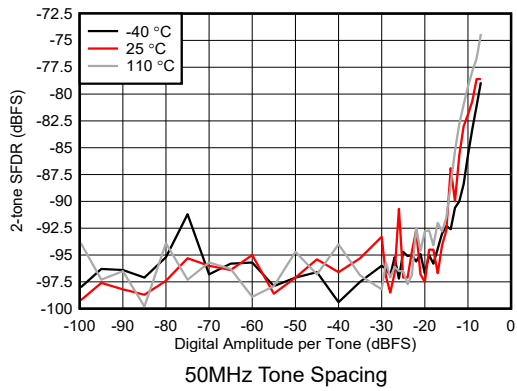

Figure 6-456. RX 2-tone SFDR vs Digital Amplitude at 8.1GHz

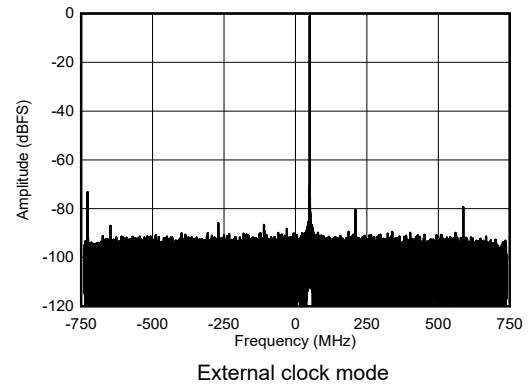

Figure 6-457. RX Single Tone Output FFT at 8.1GHz, -1dBFS

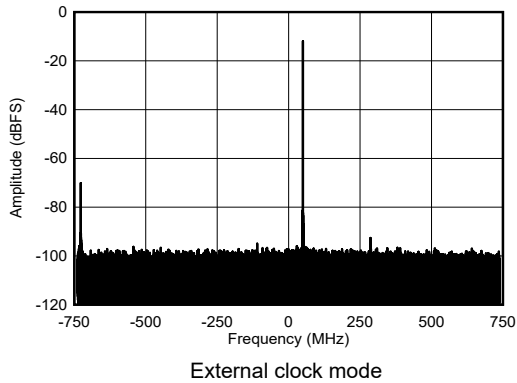

Figure 6-458. RX Single Tone Output FFT at 8.1GHz, -12dBFS

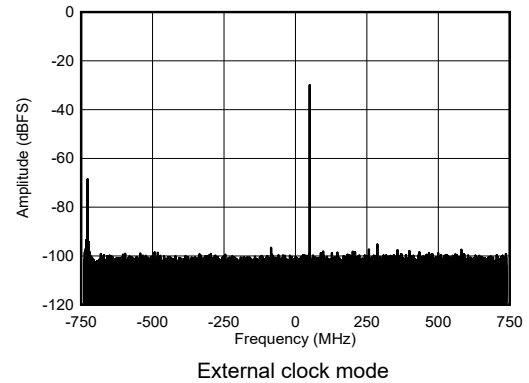

Figure 6-459. RX Single Tone Output FFT at 8.1GHz, -30dBFS

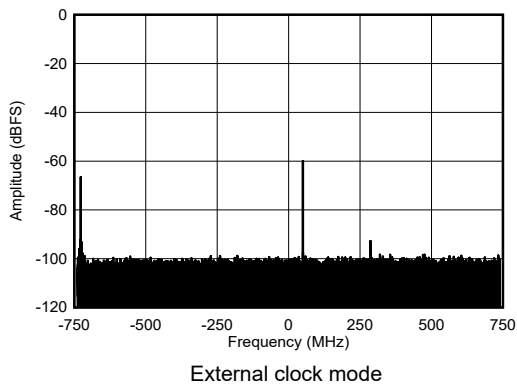

Figure 6-460. RX Single Tone Output FFT at 8.1GHz, -60dBFS

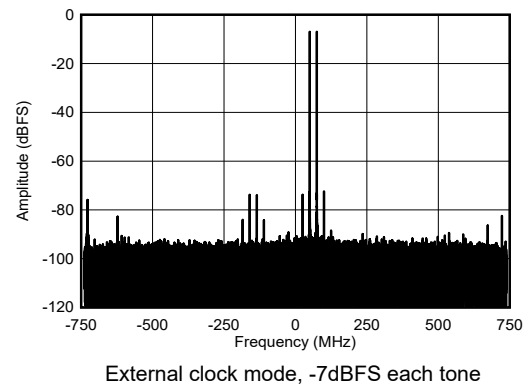
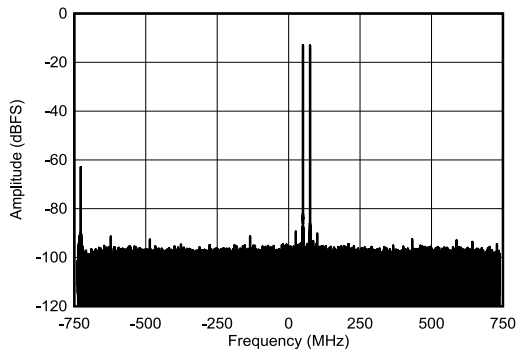

Figure 6-461. RX Dual Tone Output FFT at 8.1GHz

6.12.13 RX Typical Characteristics at 8.1GHz (continued)

Typical values at $T_A = +25^\circ\text{C}$, ADC Sampling Rate = 2949.12 MHz. Default conditions: output sample rate = 1474.56MSPS (decimate by 2), External clock mode with $f_{\text{CLK}} = 11796.48\text{MHz}$, $A_{\text{IN}} = -3\text{ dBFS}$, DSA setting = 3 dB, 8.1GHz matching.



External clock mode, -13dBFS each tone

Figure 6-462. RX Dual Tone Output FFT at 8.11GHz

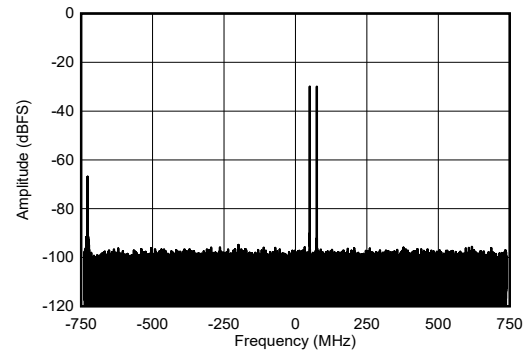

External clock mode, -30dBFS each tone

Figure 6-463. RX Dual Tone Output FFT at 8.11GHz

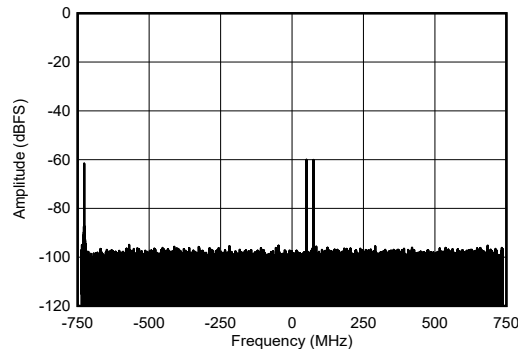

External clock mode, -60dBFS each tone

Figure 6-464. RX Dual Tone Output FFT at 8.11GHz

6.12.14 RX Typical Characteristics at 9.6 GHz

Typical values at $T_A = +25^\circ\text{C}$, ADC Sampling Rate = 2949.12 MHz. Default conditions: output sample rate = 1474.56MSPS (decimate by 2), External clock mode with $f_{\text{CLK}} = 11796.48\text{ MHz}$, $A_{\text{IN}} = -3\text{ dBFS}$, DSA setting = 3 dB, 9.6 GHz matching.

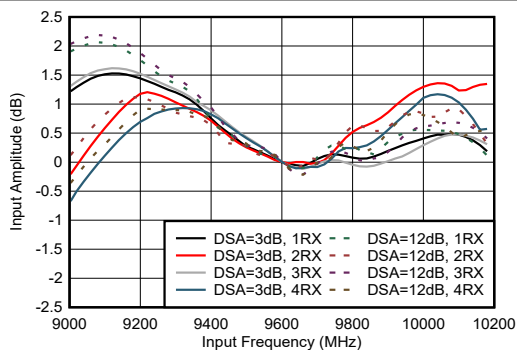

Normalized to 9.6 GHz

Figure 6-465. RX Input Amplitude vs Frequency

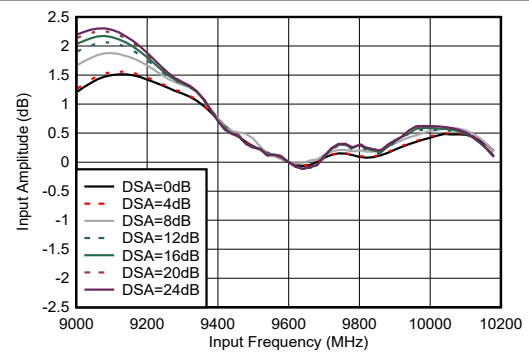

Normalized to 9.6 GHz

Figure 6-466. RX Input Amplitude vs Frequency at 9.6 GHz

6.12.14 RX Typical Characteristics at 9.6 GHz (continued)

Typical values at $T_A = +25^\circ\text{C}$, ADC Sampling Rate = 2949.12 MHz. Default conditions: output sample rate = 1474.56MSPS (decimate by 2), External clock mode with $f_{\text{CLK}} = 11796.48 \text{ MHz}$, $A_{\text{IN}} = -3 \text{ dBFS}$, DSA setting = 3 dB, 9.6 GHz matching.

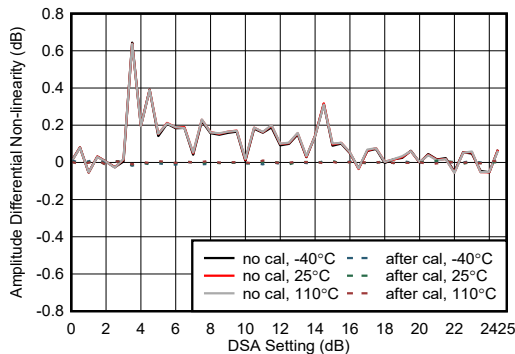

Figure 6-467. RX Amplitude Differential Non-Linearity at 9.6 GHz

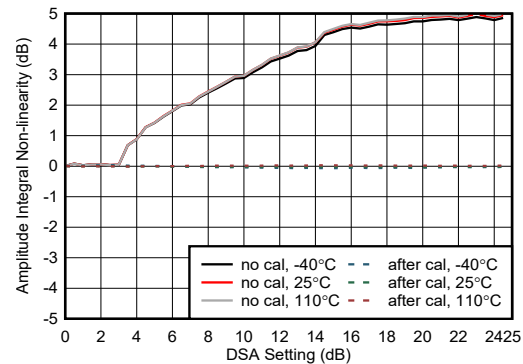

Figure 6-468. RX Amplitude Integrated Non-linearity at 9.6 GHz

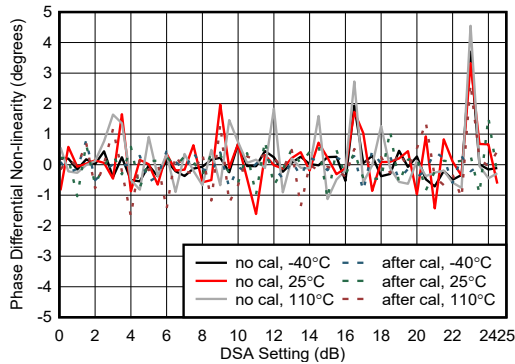

Figure 6-469. RX Phase Differential Non-linearity at 9.6 GHz

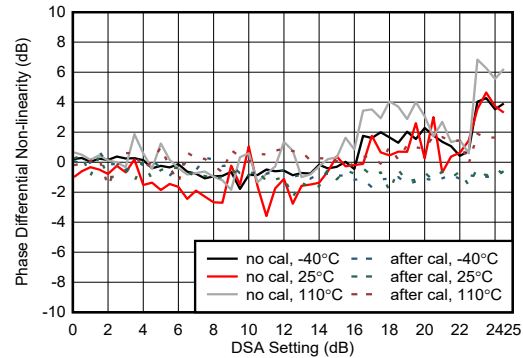

Figure 6-470. RX Phase Integrated Non-linearity at 9.6 GHz

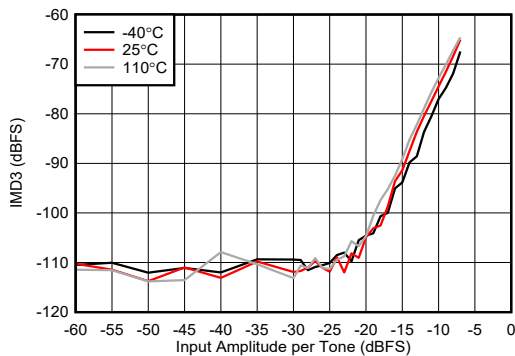

Figure 6-471. RX IMD3 vs Digital Amplitude at 9.6 GHz

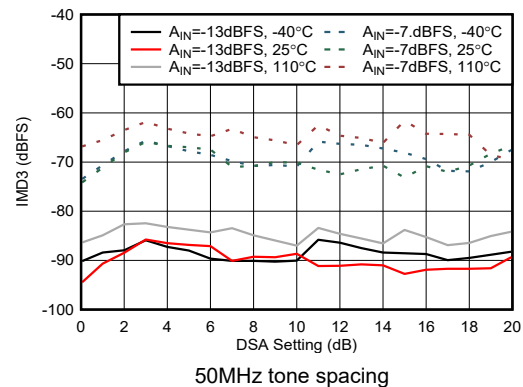

Figure 6-472. RX IMD3 vs DSA Setting at 9.6 GHz

6.12.14 RX Typical Characteristics at 9.6 GHz (continued)

Typical values at $T_A = +25^\circ\text{C}$, ADC Sampling Rate = 2949.12 MHz. Default conditions: output sample rate = 1474.56MSPS (decimate by 2), External clock mode with $f_{\text{CLK}} = 11796.48 \text{ MHz}$, $A_{\text{IN}} = -3 \text{ dBFS}$, DSA setting = 3 dB, 9.6 GHz matching.

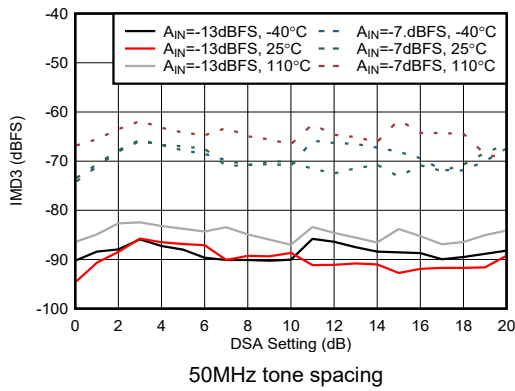

Figure 6-473. RX IMD3 vs DSA Setting at 9.6 GHz

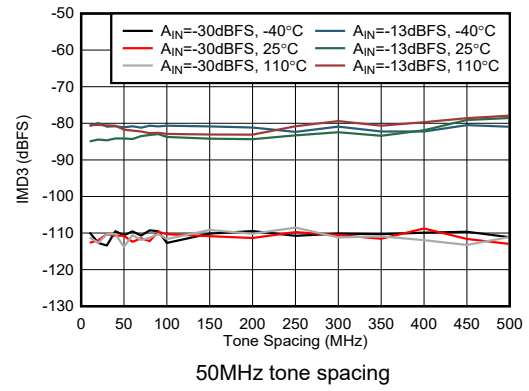

Figure 6-474. RX IMD3 vs Tone Spacing at 9.6 GHz

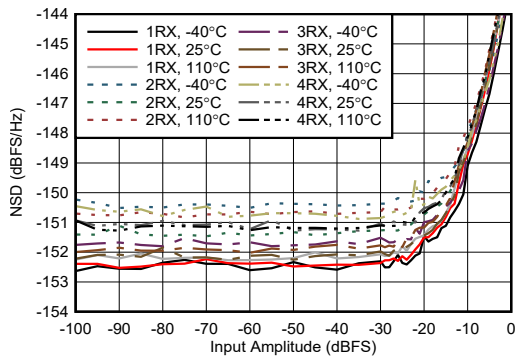

Figure 6-475. RX NSD vs Digital Amplitude at 9.6 GHz

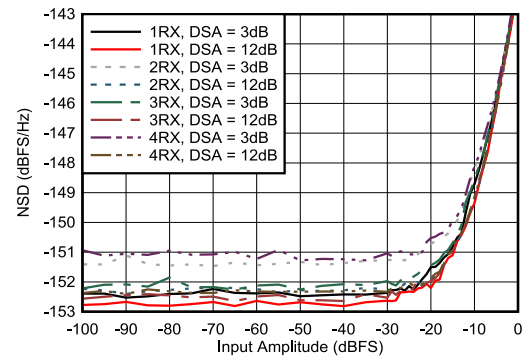

Figure 6-476. RX NSD vs Digital Amplitude at 9.6 GHz

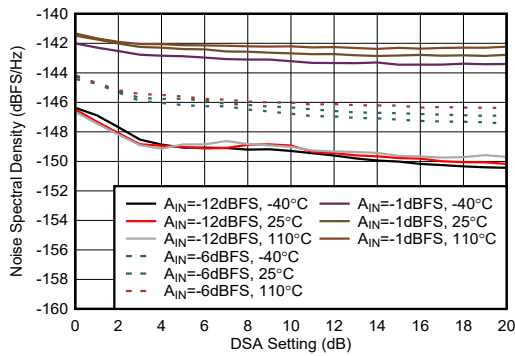

Figure 6-477. RX NSD vs DSA Setting at 9.6 GHz

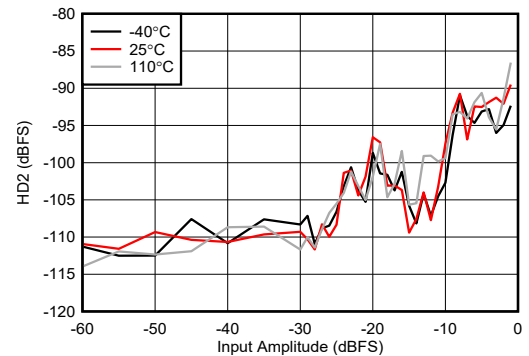

Figure 6-478. RX HD2 vs Digital Level at 9.6 GHz

6.12.14 RX Typical Characteristics at 9.6 GHz (continued)

Typical values at $T_A = +25^\circ\text{C}$, ADC Sampling Rate = 2949.12 MHz. Default conditions: output sample rate = 1474.56MSPS (decimate by 2), External clock mode with $f_{\text{CLK}} = 11796.48 \text{ MHz}$, $A_{\text{IN}} = -3 \text{ dBFS}$, DSA setting = 3 dB, 9.6 GHz matching.

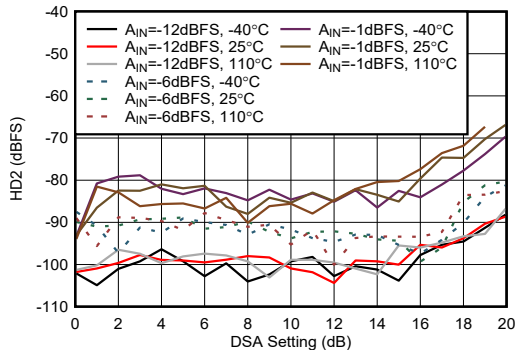

Figure 6-479. RX HD2 vs DSA Setting at 9.6 GHz

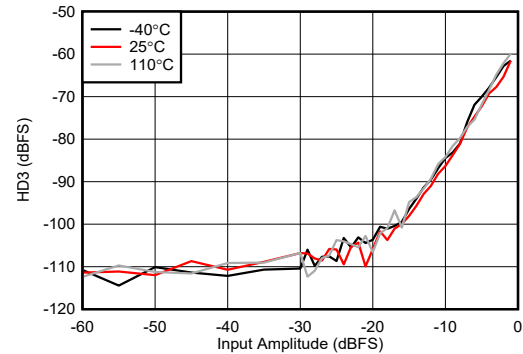

Figure 6-480. RX HD3 vs Digital Level at 9.6 GHz

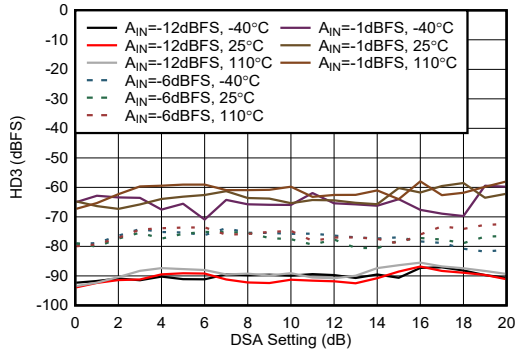
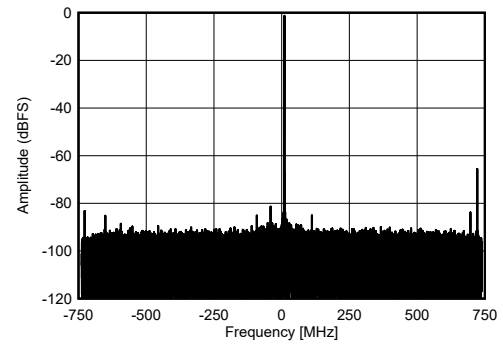
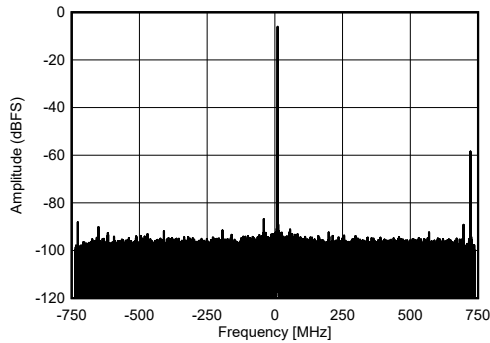

Figure 6-481. RX HD3 vs DSA Setting at 9.6 GHz



-1 dBFS

Figure 6-482. RX Single Tone Output FFT at 9.61 GHz



-6 dBFS

Figure 6-483. RX Single Tone Output FFT at 9.61 GHz

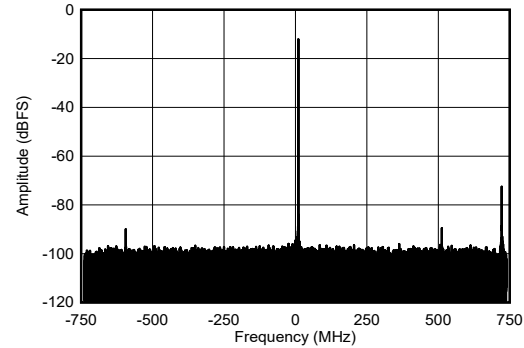

-12 dBFS.

Figure 6-484. RX Single Tone Output FFT at 9.61 GHz

6.12.14 RX Typical Characteristics at 9.6 GHz (continued)

Typical values at $T_A = +25^\circ\text{C}$, ADC Sampling Rate = 2949.12 MHz. Default conditions: output sample rate = 1474.56MSPS (decimate by 2), External clock mode with $f_{\text{CLK}} = 11796.48 \text{ MHz}$, $A_{\text{IN}} = -3 \text{ dBFS}$, DSA setting = 3 dB, 9.6 GHz matching.

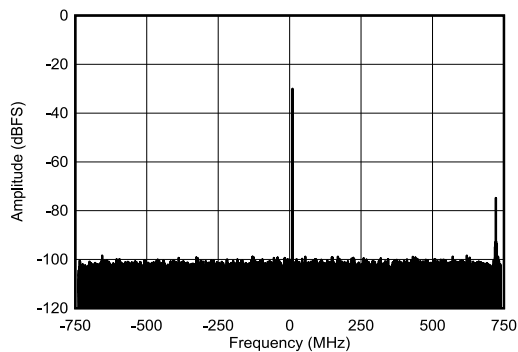

-30 dBFS

Figure 6-485. RX Single Tone Output FFT at 9.61 GHz

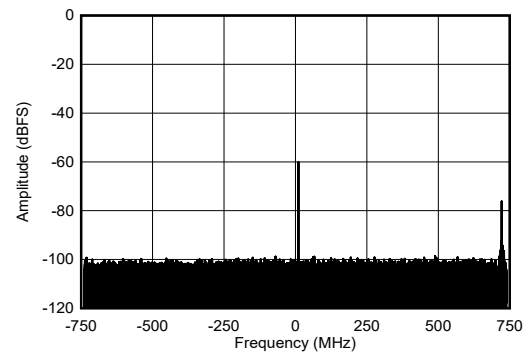

-60 dBFS

Figure 6-486. RX Single Tone Output FFT at 9.61 GHz

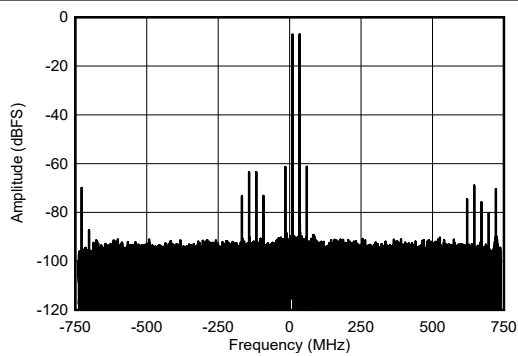

9.61 GHz and 9.635 GHz, -7 dBFS each tone

Figure 6-487. RX Two Tone Output FFT at 9.61 GHz

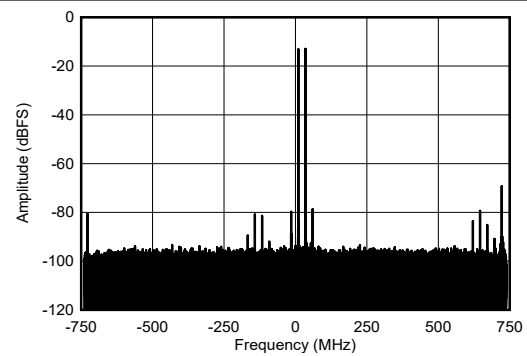

9.61 GHz and 9.635 GHz, -13 dBFS each tone

Figure 6-488. RX Two Tone Output FFT at 9.61 GHz

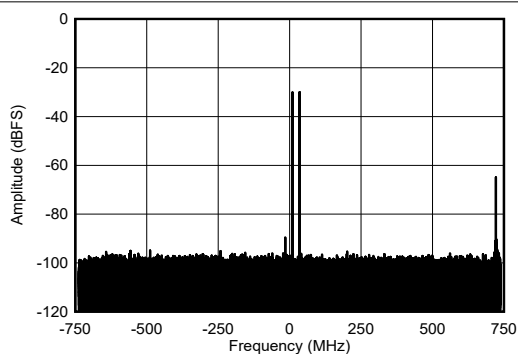

9.61 GHz and 9.635 GHz, -30 dBFS each tone

Figure 6-489. RX Two Tone Output FFT at 9.61 GHz

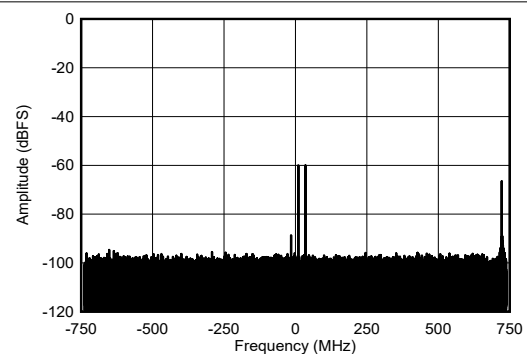

9.61 GHz and 9.635 GHz, -60 dBFS each tone

Figure 6-490. RX Two Tone Output FFT at 9.61 GHz

6.12.15 PLL and Clock Typical Characteristics

Typical values at $T_A = +25^\circ\text{C}$ with nominal supplies. Unless otherwise noted, $f_{\text{REF}} = 491.52 \text{ MHz}$, Phase noise measured at TX output

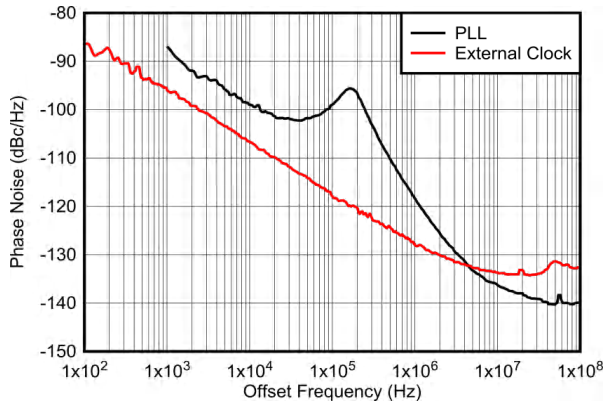

measured at TX output, normalized to 12GHz by $20 \cdot \log_{10}(12\text{GHz}/F_{\text{OUT}})$

Figure 6-491. Phase Noise vs Offset Frequency for PLL and External Clock at 12GHz

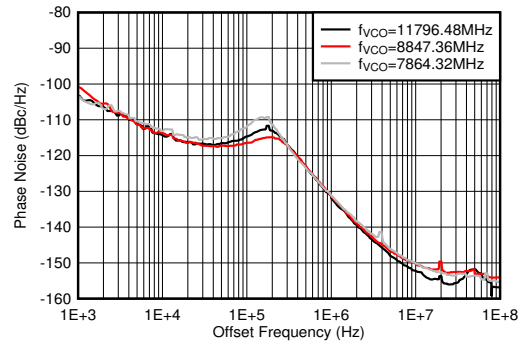

PLL enabled, $f_{\text{REF}} = 491.52\text{MSPS}$, measured at 2TXOUT

Figure 6-492. Phase Noise vs Offset Frequency and f_{VCO} at $f_{\text{OUT}} = 2610 \text{ MHz}$

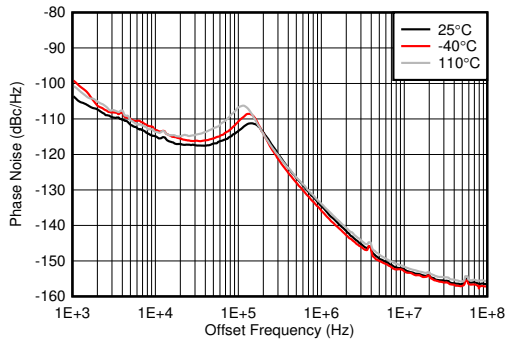

PLL enabled, $f_{\text{VCO}} = 11796.48 \text{ MHz}$, $f_{\text{REF}} = 491.52\text{MSPS}$, measured at 2TXOUT

Figure 6-493. Phase Noise for 12-GHz VCO vs Offset Frequency and Temperature at $f_{\text{OUT}} = 1910 \text{ MHz}$

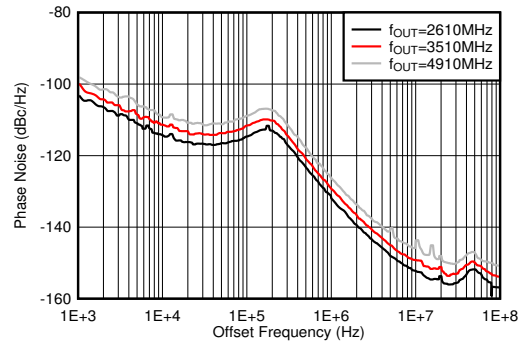

PLL enabled, $f_{\text{VCO}} = 11796.48 \text{ MHz}$, $f_{\text{REF}} = 491.52\text{MSPS}$, measured at 2TXOUT

Figure 6-494. Phase Noise for 12-GHz VCO vs Offset Frequency and f_{OUT} at 25°C

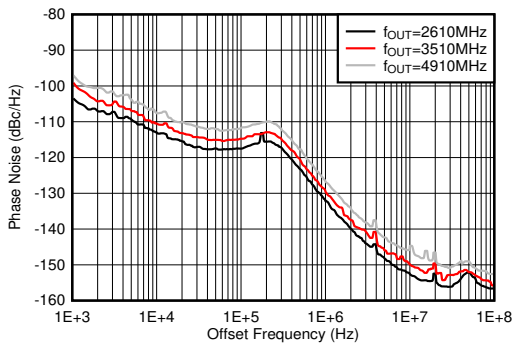

PLL enabled, $f_{\text{VCO}} = 11796.48 \text{ MHz}$, $f_{\text{REF}} = 491.52\text{MSPS}$, measured at 2TXOUT

Figure 6-495. Phase Noise for 12-GHz VCO vs Offset Frequency and f_{OUT} at -40°C

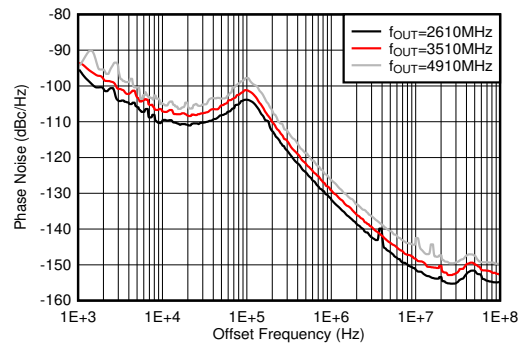

PLL enabled, $f_{\text{VCO}} = 11796.48 \text{ MHz}$, $f_{\text{REF}} = 491.52\text{MSPS}$, measured at 2TXOUT

Figure 6-496. Phase Noise for 12-GHz VCO vs Offset Frequency and f_{OUT} at 110°C

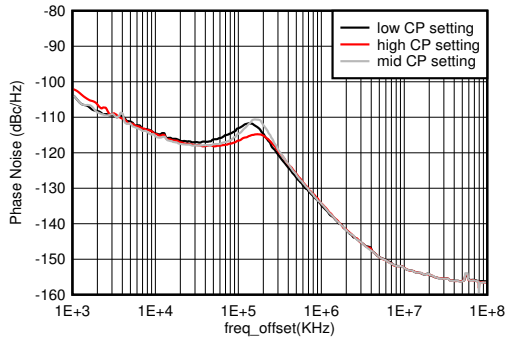

PLL enabled, $f_{VCO} = 11796.48$ MHz, $f_{REF} = 491.52$ MSPS, measured at 2TXOUT

Figure 6-497. Phase Noise for 12-GHz VCO vs Offset Frequency and CP Setting at $f_{OUT} = 2.6$ GHz

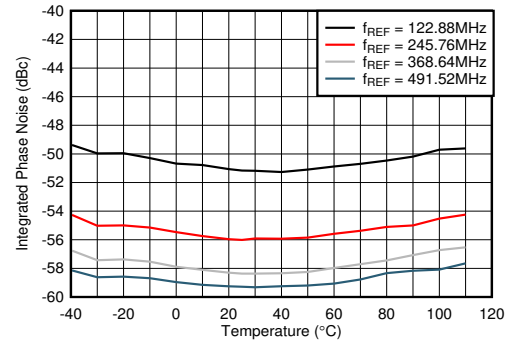

PLL enabled, $f_{VCO} = 11796.48$ MHz, 1-kHz to 100-MHz, single-sided integration bandwidth, measured at 2TXOUT

Figure 6-498. Integrated Phase Noise for 12-GHz VCO vs Temperature and f_{REF} at $f_{OUT} = 2.6$ GHz

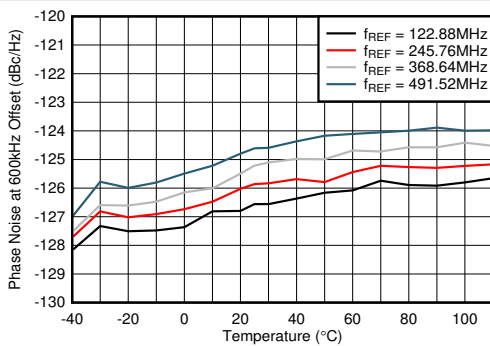

PLL enabled, $f_{VCO} = 11796.48$ MHz, measured at 2TXOUT

Figure 6-499. Phase Noise for 12-GHz VCO at 600kHz Offset vs Temperature and f_{REF} at $f_{OUT} = 2.6$ GHz

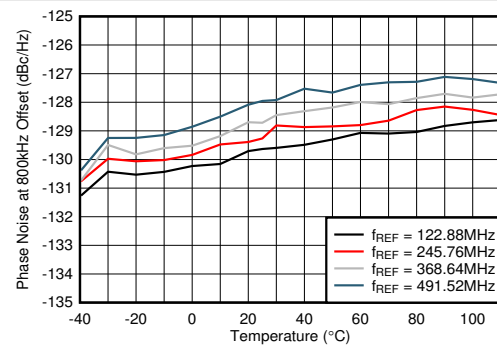

A. PLL enabled, $f_{VCO} = 11796.48$ MHz, measured at 2TXOUT

Figure 6-500. Phase Noise for 12-GHz VCO at 800-kHz Offset vs Temperature and f_{REF} at $f_{OUT} = 2.6$ GHz

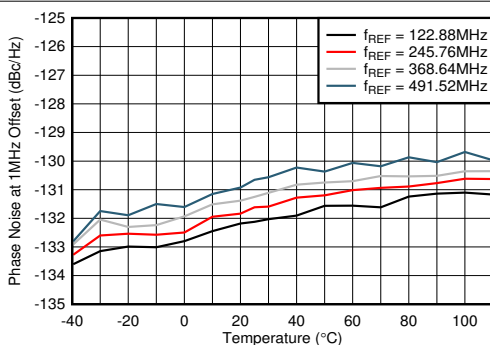

PLL enabled, $f_{VCO} = 11796.48$ MHz, measured at 2TXOUT

Figure 6-501. Phase Noise for 12-GHz VCO at 1-MHz Offset vs Temperature and f_{REF} at $f_{OUT} = 2.6$ GHz

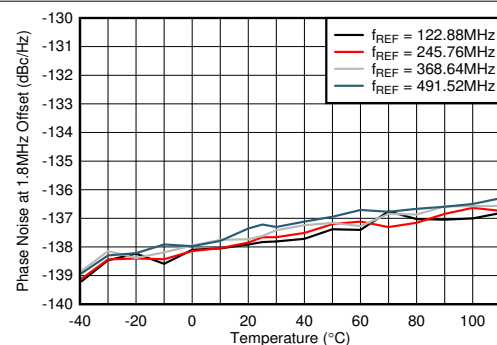

PLL enabled, $f_{VCO} = 11796.48$ MHz, measured at 2TXOUT

Figure 6-502. Phase Noise for 12-GHz VCO at 1.8-MHz Offset vs Temperature and f_{REF} at $f_{OUT} = 2.6$ GHz

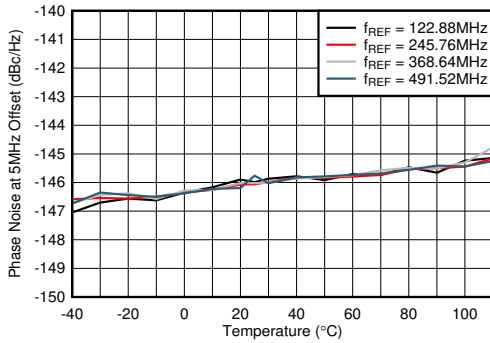

PLL enabled, $f_{VCO} = 11796.48$ MHz, measured at 2TXOUT

Figure 6-503. Phase Noise for 12-GHz VCO at 5-MHz Offset vs Temperature and f_{REF} at $f_{OUT} = 2.6$ GHz

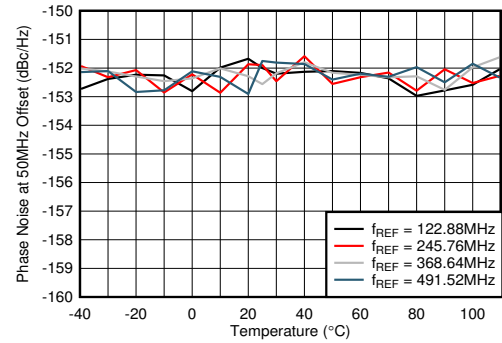

PLL enabled, $f_{VCO} = 11796.48$ MHz, measured at 2TXOUT

Figure 6-504. Phase Noise for 12-GHz VCO at 50-MHz Offset vs Temperature and f_{REF} at $f_{OUT} = 2.6$ GHz

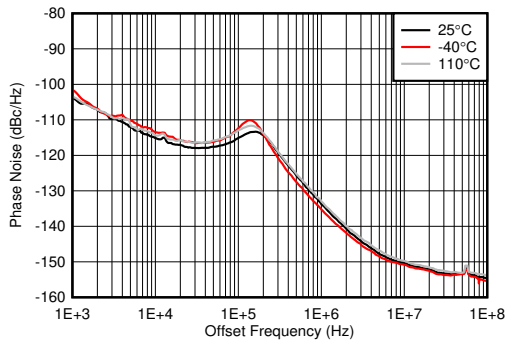

PLL enabled, $f_{VCO} = 9830.4$ MHz, $f_{REF} = 491.52$ MSPS, measured at 2TXOUT

Figure 6-505. Phase Noise for 10-GHz VCO vs Offset Frequency and Temperature at $f_{OUT} = 1910$ MHz

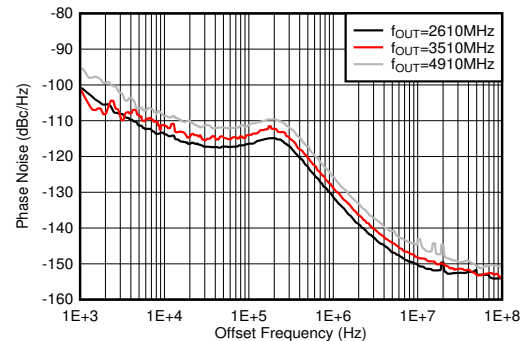

PLL enabled, $f_{VCO} = 9830.4$ MHz, $f_{REF} = 491.52$ MSPS, measured at 2TXOUT

Figure 6-506. Phase Noise for 10-GHz VCO vs Offset Frequency and f_{OUT} at 25°C

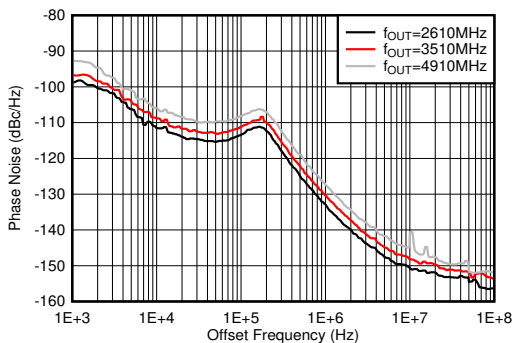

PLL enabled, $f_{VCO} = 9830.4$ MHz, $f_{REF} = 491.52$ MSPS, measured at 2TXOUT

Figure 6-507. Phase Noise for 10-GHz VCO vs Offset Frequency and f_{OUT} at -40°C

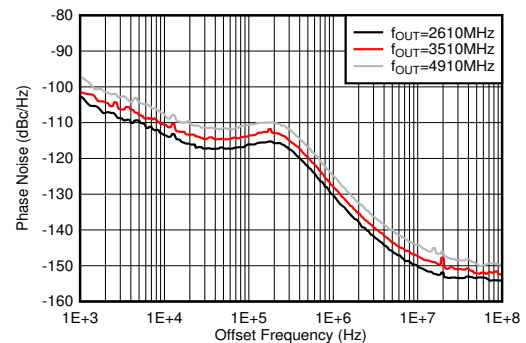

PLL enabled, $f_{VCO} = 9830.4$ MHz, $f_{REF} = 491.52$ MSPS, measured at 2TXOUT

Figure 6-508. Phase Noise for 10-GHz VCO vs Offset Frequency and f_{OUT} at 110°C

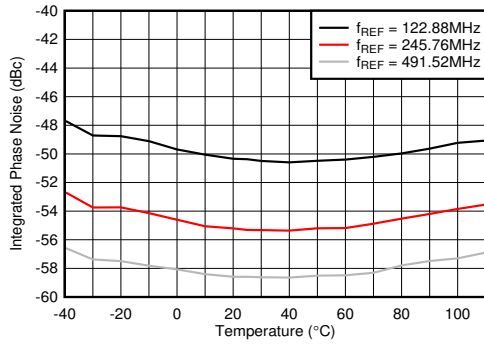

PLL enabled, $f_{VCO} = 9830.4$ MHz, 1-kHz to 100-MHz, single-sided integration bandwidth, measured at 2TXOUT

Figure 6-509. Integrated Phase Noise for 10-GHz VCO vs Temperature and f_{REF} at $f_{OUT} = 2.6$ GHz

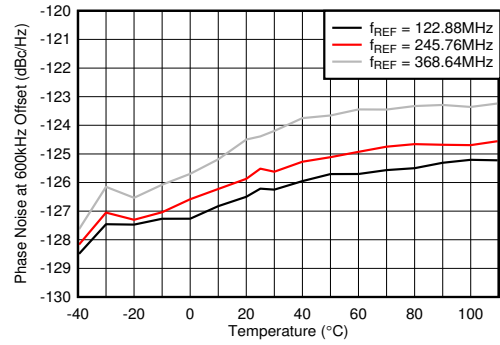

PLL enabled, $f_{VCO} = 9830.4$ MHz, measured at 2TXOUT

Figure 6-510. Phase Noise for 10-GHz VCO at 600 kHz vs Temperature and f_{REF} at $f_{OUT} = 2.6$ GHz

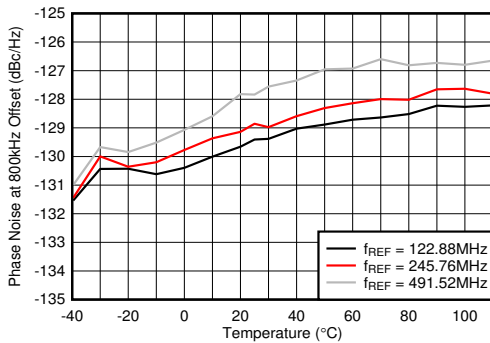

PLL enabled, $f_{VCO} = 9830.4$ MHz, measured at 2TXOUT

Figure 6-511. Phase Noise for 10-GHz VCO at 800 kHz vs Temperature and f_{REF} at $f_{OUT} = 2.6$ GHz

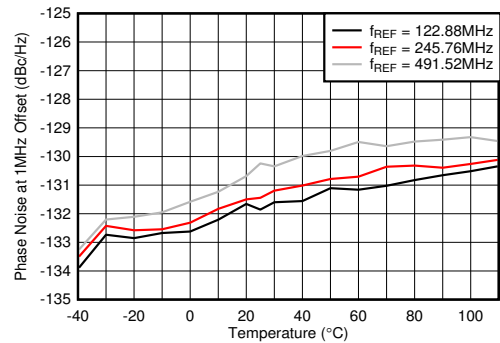

PLL enabled, $f_{VCO} = 9830.4$ MHz, measured at 2TXOUT

Figure 6-512. Phase Noise for 10-GHz VCO at 1 MHz vs Temperature and f_{REF} at $f_{OUT} = 2.6$ GHz

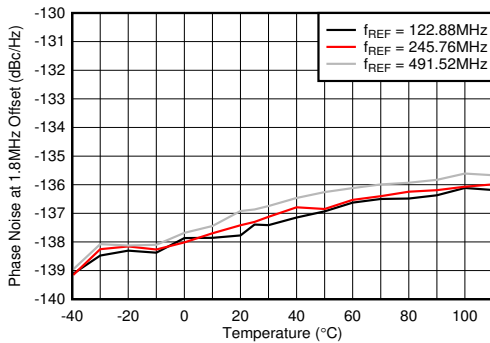

PLL enabled, $f_{VCO} = 9830.4$ MHz, measured at 2TXOUT

Figure 6-513. Phase Noise for 10-GHz VCO at 1.8 MHz vs Temperature and f_{REF} at $f_{OUT} = 2.6$ GHz

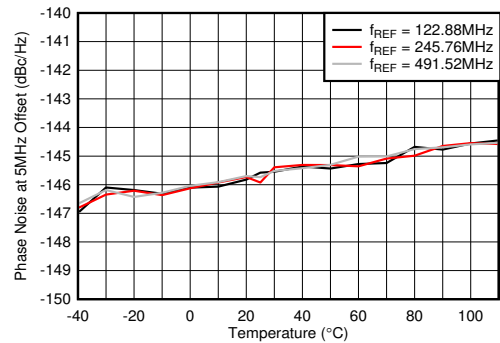

PLL enabled, $f_{VCO} = 9830.4$ MHz, measured at 2TXOUT

Figure 6-514. Phase Noise for 10-GHz VCO at 5 MHz vs Temperature and f_{REF} at $f_{OUT} = 2.6$ GHz

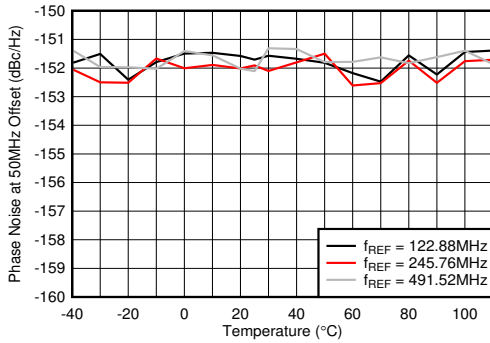

PLL enabled, $f_{VCO} = 9830.4$ MHz, measured at 2TXOUT

Figure 6-515. Phase Noise for 10-GHz VCO at 50 MHz vs Temperature and f_{REF} at $f_{OUT} = 2.6$ GHz

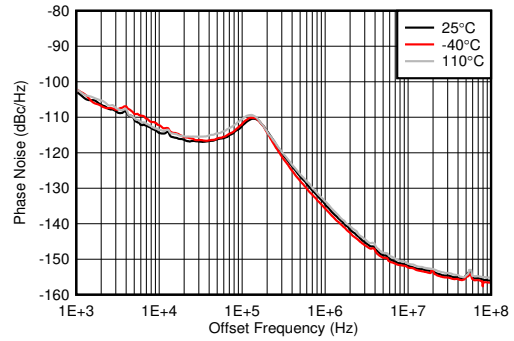

PLL enabled, $f_{VCO} = 8847.36$ MHz, $f_{REF} = 491.52$ MSPS, measured at 2TXOUT

Figure 6-516. Phase Noise for 9-GHz VCO vs Offset Frequency and Temperature at $f_{OUT} = 1910$ MHz

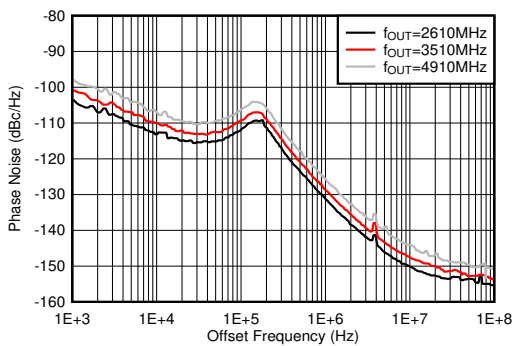

PLL enabled, $f_{VCO} = 8847.36$ MHz, $f_{REF} = 491.52$ MSPS, measured at 2TXOUT

Figure 6-517. Phase Noise for 9-GHz VCO vs Offset Frequency and f_{OUT} at 25°C

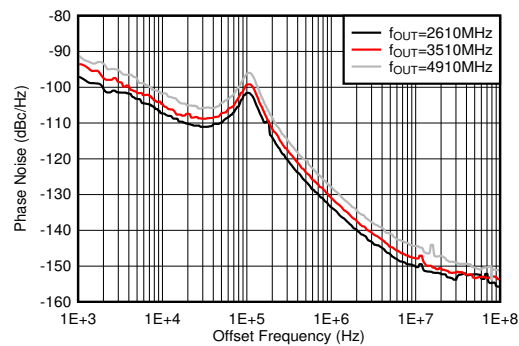

PLL enabled, $f_{VCO} = 8847.36$ MHz, $f_{REF} = 491.52$ MSPS, measured at 2TXOUT

Figure 6-518. Phase Noise for 9-GHz VCO vs Offset Frequency and f_{OUT} at -40°C

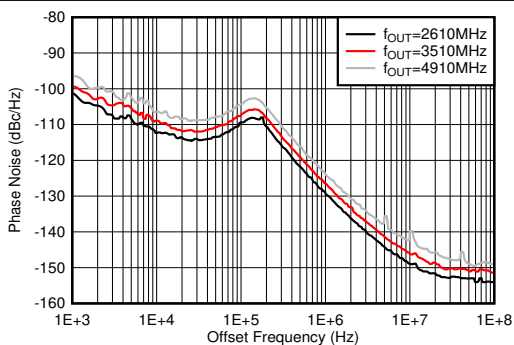

PLL enabled, $f_{VCO} = 8847.36$ MHz, $f_{REF} = 491.52$ MSPS, measured at 2TXOUT

Figure 6-519. Phase Noise for 9-GHz VCO vs Offset Frequency and f_{OUT} at 110°C

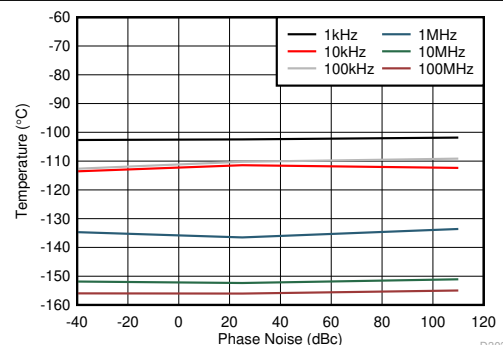

PLL enabled, $f_{VCO} = 8847.36$ MHz, $f_{REF} = 491.52$ MSPS, minimum LPF BW, measured at 2TXOUT

Figure 6-520. Phase Noise for 9-GHz VCO vs Temperature Over Offset Frequency at $f_{OUT} = 2.6$ GHz

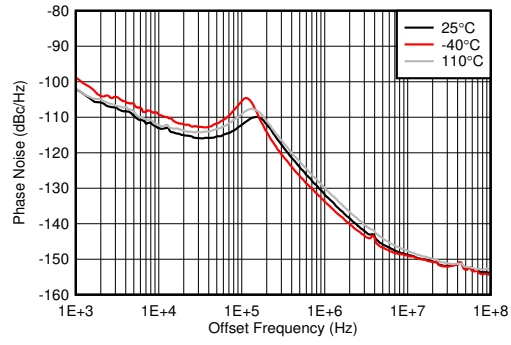

PLL enabled, $f_{VCO} = 7864.32$ MHz, $f_{REF} = 491.52$ MSPS, measured at 2TXOUT

Figure 6-521. Phase Noise for 8-GHz VCO vs Offset Frequency and Temperature at $f_{OUT} = 1910$ MHz

7 Device and Documentation Support

7.1 Receiving Notification of Documentation Updates

To receive notification of documentation updates, navigate to the device product folder on [ti.com](https://www.ti.com). Click on *Subscribe to updates* to register and receive a weekly digest of any product information that has changed. For change details, review the revision history included in any revised document.

7.2 Support Resources

[TI E2E™ support forums](#) are an engineer's go-to source for fast, verified answers and design help — straight from the experts. Search existing answers or ask your own question to get the quick design help you need.

Linked content is provided "AS IS" by the respective contributors. They do not constitute TI specifications and do not necessarily reflect TI's views; see TI's [Terms of Use](#).

7.3 Trademarks

TI E2E™ is a trademark of Texas Instruments.

All trademarks are the property of their respective owners.

7.4 Electrostatic Discharge Caution



This integrated circuit can be damaged by ESD. Texas Instruments recommends that all integrated circuits be handled with appropriate precautions. Failure to observe proper handling and installation procedures can cause damage.

ESD damage can range from subtle performance degradation to complete device failure. Precision integrated circuits may be more susceptible to damage because very small parametric changes could cause the device not to meet its published specifications.

7.5 Glossary

[TI Glossary](#) This glossary lists and explains terms, acronyms, and definitions.

8 Mechanical, Packaging, and Orderable Information

The following pages include mechanical, packaging, and orderable information. This information is the most current data available for the designated devices. This data is subject to change without notice and revision of this document. For browser-based versions of this data sheet, refer to the left-hand navigation.

PACKAGING INFORMATION

Orderable Device	Status (1)	Package Type	Package Drawing	Pins	Package Qty	Eco Plan (2)	Lead finish/ Ball material (6)	MSL Peak Temp (3)	Op Temp (°C)	Device Marking (4/5)	Samples
AFE7950IABJ	ACTIVE	FCBGA	ABJ	400	90	RoHS & Green	SNAGCU	Level-3-260C-168 HR	-40 to 85	AFE7950I	Samples
AFE7950IALK	ACTIVE	FCBGA	ALK	400	90	Non-RoHS & Green	Call TI	Level-3-220C-168 HR	-40 to 85	AFE7950 SNPB	Samples

(1) The marketing status values are defined as follows:

ACTIVE: Product device recommended for new designs.

LIFEBUY: TI has announced that the device will be discontinued, and a lifetime-buy period is in effect.

NRND: Not recommended for new designs. Device is in production to support existing customers, but TI does not recommend using this part in a new design.

PREVIEW: Device has been announced but is not in production. Samples may or may not be available.

OBSOLETE: TI has discontinued the production of the device.

(2) **RoHS:** TI defines "RoHS" to mean semiconductor products that are compliant with the current EU RoHS requirements for all 10 RoHS substances, including the requirement that RoHS substance do not exceed 0.1% by weight in homogeneous materials. Where designed to be soldered at high temperatures, "RoHS" products are suitable for use in specified lead-free processes. TI may reference these types of products as "Pb-Free".

RoHS Exempt: TI defines "RoHS Exempt" to mean products that contain lead but are compliant with EU RoHS pursuant to a specific EU RoHS exemption.

Green: TI defines "Green" to mean the content of Chlorine (Cl) and Bromine (Br) based flame retardants meet JS709B low halogen requirements of <=1000ppm threshold. Antimony trioxide based flame retardants must also meet the <=1000ppm threshold requirement.

(3) MSL, Peak Temp. - The Moisture Sensitivity Level rating according to the JEDEC industry standard classifications, and peak solder temperature.

(4) There may be additional marking, which relates to the logo, the lot trace code information, or the environmental category on the device.

(5) Multiple Device Markings will be inside parentheses. Only one Device Marking contained in parentheses and separated by a "-" will appear on a device. If a line is indented then it is a continuation of the previous line and the two combined represent the entire Device Marking for that device.

(6) Lead finish/Ball material - Orderable Devices may have multiple material finish options. Finish options are separated by a vertical ruled line. Lead finish/Ball material values may wrap to two lines if the finish value exceeds the maximum column width.

Important Information and Disclaimer:The information provided on this page represents TI's knowledge and belief as of the date that it is provided. TI bases its knowledge and belief on information provided by third parties, and makes no representation or warranty as to the accuracy of such information. Efforts are underway to better integrate information from third parties. TI has taken and continues to take reasonable steps to provide representative and accurate information but may not have conducted destructive testing or chemical analysis on incoming materials and chemicals. TI and TI suppliers consider certain information to be proprietary, and thus CAS numbers and other limited information may not be available for release.

In no event shall TI's liability arising out of such information exceed the total purchase price of the TI part(s) at issue in this document sold by TI to Customer on an annual basis.

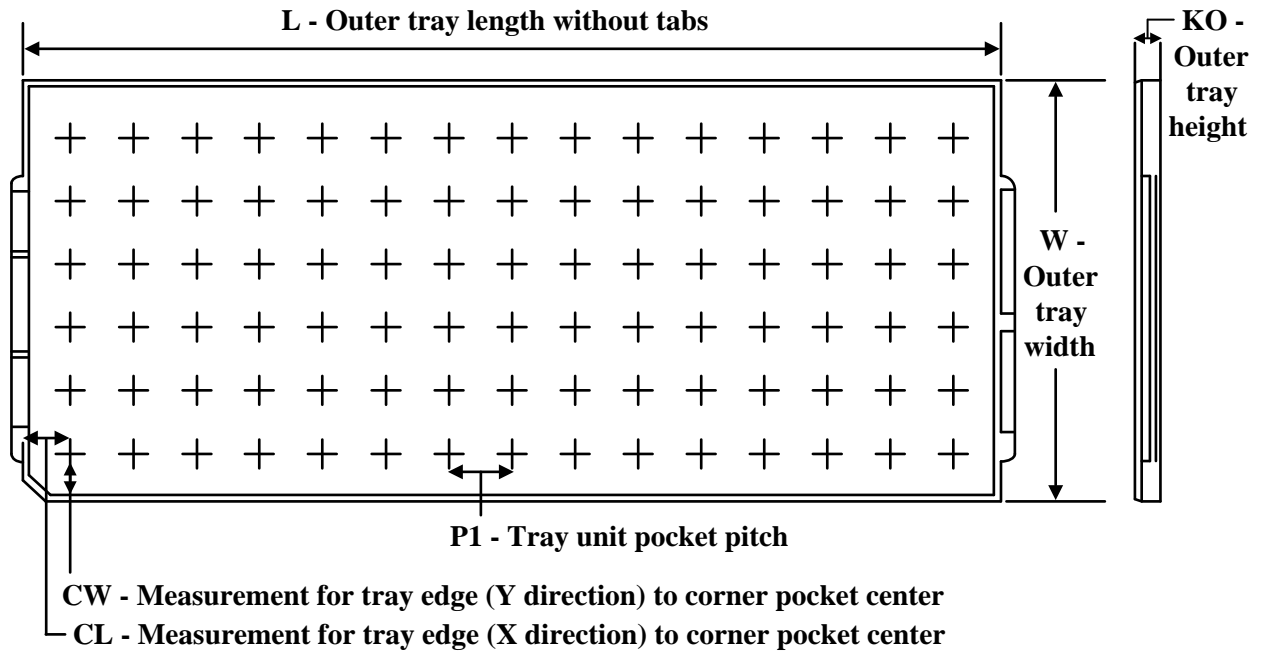
TRAY

Chamfer on Tray corner indicates Pin 1 orientation of packed units.

*All dimensions are nominal

Device	Package Name	Package Type	Pins	SPQ	Unit array matrix	Max temperature (°C)	L (mm)	W (mm)	K0 (µm)	P1 (mm)	CL (mm)	CW (mm)
AFE7950IABJ	ABJ	FCBGA	400	90	6 x 15	150	315	135.9	7620	19.5	21	19.2
AFE7950IABJ	ABJ	FCBGA	400	90	6 x 15	150	315	135.9	7620	19.5	21	19.2
AFE7950IALK	ALK	FCBGA	400	90	6 x 15	150	315	135.9	7620	19.5	21	19.2

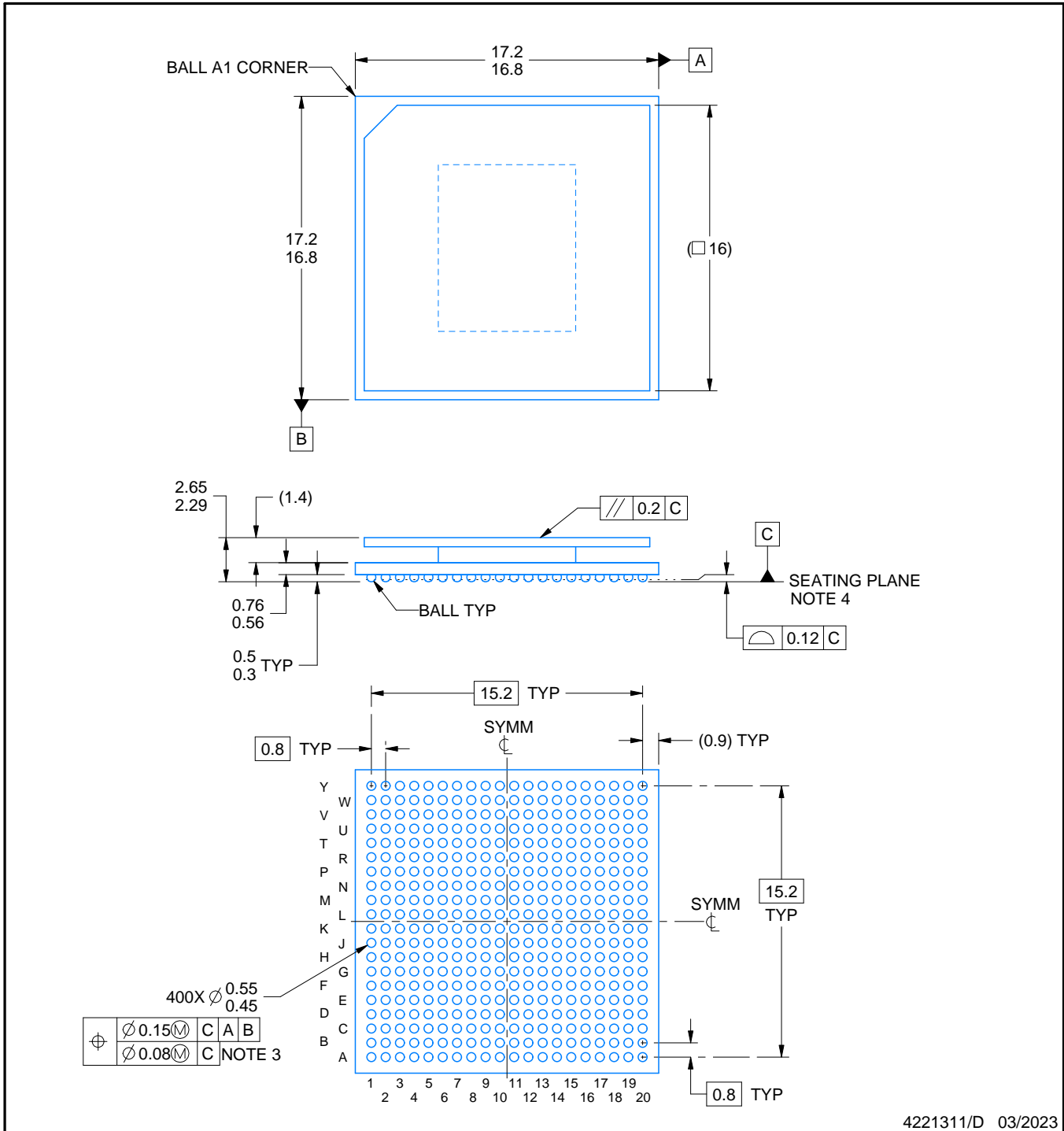
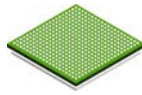

4221311/D 03/2023

NOTES:

1. All linear dimensions are in millimeters. Any dimensions in parenthesis are for reference only. Dimensioning and tolerancing per ASME Y14.5M.
2. This drawing is subject to change without notice.
3. Dimension is measured at the maximum solder ball diameter, parallel to primary datum C.
4. Primary datum C and seating plane are defined by the spherical crowns of the solder balls.
5. The lids are electrically floating (e.g. not tied to GND).

EXAMPLE BOARD LAYOUT

ABJ0400A

FCBGA - 2.65 mm max height

BALL GRID ARRAY

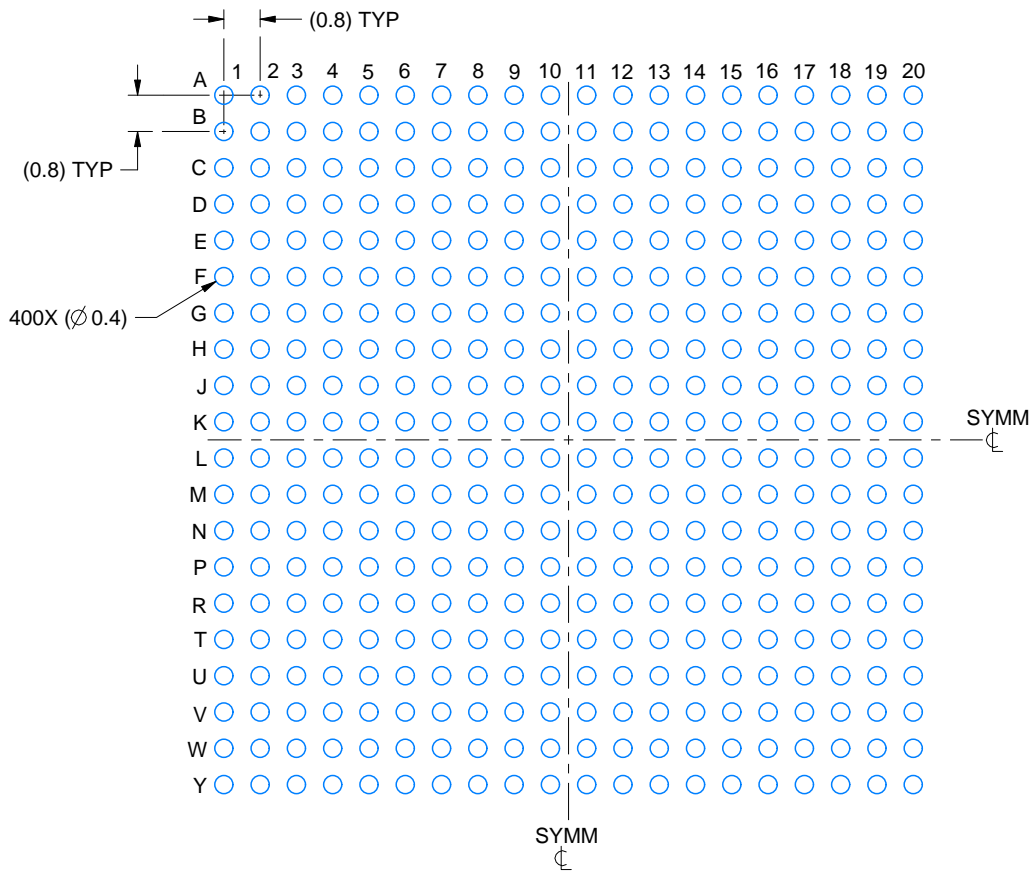

LAND PATTERN EXAMPLE
EXPOSED METAL SHOWN
SCALE:6X

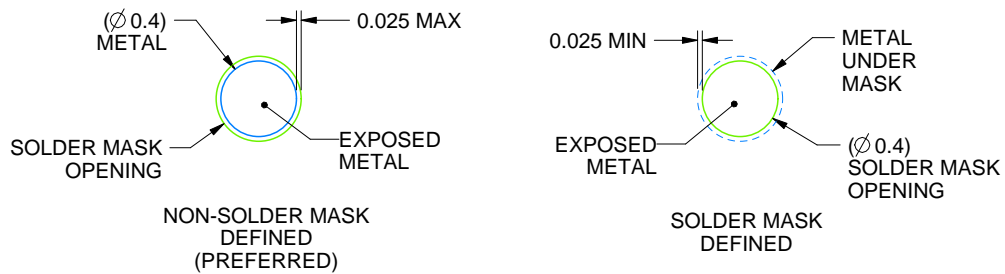

SOLDER MASK DETAILS
NOT TO SCALE

4221311/D 03/2023

NOTES: (continued)

- Final dimensions may vary due to manufacturing tolerance considerations and also routing constraints. For more information, see Texas Instruments literature number SPRU811 (www.ti.com/lit/spru811).

EXAMPLE STENCIL DESIGN

ABJ0400A

FCBGA - 2.65 mm max height

BALL GRID ARRAY

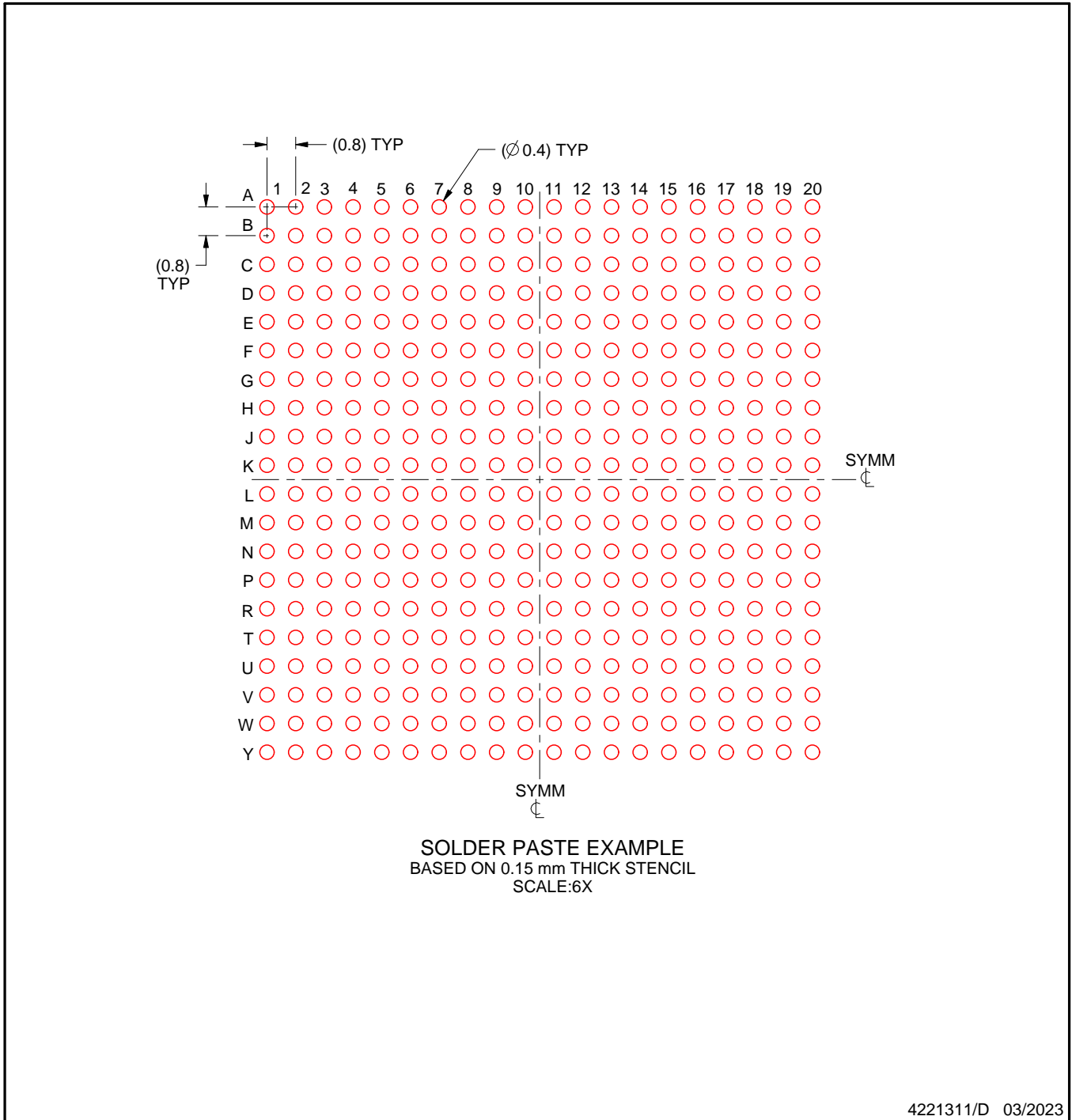

4221311/D 03/2023

NOTES: (continued)

7. Laser cutting apertures with trapezoidal walls and rounded corners may offer better paste release.

ALK0400A

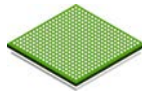

PACKAGE OUTLINE

FCBGA - 2.65 mm max height

BALL GRID ARRAY

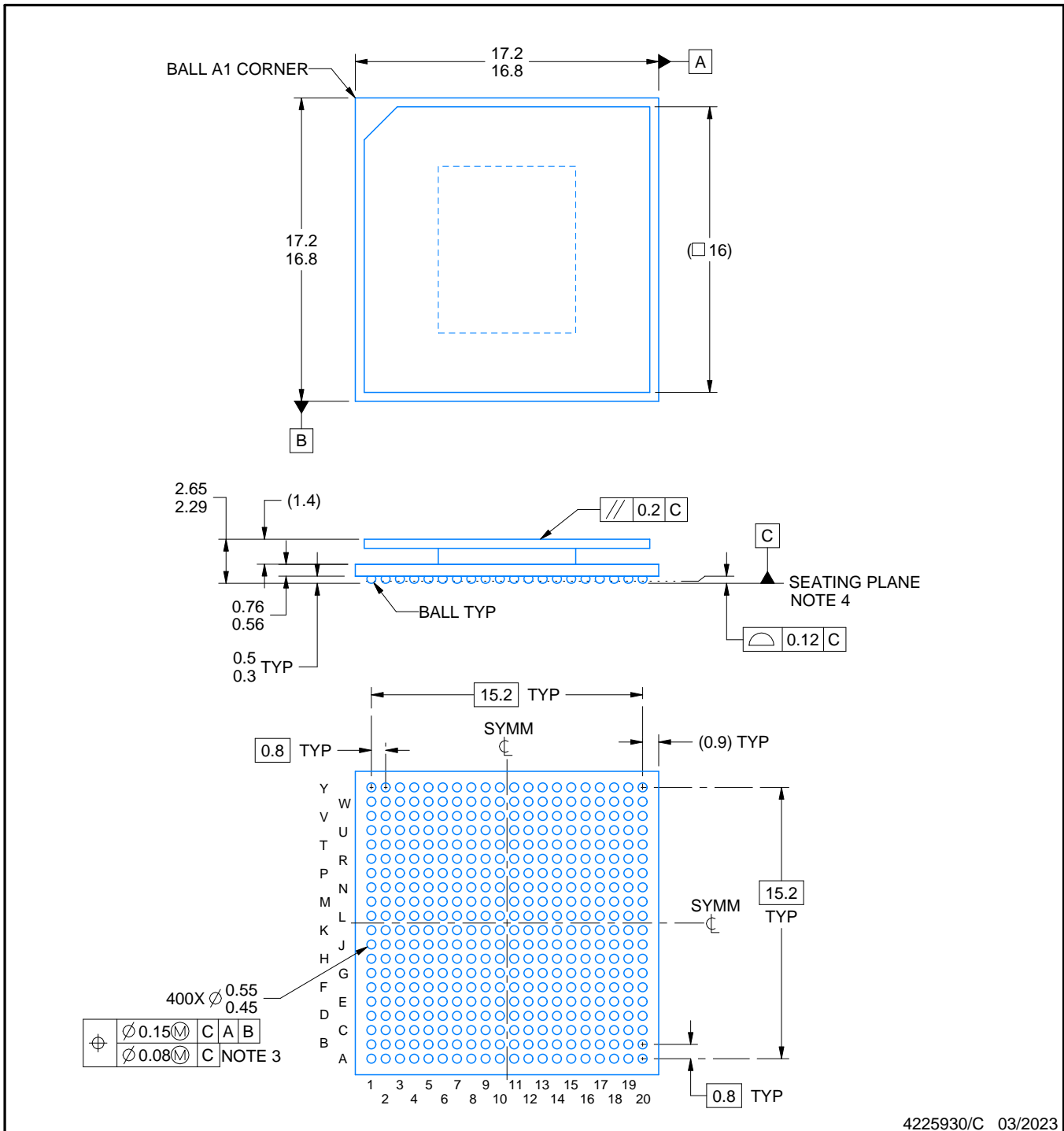

NOTES:

1. All linear dimensions are in millimeters. Any dimensions in parenthesis are for reference only. Dimensioning and tolerancing per ASME Y14.5M.
2. This drawing is subject to change without notice.
3. Dimension is measured at the maximum solder ball diameter, parallel to primary datum C.
4. Primary datum C and seating plane are defined by the spherical crowns of the solder balls.
5. Pb-Free die bump and SnPb solder ball.
6. The lids are electrically floating (e.g. not tied to GND).

EXAMPLE BOARD LAYOUT

ALK0400A

FCBGA - 2.65 mm max height

BALL GRID ARRAY

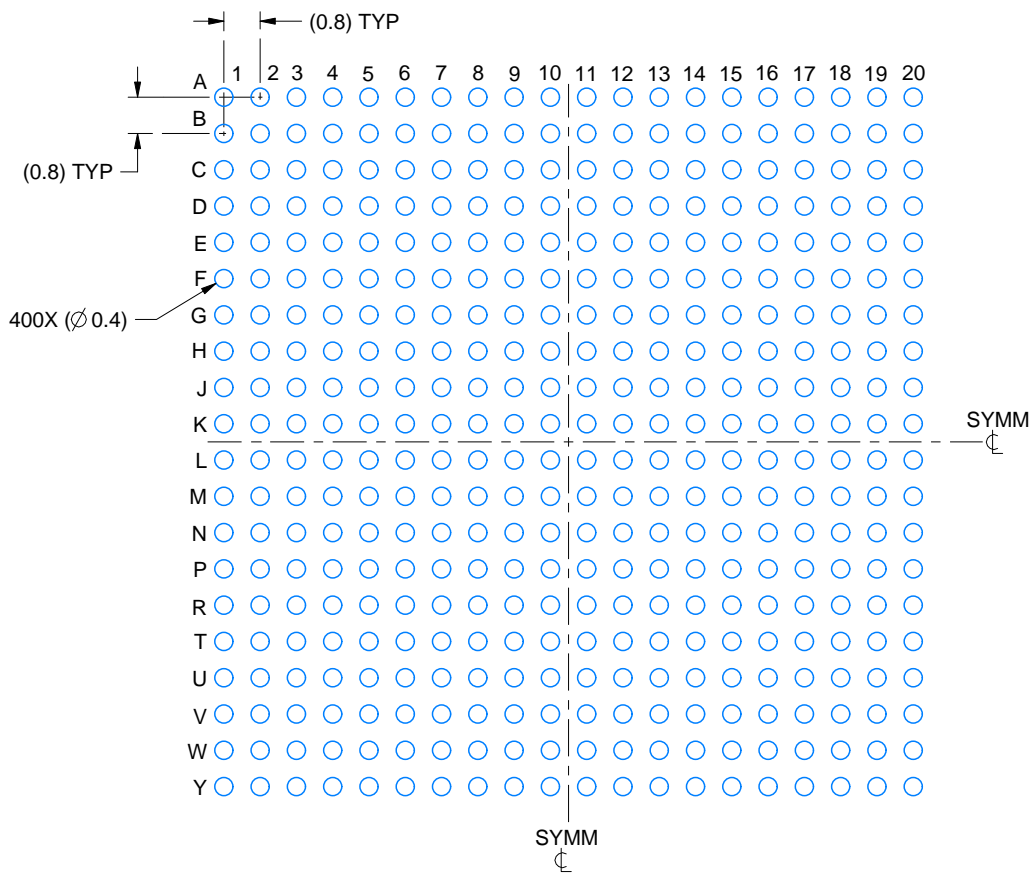

LAND PATTERN EXAMPLE
EXPOSED METAL SHOWN
SCALE:6X

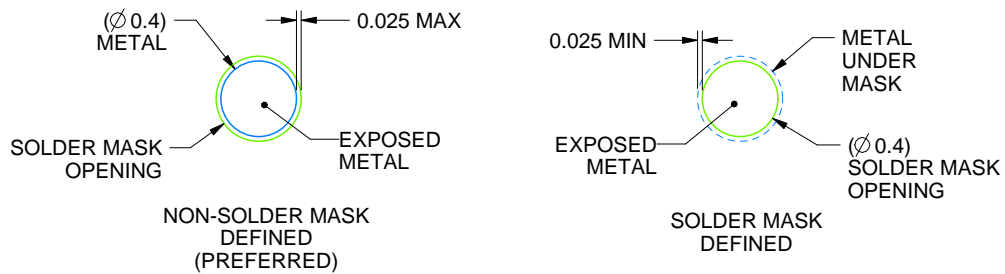

SOLDER MASK DETAILS
NOT TO SCALE

4225930/C 03/2023

NOTES: (continued)

- Final dimensions may vary due to manufacturing tolerance considerations and also routing constraints. For more information, see Texas Instruments literature number SPRU811 (www.ti.com/lit/spru811).

EXAMPLE STENCIL DESIGN

ALK0400A

FCBGA - 2.65 mm max height

BALL GRID ARRAY

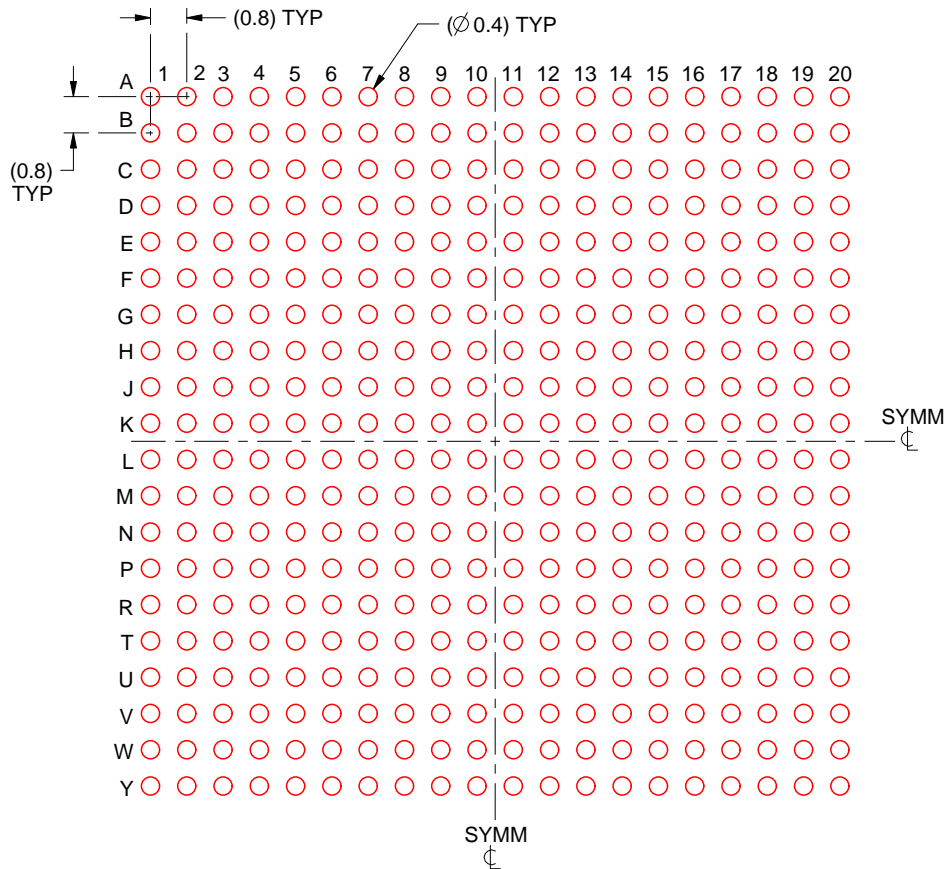

SOLDER PASTE EXAMPLE
BASED ON 0.15 mm THICK STENCIL
SCALE:6X

4225930/C 03/2023

NOTES: (continued)

8. Laser cutting apertures with trapezoidal walls and rounded corners may offer better paste release.

IMPORTANT NOTICE AND DISCLAIMER

TI PROVIDES TECHNICAL AND RELIABILITY DATA (INCLUDING DATA SHEETS), DESIGN RESOURCES (INCLUDING REFERENCE DESIGNS), APPLICATION OR OTHER DESIGN ADVICE, WEB TOOLS, SAFETY INFORMATION, AND OTHER RESOURCES "AS IS" AND WITH ALL FAULTS, AND DISCLAIMS ALL WARRANTIES, EXPRESS AND IMPLIED, INCLUDING WITHOUT LIMITATION ANY IMPLIED WARRANTIES OF MERCHANTABILITY, FITNESS FOR A PARTICULAR PURPOSE OR NON-INFRINGEMENT OF THIRD PARTY INTELLECTUAL PROPERTY RIGHTS.

These resources are intended for skilled developers designing with TI products. You are solely responsible for (1) selecting the appropriate TI products for your application, (2) designing, validating and testing your application, and (3) ensuring your application meets applicable standards, and any other safety, security, regulatory or other requirements.

These resources are subject to change without notice. TI grants you permission to use these resources only for development of an application that uses the TI products described in the resource. Other reproduction and display of these resources is prohibited. No license is granted to any other TI intellectual property right or to any third party intellectual property right. TI disclaims responsibility for, and you will fully indemnify TI and its representatives against, any claims, damages, costs, losses, and liabilities arising out of your use of these resources.

TI's products are provided subject to [TI's Terms of Sale](#) or other applicable terms available either on [ti.com](https://www.ti.com) or provided in conjunction with such TI products. TI's provision of these resources does not expand or otherwise alter TI's applicable warranties or warranty disclaimers for TI products.

TI objects to and rejects any additional or different terms you may have proposed.

Mailing Address: Texas Instruments, Post Office Box 655303, Dallas, Texas 75265
Copyright © 2024, Texas Instruments Incorporated