

# AFE7952 Quad-Channel RF Transceiver

## 1 Features

- Quad RF sampling 12-GSPS transmit DACs
- Quad RF sampling 3-GSPS receive ADCs
- Dual RF sampling 3-GSPS feedback ADCs
- Maximum RF signal bandwidth:
  - TX: 2400 MHz for 2TX or 1200 MHz for 4TX
  - FB: 1200 MHz
  - RX: 1200 MHz (no FB); 600 MHz (with FB)
- RF frequency range: up to 12 GHz
- Digital Step Attenuators (DSA):
  - TX: 40 dB range, 1-dB analog and 0.125-dB digital steps
  - RX: 25 dB range, 0.5-dB steps
- Dual-band DUC/DDCs for TX and RX
- Dual NCOs for fast frequency switching
- Supports TDD operation with fast switching between TX and RX
- Internal PLL/VCO to generate DAC/ADC clocks
- Optional external CLK at DAC or ADC rate
- SerDes data interface:
  - JESD204B and JESD204C compliant
  - 8 SerDes transceivers up to 29.5 Gbps
  - 8b/10b and 64b/66b encoding
  - 12-bit, 16-bit, 24-bit, and 32-bit resolution
  - Subclass 1 multi-device synchronization
- Package: 17-mm × 17-mm FCBGA, 0.8-mm pitch

## 2 Applications

- [Macro remote radio unit \(RRU\)](#)
- [Active antenna system mMIMO \(AAS\)](#)
- [Small cell base station](#)
- [Repeater](#)
- 5G mmWave radio
- Distributed Antenna Systems (DAS)

## 3 Description

The high performance, wide bandwidth multi-channel transceiver, integrating four RF sampling transmitter chains, four RF sampling receiver chains, and two RF sampling digitizing auxiliary chains (feedback paths). The high dynamic range of the transmitter and receiver chains allows the device to generate and receive 3G, 4G, and 5G signals from wireless base stations, while the wide bandwidth capability of the is designed for multi-band 4G and 5G base stations.

Each receiver chain includes a 25-dB range DSA (Digital Step Attenuator), followed by a 3-GSPS ADC (analog-to-digital converter). Each receiver channel has an analog peak power detector and various digital power detectors to assist an external or internal autonomous automatic gain controller, and RF overload detectors for device reliability protection. The single or dual digital down converters (DDC) provide up to 600 MHz of combined signal BW in dual DDC mode or 1200-MHz BW in single DDC mode. In TDD mode, the receiver channel can be configured to dynamically switch between the traffic receiver (TDD RX) and wideband feedback receiver (TDD FB), with the capability of reusing the same analog input for both purposes.

Each transmitter chain includes a single or dual digital up-converters (DUCs) supporting up to 2400 MHz for 2TX or 1200 MHz BW for 4TX combined signal bandwidth. The output of the DUCs drives a 12-GSPS DAC (digital-to-analog converter) with a mixed mode output option to enhance 2nd or 3rd Nyquist operation. The DAC output includes a variable gain amplifier (TX DSA) with 40-dB range and 1-dB analog and 0.125-dB digital steps.

The feedback path includes an 25-dB range DSA driving a 3-GSPS RF sampling ADC, followed by a DDC with up to 1200 MHz bandwidth.

### Package Information<sup>(1)</sup>

PART NUMBER	PACKAGE	BODY SIZE
AFE7952	FC BGA	17.00 mm × 17.00 mm

(1) For more information, see [Mechanical, Packaging, and Orderable Information](#).



## 4 Functional Block Diagram

### 4.1 AFE7952 Functional Block Diagram

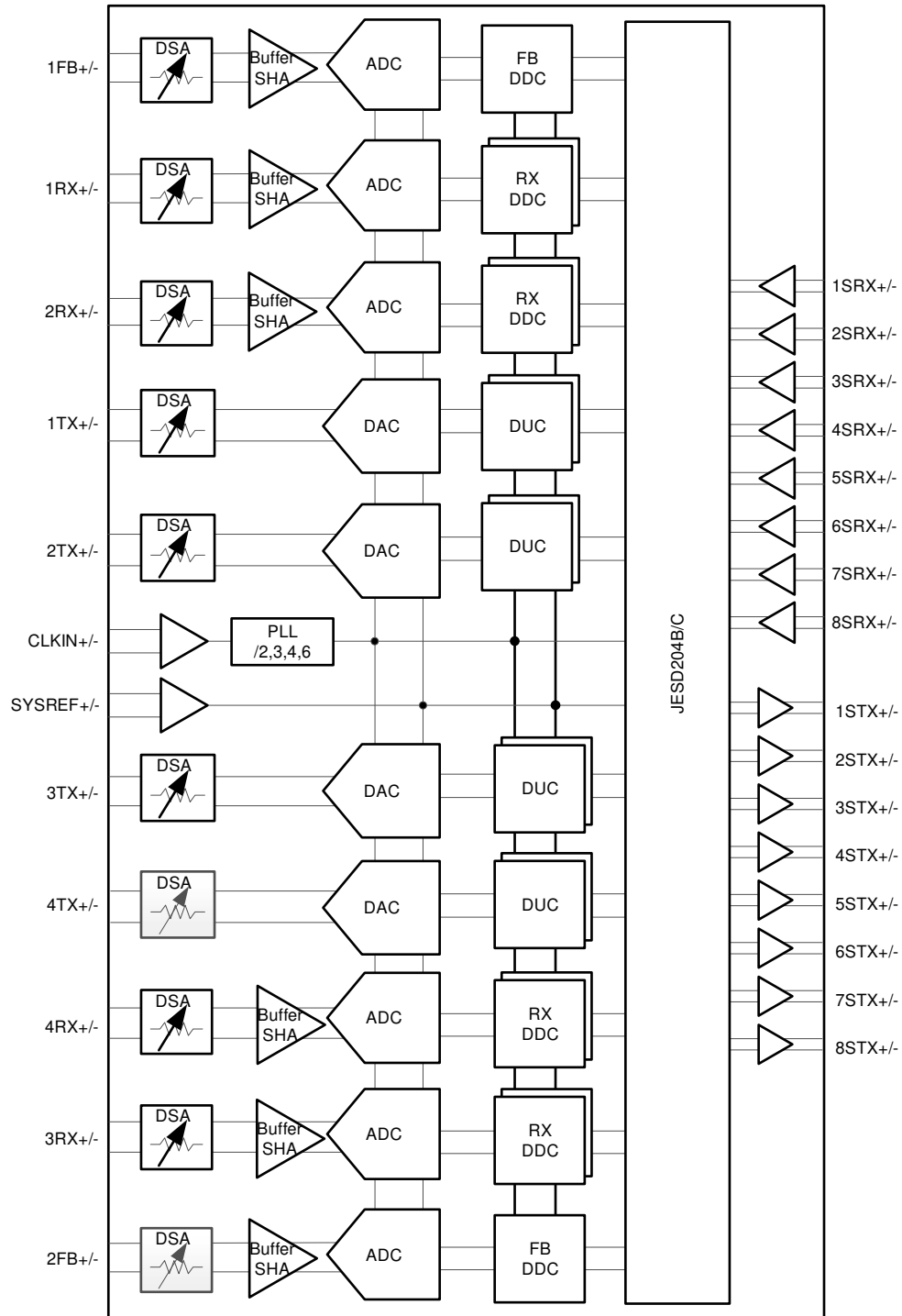

## Table of Contents

<b>1 Features</b> .....	<b>1</b>	<b>6 Device and Documentation Support</b> .....	<b>4</b>
<b>2 Applications</b> .....	<b>1</b>	6.1 Trademarks.....	4
<b>3 Description</b> .....	<b>1</b>	6.2 Electrostatic Discharge Caution.....	4
<b>4 Functional Block Diagram</b> .....	<b>2</b>	6.3 Glossary.....	4
4.1 AFE7952 Functional Block Diagram.....	2	<b>7 Mechanical, Packaging, and Orderable Information</b> ....	<b>4</b>
<b>5 Revision History</b> .....	<b>3</b>		

## 5 Revision History

NOTE: Page numbers for previous revisions may differ from page numbers in the current version.

DATE	VERSION	NOTES
November 2022	*	Initial release.

## 6 Device and Documentation Support

### 6.1 Trademarks

All trademarks are the property of their respective owners.

### 6.2 Electrostatic Discharge Caution



This integrated circuit can be damaged by ESD. Texas Instruments recommends that all integrated circuits be handled with appropriate precautions. Failure to observe proper handling and installation procedures can cause damage.

ESD damage can range from subtle performance degradation to complete device failure. Precision integrated circuits may be more susceptible to damage because very small parametric changes could cause the device not to meet its published specifications.

### 6.3 Glossary

#### [TI Glossary](#)

This glossary lists and explains terms, acronyms, and definitions.

## 7 Mechanical, Packaging, and Orderable Information

The following pages include mechanical, packaging, and orderable information. This information is the most current data available for the designated devices. This data is subject to change without notice and revision of this document. For browser-based versions of this data sheet, refer to the left-hand navigation.

**PACKAGE OUTLINE**

**ABJ0400A**

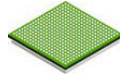

**FCBGA - 2.65 mm max height**

BALL GRID ARRAY

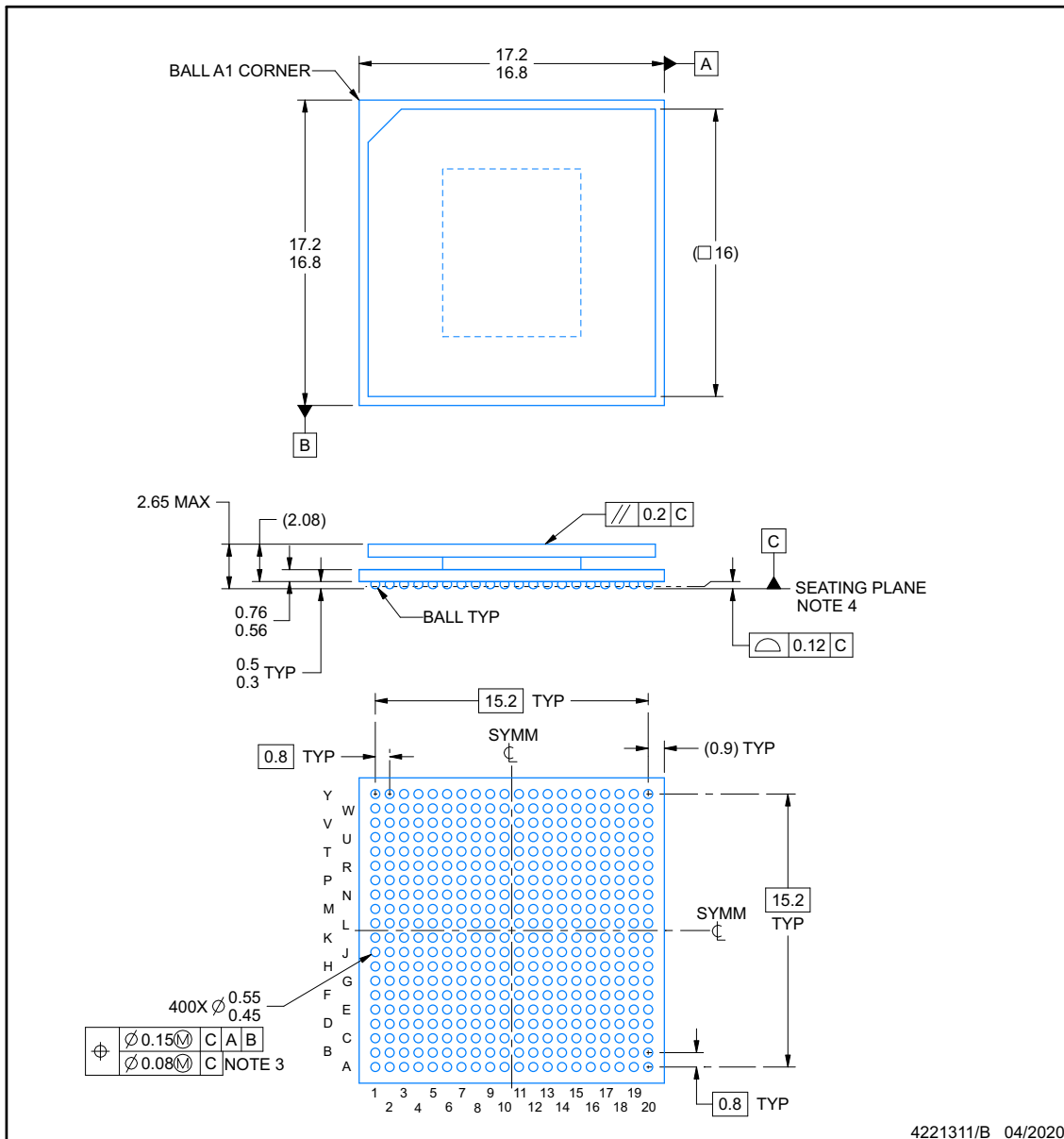

**NOTES:**

1. All linear dimensions are in millimeters. Any dimensions in parenthesis are for reference only. Dimensioning and tolerancing per ASME Y14.5M.
2. This drawing is subject to change without notice.
3. Dimension is measured at the maximum solder ball diameter, parallel to primary datum C.
4. Primary datum C and seating plane are defined by the spherical crowns of the solder balls.

## EXAMPLE BOARD LAYOUT

**ABJ0400A**

**FCBGA - 2.65 mm max height**

BALL GRID ARRAY

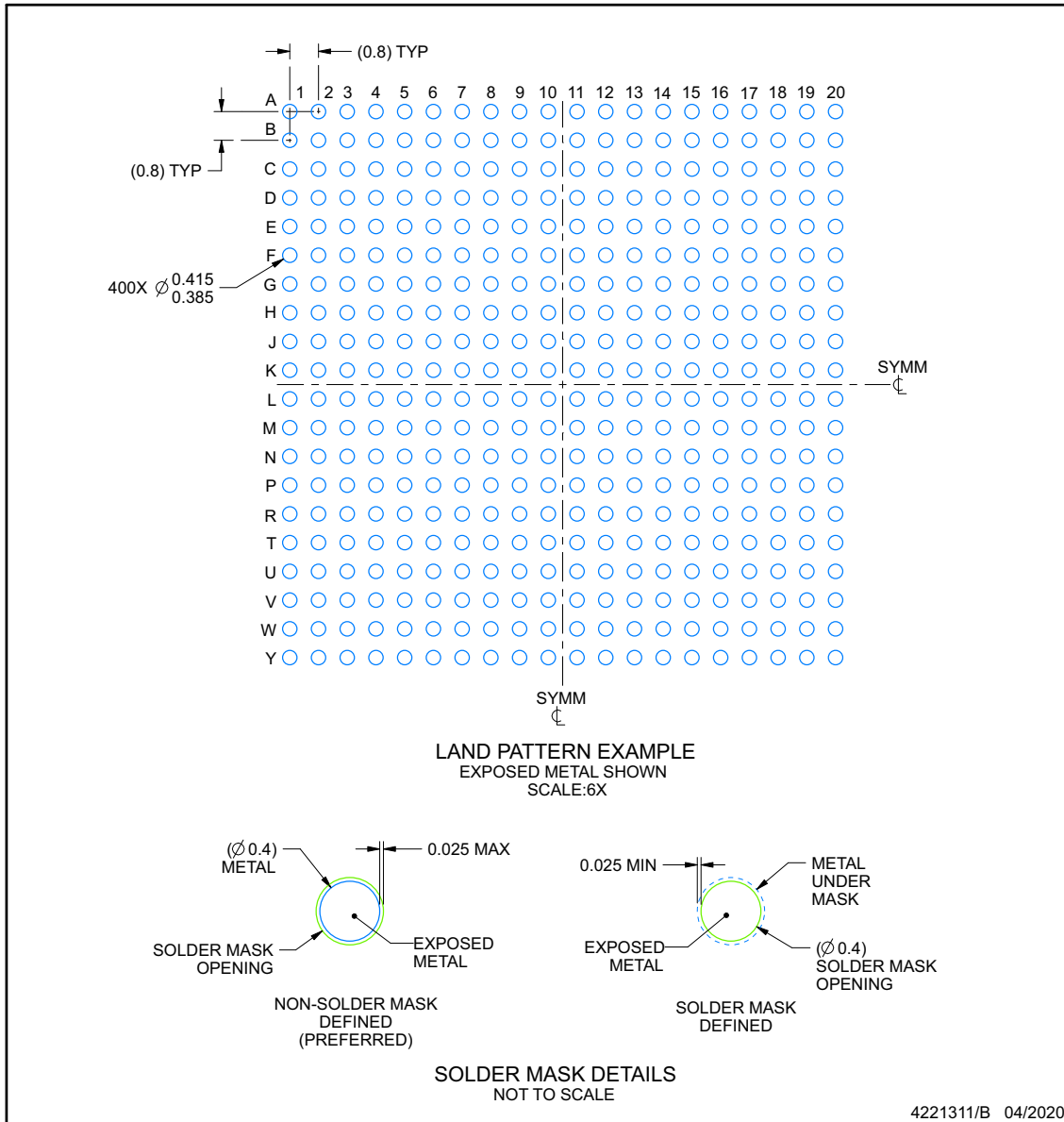

NOTES: (continued)

- Final dimensions may vary due to manufacturing tolerance considerations and also routing constraints. For more information, see Texas Instruments literature number SPRU811 ([www.ti.com/lit/spru811](http://www.ti.com/lit/spru811)).

**EXAMPLE STENCIL DESIGN**

**ABJ0400A**

**FCBGA - 2.65 mm max height**

BALL GRID ARRAY

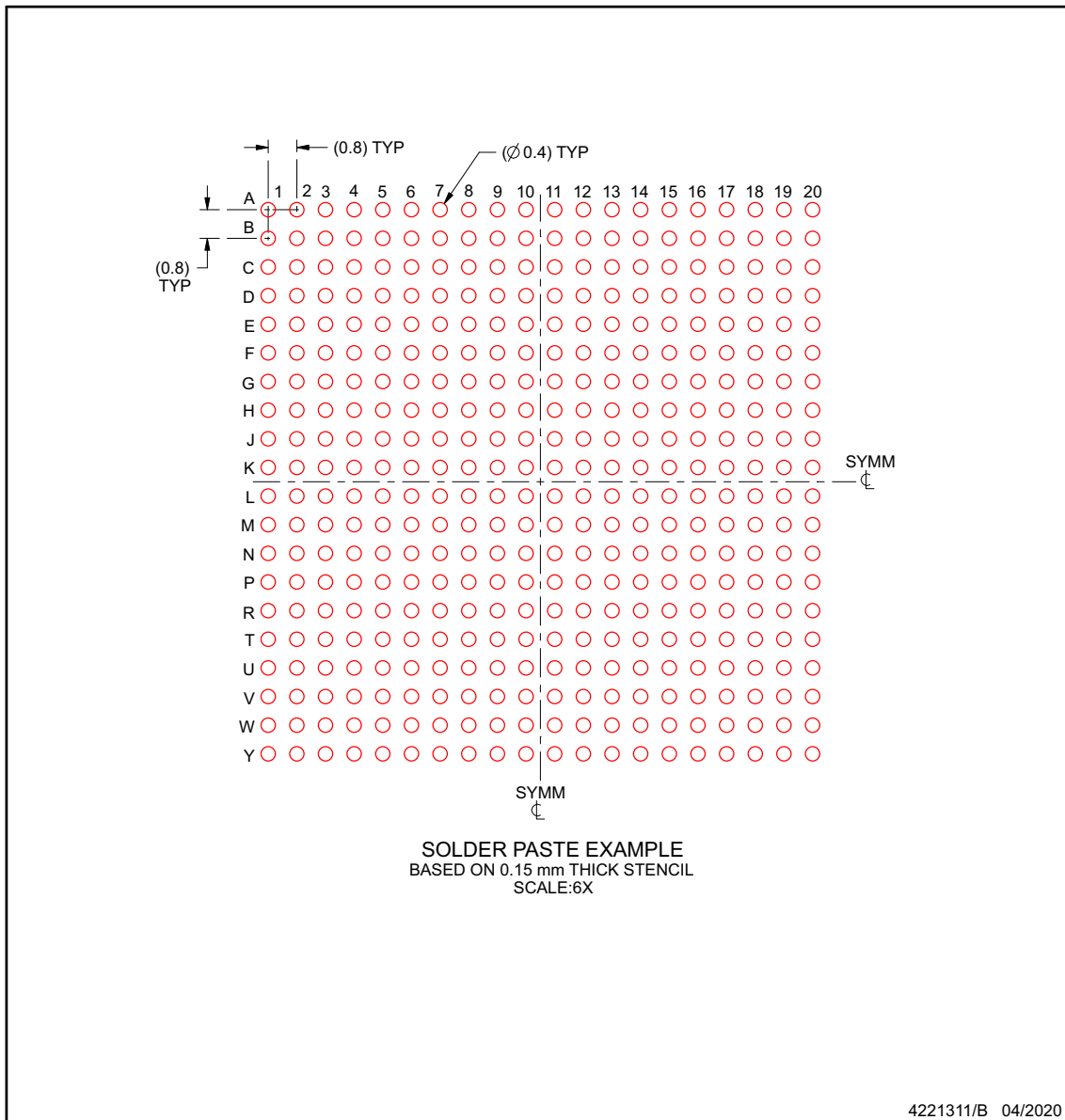

NOTES: (continued)

- 6. Laser cutting apertures with trapezoidal walls and rounded corners may offer better paste release.

**PACKAGING INFORMATION**

Orderable Device	Status (1)	Package Type	Package Drawing	Pins	Package Qty	Eco Plan (2)	Lead finish/ Ball material (6)	MSL Peak Temp (3)	Op Temp (°C)	Device Marking (4/5)	Samples
AFE7952IABJ	ACTIVE	FCBGA	ABJ	400	90	RoHS & Green	SNAGCU	Level-3-260C-168 HR	-40 to 85	AFE7952I	Samples

(1) The marketing status values are defined as follows:

**ACTIVE:** Product device recommended for new designs.

**LIFEBUY:** TI has announced that the device will be discontinued, and a lifetime-buy period is in effect.

**NRND:** Not recommended for new designs. Device is in production to support existing customers, but TI does not recommend using this part in a new design.

**PREVIEW:** Device has been announced but is not in production. Samples may or may not be available.

**OBSELETE:** TI has discontinued the production of the device.

(2) **RoHS:** TI defines "RoHS" to mean semiconductor products that are compliant with the current EU RoHS requirements for all 10 RoHS substances, including the requirement that RoHS substance do not exceed 0.1% by weight in homogeneous materials. Where designed to be soldered at high temperatures, "RoHS" products are suitable for use in specified lead-free processes. TI may reference these types of products as "Pb-Free".

**RoHS Exempt:** TI defines "RoHS Exempt" to mean products that contain lead but are compliant with EU RoHS pursuant to a specific EU RoHS exemption.

**Green:** TI defines "Green" to mean the content of Chlorine (Cl) and Bromine (Br) based flame retardants meet JS709B low halogen requirements of <=1000ppm threshold. Antimony trioxide based flame retardants must also meet the <=1000ppm threshold requirement.

(3) MSL, Peak Temp. - The Moisture Sensitivity Level rating according to the JEDEC industry standard classifications, and peak solder temperature.

(4) There may be additional marking, which relates to the logo, the lot trace code information, or the environmental category on the device.

(5) Multiple Device Markings will be inside parentheses. Only one Device Marking contained in parentheses and separated by a "-" will appear on a device. If a line is indented then it is a continuation of the previous line and the two combined represent the entire Device Marking for that device.

(6) Lead finish/Ball material - Orderable Devices may have multiple material finish options. Finish options are separated by a vertical ruled line. Lead finish/Ball material values may wrap to two lines if the finish value exceeds the maximum column width.

**Important Information and Disclaimer:**The information provided on this page represents TI's knowledge and belief as of the date that it is provided. TI bases its knowledge and belief on information provided by third parties, and makes no representation or warranty as to the accuracy of such information. Efforts are underway to better integrate information from third parties. TI has taken and continues to take reasonable steps to provide representative and accurate information but may not have conducted destructive testing or chemical analysis on incoming materials and chemicals. TI and TI suppliers consider certain information to be proprietary, and thus CAS numbers and other limited information may not be available for release.

In no event shall TI's liability arising out of such information exceed the total purchase price of the TI part(s) at issue in this document sold by TI to Customer on an annual basis.

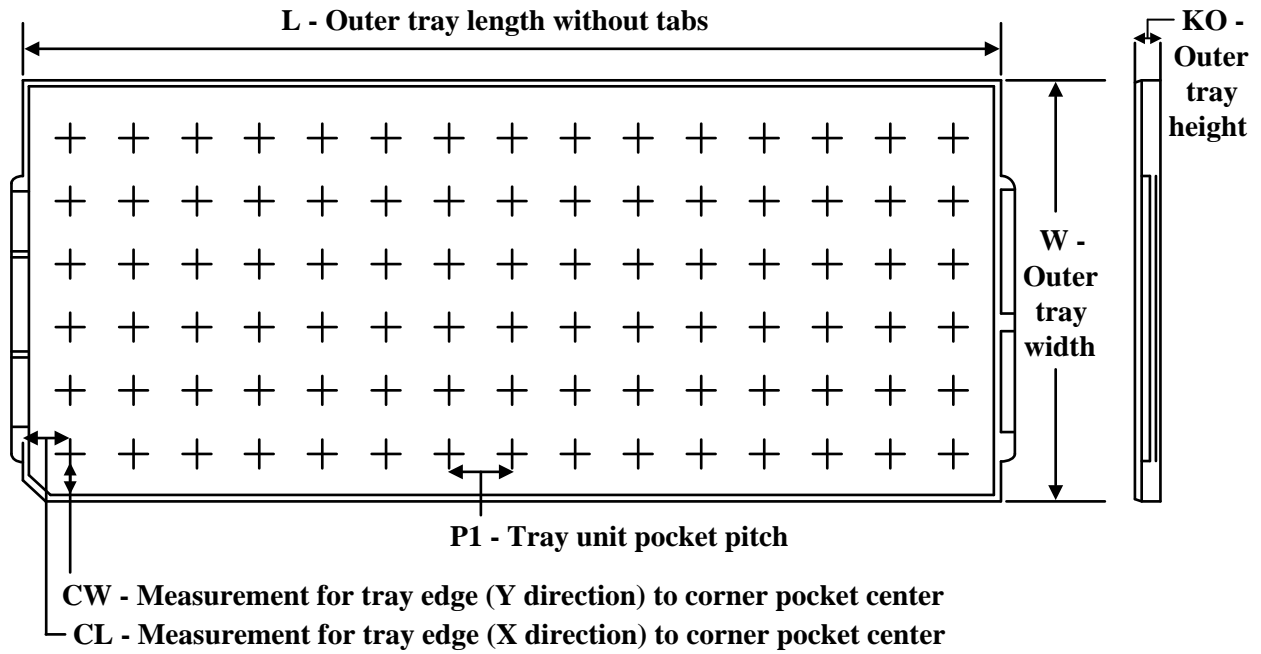

**TRAY**

Chamfer on Tray corner indicates Pin 1 orientation of packed units.

\*All dimensions are nominal

Device	Package Name	Package Type	Pins	SPQ	Unit array matrix	Max temperature (°C)	L (mm)	W (mm)	K0 (µm)	P1 (mm)	CL (mm)	CW (mm)
AFE7952IABJ	ABJ	FCBGA	400	90	6 x 15	150	315	135.9	7620	19.5	21	19.2
AFE7952IABJ	ABJ	FCBGA	400	90	6 x 15	150	315	135.9	7620	19.5	21	19.2



# EXAMPLE BOARD LAYOUT

**ABJ0400A**

**FCBGA - 2.65 mm max height**

BALL GRID ARRAY

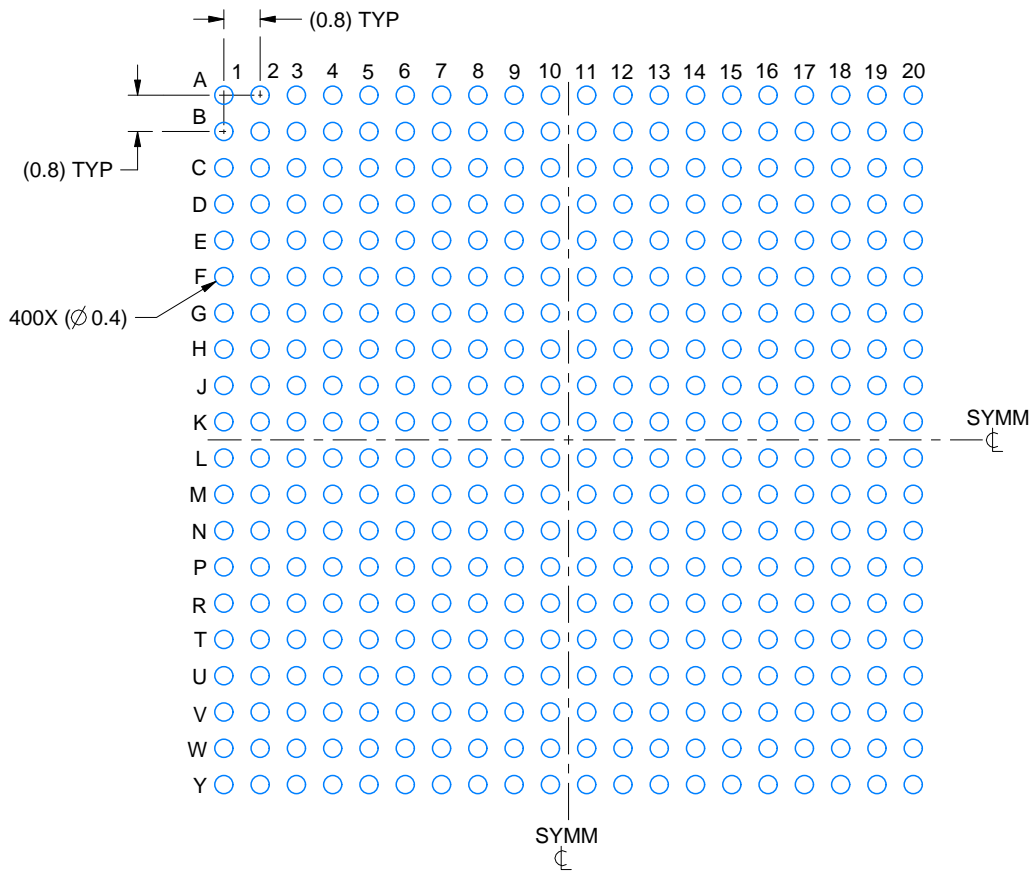

**LAND PATTERN EXAMPLE**  
EXPOSED METAL SHOWN  
SCALE:6X

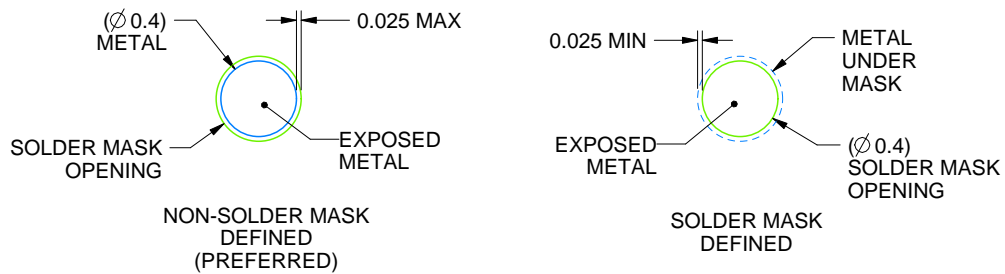

**SOLDER MASK DETAILS**  
NOT TO SCALE

4221311/D 03/2023

NOTES: (continued)

- Final dimensions may vary due to manufacturing tolerance considerations and also routing constraints. For more information, see Texas Instruments literature number SPRU811 ([www.ti.com/lit/spru811](http://www.ti.com/lit/spru811)).

# EXAMPLE STENCIL DESIGN

## ABJ0400A

### FCBGA - 2.65 mm max height

BALL GRID ARRAY

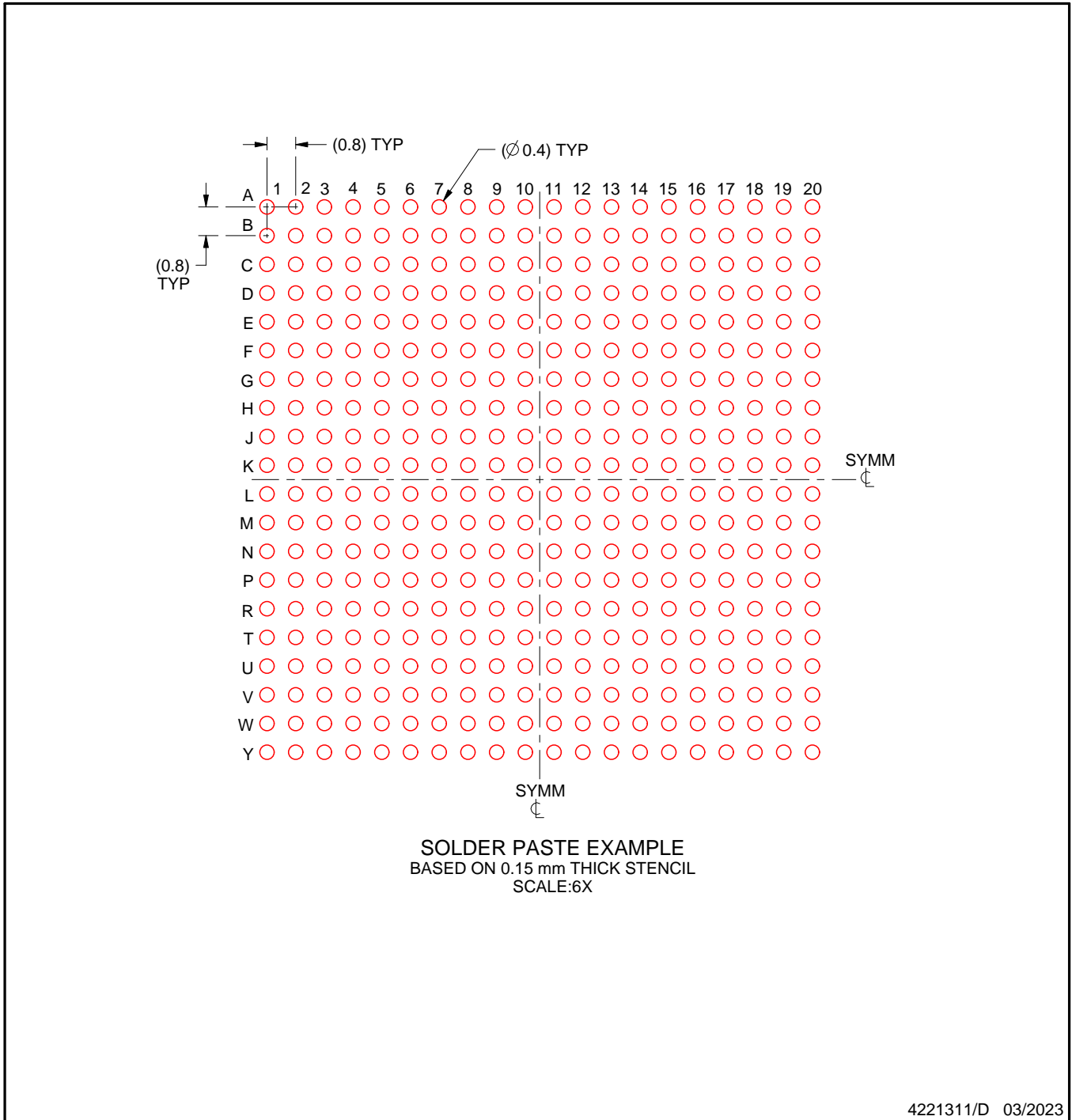

NOTES: (continued)

7. Laser cutting apertures with trapezoidal walls and rounded corners may offer better paste release.

## IMPORTANT NOTICE AND DISCLAIMER

TI PROVIDES TECHNICAL AND RELIABILITY DATA (INCLUDING DATA SHEETS), DESIGN RESOURCES (INCLUDING REFERENCE DESIGNS), APPLICATION OR OTHER DESIGN ADVICE, WEB TOOLS, SAFETY INFORMATION, AND OTHER RESOURCES "AS IS" AND WITH ALL FAULTS, AND DISCLAIMS ALL WARRANTIES, EXPRESS AND IMPLIED, INCLUDING WITHOUT LIMITATION ANY IMPLIED WARRANTIES OF MERCHANTABILITY, FITNESS FOR A PARTICULAR PURPOSE OR NON-INFRINGEMENT OF THIRD PARTY INTELLECTUAL PROPERTY RIGHTS.

These resources are intended for skilled developers designing with TI products. You are solely responsible for (1) selecting the appropriate TI products for your application, (2) designing, validating and testing your application, and (3) ensuring your application meets applicable standards, and any other safety, security, regulatory or other requirements.

These resources are subject to change without notice. TI grants you permission to use these resources only for development of an application that uses the TI products described in the resource. Other reproduction and display of these resources is prohibited. No license is granted to any other TI intellectual property right or to any third party intellectual property right. TI disclaims responsibility for, and you will fully indemnify TI and its representatives against, any claims, damages, costs, losses, and liabilities arising out of your use of these resources.

TI's products are provided subject to [TI's Terms of Sale](#) or other applicable terms available either on [ti.com](https://www.ti.com) or provided in conjunction with such TI products. TI's provision of these resources does not expand or otherwise alter TI's applicable warranties or warranty disclaimers for TI products.

TI objects to and rejects any additional or different terms you may have proposed.

Mailing Address: Texas Instruments, Post Office Box 655303, Dallas, Texas 75265  
Copyright © 2024, Texas Instruments Incorporated