

# BQ25895 I<sup>2</sup>C Controlled Single Cell 5-A Fast Charger with MaxCharge™ for High Input Voltage and Adjustable Voltage 3.1-A Boost Operation

## 1 Features

- High efficiency 5-A, 1.5-MHz switch mode buck charge
  - 93% Charge efficiency at 2 A and 91% charge efficiency at 3 A charge current
  - Optimize for high voltage input (9 V to 12 V)
  - Low Power PFM Mode for light load operations
- Boost Mode operation with adjustable output from 4.5 V to 5.5 V
  - Selectable 500-KHz to 1.5-MHz boost converter with up to 3.1-A output
  - 93% Boost efficiency at 5 V at 1 A output
- Integrated control to switch between charge and Boost Mode
- Single input to support USB input and adjustable high voltage adapters
  - Support 3.9-V to 14-V input voltage range
  - Input current limit (100 mA to 3.25 A with 50-mA resolution) to support USB2.0, USB3.0 standard and high voltage adapters
  - Maximum power tracking by input voltage limit up-to 14V for wide range of adapters
  - Auto detect USB SDP, CDP, DCP, and Non-standard Adapters
- Input current optimizer (ICO) to maximize input power without overloading adapters
- Resistance compensation (IRCOMP) from charger output to cell terminal
- Highest battery discharge efficiency with 11-mΩ battery discharge MOSFET up to 9 A
- Integrated ADC for system monitor (voltage, temperature, charge current)
- Narrow VDC (NVDC) power path management
  - Instant-on works with no battery or deeply discharged battery
  - Ideal diode operation in Battery Supplement Mode
- BATFET Control to support Ship Mode, wake up, and full system reset
- Flexible autonomous and I<sup>2</sup>C Mode for optimal system performance
- High integration includes all MOSFETs, current sensing and loop compensation
- 12-μA Low battery leakage current to support Ship Mode
- High accuracy
  - ±0.5% Charge voltage regulation
  - ±5% Charge current regulation
  - ±7.5% Input current regulation

- Safety
  - Battery temperature sensing for charge and Boost Mode
  - Thermal regulation and thermal shutdown

## 2 Applications

- **Power bank**, mobile Wi-Fi hotspot
- Wireless Bluetooth **speaker**
- **Portable** internet devices

## 3 Description

The BQ25895 is a highly-integrated 5-A switch-mode battery charge management and system power path management device for single cell Li-Ion and Li-polymer battery. The devices support high input voltage fast charging. The low impedance power path optimizes switch-mode operation efficiency, reduces battery charging time and extends battery life during discharging phase.

### Device Information

| PART NUMBER | PACKAGE <sup>(1)</sup> | BODY SIZE (NOM) |
|-------------|------------------------|-----------------|
| BQ25895     | WQFN (24)              | 4.00mm x 4.00mm |

- (1) For all available packages, see the orderable addendum at the end of the data sheet.

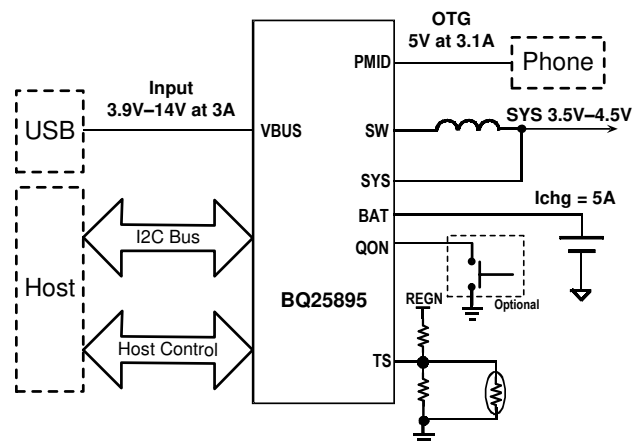

**Simplified Schematic**



## Table of Contents

|                                                   |    |                                                                  |    |
|---------------------------------------------------|----|------------------------------------------------------------------|----|
| <b>1 Features</b> .....                           | 1  | 8.4 Register Maps.....                                           | 32 |
| <b>2 Applications</b> .....                       | 1  | <b>9 Application and Implementation</b> .....                    | 49 |
| <b>3 Description</b> .....                        | 1  | 9.1 Application Information.....                                 | 49 |
| <b>4 Revision History</b> .....                   | 2  | 9.2 Typical Application.....                                     | 49 |
| <b>5 Description (continued)</b> .....            | 3  | 9.3 System Examples.....                                         | 53 |
| <b>6 Pin Configuration and Functions</b> .....    | 4  | <b>10 Power Supply Recommendations</b> .....                     | 54 |
| <b>7 Specifications</b> .....                     | 6  | <b>11 Layout</b> .....                                           | 55 |
| 7.1 Absolute Maximum Ratings <sup>(1)</sup> ..... | 6  | 11.1 Layout Guidelines.....                                      | 55 |
| 7.2 ESD Ratings.....                              | 6  | 11.2 Layout Example.....                                         | 55 |
| 7.3 Recommended Operating Conditions.....         | 6  | <b>12 Device and Documentation Support</b> .....                 | 56 |
| 7.4 Thermal Information.....                      | 7  | 12.1 Device Support.....                                         | 56 |
| 7.5 Electrical Characteristics.....               | 7  | 12.2 Receiving Notification of Documentation Updates.....        | 56 |
| 7.6 Timing Requirements.....                      | 11 | 12.3 Support Resources.....                                      | 56 |
| 7.7 Typical Characteristics.....                  | 12 | 12.4 Trademarks.....                                             | 56 |
| <b>8 Detailed Description</b> .....               | 14 | 12.5 Glossary.....                                               | 56 |
| 8.1 Functional Block Diagram.....                 | 14 | 12.6 Electrostatic Discharge Caution.....                        | 56 |
| 8.2 Feature Description.....                      | 15 | <b>13 Mechanical, Packaging, and Orderable Information</b> ..... | 56 |
| 8.3 Device Functional Modes.....                  | 31 |                                                                  |    |

## 4 Revision History

| Changes from Revision B (May 2018) to Revision C (October 2022)                                                                                                                                                                                                                                                                    | Page |
|------------------------------------------------------------------------------------------------------------------------------------------------------------------------------------------------------------------------------------------------------------------------------------------------------------------------------------|------|
| • Deleted WEBENCH throughout data sheet.....                                                                                                                                                                                                                                                                                       | 1    |
| • Updated inclusive terminology throughout data sheet.....                                                                                                                                                                                                                                                                         | 1    |
| • Changed PMID description .....                                                                                                                                                                                                                                                                                                   | 4    |
| • Changed REG01 default setting from 06 to 05.....                                                                                                                                                                                                                                                                                 | 33   |
| Changes from Revision A (May 216) to Revision B (May 2018)                                                                                                                                                                                                                                                                         | Page |
| • Added "SW (peak for 10 ns duration)" To the Absolute Maximum Rating .....                                                                                                                                                                                                                                                        | 6    |
| • Updated the <a href="#">Section 7.4</a> values.....                                                                                                                                                                                                                                                                              | 6    |
| • Changed V <sub>SYS</sub> TYP value From: V <sub>BAT</sub> + 50 mV To: I <sub>(SYS)</sub> + 150 mV.....                                                                                                                                                                                                                           | 7    |
| • Changed the title of <a href="#">Figure 7-4</a> From: Charge Current Accuracy To: I <sup>2</sup> C Setting .....                                                                                                                                                                                                                 | 12   |
| • Changed axis title of <a href="#">Figure 7-8</a> From: BAT Voltage (V) To: Input Current Limit (mA).....                                                                                                                                                                                                                         | 12   |
| • Changed V <sub>VREF</sub> to V <sub>REGN</sub> in <a href="#">Figure 8-7</a> .....                                                                                                                                                                                                                                               | 22   |
| • Changed V <sub>VREF</sub> to V <sub>REGN</sub> in <a href="#">Equation 2</a> .....                                                                                                                                                                                                                                               | 22   |
| • Changed V <sub>REF</sub> to V <sub>REGN</sub> in <a href="#">Figure 8-8</a> .....                                                                                                                                                                                                                                                | 23   |
| • Added sentence to the Battery Monitor section "In battery only mode, .."                                                                                                                                                                                                                                                         | 24   |
| • Changed bit 5 From: 0 To: 1 in <a href="#">Figure 8-21</a> .....                                                                                                                                                                                                                                                                 | 35   |
| • Changed the Description values of <a href="#">Table 8-26</a> From: mV To: mA.....                                                                                                                                                                                                                                                | 47   |
| • Changed the Type values of Bits 6 to Bit 0 in <a href="#">Table 8-28</a> From: R/W To: R.....                                                                                                                                                                                                                                    | 48   |
| • Added V <sub>REF</sub> system pullup voltage to <a href="#">Table 9-1</a> .....                                                                                                                                                                                                                                                  | 49   |
| • Changed <a href="#">Figure 9-3</a> .....                                                                                                                                                                                                                                                                                         | 51   |
| Changes from Revision * (March 2015) to Revision A (May 2016)                                                                                                                                                                                                                                                                      | Page |
| • Added Pin Configuration and Functions section, ESD Rating table, Feature Description section, Device Functional Modes, Application and Implementation section, Power Supply Recommendations section, Layout section, Device and Documentation Support section, and Mechanical, Packaging, and Orderable Information section..... | 1    |

## 5 Description (continued)

The I<sup>2</sup>C Serial interface with charging and system settings makes the device a truly flexible solution.

The device supports a wide range of input sources, including standard USB host port, USB charging port, and USB compliant adjustable high voltage adapter. To support fast charging using adjustable high voltage adapter, the BQ25895 provides support MaxCharge™ using D+/D– pins and DSEL pin for USB switch control. In addition, the device includes interface to support adjustable high voltage adapter using input current pulse protocol. To set the default input current limit, device uses the built-in USB interface. The device is compliant with USB 2.0 and USB 3.0 power spec with input current and voltage regulation. In addition, the Input Current Optimizer (ICO) supports the detection of maximum power point detection of the input source without overload. The device supports battery boost operation by supplying adjustable 4.5 V to 5.5 V on PMID pin with up to 3.1 A with integrated charge and boost mode detection

## 6 Pin Configuration and Functions

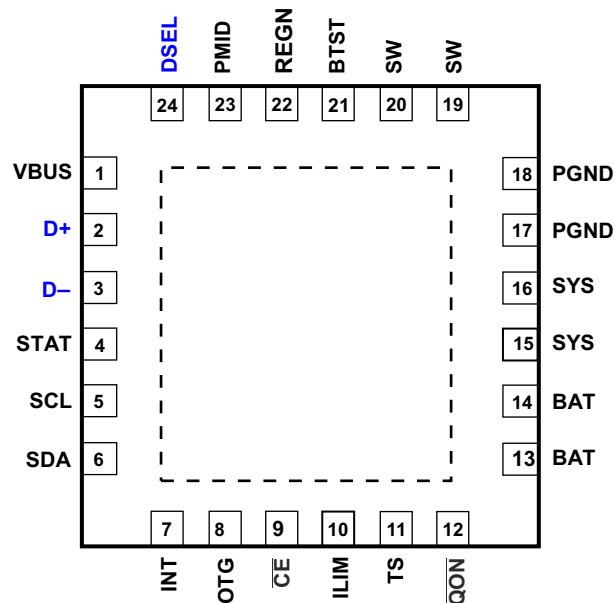

Figure 6-1. BQ25895 RTW (WQFN) Top View

Table 6-1. Pin Functions

| PIN                    |     | TYPE <sup>(1)</sup> | DESCRIPTION                                                                                                                                                                                                                                                                                                                                                                                                                                                                                                                                                                                                                                                                                                                                                                                                             |
|------------------------|-----|---------------------|-------------------------------------------------------------------------------------------------------------------------------------------------------------------------------------------------------------------------------------------------------------------------------------------------------------------------------------------------------------------------------------------------------------------------------------------------------------------------------------------------------------------------------------------------------------------------------------------------------------------------------------------------------------------------------------------------------------------------------------------------------------------------------------------------------------------------|
| NAME                   | NO. |                     |                                                                                                                                                                                                                                                                                                                                                                                                                                                                                                                                                                                                                                                                                                                                                                                                                         |
| VBUS                   | 1   | P                   | Charger Input Voltage.<br>The internal n-channel reverse block MOSFET (RBFET) is connected between VBUS and PMID with VBUS on source. Place a 1- $\mu$ F ceramic capacitor from VBUS to PGND and place it as close as possible to IC.                                                                                                                                                                                                                                                                                                                                                                                                                                                                                                                                                                                   |
| D+                     | 2   | AIO                 | Positive line of the USB data line pair.<br>D+/D- based USB host/charging port detection. The detection includes data contact detection (DCD), primary and secondary detection in BC1.2, and Adjustable high voltage adapter (MaxCharge).                                                                                                                                                                                                                                                                                                                                                                                                                                                                                                                                                                               |
| D-                     | 3   | AIO                 | Negative line of the USB data line pair.<br>D+/D- based USB host/charging port detection. The detection includes data contact detection (DCD), primary and secondary detection in BC1.2, and Adjustable high voltage adapter (MaxCharge).                                                                                                                                                                                                                                                                                                                                                                                                                                                                                                                                                                               |
| STAT                   | 4   | DO                  | Open drain charge status output to indicate various charger operation.<br>Connect to the pull up rail via 10-k $\Omega$ resistor. LOW indicates charge in progress. HIGH indicates charge complete or charge disabled. When any fault condition occurs, STAT pin blinks in 1 Hz.<br>The STAT pin function can be disabled when STAT_DIS bit is set.                                                                                                                                                                                                                                                                                                                                                                                                                                                                     |
| SCL                    | 5   | DI                  | I <sup>2</sup> C Interface clock.<br>Connect SCL to the logic rail through a 10-k $\Omega$ resistor.                                                                                                                                                                                                                                                                                                                                                                                                                                                                                                                                                                                                                                                                                                                    |
| SDA                    |     | DIO                 | I <sup>2</sup> C Interface data.<br>Connect SDA to the logic rail through a 10-k $\Omega$ resistor.                                                                                                                                                                                                                                                                                                                                                                                                                                                                                                                                                                                                                                                                                                                     |
| INT                    | 7   | DO                  | Open-drain Interrupt Output.<br>Connect the INT to a logic rail via 10-k $\Omega$ resistor. The INT pin sends active low, 256- $\mu$ s pulse to host to report charger device status and fault.                                                                                                                                                                                                                                                                                                                                                                                                                                                                                                                                                                                                                         |
| OTG                    | 8   | DI                  | Boost mode enable pin.<br>The boost mode is activated when OTG_CONFIG = 1, OTG pin is high, and no input source is detected at VBUS                                                                                                                                                                                                                                                                                                                                                                                                                                                                                                                                                                                                                                                                                     |
| $\overline{\text{CE}}$ | 9   | DI                  | Active low Charge Enable pin.<br>Battery charging is enabled when CHG_CONFIG = 1 and $\overline{\text{CE}}$ pin = Low. $\overline{\text{CE}}$ pin must be pulled High or Low.                                                                                                                                                                                                                                                                                                                                                                                                                                                                                                                                                                                                                                           |
| ILIM                   | 10  | AI                  | Input current limit Input. ILIM pin sets the maximum input current and can be used to monitor input current<br>ILIM pin sets the maximum input current limit by regulating the ILIM voltage at 0.8 V. A resistor is connected from ILIM pin to ground to set the maximum limit as $I_{INMAX} = K_{ILIM}/R_{ILIM}$ . The actual input current limit is the lower limit set by ILIM pin (when EN_ILIM bit is high) or IILNIM register bits. Input current limit of less than 500 mA is not support on ILIM pin.<br>ILIM pin can also be used to monitor input current when the voltage is below 0.8V. The input current is proportional to the voltage on ILIM pin and can be calculated by $I_{IN} = (K_{ILIM} \times V_{ILIM}) / (R_{ILIM} \times 0.8)$<br>The ILIM pin function can be disabled when EN_ILIM bit is 0. |

**Table 6-1. Pin Functions (continued)**

| PIN                     |       | TYPE <sup>(1)</sup> | DESCRIPTION                                                                                                                                                                                                                                                                                                                                                                                                                                                                                                          |
|-------------------------|-------|---------------------|----------------------------------------------------------------------------------------------------------------------------------------------------------------------------------------------------------------------------------------------------------------------------------------------------------------------------------------------------------------------------------------------------------------------------------------------------------------------------------------------------------------------|
| NAME                    | NO.   |                     |                                                                                                                                                                                                                                                                                                                                                                                                                                                                                                                      |
| TS                      | 11    | AI                  | Temperature qualification voltage input.<br>Connect a negative temperature coefficient thermistor. Program temperature window with a resistor divider from REGN to TS to GND. Charge suspends when either TS pin is out of range. Recommend 103AT-2 thermistor.                                                                                                                                                                                                                                                      |
| $\overline{\text{QON}}$ | 12    | DI                  | BATFET enable/reset control input.<br>When BATFET is in ship mode, a logic low of $t_{\text{SHIPMODE}}$ duration turns on BATFET to exit shipping mode.<br>When VBUS is not plugged-in, a logic low of $t_{\text{QON\_RST}}$ duration resets SYS (system power) by turning BATFET off for $t_{\text{BATFET\_RST}}$ and then re-enable BATFET to provide full system power reset.<br>The pin contains an internal pull-up to maintain default high logic                                                              |
| BAT                     | 13,14 | P                   | Battery connection point to the positive terminal of the battery pack.<br>The internal BATFET is connected between BAT and SYS. Connect a 10uF closely to the BAT pin.                                                                                                                                                                                                                                                                                                                                               |
| SYS                     | 15,16 | P                   | System connection point.<br>The internal BATFET is connected between BAT and SYS. When the battery falls below the minimum system voltage, switch-mode converter keeps SYS above the minimum system voltage. Connect a 20uF closely to the SYS pin.                                                                                                                                                                                                                                                                  |
| PGND                    | 17,18 | P                   | Power ground connection for high-current power converter node.<br>Internally, PGND is connected to the source of the n-channel LSFET. On PCB layout, connect directly to ground connection of input and output capacitors of the charger. A single point connection is recommended between power PGND and the analog GND near the IC PGND pin.                                                                                                                                                                       |
| SW                      | 19,20 | P                   | Switching node connecting to output inductor.<br>Internally SW is connected to the source of the n-channel HSFET and the drain of the n-channel LSFET.<br>Connect the 0.047uF bootstrap capacitor from SW to BTST.                                                                                                                                                                                                                                                                                                   |
| BTST                    | 21    | P                   | PWM high side driver positive supply.<br>Internally, the BTST is connected to the anode of the boost-strap diode. Connect the 0.047uF bootstrap capacitor from SW to BTST.                                                                                                                                                                                                                                                                                                                                           |
| REGN                    | 22    | P                   | PWM low side driver positive supply output.<br>Internally, REGN is connected to the cathode of the boost-strap diode. Connect a 4.7uF (10 V rating) ceramic capacitor from REGN to analog GND. The capacitor should be placed close to the IC. REGN also serves as bias rail of TS pin.                                                                                                                                                                                                                              |
| PMID                    | 23    | DO                  | Battery boost mode output.<br>Connected to the drain of the reverse blocking MOSFET (RBFET) and the drain of HSFET. If OTG is not used, the minimum capacitance required on PMID to PGND is 8.2 uF. If OTG is used, the minimum capacitance required on PMID to PGND is 40 uF for up-to 2.4A output and 60 uF for up-to 3.1A output.                                                                                                                                                                                 |
| DSEL                    | 24    | DO                  | Open-drain D+/D- multiplexer selection control.<br>Connect the DSEL to a logic rail via 10-KΩ resistor. The pin is normally float and pull-up by external resistor. During <a href="#">Section 8.2.3.3</a> , the pin drives low to indicate the device D+/D- detection is in progress and needs to take control of D+, D- signals. When detection is completed, the pin keeps low when MaxCharge is detected. The pin returns to float and pulls high by external resistor when other input source type is detected. |
| PowerPAD™               |       | P                   | Exposed pad beneath the IC for heat dissipation. Always solder PowerPAD Pad to the board, and have vias on the PowerPAD plane star-connecting to PGND and ground plane for high-current power converter.                                                                                                                                                                                                                                                                                                             |

(1) DI (Digital Input), DO (Digital Output), DIO (Digital Input/Output), AI (Analog Input), AO (Analog Output), AIO (Analog Input/Output)

## 7 Specifications

### 7.1 Absolute Maximum Ratings<sup>(1)</sup>

over operating free-air temperature range (unless otherwise noted)

|                                      |                                                                  | MIN  | MAX | VALUE |
|--------------------------------------|------------------------------------------------------------------|------|-----|-------|
| Voltage range (with respect to GND)  | VBUS (converter not switching)                                   | -2   | 22  | V     |
|                                      | PMID (converter not switching)                                   | -0.3 | 22  | V     |
|                                      | STAT                                                             | -0.3 | 20  | V     |
|                                      | DSEL                                                             | -0.3 | 20  | V     |
|                                      | BTST                                                             | -0.3 | 20  | V     |
|                                      | SW                                                               | -2   | 16  | V     |
|                                      | SW (peak for 10 ns duration)                                     | -3   | 16  | V     |
|                                      | BAT, SYS (converter not switching)                               | -0.3 | 6   | V     |
|                                      | SDA, SCL, INT, OTG, REGN, TS, $\overline{CE}$ , $\overline{QON}$ | -0.3 | 7   | V     |
|                                      | D+, D-                                                           | -0.3 | 7   | V     |
|                                      | BTST TO SW                                                       | -0.3 | 7   | V     |
|                                      | PGND to GND                                                      | -0.3 | 0.3 | V     |
|                                      | ILIM                                                             | -0.3 | 5   | V     |
| Output sink current                  | INT, STAT                                                        |      | 6   | mA    |
|                                      | DSEL                                                             |      | 6   | mA    |
| Junction temperature                 |                                                                  | -40  | 150 | °C    |
| Storage temperature range, $T_{stg}$ |                                                                  | -65  | 150 | °C    |

- (1) Stresses beyond those listed under absolute maximum ratings may cause permanent damage to the device. These are stress ratings only, and functional operation of the device at these or any other conditions beyond those indicated under recommended operating conditions is not implied. Exposure to absolute-maximum-rated conditions for extended periods may affect device reliability. All voltage values are with respect to the network ground terminal unless otherwise noted.

### 7.2 ESD Ratings

|           |                         | VALUE                                                                          | UNIT  |   |
|-----------|-------------------------|--------------------------------------------------------------------------------|-------|---|
| $V_{ESD}$ | Electrostatic discharge | Human body model (HBM), per ANSI/ESDA/JEDEC JS-001 <sup>(1)</sup>              | ±2000 | V |
|           |                         | Charged device model (CDM), per JEDEC specification JESD22-C101 <sup>(2)</sup> | ±250  | V |

- (1) JEDEC document JEP155 states that 500-V HBM allows safe manufacturing with a standard ESD control process.  
(2) JEDEC document JEP157 states that 250-V CDM allows safe manufacturing with a standard ESD control process.

### 7.3 Recommended Operating Conditions

over operating free-air temperature range (unless otherwise noted)

|           |                                          | MIN | NOM | MAX                                                        | UNIT |
|-----------|------------------------------------------|-----|-----|------------------------------------------------------------|------|
| $V_{IN}$  | Input voltage                            | 3.9 |     | 14 <sup>(1)</sup>                                          | V    |
| $I_{IN}$  | Input current (VBUS)                     |     |     | 3.25                                                       | A    |
| $I_{SYS}$ | Output current (SW)                      |     |     | 5                                                          | A    |
| $V_{BAT}$ | Battery voltage                          |     |     | 4.608                                                      | V    |
| $I_{BAT}$ | Fast charging current                    |     |     | 5                                                          | A    |
|           | Discharging current with internal MOSFET |     |     | Up to 6 (continuous)<br>9 (peak)<br>(Up to 1 sec duration) | A    |
| $T_A$     | Operating free-air temperature range     | -40 |     | 85                                                         | °C   |

- (1) The inherent switching noise voltage spikes should not exceed the absolute maximum rating on either the BTST or SW pins. A tight layout minimizes switching noise.

## 7.4 Thermal Information

| THERMAL METRIC <sup>(1)</sup> |                                              | BQ25895    |      |
|-------------------------------|----------------------------------------------|------------|------|
|                               |                                              | RTW (WQFN) |      |
|                               |                                              | 24-PINS    |      |
|                               |                                              |            | UNIT |
| R <sub>θJA</sub>              | Junction-to-ambient thermal resistance       | 31.8       | °C/W |
| R <sub>θJC(top)</sub>         | Junction-to-case (top) thermal resistance    | 27.9       | °C/W |
| R <sub>θJB</sub>              | Junction-to-board thermal resistance         | 8.7        | °C/W |
| ψ <sub>JT</sub>               | Junction-to-top characterization parameter   | 0.3        | °C/W |
| ψ <sub>JB</sub>               | Junction-to-board characterization parameter | 8.7        | °C/W |
| R <sub>θJC(bot)</sub>         | Junction-to-case (bottom) thermal resistance | 2.0        | °C/W |

(1) For more information about traditional and new thermal metrics, see the [Semiconductor and IC Package Thermal Metrics](#) application report.

## 7.5 Electrical Characteristics

$V_{VBUS\_UVLOZ} < V_{VBUS} < V_{ACOV}$  and  $V_{VBUS} > V_{BAT} + V_{SLEEP}$ ,  $T_J = -40^{\circ}\text{C}$  to  $+125^{\circ}\text{C}$  and  $T_J = 25^{\circ}\text{C}$  for typical values (unless otherwise noted)

| PARAMETER                    | TEST CONDITIONS                                                      | MIN                                                                                                                                                  | TYP  | MAX                            | UNIT |    |
|------------------------------|----------------------------------------------------------------------|------------------------------------------------------------------------------------------------------------------------------------------------------|------|--------------------------------|------|----|
| <b>QUIESCENT CURRENTS</b>    |                                                                      |                                                                                                                                                      |      |                                |      |    |
| I <sub>BAT</sub>             | Battery discharge current (BAT, SW, SYS) in buck mode                | V <sub>BAT</sub> = 4.2 V, V <sub>(VBUS)</sub> < V <sub>(UVLO)</sub> , leakage between BAT and VBUS                                                   |      | 5                              | μA   |    |
|                              |                                                                      | High-Z mode, no VBUS, BATFET disabled (REG09[5]=1), battery monitor disabled, T <sub>J</sub> < 85°C                                                  | 12   | 23                             | μA   |    |
|                              |                                                                      | High-Z mode, no VBUS, BATFET enabled (REG09[5]=0), battery monitor disabled, T <sub>J</sub> < 85°C                                                   | 32   | 60                             | μA   |    |
| I <sub>(VBUS_HIZ)</sub>      | Input supply current (VBUS) in buck mode when High-Z mode is enabled | V <sub>(VBUS)</sub> = 5 V, High-Z mode, no battery, battery monitor disabled                                                                         | 15   | 35                             | μA   |    |
|                              |                                                                      | V <sub>(VBUS)</sub> = 12 V, High-Z mode, no battery, battery monitor disabled                                                                        | 25   | 50                             | μA   |    |
| I <sub>(VBUS)</sub>          | Input supply current (VBUS) in buck mode                             | V <sub>BUS</sub> > V <sub>(UVLO)</sub> , V <sub>BUS</sub> > V <sub>BAT</sub> , converter not switching                                               | 1.5  | 3                              | mA   |    |
|                              |                                                                      | V <sub>BUS</sub> > V <sub>(UVLO)</sub> , V <sub>BUS</sub> > V <sub>BAT</sub> , converter switching, V <sub>BAT</sub> = 3.2 V, I <sub>SYS</sub> = 0 A | 3    |                                | mA   |    |
|                              |                                                                      | V <sub>BUS</sub> > V <sub>(UVLO)</sub> , V <sub>BUS</sub> > V <sub>BAT</sub> , converter switching, V <sub>BAT</sub> = 3.8 V, I <sub>SYS</sub> = 0 A | 3    |                                | mA   |    |
| I <sub>(BOOST)</sub>         | Battery discharge current in boost mode                              | V <sub>BAT</sub> = 4.2 V, boost mode, I <sub>(VBUS)</sub> = 0 A, converter switching                                                                 | 5    |                                | mA   |    |
| <b>VBUS/BAT POWER UP</b>     |                                                                      |                                                                                                                                                      |      |                                |      |    |
| V <sub>(VBUS_OP)</sub>       | VBUS operating range                                                 |                                                                                                                                                      | 3.9  | 14                             | V    |    |
| V <sub>(VBUS_UVLOZ)</sub>    | VBUS for active I <sup>2</sup> C, no battery                         |                                                                                                                                                      | 3.6  |                                | V    |    |
| V <sub>(SLEEP)</sub>         | Sleep mode falling threshold                                         |                                                                                                                                                      | 25   | 65                             | 120  | mV |
| V <sub>(SLEEPZ)</sub>        | Sleep mode rising threshold                                          |                                                                                                                                                      | 130  | 250                            | 370  | mV |
| V <sub>(ACOV)</sub>          | VBUS over-voltage rising threshold                                   |                                                                                                                                                      | 14   | 14.6                           |      | V  |
|                              |                                                                      | VBUS over-voltage falling threshold                                                                                                                  | 13.5 | 14                             |      | V  |
| V <sub>BAT(UVLOZ)</sub>      | Battery for active I <sup>2</sup> C, no VBUS                         |                                                                                                                                                      | 2.3  |                                | V    |    |
| V <sub>BAT(DPL)</sub>        | Battery depletion falling threshold                                  |                                                                                                                                                      | 2.15 | 2.5                            | V    |    |
| V <sub>BAT(DPLZ)</sub>       | Battery depletion rising threshold                                   |                                                                                                                                                      | 2.35 | 2.7                            | V    |    |
| V <sub>(VBUSMIN)</sub>       | Bad adapter detection threshold                                      |                                                                                                                                                      | 3.8  |                                | V    |    |
| I <sub>(BADSRC)</sub>        | Bad adapter detection current source                                 |                                                                                                                                                      | 30   |                                | mA   |    |
| <b>POWER-PATH MANAGEMENT</b> |                                                                      |                                                                                                                                                      |      |                                |      |    |
| V <sub>SYS</sub>             | Typical system regulation voltage                                    | I <sub>SYS</sub> = 0 A, V <sub>BAT</sub> > V <sub>SYS(MIN)</sub> , BATFET Disabled (REG09[5]=1)                                                      |      | V <sub>BAT</sub> + 50 mV       |      | V  |
|                              |                                                                      | I <sub>SYS</sub> = 0 A, V <sub>BAT</sub> < V <sub>SYS(MIN)</sub> , BATFET Disabled (REG09[5]=1)                                                      |      | V <sub>SYS(MIN)</sub> + 150 mV |      | V  |
| V <sub>SYS(MIN)</sub>        | Minimum DC system voltage output                                     | V <sub>BAT</sub> < V <sub>SYS(MIN)</sub> , SYS_MIN = 3.5 V (REG03[3:1]=101), I <sub>SYS</sub> = 0 A                                                  | 3.50 | 3.65                           |      | V  |
| V <sub>SYS(MAX)</sub>        | Maximum DC system voltage output                                     | V <sub>BAT</sub> = 4.35 V, SYS_MIN = 3.5V (REG03[3:1]=101), I <sub>SYS</sub> = 0 A                                                                   | 4.40 | 4.42                           |      | V  |

## 7.5 Electrical Characteristics (continued)

$V_{VBUS\_UVLOZ} < V_{VBUS} < V_{ACOV}$  and  $V_{VBUS} > V_{BAT} + V_{SLEEP}$ ,  $T_J = -40^{\circ}\text{C}$  to  $+125^{\circ}\text{C}$  and  $T_J = 25^{\circ}\text{C}$  for typical values (unless otherwise noted)

| PARAMETER                                 |                                                                                            | TEST CONDITIONS                                                                                                                     | MIN   | TYP  | MAX   | UNIT |
|-------------------------------------------|--------------------------------------------------------------------------------------------|-------------------------------------------------------------------------------------------------------------------------------------|-------|------|-------|------|
| R <sub>ON</sub> (RBFET)                   | Top reverse blocking MOSFET (RBFET) on-resistance between VBUS and PMID                    | T <sub>J</sub> = -40°C to +85°C                                                                                                     |       | 27   | 38    | mΩ   |
|                                           |                                                                                            | T <sub>J</sub> = -40°C to +125°C                                                                                                    |       | 27   | 44    | mΩ   |
| R <sub>ON</sub> (HSFET)                   | Top switching MOSFET (HSFET) on-resistance between PMID and SW                             | T <sub>J</sub> = -40°C to +85°C                                                                                                     |       | 27   | 39    | mΩ   |
|                                           |                                                                                            | T <sub>J</sub> = -40°C to +125°C                                                                                                    |       | 27   | 47    | mΩ   |
| R <sub>ON</sub> (LSFET)                   | Bottom switching MOSFET (LSFET) on-resistance between SW and GND                           | T <sub>J</sub> = -40°C to +85°C                                                                                                     |       | 16   | 24    | mΩ   |
|                                           |                                                                                            | T <sub>J</sub> = -40°C to +125°C                                                                                                    |       | 16   | 28    | mΩ   |
| V <sub>(FWD)</sub>                        | BATFET forward voltage in supplement mode                                                  | BAT discharge current 10 mA                                                                                                         |       | 30   |       | mV   |
| V <sub>BAT(GD)</sub>                      | Battery good comparator rising threshold                                                   | V <sub>BAT</sub> rising                                                                                                             | 3.4   | 3.55 | 3.7   | V    |
| V <sub>BAT(GD_HYST)</sub>                 | Battery good comparator falling threshold                                                  | V <sub>BAT</sub> falling                                                                                                            |       | 100  |       | mV   |
| <b>BATTERY CHARGER</b>                    |                                                                                            |                                                                                                                                     |       |      |       |      |
| V <sub>BAT(REG_RANGE)</sub>               | Typical charge voltage range                                                               |                                                                                                                                     | 3.840 |      | 4.608 | V    |
| V <sub>BAT(REG_STEP)</sub>                | Typical charge voltage step                                                                |                                                                                                                                     |       | 16   |       | mV   |
| V <sub>BAT(REG)</sub>                     | Charge voltage resolution accuracy                                                         | V <sub>BAT</sub> = 4.208 V (REG06[7:2]=010111) or V <sub>BAT</sub> = 4.352 V (REG06[7:2]=100000)<br>T <sub>J</sub> = -40°C to +85°C | -0.5% |      | 0.5%  |      |
| I <sub>(CHG_REG_RANGE)</sub>              | Typical fast charge current regulation range                                               |                                                                                                                                     | 0     |      | 5056  | mA   |
| I <sub>(CHG_REG_STEP)</sub>               | Typical fast charge current regulation step                                                |                                                                                                                                     |       | 64   |       | mA   |
| I <sub>(CHG_REG_ACC)</sub>                | Fast charge current regulation accuracy                                                    | V <sub>BAT</sub> = 3.1 V or 3.8 V, I <sub>CHG</sub> = 128 mA<br>T <sub>J</sub> = -40°C to +85°C                                     | -20%  |      | 20%   |      |
|                                           |                                                                                            | V <sub>BAT</sub> = 3.1 V or 3.8 V, I <sub>CHG</sub> = 256 mA<br>T <sub>J</sub> = -40°C to +85°C                                     | -10%  |      | 10%   |      |
|                                           |                                                                                            | V <sub>BAT</sub> = 3.1 V or 3.8 V, I <sub>CHG</sub> = 1792 mA<br>T <sub>J</sub> = -40°C to +85°C                                    | -5%   |      | 5%    |      |
| V <sub>BAT(LOWV)</sub>                    | Battery LOWV falling threshold                                                             | Fast charge to precharge, BATLOWV (REG06[1]) = 1                                                                                    | 2.6   | 2.8  | 2.9   | V    |
|                                           | Battery LOWV rising threshold                                                              | Precharge to fast charge, BATLOWV (REG06[1])=1<br>(Typical 200-mV hysteresis)                                                       | 2.8   | 3    | 3.1   | V    |
| I <sub>(PRECHG_RANGE)</sub>               | Precharge current range                                                                    |                                                                                                                                     | 64    |      | 1024  | mA   |
| I <sub>(PRECHG_STEP)</sub>                | Typical precharge current step                                                             |                                                                                                                                     |       | 64   |       | mA   |
| I <sub>(PRECHG_ACC)</sub>                 | Precharge current accuracy                                                                 | V <sub>BAT</sub> =2.6 V, I <sub>PRECHG</sub> = 256 mA                                                                               | -10%  |      | +10%  |      |
| I <sub>(TERM_RANGE)</sub>                 | Termination current range                                                                  |                                                                                                                                     | 64    |      | 1024  | mA   |
| I <sub>(TERM_STEP)</sub>                  | Typical termination current step                                                           |                                                                                                                                     |       | 64   |       | mA   |
| I <sub>(TERM_ACC)</sub>                   | Termination current accuracy                                                               | I <sub>TERM</sub> = 256 mA, I <sub>CHG</sub> ≤ 1344 mA<br>T <sub>J</sub> = -20°C to +85°C                                           | -12%  |      | 12%   |      |
|                                           |                                                                                            | I <sub>TERM</sub> = 256 mA, I <sub>CHG</sub> > 1344 mA<br>T <sub>J</sub> = -20°C to +85°C                                           | -20%  |      | 20%   |      |
| V <sub>(SHORT)</sub>                      | Battery short voltage                                                                      | VBAT falling                                                                                                                        |       | 2    |       | V    |
| V <sub>(SHORT_HYST)</sub>                 | Battery short voltage hysteresis                                                           | VBAT rising                                                                                                                         |       | 200  |       | mV   |
| I <sub>(SHORT)</sub>                      | Battery short current                                                                      | VBAT < 2.2 V                                                                                                                        |       | 100  |       | mA   |
| V <sub>(RECHG)</sub>                      | Recharge threshold below V <sub>BATREG</sub>                                               | V <sub>BAT</sub> falling, V <sub>RECHG</sub> (REG06[0]=0) = 0                                                                       |       | 100  |       | mV   |
|                                           |                                                                                            | V <sub>BAT</sub> falling, V <sub>RECHG</sub> (REG06[0]=0) = 1                                                                       |       | 200  |       | mV   |
| I <sub>BAT(LOAD)</sub>                    | Battery discharge load current                                                             | V <sub>BAT</sub> = 4.2 V                                                                                                            | 15    |      |       | mA   |
| I <sub>SYS(LOAD)</sub>                    | System discharge load current                                                              | V <sub>SYS</sub> = 4.2 V                                                                                                            | 30    |      |       | mA   |
| R <sub>ON</sub> (BATFET)                  | SYS-BAT MOSFET (BATFET) on-resistance                                                      | T <sub>J</sub> = 25°C                                                                                                               |       | 11   | 13    | mΩ   |
|                                           |                                                                                            | T <sub>J</sub> = -40°C to +125°C                                                                                                    |       | 11   | 19    | mΩ   |
| <b>INPUT VOLTAGE / CURRENT REGULATION</b> |                                                                                            |                                                                                                                                     |       |      |       |      |
| V <sub>IN(DPM_RANGE)</sub>                | Typical Input voltage regulation range                                                     |                                                                                                                                     | 3.9   |      | 15.3  | V    |
| V <sub>IN(DPM_STEP)</sub>                 | Typical Input voltage regulation step                                                      |                                                                                                                                     |       | 100  |       | mV   |
| V <sub>IN(DPM_ACC)</sub>                  | Input voltage regulation accuracy                                                          | V <sub>INDPM</sub> = 4.4 V, 9 V                                                                                                     | 3%    |      | 3%    |      |
| I <sub>IN(DPM_RANGE)</sub>                | Typical Input current regulation range                                                     |                                                                                                                                     | 100   |      | 3250  | mA   |
| I <sub>IN(DPM_STEP)</sub>                 | Typical Input current regulation step                                                      |                                                                                                                                     |       | 50   |       | mA   |
| I <sub>IN(DPM100_ACC)</sub>               | Input current 100-mA regulation accuracy<br>V <sub>BAT</sub> = 5 V, current pulled from SW | I <sub>INLIM</sub> (REG00[5:0]) = 100 mA                                                                                            | 85    | 90   | 100   | mA   |



## 7.5 Electrical Characteristics (continued)

$V_{VBUS\_UVLOZ} < V_{VBUS} < V_{ACOV}$  and  $V_{VBUS} > V_{BAT} + V_{SLEEP}$ ,  $T_J = -40^{\circ}\text{C}$  to  $+125^{\circ}\text{C}$  and  $T_J = 25^{\circ}\text{C}$  for typical values (unless otherwise noted)

| PARAMETER                                          |                                                                                      | TEST CONDITIONS                                                                           | MIN    | TYP    | MAX    | UNIT               |
|----------------------------------------------------|--------------------------------------------------------------------------------------|-------------------------------------------------------------------------------------------|--------|--------|--------|--------------------|
| $I_{IN(DPM\_ACC)}$                                 | Input current regulation accuracy<br>$V_{BAT} = 5\text{ V}$ , current pulled from SW | USB150, IINLIM (REG00[5:0]) = 150 mA                                                      | 125    | 135    | 150    | mA                 |
|                                                    |                                                                                      | USB500, IINLIM (REG00[5:0]) = 500 mA                                                      | 440    | 470    | 500    | mA                 |
|                                                    |                                                                                      | USB900, IINLIM (REG00[5:0]) = 900 mA                                                      | 750    | 825    | 900    | mA                 |
|                                                    |                                                                                      | Adapter 1.5 A, IINLIM (REG00[5:0]) = 1500 mA                                              | 1300   | 1400   | 1500   | mA                 |
| $I_{IN(START)}$                                    | Input current regulation during system start up                                      | $V_{SYS} = 2.2\text{ V}$ , IINLIM (REG00[5:0]) > = 200 mA                                 |        |        | 200    | mA                 |
| $K_{ILIM}$                                         | $I_{INMAX} = K_{ILIM}/R_{ILIM}$                                                      | Input current regulation by ILIM pin = 1.5 A                                              | 320    | 355    | 390    | A x $\Omega$       |
| <b>D+/D- DETECTION</b>                             |                                                                                      |                                                                                           |        |        |        |                    |
| $V_{(OP6\_VSR)}$                                   | D+/D- voltage source (0.6 V)                                                         |                                                                                           | 0.5    | 0.6    | 0.7    | V                  |
| $V_{(3p45\_VSR)}$                                  | D+/D- voltage source (3.45 V)                                                        |                                                                                           | 3.3    | 3.45   | 3.6    | V                  |
| $I_{(10UA\_ISRC)}$                                 | D+ connection check current source                                                   |                                                                                           | 7      | 10     | 14     | $\mu\text{A}$      |
| $I_{(100UA\_ISINK)}$                               | D+/D- current sink (100 $\mu\text{A}$ )                                              |                                                                                           | 50     | 100    | 150    | $\mu\text{A}$      |
| $I_{(DPDM\_LKG)}$                                  | D+/D- Leakage current                                                                | D-, switch open                                                                           | -1     |        | 1      | $\mu\text{A}$      |
|                                                    |                                                                                      | D+, switch open                                                                           | -1     |        | 1      | $\mu\text{A}$      |
| $I_{(1P6MA\_ISINK)}$                               | D+/D- current sink (1.6 mA)                                                          |                                                                                           | 1.45   | 1.60   | 1.75   | $\mu\text{A}$      |
| $V_{(OP4\_VTH)}$                                   | D+/D- low comparator threshold                                                       |                                                                                           | 250    |        | 400    | mV                 |
| $V_{(OP8\_VTH)}$                                   | D+ low comparator threshold                                                          |                                                                                           |        |        | 0.8    | V                  |
| $V_{(2P7\_VTH)}$                                   | D+/D- comparator threshold for non-standard adapter detection (divider 1, 3, or 4)   |                                                                                           | 2.55   |        | 2.85   | V                  |
| $V_{(2P0\_VTH)}$                                   | D+/D- comparator threshold for non-standard adapter detection (divider 1, 3)         |                                                                                           | 1.85   |        | 2.15   | V                  |
| $V_{(1P2\_VTH)}$                                   | D+/D- comparator threshold for non-standard adapter detection (divider 2)            |                                                                                           | 1.05   |        | 1.35   | V                  |
| $R_{(D\_DWN)}$                                     | D- pull-down for connection check                                                    |                                                                                           | 14.25  |        | 24.8   | k $\Omega$         |
| <b>BAT OVERVOLTAGE/CURRENT PROTECTION</b>          |                                                                                      |                                                                                           |        |        |        |                    |
| $V_{BAT(OVP)}$                                     | Battery over-voltage threshold                                                       | $V_{BAT}$ rising, as percentage of $V_{BAT(REG)}$                                         |        | 104%   |        |                    |
| $V_{BAT(OVP\_HYST)}$                               | Battery over-voltage hysteresis                                                      | $V_{BAT}$ falling, as percentage of $V_{BAT(REG)}$                                        |        | 2%     |        |                    |
| $I_{BAT(FET\_OCP)}$                                | System over-current threshold                                                        |                                                                                           | 9      |        |        | A                  |
| <b>THERMAL REGULATION AND THERMAL SHUTDOWN</b>     |                                                                                      |                                                                                           |        |        |        |                    |
| $T_{REG}$                                          | Junction temperature regulation accuracy                                             | REG08[1:0] = 11                                                                           |        | 120    |        | $^{\circ}\text{C}$ |
| $T_{SHUT}$                                         | Thermal shutdown rising temperature                                                  | Temperature rising                                                                        |        | 160    |        | $^{\circ}\text{C}$ |
| $T_{SHUT(HYS)}$                                    | Thermal shutdown hysteresis                                                          | Temperature falling                                                                       |        | 30     |        | $^{\circ}\text{C}$ |
| $V_{(LTF)}$                                        | Cold temperature threshold, TS pin voltage rising threshold                          | As percentage to $V_{(REGN)}$                                                             | 72.75% | 73.25% | 73.75% |                    |
| $V_{(LTF\_HYS)}$                                   | Cold temperature hysteresis, TS pin voltage falling                                  | As percentage to $V_{(REGN)}$                                                             |        | 0.4%   |        |                    |
| $V_{(HTF)}$                                        | Hot temperature TS pin voltage rising threshold                                      | As percentage to $V_{(REGN)}$                                                             | 47.75% | 48.25% | 48.75% |                    |
| $V_{(TCO)}$                                        | Cut-off temperature TS pin voltage falling threshold                                 | As percentage to $V_{(REGN)}$                                                             | 44.25% | 44.75% | 45.25% |                    |
| <b>COLD/HOT THERMISTOR COMPARATOR (BOOST MODE)</b> |                                                                                      |                                                                                           |        |        |        |                    |
| $V_{(BCOLD1)}$                                     | Cold temperature threshold 1, TS pin voltage rising threshold                        | As percentage to $V_{(REGN)}$ REG01[5] = 1 (Approximately $-20^{\circ}\text{C}$ w/ 103AT) | 79.5%  | 80%    | 80.5%  |                    |
| $V_{(BCOLD1\_HYS)}$                                | Cold temperature threshold 1, TS pin voltage falling threshold                       | As percentage to $V_{(REGN)}$ REG01[5] = 1                                                |        | 1%     |        |                    |
| $V_{(BHOT2)}$                                      | Hot temperature threshold 2, TS pin voltage falling threshold                        | As percentage to $V_{(REGN)}$ REG01[7:6] = 10 (Approx. $65^{\circ}\text{C}$ w/ 103AT)     | 30.75% | 31.25% | 31.75% |                    |
| $V_{(BHOT2\_HYS)}$                                 | Hot temperature threshold 2, TS pin voltage rising threshold                         | As percentage to $V_{(REGN)}$ REG01[7:6] = 10                                             |        | 3%     |        |                    |
| <b>PWM</b>                                         |                                                                                      |                                                                                           |        |        |        |                    |
| $F_{SW}$                                           | PWM switching frequency, and digital clock                                           | Oscillator frequency                                                                      | 1.32   |        | 1.68   | MHz                |
| $D_{MAX}$                                          | Maximum PWM duty cycle                                                               |                                                                                           |        | 97%    |        |                    |
| <b>BOOST MODE OPERATION</b>                        |                                                                                      |                                                                                           |        |        |        |                    |
| $V_{(OTG\_REG\_RANGE)}$                            | Typical boost mode regulation voltage range                                          |                                                                                           | 4.55   |        | 5.55   | V                  |
| $V_{(OTG\_REG\_STEP)}$                             | Typical boost mode regulation voltage step                                           |                                                                                           |        | 64     |        | mV                 |
| $V_{(OTG\_REG\_ACC)}$                              | Boost mode regulation voltage accuracy                                               | $I_{(PMID)} = 0\text{ A}$ , BOOSTV=5.126V (REG0A[7:4] = 1001)                             | -3%    |        | 3%     |                    |
| $V_{(OTG\_BAT)}$                                   | Battery voltage exiting boost mode                                                   | BAT falling                                                                               | 2.6    |        | 2.9    | V                  |
| $I_{(OTG)}$                                        | Boost mode output current range                                                      |                                                                                           | 3.1    |        |        | A                  |
| $V_{(OTG\_OVP)}$                                   | Boost mode over-voltage threshold                                                    | Rising threshold                                                                          | 5.8    | 6      |        | V                  |
| <b>REGN LDO</b>                                    |                                                                                      |                                                                                           |        |        |        |                    |

## 7.5 Electrical Characteristics (continued)

$V_{VBUS\_UVLOZ} < V_{VBUS} < V_{ACOV}$  and  $V_{VBUS} > V_{BAT} + V_{SLEEP}$ ,  $T_J = -40^{\circ}\text{C}$  to  $+125^{\circ}\text{C}$  and  $T_J = 25^{\circ}\text{C}$  for typical values (unless otherwise noted)

| PARAMETER                                                                                 |                                           | TEST CONDITIONS                                                     | MIN            | TYP   | MAX   | UNIT          |
|-------------------------------------------------------------------------------------------|-------------------------------------------|---------------------------------------------------------------------|----------------|-------|-------|---------------|
| $V_{(REGN)}$                                                                              | REGN LDO output voltage                   | $V_{(VBUS)} = 9\text{ V}$ , $I_{(REGN)} = 40\text{ mA}$             | 5.6            | 6     | 6.4   | V             |
|                                                                                           |                                           | $V_{(VBUS)} = 5\text{ V}$ , $I_{(REGN)} = 20\text{ mA}$             | 4.7            | 4.8   |       | V             |
| $I_{(REGN)}$                                                                              | REGN LDO current limit                    | $V_{(VBUS)} = 9\text{ V}$ , $V_{(REGN)} = 3.8\text{ V}$             | 50             |       |       | mA            |
| <b>ANALOG-TO-DIGITAL CONVERTER (ADC)</b>                                                  |                                           |                                                                     |                |       |       |               |
| RES                                                                                       | Resolution                                | Rising threshold                                                    |                | 7     |       | bits          |
| $V_{BAT(RANGE)}$                                                                          | Typical battery voltage range             | $V_{(VBUS)} > V_{BAT} + V_{(SLEEP)}$ or OTG mode is enabled         | 2.304          |       | 4.848 | V             |
|                                                                                           |                                           | $V_{(VBUS)} < V_{BAT} + V_{(SLEEP)}$ and OTG mode is disabled       | $V_{SYS\_MIN}$ |       | 4.848 | V             |
| $V_{(BAT\_RES)}$                                                                          | Typical battery voltage resolution        |                                                                     |                | 20    |       | mV            |
| $V_{(SYS\_RANGE)}$                                                                        | Typical system voltage range              | $V_{(VBUS)} > V_{BAT} + V_{(SLEEP)}$ or OTG mode is enabled         | 2.304          |       | 4.848 | V             |
|                                                                                           |                                           | $V_{(VBUS)} < V_{BAT} + V_{(SLEEP)}$ and OTG mode is disabled       | $V_{SYS\_MIN}$ |       | 4.848 | V             |
| $V_{(SYS\_RES)}$                                                                          | Typical system voltage resolution         |                                                                     |                | 20    |       | mV            |
| $V_{(VBUS\_RANGE)}$                                                                       | Typical $V_{VBUS}$ voltage range          | $V_{(VBUS)} > V_{BAT} + V_{(SLEEP)}$ or OTG mode is enabled         | 2.6            |       | 15.3  | V             |
| $V_{(VBUS\_RES)}$                                                                         | Typical $V_{VBUS}$ voltage resolution     |                                                                     |                | 100   |       | mV            |
| $I_{BAT(RANGE)}$                                                                          | Typical battery charge current range      | $V_{(VBUS)} > V_{BAT} + V_{(SLEEP)}$ and $V_{BAT} > V_{BAT(SHORT)}$ | 0              |       | 6.4   | A             |
| $I_{BAT(RES)}$                                                                            | Typical battery charge current resolution |                                                                     |                | 50    |       | mA            |
| $V_{(TS\_RANGE)}$                                                                         | Typical TS voltage range                  |                                                                     | 21%            |       | 80%   |               |
| $V_{(TS\_RES)}$                                                                           | Typical TS voltage resolution             |                                                                     |                | 0.47% |       |               |
| <b>LOGIC I/O PIN (OTG, <math>\overline{CE}</math>, PSEL, <math>\overline{QON}</math>)</b> |                                           |                                                                     |                |       |       |               |
| $V_{IH}$                                                                                  | Input high threshold level                |                                                                     | 1.3            |       |       |               |
| $V_{IL}$                                                                                  | Input low threshold level                 |                                                                     |                |       | 0.4   | V             |
| $I_{IN(BIAS)}$                                                                            | High Level Leakage Current                | Pull-up rail 1.8 V                                                  |                |       | 1     | $\mu\text{A}$ |
| $V_{(QON)}$                                                                               | Internal /QON pull-up                     | Battery only mode                                                   |                | BAT   |       | V             |
|                                                                                           |                                           | $V_{(VBUS)} = 9\text{ V}$                                           |                | 5.8   |       | V             |
|                                                                                           |                                           | $V_{(VBUS)} = 5\text{ V}$                                           |                | 4.3   |       | V             |
| $R_{(QON)}$                                                                               | Internal /QON pull-up resistance          |                                                                     |                | 200   |       | k $\Omega$    |
| <b>LOGIC I/O PIN (INT, STAT, <math>\overline{PG}</math>, DSEL)</b>                        |                                           |                                                                     |                |       |       |               |
| $V_{OL}$                                                                                  | Output low threshold level                | Sink current = 5 mA, sink current                                   |                |       | 0.4   | V             |
| $I_{OUT\_BIAS}$                                                                           | High level leakage current                | Pull-up rail 1.8 V                                                  |                |       | 1     | $\mu\text{A}$ |
| <b>I<sup>2</sup>C INTERFACE (SCL, SDA)</b>                                                |                                           |                                                                     |                |       |       |               |
| $V_{IH}$                                                                                  | Input high threshold level, SCL and SDA   | Pull-up rail 1.8 V                                                  | 1.3            |       |       |               |
| $V_{IL}$                                                                                  | Input low threshold level                 | Pull-up rail 1.8 V                                                  |                |       | 0.4   | V             |
| $V_{OL}$                                                                                  | Output low threshold level                | Sink current = 5 mA, sink current                                   |                |       | 0.4   | V             |
| $I_{BIAS}$                                                                                | High level leakage current                | Pull-up rail 1.8 V                                                  |                |       | 1     | $\mu\text{A}$ |

## 7.6 Timing Requirements

|                                         |                                                      |                                             | MIN  | NOM  | MAX  | UNIT |
|-----------------------------------------|------------------------------------------------------|---------------------------------------------|------|------|------|------|
| <b>VBUS/BAT POWER UP</b>                |                                                      |                                             |      |      |      |      |
| t <sub>BADSRC</sub>                     | Bad Adapter detection duration                       |                                             | 30   |      |      | msec |
| <b>D+/D- DETECTION</b>                  |                                                      |                                             |      |      |      |      |
| t <sub>SDP_DEFAULT</sub>                | Charging timer with USB100 in default mode           |                                             | 2    |      |      | mins |
| <b>BAT OVER-VOLTAGE PROTECTION</b>      |                                                      |                                             |      |      |      |      |
| t <sub>BATOV</sub>                      | Battery over-voltage deglitch time to disable charge |                                             | 1    |      |      | µs   |
| <b>BATTERY CHARGER</b>                  |                                                      |                                             |      |      |      |      |
| t <sub>RECHG</sub>                      | Recharge deglitch time                               |                                             | 20   |      |      | ms   |
| <b>CURRENT PULSE CONTROL</b>            |                                                      |                                             |      |      |      |      |
| t <sub>PUMPX_STOP</sub>                 | Current pulse control stop pulse                     |                                             | 430  |      | 570  | ms   |
| t <sub>PUMPX_ON1</sub>                  | Current pulse control long on pulse                  |                                             | 240  |      | 360  | ms   |
| t <sub>PUMPX_ON2</sub>                  | Current pulse control short on pulse                 |                                             | 70   |      | 130  | ms   |
| t <sub>PUMPX_OFF</sub>                  | Current pulse control off pulse                      |                                             | 70   |      | 130  | ms   |
| t <sub>PUMPX_DLY</sub>                  | Current pulse control stop start delay               |                                             | 80   |      | 225  | ms   |
| <b>BATTERY MONITOR</b>                  |                                                      |                                             |      |      |      |      |
| t <sub>CONV</sub>                       | Conversion time                                      | CONV_RATE(REG02[6]) = 0                     | 8    | 1000 |      | ms   |
| <b>QON AND SHIPMODE TIMING</b>          |                                                      |                                             |      |      |      |      |
| t <sub>SHIPMODE</sub>                   | QON low time to turn on BATFET and exit ship mode    | T <sub>J</sub> = -10°C to +60°C             | 1.25 |      | 2.25 | s    |
| t <sub>QON_RST</sub>                    | QON low time to enable full system reset             | T <sub>J</sub> = -10°C to +60°C             | 12   |      | 18   | s    |
| t <sub>BATFET_RST</sub>                 | BATFET off time during full system reset             | T <sub>J</sub> = -10°C to +60°C             | 350  |      | 550  | ms   |
| t <sub>SM_DLY</sub>                     | Enter ship mode delay                                | T <sub>J</sub> = -10°C to +60°C             | 10   |      | 15   | s    |
| <b>I2C INTERFACE</b>                    |                                                      |                                             |      |      |      |      |
| f <sub>SCL</sub>                        | SCL clock frequency                                  |                                             | 400  |      |      | kHz  |
| <b>DIGITAL CLOCK and WATCHDOG TIMER</b> |                                                      |                                             |      |      |      |      |
| f <sub>LPDIG</sub>                      | Digital low power clock                              | REGN LDO disabled                           | 18   | 30   | 45   | kHz  |
| f <sub>DIG</sub>                        | Digital clock                                        | REGN LDO enabled                            | 1320 | 1500 | 1680 | kHz  |
| t <sub>WDT</sub>                        | Watchdog reset time                                  | WATCHDOG (REG07[5:4])=11, REGN LDO disabled | 100  | 160  |      | s    |
|                                         |                                                      | WATCHDOG (REG07[5:4])=11, REGN LDO enabled  | 136  | 160  |      | s    |

## 7.7 Typical Characteristics

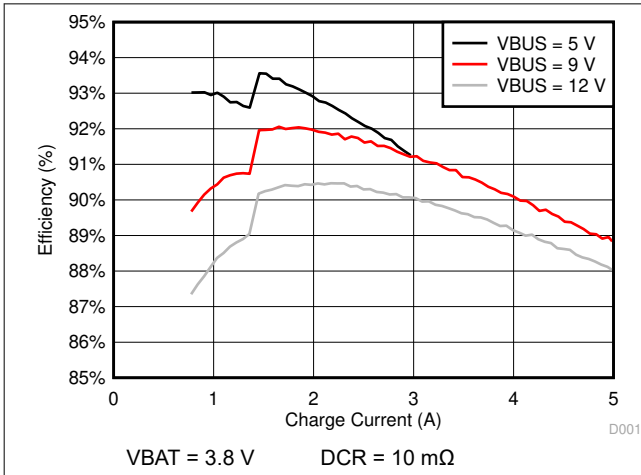

Figure 7-1. Charge Efficiency vs Charge Current

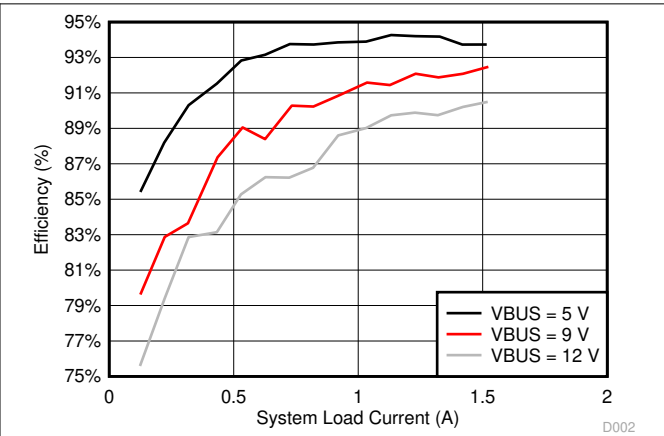

Figure 7-2. System Light Load Efficiency vs System Light Load Current

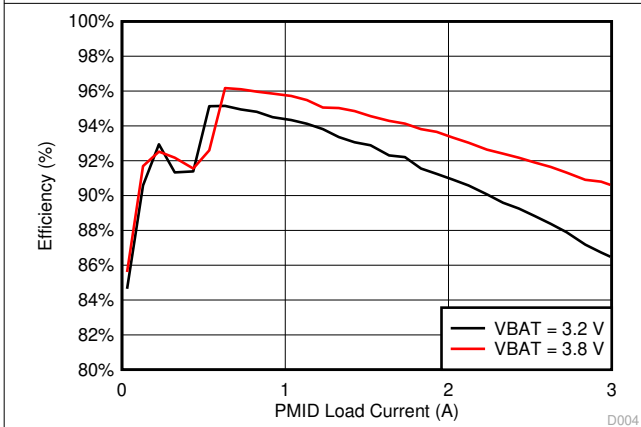

Figure 7-3. Boost Mode Efficiency vs PMID Load Current

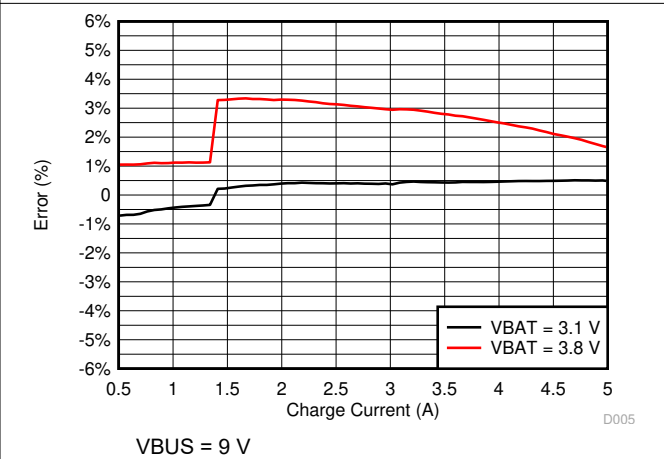

Figure 7-4. Charge Current Accuracy vs Charge Current I<sup>2</sup>C Setting

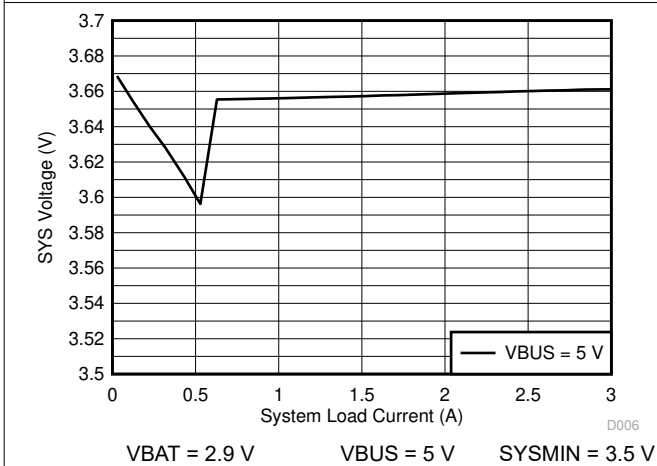

Figure 7-5. SYS Voltage Regulation vs System Load Current

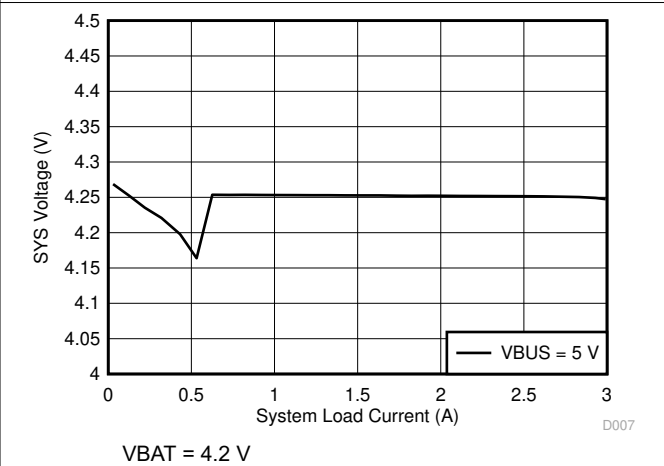
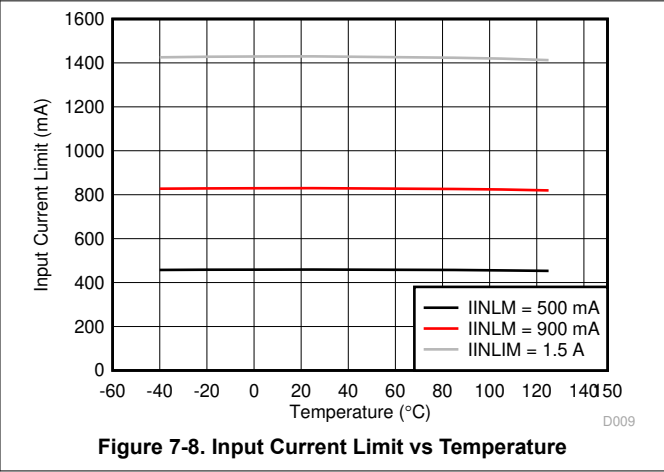
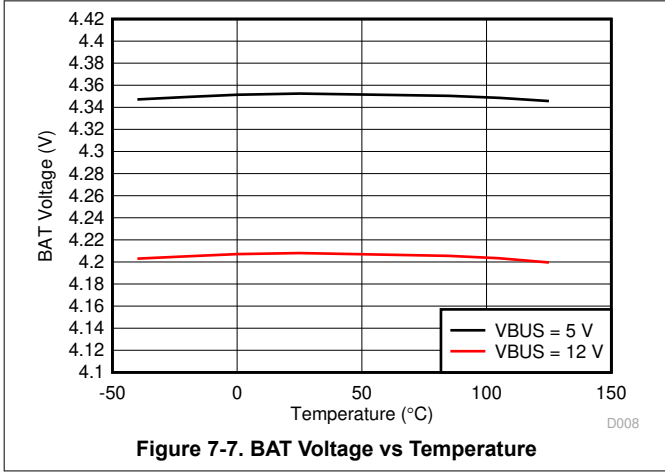

Figure 7-6. SYS Voltage Regulation vs System Load Current

**7.7 Typical Characteristics (continued)**



## 8 Detailed Description

The device is a highly integrated 5-A switch-mode battery charger for single cell Li-Ion and Li-polymer battery. It is highly integrated with the input reverse-blocking FET (RBFET, Q1), high-side switching FET (HSFET, Q2), low-side switching FET (LSFET, Q3), and battery FET (BATFET, Q4). The device also integrates the bootstrap diode for the high-side gate drive.

### 8.1 Functional Block Diagram

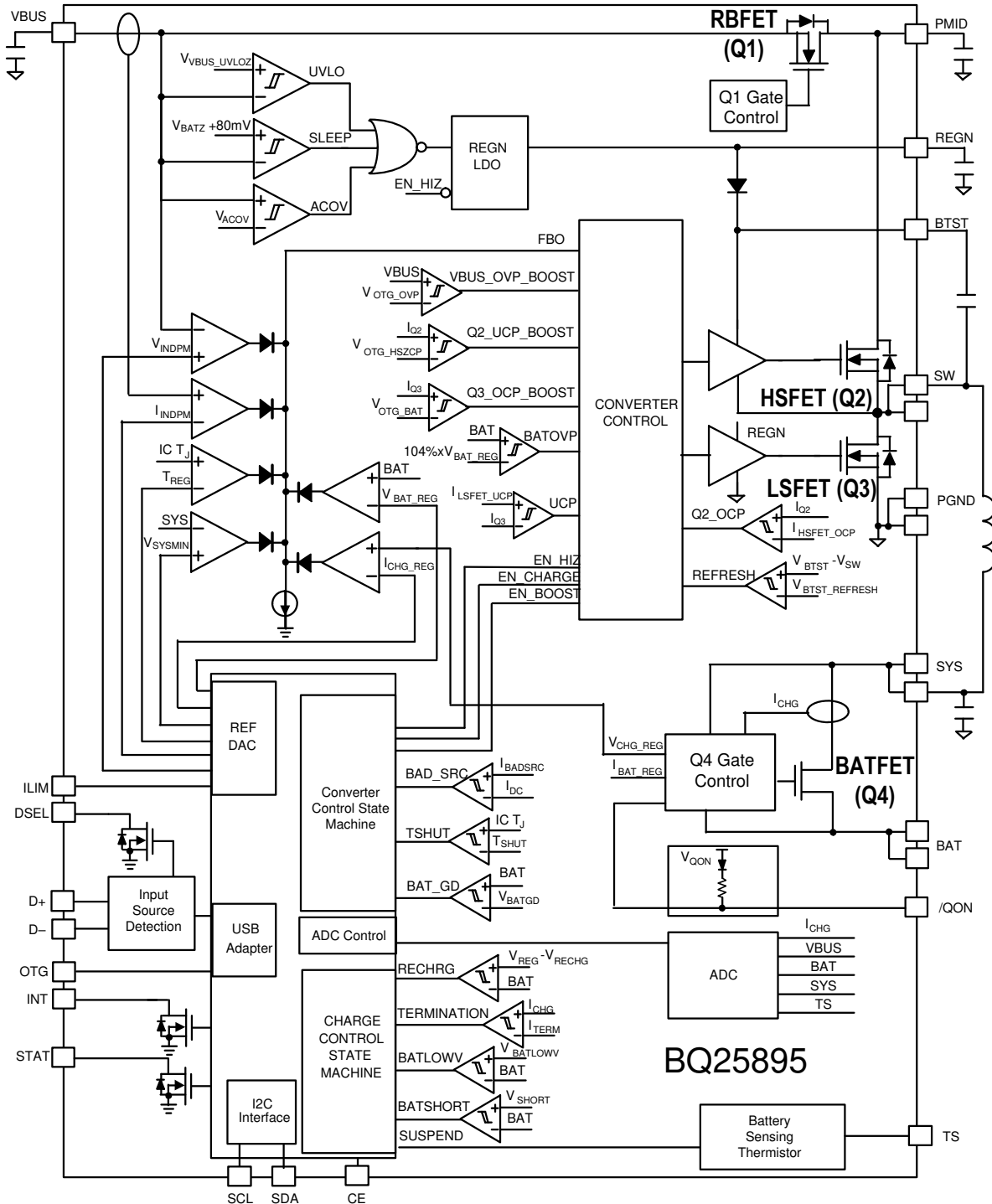

## 8.2 Feature Description

### 8.2.1 Device Power-On-Reset (POR)

The internal bias circuits are powered from the higher voltage of VBUS and BAT. When VBUS rises above  $V_{VBUS\_UVLOZ}$  or BAT rises above  $V_{BAT\_UVLOZ}$ , the sleep comparator, battery depletion comparator and BATFET driver are active. I<sup>2</sup>C interface is ready for communication and all the registers are reset to default value. The host can access all the registers after POR.

### 8.2.2 Device Power Up from Battery without Input Source

If only battery is present and the voltage is above depletion threshold ( $V_{BAT\_DPLZ}$ ), the BATFET turns on and connects battery to system. The REGN LDO stays off to minimize the quiescent current. The low  $R_{DS(ON)}$  of BATFET and the low quiescent current on BAT minimize the conduction loss and maximize the battery run time. The device always monitors the discharge current through BATFET (Section 8.2.6.3). When the system is overloaded or shorted ( $IBAT > I_{BATFET\_OCP}$ ), the device turns off BATFET immediately and set BATFET\_DIS bit to indicate BATFET is disabled until the input source plugs in again or one of the methods describe in Section 8.2.10.2 is applied to re-enable BATFET.

### 8.2.3 Device Power Up from Input Source

When an input source is plugged in, the device checks the input source voltage to turn on REGN LDO and all the bias circuits. It detects and sets the input current limit before the buck converter is started when AUTO\_DPDM\_EN bit is set. The power up sequence from input source is as listed:

1. Power Up REGN LDO
2. Poor Source Qualification
3. Section 8.2.3.3 based on D+/D- to set default Input Current Limit (IINLIM) register and input source type
4. Input Voltage Limit Threshold Setting (VINDPM threshold)
5. Converter Power-up

#### 8.2.3.1 Power Up REGN Regulation (LDO)

The REGN LDO supplies internal bias circuits as well as the HSFET and LSFET gate drive. The LDO also provides bias rail to TS external resistors. The pull-up rail of STAT can be connected to REGN as well. The REGN is enabled when all the below conditions are valid.

1. VBUS above  $V_{VBUS\_UVLOZ}$
2. VBUS above  $V_{BAT} + V_{SLEEPZ}$  in buck mode or VBUS below  $V_{BAT} + V_{SLEEP}$  in boost mode
3. After 220 ms delay is completed

If one of the above conditions is not valid, the device is in high impedance mode (HIZ) with REGN LDO off. The device draws less than  $I_{VBUS\_HIZ}$  from VBUS during HIZ state. The battery powers up the system when the device is in HIZ.

#### 8.2.3.2 Poor Source Qualification

After REGN LDO powers up, the device checks the current capability of the input source. The input source has to meet the following requirements in order to start the buck converter.

1. VBUS voltage below  $V_{ACOV}$
2. VBUS voltage above  $V_{VBUSMIN}$  when pulling  $I_{BADSRC}$  (typical 30mA)

Once the input source passes all the conditions above, the status register bit VBUS\_GD is set high and the INT pin is pulsed to signal to the host. If the device fails the poor source detection, it repeats poor source qualification every 2 seconds.

### 8.2.3.3 Input Source Type Detection

After the VBUS\_GD bit is set and REGN LDO is powered, the charger device runs [Section 8.2.3.3](#) when AUTO\_DPDM\_EN bit is set.

The BQ25895 follows the USB Battery Charging Specification 1.2 (BC1.2) and to detect input source (SDP/CDP/DCP) and non-standard adapter through USB D+/D- lines. In addition, when USB DCP is detected, it initiates adjustable high voltage adapter handshake on D+/D-. The device supports MaxCharge™ handshake when MAXC\_EN or HVDCP\_EN is set.

After input source type detection, an INT pulse is asserted to the host. In addition, the following registers and pin are changed:

1. Input Current Limit (IINLIM) register is changed to set current limit
2. PG\_STAT bit is set
3. SDP\_STAT bit is updated to indicate USB100 or other input source

The host can over-write IINLIM register to change the input current limit if needed. The charger input current is always limited by the lower of IINLIM register or ILIM pin at all-time regardless of Input Current Optimizer (ICO) is enable or disabled.

When AUTO\_DPDM\_EN is disabled, the [Section 8.2.3.3](#) is bypassed. The Input Current Limit (IINLIM) register, VBUS\_STAT, and SPD\_STAT bits are unchanged from previous values.

#### 8.2.3.3.1 D+/D- Detection Sets Input Current Limit

The BQ25890 contains a D+/D- based input source detection to set the input current limit automatically. The D+/D- detection includes standard USB BC1.2, non-standard adapter, and adjustable high voltage adapter detections. When input source is plugged-in, the device starts standard USB BC1.2 detections. The USB BC1.2 is capable to identify Standard Downstream Port (SDP), Charging Downstream Port (CDP), and Dedicated Charging Port (DCP). When the Data Contact Detection (DCD) timer of 500ms is expired, the non-standard adapter detection is applied to set the input current limit.

When DCP is detected, the device initiates adjustable high voltage adapter handshake including MaxCharge™, etc. The handshake connects combinations of voltage source(s) and/or current sink on D+/D- to signal input source to raise output voltage from 5 V to 9 V / 12 V. The adjustable high voltage adapter handshake can be disabled by clearing MAXC\_EN and/or HVDCP\_EN bits.

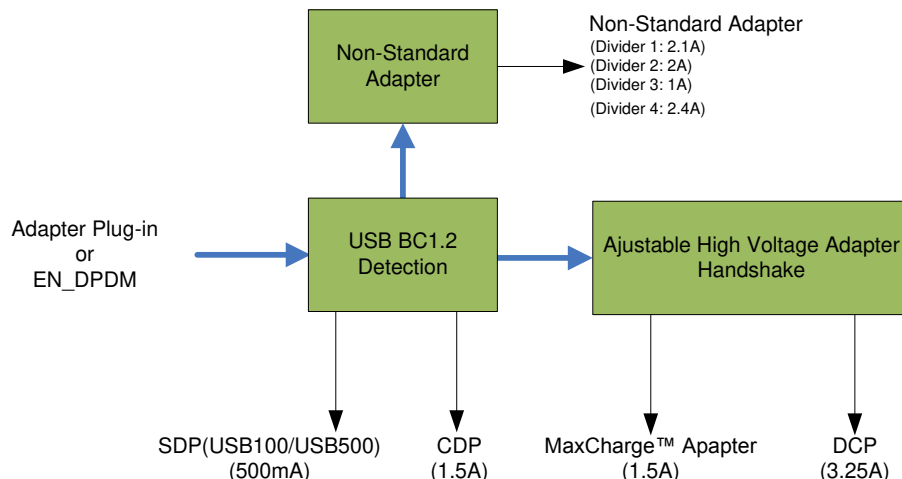

**Figure 8-1. USB D+/D- Detection**



**Table 8-1. Non-Standard Adapter Detection**

| NON-STANDARD ADAPTER | D+ THRESHOLD                   | D- THRESHOLD                   | INPUT CURRENT LIMIT |
|----------------------|--------------------------------|--------------------------------|---------------------|
| Divider 1            | $V_{D+}$ within $V_{2P7\_VTH}$ | $V_{D-}$ within $V_{2P0\_VTH}$ | 2.1A                |
| Divider 2            | $V_{D+}$ within $V_{1P2\_VTH}$ | $V_{D-}$ within $V_{1P2\_VTH}$ | 2A                  |
| Divider 3            | $V_{D+}$ within $V_{2P0\_VTH}$ | $V_{D-}$ within $V_{2P7\_VTH}$ | 1A                  |
| Divider 4            | $V_{D+}$ within $V_{2P7\_VTH}$ | $V_{D-}$ within $V_{2P7\_VTH}$ | 2.4A                |

**Table 8-2. Adjustable High Voltage Adapter D+/D- Output Configurations**

| ADJUSTABLE HIGH VOLTAGE HANDSHAKE | D+                 | D-                 | OUTPUT |
|-----------------------------------|--------------------|--------------------|--------|
| MaxCharge (12V)                   | $I_{1P6MA\_ISINK}$ | $V_{3p45\_VSRC}$   | 12 V   |
| MaxCharge (9V)                    | $V_{3p45\_VSRC}$   | $I_{1P6MA\_ISINK}$ | 9 V    |

After the [Section 8.2.3.3](#) is done, an INT pulse is asserted to the host. In addition, the following registers including Input Current Limit register (IINLIM), VBUS\_STAT, and SDP\_STAT are updated as below:

**Table 8-3. BQ25895 Result**

| D+/D- DETECTION  | INPUT CURRENT LIMIT (IINLIM) | SDP_STAT | VBUS_STAT |
|------------------|------------------------------|----------|-----------|
| USB SDP (USB500) | 500 mA                       | 1        | 001       |
| USB CDP          | 1.5 A                        | 1        | 010       |
| USB DCP          | 3.25 A                       | 1        | 011       |
| Divider 3        | 1 A                          | 1        | 110       |
| Divider 1        | 2.1 A                        | 1        | 110       |
| Divider 4        | 2.4 A                        | 1        | 110       |
| Divider 2        | 2 A                          | 1        | 110       |
| MaxCharge        | 1.5 A                        | 1        | 100       |
| Unknown Adapter  | 500 mA                       | 1        | 101       |

#### 8.2.3.3.2 Force Input Current Limit Detection

In host mode, the host can force the device to run by setting FORCE\_DPDM bit. After the detection is completed, FORCE\_DPDM bit returns to 0 by itself and Input Result is updated.

#### 8.2.3.4 Input Voltage Limit Threshold Setting (VINDPM Threshold)

The device supports wide range of input voltage limit (3.9 V – 14 V) for high voltage charging and provides two methods to set Input Voltage Limit (VINDPM) threshold to facilitate autonomous detection.

1. Absolute VINDPM (FORCE\_VINDPM=1)

By setting FORCE\_VINDPM bit to 1, the VINDPM threshold setting algorithm is disabled. Register VINDPM is writable and allows host to set the absolute threshold of VINDPM function.

2. Relative VINDPM based on VINDPM\_OS registers (FORCE\_VINDPM=0) (Default)

When FORCE\_VINDPM bit is 0 (default), the VINDPM threshold setting algorithm is enabled. The VINDPM register is read only and the charger controls the register by using VINDPM Threshold setting algorithm. The algorithm allows a wide range of adapter ( $V_{VBUS\_OP}$ ) to be used with flexible VINDPM threshold.

After Input Voltage Limit Threshold is set, an INT pulse is generated to signal to the host.

#### 8.2.3.5 Converter Power-Up

After the input current limit is set, the converter is enabled and the HSFET and LSFET start switching. If battery charging is disabled, BATFET turns off. Otherwise, BATFET stays on to charge the battery.

The device provides soft-start when system rail is ramped up. When the system rail is below 2.2 V, the input current limit is forced to the lower of 200 mA or IINLIM register setting. After the system rises above 2.2 V, the device limits input current to the lower value of ILIM pin and IILIM register (ICO\_EN = 0) or IDPM\_LIM register (ICO\_EN = 1).

As a battery charger, the device deploys a highly efficient 1.5 MHz step-down switching regulator. The fixed frequency oscillator keeps tight control of the switching frequency under all conditions of input voltage, battery voltage, charge current and temperature, simplifying output filter design.

A type III compensation network allows using ceramic capacitors at the output of the converter. An internal saw-tooth ramp is compared to the internal error control signal to vary the duty cycle of the converter. The ramp height is proportional to the PMID voltage to cancel out any loop gain variation due to a change in input voltage.

In order to improve light-load efficiency, the device switches to PFM control at light load when battery is below minimum system voltage setting or charging is disabled. During the PFM operation, the switching duty cycle is set by the ratio of SYS and VBUS.

#### 8.2.4 Input Current Optimizer (ICO)

The device provides innovative Input Current Optimizer (ICO) to identify maximum power point without overload the input source. The algorithm automatically identify maximum input current limit of power source without entering VINDPM to avoid input source overload.

This feature is enabled by default (ICO\_EN=1) and can be disabled by setting ICO\_EN bit to 0. After DCP or MaxCharge type input source is detected based on the procedures previously described ([Section 8.2.3.3](#)). The algorithm runs automatically when ICO\_EN bit is set. The algorithm can also be forced to execute by setting FORCE\_ICO bit regardless of input source type detected.

The actual input current limit used by the [Section 8.2.6.2](#) is reported in IDPM\_LIM register while Input Current Optimizer is enabled (ICO\_EN = 1) or set by IINLIM register when the algorithm is disabled (ICO\_EN = 0). In addition, the current limit is clamped by ILIM pin unless EN\_ILIM bit is 0 to disable ILIM pin function.

### 8.2.5 Boost Mode Operation from Battery

The device supports boost converter operation to deliver power from the battery to other portable devices through PMID pin. The boost mode output current rating supports maximum output current up to 3.1 A to charge smartphone and tablet at fast charging rate. The boost operation can be enabled if the conditions are valid:

1. BAT above  $BAT_{LOWV}$
2. VBUS less than  $BAT + V_{SLEEP}$  (in sleep mode)
3. Boost mode operation is enabled (OTG pin HIGH and OTG\_CONFIG bit =1)
4. Voltage at TS (thermistor) pin is within range configured by Boost Mode Temperature Monitor as configured by BHOT and BCOLD bits
5. After 30 ms delay from boost mode enable

In boost mode, the device employs a 500 KHz or 1.5 MHz (selectable using BOOST\_FREQ bit) step-up switching regulator based on system requirements. To avoid frequency change during boost mode operations, write to boost frequency configuration bit (BOOST\_FREQ) is ignored when OTG\_CONFIG is set.

During boost mode, the status register VBUS\_STAT bits is set to 111, the VBUS output is 5V by default (selectable via BOOSTV register bits). The boost output is maintained when BAT is above  $V_{OTG\_BAT}$  threshold

### 8.2.6 Power Path Management

The device accommodates a wide range of input sources from USB, wall adapter, to car battery. The device provides automatic power path selection to supply the system (SYS) from input source (VBUS), battery (BAT), or both.

#### 8.2.6.1 Narrow VDC Architecture

The device deploys Narrow VDC architecture (NVDC) with BATFET separating system from battery. The minimum system voltage is set by SYS\_MIN bits. Even with a fully depleted battery, the system is regulated above the minimum system voltage (default 3.5 V).

When the battery is below minimum system voltage setting, the BATFET operates in linear mode (LDO mode), and the system is regulated above the minimum system voltage setting. As the battery voltage rises above the minimum system voltage, BATFET is fully on and the voltage difference between the system and battery is the  $V_{DS}$  of BATFET. The status register VSYS\_STAT bit goes high when the system is in minimum system voltage regulation.

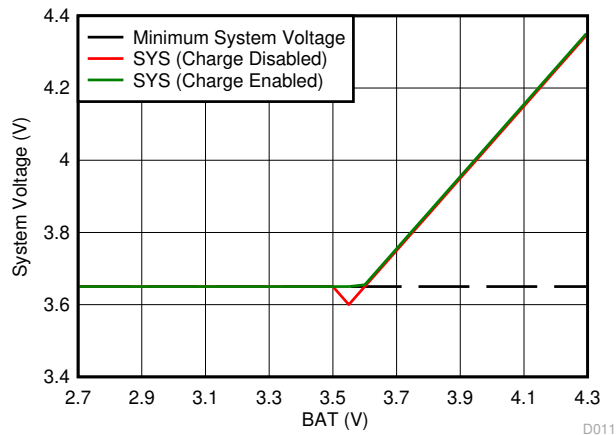

**Figure 8-2. V(SYS) vs V(BAT)**

#### 8.2.6.2 Dynamic Power Management

To meet maximum current limit in USB spec and avoid over loading the adapter, the device features Dynamic Power Management (DPM), which continuously monitors the input current and input voltage. When input source is over-loaded, either the current exceeds the input current limit (IINLIM or IDPM\_LIM) or the voltage falls below

the input voltage limit (VINDPM). The device then reduces the charge current until the input current falls below the input current limit and the input voltage rises above the input voltage limit.

When the charge current is reduced to zero, but the input source is still overloaded, the system voltage starts to drop. Once the system voltage falls below the battery voltage, the device automatically enters the [Section 8.2.6.3](#) where the BATFET turns on and battery starts discharging so that the system is supported from both the input source and battery.

During DPM mode, the status register bits VDPM\_STAT (VINDPM) and/or IDPM\_STAT (IINDPM) is/are set high. [Figure 8-3](#) shows the DPM response with 9V/1.2A adapter, 3.2-V battery, 2.8-A charge current and 3.4-V minimum system voltage setting.

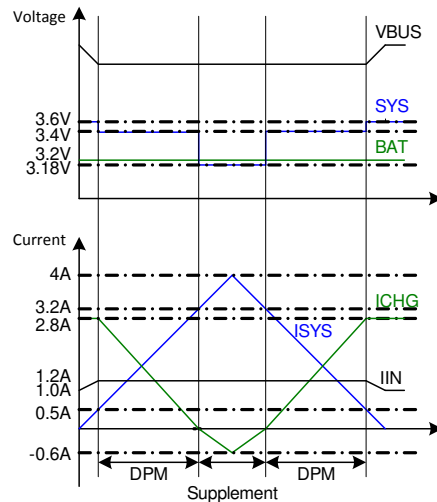

**Figure 8-3. DPM Response**

### 8.2.6.3 Supplement Mode

When the system voltage falls below the battery voltage, the BATFET turns on and the BATFET gate is regulated so that the minimum BATFET VDS stays at 30 mV when the current is low. This prevents oscillation from entering and exiting the [Section 8.2.6.3](#). As the discharge current increases, the BATFET gate is regulated with a higher voltage to reduce  $R_{DS(ON)}$  until the BATFET is in full conduction. At this point onwards, the BATFET VDS linearly increases with discharge current. [Figure 8-4](#) shows the V-I curve of the BATFET gate regulation operation. BATFET turns off to exit [Section 8.2.6.3](#) when the battery is below battery depletion threshold.

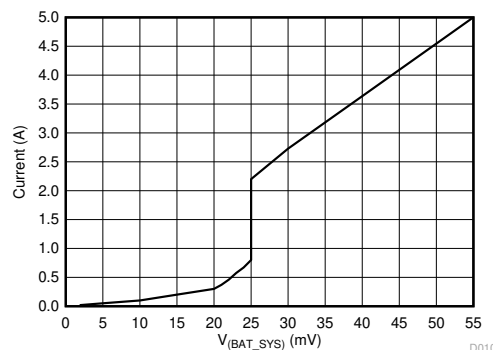

**Figure 8-4. BATFET V-I Curve**

## 8.2.7 Battery Charging Management

The device charges 1-cell Li-Ion battery with up to 5-A charge current for high capacity battery. The 11-mΩ BATFET improves charging efficiency and minimize the voltage drop during discharging.

### 8.2.7.1 Autonomous Charging Cycle

With battery charging is enabled (CHG\_CONFIG bit = 1 and  $\overline{CE}$  pin is low), the device autonomously completes a charging cycle without host involvement. The device default charging parameters are listed in [Table 8-4](#) always control the charging operations and optimize the charging parameters by writing to the corresponding registers through I<sup>2</sup>C.

**Table 8-4. Charging Parameter Default Setting**

| DEFAULT MODE        | BQ25895  |
|---------------------|----------|
| Charging Voltage    | 4.208 V  |
| Charging Current    | 2.048 A  |
| Pre-charge Current  | 128 mA   |
| Termination Current | 256 mA   |
| Temperature Profile | Cold/Hot |
| Safety Timer        | 12 hour  |

A new charge cycle starts when the following conditions are valid:

- Converter starts
- Battery charging is enabled by setting CHG\_CONFIG bit, /CE pin is low and ICHG register is not 0 mA
- No thermistor fault on TS pin
- No safety timer fault
- BATFET is not forced to turn off (BATFET\_DIS bit = 0)

The charger device automatically terminates the charging cycle when the charging current is below termination threshold, charge voltage is above recharge threshold, and device not in DPM mode or thermal regulation. When a full battery voltage is discharged below recharge threshold (threshold selectable via VRECHG bit), the device automatically starts a new charging cycle. After the charge is done, either toggle  $\overline{CE}$  pin or CHG\_CONFIG bit can initiate a new charging cycle.

The STAT output indicates the charging status of charging (LOW), charging complete or charge disable (HIGH) or charging fault (Blinking). The STAT output can be disabled by setting STAT\_DIS bit. In addition, the status register (CHRG\_STAT) indicates the different charging phases: 00-charging disable, 01-precharge, 10-fast charge (constant current) and constant voltage mode, 11-charging done. Once a charging cycle is completed, an INT is asserted to notify the host.

### 8.2.7.2 Battery Charging Profile

The device charges the battery in three phases: preconditioning, constant current and constant voltage. At the beginning of a charging cycle, the device checks the battery voltage and regulates current / voltage.

**Table 8-5. Charging Current Setting**

| VBAT      | CHARGING CURRENT      | REG DEFAULT SETTING | CHRG_STAT |
|-----------|-----------------------|---------------------|-----------|
| < 2 V     | I <sub>BATSHORT</sub> | –                   | 01        |
| 2 V – 3 V | I <sub>PRECHG</sub>   | 128 mA              | 01        |
| > 3 V     | I <sub>CHG</sub>      | 2048 mA             | 10        |

If the charger device is in DPM regulation or thermal regulation during charging, the charging current can be less than the programmed value. In this case, termination is temporarily disabled and the charging safety timer is counted at half the clock rate.

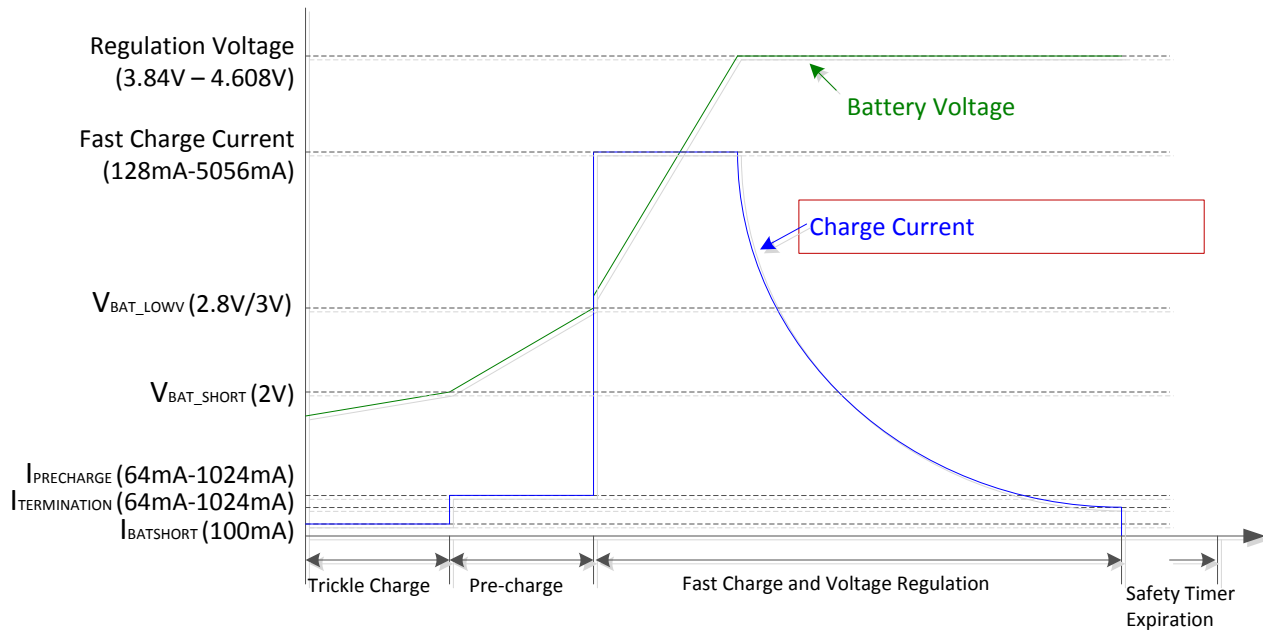

**Figure 8-5. Battery Charging Profile**

### 8.2.7.3 Charging Termination

The device terminates a charge cycle when the battery voltage is above recharge threshold, and the current is below termination current. After the charging cycle is completed, the BATFET turns off. The converter keeps running to power the system, and BATFET can turn on again to engage [Section 8.2.6.3](#).

When termination occurs, the status register CHRG\_STAT is set to 11, and an INT pulse is asserted to the host. Termination is temporarily disabled when the charger device is in input current, voltage or thermal regulation. Termination can be disabled by writing 0 to EN\_TERM bit prior to charge termination.

### 8.2.7.4 Resistance Compensation (IRCOMP)

For high current charging system, resistance between charger output and battery cell terminal such as board routing, connector, MOSFETs and sense resistor can force the charging process to move from constant current to constant voltage too early and increase charge time. To speed up the charging cycle, the device provides resistance compensation (IRCOMP) feature which can extend the constant current charge time to delivery maximum power to battery.

The device allows the host to compensate for the resistance by increasing the voltage regulation set point based on actual charge current and the resistance as shown below. For safe operation, the host should set the maximum allowed regulation voltage register ( $V_{CLAMP}$ ) and the minimum resistance compensation (BATCOMP).

$$V_{REG\_ACTUAL} = V_{REG} + \min(I_{CHRG\_ACTUAL} \times BATCOMP, V_{CLAMP}) \quad (1)$$

### 8.2.7.5 Thermistor Qualification

#### 8.2.7.5.1 Cold/Hot Temperature Window in Charge Mode

The device continuously monitors battery temperature by measuring the voltage between the TS pins and ground, typically determined by a negative temperature coefficient thermistor (NTC) and an external voltage divider. The device compares this voltage against its internal thresholds to determine if charging is allowed. To initiate a charge cycle, the battery temperature must be within the  $V_{LTF}$  to  $V_{HTF}$  thresholds. During the charge cycle the battery temperature must be within the  $V_{LTF}$  to  $V_{TCO}$  thresholds, else the device suspends charging and waits until the battery temperature is within the  $V_{LTF}$  to  $V_{HTF}$  range.

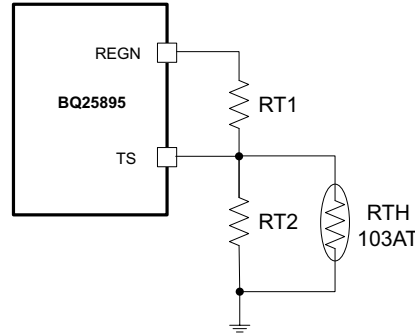

Figure 8-6. TS Resistor Network

When the TS fault occurs, the fault register REG0C[2:0] indicates the actual condition on each TS pin and an INT is asserted to the host. The STAT pin indicates the fault when charging is suspended.

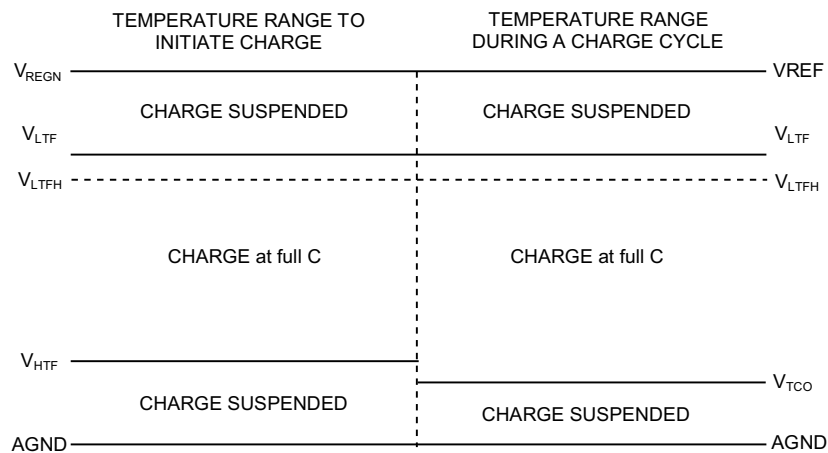

Figure 8-7. TS Pin Thermistor Sense Thresholds

Assuming a 103AT NTC thermistor on the battery pack as shown in Figure 8-6, the value RT1 and RT2 can be determined by using Equation 2:

$$RT2 = \frac{V_{REGN} \times RTH_{COLD} \times RTH_{HOT} \times \left( \frac{1}{VT1} - \frac{1}{VT5} \right)}{RTH_{HOT} \times \left( \frac{V_{REGN}}{VT5} - 1 \right) - RTH_{COLD} \times \left( \frac{V_{REGN}}{VT1} - 1 \right)}$$

$$RT1 = \frac{\frac{V_{REGN}}{VT1} - 1}{\frac{1}{RT2} + \frac{1}{RTH_{COLD}}}$$

(2)

Select 0°C to 45°C range for Li-ion or Li-polymer battery,

$RTH_{COLD} = 27.28 \text{ k}\Omega$

$RTH_{HOT} = 4.91 \text{ k}\Omega$

$RT1 = 5.21 \text{ k}\Omega$

$RT2 = 29.87 \text{ k}\Omega$

#### 8.2.7.5.2 Cold/Hot Temperature Window in Boost Mode

For battery protection during boost mode, the device monitors the battery temperature to be within the  $V_{BCOLDx}$  to  $V_{BHOTx}$  thresholds unless boost mode temperature is disabled by setting BHOT bits to 11. When temperature

is outside of the temperature thresholds, the boost mode and BATFET are disabled and BATFET\_DIS bit is set to reduce leakage current on PMID. Once temperature returns within thresholds, the host can clear BATFET\_DIS bit or provide logic low to high transition on QON pin to enable BATFET and boost mode.

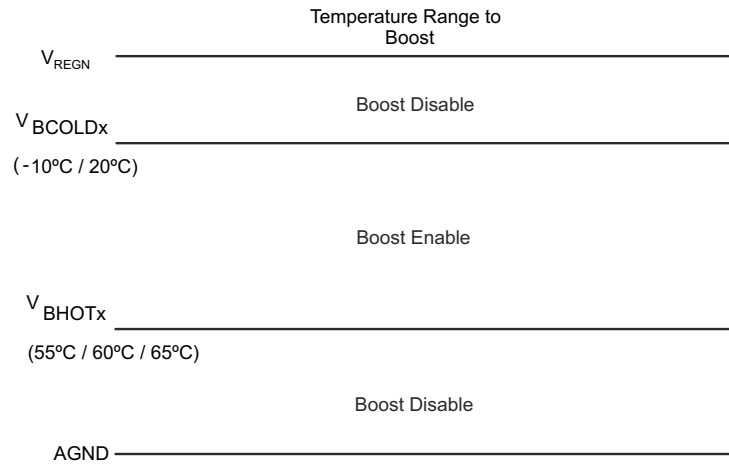

**Figure 8-8. TS Pin Thermistor Sense Thresholds in Boost Mode**

### 8.2.7.6 Charging Safety Timer

The device has built-in safety timer to prevent extended charging cycle due to abnormal battery conditions. The safety timer is 4 hours when the battery is below  $V_{BATLOWV}$  threshold. The user can program fast charge safety timer through I<sup>2</sup>C (CHG\_TIMER bits). When safety timer expires, the fault register CHRG\_FAULT bits are set to 11 and an INT is asserted to the host. The safety timer feature can be disabled via I2C by setting EN\_TIMER bit.

During input voltage, current or thermal regulation, the safety timer counts at half clock rate as the actual charge current is likely to be below the register setting. For example, if the charger is in input current regulation (IDPM\_STAT = 1) throughout the whole charging cycle, and the safety time is set to 5 hours, the safety timer will expire in 10 hours. This half clock rate feature can be disabled by writing 0 to TMR2X\_EN bit.

### 8.2.8 Battery Monitor

The device includes a battery monitor to provide measurements of VBUS voltage, battery voltage, system voltage, thermistor ratio, and charging current, and charging current based on the device modes of operation. The measurements are reported in Battery Monitor Registers (REG0E-REG12). The battery monitor can be configured as two conversion modes by using CONV\_RATE bit: one-shot conversion (default) and 1 second continuous conversion.

For one-shot conversion (CONV\_RATE = 0), the CONV\_START bit can be set to start the conversion. During the conversion, the CONV\_START is set and it is cleared by the device when conversion is completed. The conversion result is ready after  $t_{CONV}$  (maximum 1 second).

For continuous conversion (CONV\_RATE = 1), the CONV\_RATE bit can be set to initiate the conversion. During active conversion, the CONV\_START is set to indicate conversion is in progress. The battery monitor provides conversion result every 1 second automatically. The battery monitor exits continuous conversion mode when CONV\_RATE is cleared.

When battery monitor is active, the REGN power is enabled and can increase device quiescent current. In battery only mode, the battery monitor is only active when  $V_{(BAT)} > SYS\_MIN$  setting in REG03.



**Table 8-6. Battery Monitor Modes of Operation**

| PARAMETER                             | REGISTER | MODES OF OPERATION |            |                     |                   |
|---------------------------------------|----------|--------------------|------------|---------------------|-------------------|
|                                       |          | CHARGE MODE        | BOOST MODE | DISABLE CHARGE MODE | BATTERY ONLY MODE |
| Battery Voltage ( $V_{BAT}$ )         | REG0E    | Yes                | Yes        | Yes                 | Yes               |
| System Voltage ( $V_{SYS}$ )          | REG0F    | Yes                | Yes        | Yes                 | Yes               |
| Temperature (TS) Voltage ( $V_{TS}$ ) | REG10    | Yes                | Yes        | Yes                 | Yes               |
| VBUS Voltage ( $V_{VBUS}$ )           | REG11    | Yes                | Yes        | Yes                 | NA                |
| Charge Current ( $I_{BAT}$ )          | REG12    | Yes                | NA         | NA                  | NA                |

## 8.2.9 Status Outputs (STAT, and INT)

### 8.2.9.1 Charging Status Indicator (STAT)

The device indicates charging state on the open drain STAT pin. The STAT pin can drive LED as shown in [Figure 9-1](#). The STAT pin function can be disabled by setting STAT\_DIS bit.

**Table 8-7. STAT Pin State**

| CHARGING STATE                                                                                                                  | STAT INDICATOR   |
|---------------------------------------------------------------------------------------------------------------------------------|------------------|
| Charging in progress (including recharge)                                                                                       | LOW              |
| Charging complete                                                                                                               | HIGH             |
| Sleep mode, charge disable                                                                                                      | HIGH             |
| Charge suspend (Input overvoltage, TS fault, timer fault, input or system overvoltage).<br>Boost Mode suspend (due to TS Fault) | blinking at 1 Hz |

### 8.2.9.2 Interrupt to Host (INT)

In some applications, the host does not always monitor the charger operation. The INT notifies the system on the device operation. The following events will generate 256- $\mu$ s INT pulse.

- USB/adaptor source identified (through PSEL or DPDM detection, with OTG pin)
- Good input source detected
  - VBUS above battery (not in sleep)
  - VBUS below  $V_{ACOV}$  threshold
  - VBUS above  $V_{VBUSMIN}$  (typical 3.8 V) when  $I_{BADSRC}$  (typical 30 mA) current is applied (not a poor source)
- Input removed
- Charge Complete
- Any FAULT event in REG0C

When a fault occurs, the charger device sends out INT and keeps the fault state in REG0C until the host reads the fault register. Before the host reads REG0C and all the faults are cleared, the charger device would not send any INT upon new faults. To read the current fault status, the host has to read REG0C two times consecutively. The 1<sup>st</sup> read reports the pre-existing fault register status and the 2<sup>nd</sup> read reports the current fault register status.

## 8.2.10 BATET (Q4) Control

### 8.2.10.1 BATFET Disable Mode (Shipping Mode)

To extend battery life and minimize power when system is powered off during system idle, shipping, or storage, the device can turn off BATFET so that the system voltage is zero to minimize the battery leakage current. When the host set BATFET\_DIS bit, the charger can turn off BATFET immediately or delay by  $t_{SM\_DLY}$  as configured by BATFET\_DLY bit.

### 8.2.10.2 BATFET Enable (Exit Shipping Mode)

When the BATFET is disabled (in shipping mode) and indicated by setting BATFET\_DIS, one of the following events can enable BATFET to restore system power:

1. Plug in adapter
2. Clear BATFET\_DIS bit

3. Set REG\_RST bit to reset all registers including BATFET\_DIS bit to default (0)
4. A logic high to low transition on QON pin with t<sub>SHIPMODE</sub> deglitch time to enable BATFET to exit shipping mode

### 8.2.10.3 BATFET Full System Reset

The BATFET functions as a load switch between battery and system when input source is not plugged-in. By changing the state of BATFET from off to on, system connects to SYS can be effectively have a power-on-reset. The QON pin supports push-button interface to reset system power without host by change the state of BATFET.

When the QON pin is driven to logic low for t<sub>QON\_RST</sub> while input source is not plugged in and BATFET is enabled (BATFET\_DIS=0), the BATFET is turned off for t<sub>BATFET\_RST</sub> and then it is re-enabled to reset system power. This function can be disabled by setting BATFET\_RST\_EN bit to 0.

### 8.2.11 Current Pulse Control Protocol

The device provides the control to generate the VBUS current pulse protocol to communicate with adjustable high voltage adapter in order to signal adapter to increase or decrease output voltage. To enable the interface, the EN\_PUMPX bit must be set. Then the host can select the increase/decrease voltage pulse by setting one of the PUMPX\_UP or PUMPX\_DN bit (but not both) to start the VBUS current pulse sequence. During the current pulse sequence, the PUMPX\_UP and PUMPX\_DN bits are set to indicate pulse sequence is in progress and the device pulses the input current limit between current limit set forth by IINLIM or IDPM\_LIM register and the 100mA current limit (I<sub>INDPM100\_ACC</sub>). When the pulse sequence is completed, the input current limit is returned to value set by IINLIM or IDPM\_LIM register and the PUMPX\_UP or PUMPX\_DN bit is cleared. In addition, the EN\_PUMPX can be cleared during the current pulse sequence to terminate the sequence and force charger to return to input current limit as set forth by the IINLIM or IDPM\_LIM register immediately. When EN\_PUMPX bit is low, write to PUMPX\_UP and PUMPX\_DN bit would be ignored and have no effect on VBUS current limit.

### 8.2.12 Input Current Limit on ILIM

For safe operation, the device has an additional hardware pin on ILIM to limit maximum input current on ILIM pin. The input maximum current is set by a resistor from ILIM pin to ground as:

$$I_{INMAX} = \frac{K_{ILIM}}{R_{ILIM}} \quad (3)$$

The actual input current limit is the lower value between ILIM setting and register setting (IINLIM). For example, if the register setting is 111111 for 3.25 A, and ILIM has a 260-Ω resistor (K<sub>ILIM</sub> = 390 max.) to ground for 1.5 A, the input current limit is 1.5 A. ILIM pin can be used to set the input current limit rather than the register settings when EN\_ILIM bit is set. The device regulates ILIM pin at 0.8 V. If ILIM voltage exceeds 0.8 V, the device enters input current regulation (refer to [Section 8.2.6.2](#) section).

The ILIM pin can also be used to monitor input current when EN\_ILIM is enabled. The voltage on ILIM pin is proportional to the input current. ILIM pin can be used to monitor the input current following [Equation 4](#):

$$I_N = \frac{K_{ILIM} \times V_{ILIM}}{R_{ILIM} \times 0.8 \text{ V}} \quad (4)$$

For example, if ILIM pin is set with 260-Ω resistor, and the ILIM voltage is 0.4 V, the actual input current 0.615 A - 0.75 A (based on K<sub>ILIM</sub> specified). If ILIM pin is open, the input current is limited to zero since ILIM voltage floats above 0.8 V. If ILIM pin is short, the input current limit is set by the register.

The ILIM pin function can be disabled by setting EN\_ILIM bit to 0. When the pin is disabled, both input current limit function and monitoring function are not available.

### 8.2.13 Thermal Regulation and Thermal Shutdown

#### 8.2.13.1 Thermal Protection in Buck Mode

The device monitors the internal junction temperature T<sub>J</sub> to avoid overheat the chip and limits the IC surface temperature in buck mode. When the internal junction temperature exceeds the preset thermal regulation limit

(TREG bits), the device lowers down the charge current. The wide thermal regulation range from 60°C to 120°C allows the user to optimize the system thermal performance.

During thermal regulation, the actual charging current is usually below the programmed battery charging current. Therefore, termination is disabled, the safety timer runs at half the clock rate, and the status register THERM\_STAT bit goes high.

Additionally, the device has thermal shutdown to turn off the converter and BATFET when IC surface temperature exceeds  $T_{SHUT}$ . The fault register CHRG\_FAULT is set to 10 and an INT is asserted to the host. The BATFET and converter is enabled to recover when IC temperature is below  $T_{SHUT\_HYS}$ .

### **8.2.13.2 Thermal Protection in Boost Mode**

The device monitors the internal junction temperature to provide thermal shutdown during boost mode. When IC surface temperature exceeds  $T_{SHUT}$ , BATFET is turned off to disable battery discharge. When IC surface temperature is below  $T_{SHUT\_HYS}$ , the host can use one of the method describes in section [Section 8.2.10.2](#) to recover.

## **8.2.14 Voltage and Current Monitoring in Buck and Boost Mode**

### **8.2.14.1 Voltage and Current Monitoring in Buck Mode**

The device closely monitors the input and system voltage, as well as HSFET current for safe buck and boost mode operations.

#### **8.2.14.1.1 Input Overvoltage (ACOV)**

The input voltage for buck mode operation is  $V_{VBUS\_OP}$ . If VBUS voltage exceeds  $V_{ACOV}$ , the device stops switching immediately. During input over voltage (ACOV), the fault register CHRG\_FAULT bits sets to 01. An INT is asserted to the host.

#### **8.2.14.1.2 System Overvoltage Protection (YSOVP)**

The charger device clamps the system voltage during load transient so that the components connect to system would not be damaged due to high voltage. When YSOVP is detected, the converter stops immediately to clamp the overshoot.

### **8.2.14.2 Current Monitoring in Boost Mode**

The device closely monitors the VBUS voltage, as well as LSFET current to ensure safe boost mode operation.

#### **8.2.14.2.1 Boost Mode Overvoltage Protection**

When PMID voltage rises above regulation target and exceeds  $V_{OTG\_OVP}$ , the device enters overvoltage protection which stops switching and pauses boost mode (OTG\_CONFIG bit remains set) until OVP fault is removed. During the overvoltage, the fault register bit (BOOST\_FAULT) is set high to indicate fault in boost operation. An INT is also asserted to the host.

## **8.2.15 Battery Protection**

### **8.2.15.1 Battery Overvoltage Protection (BATOVP)**

The battery overvoltage limit is clamped at 4% above the battery regulation voltage. When battery over voltage occurs, the charger device immediately disables charge. The fault register BAT\_FAULT bit goes high and an INT is asserted to the host.

### **8.2.15.2 Battery Over-Discharge Protection**

When battery is discharged below  $V_{BAT\_DPL}$ , the BATFET is turned off to protect battery from over discharge. To recover from over-discharge, an input source is required at VBUS. When an input source is plugged in, the BATFET turns on. The battery is charged with  $I_{BATSHORT}$  (typically 100 mA) current when  $V_{BAT} < V_{SHORT}$  or precharge current as set in the IPRECHG register when the battery voltage is between  $V_{SHORT}$  and  $V_{BATLOWV}$ .

### 8.2.15.3 System Overcurrent Protection

When the system is shorted or significantly overloaded ( $I_{BAT} > I_{BATOP}$ ) so that its current exceeds the overcurrent limit, the device latches off BATFET. Section [Section 8.2.10.2](#) can reset the latch-off condition and turn on BATFET.

### 8.2.16 Serial Interface

The device uses I<sup>2</sup>C compatible interface for flexible charging parameter programming and instantaneous device status reporting. I<sup>2</sup>C is a bi-directional 2-wire serial interface. Only two open-drain bus lines are required: a serial data line (SDA) and a serial clock line (SCL). Devices can be considered as hosts or targets when performing data transfers. A host is the device which initiates a data transfer on the bus and generates the clock signals to permit that transfer. At that time, any device addressed is considered a target.

The device operates as a target device with address 6AH, receiving control inputs from the host device like micro controller or a digital signal processor through REG00-REG14. Register read beyond REG14 (0x14) returns 0xFF. The I<sup>2</sup>C interface supports both standard mode (up to 100 kbits), and fast mode (up to 400 kbits). When the bus is free, both lines are HIGH. The SDA and SCL pins are open drain and must be connected to the positive supply voltage via a current source or pull-up resistor.

#### 8.2.16.1 Data Validity

The data on the SDA line must be stable during the HIGH period of the clock. The HIGH or LOW state of the data line can only change when the clock signal on the SCL line is LOW. One clock pulse is generated for each data bit transferred.

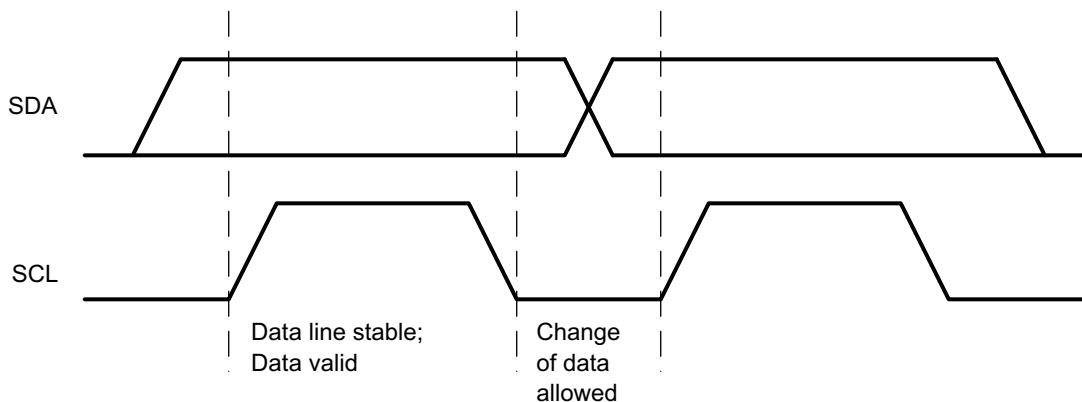

**Figure 8-9. Bit Transfer on the I<sup>2</sup>C Bus**

#### 8.2.16.2 START and STOP Conditions

All transactions begin with a START (S) and can be terminated by a STOP (P). A HIGH to LOW transition on the SDA line while SCL is HIGH defines a START condition. A LOW to HIGH transition on the SDA line when the SCL is HIGH defines a STOP condition.

START and STOP conditions are always generated by the host. The bus is considered busy after the START condition, and free after the STOP condition.

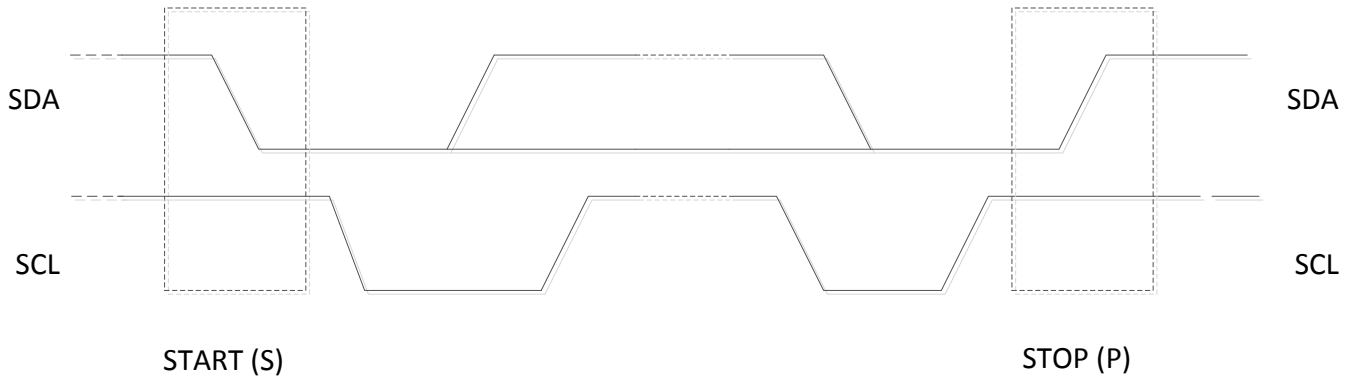

Figure 8-10. START and STOP conditions

### 8.2.16.3 Byte Format

Every byte on the SDA line must be 8 bits long. The number of bytes to be transmitted per transfer is unrestricted. Each byte has to be followed by an Acknowledge bit. Data is transferred with the Most Significant Bit (MSB) first. If a target cannot receive or transmit another complete byte of data until it has performed some other function, it can hold the clock line SCL low to force the host into a wait state (clock stretching). Data transfer then continues when the target is ready for another byte of data and release the clock line SCL.

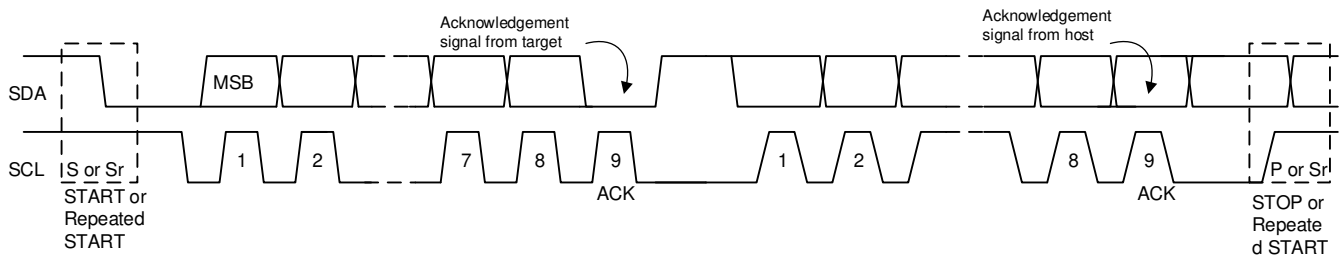

Figure 8-11. Data Transfer on the I<sup>2</sup>C Bus

### 8.2.16.4 Acknowledge (ACK) and Not Acknowledge (NACK)

The acknowledge takes place after every byte. The acknowledge bit allows the receiver to signal the transmitter that the byte was successfully received and another byte may be sent. All clock pulses, including the acknowledge 9<sup>th</sup> clock pulse, are generated by the host.

The transmitter releases the SDA line during the acknowledge clock pulse so the receiver can pull the SDA line LOW and it remains stable LOW during the HIGH period of this clock pulse.

When SDA remains HIGH during the 9<sup>th</sup> clock pulse, this is the Not Acknowledge signal. The host can then generate either a STOP to abort the transfer or a repeated START to start a new transfer.

### 8.2.16.5 Target Address and Data Direction Bit

After the START, a target address is sent. This address is 7 bits long followed by the eighth bit as a data direction bit (bit R/W). A zero indicates a transmission (WRITE) and a one indicates a request for data (READ).

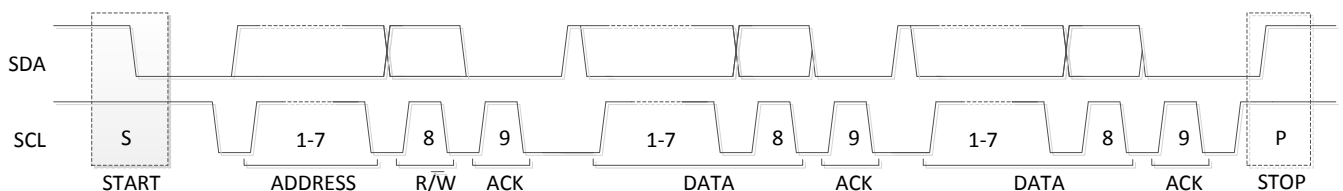
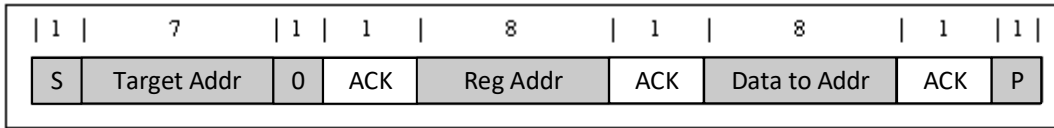
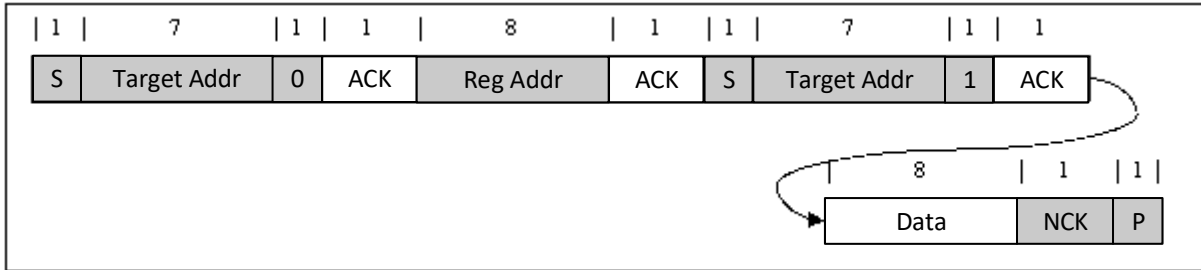

Figure 8-12. Complete Data Transfer

**8.2.16.6 Single Read and Write**



**Figure 8-13. Single Write**

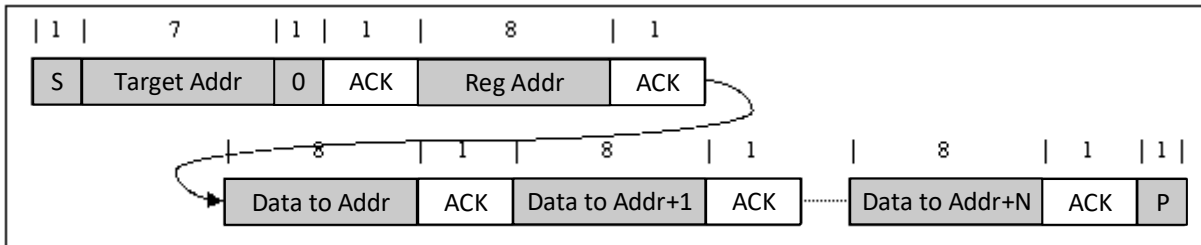

**Figure 8-14. Single Read**

If the register address is not defined, the charger IC send back NACK and go back to the idle state.

**8.2.16.7 Multi-Read and Multi-Write**

The charger device supports multi-read and multi-write on REG00 through REG14 except REG0C.



**Figure 8-15. Multi-Write**

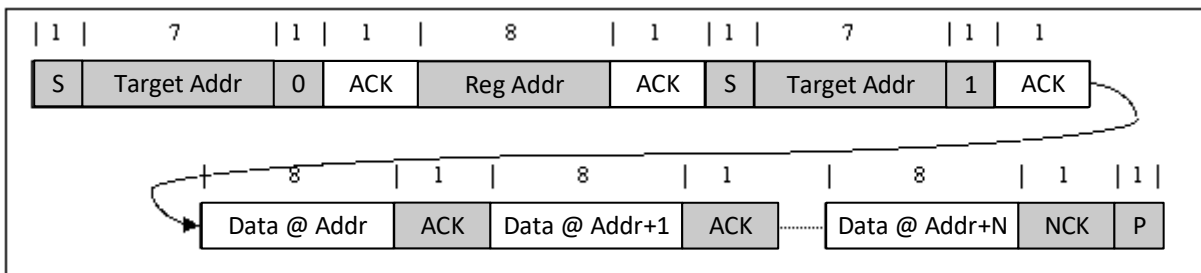

**Figure 8-16. Multi-Read**

REG0C is a fault register. It keeps all the fault information from last read until the host issues a new read. For example, if Charge Safety Timer Expiration fault occurs but recovers later, the fault register REG0C reports the fault when it is read the first time, but returns to normal when it is read the second time. In order to get the fault information at present, the host has to read REG0C for the second time. The only exception is NTC\_FAULT which always reports the actual condition on the TS pin. In addition, REG0C does not support multi-read and multi-write.

## 8.3 Device Functional Modes

### 8.3.1 Host Mode and Default Mode

The device is a host controlled charger, but it can operate in default mode without host management. In default mode, the device can be used as an autonomous charger with no host or while host is in sleep mode. When the charger is in default mode, WATCHDOG\_FAULT bit is HIGH. When the charger is in host mode, WATCHDOG\_FAULT bit is LOW.

After power-on-reset, the device starts in default mode with watchdog timer expired, or default mode. All the registers are in the default settings.

In default mode, the device keeps charging the battery with 12-hour fast charging safety timer. At the end of the 12-hour, the charging is stopped and the buck converter continues to operate to supply system load. Any write command to device transitions the charger from default mode to host mode. All the device parameters can be programmed by the host. To keep the device in host mode, the host has to reset the watchdog timer by writing 1 to WD\_RST bit before the watchdog timer expires (WATCHDOG\_FAULT bit is set), or disable watchdog timer by setting WATCHDOG bits=00.

When the watchdog timer (WATCHDOG\_FAULT bit = 1) is expired, the device returns to default mode and all registers are reset to default values except IINLIM, VINDPM, VINDPM\_OS, BATFET\_RST\_EN, BATFET\_DLY, and BATFET\_DIS bits.

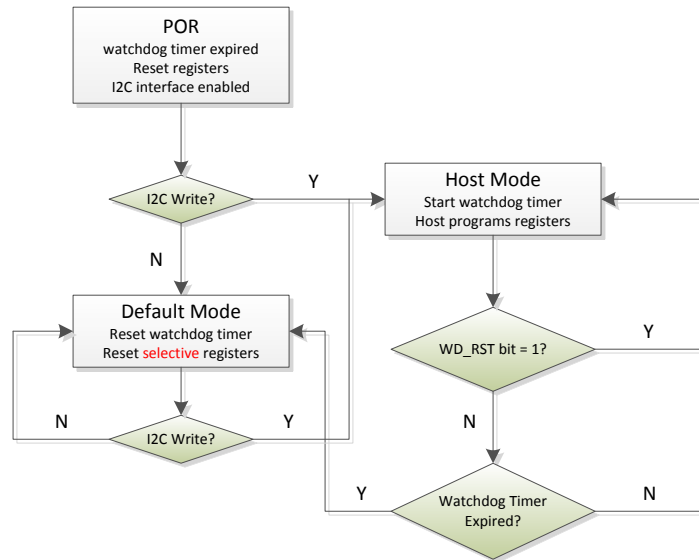

**Figure 8-17. Watchdog Timer Flow Chart**

## 8.4 Register Maps

I2C Target Address: 6AH (1101010B + R/  $\overline{W}$ )

### 8.4.1 REG00

**Figure 8-18. REG00**

| 7   | 6   | 5   | 4   | 3   | 2   | 1   | 0   |
|-----|-----|-----|-----|-----|-----|-----|-----|
| 0   | 0   | 0   | 0   | 1   | 0   | 0   | 0   |
| R/W | R/W | R/W | R/W | R/W | R/W | R/W | R/W |

LEGEND: R/W = Read/Write; R = Read only; -n = value after reset

**Table 8-8. REG00**

| Bit | Field     | Type | Reset                     | Description                                                                 |
|-----|-----------|------|---------------------------|-----------------------------------------------------------------------------|
| 7   | EN_HIZ    | R/W  | by REG_RST<br>by Watchdog | Enable HIZ Mode<br>0 – Disable (default)<br>1 – Enable                      |
| 6   | EN_ILIM   | R/W  | by REG_RST<br>by Watchdog | Enable ILIM Pin<br>0 – Disable<br>1 – Enable (default: Enable ILIM pin (1)) |
| 5   | IINLIM[5] | R/W  | by REG_RST                | 1600mA                                                                      |
| 4   | IINLIM[4] | R/W  | by REG_RST                | 800mA                                                                       |
| 3   | IINLIM[3] | R/W  | by REG_RST                | 400mA                                                                       |
| 2   | IINLIM[2] | R/W  | by REG_RST                | 200mA                                                                       |
| 1   | IINLIM[1] | R/W  | by REG_RST                | 100mA                                                                       |
| 0   | IINLIM[0] | R/W  | by REG_RST                | 50mA                                                                        |

Input Current Limit  
Offset: 100mA  
Range: 100mA (000000) – 3.25A (111111)  
Default: 0001000 (500mA)  
(Actual input current limit is the lower of I2C or ILIM pin)  
IINLIM bits are changed automatically after input source type detection is completed  
USB Host SDP w/ OTG=Hi (USB500) = 500mA  
USB Host SDP w/ OTG=Lo (USB100) = 500mA  
USB CDP = 1.5A  
USB DCP = 3.25A  
Adjustable High Voltage (MaxCharge) DCP = 1.5A  
Unknown Adapter = 500mA  
Non-Standard Adapter = 1A/2A/2.1A/2.4A



### 8.4.2 REG01

**Figure 8-19. REG01**

| 7   | 6   | 5   | 4   | 3   | 2   | 1   | 0   |
|-----|-----|-----|-----|-----|-----|-----|-----|
| 0   | 0   | 0   | 0   | 0   | 1   | 0   | 1   |
| R/W | R/W | R/W | R/W | R/W | R/W | R/W | R/W |

LEGEND: R/W = Read/Write; R = Read only; -n = value after reset

**Table 8-9. REG01**

| Bit | Field        | Type | Reset                     | Description                                                                                                                                                                                                                                                                                                                                                       |
|-----|--------------|------|---------------------------|-------------------------------------------------------------------------------------------------------------------------------------------------------------------------------------------------------------------------------------------------------------------------------------------------------------------------------------------------------------------|
| 7   | BHOT[1]      | R/W  | by REG_RST<br>by Watchdog | Boost Mode Hot Temperature Monitor Threshold<br>00 – V <sub>BHOT1</sub> Threshold (34.75%) (default)<br>01 – V <sub>BHOT0</sub> Threshold (Typ. 37.75%)<br>10 – V <sub>BHOT2</sub> Threshold (Typ. 31.25%)<br>11 – Disable boost mode thermal protection                                                                                                          |
| 6   | BHOT[0]      | R/W  | by REG_RST<br>by Watchdog |                                                                                                                                                                                                                                                                                                                                                                   |
| 5   | BCOLD        | R/W  | by REG_RST<br>by Watchdog | Boost Mode Cold Temperature Monitor Threshold<br>0 – V <sub>BCOLD0</sub> Threshold (Typ. 77%) (default)<br>1 – V <sub>BCOLD1</sub> Threshold (Typ. 80%)                                                                                                                                                                                                           |
| 4   | VINDPM_OS[4] | R/W  | by REG_RST                | Input Voltage Limit Offset<br>Default: 500mV (00101)<br>Range: 0mV – 3100mV<br>Minimum VINDPM threshold is clamped at 3.9V<br>Maximum VINDPM threshold is clamped at 15.3V<br>When VBUS at noLoad is ≤ 6V, the VINDPM_OS is used to calculate VINDPM threshold<br>When VBUS at noLoad is > 6V, the VINDPM_OS multiple by 2 is used to calculate VINDPM threshold. |
| 3   | VINDPM_OS[3] | R/W  | by REG_RST                |                                                                                                                                                                                                                                                                                                                                                                   |
| 2   | VINDPM_OS[2] | R/W  | by REG_RST                |                                                                                                                                                                                                                                                                                                                                                                   |
| 1   | VINDPM_OS[1] | R/W  | by REG_RST                |                                                                                                                                                                                                                                                                                                                                                                   |
| 0   | VINDPM_OS[0] | R/W  | by REG_RST                |                                                                                                                                                                                                                                                                                                                                                                   |

### 8.4.3 REG02

**Figure 8-20. REG02**

| 7   | 6   | 5   | 4   | 3   | 2   | 1   | 0   |
|-----|-----|-----|-----|-----|-----|-----|-----|
| 0   | 0   | 1   | 1   | 1   | 1   | 0   | 1   |
| R/W | R/W | R/W | R/W | R/W | R/W | R/W | R/W |

LEGEND: R/W = Read/Write; R = Read only; -n = value after reset

**Table 8-10. REG02**

| Bit | Field        | Type | Reset                     | Description                                                                                                                                                                                                                   |
|-----|--------------|------|---------------------------|-------------------------------------------------------------------------------------------------------------------------------------------------------------------------------------------------------------------------------|
| 7   | CONV_START   | R/W  | by REG_RST<br>by Watchdog | ADC Conversion Start Control<br>0 – ADC conversion not active (default).<br>1 – Start ADC Conversion<br>This bit is read-only when CONV_RATE = 1. The bit stays high during ADC conversion and during input source detection. |
| 6   | CONV_RATE    | R/W  | by REG_RST<br>by Watchdog | ADC Conversion Rate Selection<br>0 – One shot ADC conversion (default)<br>1 – Start 1s Continuous Conversion                                                                                                                  |
| 5   | BOOST_FREQ   | R/W  | by REG_RST<br>by Watchdog | Boost Mode Frequency Selection<br>0 – 1.5MHz<br>1 – 500KHz (default)<br>Note: Write to this bit is ignored when OTG_CONFIG is enabled.                                                                                        |
| 4   | ICO_EN       | R/W  | by REG_RST                | Input Current Optimizer (ICO) Enable<br>0 – Disable ICO Algorithm<br>1 – Enable ICO Algorithm (default)                                                                                                                       |
| 3   | HVDCP_EN     | R/W  | by REG_RST                | High Voltage DCP Enable<br>0 – Disable HVDCP handshake<br>1 – Enable HVDCP handshake (default)                                                                                                                                |
| 2   | MAXC_EN      | R/W  | by REG_RST                | MaxCharge Adapter Enable<br>0 – Disable MaxCharge handshake<br>1 – Enable MaxCharge handshake (default)                                                                                                                       |
| 1   | FORCE_DPDM   | R/W  | by REG_RST<br>by Watchdog | Force D+/D- Detection<br>0 – Not in D+/D- or PSEL detection (default)<br>1 – Force D+/D- detection                                                                                                                            |
| 0   | AUTO_DPDM_EN | R/W  | by REG_RST                | Automatic D+/D- Detection Enable<br>0 –Disable D+/D- or PSEL detection when VBUS is plugged-in<br>1 –Enable D+/D- or PEL detection when VBUS is plugged-in (default)                                                          |

### 8.4.4 REG03

**Figure 8-21. REG03**

| 7   | 6   | 5   | 4   | 3   | 2   | 1   | 0  |
|-----|-----|-----|-----|-----|-----|-----|----|
| 0   | 0   | 1   | 1   | 1   | 0   | 1   | 0  |
| R/W | R/W | R/W | R/W | R/W | R/W | R/W | RW |

LEGEND: R/W = Read/Write; R = Read only; -n = value after reset

**Table 8-11. REG03**

| Bit | Field      | Type | Reset                     | Description                                                                                 |
|-----|------------|------|---------------------------|---------------------------------------------------------------------------------------------|
| 7   | BAT_LOADEN | R/W  | by REG_RST<br>by Watchdog | Battery Load (I <sub>BATLOAD</sub> ) Enable<br>0 – Disabled (default)<br>1 – Enabled        |
| 6   | WD_RST     | R/W  | by REG_RST<br>by Watchdog | I2C Watchdog Timer Reset<br>0 – Normal (default)<br>1 – Reset (Back to 0 after timer reset) |
| 5   | OTG_CONFIG | R/W  | by REG_RST<br>by Watchdog | Boost (OTG) Mode Configuration<br>0 – OTG Disable<br>1 – OTG Enable (default)               |
| 4   | CHG_CONFIG | R/W  | by REG_RST<br>by Watchdog | Charge Enable Configuration<br>0 – Charge Disable<br>1 – Charge Enable (default)            |
| 3   | SYS_MIN[2] | R/W  | by REG_RST                | 0.4V                                                                                        |
| 2   | SYS_MIN[1] | R/W  | by REG_RST                | 0.2V                                                                                        |
| 1   | SYS_MIN[0] | R/W  | by REG_RST                | 0.1V                                                                                        |
| 0   | Reserved   | R/W  | by REG_RST<br>by Watchdog | Reserved (default = 0)                                                                      |

### 8.4.5 REG04

**Figure 8-22. REG04**

| 7   | 6   | 5   | 4   | 3   | 2   | 1   | 0   |
|-----|-----|-----|-----|-----|-----|-----|-----|
| 0   | 0   | 1   | 0   | 0   | 0   | 0   | 0   |
| R/W | R/W | R/W | R/W | R/W | R/W | R/W | R/W |

LEGEND: R/W = Read/Write; R = Read only; -n = value after reset

**Table 8-12. REG04**

| Bit | Field    | Type | Reset                      | Description                                                                                                                            |
|-----|----------|------|----------------------------|----------------------------------------------------------------------------------------------------------------------------------------|
| 7   | EN_PUMPX | R/W  | by Software<br>by Watchdog | Current pulse control Enable<br>0 - Disable Current pulse control (default)<br>1- Enable Current pulse control (PUMPX_UP and PUMPX_DN) |
| 6   | ICHG[6]  | R/W  | by Software<br>by Watchdog | 4096mA                                                                                                                                 |
| 5   | ICHG[5]  | R/W  | by Software<br>by Watchdog | 2048mA                                                                                                                                 |
| 4   | ICHG[4]  | R/W  | by Software<br>by Watchdog | 1024mA                                                                                                                                 |
| 3   | ICHG[3]  | R/W  | by Software<br>by Watchdog | 512mA                                                                                                                                  |
| 2   | ICHG[2]  | R/W  | by Software<br>by Watchdog | 256mA                                                                                                                                  |
| 1   | ICHG[1]  | R/W  | by Software<br>by Watchdog | 128mA                                                                                                                                  |
| 0   | ICHG[0]  | R/W  | by Software<br>by Watchdog | 64mA                                                                                                                                   |

Fast Charge Current Limit  
Offset: 0mA  
Range: 0mA (0000000) – 5056mA (1001111)  
Default: 2048mA (0100000)  
Note:  
ICHG=000000 (0mA) disables charge  
ICHG > 1001111 (5056mA) is clamped to register value  
1001111 (5056mA)

### 8.4.6 REG05

**Figure 8-23. REG05**

|     |     |     |     |     |     |     |     |
|-----|-----|-----|-----|-----|-----|-----|-----|
| 7   | 6   | 5   | 4   | 3   | 2   | 1   | 0   |
| 0   | 0   | 0   | 1   | 0   | 0   | 1   | 1   |
| R/W | R/W | R/W | R/W | R/W | R/W | R/W | R/W |

LEGEND: R/W = Read/Write; R = Read only; -n = value after reset

**Table 8-13. REG05**

| Bit | Field      | Type | Reset                      | Description |                                                                                            |
|-----|------------|------|----------------------------|-------------|--------------------------------------------------------------------------------------------|
| 7   | IPRECHG[3] | R/W  | by Software<br>by Watchdog | 512mA       | Precharge Current Limit<br>Offset: 64mA<br>Range: 64mA – 1024mA<br>Default: 128mA (0001)   |
| 6   | IPRECHG[2] | R/W  | by Software<br>by Watchdog | 256mA       |                                                                                            |
| 5   | IPRECHG[1] | R/W  | by Software<br>by Watchdog | 128mA       |                                                                                            |
| 4   | IPRECHG[0] | R/W  | by Software<br>by Watchdog | 64mA        |                                                                                            |
| 3   | ITERM[3]   | R/W  | by Software<br>by Watchdog | 512mA       | Termination Current Limit<br>Offset: 64mA<br>Range: 64mA – 1024mA<br>Default: 256mA (0011) |
| 2   | ITERM[2]   | R/W  | by Software<br>by Watchdog | 256mA       |                                                                                            |
| 1   | ITERM[1]   | R/W  | by Software<br>by Watchdog | 128mA       |                                                                                            |
| 0   | ITERM[0]   | R/W  | by Software<br>by Watchdog | 64mA        |                                                                                            |

## 8.4.7 REG06

Figure 8-24. REG06

| 7   | 6   | 5   | 4   | 3   | 2   | 1   | 0   |
|-----|-----|-----|-----|-----|-----|-----|-----|
| 0   | 1   | 0   | 1   | 1   | 1   | 1   | 0   |
| R/W | R/W | R/W | R/W | R/W | R/W | R/W | R/W |

LEGEND: R/W = Read/Write; R = Read only; -n = value after reset

Table 8-14. REG06

| Bit | Field   | Type | Reset                      | Description                                                                                                                                                                                       |
|-----|---------|------|----------------------------|---------------------------------------------------------------------------------------------------------------------------------------------------------------------------------------------------|
| 7   | VREG[5] | R/W  | by Software<br>by Watchdog | 512mV                                                                                                                                                                                             |
| 6   | VREG[4] | R/W  | by Software<br>by Watchdog | 256mV                                                                                                                                                                                             |
| 5   | VREG[3] | R/W  | by Software<br>by Watchdog | 128mV                                                                                                                                                                                             |
| 4   | VREG[2] | R/W  | by Software<br>by Watchdog | 64mV                                                                                                                                                                                              |
| 3   | VREG[1] | R/W  | by Software<br>by Watchdog | 32mV                                                                                                                                                                                              |
| 2   | VREG[0] | R/W  | by Software<br>by Watchdog | 16mV                                                                                                                                                                                              |
| 1   | BATLOWV | R/W  | by Software<br>by Watchdog | Battery Precharge to Fast Charge Threshold<br>0 – 2.8V<br>1 – 3.0V (default)                                                                                                                      |
| 0   | VRECHG  | R/W  | by Software<br>by Watchdog | Battery Recharge Threshold Offset<br>(below Charge Voltage Limit)<br>0 – 100mV (V <sub>RECHG</sub> ) below VREG (REG06[7:2]) (default)<br>1 – 200mV (V <sub>RECHG</sub> ) below VREG (REG06[7:2]) |

### 8.4.8 REG07

**Figure 8-25. REG07**

|          |          |          |          |          |          |          |          |
|----------|----------|----------|----------|----------|----------|----------|----------|
| <b>7</b> | <b>6</b> | <b>5</b> | <b>4</b> | <b>3</b> | <b>2</b> | <b>1</b> | <b>0</b> |
| 1        | 0        | 0        | 1        | 1        | 1        | 0        | 1        |
| R/W      | R/W      | R/W      | R/W      | R/W      | R/W      | R/W      | R/W      |

LEGEND: R/W = Read/Write; R = Read only; -n = value after reset

**Table 8-15. REG07**

| Bit | Field        | Type | Reset                      | Description                                                                                              |
|-----|--------------|------|----------------------------|----------------------------------------------------------------------------------------------------------|
| 7   | EN_TERM      | R/W  | by Software<br>by Watchdog | Charging Termination Enable<br>0 – Disable<br>1 – Enable (default)                                       |
| 6   | STAT_DIS     | R/W  | by Software<br>by Watchdog | STAT Pin Disable<br>0 – Enable STAT pin function (default)<br>1 – Disable STAT pin function              |
| 5   | WATCHDOG[1]  | R/W  | by Software<br>by Watchdog | I2C Watchdog Timer Setting<br>00 – Disable watchdog timer<br>01 – 40s (default)<br>10 – 80s<br>11 – 160s |
| 4   | WATCHDOG[0]  | R/W  | by Software<br>by Watchdog |                                                                                                          |
| 3   | EN_TIMER     | R/W  | by Software<br>by Watchdog | Charging Safety Timer Enable<br>0 – Disable<br>1 – Enable (default)                                      |
| 2   | CHG_TIMER[1] | R/W  | by Software<br>by Watchdog | Fast Charge Timer Setting<br>00 – 5 hrs<br>01 – 8 hrs<br>10 – 12 hrs (default)<br>11 – 20 hrs            |
| 1   | CHG_TIMER[0] | R/W  | by Software<br>by Watchdog |                                                                                                          |
| 0   | Reserved     | R/W  |                            | Reserved (Default = 1)                                                                                   |

### 8.4.9 REG08

**Figure 8-26. REG08**

| 7   | 6   | 5   | 4   | 3   | 2   | 1   | 0   |
|-----|-----|-----|-----|-----|-----|-----|-----|
| 0   | 0   | 0   | 0   | 0   | 0   | 1   | 1   |
| R/W | R/W | R/W | R/W | R/W | R/W | R/W | R/W |

LEGEND: R/W = Read/Write; R = Read only; -n = value after reset

**Table 8-16. REG08**

| Bit | Field       | Type | Reset                      | Description                                                                                  |
|-----|-------------|------|----------------------------|----------------------------------------------------------------------------------------------|
| 7   | BAT_COMP[2] | R/W  | by Software<br>by Watchdog | 80mΩ                                                                                         |
| 6   | BAT_COMP[1] | R/W  | by Software<br>by Watchdog | 40mΩ                                                                                         |
| 5   | BAT_COMP[0] | R/W  | by Software<br>by Watchdog | 20mΩ                                                                                         |
| 4   | VCLAMP[2]   | R/W  | by Software<br>by Watchdog | 128mV                                                                                        |
| 3   | VCLAMP[1]   | R/W  | by Software<br>by Watchdog | 64mV                                                                                         |
| 2   | VCLAMP[0]   | R/W  | by Software<br>by Watchdog | 32mV                                                                                         |
| 1   | TREG[1]     | R/W  | by Software<br>by Watchdog | Thermal Regulation Threshold<br>00 – 60°C<br>01 – 80°C<br>10 – 100°C<br>11 – 120°C (default) |
| 0   | TREG[0]     | R/W  | by Software<br>by Watchdog |                                                                                              |



### 8.4.10 REG09

**Figure 8-27. REG09**

| 7   | 6   | 5   | 4   | 3   | 2   | 1   | 0   |
|-----|-----|-----|-----|-----|-----|-----|-----|
| 0   | 1   | 0   | 0   | 0   | 1   | 0   | 0   |
| R/W | R/W | R/W | R/W | R/W | R/W | R/W | R/W |

LEGEND: R/W = Read/Write; R = Read only; -n = value after reset

**Table 8-17. REG09**

| Bit | Field         | Type | Reset                      | Description                                                                                                                                                                                                          |
|-----|---------------|------|----------------------------|----------------------------------------------------------------------------------------------------------------------------------------------------------------------------------------------------------------------|
| 7   | FORCE_ICO     | R/W  | by Software<br>by Watchdog | Force Start Input Current Optimizer (ICO)<br>0 – Do not force ICO (default)<br>1 – Force ICO<br>Note:<br>This bit is can only be set only and always returns to 0 after ICO starts                                   |
| 6   | TMR2X_EN      | R/W  | by Software<br>by Watchdog | Safety Timer Setting during DPM or Thermal Regulation<br>0 – Safety timer not slowed by 2X during input DPM or thermal regulation<br>1 – Safety timer slowed by 2X during input DPM or thermal regulation (default)  |
| 5   | BATFET_DIS    | R/W  | by Software                | Force BATFET off to enable ship mode<br>0 – Allow BATFET turn on (default)<br>1 – Force BATFET off                                                                                                                   |
| 4   | Reserved      | R/W  |                            | Reserved (Default = 0)                                                                                                                                                                                               |
| 3   | BATFET_DLY    | R/W  | by Software                | BATFET turn off delay control<br>0 – BATFET turn off immediately when BATFET_DIS bit is set (default)<br>1 – BATFET turn off delay by $t_{SM\_DLY}$ when BATFET_DIS bit is set                                       |
| 2   | BATFET_RST_EN | R/W  | by Software                | BATFET full system reset enable<br>0 – Disable BATFET full system reset<br>1 – Enable BATFET full system reset (default)                                                                                             |
| 1   | PUMPX_UP      | R/W  | by Software<br>by Watchdog | Current pulse control voltage up enable<br>0 – Disable (default)<br>1 – Enable<br>Note:<br>This bit is can only be set when EN_PUMPX bit is set and returns to 0 after current pulse control sequence is completed   |
| 0   | PUMPX_DN      | R/W  | by Software<br>by Watchdog | Current pulse control voltage down enable<br>0 – Disable (default)<br>1 – Enable<br>Note:<br>This bit is can only be set when EN_PUMPX bit is set and returns to 0 after current pulse control sequence is completed |

## 8.4.11 REG0A

Figure 8-28. REG0A

| 7   | 6   | 5   | 4   | 3   | 2   | 1   | 0   |
|-----|-----|-----|-----|-----|-----|-----|-----|
| 1   | 0   | 0   | 1   | 0   | 0   | 1   | 1   |
| R/W | R/W | R/W | R/W | R/W | R/W | R/W | R/W |

LEGEND: R/W = Read/Write; R = Read only; -n = value after reset

Table 8-18. REG0A

| Bit | Field     | Type | Reset                      | Description            |
|-----|-----------|------|----------------------------|------------------------|
| 7   | BOOSTV[3] | R/W  | by Software<br>by Watchdog | 512mV                  |
| 6   | BOOSTV[2] | R/W  | by Software<br>by Watchdog | 256mV                  |
| 5   | BOOSTV[1] | R/W  | by Software                | 128mV                  |
| 4   | BOOSTV[0] | R/W  | by Software<br>by Watchdog | 64mV                   |
| 3   | Reserved  | R/W  | by Software<br>by Watchdog | Reserved (default = 0) |
| 2   | Reserved  | R/W  | by Software<br>by Watchdog | Reserved (default = 0) |
| 1   | Reserved  | R/W  | by Software<br>by Watchdog | Reserved (default = 1) |
| 0   | Reserved  | R/W  | by Software<br>by Watchdog | Reserved (default = 1) |

## 8.4.12 REG0B

**Figure 8-29. REG0B**

| 7 | 6 | 5 | 4 | 3 | 2 | 1 | 0 |
|---|---|---|---|---|---|---|---|
| x | x | x | x | x | x | x | x |
| R | R | R | R | R | R | R | R |

LEGEND: R/W = Read/Write; R = Read only; -n = value after reset

**Table 8-19. REG0B**

| Bit | Field        | Type | Reset | Description                                                                                                                                                                                                                                                  |
|-----|--------------|------|-------|--------------------------------------------------------------------------------------------------------------------------------------------------------------------------------------------------------------------------------------------------------------|
| 7   | VBUS_STAT[2] | R    | N/A   | VBUS Status register                                                                                                                                                                                                                                         |
| 6   | VBUS_STAT[1] | R    | N/A   | BQ25895<br>000: No Input 001: USB Host SDP                                                                                                                                                                                                                   |
| 5   | VBUS_STAT[0] | R    | N/A   | 010: USB CDP (1.5A)<br>011: USB DCP (3.25A)<br>100: Adjustable High Voltage DCP (MaxCharge) (1.5A)<br>101: Unknown Adapter (500mA)<br>110: Non-Standard Adapter (1A/2A/2.1A/2.4A)<br>111: OTG<br>Note: Software current limit is reported in IINLIM register |
| 4   | CHRG_STAT[1] | R    | N/A   | Charging Status<br>00 – Not Charging                                                                                                                                                                                                                         |
| 3   | CHRG_STAT[0] | R    | N/A   | 01 – Pre-charge ( $< V_{BATLOWV}$ )<br>10 – Fast Charging<br>11 – Charge Termination Done                                                                                                                                                                    |
| 2   | PG_STAT      | R    | N/A   | Power Good Status<br>0 – Not Power Good<br>1 – Power Good                                                                                                                                                                                                    |
| 1   | SDP_STAT     | R    | N/A   | USB Input Status<br>0 – USB100 input is detected<br>1 – USB500 input is detected<br>Note: This bit always read 1 when VBUS_STAT is not 001                                                                                                                   |
| 0   | VSYS_STAT    | R    | N/A   | VSYS Regulation Status<br>0 – Not in VSYSMIN regulation (BAT > VSYSMIN)<br>1 – In VSYSMIN regulation (BAT < VSYSMIN)                                                                                                                                         |

## 8.4.13 REG0C

Figure 8-30. REG0C

| 7 | 6 | 5 | 4 | 3 | 2 | 1 | 0 |
|---|---|---|---|---|---|---|---|
| x | x | x | x | x | x | x | x |
| R | R | R | R | R | R | R | R |

LEGEND: R/W = Read/Write; R = Read only; -n = value after reset

Table 8-20. REG0C

| Bit | Field          | Type | Reset | Description                                                                                                                                                                                         |
|-----|----------------|------|-------|-----------------------------------------------------------------------------------------------------------------------------------------------------------------------------------------------------|
| 7   | WATCHDOG_FAULT | R    | N/A   | Watchdog Fault Status<br>Status 0 – Normal<br>1- Watchdog timer expiration                                                                                                                          |
| 6   | BOOST_FAULT    | R    | N/A   | Boost Mode Fault Status<br>0 – Normal<br>1 – VBUS overloaded in OTG, or VBUS OVP, or battery is too low in boost mode                                                                               |
| 5   | CHRG_FAULT[1]  | R    | N/A   | Charge Fault Status<br>00 – Normal<br>01 – Input fault ( $V_{BUS} > V_{ACOV}$ or $V_{BAT} < V_{BUS} < V_{VBUSMIN}$ (typical 3.8V) )<br>10 - Thermal shutdown<br>11 – Charge Safety Timer Expiration |
| 4   | CHRG_FAULT[0]  | R    | N/A   |                                                                                                                                                                                                     |
| 3   | BAT_FAULT      | R    | N/A   | Battery Fault Status<br>0 – Normal<br>1 – BATOVP ( $V_{BAT} > V_{BATOVP}$ )                                                                                                                         |
| 2   | NTC_FAULT[2]   | R    | N/A   | NTC Fault Status<br>Buck Mode:<br>000 – Normal<br>001 – TS Cold<br>010 – TS Hot<br>Boost Mode:<br>000 – Normal<br>101 – TS Cold<br>110 – TS Hot                                                     |
| 1   | NTC_FAULT[1]   | R    | N/A   |                                                                                                                                                                                                     |
| 0   | NTC_FAULT[0]   | R    | N/A   |                                                                                                                                                                                                     |

### 8.4.14 REG0D

**Figure 8-31. REG0D**

| 7   | 6   | 5   | 4   | 3   | 2   | 1   | 0   |
|-----|-----|-----|-----|-----|-----|-----|-----|
| 0   | 0   | 0   | 1   | 0   | 0   | 1   | 0   |
| R/W | R/W | R/W | R/W | R/W | R/W | R/W | R/W |

LEGEND: R/W = Read/Write; R = Read only; -n = value after reset

**Table 8-21. REG0D**

| Bit | Field        | Type | Reset       | Description                                                                                                                          |
|-----|--------------|------|-------------|--------------------------------------------------------------------------------------------------------------------------------------|
| 7   | FORCE_VINDPM | R/W  | by Software | VINDPM Threshold Setting Method<br>0 – Run Relative VINDPM Threshold (default)<br>1 – Run Absolute VINDPM Threshold                  |
| 6   | VINDPM[6]    | R/W  | by Software | 6400mV<br>Absolute VINDPM Threshold                                                                                                  |
| 5   | VINDPM[5]    | R/W  | by Software | 3200mV<br>Offset: 2.6V                                                                                                               |
| 4   | VINDPM[4]    | R/W  | by Software | 1600mV<br>Range: 3.9V (0001101) – 15.3V (1111111)<br>Default: 4.4V (0010010)                                                         |
| 3   | VINDPM[3]    | R/W  | by Software | 800mV<br>Note:<br>Value < 0001101 is clamped to 3.9V (0001101)                                                                       |
| 2   | VINDPM[2]    | R/W  | by Software | 400mV<br>Register is read only when FORCE_VINDPM=0 and can be written by internal control based on relative VINDPM threshold setting |
| 1   | VINDPM[1]    | R/W  | by Software | 200mV                                                                                                                                |
| 0   | VINDPM[0]    | R/W  | by Software | 100mV<br>Register can be read/write when FORCE_VINDPM = 1                                                                            |

### 8.4.15 REG0E

**Figure 8-32. REG0E**

| 7 | 6 | 5 | 4 | 3 | 2 | 1 | 0 |
|---|---|---|---|---|---|---|---|
| 0 | 0 | 0 | 0 | 0 | 0 | 0 | 0 |
| R | R | R | R | R | R | R | R |

LEGEND: R/W = Read/Write; R = Read only; -n = value after reset

**Table 8-22. REG0E**

| Bit | Field      | Type | Reset | Description                                                          |
|-----|------------|------|-------|----------------------------------------------------------------------|
| 7   | THERM_STAT | R    | N/A   | Thermal Regulation Status<br>0 – Normal<br>1 – In Thermal Regulation |
| 6   | BATV[6]    | R    | N/A   | 1280mV                                                               |
| 5   | BATV[5]    | R    | N/A   | 640mV                                                                |
| 4   | BATV[4]    | R    | N/A   | 320mV                                                                |
| 3   | BATV[3]    | R    | N/A   | 160mV                                                                |
| 2   | BATV[2]    | R    | N/A   | 80mV                                                                 |
| 1   | BATV[1]    | R    | N/A   | 40mV                                                                 |
| 0   | BATV[0]    | R    | N/A   | 20mV                                                                 |

ADC conversion of Battery Voltage ( $V_{BAT}$ )  
Offset: 2.304V  
Range: 2.304V (0000000) – 4.848V (1111111)  
Default: 2.304V (0000000)

### 8.4.16 REG0F

**Figure 8-33. REG0F**

| 7 | 6 | 5 | 4 | 3 | 2 | 1 | 0 |
|---|---|---|---|---|---|---|---|
| 0 | 0 | 0 | 0 | 0 | 0 | 0 | 0 |
| R | R | R | R | R | R | R | R |

LEGEND: R/W = Read/Write; R = Read only; -n = value after reset

**Table 8-23. REG0F**

| Bit | Field    | Type | Reset | Description              |
|-----|----------|------|-------|--------------------------|
| 7   | Reserved | R    | N/A   | Reserved: Always reads 0 |
| 6   | SYSV[6]  | R    | N/A   | 1280mV                   |
| 5   | SYSV[5]  | R    | N/A   | 640mV                    |
| 4   | SYSV[4]  | R    | N/A   | 320mV                    |
| 3   | SYSV[3]  | R    | N/A   | 160mV                    |
| 2   | SYSV[2]  | R    | N/A   | 80mV                     |
| 1   | SYSV[1]  | R    | N/A   | 40mV                     |
| 0   | SYSV[0]  | R    | N/A   | 20mV                     |

ADDC conversion of System Voltage (V<sub>sys</sub>)  
Offset: 2.304V  
Range: 2.304V (0000000) – 4.848V (1111111)  
Default: 2.304V (0000000)

### 8.4.17 REG10

**Figure 8-34. REG10**

| 7 | 6 | 5 | 4 | 3 | 2 | 1 | 0 |
|---|---|---|---|---|---|---|---|
| 0 | 0 | 0 | 0 | 0 | 0 | 0 | 0 |
| R | R | R | R | R | R | R | R |

LEGEND: R/W = Read/Write; R = Read only; -n = value after reset

**Table 8-24. REG10**

| Bit | Field    | Type | Reset | Description              |
|-----|----------|------|-------|--------------------------|
| 7   | Reserved | R    | N/A   | Reserved: Always reads 0 |
| 6   | TSPCT[6] | R    | N/A   | 29.76%                   |
| 5   | TSPCT[5] | R    | N/A   | 14.88%                   |
| 4   | TSPCT[4] | R    | N/A   | 7.44%                    |
| 3   | TSPCT[3] | R    | N/A   | 3.72%                    |
| 2   | TSPCT[2] | R    | N/A   | 1.86%                    |
| 1   | TSPCT[1] | R    | N/A   | 0.93%                    |
| 0   | TSPCT[0] | R    | N/A   | 0.465%                   |

ADC conversion of TS Voltage (TS) as percentage of REGN  
Offset: 21%  
Range 21% (0000000) – 80% (1111111)  
Default: 21% (0000000)

### 8.4.18 REG11

**Figure 8-35. REG11**

| 7 | 6 | 5 | 4 | 3 | 2 | 1 | 0 |
|---|---|---|---|---|---|---|---|
| 0 | 0 | 0 | 0 | 0 | 0 | 0 | 0 |
| R | R | R | R | R | R | R | R |

LEGEND: R/W = Read/Write; R = Read only; -n = value after reset

**Table 8-25. REG11**

| Bit | Field    | Type | Reset | Description                                                    |
|-----|----------|------|-------|----------------------------------------------------------------|
| 7   | VBUS_GD  | R    | N/A   | VBUS Good Status<br>0 – Not VBUS attached<br>1 – VBUS Attached |
| 6   | VBUSV[6] | R    | N/A   | 6400mV                                                         |
| 5   | VBUSV[5] | R    | N/A   | 3200mV                                                         |
| 4   | VBUSV[4] | R    | N/A   | 1600mV                                                         |
| 3   | VBUSV[3] | R    | N/A   | 800mV                                                          |
| 2   | VBUSV[2] | R    | N/A   | 400mV                                                          |
| 1   | VBUSV[1] | R    | N/A   | 200mV                                                          |
| 0   | VBUSV[0] | R    | N/A   | 100mV                                                          |

ADC conversion of VBUS voltage ( $V_{BUS}$ )  
Offset: 2.6V  
Range 2.6V (0000000) – 15.3V (1111111)  
Default: 2.6V (0000000)

### 8.4.19 REG12

**Figure 8-36. REG12**

| 7 | 6 | 5 | 4 | 3 | 2 | 1 | 0 |
|---|---|---|---|---|---|---|---|
| 0 | 0 | 0 | 0 | 0 | 0 | 0 | 0 |
| R | R | R | R | R | R | R | R |

LEGEND: R/W = Read/Write; R = Read only; -n = value after reset

**Table 8-26. REG12**

| Bit | Field    | Type | Reset | Description    |
|-----|----------|------|-------|----------------|
| 7   | Unused   | R    | N/A   | Always reads 0 |
| 6   | ICHGR[6] | R    | N/A   | 3200mA         |
| 5   | ICHGR[5] | R    | N/A   | 1600mA         |
| 4   | ICHGR[4] | R    | N/A   | 800mA          |
| 3   | ICHGR[3] | R    | N/A   | 400mA          |
| 2   | ICHGR[2] | R    | N/A   | 200mA          |
| 1   | ICHGR[1] | R    | N/A   | 100mA          |
| 0   | ICHGR[0] | R    | N/A   | 50mA           |

ADC conversion of Charge Current ( $I_{BAT}$ ) when  $V_{BAT} > V_{BATSHORT}$   
Offset: 0mA  
Range 0mA (0000000) – 6350mA (1111111)  
Default: 0mA (0000000)  
Note:  
This register returns 0000000 for  $V_{BAT} < V_{BATSHORT}$

## 8.4.20 REG13

Figure 8-37. REG13

| 7 | 6 | 5 | 4 | 3 | 2 | 1 | 0 |
|---|---|---|---|---|---|---|---|
| 0 | 0 | 0 | 0 | 0 | 0 | 0 | 0 |
| R | R | R | R | R | R | R | R |

LEGEND: R/W = Read/Write; R = Read only; -n = value after reset

Table 8-27. REG13

| Bit | Field       | Type | Reset | Description                                      |
|-----|-------------|------|-------|--------------------------------------------------|
| 7   | VDPM_STAT   | R    | N/A   | VINDPM Status<br>0 – Not in VINDPM<br>1 – VINDPM |
| 6   | IDPM_STAT   | R    | N/A   | IINDPM Status<br>0 – Not in IINDPM<br>1 – IINDPM |
| 5   | IDPM_LIM[5] | R    | N/A   | 1600mA                                           |
| 4   | IDPM_LIM[4] | R    | N/A   | 800mA                                            |
| 3   | IDPM_LIM[3] | R    | N/A   | 400mA                                            |
| 2   | IDPM_LIM[2] | R    | N/A   | 200mA                                            |
| 1   | IDPM_LIM[1] | R    | N/A   | 100mA                                            |
| 0   | IDPM_LIM[0] | R    | N/A   | 50mA                                             |

Input Current Limit in effect while Input Current Optimizer (ICO) is enabled  
Offset: 100mA (default)  
Range 100mA (0000000) – 3.25mA (1111111)

## 8.4.21 REG14

Figure 8-38. REG14

| 7   | 6   | 5 | 4 | 3 | 2 | 1 | 0 |
|-----|-----|---|---|---|---|---|---|
| 0   | 0   | 0 | 0 | 0 | 0 | 0 | 0 |
| R/W | R/W | R | R | R | R | R | R |

LEGEND: R/W = Read/Write; R = Read only; -n = value after reset

Table 8-28. REG14

| Bit | Field         | Type | Reset | Description                                                                                                                                                                          |
|-----|---------------|------|-------|--------------------------------------------------------------------------------------------------------------------------------------------------------------------------------------|
| 7   | REG_RST       | R/W  | N/A   | Register Reset<br>0 – Keep current register setting (default)<br>1 – Reset to default register value and reset safety timer<br>Note:<br>Reset to 0 after register reset is completed |
| 6   | ICO_OPTIMIZED | R    | N/A   | Input Current Optimizer (ICO) Status<br>0 – Optimization is in progress<br>1 – Maximum Input Current Detected                                                                        |
| 5   | PN[2]         | R    | N/A   | Device Configuration<br>111: BQ25895                                                                                                                                                 |
| 4   | PN[1]         | R    | N/A   |                                                                                                                                                                                      |
| 3   | PN[0]         | R    | N/A   |                                                                                                                                                                                      |
| 2   | TS_PROFILE    | R    | N/A   | Temperature Profile<br>0 – Cold/Hot (default)                                                                                                                                        |
| 1   | DEV_REV[1]    | R    | N/A   | Device Revision: 01                                                                                                                                                                  |
| 0   | DEV_REV[0]    | R    | N/A   |                                                                                                                                                                                      |



## 9 Application and Implementation

### Note

Information in the following applications sections is not part of the TI component specification, and TI does not warrant its accuracy or completeness. TI's customers are responsible for determining suitability of components for their purposes, as well as validating and testing their design implementation to confirm system functionality.

### 9.1 Application Information

A typical application consists of the device configured as an I<sup>2</sup>C controlled power path management device and a single cell battery charger for Li-Ion and Li-polymer batteries used in a wide range of smartphones and other portable devices. It integrates an input reverse-block FET (RBFET, Q1), high-side switching FET (HSFET, Q2), low-side switching FET (LSFET, Q3), and BATFET (Q4) between the system and battery. The device also integrates a bootstrap diode for the high-side gate drive.

### 9.2 Typical Application

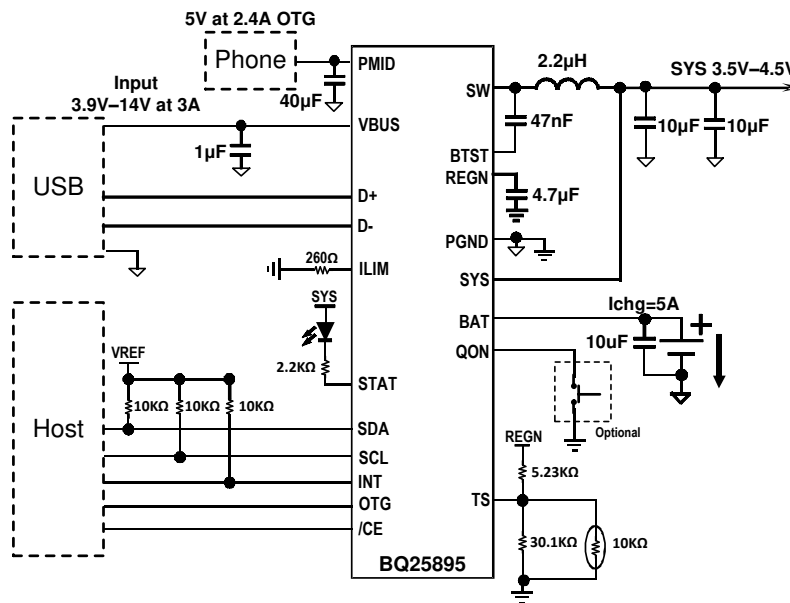

Figure 9-1. BQ25895 with D+/D- Interface and 2.4-A Boost Mode Output

#### 9.2.1 Design Requirements

For this design example, use the parameters shown in [Table 9-1](#).

Table 9-1. Design Parameter

| PARAMETERS                             | VALUES        |
|----------------------------------------|---------------|
| Input voltage range                    | 3.9 V to 14 V |
| Input current limit                    | 1.5 A         |
| Fast charge current                    | 5000 mA       |
| Output voltage                         | 4.352 V       |
| V <sub>REF</sub> system pullup voltage | 1.8 V - 3.3 V |

## 9.2.2 Detailed Design Procedure

### 9.2.2.1 Inductor Selection

The device has 1.5 MHz switching frequency to allow the use of small inductor and capacitor values. The Inductor saturation current should be higher than the charging current ( $I_{CHG}$ ) plus half the ripple current ( $I_{RIPPLE}$ ):

$$I_{BAT} \geq I_{CHG} + (1/2) I_{RIPPLE} \quad (5)$$

The inductor ripple current depends on input voltage ( $V_{BUS}$ ), duty cycle ( $D = V_{BAT}/V_{BUS}$ ), switching frequency ( $f_s$ ) and inductance ( $L$ ):

$$I_{RIPPLE} = \frac{V_{BUS} \times D \times (1-D)}{f_s \times L} \quad (6)$$

The maximum inductor ripple current happens with  $D = 0.5$  or close to 0.5. Usually inductor ripple is designed in the range of (20–40%) maximum charging current as a trade-off between inductor size and efficiency for a practical design.

### 9.2.2.2 Buck Input Capacitor

Input capacitor should have enough ripple current rating to absorb input switching ripple current. The worst case RMS ripple current is half of the charging current when duty cycle is 0.5. If the converter does not operate at 50% duty cycle, then the worst case capacitor RMS current  $I_{PMID}$  occurs where the duty cycle is closest to 50% and can be estimated by [Equation 7](#):

$$I_{PMID} = I_{CHG} \times \sqrt{D \times (1 - D)} \quad (7)$$

Low ESR ceramic capacitor such as X7R or X5R is preferred for input decoupling capacitor and should be placed to the drain of the high side MOSFET and source of the low side MOSFET as close as possible. Voltage rating of the capacitor must be higher than normal input voltage level. 25 V rating or higher capacitor is preferred for up to 14-V input voltage. 8.2- $\mu$ F capacitance is suggested for typical of 3 A – 5 A charging current.

### 9.2.2.3 System Output Capacitor

Output capacitor also should have enough ripple current rating to absorb output switching ripple current. The output capacitor RMS current  $I_{COUT}$  is given:

$$I_{CSYS} = \frac{I_{RIPPLE}}{2 \times \sqrt{3}} \approx 0.29 \times I_{RIPPLE} \quad (8)$$

The output capacitor voltage ripple can be calculated as follows:

$$\Delta V_O = \frac{V_{SYS}}{8 LC_{SYS} f_s^2} \left( 1 - \frac{V_{SYS}}{V_{BUS}} \right) \quad (9)$$

At certain input/output voltage and switching frequency, the voltage ripple can be reduced by increasing the output filter LC. The charger device has internal loop compensator. To get good loop stability, 1- $\mu$ H and minimum of 20- $\mu$ F output capacitor is recommended. The preferred ceramic capacitor is 6V or higher rating, X7R or X5R.

### 9.2.3 Application Curves

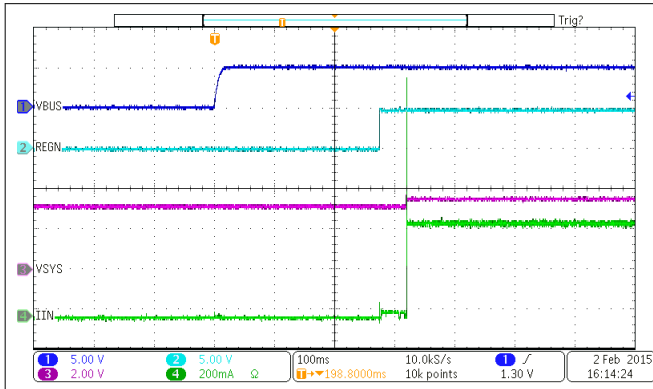

VBAT = 3.2 V      $I_{LIM} = 500 \text{ mA}$   
**Figure 9-2. Power Up from USB100**

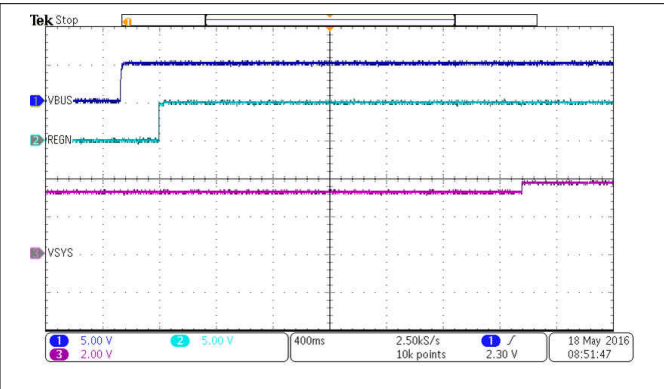

VBAT = 3.2 V  
**Figure 9-3. Power Up with Charge Disabled**

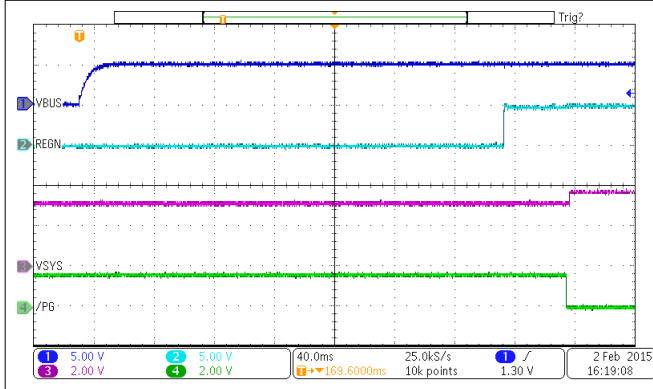

VBAT = 3.2 V  
**Figure 9-4. Power Up with Charge Disabled**

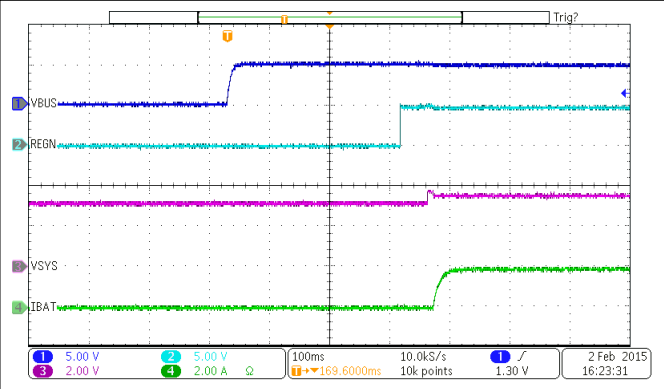

**Figure 9-5. Power Up with Charge Enabled**

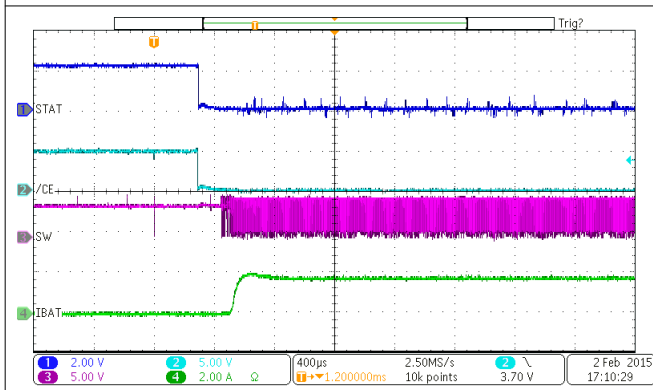

VBUS = 5 V  
**Figure 9-6. Charge Enable**

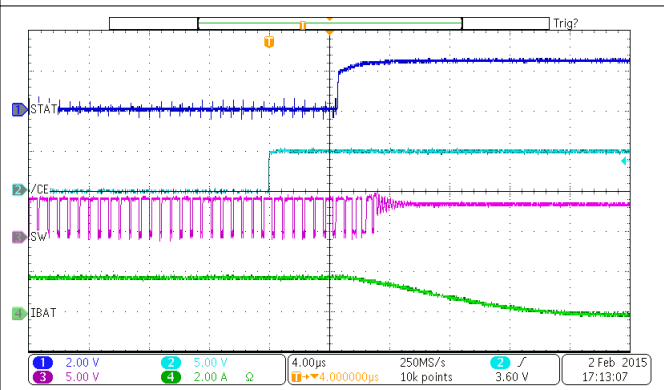

VBUS = 12 V  
**Figure 9-7. Charge Disable**

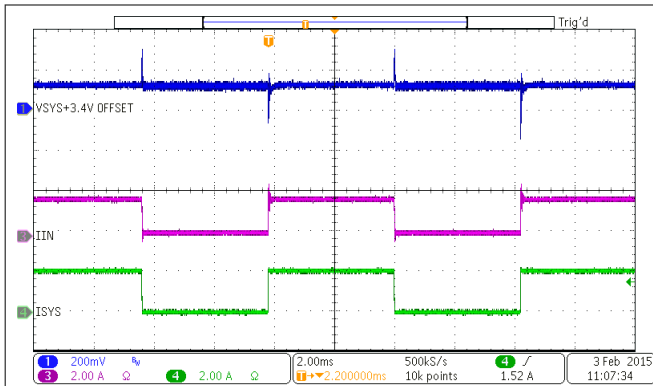

VBUS = 5 V  $I_{IN} = 3$  A Charge Disable

**Figure 9-8. Input Current DPM Response without Battery**

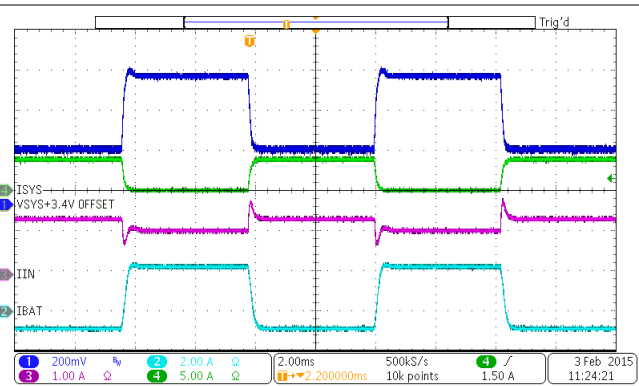

VBUS = 9 V  $I_{IN} = 1.5$  A  $V_{BAT} = 3.8$  V  
 $I_{CHG} = 2$  A  $I_{SYS} = 0$  A - 4 A

**Figure 9-9. Load Transient During Supplement Mode**

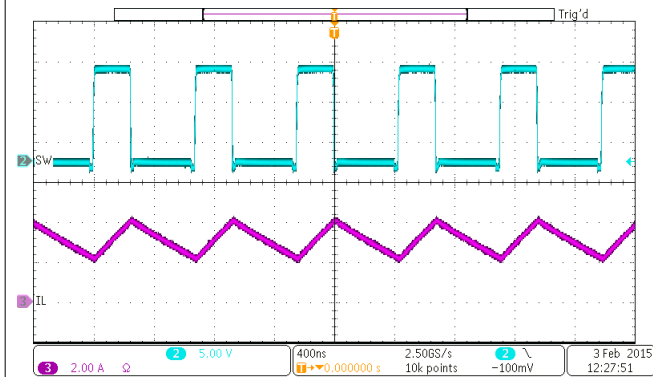

VBUS = 12 V  $V_{BAT} = 3.8$  V  $I_{CHG} = 3$  A

**Figure 9-10. PWM Switching Waveform**

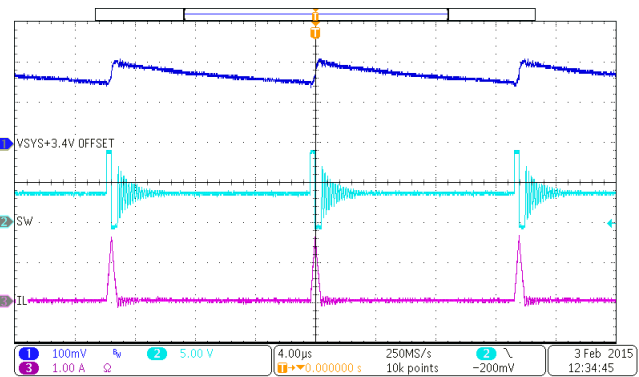

VBUS = 9V  $I_{SYS} = 10$  mA, Charge Disable  
No Battery

**Figure 9-11. PFM Switching Waveform**

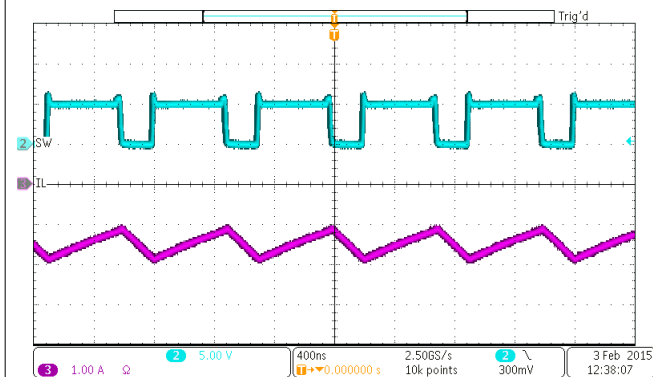

$V_{BAT} = 3.8$  V  $I_{LOAD} = 1$  A

**Figure 9-12. Boost Mode Switching Waveform**

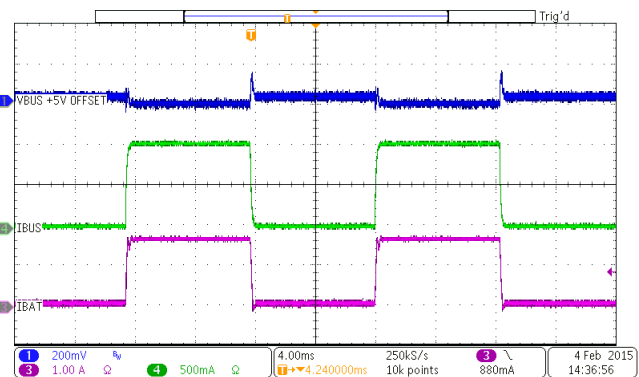

$V_{BAT} = 3.8$  V  $I_{LOAD} = 0$  A - 1 A

**Figure 9-13. Boost Mode Load Transient**

### 9.3 System Examples

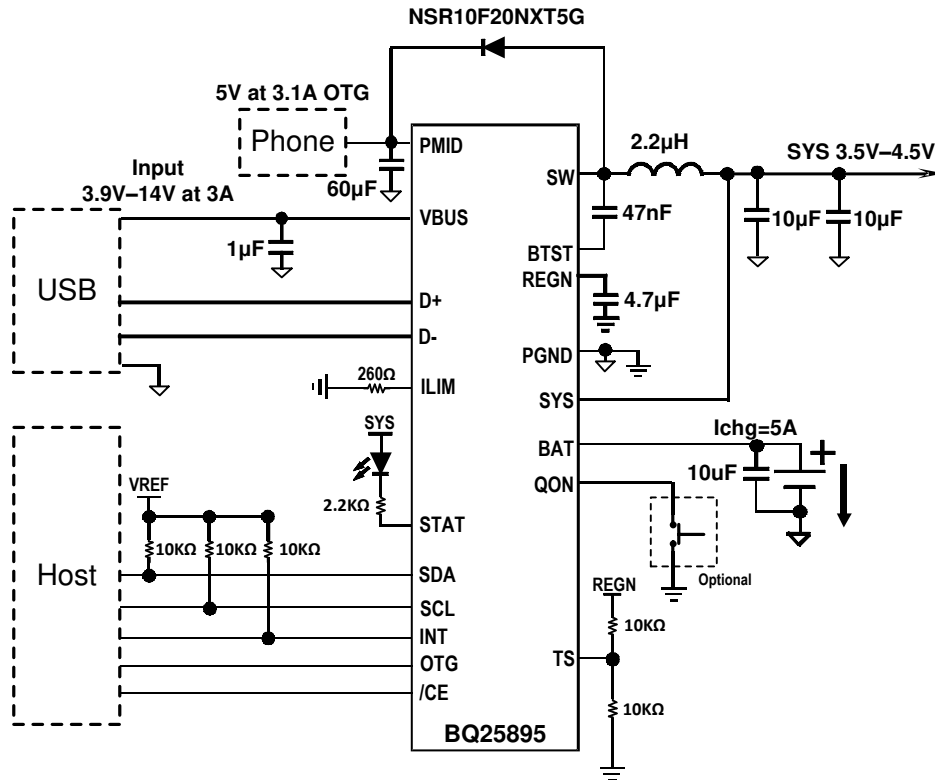

Figure 9-14. BQ25895 with D+/D- Interface, 3.1-A Boost Mode Output, and No Thermistor Connections

## 10 Power Supply Recommendations

In order to provide an output voltage on SYS, the device requires a power supply between 3.9 V and 14 V input with at least 100-mA current rating connected to VBUS or a single-cell Li-Ion battery with voltage  $> V_{BATUVLO}$  connected to BAT. The source current rating needs to be at least 3 A in order for the buck converter of the charger to provide maximum output power to SYS.

## 11 Layout

### 11.1 Layout Guidelines

The switching node rise and fall times should be minimized for minimum switching loss. Proper layout of the components to minimize high frequency current path loop (see [Figure 11-1](#)) is important to prevent electrical and magnetic field radiation and high frequency resonant problems. Here is a PCB layout priority list for proper layout. Layout PCB according to this specific order is essential.

1. Place input capacitor as close as possible to PMID pin and GND pin connections and use shortest copper trace connection or GND plane.
2. Place inductor input terminal to SW pin as close as possible. Minimize the copper area of this trace to lower electrical and magnetic field radiation but make the trace wide enough to carry the charging current. Do not use multiple layers in parallel for this connection. Minimize parasitic capacitance from this area to any other trace or plane.
3. Put output capacitor near to the inductor and the IC. Ground connections need to be tied to the IC ground with a short copper trace connection or GND plane.
4. Route analog ground separately from power ground. Connect analog ground and connect power ground separately. Connect analog ground and power ground together using power pad as the single ground connection point. Or using a 0Ω resistor to tie analog ground to power ground.
5. Use single ground connection to tie charger power ground to charger analog ground. Just beneath the IC. Use ground copper pour but avoid power pins to reduce inductive and capacitive noise coupling.
6. Decoupling capacitors should be placed next to the IC pins and make trace connection as short as possible.
7. It is critical that the exposed power pad on the backside of the IC package be soldered to the PCB ground. Ensure that there are sufficient thermal vias directly under the IC, connecting to the ground plane on the other layers.
8. The via size and number should be enough for a given current path.

See the EVM design for the recommended component placement with trace and via locations. For the VQFN information, refer to [Quad Flatpack No-Lead Logic Packages Application Report](#) and [QFN and SON PCB Attachment Application Report](#).

### 11.2 Layout Example

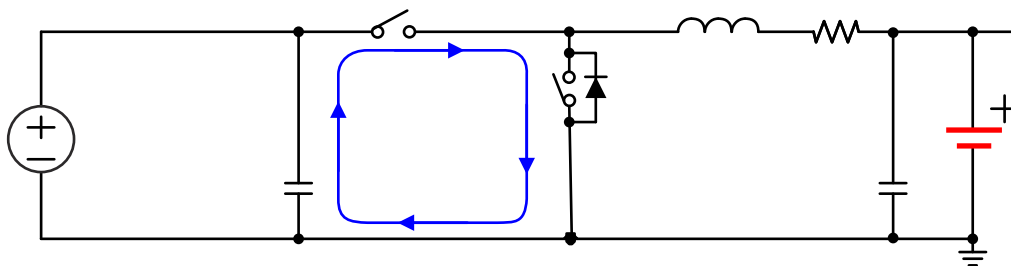

**Figure 11-1. High Frequency Current Path**

## 12 Device and Documentation Support

### 12.1 Device Support

#### 12.1.1 Third-Party Products Disclaimer

TI'S PUBLICATION OF INFORMATION REGARDING THIRD-PARTY PRODUCTS OR SERVICES DOES NOT CONSTITUTE AN ENDORSEMENT REGARDING THE SUITABILITY OF SUCH PRODUCTS OR SERVICES OR A WARRANTY, REPRESENTATION OR ENDORSEMENT OF SUCH PRODUCTS OR SERVICES, EITHER ALONE OR IN COMBINATION WITH ANY TI PRODUCT OR SERVICE.

#### 12.2 Receiving Notification of Documentation Updates

To receive notification of documentation updates, navigate to the device product folder on [ti.com](http://ti.com). Click on *Subscribe to updates* to register and receive a weekly digest of any product information that has changed. For change details, review the revision history included in any revised document.

#### 12.3 Support Resources

[TI E2E™ support forums](#) are an engineer's go-to source for fast, verified answers and design help — straight from the experts. Search existing answers or ask your own question to get the quick design help you need.

Linked content is provided "AS IS" by the respective contributors. They do not constitute TI specifications and do not necessarily reflect TI's views; see TI's [Terms of Use](#).

#### 12.4 Trademarks

PowerPAD™ and TI E2E™ are trademarks of Texas Instruments.

All trademarks are the property of their respective owners.

#### 12.5 Glossary

[TI Glossary](#) This glossary lists and explains terms, acronyms, and definitions.

#### 12.6 Electrostatic Discharge Caution



This integrated circuit can be damaged by ESD. Texas Instruments recommends that all integrated circuits be handled with appropriate precautions. Failure to observe proper handling and installation procedures can cause damage.

ESD damage can range from subtle performance degradation to complete device failure. Precision integrated circuits may be more susceptible to damage because very small parametric changes could cause the device not to meet its published specifications.

## 13 Mechanical, Packaging, and Orderable Information

The following pages include mechanical, packaging, and orderable information. This information is the most current data available for the designated devices. This data is subject to change without notice and revision of this document. For browser-based versions of this data sheet, refer to the left-hand navigation.



**PACKAGING INFORMATION**

| Orderable Device | Status<br>(1) | Package Type | Package<br>Drawing | Pins | Package<br>Qty | Eco Plan<br>(2) | Lead finish/<br>Ball material<br>(6) | MSL Peak Temp<br>(3) | Op Temp (°C) | Device Marking<br>(4/5) | Samples                 |
|------------------|---------------|--------------|--------------------|------|----------------|-----------------|--------------------------------------|----------------------|--------------|-------------------------|-------------------------|
| BQ25895RTWR      | ACTIVE        | WQFN         | RTW                | 24   | 3000           | RoHS & Green    | NIPDAU                               | Level-2-260C-1 YEAR  | -40 to 85    | BQ25895                 | <a href="#">Samples</a> |
| BQ25895RTWT      | ACTIVE        | WQFN         | RTW                | 24   | 250            | RoHS & Green    | NIPDAU                               | Level-2-260C-1 YEAR  | -40 to 85    | BQ25895                 | <a href="#">Samples</a> |

(1) The marketing status values are defined as follows:

**ACTIVE:** Product device recommended for new designs.

**LIFEBUY:** TI has announced that the device will be discontinued, and a lifetime-buy period is in effect.

**NRND:** Not recommended for new designs. Device is in production to support existing customers, but TI does not recommend using this part in a new design.

**PREVIEW:** Device has been announced but is not in production. Samples may or may not be available.

**OBSOLETE:** TI has discontinued the production of the device.

(2) **RoHS:** TI defines "RoHS" to mean semiconductor products that are compliant with the current EU RoHS requirements for all 10 RoHS substances, including the requirement that RoHS substance do not exceed 0.1% by weight in homogeneous materials. Where designed to be soldered at high temperatures, "RoHS" products are suitable for use in specified lead-free processes. TI may reference these types of products as "Pb-Free".

**RoHS Exempt:** TI defines "RoHS Exempt" to mean products that contain lead but are compliant with EU RoHS pursuant to a specific EU RoHS exemption.

**Green:** TI defines "Green" to mean the content of Chlorine (Cl) and Bromine (Br) based flame retardants meet JS709B low halogen requirements of <=1000ppm threshold. Antimony trioxide based flame retardants must also meet the <=1000ppm threshold requirement.

(3) MSL, Peak Temp. - The Moisture Sensitivity Level rating according to the JEDEC industry standard classifications, and peak solder temperature.

(4) There may be additional marking, which relates to the logo, the lot trace code information, or the environmental category on the device.

(5) Multiple Device Markings will be inside parentheses. Only one Device Marking contained in parentheses and separated by a "~" will appear on a device. If a line is indented then it is a continuation of the previous line and the two combined represent the entire Device Marking for that device.

(6) Lead finish/Ball material - Orderable Devices may have multiple material finish options. Finish options are separated by a vertical ruled line. Lead finish/Ball material values may wrap to two lines if the finish value exceeds the maximum column width.

**Important Information and Disclaimer:**The information provided on this page represents TI's knowledge and belief as of the date that it is provided. TI bases its knowledge and belief on information provided by third parties, and makes no representation or warranty as to the accuracy of such information. Efforts are underway to better integrate information from third parties. TI has taken and continues to take reasonable steps to provide representative and accurate information but may not have conducted destructive testing or chemical analysis on incoming materials and chemicals. TI and TI suppliers consider certain information to be proprietary, and thus CAS numbers and other limited information may not be available for release.

In no event shall TI's liability arising out of such information exceed the total purchase price of the TI part(s) at issue in this document sold by TI to Customer on an annual basis.



**TAPE AND REEL INFORMATION**

**QUADRANT ASSIGNMENTS FOR PIN 1 ORIENTATION IN TAPE**

\*All dimensions are nominal

| Device      | Package Type | Package Drawing | Pins | SPQ  | Reel Diameter (mm) | Reel Width W1 (mm) | A0 (mm) | B0 (mm) | K0 (mm) | P1 (mm) | W (mm) | Pin1 Quadrant |
|-------------|--------------|-----------------|------|------|--------------------|--------------------|---------|---------|---------|---------|--------|---------------|
| BQ25895RTWR | WQFN         | RTW             | 24   | 3000 | 330.0              | 12.4               | 4.25    | 4.25    | 1.15    | 8.0     | 12.0   | Q2            |
| BQ25895RTWR | WQFN         | RTW             | 24   | 3000 | 330.0              | 12.4               | 4.25    | 4.25    | 1.15    | 8.0     | 12.0   | Q2            |
| BQ25895RTWT | WQFN         | RTW             | 24   | 250  | 180.0              | 12.4               | 4.25    | 4.25    | 1.15    | 8.0     | 12.0   | Q2            |
| BQ25895RTWT | WQFN         | RTW             | 24   | 250  | 180.0              | 12.4               | 4.25    | 4.25    | 1.15    | 8.0     | 12.0   | Q2            |

**TAPE AND REEL BOX DIMENSIONS**

\*All dimensions are nominal

| Device      | Package Type | Package Drawing | Pins | SPQ  | Length (mm) | Width (mm) | Height (mm) |
|-------------|--------------|-----------------|------|------|-------------|------------|-------------|
| BQ25895RTWR | WQFN         | RTW             | 24   | 3000 | 367.0       | 367.0      | 35.0        |
| BQ25895RTWR | WQFN         | RTW             | 24   | 3000 | 346.0       | 346.0      | 33.0        |
| BQ25895RTWT | WQFN         | RTW             | 24   | 250  | 210.0       | 185.0      | 35.0        |
| BQ25895RTWT | WQFN         | RTW             | 24   | 250  | 210.0       | 185.0      | 35.0        |

## GENERIC PACKAGE VIEW

**RTW 24**

**WQFN - 0.8 mm max height**

4 x 4, 0.5 mm pitch

PLASTIC QUAD FLATPACK - NO LEAD

This image is a representation of the package family, actual package may vary.  
Refer to the product data sheet for package details.

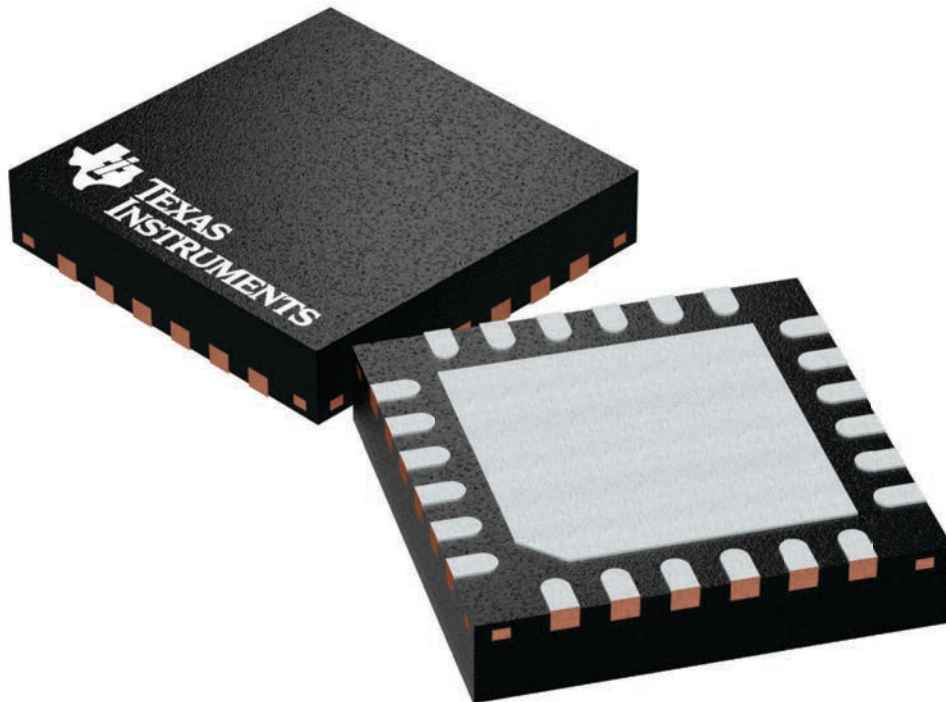

4224801/A

RTW (S-PWQFN-N24)

PLASTIC QUAD FLATPACK NO-LEAD

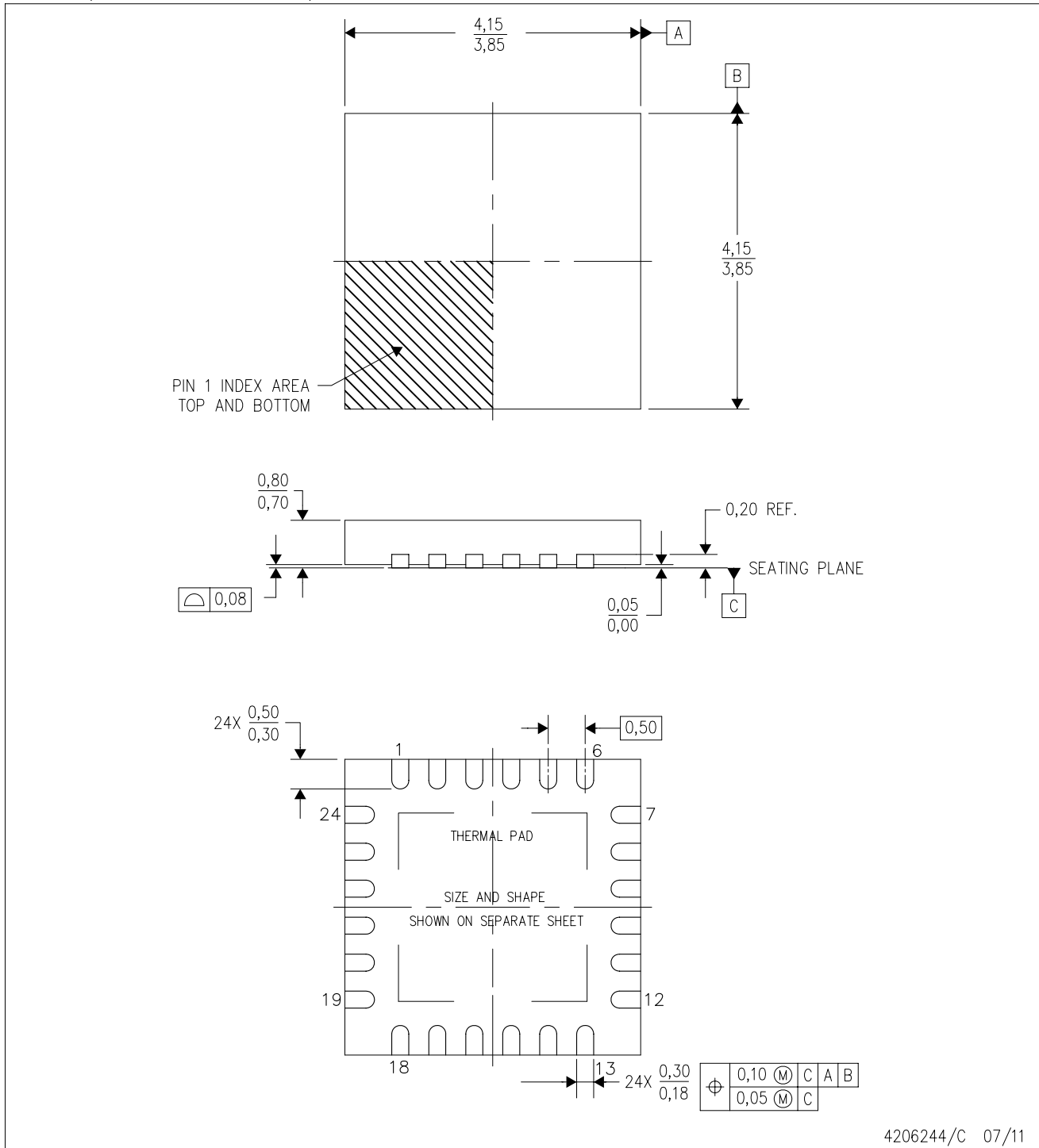

- NOTES:
- A. All linear dimensions are in millimeters. Dimensioning and tolerancing per ASME Y14.5M-1994.
  - B. This drawing is subject to change without notice.
  - C. Quad Flatpack, No-Leads (QFN) package configuration.
  - D. The package thermal pad must be soldered to the board for thermal and mechanical performance.
  - E. See the additional figure in the Product Data Sheet for details regarding the exposed thermal pad features and dimensions.
  - F. Falls within JEDEC MO-220.

THERMAL INFORMATION

This package incorporates an exposed thermal pad that is designed to be attached directly to an external heatsink. The thermal pad must be soldered directly to the printed circuit board (PCB). After soldering, the PCB can be used as a heatsink. In addition, through the use of thermal vias, the thermal pad can be attached directly to the appropriate copper plane shown in the electrical schematic for the device, or alternatively, can be attached to a special heatsink structure designed into the PCB. This design optimizes the heat transfer from the integrated circuit (IC).

For information on the Quad Flatpack No-Lead (QFN) package and its advantages, refer to Application Report, QFN/SON PCB Attachment, Texas Instruments Literature No. SLUA271. This document is available at [www.ti.com](http://www.ti.com).

The exposed thermal pad dimensions for this package are shown in the following illustration.

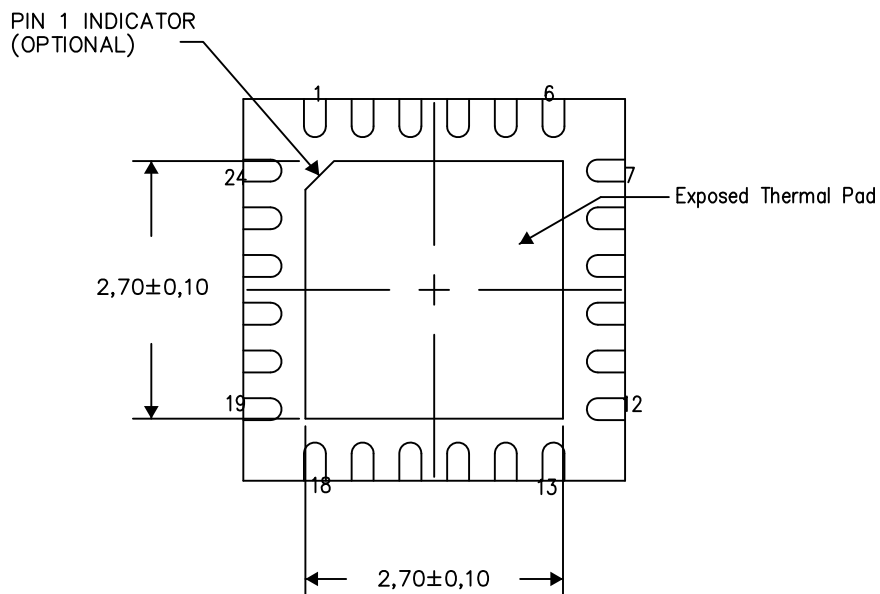

Bottom View

Exposed Thermal Pad Dimensions

4206249-5/P 05/15

NOTES: A. All linear dimensions are in millimeters

RTW (S-PWQFN-N24)

PLASTIC QUAD FLATPACK NO-LEAD

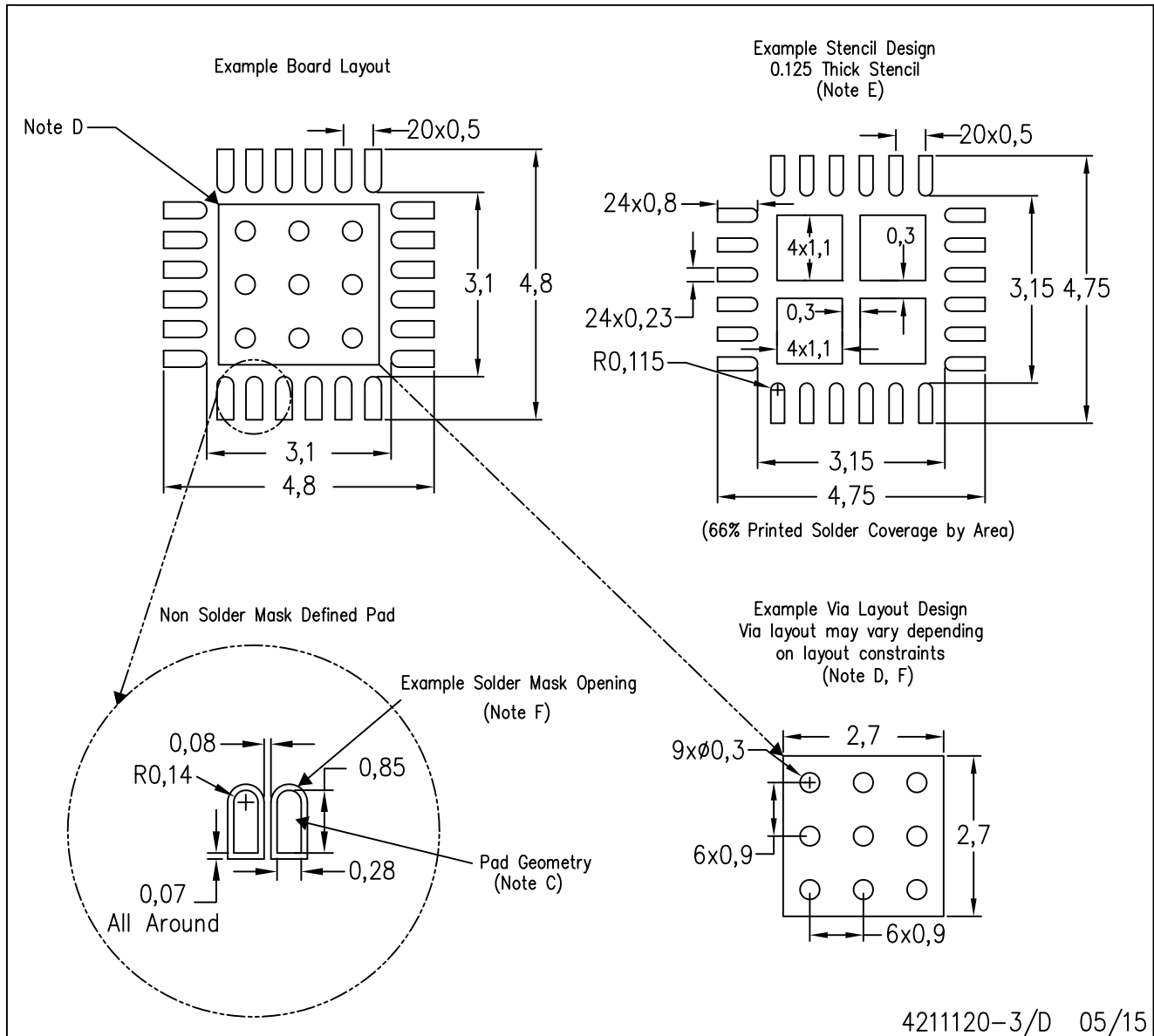

- NOTES:
- A. All linear dimensions are in millimeters.
  - B. This drawing is subject to change without notice.
  - C. Publication IPC-7351 is recommended for alternate designs.
  - D. This package is designed to be soldered to a thermal pad on the board. Refer to Application Note, Quad Flat-Pack Packages, Texas Instruments Literature No. SLUA271, and also the Product Data Sheets for specific thermal information, via requirements, and recommended board layout. These documents are available at [www.ti.com](http://www.ti.com) <<http://www.ti.com>>.
  - E. Laser cutting apertures with trapezoidal walls and also rounding corners will offer better paste release. Customers should contact their board assembly site for stencil design recommendations. Refer to IPC 7525 for stencil design considerations.
  - F. Customers should contact their board fabrication site for recommended solder mask tolerances and via tenting recommendations for vias placed in the thermal pad.



## IMPORTANT NOTICE AND DISCLAIMER

TI PROVIDES TECHNICAL AND RELIABILITY DATA (INCLUDING DATA SHEETS), DESIGN RESOURCES (INCLUDING REFERENCE DESIGNS), APPLICATION OR OTHER DESIGN ADVICE, WEB TOOLS, SAFETY INFORMATION, AND OTHER RESOURCES "AS IS" AND WITH ALL FAULTS, AND DISCLAIMS ALL WARRANTIES, EXPRESS AND IMPLIED, INCLUDING WITHOUT LIMITATION ANY IMPLIED WARRANTIES OF MERCHANTABILITY, FITNESS FOR A PARTICULAR PURPOSE OR NON-INFRINGEMENT OF THIRD PARTY INTELLECTUAL PROPERTY RIGHTS.

These resources are intended for skilled developers designing with TI products. You are solely responsible for (1) selecting the appropriate TI products for your application, (2) designing, validating and testing your application, and (3) ensuring your application meets applicable standards, and any other safety, security, regulatory or other requirements.

These resources are subject to change without notice. TI grants you permission to use these resources only for development of an application that uses the TI products described in the resource. Other reproduction and display of these resources is prohibited. No license is granted to any other TI intellectual property right or to any third party intellectual property right. TI disclaims responsibility for, and you will fully indemnify TI and its representatives against, any claims, damages, costs, losses, and liabilities arising out of your use of these resources.

TI's products are provided subject to [TI's Terms of Sale](#) or other applicable terms available either on [ti.com](https://www.ti.com) or provided in conjunction with such TI products. TI's provision of these resources does not expand or otherwise alter TI's applicable warranties or warranty disclaimers for TI products.

TI objects to and rejects any additional or different terms you may have proposed.

Mailing Address: Texas Instruments, Post Office Box 655303, Dallas, Texas 75265  
Copyright © 2024, Texas Instruments Incorporated