

High-Speed CMOS Logic 4-Bit Bidirectional Universal Shift Register

Features

- **Four Operating Modes**
 - Shift Right, Shift Left, Hold and Reset
- **Synchronous Parallel or Serial Operation**
- **Typical $f_{MAX} = 60\text{MHz}$ at $V_{CC} = 5\text{V}$, $C_L = 15\text{pF}$, $T_A = 25^\circ\text{C}$**
- **Asynchronous Master Reset**
- **Fanout (Over Temperature Range)**
 - Standard Outputs 10 LSTTL Loads
 - Bus Driver Outputs 15 LSTTL Loads
- **Wide Operating Temperature Range . . . -55°C to 125°C**
- **Balanced Propagation Delay and Transition Times**
- **Significant Power Reduction Compared to LSTTL Logic ICs**
- **HC Types**
 - 2V to 6V Operation
 - High Noise Immunity: $N_{IL} = 30\%$, $N_{IH} = 30\%$ of V_{CC} at $V_{CC} = 5\text{V}$
- **HCT Types**
 - 4.5V to 5.5V Operation
 - Direct LSTTL Input Logic Compatibility, $V_{IL} = 0.8\text{V}$ (Max), $V_{IH} = 2\text{V}$ (Min)
 - CMOS Input Compatibility, $I_I \leq 1\mu\text{A}$ at V_{OL} , V_{OH}

Description

The 'HC194 and CD74HCT194 are 4-bit shift registers with Asynchronous Master Reset ($\overline{\text{MR}}$). In the parallel mode (S_0 and S_1 are high), data is loaded into the associated flip-flop and appears at the output after the positive transition of the clock input (CP). During parallel loading serial data flow is inhibited. Shift left and shift right are accomplished synchronously on the positive clock edge with serial data entered at the shift left (DSL) serial input for the shift left mode, and at the shift right (DSR) serial input for the shift right mode. Clearing the register is accomplished by a Low applied to the Master Reset ($\overline{\text{MR}}$) pin.

Ordering Information

PART NUMBER	TEMP. RANGE (°C)	PACKAGE
CD54HC194F3A	-55 to 125	16 Ld CERDIP
CD74HC194E	-55 to 125	16 Ld PDIP
CD74HC194M	-55 to 125	16 Ld SOIC
CD74HC194MT	-55 to 125	16 Ld SOIC
CD74HC194M96	-55 to 125	16 Ld SOIC
CD74HC194NSR	-55 to 125	16 Ld SOP
CD74HC194PW	-55 to 125	16 Ld TSSOP
CD74HC194PWR	-55 to 125	16 Ld TSSOP
CD74HC194PWT	-55 to 125	16 Ld TSSOP
CD74HCT194E	-55 to 125	16 Ld PDIP

NOTE: When ordering, use the entire part number. The suffixes 96 and R denote tape and reel. The suffix T denotes a small-quantity reel of 250.

Pinout

CD54HC194 (CERDIP)
 CD74HC194 (PDIP, SOIC, SOP, TSSOP)
 CD74HCT194 (PDIP)
 TOP VIEW

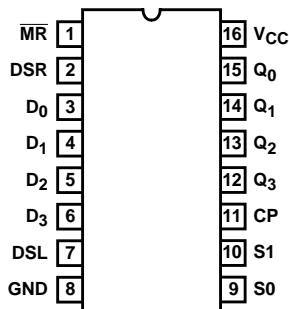

CD54HC194, CD74HC194, CD74HCT194

Functional Diagram

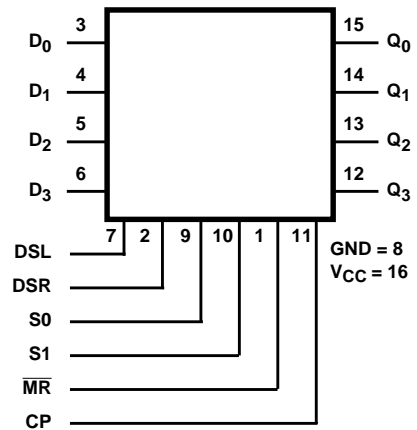

TRUTH TABLE

OPERATING MODE	INPUTS							OUTPUT			
	CP	\overline{MR}	S1	S0	DSR	DSL	D _n	Q ₀	Q ₁	Q ₂	Q ₃
Reset (Clear)	X	L	X	X	X	X	X	L	L	L	L
Hold (Do Nothing)	X	H	l	l	X	X	X	q ₀	q ₁	q ₂	q ₃
Shift Left	↑	H	h	l	X	l	X	q ₁	q ₂	q ₃	L
	↑	H	h	l	X	h	X	q ₁	q ₂	q ₃	H
Shift Right	↑	H	l	h	l	X	X	L	q ₀	q ₁	q ₂
	↑	H	l	h	h	X	X	H	q ₀	q ₁	q ₂
Parallel Load	↑	H	h	h	X	X	d _n	d ₀	d ₁	d ₂	d ₃

H = High Voltage Level,
h = High Voltage Level One Set-up Time Prior To The Low to High Clock Transition,
L = Low Voltage Level,
l = Low Voltage Level One Set-up Time Prior to the Low to High Clock Transition,
d_n (q_n) = Lower Case Letters Indicate the State of the Referenced Input (or output) One Set-up Time Prior to the Low To High Clock Transition,
X = Don't Care,
↑ = Transition from Low to High Level

CD54HC194, CD74HC194, CD74HCT194

Absolute Maximum Ratings

DC Supply Voltage, V_{CC}	-0.5V to 7V
DC Input Diode Current, I_{IK}	
For $V_I < -0.5V$ or $V_I > V_{CC} + 0.5V$	$\pm 20mA$
DC Output Diode Current, I_{OK}	
For $V_O < -0.5V$ or $V_O > V_{CC} + 0.5V$	$\pm 20mA$
DC Output Source or Sink Current per Output Pin, I_O	
For $V_O > -0.5V$ or $V_O < V_{CC} + 0.5V$	$\pm 25mA$
DC V_{CC} or Ground Current, I_{CC} or I_{GND}	$\pm 50mA$

Thermal Information

Package Thermal Impedance, θ_{JA} (see Note 2):	
E (PDIP) Package	67°C/W
M (SOIC) Package	73°C/W
NS (SOP) Package	64°C/W
PW (TSSOP) Package	108°C/W
Maximum Junction Temperature	150°C
Maximum Storage Temperature Range	-65°C to 150°C
Maximum Lead Temperature (Soldering 10s)	300°C
(SOIC - Lead Tips Only)	

Operating Conditions

Temperature Range (T_A)	-55°C to 125°C
Supply Voltage Range, V_{CC}	
HC Types2V to 6V
HCT Types	4.5V to 5.5V
DC Input or Output Voltage, V_I , V_O	0V to V_{CC}
Input Rise and Fall Time	
2V	1000ns (Max)
4.5V	500ns (Max)
6V	400ns (Max)

CAUTION: Stresses above those listed in "Absolute Maximum Ratings" may cause permanent damage to the device. This is a stress only rating and operation of the device at these or any other conditions above those indicated in the operational sections of this specification is not implied.

NOTE:

- The package thermal impedance is calculated in accordance with JESD 51-7.

DC Electrical Specifications

PARAMETER	SYMBOL	TEST CONDITIONS		V_{CC} (V)	25°C			-40°C TO 85°C		-55°C TO 125°C		UNITS
		V_I (V)	I_O (mA)		MIN	TYP	MAX	MIN	MAX	MIN	MAX	
HC TYPES												
High Level Input Voltage	V_{IH}	-	-	2	1.5	-	-	1.5	-	1.5	-	V
				4.5	3.15	-	-	3.15	-	3.15	-	V
				6	4.2	-	-	4.2	-	4.2	-	V
Low Level Input Voltage	V_{IL}	-	-	2	-	-	0.5	-	0.5	-	0.5	V
				4.5	-	-	1.35	-	1.35	-	1.35	V
				6	-	-	1.8	-	1.8	-	1.8	V
High Level Output Voltage CMOS Loads	V_{OH}	V_{IH} or V_{IL}	-0.02	2	1.9	-	-	1.9	-	1.9	-	V
			-0.02	4.5	4.4	-	-	4.4	-	4.4	-	V
			-0.02	6	5.9	-	-	5.9	-	5.9	-	V
High Level Output Voltage TTL Loads	V_{OH}	V_{IH} or V_{IL}	-4	4.5	3.98	-	-	3.84	-	3.7	-	V
			-5.2	6	5.48	-	-	5.34	-	5.2	-	V
Low Level Output Voltage CMOS Loads	V_{OL}	V_{IH} or V_{IL}	0.02	2	-	-	0.1	-	0.1	-	0.1	V
			0.02	4.5	-	-	0.1	-	0.1	-	0.1	V
			0.02	6	-	-	0.1	-	0.1	-	0.1	V
Low Level Output Voltage TTL Loads	V_{OL}	V_{IH} or V_{IL}	4	4.5	-	-	0.26	-	0.33	-	0.4	V
			5.2	6	-	-	0.26	-	0.33	-	0.4	V

CD54HC194, CD74HC194, CD74HCT194

DC Electrical Specifications (Continued)

PARAMETER	SYMBOL	TEST CONDITIONS		V _{CC} (V)	25°C			-40°C TO 85°C		-55°C TO 125°C		UNITS
		V _I (V)	I _O (mA)		MIN	TYP	MAX	MIN	MAX	MIN	MAX	
Input Leakage Current	I _I	V _{CC} or GND	-	6	-	-	±0.1	-	±1	-	±1	μA
Quiescent Device Current	I _{CC}	V _{CC} or GND	0	6	-	-	8	-	80	-	160	μA
HCT TYPES												
High Level Input Voltage	V _{IH}	-	-	4.5 to 5.5	2	-	-	2	-	2	-	V
Low Level Input Voltage	V _{IL}	-	-	4.5 to 5.5	-	-	0.8	-	0.8	-	0.8	V
High Level Output Voltage CMOS Loads	V _{OH}	V _{IH} or V _{IL}	-0.02	4.5	4.4	-	-	4.4	-	4.4	-	V
High Level Output Voltage TTL Loads			-4	4.5	3.98	-	-	3.84	-	3.7	-	V
Low Level Output Voltage CMOS Loads	V _{OL}	V _{IH} or V _{IL}	0.02	4.5	-	-	0.1	-	0.1	-	0.1	V
Low Level Output Voltage TTL Loads			4	4.5	-	-	0.26	-	0.33	-	0.4	V
Input Leakage Current	I _I	V _{CC} to GND	0	5.5	-	-	±0.1	-	±1	-	±1	μA
Quiescent Device Current	I _{CC}	V _{CC} or GND	0	5.5	-	-	8	-	80	-	160	μA
Additional Quiescent Device Current Per Input Pin: 1 Unit Load	ΔI _{CC} (Note 3)	V _{CC} -2.1	-	4.5 to 5.5	-	100	360	-	450	-	490	μA

NOTE:

- For dual-supply systems theoretical worst case (V_I = 2.4V, V_{CC} = 5.5V) specification is 1.8mA.

HCT Input Loading Table

INPUT	UNIT LOADS
CP	0.6
MR	0.55
DSL, DSR, D _n	0.25
Sn	1.10

NOTE: Unit Load is ΔI_{CC} limit specified in DC Electrical Specifications table, e.g. 360μA max at 25°C.

CD54HC194, CD74HC194, CD74HCT194

Prerequisite For Switching Function

PARAMETER	SYMBOL	TEST CONDITIONS	V _{CC} (V)	25°C		-40°C TO 85°C		-55°C TO 125°C		UNITS
				MIN	MAX	MIN	MAX	MIN	MAX	
HC TYPES										
Max. Clock Frequency (Figure 1)	f _{MAX}	-	2	6	-	5	-	4	-	MHz
			4.5	30	-	24	-	20	-	MHz
			6	35	-	28	-	23	-	MHz
MR Pulse Width (Figure 2)	t _W	-	2	80	-	100	-	120	-	ns
			4.5	16	-	20	-	24	-	ns
			6	14	-	17	-	20	-	ns
Clock Pulse Width (Figure 1)	t _W	-	2	80	-	100	-	120	-	ns
			4.5	16	-	20	-	24	-	ns
			6	14	-	17	-	20	-	ns
Set-up Time Data to Clock (Figure 3)	t _{SU}	-	2	70	-	90	-	105	-	ns
			4.5	14	-	18	-	21	-	ns
			6	12	-	15	-	19	-	ns
Removal Time, MR to Clock (Figure 2)	t _{REM}	-	2	60	-	75	-	90	-	ns
			4.5	12	-	15	-	18	-	ns
			6	10	-	13	-	15	-	ns
Set-Up Time S1, S0 to Clock (Figure 4)	t _{SU}	-	2	80	-	100	-	120	-	ns
			4.5	16	-	20	-	24	-	ns
			6	14	-	17	-	20	-	ns
Set-up Time DSL, DSR to Clock (Figure 4)	t _{SU}	-	2	70	-	90	-	105	-	ns
			4.5	14	-	18	-	21	-	ns
			6	12	-	15	-	18	-	ns
Hold Time S1, S0 to Clock (Figure 4)	t _H	-	2	0	-	0	-	0	-	ns
			4.5	0	-	0	-	0	-	ns
			6	0	-	0	-	0	-	ns
Hold Time Data to Clock (Figure 3)	t _H	-	2	0	-	0	-	0	-	ns
			4.5	0	-	0	-	0	-	ns
			6	0	-	0	-	0	-	ns
HCT TYPES										
Max. Clock Frequency (Figure 1)	f _{MAX}	-	4.5	27	-	22	-	18	-	MHz
MR Pulse Width (Figure 2)	t _W	-	4.5	16	-	20	-	24	-	ns
Clock Pulse Width (Figure 1)	t _W	-	4.5	16	-	20	-	24	-	ns
Set-up Time, Data to Clock (Figure 3)	t _{SU}	-	4.5	14	-	18	-	21	-	ns
Removal Time MR to Clock (Figure 2)	t _{REM}	-	4.5	12	-	15	-	18	-	ns

Prerequisite For Switching Function (Continued)

PARAMETER	SYMBOL	TEST CONDITIONS	V _{CC} (V)	25°C		-40°C TO 85°C		-55°C TO 125°C		UNITS
				MIN	MAX	MIN	MAX	MIN	MAX	
Set-up Time S1, S0 to Clock (Figure 4)	t _{SU}	-	4.5	20	-	25	-	30	-	ns
Set-up Time DSL, DSR to Clock (Figure 4)	t _{SU}	-	4.5	14	-	18	-	21	-	ns
Hold Time S1, S0 to Clock (Figure 4)	t _H	-	4.5	0	-	0	-	0	-	ns
Hold Time Data to Clock (Figure 3)	t _H	-	4.5	0	-	0	-	0	-	ns

Switching Specifications Input t_r, t_f = 6ns

PARAMETER	SYMBOL	TEST CONDITIONS	V _{CC} (V)	25°C		-40°C TO 85°C	-55°C TO 125°C	UNITS
				TYP	MAX	MAX	MAX	
HC TYPES								
Propagation Delay, Clock to Output (Figure 1)	t _{PLH} , t _{PHL}	C _L = 50pF	2	-	175	220	265	ns
			4.5	-	35	44	53	ns
			6	-	30	37	45	ns
Propagation Delay, Clock to Q	t _{PLH} , t _{PHL}	-	5	14	-	-	-	ns
Output Transition Time (Figure 1)	t _{TLH} , t _{THL}	C _L = 50pF	2	-	75	95	110	ns
			4.5	-	15	19	22	ns
			6	-	13	16	19	ns
Propagation Delay, MR to Output (Figure 2)	t _{PHL}	C _L = 50pF	2	-	140	175	210	ns
			4.5	-	28	35	42	ns
			6	-	24	30	36	ns
Input Capacitance	C _{IN}	-	-	-	10	10	10	pF
Maximum Clock Frequency	f _{MAX}	-	5	60	-	-	-	MHz
Power Dissipation Capacitance (Notes 4, 5)	C _{PD}	-	5	55	-	-	-	pF
HCT TYPES								
Propagation Delay, Clock to Output (Figure 1)	t _{PLH} , t _{PHL}	C _L = 50pF	4.5	-	37	46	56	ns
Propagation Delay, Clock to Q	t _{PLH} , t _{PHL}	-	5	15	-	-	-	ns
Output Transition Times (Figure 1)	t _{TLH} , t _{THL}	C _L = 50pF	4.5	-	15	19	22	ns
Propagation Delay, MR to Output (Figure 2)	t _{PHL}	C _L = 50pF	4.5	-	40	50	60	ns
Input Capacitance	C _{IN}	-	-	-	10	10	10	pF
Maximum Clock Frequency	f _{MAX}	-	5	50	-	-	-	MHz
Power Dissipation Capacitance (Notes 4, 5)	C _{PD}	-	5	60	-	-	-	pF

NOTES:

- C_{PD} is used to determine the dynamic power consumption, per gate.
- $P_D = V_{CC}^2 f_i + \sum (C_L V_{CC}^2)$ where f_i = Input Frequency, C_L = Output Load Capacitance, V_{CC} = Supply Voltage.

Test Circuits and Waveforms

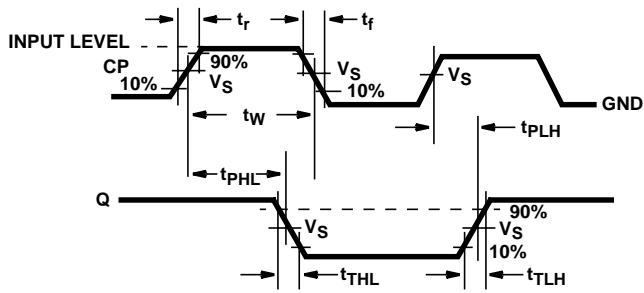

FIGURE 1. CLOCK PREREQUISITE TIMES AND PROPAGATION AND OUTPUT TRANSITION TIMES

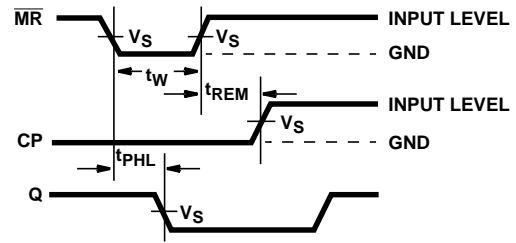

FIGURE 2. MASTER RESET PREREQUISITE TIMES AND PROPAGATION DELAYS

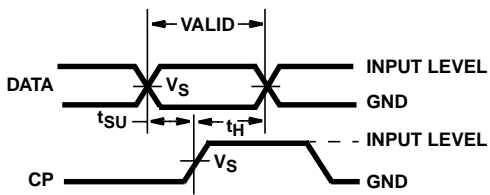

FIGURE 3. DATA PREREQUISITE TIMES

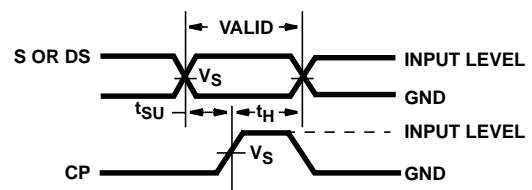

FIGURE 4. PARALLEL LOAD OR SHIFT-LEFT/SHIFT-RIGHT PREREQUISITE TIMES

PACKAGING INFORMATION

Orderable Device	Status (1)	Package Type	Package Drawing	Pins	Package Qty	Eco Plan (2)	Lead finish/ Ball material (6)	MSL Peak Temp (3)	Op Temp (°C)	Device Marking (4/5)	Samples
5962-8682601EA	ACTIVE	CDIP	J	16	1	Non-RoHS & Green	SNPB	N / A for Pkg Type	-55 to 125	5962-8682601EA CD54HC194F3A	Samples
CD54HC194F3A	ACTIVE	CDIP	J	16	1	Non-RoHS & Green	SNPB	N / A for Pkg Type	-55 to 125	5962-8682601EA CD54HC194F3A	Samples
CD74HC194E	ACTIVE	PDIP	N	16	25	RoHS & Green	NIPDAU	N / A for Pkg Type	-55 to 125	CD74HC194E	Samples
CD74HC194M	ACTIVE	SOIC	D	16	40	RoHS & Green	NIPDAU	Level-1-260C-UNLIM	-55 to 125	HC194M	Samples
CD74HC194M96	ACTIVE	SOIC	D	16	2500	RoHS & Green	NIPDAU	Level-1-260C-UNLIM	-55 to 125	HC194M	Samples
CD74HC194PW	ACTIVE	TSSOP	PW	16	90	RoHS & Green	NIPDAU	Level-1-260C-UNLIM	-55 to 125	HJ194	Samples
CD74HC194PWR	ACTIVE	TSSOP	PW	16	2000	RoHS & Green	NIPDAU	Level-1-260C-UNLIM	-55 to 125	HJ194	Samples
CD74HC194PWT	ACTIVE	TSSOP	PW	16	250	RoHS & Green	NIPDAU	Level-1-260C-UNLIM	-55 to 125	HJ194	Samples
CD74HCT194E	ACTIVE	PDIP	N	16	25	RoHS & Green	NIPDAU	N / A for Pkg Type	-55 to 125	CD74HCT194E	Samples

(1) The marketing status values are defined as follows:

ACTIVE: Product device recommended for new designs.

LIFEBUY: TI has announced that the device will be discontinued, and a lifetime-buy period is in effect.

NRND: Not recommended for new designs. Device is in production to support existing customers, but TI does not recommend using this part in a new design.

PREVIEW: Device has been announced but is not in production. Samples may or may not be available.

OBSOLETE: TI has discontinued the production of the device.

(2) **RoHS:** TI defines "RoHS" to mean semiconductor products that are compliant with the current EU RoHS requirements for all 10 RoHS substances, including the requirement that RoHS substance do not exceed 0.1% by weight in homogeneous materials. Where designed to be soldered at high temperatures, "RoHS" products are suitable for use in specified lead-free processes. TI may reference these types of products as "Pb-Free".

RoHS Exempt: TI defines "RoHS Exempt" to mean products that contain lead but are compliant with EU RoHS pursuant to a specific EU RoHS exemption.

Green: TI defines "Green" to mean the content of Chlorine (Cl) and Bromine (Br) based flame retardants meet JS709B low halogen requirements of <=1000ppm threshold. Antimony trioxide based flame retardants must also meet the <=1000ppm threshold requirement.

(3) MSL, Peak Temp. - The Moisture Sensitivity Level rating according to the JEDEC industry standard classifications, and peak solder temperature.

(4) There may be additional marking, which relates to the logo, the lot trace code information, or the environmental category on the device.

⁽⁵⁾ Multiple Device Markings will be inside parentheses. Only one Device Marking contained in parentheses and separated by a "-" will appear on a device. If a line is indented then it is a continuation of the previous line and the two combined represent the entire Device Marking for that device.

⁽⁶⁾ Lead finish/Ball material - Orderable Devices may have multiple material finish options. Finish options are separated by a vertical ruled line. Lead finish/Ball material values may wrap to two lines if the finish value exceeds the maximum column width.

Important Information and Disclaimer:The information provided on this page represents TI's knowledge and belief as of the date that it is provided. TI bases its knowledge and belief on information provided by third parties, and makes no representation or warranty as to the accuracy of such information. Efforts are underway to better integrate information from third parties. TI has taken and continues to take reasonable steps to provide representative and accurate information but may not have conducted destructive testing or chemical analysis on incoming materials and chemicals. TI and TI suppliers consider certain information to be proprietary, and thus CAS numbers and other limited information may not be available for release.

In no event shall TI's liability arising out of such information exceed the total purchase price of the TI part(s) at issue in this document sold by TI to Customer on an annual basis.

OTHER QUALIFIED VERSIONS OF CD54HC194, CD74HC194 :

- Catalog: [CD74HC194](#)
- Military: [CD54HC194](#)

NOTE: Qualified Version Definitions:

- Catalog - TI's standard catalog product
- Military - QML certified for Military and Defense Applications

TAPE AND REEL INFORMATION



QUADRANT ASSIGNMENTS FOR PIN 1 ORIENTATION IN TAPE



*All dimensions are nominal

Device	Package Type	Package Drawing	Pins	SPQ	Reel Diameter (mm)	Reel Width W1 (mm)	A0 (mm)	B0 (mm)	K0 (mm)	P1 (mm)	W (mm)	Pin1 Quadrant
CD74HC194M96	SOIC	D	16	2500	330.0	16.4	6.5	10.3	2.1	8.0	16.0	Q1
CD74HC194PWR	TSSOP	PW	16	2000	330.0	12.4	6.9	5.6	1.6	8.0	12.0	Q1
CD74HC194PWT	TSSOP	PW	16	250	330.0	12.4	6.9	5.6	1.6	8.0	12.0	Q1

TAPE AND REEL BOX DIMENSIONS

*All dimensions are nominal



Device	Package Type	Package Drawing	Pins	SPQ	Length (mm)	Width (mm)	Height (mm)
CD74HC194M96	SOIC	D	16	2500	333.2	345.9	28.6
CD74HC194PWR	TSSOP	PW	16	2000	853.0	449.0	35.0
CD74HC194PWT	TSSOP	PW	16	250	853.0	449.0	35.0

D (R-PDSO-G16)

PLASTIC SMALL OUTLINE



4040047-6/M 06/11

- NOTES:
- A. All linear dimensions are in inches (millimeters).
 - B. This drawing is subject to change without notice.
 -  C. Body length does not include mold flash, protrusions, or gate burrs. Mold flash, protrusions, or gate burrs shall not exceed 0.006 (0,15) each side.
 -  D. Body width does not include interlead flash. Interlead flash shall not exceed 0.017 (0,43) each side.
 - E. Reference JEDEC MS-012 variation AC.

D (R-PDSO-G16)

PLASTIC SMALL OUTLINE

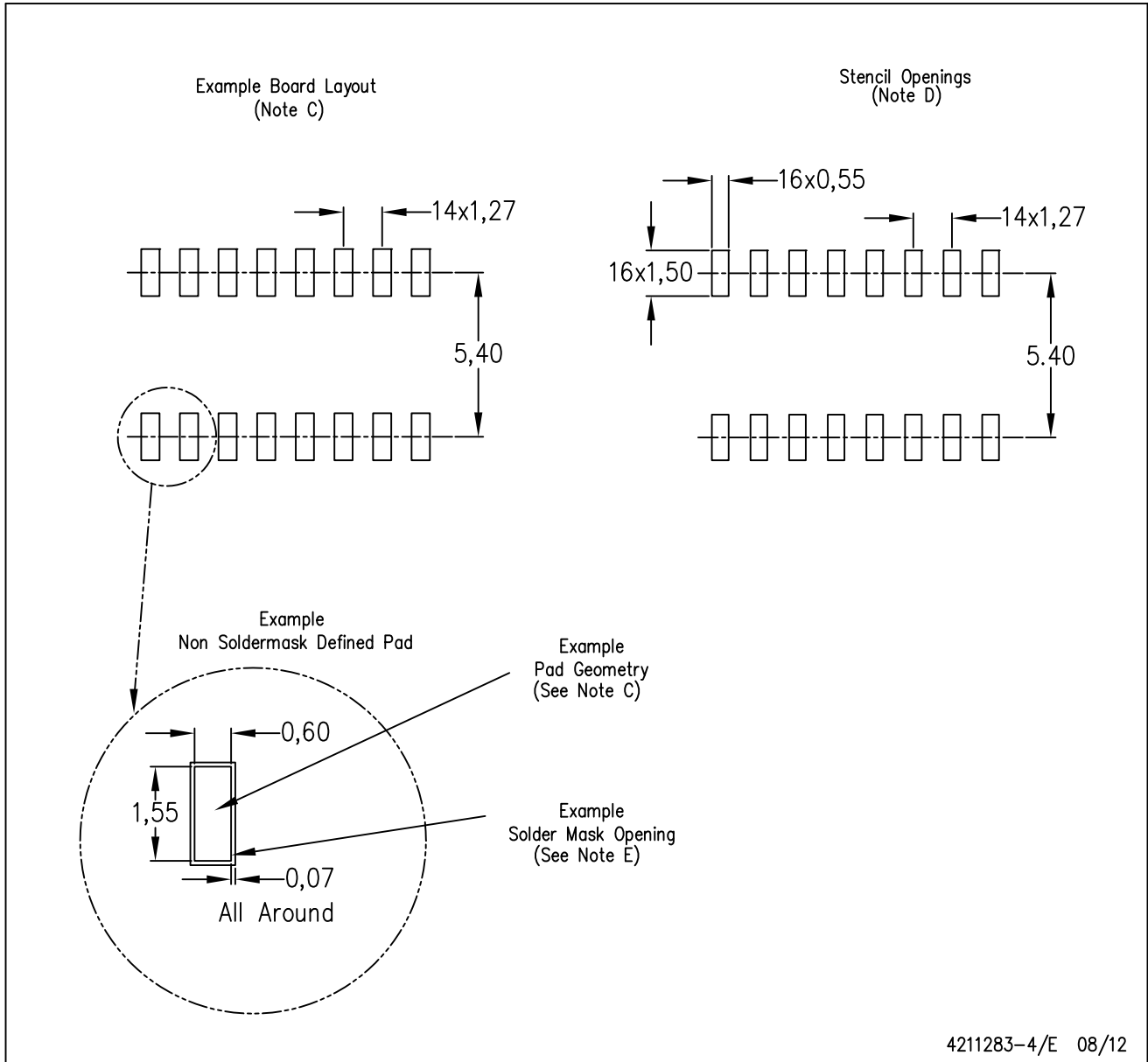

4211283-4/E 08/12

- NOTES:
- All linear dimensions are in millimeters.
 - This drawing is subject to change without notice.
 - Publication IPC-7351 is recommended for alternate designs.
 - Laser cutting apertures with trapezoidal walls and also rounding corners will offer better paste release. Customers should contact their board assembly site for stencil design recommendations. Refer to IPC-7525 for other stencil recommendations.
 - Customers should contact their board fabrication site for solder mask tolerances between and around signal pads.



4220204/A 02/2017

NOTES:

1. All linear dimensions are in millimeters. Any dimensions in parenthesis are for reference only. Dimensioning and tolerancing per ASME Y14.5M.
2. This drawing is subject to change without notice.
3. This dimension does not include mold flash, protrusions, or gate burrs. Mold flash, protrusions, or gate burrs shall not exceed 0.15 mm per side.
4. This dimension does not include interlead flash. Interlead flash shall not exceed 0.25 mm per side.
5. Reference JEDEC registration MO-153.

EXAMPLE BOARD LAYOUT

PW0016A

TSSOP - 1.2 mm max height

SMALL OUTLINE PACKAGE



LAND PATTERN EXAMPLE
EXPOSED METAL SHOWN
SCALE: 10X



SOLDER MASK DETAILS

4220204/A 02/2017

NOTES: (continued)

6. Publication IPC-7351 may have alternate designs.
7. Solder mask tolerances between and around signal pads can vary based on board fabrication site.

EXAMPLE STENCIL DESIGN

PW0016A

TSSOP - 1.2 mm max height

SMALL OUTLINE PACKAGE



SOLDER PASTE EXAMPLE
BASED ON 0.125 mm THICK STENCIL
SCALE: 10X

4220204/A 02/2017

NOTES: (continued)

8. Laser cutting apertures with trapezoidal walls and rounded corners may offer better paste release. IPC-7525 may have alternate design recommendations.
9. Board assembly site may have different recommendations for stencil design.

J (R-GDIP-T**)

14 LEADS SHOWN

CERAMIC DUAL IN-LINE PACKAGE



DIM \ PINS **	14	16	18	20
A	0.300 (7,62) BSC	0.300 (7,62) BSC	0.300 (7,62) BSC	0.300 (7,62) BSC
B MAX	0.785 (19,94)	.840 (21,34)	0.960 (24,38)	1.060 (26,92)
B MIN	—	—	—	—
C MAX	0.300 (7,62)	0.300 (7,62)	0.310 (7,87)	0.300 (7,62)
C MIN	0.245 (6,22)	0.245 (6,22)	0.220 (5,59)	0.245 (6,22)



4040083/F 03/03

- NOTES:
- All linear dimensions are in inches (millimeters).
 - This drawing is subject to change without notice.
 - This package is hermetically sealed with a ceramic lid using glass frit.
 - Index point is provided on cap for terminal identification only on press ceramic glass frit seal only.
 - Falls within MIL STD 1835 GDIP1-T14, GDIP1-T16, GDIP1-T18 and GDIP1-T20.

N (R-PDIP-T**)

PLASTIC DUAL-IN-LINE PACKAGE

16 PINS SHOWN



- NOTES:
- A. All linear dimensions are in inches (millimeters).
 - B. This drawing is subject to change without notice.
 - $\triangle C$ Falls within JEDEC MS-001, except 18 and 20 pin minimum body length (Dim A).
 - $\triangle D$ The 20 pin end lead shoulder width is a vendor option, either half or full width.

4040049/E 12/2002

IMPORTANT NOTICE AND DISCLAIMER

TI PROVIDES TECHNICAL AND RELIABILITY DATA (INCLUDING DATASHEETS), DESIGN RESOURCES (INCLUDING REFERENCE DESIGNS), APPLICATION OR OTHER DESIGN ADVICE, WEB TOOLS, SAFETY INFORMATION, AND OTHER RESOURCES "AS IS" AND WITH ALL FAULTS, AND DISCLAIMS ALL WARRANTIES, EXPRESS AND IMPLIED, INCLUDING WITHOUT LIMITATION ANY IMPLIED WARRANTIES OF MERCHANTABILITY, FITNESS FOR A PARTICULAR PURPOSE OR NON-INFRINGEMENT OF THIRD PARTY INTELLECTUAL PROPERTY RIGHTS.

These resources are intended for skilled developers designing with TI products. You are solely responsible for (1) selecting the appropriate TI products for your application, (2) designing, validating and testing your application, and (3) ensuring your application meets applicable standards, and any other safety, security, or other requirements. These resources are subject to change without notice. TI grants you permission to use these resources only for development of an application that uses the TI products described in the resource. Other reproduction and display of these resources is prohibited. No license is granted to any other TI intellectual property right or to any third party intellectual property right. TI disclaims responsibility for, and you will fully indemnify TI and its representatives against, any claims, damages, costs, losses, and liabilities arising out of your use of these resources.

TI's products are provided subject to TI's Terms of Sale (<https://www.ti.com/legal/termsofsale.html>) or other applicable terms available either on [ti.com](https://www.ti.com) or provided in conjunction with such TI products. TI's provision of these resources does not expand or otherwise alter TI's applicable warranties or warranty disclaimers for TI products.

Mailing Address: Texas Instruments, Post Office Box 655303, Dallas, Texas 75265
Copyright © 2021, Texas Instruments Incorporated