

- **533-MHz Differential Clock Source for Direct Rambus™ Memory Systems for an 1066-MHz Data Transfer Rate**
- **Synchronizes the Clock Domains of the Rambus Channel With an External System or Processor Clock**
- **Three Power Operating Modes to Minimize Power for Mobile and Other Power-Sensitive Applications**
- **Operates From a Single 3.3-V Supply and 120 mW at 300 MHz (Typ)**
- **Packaged in a Shrink Small-Outline Package (DBQ)**
- **Supports Frequency Multipliers: 4, 6, 8, 16/3**
- **No External Components Required for PLL**
- **Supports Independent Channel Clocking**
- **Spread Spectrum Clocking Tracking Capability to Reduce EMI**
- **Designed for Use With TI's 133-MHz Clock Synthesizers CDC924 and CDC921**
- **Cycle-Cycle Jitter Is Less Than 40 ps at 533 MHz**
- **Certified by Gigatest Labs to Exceed the Rambus DRCG Validation Requirement**
- **Supports Industrial Temperature Range of –40°C to 85°C**

**DBQ PACKAGE
(TOP VIEW)**

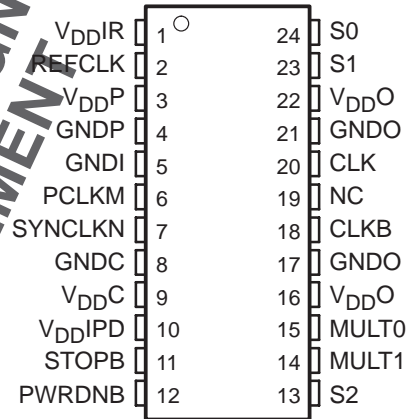

NC – No internal connection

description

The Direct Rambus clock generator (DRCG) provides the necessary clock signals to support a Direct Rambus memory subsystem. It includes signals to synchronize the Direct Rambus channel clock to an external system or processor clock. It is designed to support Direct Rambus memory on a desktop, workstation, server, and mobile PC motherboards. DRCG also provides an off-the-shelf solution for a broad range of Direct Rambus memory applications.

The DRCG provides clock multiplication and phase alignment for a Direct Rambus memory subsystem to enable synchronous communication between the Rambus channel and ASIC clock domains. In a Direct Rambus memory subsystem, a system clock source provides the REFCLK and PCLK clock references to the DRCG and memory controller, respectively. The DRCG multiplies REFCLK and drives a high-speed BUSCLK to RDRAMs and the memory controller. Gear ratio logic in the memory controller divides the PCLK and BUSCLK frequencies by ratios M and N such that PCLKM = SYNCLKN, where SYNCLK = BUSCLK/4. The DRCG detects the phase difference between PCLKM and SYNCLKN and adjusts the phase of BUSCLK such that the skew between PCLKM and SYNCLKN is minimized. This allows data to be transferred across the SYNCLK/PCLK boundary without incurring additional latency.

User control is provided by multiply and mode selection terminals. The multiply terminals provide selection of one of four clock frequency multiply ratios, generating BUSCLK frequencies ranging from 267 MHz to 533 MHz with clock references ranging from 33 MHz to 100 MHz. The mode select terminals can be used to select a bypass mode where the frequency multiplied reference clock is directly output to the Rambus channel for systems where synchronization between the Rambus clock and a system clock is not required. Test modes are provided to bypass the PLL and output REFCLK on the Rambus channel and to place the outputs in a high-impedance state for board testing.

The CDCFR83 is characterized for operation over free-air temperatures of –40°C to 85°C.



Please be aware that an important notice concerning availability, standard warranty, and use in critical applications of Texas Instruments semiconductor products and disclaimers thereto appears at the end of this data sheet.

Direct Rambus and Rambus are trademarks of Rambus Inc.

PRODUCTION DATA information is current as of publication date. Products conform to specifications per the terms of Texas Instruments standard warranty. Production processing does not necessarily include testing of all parameters.



POST OFFICE BOX 655303 • DALLAS, TEXAS 75265

Copyright © 2001 – 2005, Texas Instruments Incorporated

CDCFR83 DIRECT RAMBUS™ CLOCK GENERATOR

SCAS665B – APRIL 2001 REVISED OCTOBER 2005

functional block diagram

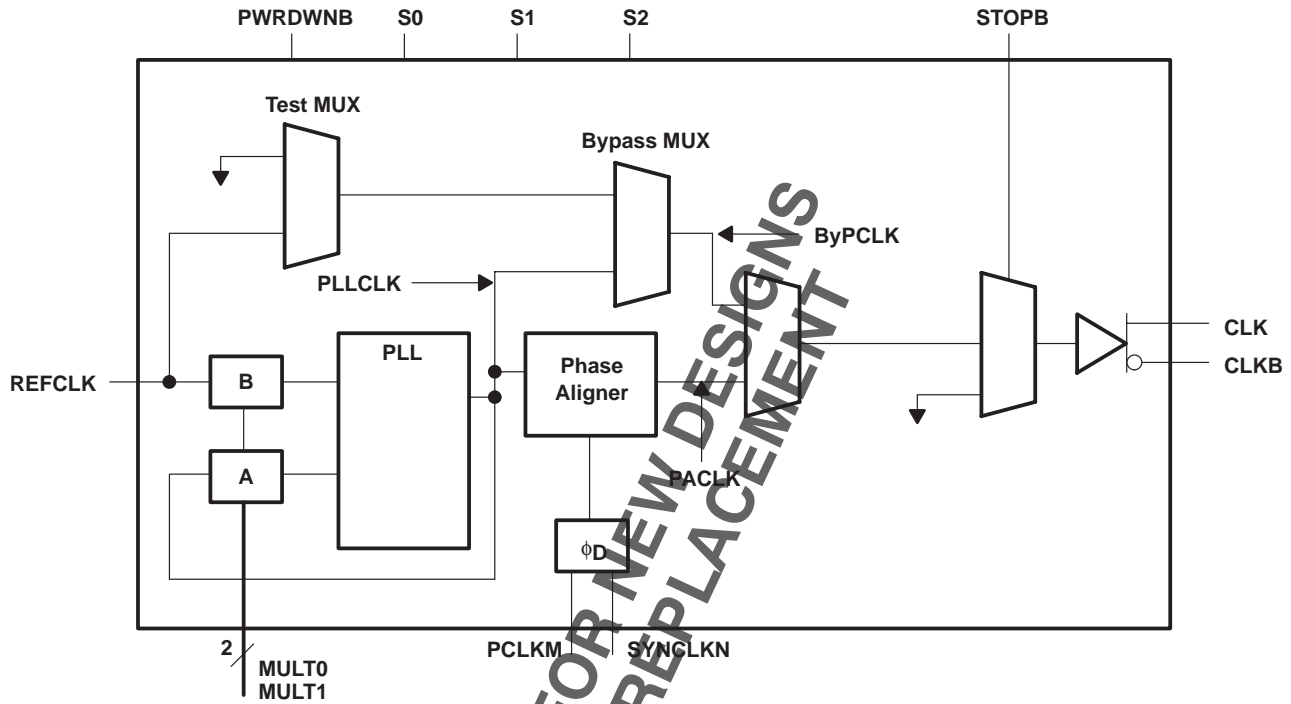

FUNCTION TABLE†

MODE	S0	S1	S2	CLK	CLKB
Normal	0	0	0	Phase aligned clock	Phase aligned clock B
Bypass	1	0	0	PLLCLK	PLLCLKB
Test	1	1	0	REFCLK	REFCLKB
Output test (OE)	0	0	X	Hi-Z	Hi-Z
Reserved	0	1	—	—	—
Reserved	1	0	1	—	—
Reserved	1	1	1	Hi-Z	Hi-Z

† X = don't care, Hi-Z = high impedance

NOT RECOMMENDED FOR NEW DESIGNS
USE CDCFR63A AS A REPLACEMENT

Terminal Functions

TERMINAL NAME	NO.	I/O	DESCRIPTION
CLK	20	O	Output clock
CLKB	18	O	Output clock (complement)
GNDC	8		GND for phase aligner
GNDI	5		GND for control inputs
GNDO	17, 21		GND for clock outputs
GNDP	4		GND for PLL
MULT0	15	I	PLL multiplier select
MULT1	14	I	PLL multiplier select
NC	19		Not used
PCLKM	6	I	Phase detector input
PWRDNB	12	I	Active low power down
REFCLK	2	I	Reference clock
S0	24	I	Mode control
S1	23	I	Mode control
S2	13	I	Mode control
STOPB	11	I	Active low output disable
SYNCLKN	7	I	Phase detector input
V _{DDC}	9		V _{DD} for phase aligner
V _{DDIPD}	10		Reference voltage for phase detector inputs and STOPB
V _{DDIR}	1		Reference voltage for REFCLK
V _{DDO}	16, 22		V _{DD} for clock outputs
V _{DDP}	3		V _{DD} for PLL

NOT RECOMMENDED FOR NEW DESIGNS
USE CDCFR83A AS A REPLACEMENT

CDCFR83 DIRECT RAMBUS™ CLOCK GENERATOR

SCAS665B – APRIL 2001 REVISED OCTOBER 2005

PLL divider selection

Table 1 lists the supported REFCLK and BUSCLK frequencies. Other REFCLK frequencies are permitted, provided that (267 MHz < BUSCLK < 533 MHz) and (33 MHz < REFCLK < 100 MHz).

Table 1. REFCLK and BUSCLK Frequencies

MULT0	MULT1	REFCLK (MHz)	MULTIPLY RATIO	BUSCLK (MHz)
0	0	67	4	267
0	1	50	6	300
0	1	67	6	400
1	1	33	8	267
1	1	50	8	400
1	1	67	8	533
1	0	67	16/3	356

Table 2. Clock Output Driver States

STATE	PWRDNB	STOPB	CLK	CLKB
Powerdown	0	X	GND	GND
CLK stop	1	0	V _X , STOP	V _X , STOP
Normal	1	1	PACLK/PLLCLK/ REFCLK†	PACLKB/PLLCLKB/ REFCLKB

† Depending on the state of S0, S1, and S2

absolute maximum ratings over operating free-air temperature (unless otherwise noted)†

Supply voltage range, V _{DD} (see Note 1)	–0.5 V to 4 V
Output voltage range, V _O , at any output terminal	–0.5 V to V _{DD} + 0.5 V
Input voltage range, V _I , at any input terminal	–0.5 V to V _{DD} + 0.5 V
Continuous total power dissipation	see Dissipation Rating Table
Operating free-air temperature range, T _A	–40°C to 85°C
Storage temperature range, T _{stg}	–65°C to 150°C
Lead temperature 1,6 mm (1/16 inch) from case for 10 seconds	260°C

† Stresses beyond those listed under “absolute maximum ratings” may cause permanent damage to the device. These are stress ratings only, and functional operation of the device at these or any other conditions beyond those indicated under “recommended operating conditions” is not implied. Exposure to absolute-maximum-rated conditions for extended periods may affect device reliability.

NOTE 1: All voltage values are with respect to the GND terminals.

DISSIPATION RATING TABLE

PACKAGE	T _A = 25°C	DERATING FACTOR	T _A = 70°C	T _A = 85°C
	POWER RATING	ABOVE T _A = 25°C‡	POWER RATING	POWER RATING
DBQ	1400 mW	11 mW/°C	905 mW	740 mW

‡ This is the inverse of the junction-to-ambient thermal resistance when board-mounted and with no air flow.



recommended operating conditions

	MIN	NOM	MAX	UNIT
Supply voltage, V_{DD}	3.135	3.3	3.465	V
High-level input voltage, V_{IH} (CMOS)	$0.7 \times V_{DD}$			V
Low-level input voltage, V_{IL} (CMOS)	$0.3 \times V_{DD}$			V
Initial phase error at phase detector inputs (required range for phase aligner)	$-0.5 \times t_c(\text{PD})$		$0.5 \times t_c(\text{PD})$	
REFCLK low-level input voltage, V_{IL}	$0.3 \times V_{DDIR}$			V
REFCLK high-level input voltage, V_{IH}	$0.7 \times V_{DDIR}$			V
Input signal low voltage, V_{IL} (STOPB)	$0.3 \times V_{DDIPD}$			V
Input signal high voltage, V_{IH} (STOPB)	$0.7 \times V_{DDIPD}$			V
Input reference voltage for (REFCLK) (V_{DDIR})	1.235		3.465	V
Input reference voltage for (PCLKM and SYNCLKN) (V_{DDIPD})	1.235		3.465	V
High-level output current, I_{OH}				-16 mA
Low-level output current, I_{OL}				16 mA
Operating free-air temperature, T_A	-40		85	°C

timing requirements

	MIN	MAX	UNIT
Input cycle time, $t_{c(in)}$	10	40	ns
Input cycle-to-cycle jitter		250	ps
Input duty cycle over 10,000 cycles	40%	60%	
Input frequency modulation, f_{mod}	30	33	kHz
Modulation index, nonlinear maximum 0.5%		0.6%	
Phase detector input cycle time (PCLKM and SYNCLKN)	30	100	ns
Input slew rate, SR	1	4	V/ns
Input duty cycle (PCLKM and SYNCLKN)	25%	75%	

NOT RECOMMENDED FOR NEW DESIGNS
USE CDCFR83A AS A REPLACEMENT

CDCFR83 DIRECT RAMBUS™ CLOCK GENERATOR

SCAS665B – APRIL 2001 REVISED OCTOBER 2005

electrical characteristics over recommended operating free-air temperature range (unless otherwise noted)

PARAMETER		TEST CONDITIONST	MIN	TYP‡	MAX	UNIT	
$V_{O(STOP)}$	Output voltage during CLK Stop (STOPB = 0)	See Figure 1	1.1		2		
$V_{O(X)}$	Output crossing-point voltage	See Figure 1 and Figure 6	1.3		1.8	V	
V_O	Output voltage swing	See Figure 1	0.4		0.6	V	
V_{IK}	Input clamp voltage	$V_{DD} = 3.135\text{ V}$, $I_I = -18\text{ mA}$			-1.2	V	
V_{OH}	High-level output voltage	See Figure 1			2	V	
		$V_{DD} = \text{min to max}$, $I_{OH} = -4\text{ mA}$	$V_{DD} - 0.1\text{ V}$				
		$V_{DD} = 3.135\text{ V}$, $I_{OH} = -16\text{ mA}$	2.4				
V_{OL}	Low-level output voltage	See Figure 1	1			V	
		$V_{DD} = \text{min to max}$, $I_{OL} = 4\text{ mA}$			0.1		
		$V_{DD} = 3.135\text{ V}$, $I_{OL} = 16\text{ mA}$			0.5		
I_{OH}	High-level output current	$V_{DD} = 3.135\text{ V}$, $V_O = 1\text{ V}$	-32	-52		mA	
		$V_{DD} = 3.3\text{ V}$, $V_O = 1.65\text{ V}$		-51			
		$V_{DD} = 3.465\text{ V}$, $V_O = 3.135\text{ V}$	-14.5	-21			
I_{OL}	Low-level output current	$V_{DD} = 3.135\text{ V}$, $V_O = 1.95\text{ V}$	43	61.5		mA	
		$V_{DD} = 3.3\text{ V}$, $V_O = 1.65\text{ V}$		65			
		$V_{DD} = 3.465\text{ V}$, $V_O = 0.4\text{ V}$	25.5	36			
I_{OZ}	High-impedance-state output current	$S_0 = 0$, $S_1 = 1$			± 10	μA	
$I_{OZ(STOP)}$	High-impedance-state output current during CLK stop	Stop = 0, $V_O = \text{GND or } V_{DD}$			± 100	μA	
$I_{OZ(PD)}$	High-impedance-state output current in power-down state	PWRDNB = 0, $V_O = \text{GND or } V_{DD}$	-10		100	μA	
I_{IH}	High-level input current	REFCLK, PCLKM, SYNCLKN, STOPB	$V_{DD} = 3.465\text{ V}$, $V_I = V_{DD}$		10	μA	
		PWRDNB, S0, S1, S2, MULT0, MULT1	$V_{DD} = 3.465\text{ V}$, $V_I = V_{DD}$		10		
I_{IL}	Low-level input current	REFCLK, PCLKM, SYNCLKN, STOPB	$V_{DD} = 3.465\text{ V}$, $V_I = 0$		-10	μA	
		PWRDNB, S0, S1, S2, MULT0, MULT1	$V_{DD} = 3.465\text{ V}$, $V_I = 0$		-10		
Z_O	Output impedance	High state	R_I at $I_O -14.5\text{ mA to } -16.5\text{ mA}$	15	35	50	Ω
		Low state	R_I at $I_O 14.5\text{ mA to } 16.5\text{ mA}$	11	17	35	
Reference current	V_{DDIR} , V_{DDIPD}	$V_{DD} = 3.465\text{ V}$	PWRDNB = 0		50	μA	
			PWRDNB = 1		0.5	mA	
C_I	Input capacitance	$V_I = V_{DD}$ or GND		2		pF	
C_O	Output capacitance	$V_O = V_{DD}$ or GND		3		pF	
$I_{DD(PD)}$	Supply current in power-down state	REFCLK = 0 MHz to 100 MHz, PWRDNB = 0, STOPB = 1			100	μA	
$I_{DD(CLKSTOP)}$	Supply current in CLK stop state	BUSCLK configured for 533 MHz			45	mA	
$I_{DD(NORMAL)}$	Supply current in normal state	BUSCLK = 533 MHz			100	mA	

† V_{DD} refers to any of the following; V_{DD} , V_{DDIPD} , V_{DDIR} , V_{DDO} , V_{DDC} , and V_{DDP}

‡ All typical values are at $V_{DD} = 3.3\text{ V}$, $T_A = 25^\circ\text{C}$.



switching characteristics over recommended operating free-air temperature range (unless otherwise noted)

PARAMETER		TEST CONDITIONS	MIN	TYP†	MAX	UNIT	
t _{c(out)}	Clock output cycle time		1.87		3.75	ns	
t _(jitter)	Total cycle jitter over 1, 2, 3, 4, 5, or 6 clock cycles	Infinite and stopped phase alignment	267 MHz	See Figure 3	80	ps	
					300 MHz		70
					356 MHz		60
					400 MHz		50
					533 MHz§		40
t _(phase)	Phase detector phase error for distributed loop	Static phase error‡	-100		100	ps	
t _(phase, SSC)	PLL output phase error when tracking SSC	Dynamic phase error‡	-100		100	ps	
t _(DC)	Output duty cycle over 10,000 cycles	See Figure 4	45%		55%		
t _(DC, err)	Output cycle-to-cycle duty cycle error	Infinite and stopped phase alignment	267 MHz	See Figure 5	80	ps	
					300 MHz		70
					356 MHz		60
					400 MHz		50
					533 MHz		50
t _r , t _f	Output rise and fall times (measured at 20%–80% of output voltage)	See Figure 7	160		400	ps	
Δt	Difference between rise and fall times on a single device (20%–80%) t _f – t _r	See Figure 7			100	ps	

† All typical values are at V_{DD} = 3.3 V, T_A = 25°C.

‡ Assured by design

§ Jitter measurement according to Rambus validation specification

state transition latency specifications

PARAMETER		FROM	TO	TEST CONDITIONS	MIN	TYP†	MAX	UNIT
t _(powerup)	Delay time, PWRDNB↑ to CLK/CLKB output settled (excluding t _(DISTLOCK))	Powerdown	Normal	See Figure 8			3	ms
	Delay time, PWRDNB↑ to internal PLL and clock are on and settled						3	
t _(VDDpowerup)	Delay time, power up to CLK/CLKB output settled	V _{DD}	Normal	See Figure 8			3	ms
	Delay time, power up to internal PLL and clock are on and settled						3	
t _(MULT)	MULT0 and MULT1 change to CLK/CLKB output resettled (excluding t _(DISTLOCK))	Normal	Normal	See Figure 9			1	ms
t _(CLKON)	STOPB↑ to CLK/CLKB glitch-free clock edges	CLK Stop	Normal	See Figure 10			10	ns
t _(CLKSETL)	STOPB↑ to CLK/CLKB output settled to within 50 ps of the phase before STOPB was disabled	CLK Stop	Normal	See Figure 10			20	cycles
t _(CLKOFF)	STOPB↓ to CLK/CLKB output disabled	Normal	CLK Stop	See Figure 10			5	ns

† All typical values are at V_{DD} = 3.3 V, T_A = 25°C.

CDCFR83 DIRECT RAMBUS™ CLOCK GENERATOR

SCAS665B – APRIL 2001 REVISED OCTOBER 2005

state transition latency specifications (continued)

PARAMETER	FROM	TO	TEST CONDITIONS	MIN	TYP†	MAX	UNIT
$t_{(\text{powerdown})}$	Normal	Powerdown	See Figure 8			1	ms
$t_{(\text{STOP})}$	STOPB	Normal	See Figure 10			100	μs
$t_{(\text{ON})}$	Normal	CLK stop	See Figure 10	100			ms
$t_{(\text{DISTLOCK})}$	Unlocked	Locked				5	ms

† All typical values are at $V_{DD} = 3.3\text{ V}$, $T_A = 25^\circ\text{C}$.

PARAMETER MEASUREMENT INFORMATION

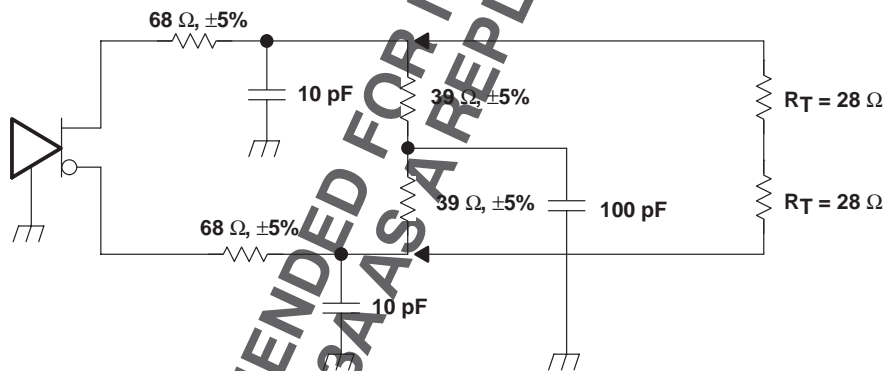
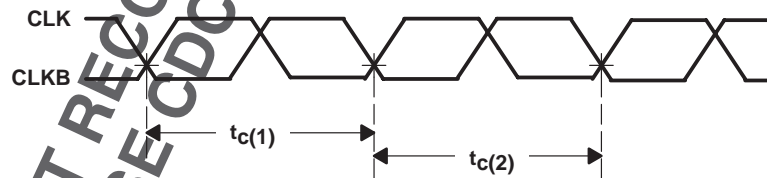

Figure 1. Test Load and Voltage Definitions ($V_{O(\text{STOP})}$, $V_{O(X)}$, V_O , V_{OH} , V_{OL})



cycle-to-cycle jitter = $|t_{c(1)} - t_{c(2)}|$ over 10000 consecutive cycles

Figure 2. Cycle-to-Cycle Jitter

PARAMETER MEASUREMENT INFORMATION

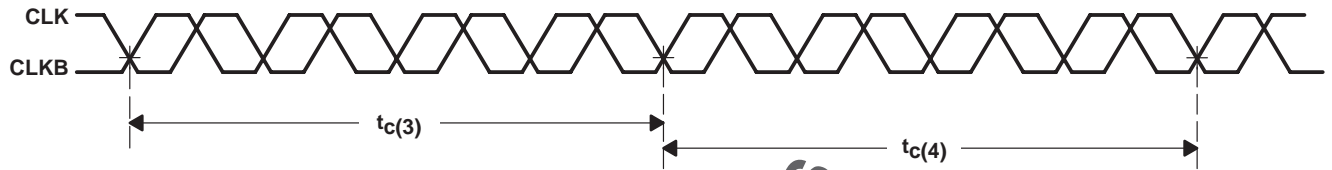

Cycle-to-cycle jitter = $|t_{c(3)} - t_{c(4)}|$ over 10000 consecutive cycles

Figure 3. Short Term Cycle-to-Cycle Jitter Over Four Cycles

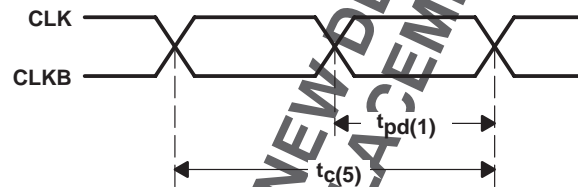

Duty cycle = $(t_{pd(1)}/t_{c(5)})$

Figure 4. Output Duty Cycle

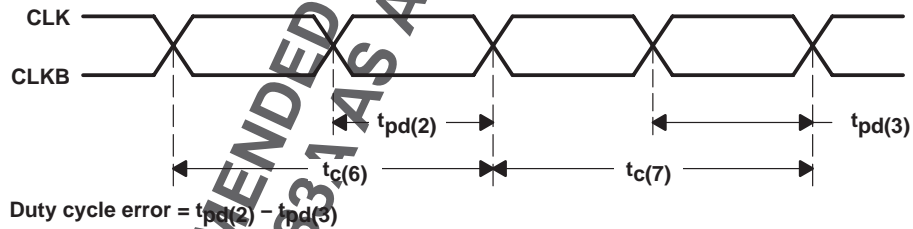

Duty cycle error = $t_{pd(2)} - t_{pd(3)}$

Figure 5. Duty Cycle Error (Cycle-to-Cycle)

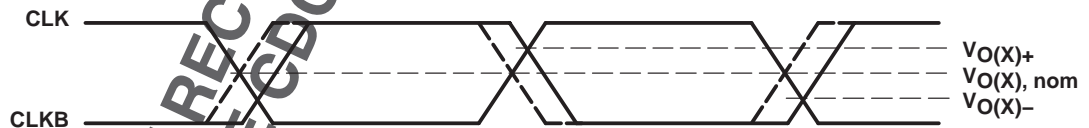

Figure 6. Crossing-Point Voltage



Figure 7. Voltage Waveforms

NOT RECOMMENDED FOR NEW DESIGNS
 USE CDCFR831 AS A REPLACEMENT

PARAMETER MEASUREMENT INFORMATION

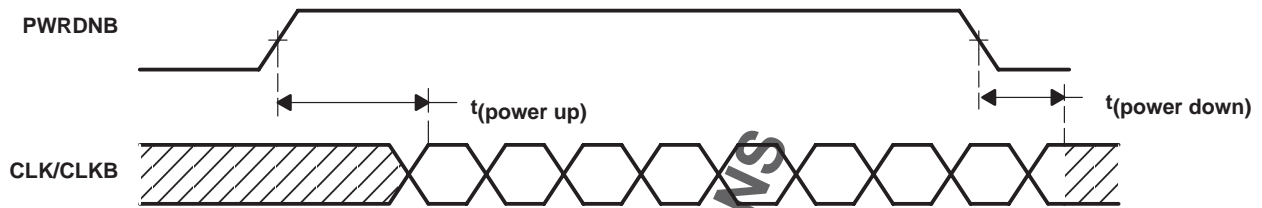
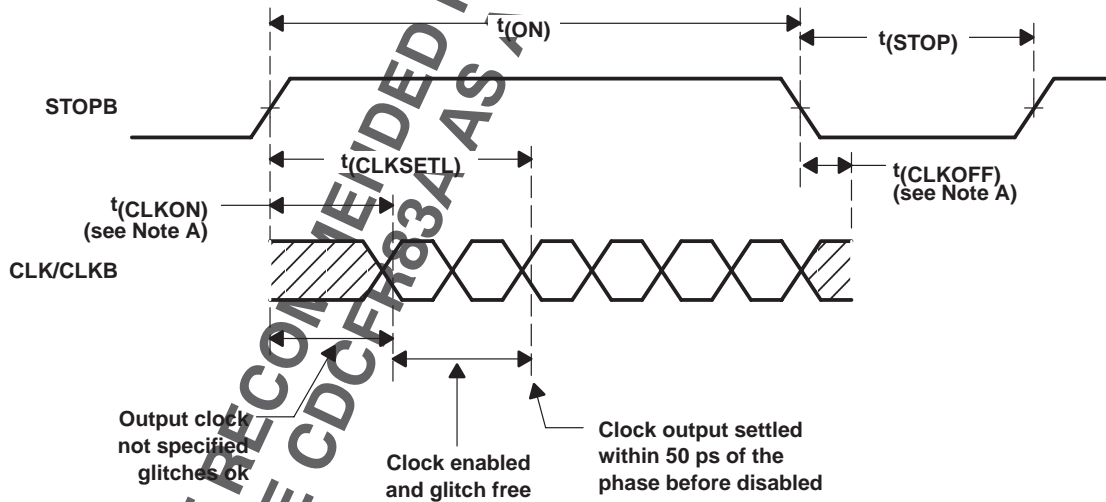

Figure 8. PWRDNB Transition Timings



Figure 9. MULT Transition Timings



NOTE A: $V_{ref} = V_O \pm 200 \text{ mV}$

Figure 10. STOPB Transition Timings

NOT RECOMMENDED FOR NEW DESIGNS
 USE CDCFR83 AS A REFERENCE

PACKAGING INFORMATION

Orderable Device	Status (1)	Package Type	Package Drawing	Pins	Package Qty	Eco Plan (2)	Lead finish/ Ball material (6)	MSL Peak Temp (3)	Op Temp (°C)	Device Marking (4/5)	Samples
CDCFR83DBQR	NRND	SSOP	DBQ	24	2500	RoHS & Green	NIPDAU	Level-2-260C-1 YEAR	-40 to 85	CDCFR83	
CDCFR83DBQRG4	NRND	SSOP	DBQ	24	2500	RoHS & Green	NIPDAU	Level-2-260C-1 YEAR	-40 to 85	CDCFR83	

(1) The marketing status values are defined as follows:

ACTIVE: Product device recommended for new designs.

LIFEBUY: TI has announced that the device will be discontinued, and a lifetime-buy period is in effect.

NRND: Not recommended for new designs. Device is in production to support existing customers, but TI does not recommend using this part in a new design.

PREVIEW: Device has been announced but is not in production. Samples may or may not be available.

OBSOLETE: TI has discontinued the production of the device.

(2) **RoHS:** TI defines "RoHS" to mean semiconductor products that are compliant with the current EU RoHS requirements for all 10 RoHS substances, including the requirement that RoHS substance do not exceed 0.1% by weight in homogeneous materials. Where designed to be soldered at high temperatures, "RoHS" products are suitable for use in specified lead-free processes. TI may reference these types of products as "Pb-Free".

RoHS Exempt: TI defines "RoHS Exempt" to mean products that contain lead but are compliant with EU RoHS pursuant to a specific EU RoHS exemption.

Green: TI defines "Green" to mean the content of Chlorine (Cl) and Bromine (Br) based flame retardants meet JS709B low halogen requirements of <=1000ppm threshold. Antimony trioxide based flame retardants must also meet the <=1000ppm threshold requirement.

(3) MSL, Peak Temp. - The Moisture Sensitivity Level rating according to the JEDEC industry standard classifications, and peak solder temperature.

(4) There may be additional marking, which relates to the logo, the lot trace code information, or the environmental category on the device.

(5) Multiple Device Markings will be inside parentheses. Only one Device Marking contained in parentheses and separated by a "~" will appear on a device. If a line is indented then it is a continuation of the previous line and the two combined represent the entire Device Marking for that device.

(6) Lead finish/Ball material - Orderable Devices may have multiple material finish options. Finish options are separated by a vertical ruled line. Lead finish/Ball material values may wrap to two lines if the finish value exceeds the maximum column width.

Important Information and Disclaimer:The information provided on this page represents TI's knowledge and belief as of the date that it is provided. TI bases its knowledge and belief on information provided by third parties, and makes no representation or warranty as to the accuracy of such information. Efforts are underway to better integrate information from third parties. TI has taken and continues to take reasonable steps to provide representative and accurate information but may not have conducted destructive testing or chemical analysis on incoming materials and chemicals. TI and TI suppliers consider certain information to be proprietary, and thus CAS numbers and other limited information may not be available for release.

In no event shall TI's liability arising out of such information exceed the total purchase price of the TI part(s) at issue in this document sold by TI to Customer on an annual basis.

TAPE AND REEL INFORMATION



QUADRANT ASSIGNMENTS FOR PIN 1 ORIENTATION IN TAPE



*All dimensions are nominal

Device	Package Type	Package Drawing	Pins	SPQ	Reel Diameter (mm)	Reel Width W1 (mm)	A0 (mm)	B0 (mm)	K0 (mm)	P1 (mm)	W (mm)	Pin1 Quadrant
CDCFR83DBQR	SSOP	DBQ	24	2500	330.0	16.4	6.5	9.0	2.1	8.0	16.0	Q1

TAPE AND REEL BOX DIMENSIONS



*All dimensions are nominal

Device	Package Type	Package Drawing	Pins	SPQ	Length (mm)	Width (mm)	Height (mm)
CDCFR83DBQR	SSOP	DBQ	24	2500	853.0	449.0	35.0

IMPORTANT NOTICE AND DISCLAIMER

TI PROVIDES TECHNICAL AND RELIABILITY DATA (INCLUDING DATASHEETS), DESIGN RESOURCES (INCLUDING REFERENCE DESIGNS), APPLICATION OR OTHER DESIGN ADVICE, WEB TOOLS, SAFETY INFORMATION, AND OTHER RESOURCES "AS IS" AND WITH ALL FAULTS, AND DISCLAIMS ALL WARRANTIES, EXPRESS AND IMPLIED, INCLUDING WITHOUT LIMITATION ANY IMPLIED WARRANTIES OF MERCHANTABILITY, FITNESS FOR A PARTICULAR PURPOSE OR NON-INFRINGEMENT OF THIRD PARTY INTELLECTUAL PROPERTY RIGHTS.

These resources are intended for skilled developers designing with TI products. You are solely responsible for (1) selecting the appropriate TI products for your application, (2) designing, validating and testing your application, and (3) ensuring your application meets applicable standards, and any other safety, security, or other requirements. These resources are subject to change without notice. TI grants you permission to use these resources only for development of an application that uses the TI products described in the resource. Other reproduction and display of these resources is prohibited. No license is granted to any other TI intellectual property right or to any third party intellectual property right. TI disclaims responsibility for, and you will fully indemnify TI and its representatives against, any claims, damages, costs, losses, and liabilities arising out of your use of these resources.

TI's products are provided subject to TI's Terms of Sale (<https://www.ti.com/legal/termsofsale.html>) or other applicable terms available either on [ti.com](https://www.ti.com) or provided in conjunction with such TI products. TI's provision of these resources does not expand or otherwise alter TI's applicable warranties or warranty disclaimers for TI products.

Mailing Address: Texas Instruments, Post Office Box 655303, Dallas, Texas 75265
Copyright © 2021, Texas Instruments Incorporated