

CSD16321Q5 25V N-Channel NexFET™ Power MOSFET

1 Features

- Optimized for 5V gate drive
- Ultra-low Q_g and Q_{gd}
- Low-thermal resistance
- Avalanche rated
- Lead-free terminal plating
- RoHS compliant
- SON 5mm × 6mm plastic package

2 Applications

- Point-of-load synchronous buck converter for applications in networking, telecom, and computing systems
- Optimized for synchronous FET applications

3 Description

This 25V, 1.9mΩ, 5mm × 6mm SON NexFET™ power MOSFET has been designed to minimize losses in power conversion and optimized for 5V gate drive applications.

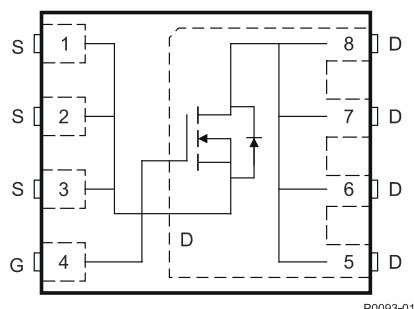

Top View

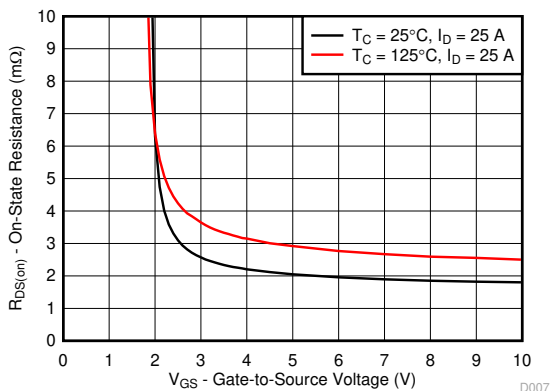

$R_{DS(ON)}$ vs V_{GS}

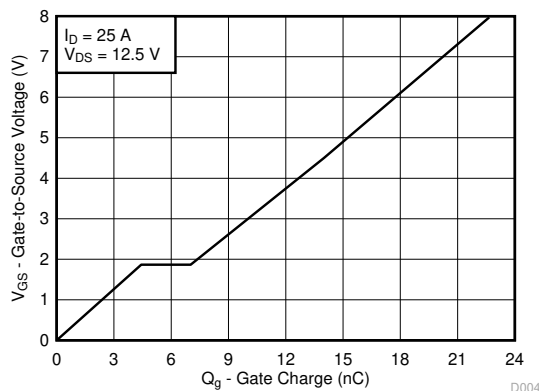

Gate Charge

Product Summary

$T_A = 25^\circ\text{C}$		TYPICAL VALUE	UNIT
V_{DS}	Drain-to-Source Voltage	25	V
Q_g	Gate Charge Total (4.5V)	14	nC
Q_{gd}	Gate Charge Gate-to-Drain	2.5	nC
$R_{DS(on)}$	Drain-to-Source On Resistance	$V_{GS} = 3\text{V}$	2.8
		$V_{GS} = 4.5\text{V}$	2.1
		$V_{GS} = 8\text{V}$	1.9
$V_{GS(th)}$	Threshold Voltage	1.1	V

Device Information⁽¹⁾

DEVICE	MEDIA	QTY	PACKAGE	SHIP
CSD16321Q5	13-Inch Reel	2500	SON 5.00mm × 6.00mm Plastic Package	Tape and Reel
CSD16321Q5T	7-Inch Reel	250		

- (1) For all available packages, see the orderable addendum at the end of the data sheet.

Absolute Maximum Ratings

$T_A = 25^\circ\text{C}$		VALUE	UNIT
V_{DS}	Drain-to-Source Voltage	25	V
V_{GS}	Gate-to-Source Voltage	+10 / -8	V
I_D	Continuous Drain Current (Package Limited)	100	A
	Continuous Drain Current (Silicon Limited), $T_C = 25^\circ\text{C}$	177	
	Continuous Drain Current ⁽¹⁾	29	
I_{DM}	Pulsed Drain Current ⁽²⁾	400	A
P_D	Power Dissipation ⁽¹⁾	3.1	W
	Power Dissipation, $T_C = 25^\circ\text{C}$	113	
T_J, T_{stg}	Operating Junction, Storage Temperature	-55 to 150	$^\circ\text{C}$
E_{AS}	Avalanche Energy, Single Pulse $I_D = 66\text{ A}, L = 0.1\text{ mH}, R_G = 25\Omega$	218	mJ

- (1) Typical $R_{\theta JA} = 40^\circ\text{C/W}$ on 1in², 2oz Cu pad on 0.06in thick FR4 PCB.
 (2) Max $R_{\theta JC} = 1.1^\circ\text{C/W}$, pulse duration $\leq 100\mu\text{s}$, duty cycle $\leq 1\%$.



Table of Contents

1 Features	1	5.1 Receiving Notification of Documentation Updates.....	7
2 Applications	1	5.2 Support Resources.....	7
3 Description	1	5.3 Trademarks.....	7
4 Specifications	3	5.4 Electrostatic Discharge Caution.....	7
4.1 Electrical Characteristics.....	3	5.5 Glossary.....	7
4.2 Thermal Information.....	3	6 Revision History	8
4.3 Typical MOSFET Characteristics.....	4	7 Mechanical, Packaging, and Orderable Information	9
5 Device and Documentation Support	7		

4 Specifications

4.1 Electrical Characteristics

$T_A = 25^\circ\text{C}$ (unless otherwise stated)

PARAMETER		TEST CONDITIONS	MIN	TYP	MAX	UNIT
STATIC CHARACTERISTICS						
BV_{DSS}	Drain-to-source voltage	$V_{GS} = 0V, I_D = 250\mu A$	25			V
I_{DSS}	Drain-to-source leakage current	$V_{GS} = 0V, V_{DS} = 20V$			1	μA
I_{GSS}	Gate-to-source leakage current	$V_{DS} = 0V, V_{GS} = +10 / -8V$			100	nA
$V_{GS(th)}$	Gate-to-source threshold voltage	$V_{DS} = V_{GS}, I_D = 250\mu A$	0.9	1.1	1.4	V
$R_{DS(on)}$	Drain-to-source on resistance	$V_{GS} = 3V, I_D = 25A$		2.8	3.8	m Ω
		$V_{GS} = 4.5V, I_D = 25A$		2.1	2.6	
		$V_{GS} = 8V, I_D = 25A$		1.9	2.4	
g_{fs}	Transconductance	$V_{DS} = 12.5V, I_D = 25A$		150		S
DYNAMIC CHARACTERISTICS						
C_{iss}	Input capacitance	$V_{GS} = 0V, V_{DS} = 12.5V, f = 1MHz$		2360	3100	pF
C_{oss}	Output capacitance			1700	2200	pF
C_{riss}	Reverse transfer capacitance			115	150	pF
R_G	Series gate resistance			1.5	3	Ω
Q_g	Gate charge total (4.5 V)	$V_{DS} = 12.5V, I_D = 25A$		14	19	nC
Q_{gd}	Gate charge gate-to-drain			2.5		nC
Q_{gs}	Gate charge gate-to-source			4		nC
$Q_{g(th)}$	Gate charge at V_{th}			2.1		nC
Q_{oss}	Output charge	$V_{DS} = 15V, V_{GS} = 0V$		36		nC
$t_{d(on)}$	Turnon delay time	$V_{DS} = 12.5V, V_{GS} = 4.5V, I_D = 25A, R_G = 2\Omega$		9		ns
t_r	Rise time			15		ns
$t_{d(off)}$	Turnoff delay time			27		ns
t_f	Fall time			17		ns
DIODE CHARACTERISTICS						
V_{SD}	Diode forward voltage	$I_{SD} = 25A, V_{GS} = 0V$		0.8	1	V
Q_{rr}	Reverse recovery charge	$V_{DD} = 13V, I_F = 25A, di/dt = 300A/\mu s$		33		nC
t_{rr}	Reverse recovery time	$V_{DD} = 13V, I_F = 25A, di/dt = 300A/\mu s$		32		ns

4.2 Thermal Information

$T_A = 25^\circ\text{C}$ (unless otherwise stated)

PARAMETER		MIN	TYP	MAX	UNIT
$R_{\theta JC}$	Junction-to-case thermal resistance ⁽¹⁾			1.1	$^\circ\text{C/W}$
$R_{\theta JA}$	Junction-to-ambient thermal resistance ^{(1) (2)}			50	$^\circ\text{C/W}$

- $R_{\theta JC}$ is determined with the device mounted on a 1in², 2oz Cu pad on a 1.5in × 1.5in, 0.06in thick FR4 board. $R_{\theta JC}$ is specified by design while $R_{\theta JA}$ is determined by the user's board design.
- Device mounted on FR4 Material with 1 in² of 2oz Cu.

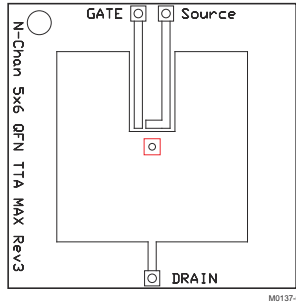

Max $R_{\theta JA}$ = 50°C/W when mounted on 1in² of 2oz Cu.

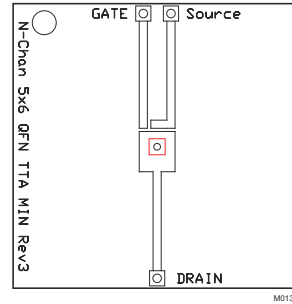

Max $R_{\theta JA}$ = 125°C/W when mounted on minimum pad area of 2oz Cu.

4.3 Typical MOSFET Characteristics

T_A = 25°C (unless otherwise stated)

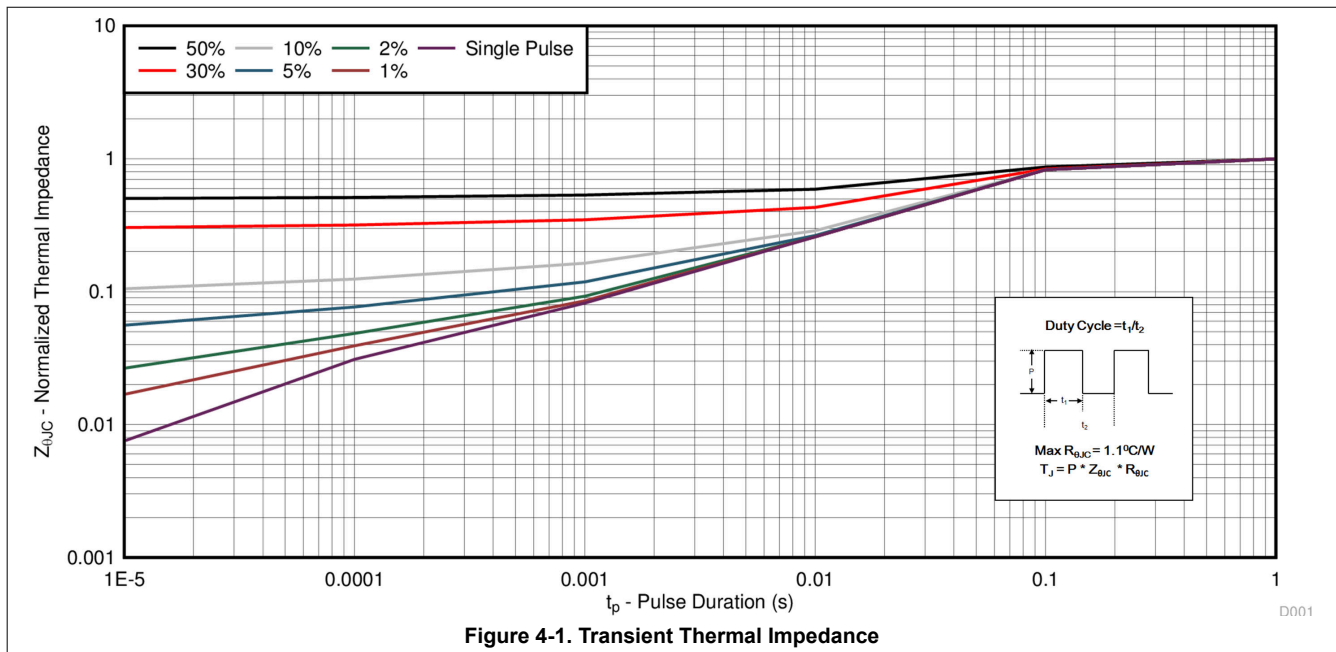

4.3 Typical MOSFET Characteristics (continued)

T_A = 25°C (unless otherwise stated)

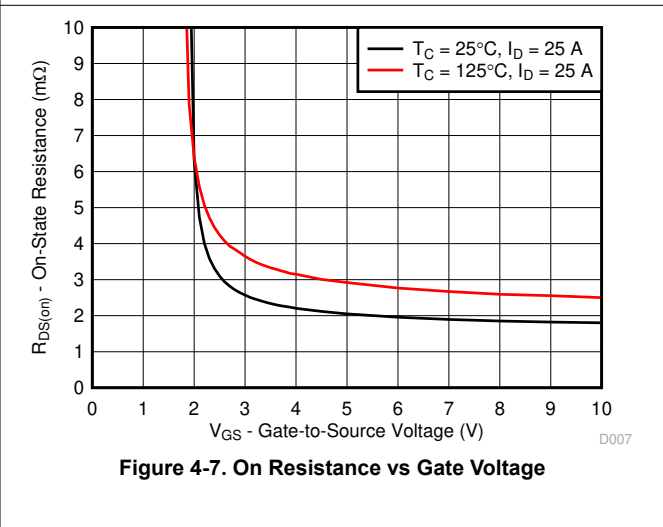
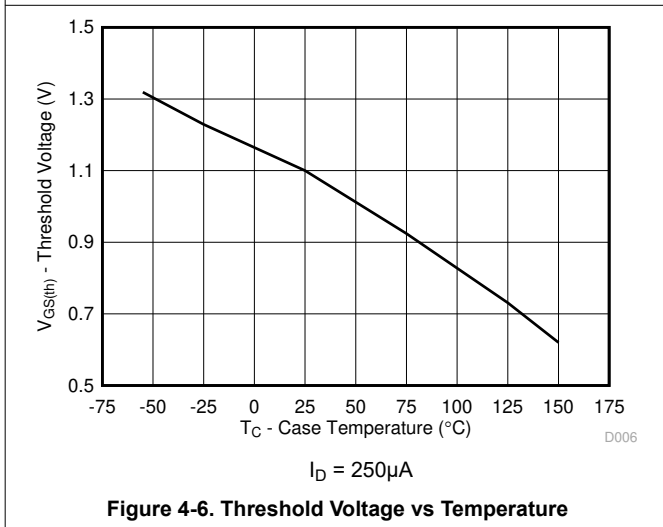
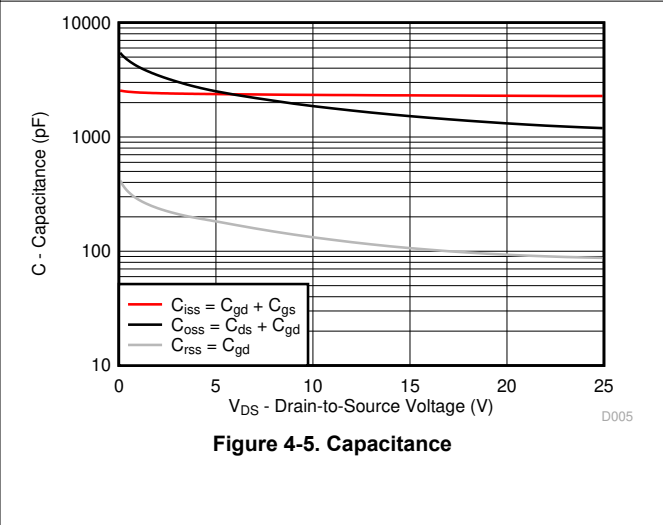
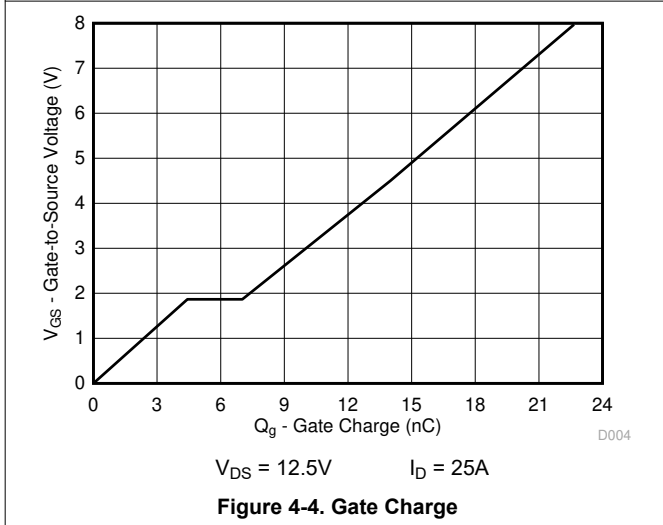
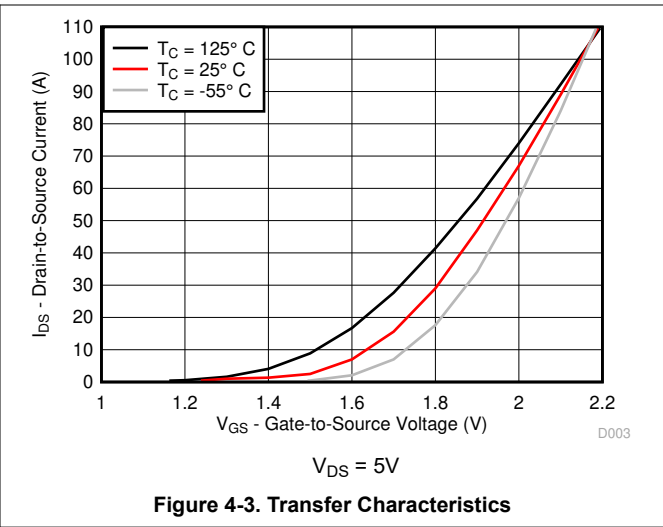
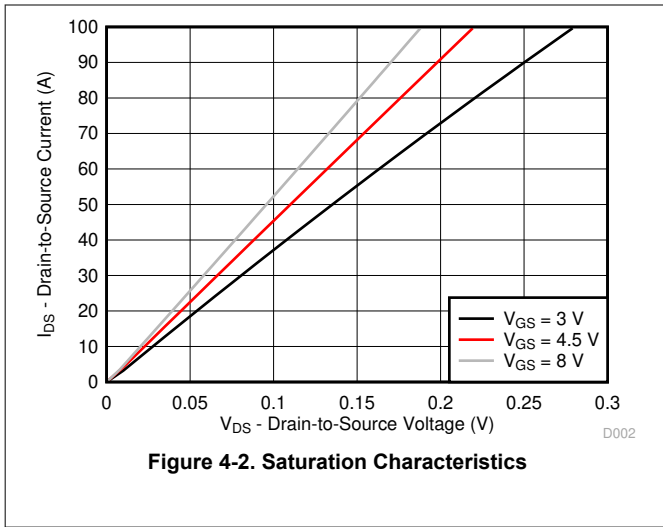

4.3 Typical MOSFET Characteristics (continued)

T_A = 25°C (unless otherwise stated)

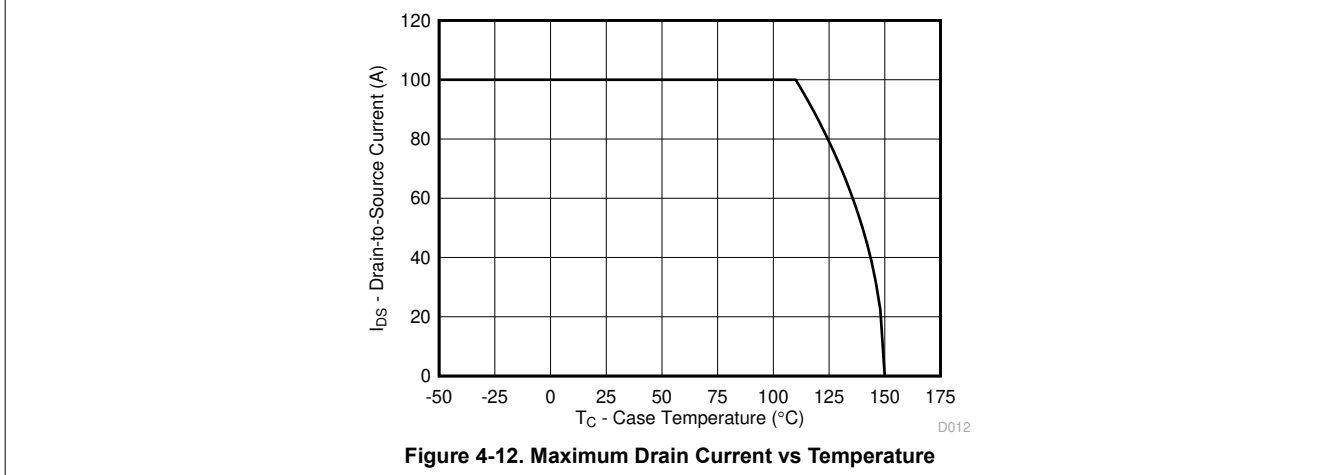
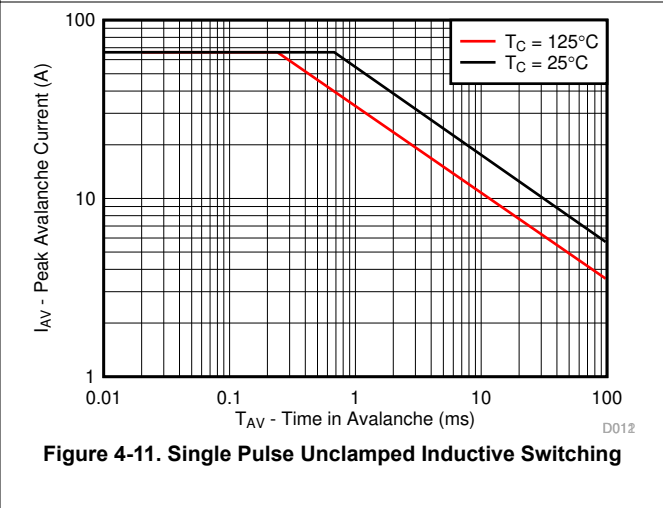
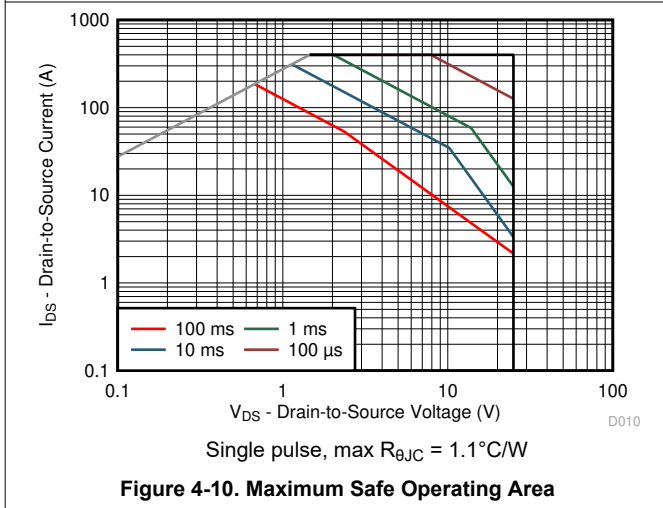
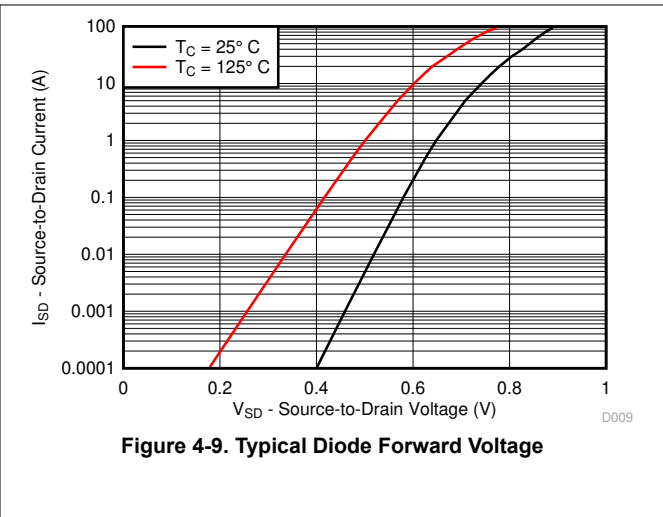
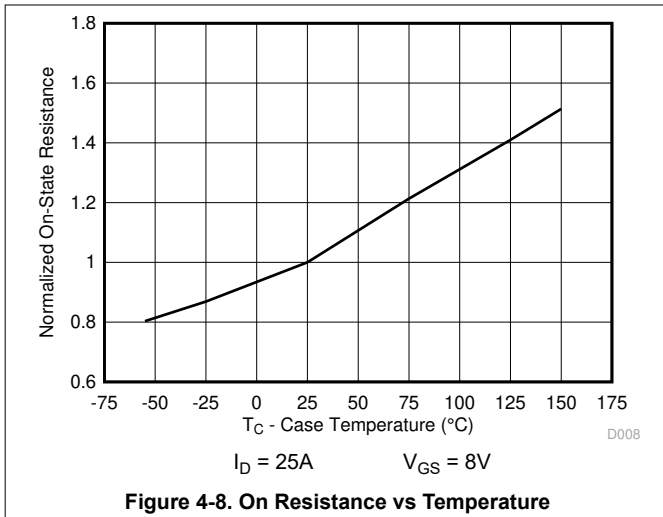

5 Device and Documentation Support

5.1 Receiving Notification of Documentation Updates

To receive notification of documentation updates, navigate to the device product folder on ti.com. Click on *Notifications* to register and receive a weekly digest of any product information that has changed. For change details, review the revision history included in any revised document.

5.2 Support Resources

[TI E2E™ support forums](#) are an engineer's go-to source for fast, verified answers and design help — straight from the experts. Search existing answers or ask your own question to get the quick design help you need.

Linked content is provided "AS IS" by the respective contributors. They do not constitute TI specifications and do not necessarily reflect TI's views; see TI's [Terms of Use](#).

5.3 Trademarks

NexFET™ and TI E2E™ are trademarks of Texas Instruments.
All trademarks are the property of their respective owners.

5.4 Electrostatic Discharge Caution



This integrated circuit can be damaged by ESD. Texas Instruments recommends that all integrated circuits be handled with appropriate precautions. Failure to observe proper handling and installation procedures can cause damage.

ESD damage can range from subtle performance degradation to complete device failure. Precision integrated circuits may be more susceptible to damage because very small parametric changes could cause the device not to meet its published specifications.

5.5 Glossary

[TI Glossary](#) This glossary lists and explains terms, acronyms, and definitions.

6 Revision History

NOTE: Page numbers for previous revisions may differ from page numbers in the current version.

Changes from Revision D (May 2017) to Revision E (December 2023)	Page
<ul style="list-style-type: none"> • Updated the numbering format for tables, figures, and cross-references throughout the document..... 1 	1
<hr/>	
Changes from Revision C (December 2016) to Revision D (May 2017)	Page
<ul style="list-style-type: none"> • Changed the $R_{DS(ON)}$ values at 3 V, 4.5 V, 8 V & the <i>Description</i> to match the values on the <i>Electrical Characteristics</i> table. 1 	1
<hr/>	
Changes from Revision B (May 2010) to Revision C (December 2016)	Page
<ul style="list-style-type: none"> • Changed <i>Description</i> text..... 1 • Added silicon limited continuous drain current to <i>Absolute Maximum Ratings</i> table.....1 • Added max power dissipation at $T_C = 25^\circ\text{C}$ to <i>Absolute Maximum Ratings</i> table.....1 • Changed Note 2 in <i>Absolute Maximum Ratings</i> table..... 1 • Changed $R_{\theta JA}$ max from 48°C/W : to 50°C/W.....3 • Changed the SOA in Figure 4-10 to reflect measured data..... 4 • Changed <i>MECHANICAL DATA</i> section to <i>Mechanical, Packaging, and Orderable Information</i> section.....9 	9
<hr/>	
Changes from Revision A (January 2010) to Revision B (May 2010)	Page
<ul style="list-style-type: none"> • Changed $R_{DS(on)} - V_{GS} = 3\text{V}$, $I_D = 25\text{A}$ MAX value From: 3.5 To: 3.8..... 3 	3
<hr/>	
Changes from Revision * (August 2009) to Revision A (January 2010)	Page
<ul style="list-style-type: none"> • Changed the labels on the Top View pinout image..... 1 • Changed Note 1 of the <i>Absolute Maximum Ratings</i> From: $R_{\theta JA} = 39^\circ\text{C/W}$ To: Typical $R_{\theta JA} = 39^\circ\text{C/W}$..... 1 • Changed Figure 4-1 text From: $R_{\theta JA} = 92^\circ\text{C/W}$ To: Typical $R_{\theta JA} = 93^\circ\text{C/W}$..... 4 • Changed Figure 4-10 text From: $R_{\theta JA} = 92^\circ\text{C/W}$ To: Typical $R_{\theta JA} = 93^\circ\text{C/W}$..... 4 • Changed Figure 4-11 X-axis values..... 4 	4

7 Mechanical, Packaging, and Orderable Information

The following pages include mechanical, packaging, and orderable information. This information is the most current data available for the designated devices. This data is subject to change without notice and revision of this document. For browser-based versions of this data sheet, refer to the left-hand navigation.

PACKAGING INFORMATION

Orderable part number	Status (1)	Material type (2)	Package Pins	Package qty Carrier	RoHS (3)	Lead finish/ Ball material (4)	MSL rating/ Peak reflow (5)	Op temp (°C)	Part marking (6)
CSD16321Q5	Active	Production	VSON-CLIP (DQH) 8	2500 LARGE T&R	ROHS Exempt	SN	Level-1-260C-UNLIM	-55 to 150	CSD16321
CSD16321Q5.Z	Active	Production	VSON-CLIP (DQH) 8	2500 LARGE T&R	ROHS Exempt	SN	Level-1-260C-UNLIM	-55 to 150	CSD16321
CSD16321Q5T	Active	Production	VSON-CLIP (DQH) 8	250 SMALL T&R	ROHS Exempt	SN	Level-1-260C-UNLIM	-55 to 150	CSD16321
CSD16321Q5T.Z	Active	Production	VSON-CLIP (DQH) 8	250 SMALL T&R	ROHS Exempt	SN	Level-1-260C-UNLIM	-55 to 150	CSD16321

(1) **Status:** For more details on status, see our [product life cycle](#).

(2) **Material type:** When designated, preproduction parts are prototypes/experimental devices, and are not yet approved or released for full production. Testing and final process, including without limitation quality assurance, reliability performance testing, and/or process qualification, may not yet be complete, and this item is subject to further changes or possible discontinuation. If available for ordering, purchases will be subject to an additional waiver at checkout, and are intended for early internal evaluation purposes only. These items are sold without warranties of any kind.

(3) **RoHS values:** Yes, No, RoHS Exempt. See the [TI RoHS Statement](#) for additional information and value definition.

(4) **Lead finish/Ball material:** Parts may have multiple material finish options. Finish options are separated by a vertical ruled line. Lead finish/Ball material values may wrap to two lines if the finish value exceeds the maximum column width.

(5) **MSL rating/Peak reflow:** The moisture sensitivity level ratings and peak solder (reflow) temperatures. In the event that a part has multiple moisture sensitivity ratings, only the lowest level per JEDEC standards is shown. Refer to the shipping label for the actual reflow temperature that will be used to mount the part to the printed circuit board.

(6) **Part marking:** There may be an additional marking, which relates to the logo, the lot trace code information, or the environmental category of the part.

Multiple part markings will be inside parentheses. Only one part marking contained in parentheses and separated by a "~" will appear on a part. If a line is indented then it is a continuation of the previous line and the two combined represent the entire part marking for that device.

Important Information and Disclaimer: The information provided on this page represents TI's knowledge and belief as of the date that it is provided. TI bases its knowledge and belief on information provided by third parties, and makes no representation or warranty as to the accuracy of such information. Efforts are underway to better integrate information from third parties. TI has taken and continues to take reasonable steps to provide representative and accurate information but may not have conducted destructive testing or chemical analysis on incoming materials and chemicals. TI and TI suppliers consider certain information to be proprietary, and thus CAS numbers and other limited information may not be available for release.

In no event shall TI's liability arising out of such information exceed the total purchase price of the TI part(s) at issue in this document sold by TI to Customer on an annual basis.

TAPE AND REEL INFORMATION

QUADRANT ASSIGNMENTS FOR PIN 1 ORIENTATION IN TAPE

*All dimensions are nominal

Device	Package Type	Package Drawing	Pins	SPQ	Reel Diameter (mm)	Reel Width W1 (mm)	A0 (mm)	B0 (mm)	K0 (mm)	P1 (mm)	W (mm)	Pin1 Quadrant
CSD16321Q5T	VSON-CLIP	DQH	8	250	178.0	12.4	6.3	5.3	1.2	8.0	12.0	Q1

TAPE AND REEL BOX DIMENSIONS

*All dimensions are nominal

Device	Package Type	Package Drawing	Pins	SPQ	Length (mm)	Width (mm)	Height (mm)
CSD16321Q5T	VSON-CLIP	DQH	8	250	180.0	180.0	79.0

DQH0008A

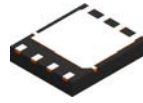

PACKAGE OUTLINE

VSON-CLIP - 1.05 mm max height

PLASTIC SMALL OUTLINE - NO LEAD

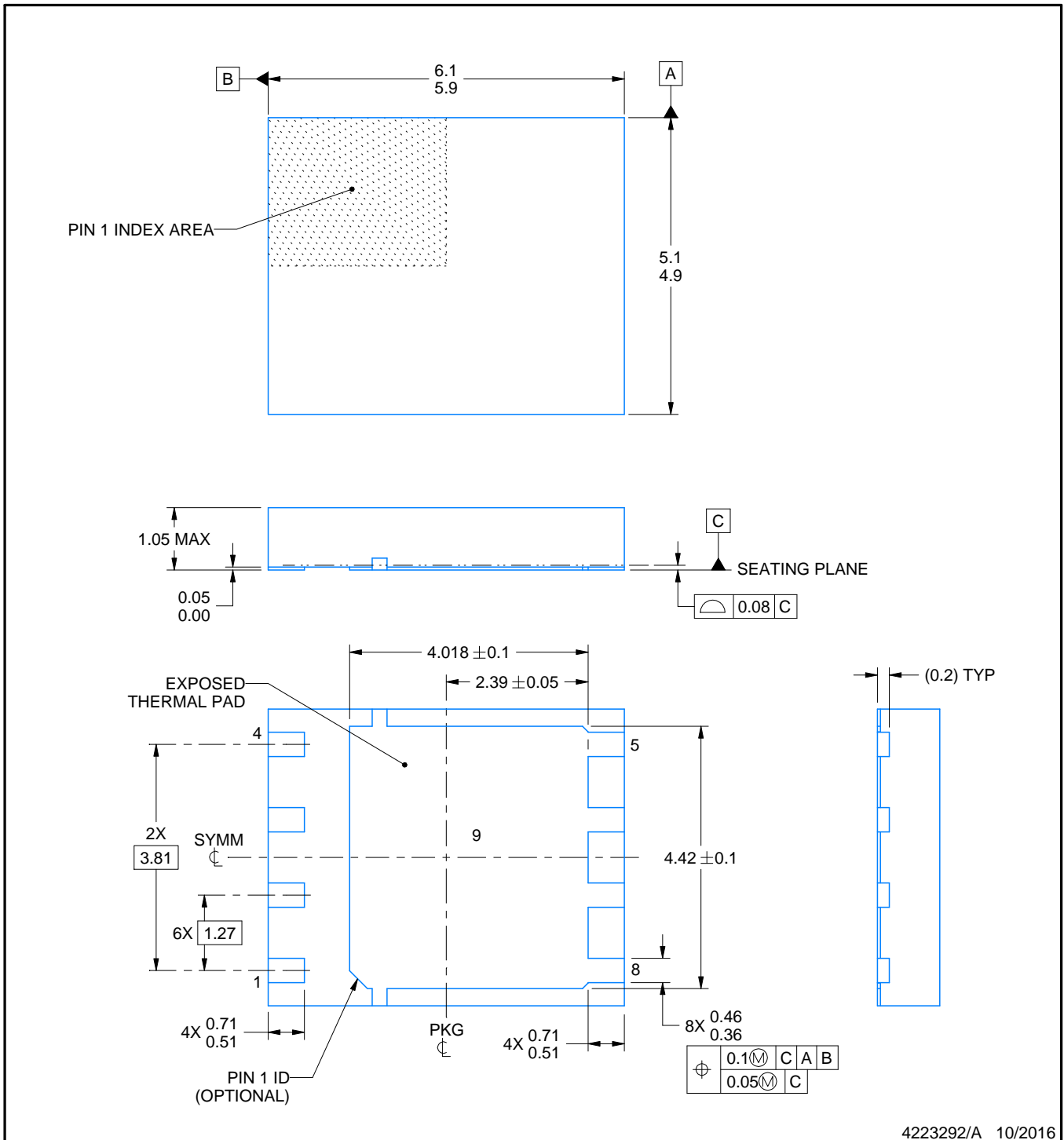

4223292/A 10/2016

NOTES:

1. All linear dimensions are in millimeters. Any dimensions in parenthesis are for reference only. Dimensioning and tolerancing per ASME Y14.5M.
2. This drawing is subject to change without notice.
3. The package thermal pad must be soldered to the printed circuit board for thermal and mechanical performance.

EXAMPLE BOARD LAYOUT

DQH0008A

VSON-CLIP - 1.05 mm max height

PLASTIC SMALL OUTLINE - NO LEAD

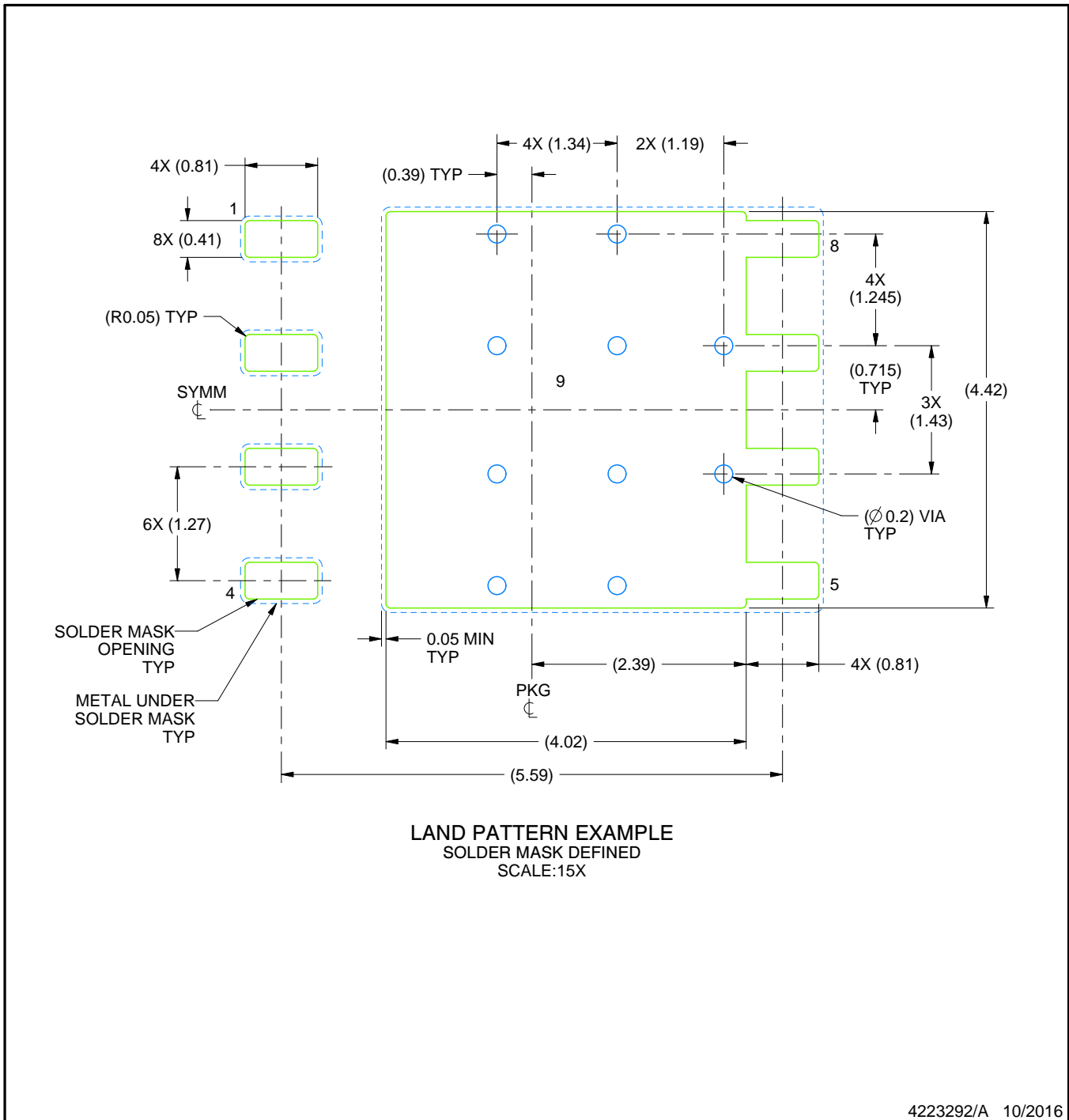

NOTES: (continued)

4. This package is designed to be soldered to a thermal pad on the board. For more information, see Texas Instruments literature number SLUA271 (www.ti.com/lit/sluea271).
5. Vias are optional depending on application, refer to device data sheet. If some or all are implemented, recommended via locations are shown.

EXAMPLE STENCIL DESIGN

DQH0008A

VSON-CLIP - 1.05 mm max height

PLASTIC SMALL OUTLINE - NO LEAD

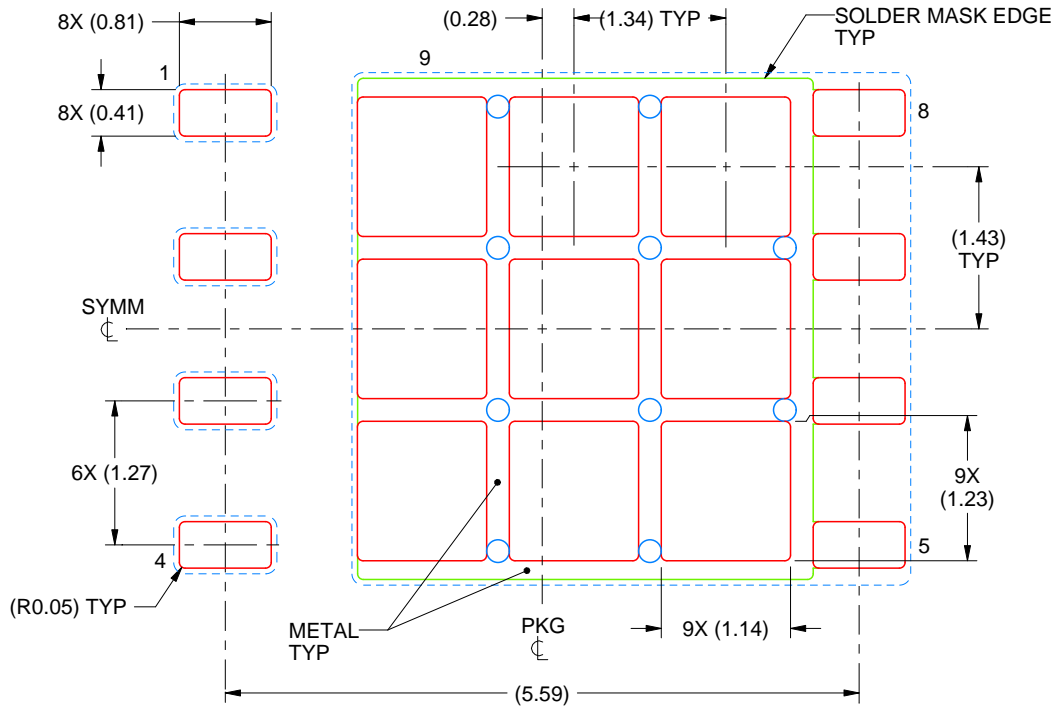

SOLDER PASTE EXAMPLE
BASED ON 0.125 mm THICK STENCIL

EXPOSED PAD 9:
71% PRINTED SOLDER COVERAGE BY AREA UNDER PACKAGE
SCALE:15X

4223292/A 10/2016

NOTES: (continued)

6. Laser cutting apertures with trapezoidal walls and rounded corners may offer better paste release. IPC-7525 may have alternate design recommendations.

IMPORTANT NOTICE AND DISCLAIMER

TI PROVIDES TECHNICAL AND RELIABILITY DATA (INCLUDING DATA SHEETS), DESIGN RESOURCES (INCLUDING REFERENCE DESIGNS), APPLICATION OR OTHER DESIGN ADVICE, WEB TOOLS, SAFETY INFORMATION, AND OTHER RESOURCES "AS IS" AND WITH ALL FAULTS, AND DISCLAIMS ALL WARRANTIES, EXPRESS AND IMPLIED, INCLUDING WITHOUT LIMITATION ANY IMPLIED WARRANTIES OF MERCHANTABILITY, FITNESS FOR A PARTICULAR PURPOSE OR NON-INFRINGEMENT OF THIRD PARTY INTELLECTUAL PROPERTY RIGHTS.

These resources are intended for skilled developers designing with TI products. You are solely responsible for (1) selecting the appropriate TI products for your application, (2) designing, validating and testing your application, and (3) ensuring your application meets applicable standards, and any other safety, security, regulatory or other requirements.

These resources are subject to change without notice. TI grants you permission to use these resources only for development of an application that uses the TI products described in the resource. Other reproduction and display of these resources is prohibited. No license is granted to any other TI intellectual property right or to any third party intellectual property right. TI disclaims responsibility for, and you will fully indemnify TI and its representatives against, any claims, damages, costs, losses, and liabilities arising out of your use of these resources.

TI's products are provided subject to [TI's Terms of Sale](#) or other applicable terms available either on [ti.com](https://www.ti.com) or provided in conjunction with such TI products. TI's provision of these resources does not expand or otherwise alter TI's applicable warranties or warranty disclaimers for TI products.

TI objects to and rejects any additional or different terms you may have proposed.

Mailing Address: Texas Instruments, Post Office Box 655303, Dallas, Texas 75265
Copyright © 2025, Texas Instruments Incorporated