

CSD17318Q2 30-V N-Channel NexFET™ Power MOSFET

1 Features

- Optimized for 5-V Gate Drive
- Low Capacitance and Charge
- Low $R_{DS(ON)}$
- Low-Thermal Resistance
- Lead Free
- RoHS Compliant
- Halogen Free
- SON 2-mm x 2-mm Plastic Package

2 Applications

- Storage, Tablets, and Handheld Devices
- Optimized for Load Switch Applications
- DC-DC Converters
- Battery and Load Management Applications

3 Description

This 30-V, 12.6-m Ω , 2-mm x 2-mm SON NexFET™ power MOSFET is designed to minimize losses in power conversion applications and optimized for 5-V gate drive applications. The 2-mm x 2-mm SON offers excellent thermal performance for the size of the package.

Top View

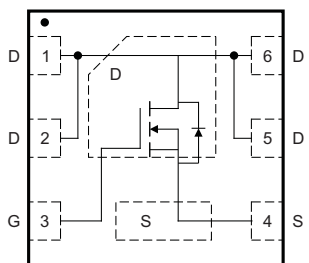

P0108-01

On-State Resistance vs Gate to Source Voltage

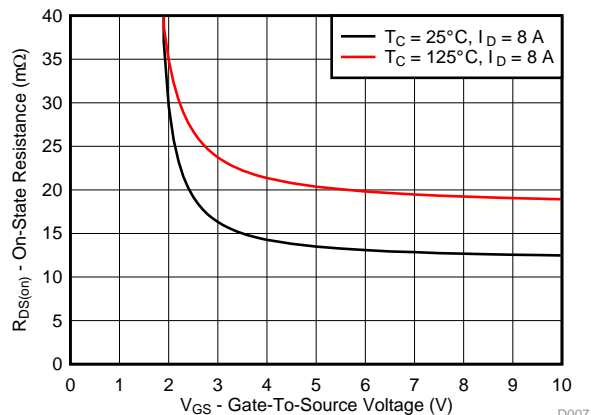

D007

Gate Charge

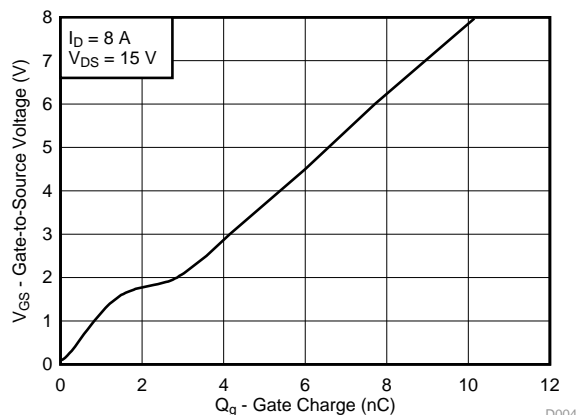

D004

Product Summary

| $T_A = 25^\circ\text{C}$ | | TYPICAL VALUE | | UNIT |
|--------------------------|-------------------------------|-------------------------|------|------------|
| V_{DS} | Drain-to-Source Voltage | 30 | | V |
| Q_g | Gate Charge Total (4.5 V) | 6.0 | | nC |
| Q_{gd} | Gate Charge Gate-to-Drain | 1.3 | | nC |
| $R_{DS(on)}$ | Drain-to-Source On-Resistance | $V_{GS} = 2.5\text{ V}$ | 20 | m Ω |
| | | $V_{GS} = 4.5\text{ V}$ | 13.9 | |
| | | $V_{GS} = 8\text{ V}$ | 12.6 | |
| $V_{GS(th)}$ | Threshold Voltage | 0.9 | | V |

Device Information⁽¹⁾

| PART NUMBER | QTY | MEDIA | PACKAGE | SHIP |
|-------------|------|-------------|---|---------------------|
| CSD17318Q2 | 3000 | 7-Inch Reel | SON 2.00-mm x 2.00-mm Plastic Package | Tape and Reel |
| CSD17318Q2T | 250 | | | |

(1) For all available packages, see the orderable addendum at the end of the data sheet.

Absolute Maximum Ratings

| $T_A = 25^\circ\text{C}$ | | VALUE | UNIT |
|--------------------------|---|------------|------------------|
| V_{DS} | Drain-to-Source Voltage | 30 | V |
| V_{GS} | Gate-to-Source Voltage | ± 10 | V |
| I_D | Continuous Drain Current (Package Limited) | 21.5 | A |
| | Continuous Drain Current (Silicon Limited), $T_C = 25^\circ\text{C}$ | 25 | |
| | Continuous Drain Current ⁽¹⁾ | 10 | |
| I_{DM} | Pulsed Drain Current, $T_A = 25^\circ\text{C}$ ⁽²⁾ | 68 | A |
| P_D | Power Dissipation ⁽¹⁾ | 2.5 | W |
| | Power Dissipation, $T_C = 25^\circ\text{C}$ | 16 | |
| T_J , T_{STG} | Operating Junction, Storage Temperature | -55 to 150 | $^\circ\text{C}$ |
| E_{AS} | Avalanche Energy, Single Pulse, $I_D = 12.4\text{ A}$, $L = 0.1\text{ mH}$, $R_G = 25\ \Omega$ | 7.7 | mJ |

(1) Typical $R_{\theta JA} = 55^\circ\text{C/W}$ on a 1-in², 2-oz Cu pad on a 0.06-in thick FR4 PCB.

(2) Max $R_{\theta JC} = 7^\circ\text{C/W}$, pulse duration $\leq 100\ \mu\text{s}$, duty cycle $\leq 1\%$.



Table of Contents

| | | | |
|---|----------|---|----------|
| 1 Features | 1 | 6 Device and Documentation Support | 7 |
| 2 Applications | 1 | 6.1 Receiving Notification of Documentation Updates.... | 7 |
| 3 Description | 1 | 6.2 Community Resources..... | 7 |
| 4 Revision History | 2 | 6.3 Trademarks | 7 |
| 5 Specifications | 3 | 6.4 Electrostatic Discharge Caution..... | 7 |
| 5.1 Electrical Characteristics..... | 3 | 6.5 Glossary | 7 |
| 5.2 Thermal Characteristics | 3 | 7 Mechanical Data | 8 |
| 5.3 Typical MOSFET Characteristics..... | 4 | 7.1 Q2 Package Dimensions | 8 |
| | | 7.2 Q2 Tape and Reel Information..... | 10 |

4 Revision History

| Changes from Original (February 2017) to Revision A | Page |
|---|------|
| • Updated the Mechanical Data drawings..... | 8 |

5 Specifications

5.1 Electrical Characteristics

 $T_A = 25^\circ\text{C}$ (unless otherwise noted)

| PARAMETER | | TEST CONDITIONS | MIN | TYP | MAX | UNIT |
|--------------------------------|----------------------------------|---|-----|------|------|---------------|
| STATIC CHARACTERISTICS | | | | | | |
| V_{DSS} | Drain-to-source voltage | $V_{GS} = 0\text{ V}, I_D = 250\ \mu\text{A}$ | 30 | | | V |
| I_{DSS} | Drain-to-source leakage | $V_{GS} = 0\text{ V}, V_{DS} = 24\text{ V}$ | | | 1 | μA |
| I_{GSS} | Gate-to-source leakage | $V_{DS} = 0\text{ V}, V_{GS} = 10\text{ V}$ | | | 100 | nA |
| $V_{GS(th)}$ | Gate-to-source threshold voltage | $V_{DS} = V_{GS}, I_D = 250\ \mu\text{A}$ | 0.6 | 0.9 | 1.2 | V |
| $R_{DS(on)}$ | Drain-to-source on-resistance | $V_{GS} = 2.5\text{ V}, I_D = 8\text{ A}$ | | 20 | 30 | m Ω |
| | | $V_{GS} = 4.5\text{ V}, I_D = 8\text{ A}$ | | 13.9 | 16.9 | |
| | | $V_{GS} = 8\text{ V}, I_D = 8\text{ A}$ | | 12.6 | 15.1 | |
| g_{fs} | Transconductance | $V_{DS} = 3\text{ V}, I_D = 8\text{ A}$ | | 42 | | S |
| DYNAMIC CHARACTERISTICS | | | | | | |
| C_{iss} | Input capacitance | $V_{GS} = 0\text{ V}, V_{DS} = 15\text{ V},$ $f = 1\text{ MHz}$ | | 676 | 879 | pF |
| C_{oss} | Output capacitance | | | 71 | 92 | pF |
| C_{rss} | Reverse transfer capacitance | | | 39 | 51 | pF |
| R_G | Series gate resistance | | | 1.0 | 2.0 | Ω |
| Q_g | Gate charge total (4.5 V) | $V_{DS} = 15\text{ V},$ $I_D = 8\text{ A}$ | | 6.0 | | nC |
| Q_{gd} | Gate charge gate-to-drain | | | 1.3 | | nC |
| Q_{gs} | Gate charge gate-to-source | | | 1.5 | | nC |
| $Q_{g(th)}$ | Gate charge at V_{th} | | | 0.7 | | nC |
| Q_{oss} | Output charge | $V_{DS} = 15\text{ V}, V_{GS} = 0\text{ V}$ | | 2.7 | | nC |
| $t_{d(on)}$ | Turnon delay time | $V_{DS} = 15\text{ V}, V_{GS} = 4.5\text{ V},$ $I_D = 8\text{ A}, R_G = 2\ \Omega$ | | 5 | | ns |
| t_r | Rise time | | | 16 | | ns |
| $t_{d(off)}$ | Turnoff delay time | | | 13 | | ns |
| t_f | Fall time | | | 4 | | ns |
| DIODE CHARACTERISTICS | | | | | | |
| V_{SD} | Diode forward voltage | $I_{SD} = 8\text{ A}, V_{GS} = 0\text{ V}$ | | 0.8 | 1.0 | V |
| Q_{rr} | Reverse recovery charge | $V_{DD} = 15\text{ V}, I_F = 8\text{ A},$ $di/dt = 300\text{ A}/\mu\text{s}$ | | 2.9 | | nC |
| t_{rr} | Reverse recovery time | | | | 12 | |

5.2 Thermal Characteristics

 $T_A = 25^\circ\text{C}$ (unless otherwise noted)

| PARAMETER | | MIN | TYP | MAX | UNIT |
|-----------------|--|-----|-----|-----|---------------------------|
| $R_{\theta JC}$ | Thermal resistance junction-to-case ⁽¹⁾ | | | 7.9 | $^\circ\text{C}/\text{W}$ |
| $R_{\theta JA}$ | Thermal resistance junction-to-ambient ⁽¹⁾⁽²⁾ | | | 65 | $^\circ\text{C}/\text{W}$ |

- (1) $R_{\theta JC}$ is determined with the device mounted on a 1-in² (6.45-cm²), 2-oz (0.071-mm) thick Cu pad on a 1.5-in × 1.5-inch (3.81-cm × 3.81-cm), 0.06-in (1.52-mm) thick FR4 PCB. $R_{\theta JC}$ is specified by design, whereas $R_{\theta JA}$ is determined by the user's board design.
- (2) Device mounted on FR4 material with 1-in² (6.45-cm²), 2-oz (0.071-mm) thick Cu.

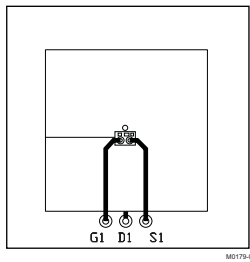

Max $R_{\theta JA} = 65^{\circ}\text{C/W}$
when mounted on 1 in²
(6.45 cm²) of 2-oz
(0.071-mm) thick Cu.

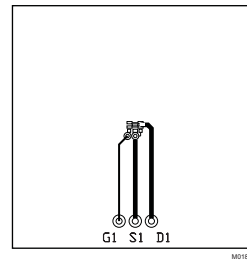

Max $R_{\theta JA} = 250^{\circ}\text{C/W}$
when mounted on a
minimum pad area of
2-oz (0.071-mm) thick
Cu.

5.3 Typical MOSFET Characteristics

$T_A = 25^{\circ}\text{C}$ (unless otherwise noted)

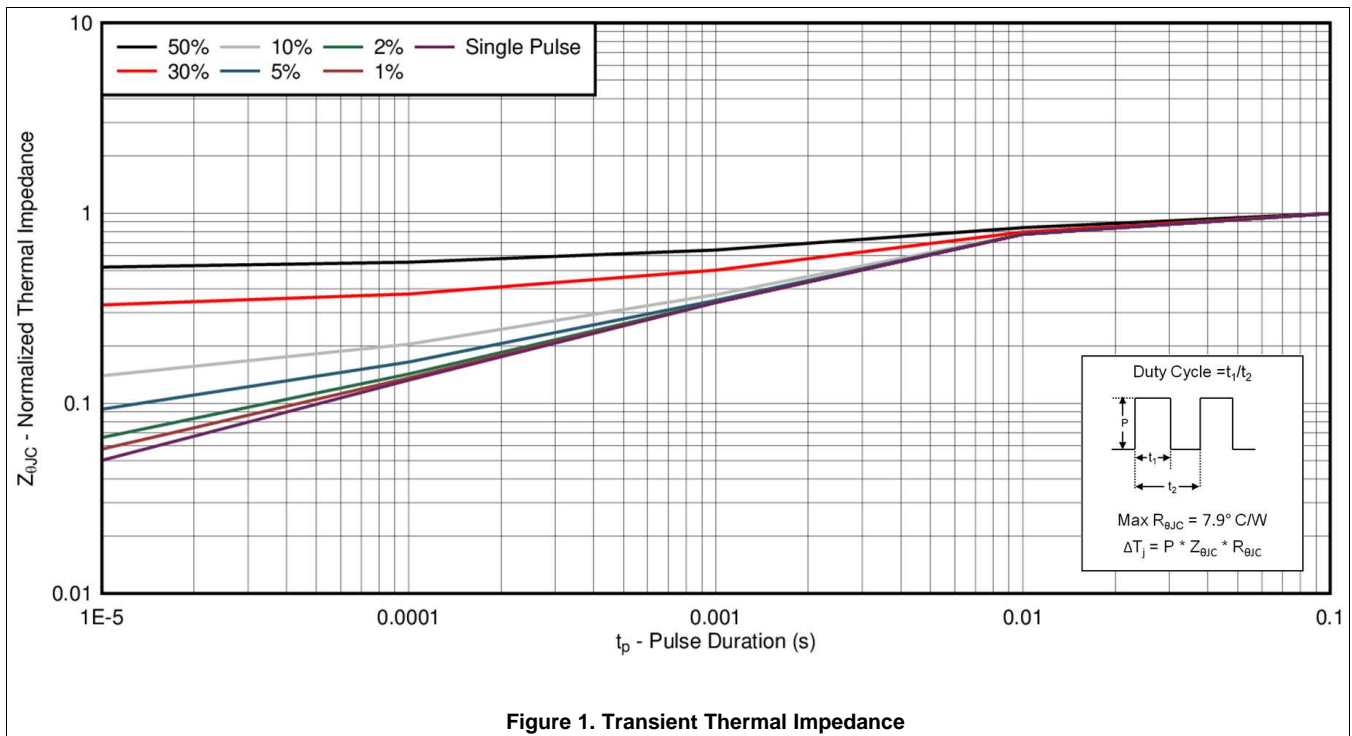

Figure 1. Transient Thermal Impedance

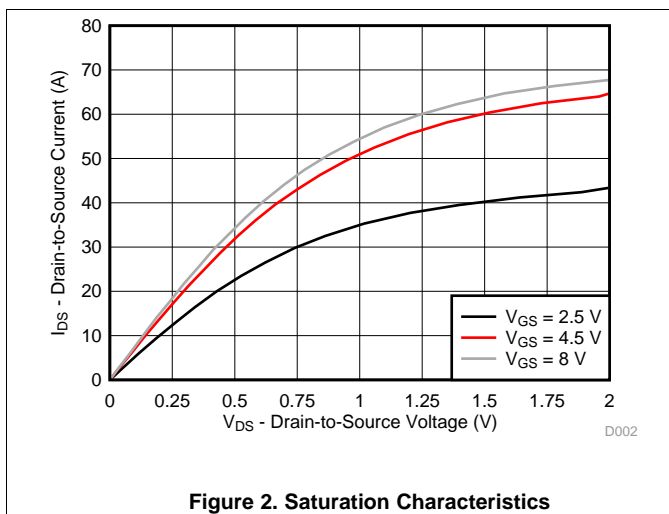

Figure 2. Saturation Characteristics

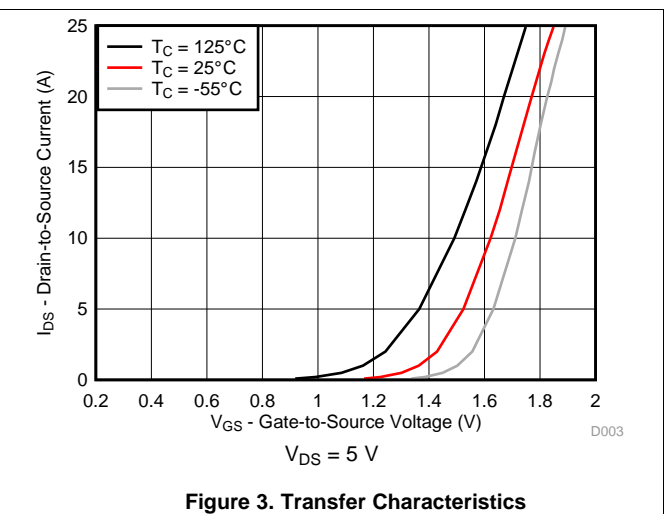
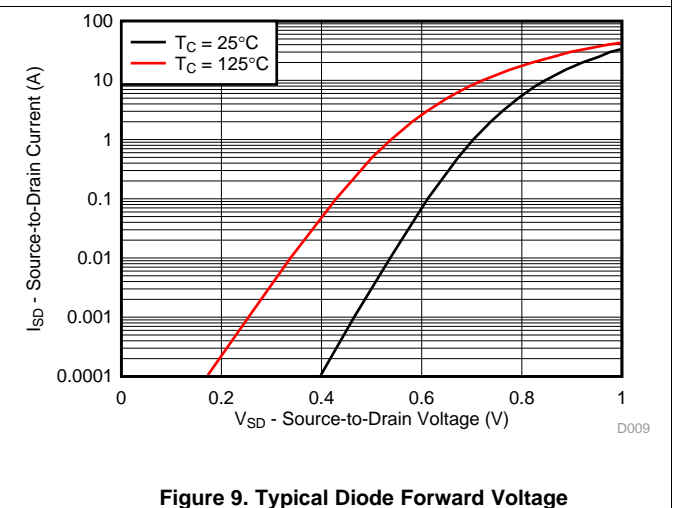
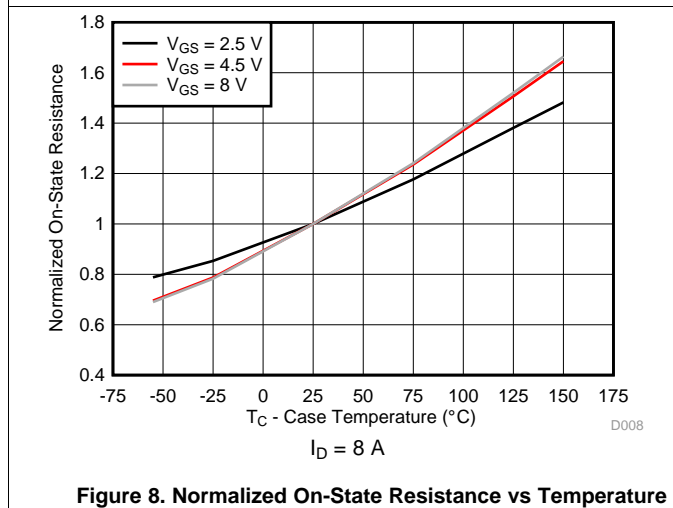
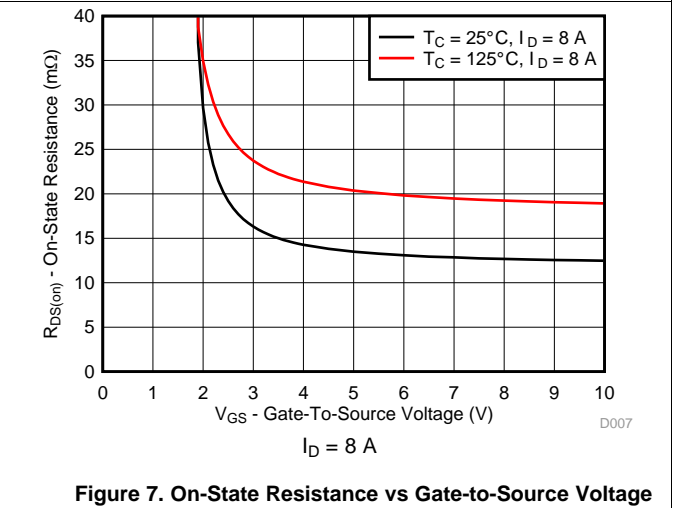
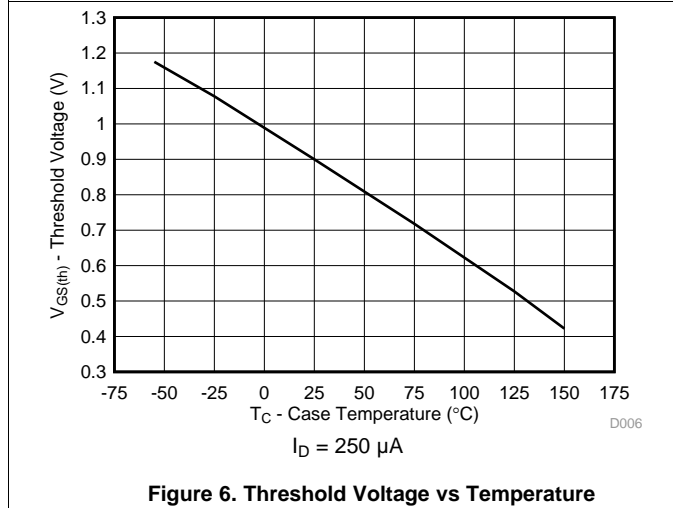
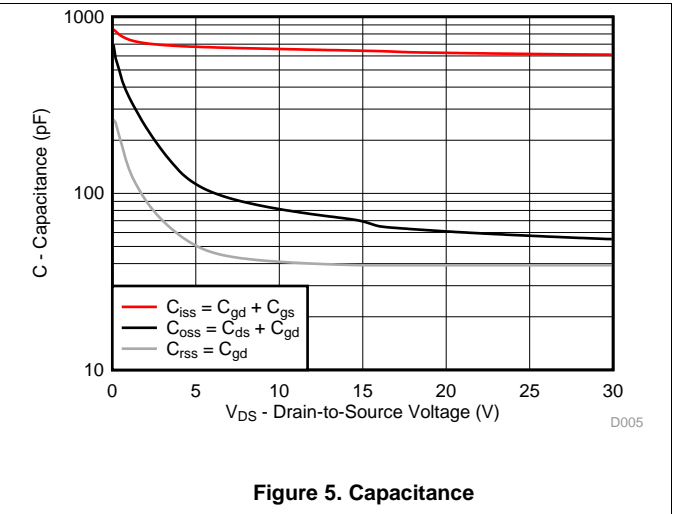
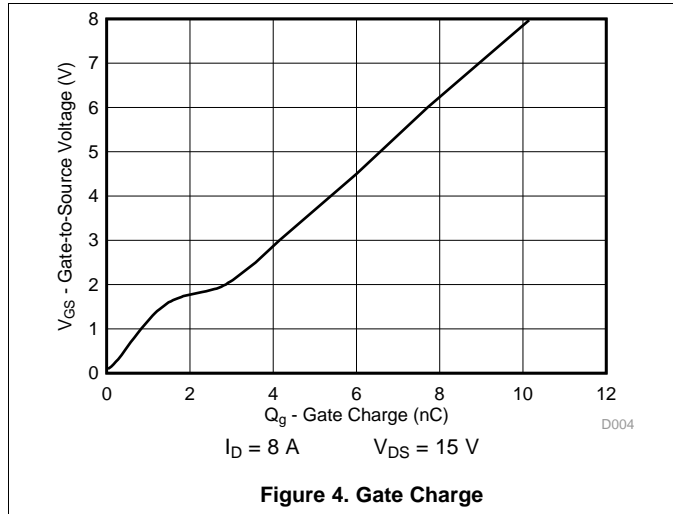

Figure 3. Transfer Characteristics

Typical MOSFET Characteristics (continued)

T_A = 25°C (unless otherwise noted)



Typical MOSFET Characteristics (continued)

$T_A = 25^\circ\text{C}$ (unless otherwise noted)

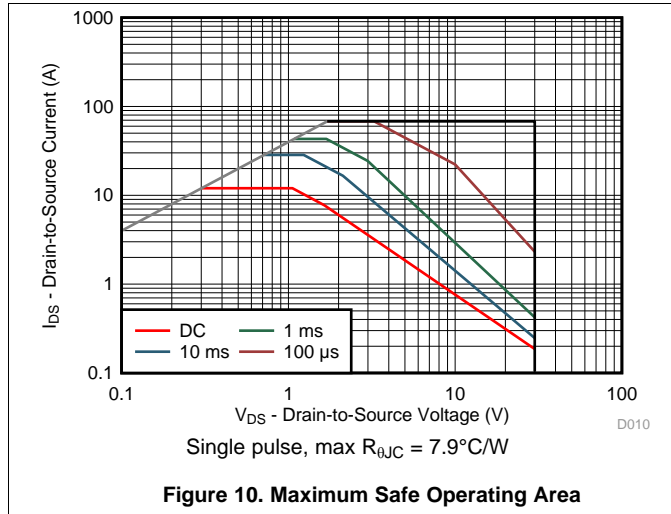

Figure 10. Maximum Safe Operating Area

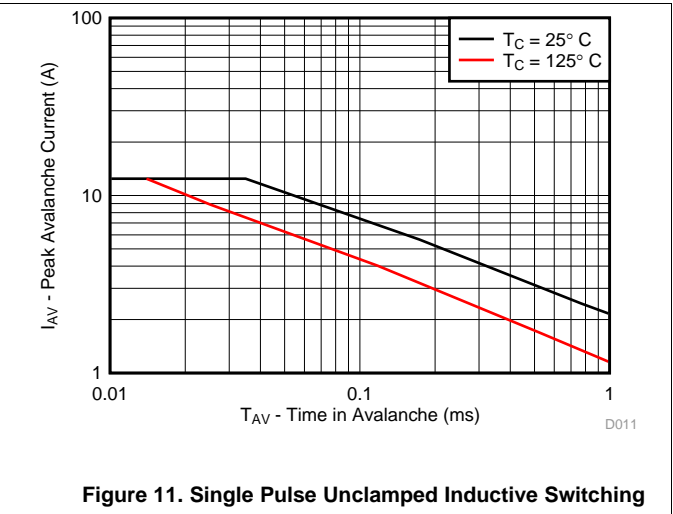

Figure 11. Single Pulse Unclamped Inductive Switching

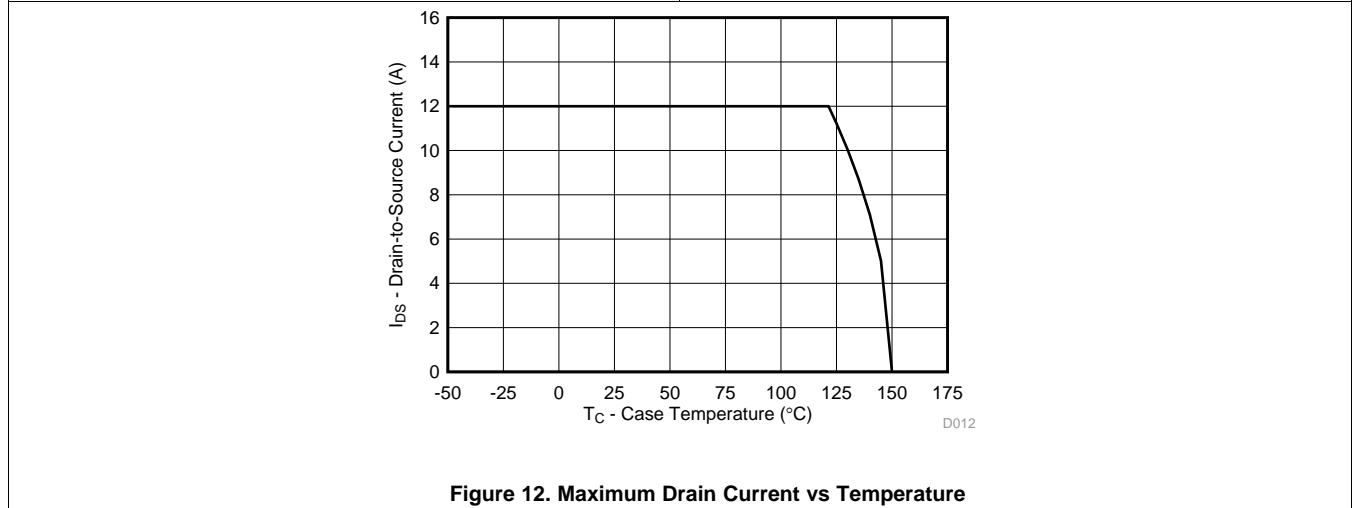

Figure 12. Maximum Drain Current vs Temperature

6 Device and Documentation Support

6.1 Receiving Notification of Documentation Updates

To receive notification of documentation updates, navigate to the device product folder on ti.com. In the upper right corner, click on *Alert me* to register and receive a weekly digest of any product information that has changed. For change details, review the revision history included in any revised document.

6.2 Community Resources

The following links connect to TI community resources. Linked contents are provided "AS IS" by the respective contributors. They do not constitute TI specifications and do not necessarily reflect TI's views; see TI's [Terms of Use](#).

TI E2E™ Online Community *TI's Engineer-to-Engineer (E2E) Community*. Created to foster collaboration among engineers. At e2e.ti.com, you can ask questions, share knowledge, explore ideas and help solve problems with fellow engineers.

Design Support *TI's Design Support* Quickly find helpful E2E forums along with design support tools and contact information for technical support.

6.3 Trademarks

NexFET, E2E are trademarks of Texas Instruments.
All other trademarks are the property of their respective owners.

6.4 Electrostatic Discharge Caution



These devices have limited built-in ESD protection. The leads should be shorted together or the device placed in conductive foam during storage or handling to prevent electrostatic damage to the MOS gates.

6.5 Glossary

[SLYZ022](#) — *TI Glossary*.

This glossary lists and explains terms, acronyms, and definitions.

7 Mechanical Data

7.1 Q2 Package Dimensions

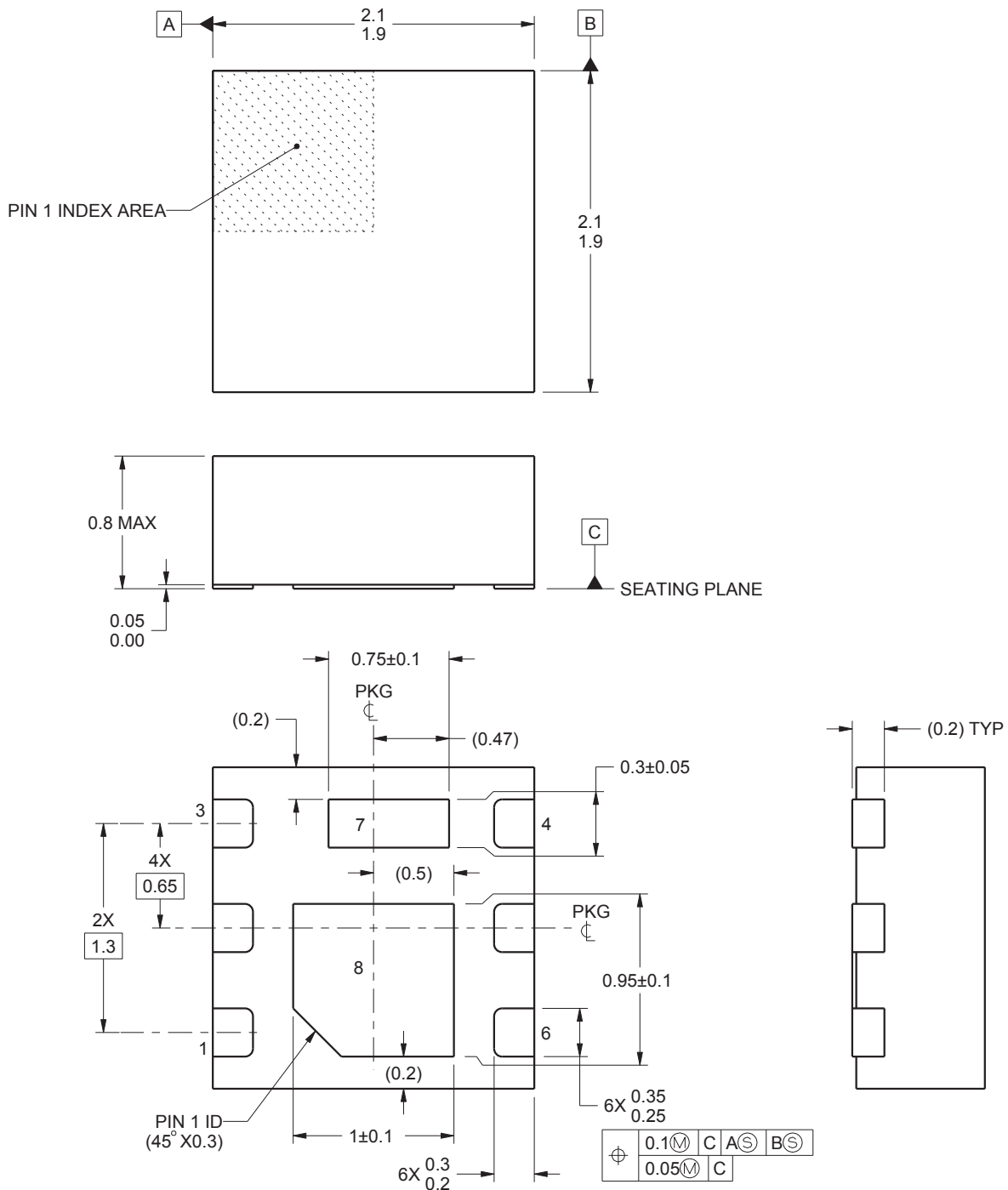

4222322/A 08/2015

1. All linear dimensions are in millimeters. Any dimensions in parenthesis are for reference only. Dimensioning and tolerancing per ASME Y14.5M.
2. This drawing is subject to change without notice.
3. The package thermal pads must be soldered to the printed circuit board for thermal and mechanical performance.

Q2 Package Dimensions (continued)

7.1.1 Recommended PCB Pattern

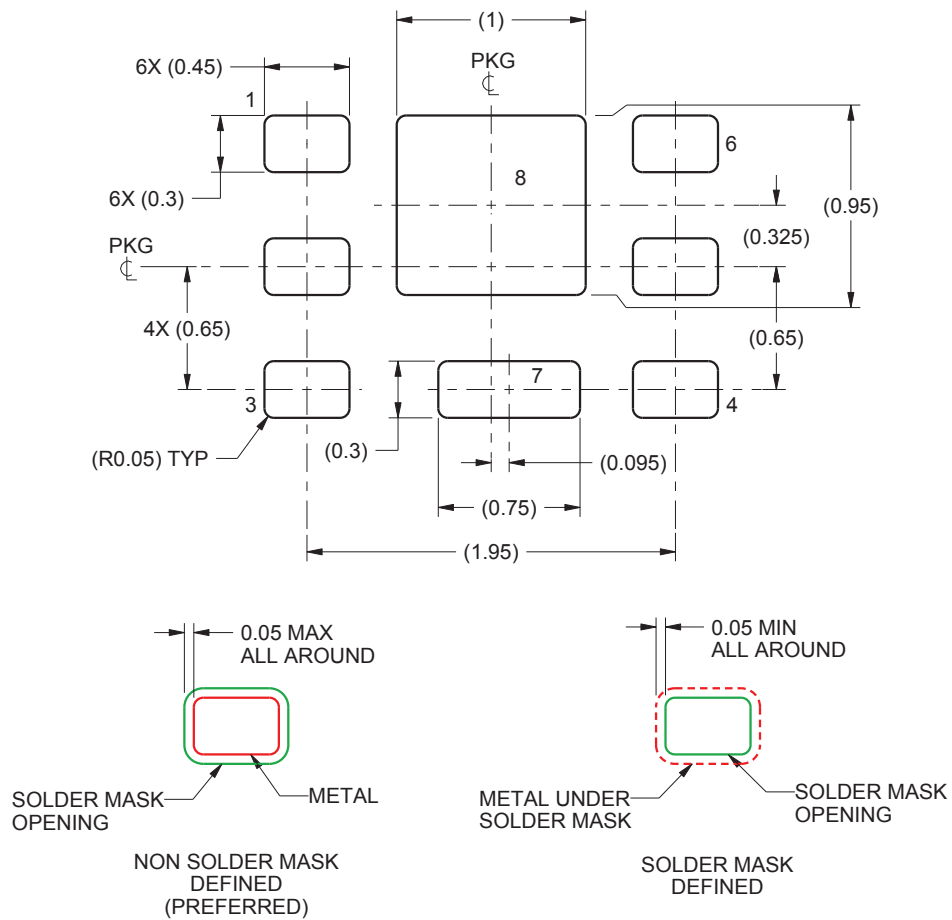

SOLDER MASK DETAILS

1. This package is designed to be soldered to a thermal pad on the board. For more information, see [QFN/SOP PCB Attachment \(SLUA271\)](#).

Q2 Package Dimensions (continued)

7.1.2 Recommended Stencil Pattern

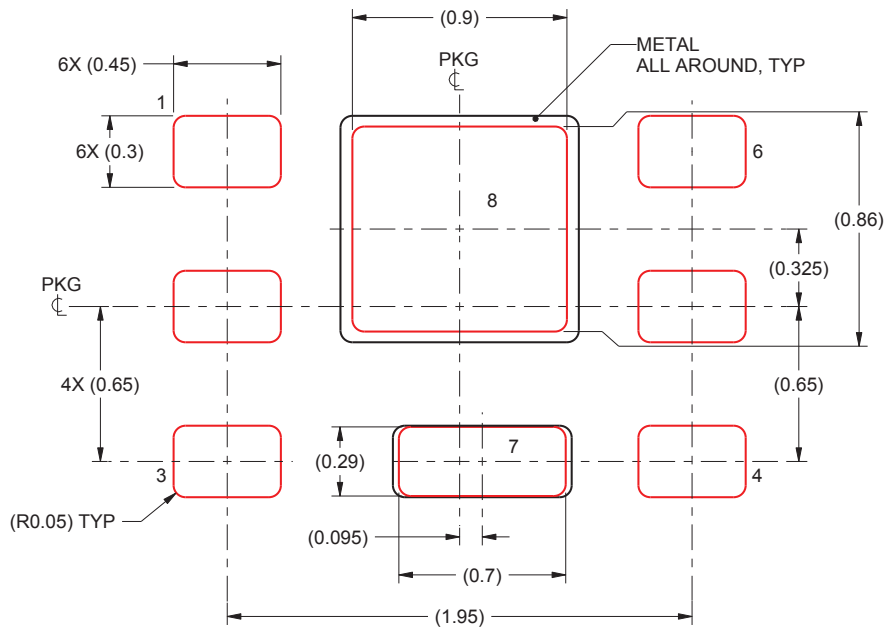

1. Laser cutting apertures with trapezoidal walls and rounded corners may offer better paste release. IPC-7525 may have alternate design recommendations.

7.2 Q2 Tape and Reel Information

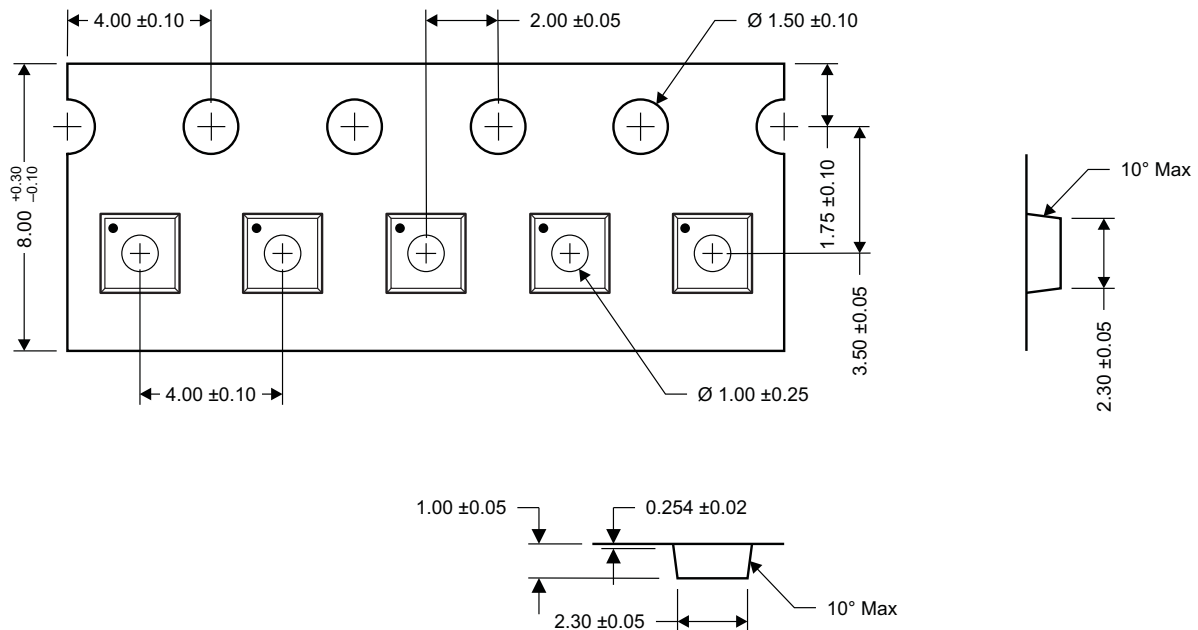

- Notes:
1. Measured from centerline of sprocket hole to centerline of pocket.
 2. Cumulative tolerance of 10 sprocket holes is ± 0.20 .
 3. Other material available.
 4. Typical SR of form tape Max 10^9 OHM/SQ.
 5. All dimensions are in mm, unless otherwise specified.

M0168-01

PACKAGING INFORMATION

| Orderable Device | Status (1) | Package Type | Package Drawing | Pins | Package Qty | Eco Plan (2) | Lead finish/ Ball material (6) | MSL Peak Temp (3) | Op Temp (°C) | Device Marking (4/5) | Samples |
|------------------|---------------|--------------|-----------------|------|-------------|-----------------|--------------------------------------|----------------------|--------------|-------------------------|-------------------------|
| CSD17318Q2 | ACTIVE | WSON | DQK | 6 | 3000 | RoHS & Green | NIPDAU SN | Level-1-260C-UNLIM | -55 to 150 | 1718 | Samples |
| CSD17318Q2T | ACTIVE | WSON | DQK | 6 | 250 | RoHS & Green | NIPDAU SN | Level-1-260C-UNLIM | -55 to 150 | 1718 | Samples |

(1) The marketing status values are defined as follows:

ACTIVE: Product device recommended for new designs.

LIFEBUY: TI has announced that the device will be discontinued, and a lifetime-buy period is in effect.

NRND: Not recommended for new designs. Device is in production to support existing customers, but TI does not recommend using this part in a new design.

PREVIEW: Device has been announced but is not in production. Samples may or may not be available.

OBSOLETE: TI has discontinued the production of the device.

(2) **RoHS:** TI defines "RoHS" to mean semiconductor products that are compliant with the current EU RoHS requirements for all 10 RoHS substances, including the requirement that RoHS substance do not exceed 0.1% by weight in homogeneous materials. Where designed to be soldered at high temperatures, "RoHS" products are suitable for use in specified lead-free processes. TI may reference these types of products as "Pb-Free".

RoHS Exempt: TI defines "RoHS Exempt" to mean products that contain lead but are compliant with EU RoHS pursuant to a specific EU RoHS exemption.

Green: TI defines "Green" to mean the content of Chlorine (Cl) and Bromine (Br) based flame retardants meet JS709B low halogen requirements of <=1000ppm threshold. Antimony trioxide based flame retardants must also meet the <=1000ppm threshold requirement.

(3) MSL, Peak Temp. - The Moisture Sensitivity Level rating according to the JEDEC industry standard classifications, and peak solder temperature.

(4) There may be additional marking, which relates to the logo, the lot trace code information, or the environmental category on the device.

(5) Multiple Device Markings will be inside parentheses. Only one Device Marking contained in parentheses and separated by a "~" will appear on a device. If a line is indented then it is a continuation of the previous line and the two combined represent the entire Device Marking for that device.

(6) Lead finish/Ball material - Orderable Devices may have multiple material finish options. Finish options are separated by a vertical ruled line. Lead finish/Ball material values may wrap to two lines if the finish value exceeds the maximum column width.

Important Information and Disclaimer:The information provided on this page represents TI's knowledge and belief as of the date that it is provided. TI bases its knowledge and belief on information provided by third parties, and makes no representation or warranty as to the accuracy of such information. Efforts are underway to better integrate information from third parties. TI has taken and continues to take reasonable steps to provide representative and accurate information but may not have conducted destructive testing or chemical analysis on incoming materials and chemicals. TI and TI suppliers consider certain information to be proprietary, and thus CAS numbers and other limited information may not be available for release.

In no event shall TI's liability arising out of such information exceed the total purchase price of the TI part(s) at issue in this document sold by TI to Customer on an annual basis.

TAPE AND REEL INFORMATION

QUADRANT ASSIGNMENTS FOR PIN 1 ORIENTATION IN TAPE

*All dimensions are nominal

| Device | Package Type | Package Drawing | Pins | SPQ | Reel Diameter (mm) | Reel Width W1 (mm) | A0 (mm) | B0 (mm) | K0 (mm) | P1 (mm) | W (mm) | Pin1 Quadrant |
|-------------|--------------|-----------------|------|------|--------------------|--------------------|---------|---------|---------|---------|--------|---------------|
| CSD17318Q2 | WSO | DQK | 6 | 3000 | 180.0 | 9.5 | 2.3 | 2.3 | 1.0 | 4.0 | 8.0 | Q1 |
| CSD17318Q2T | WSO | DQK | 6 | 250 | 180.0 | 9.5 | 2.3 | 2.3 | 1.0 | 4.0 | 8.0 | Q1 |

TAPE AND REEL BOX DIMENSIONS

*All dimensions are nominal

| Device | Package Type | Package Drawing | Pins | SPQ | Length (mm) | Width (mm) | Height (mm) |
|-------------|--------------|-----------------|------|------|-------------|------------|-------------|
| CSD17318Q2 | WSON | DQK | 6 | 3000 | 189.0 | 185.0 | 36.0 |
| CSD17318Q2T | WSON | DQK | 6 | 250 | 189.0 | 185.0 | 36.0 |

IMPORTANT NOTICE AND DISCLAIMER

TI PROVIDES TECHNICAL AND RELIABILITY DATA (INCLUDING DATA SHEETS), DESIGN RESOURCES (INCLUDING REFERENCE DESIGNS), APPLICATION OR OTHER DESIGN ADVICE, WEB TOOLS, SAFETY INFORMATION, AND OTHER RESOURCES "AS IS" AND WITH ALL FAULTS, AND DISCLAIMS ALL WARRANTIES, EXPRESS AND IMPLIED, INCLUDING WITHOUT LIMITATION ANY IMPLIED WARRANTIES OF MERCHANTABILITY, FITNESS FOR A PARTICULAR PURPOSE OR NON-INFRINGEMENT OF THIRD PARTY INTELLECTUAL PROPERTY RIGHTS.

These resources are intended for skilled developers designing with TI products. You are solely responsible for (1) selecting the appropriate TI products for your application, (2) designing, validating and testing your application, and (3) ensuring your application meets applicable standards, and any other safety, security, regulatory or other requirements.

These resources are subject to change without notice. TI grants you permission to use these resources only for development of an application that uses the TI products described in the resource. Other reproduction and display of these resources is prohibited. No license is granted to any other TI intellectual property right or to any third party intellectual property right. TI disclaims responsibility for, and you will fully indemnify TI and its representatives against, any claims, damages, costs, losses, and liabilities arising out of your use of these resources.

TI's products are provided subject to [TI's Terms of Sale](#) or other applicable terms available either on [ti.com](https://www.ti.com) or provided in conjunction with such TI products. TI's provision of these resources does not expand or otherwise alter TI's applicable warranties or warranty disclaimers for TI products.

TI objects to and rejects any additional or different terms you may have proposed.

Mailing Address: Texas Instruments, Post Office Box 655303, Dallas, Texas 75265
Copyright © 2023, Texas Instruments Incorporated