

CSD87502Q2 30 V Dual N-Channel NexFET™ Power MOSFETs

1 Features

- Low On-Resistance
- Dual Independent MOSFETs
- Space Saving SON 2 x 2 mm Plastic Package
- Optimized for 5 V Gate Driver
- Avalanche Rated
- Pb and Halogen Free
- RoHS Compliant

2 Applications

- Point-of-Load Synchronous Buck Converter for Applications in Networking, Telecom, and Computing Systems
- Adaptor or USB Input Protection for Notebook PCs and Tablets
- Battery Protection

3 Description

The CSD87502Q2 is a 30 V, 27 mΩ N-Channel device with dual independent MOSFETs in a SON 2 x 2 mm plastic package. The two FETs were designed to be used in a half-bridge configuration for synchronous buck and other power supply applications. Additionally, these NexFET™ power MOSFETs can be used for adaptor, USB input protection, and battery charging applications. The dual FETs feature low drain-to-source on-resistance that minimizes losses and offers low component count for space-constrained applications.

Top View and Circuit Image

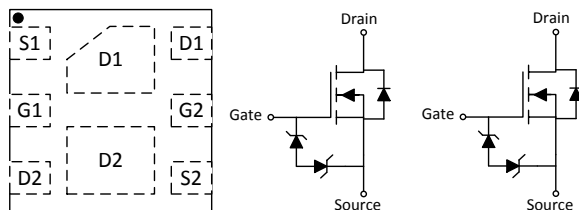

$R_{DS(on)}$ vs V_{GS}

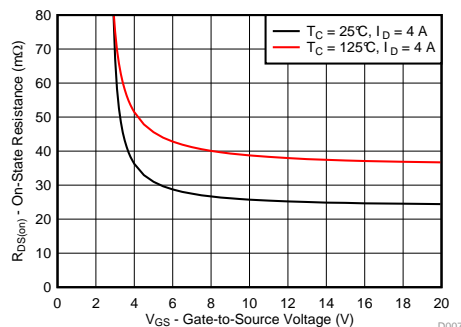

Gate Charge

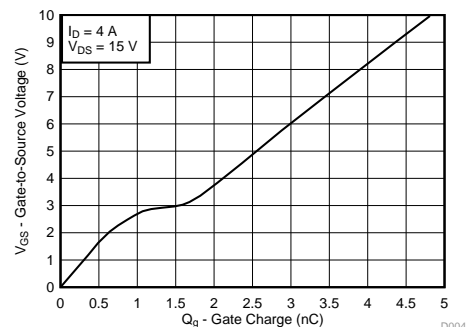

Product Summary

$T_A = 25^\circ\text{C}$		TYPICAL VALUE		UNIT
V_{DS}	Drain-to-Source Voltage	30		V
Q_g	Gate Charge Total (4.5 V)	2.2		nC
Q_{gd}	Gate Charge Gate to Drain	0.5		nC
$R_{DS(on)}$	Drain-to-Source On Resistance	$V_{GS} = 3.8\text{ V}$	42.0	mΩ
		$V_{GS} = 4.5\text{ V}$	35.5	mΩ
		$V_{GS} = 10\text{ V}$	27.0	mΩ
$V_{GS(th)}$	Threshold Voltage	1.6		V

Ordering Information⁽¹⁾

DEVICE	MEDIA	QTY	PACKAGE	SHIP
CSD87502Q2	7-Inch Reel	3000	SON 2 x 2 mm Plastic Package	Tape and Reel
CSD87502Q2T	7-Inch Reel	250		

(1) For all available packages, see the orderable addendum at the end of the data sheet.

Absolute Maximum Ratings

$T_A = 25^\circ\text{C}$		VALUE	UNIT
V_{DS}	Drain-to-Source Voltage	30	V
V_{GS}	Gate-to-Source Voltage	± 20	V
I_D	Continuous Drain Current (Package limited)	5.0	A
I_{DM}	Pulsed Drain Current ⁽¹⁾	23	A
P_D	Power Dissipation ⁽²⁾	2.3	W
T_J, T_{stg}	Operating Junction Temperature, Storage Temperature	-55 to 150	$^\circ\text{C}$
E_{AS}	Avalanche Energy, single pulse $I_D = 7.9\text{ A}, L = 0.1\text{ mH}, R_G = 25\ \Omega$	3.1	mJ

(1) Max $R_{\theta JA} = 185\ ^\circ\text{C}/\text{W}$, pulse duration $\leq 100\ \mu\text{s}$, duty cycle $\leq 1\%$.

(2) Typical $R_{\theta JA} = 55\ ^\circ\text{C}/\text{W}$ on a 1 inch², 2 oz. Cu pad on a 0.06 inch thick FR4 PCB.



Table of Contents

1 Features	1	6.1 Community Resources.....	7
2 Applications	1	6.2 Trademarks	7
3 Description	1	6.3 Electrostatic Discharge Caution	7
4 Revision History	2	6.4 Glossary	7
5 Specifications	3	7 Mechanical, Packaging, and Orderable Information	8
5.1 Electrical Characteristics.....	3	7.1 Package Dimensions	8
5.2 Thermal Information	3	7.2 PCB Land Pattern	9
5.3 Typical MOSFET Characteristics.....	4	7.3 Recommended Stencil Opening	9
6 Device and Documentation Support	7	7.4 Q2 Tape and Reel Information.....	10

4 Revision History

DATE	REVISION	NOTES
December 2015	*	Initial release.

5 Specifications

5.1 Electrical Characteristics

($T_A = 25^\circ\text{C}$ unless otherwise stated)

PARAMETER		TEST CONDITIONS	MIN	TYP	MAX	UNIT
STATIC CHARACTERISTICS						
V_{DSS}	Drain-to-source voltage	$V_{GS} = 0\text{ V}, I_D = 250\ \mu\text{A}$	30			V
I_{DSS}	Drain-to-source leakage current	$V_{GS} = 0\text{ V}, V_{DS} = 24\text{ V}$			1	μA
I_{GSS}	Gate-to-source leakage current	$V_{DS} = 0\text{ V}, V_{GS} = 20\text{ V}$			4	μA
$V_{GS(th)}$	Gate-to-source threshold voltage	$V_{DS} = V_{GS}, I_D = 250\ \mu\text{A}$	1.2	1.6	2.0	V
$R_{DS(on)}$	Drain-to-source on-resistance	$V_{GS} = 3.8\text{ V}, I_D = 4\text{ A}$		42.0	60.0	m Ω
		$V_{GS} = 4.5\text{ V}, I_D = 4\text{ A}$		35.5	42.0	m Ω
		$V_{GS} = 10\text{ V}, I_D = 4\text{ A}$		27.0	32.4	m Ω
g_{fs}	Transconductance	$V_{DS} = 3\text{ V}, I_D = 4\text{ A}$		75		S
DYNAMIC CHARACTERISTICS						
C_{iss}	Input capacitance	$V_{GS} = 0\text{ V}, V_{DS} = 15\text{ V}, f = 1\text{ MHz}$		272	353	pF
C_{oss}	Output capacitance			42	55	pF
C_{rss}	Reverse transfer capacitance			22	29	pF
R_G	Series gate resistance			6.9		Ω
Q_g	Gate charge total (4.5 V)	$V_{DS} = 15\text{ V}, I_D = 4\text{ A}$		2.2	2.9	nC
Q_g	Gate charge total (10 V)			4.6	6.0	nC
Q_{gd}	Gate charge gate to drain			0.5		nC
Q_{gs}	Gate charge gate to source			1.0		nC
$Q_{g(th)}$	Gate charge at V_{th}			0.5		nC
Q_{oss}	Output charge		$V_{DS} = 15\text{ V}, V_{GS} = 0\text{ V}$		1.4	
$t_{d(on)}$	Turn on delay time	$V_{DS} = 15\text{ V}, V_{GS} = 5\text{ V}, I_{DS} = 4\text{ A}, R_G = 0\ \Omega$		3		ns
t_r	Rise time			11		ns
$t_{d(off)}$	Turn off delay time			12		ns
t_f	Fall time			3		ns
DIODE CHARACTERISTICS						
V_{SD}	Diode forward voltage	$I_{SD} = 4\text{ A}, V_{GS} = 0\text{ V}$		0.85	1.0	V
Q_{rr}	Reverse recovery charge	$V_{DS} = 15\text{ V}, I_F = 4\text{ A}, di/dt = 300\text{ A}/\mu\text{s}$		4.0		nC
t_{rr}	Reverse recovery time			6.4		ns

5.2 Thermal Information

($T_A = 25^\circ\text{C}$ unless otherwise stated)

THERMAL METRIC		MIN	TYP	MAX	UNIT
$R_{\theta JA}$	Junction-to-ambient thermal resistance ⁽¹⁾			70	$^\circ\text{C}/\text{W}$
	Junction-to-ambient thermal resistance ⁽²⁾			185	

(1) Device mounted on FR4 material with 1 inch² (6.45 cm²), 2 oz. (0.071 mm thick) Cu.

(2) Device mounted on FR4 material with minimum Cu mounting area.

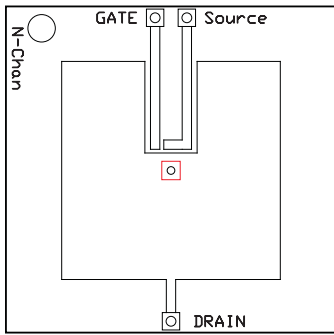

Max $R_{\theta JA} = 70$ when mounted on 1 inch² (6.45 cm²) of 2 oz. (0.071 mm thick) Cu.

M0164-01

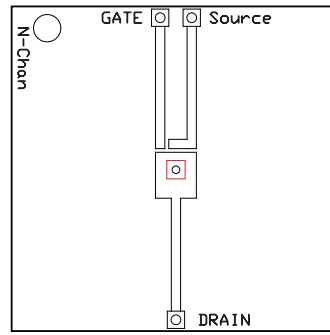

Max $R_{\theta JA} = 185$ when mounted on minimum pad area of 2 oz. (0.071 mm thick) Cu.

M0164-02

5.3 Typical MOSFET Characteristics

($T_A = 25^\circ\text{C}$ unless otherwise stated)

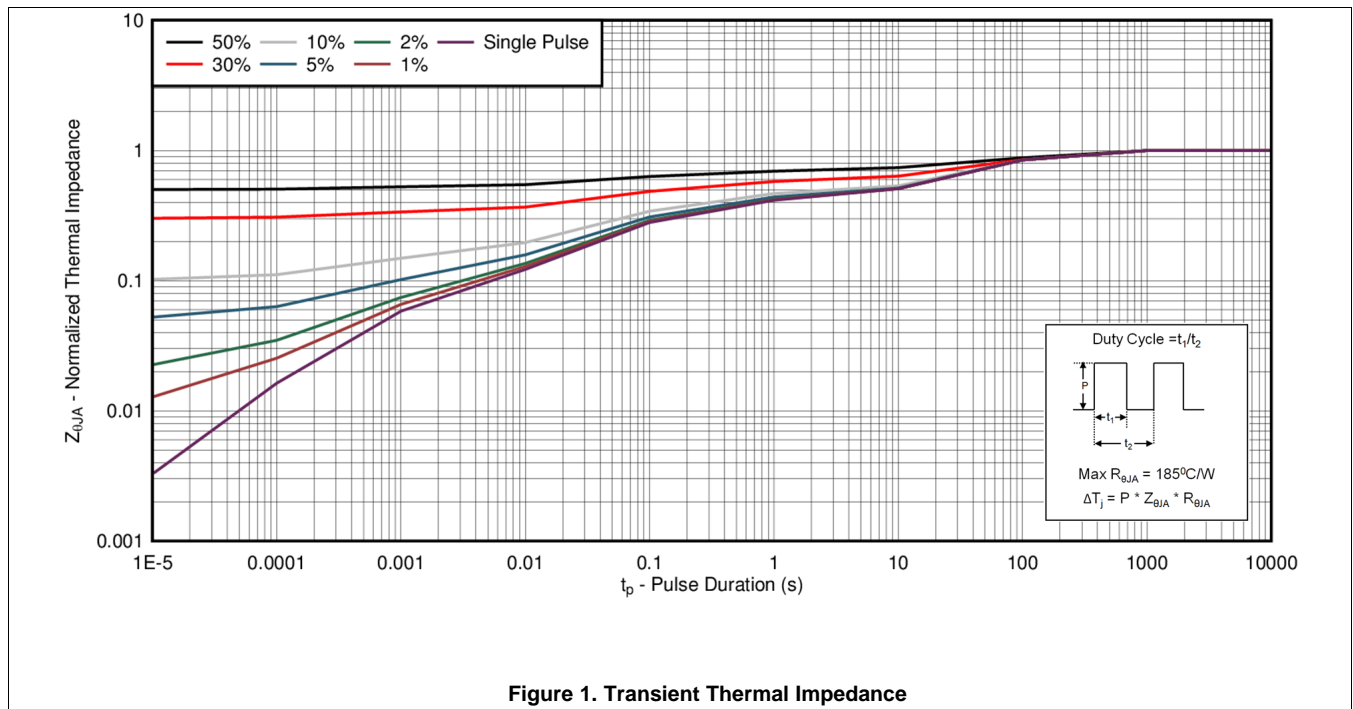
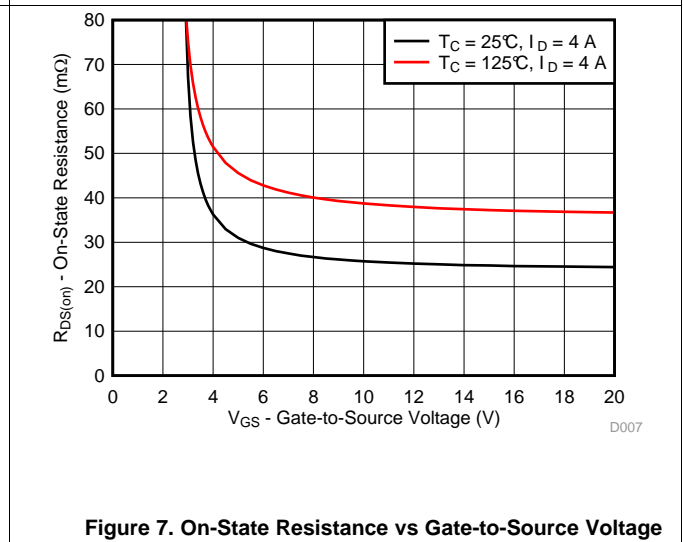
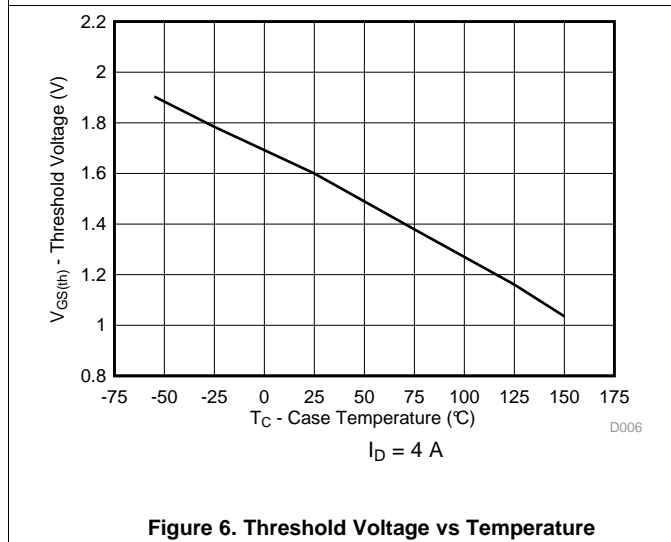
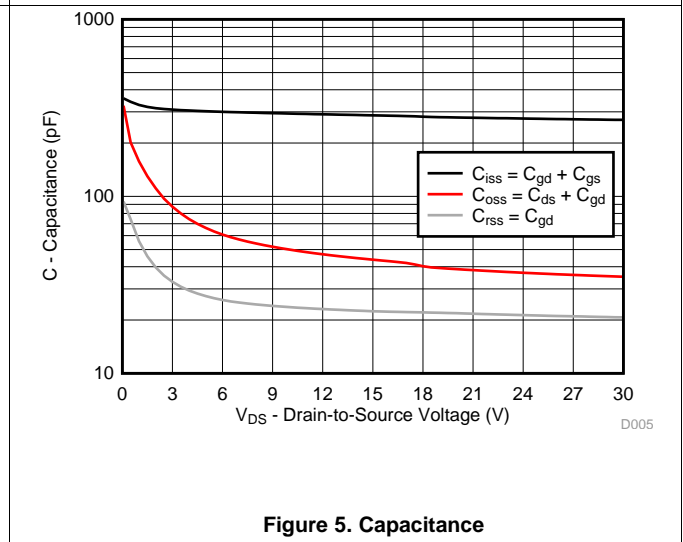
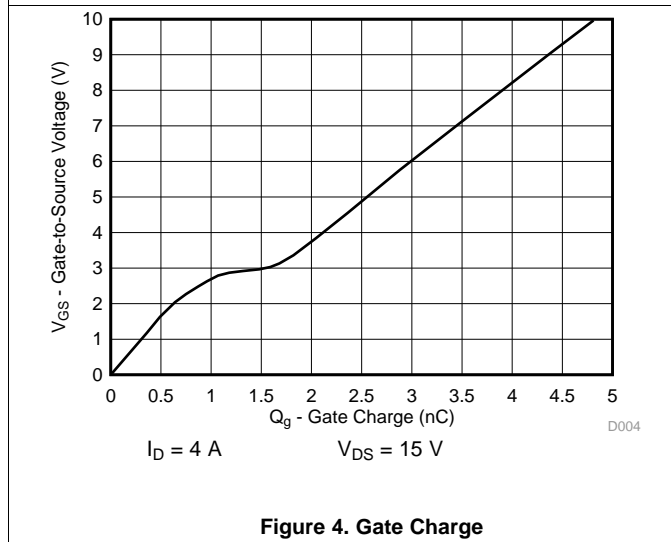
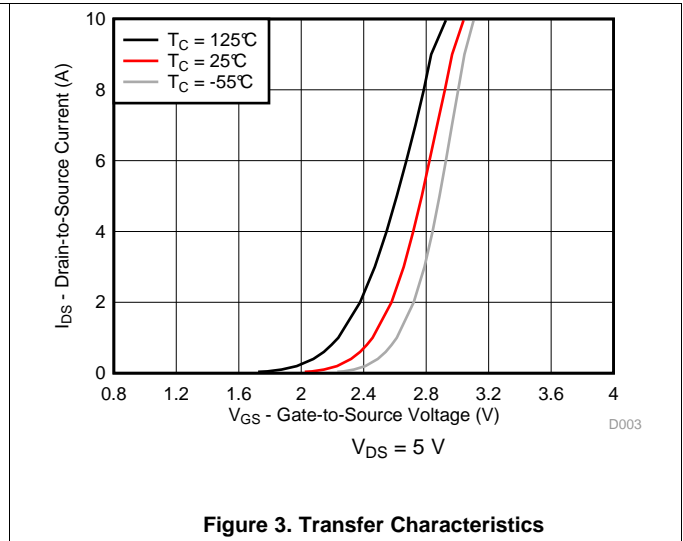
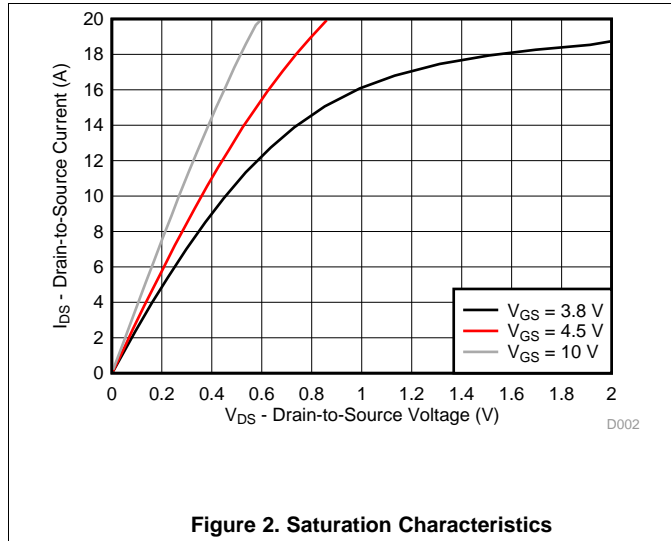

Figure 1. Transient Thermal Impedance

Typical MOSFET Characteristics (continued)

($T_A = 25^\circ\text{C}$ unless otherwise stated)



Typical MOSFET Characteristics (continued)

($T_A = 25^\circ\text{C}$ unless otherwise stated)

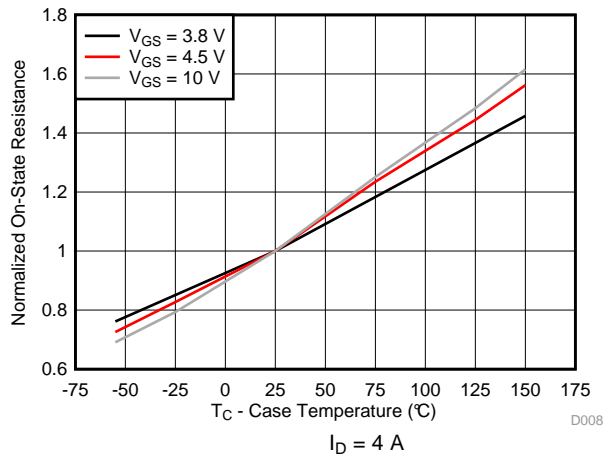

Figure 8. Normalized On-State Resistance vs Temperature

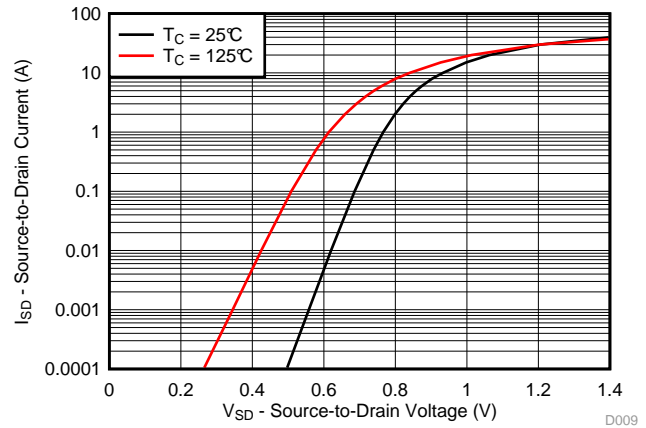

Figure 9. Typical Diode Forward Voltage

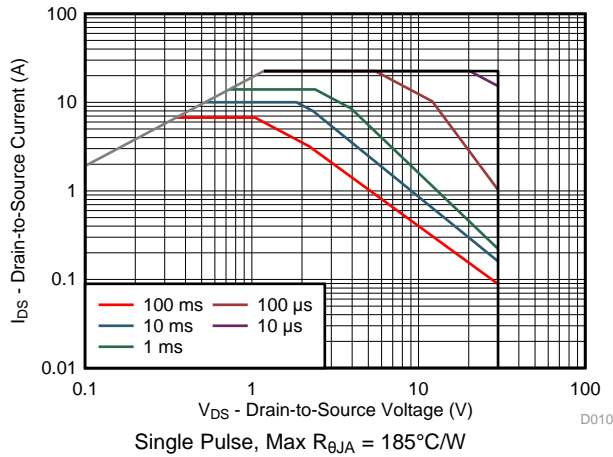

Figure 10. Maximum Safe Operating Area

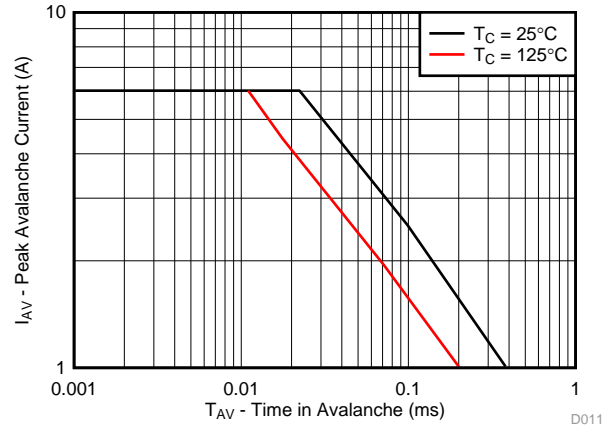

Figure 11. Single Pulse Unclamped Inductive Switching

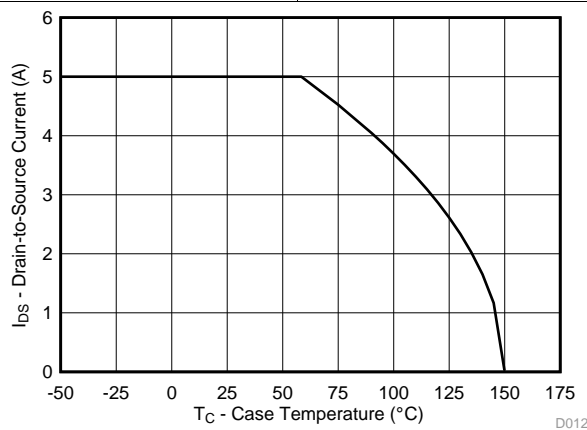

Figure 12. Maximum Drain Current vs Temperature

6 Device and Documentation Support

6.1 Community Resources

The following links connect to TI community resources. Linked contents are provided "AS IS" by the respective contributors. They do not constitute TI specifications and do not necessarily reflect TI's views; see TI's [Terms of Use](#).

TI E2E™ Online Community *TI's Engineer-to-Engineer (E2E) Community*. Created to foster collaboration among engineers. At e2e.ti.com, you can ask questions, share knowledge, explore ideas and help solve problems with fellow engineers.

Design Support *TI's Design Support* Quickly find helpful E2E forums along with design support tools and contact information for technical support.

6.2 Trademarks

NexFET, E2E are trademarks of Texas Instruments.
All other trademarks are the property of their respective owners.

6.3 Electrostatic Discharge Caution



These devices have limited built-in ESD protection. The leads should be shorted together or the device placed in conductive foam during storage or handling to prevent electrostatic damage to the MOS gates.

6.4 Glossary

[SLYZ022](#) — *TI Glossary*.

This glossary lists and explains terms, acronyms, and definitions.

7 Mechanical, Packaging, and Orderable Information

The following pages include mechanical, packaging, and orderable information. This information is the most current data available for the designated devices. This data is subject to change without notice and revision of this document. For browser-based versions of this data sheet, refer to the left-hand navigation.

7.1 Package Dimensions

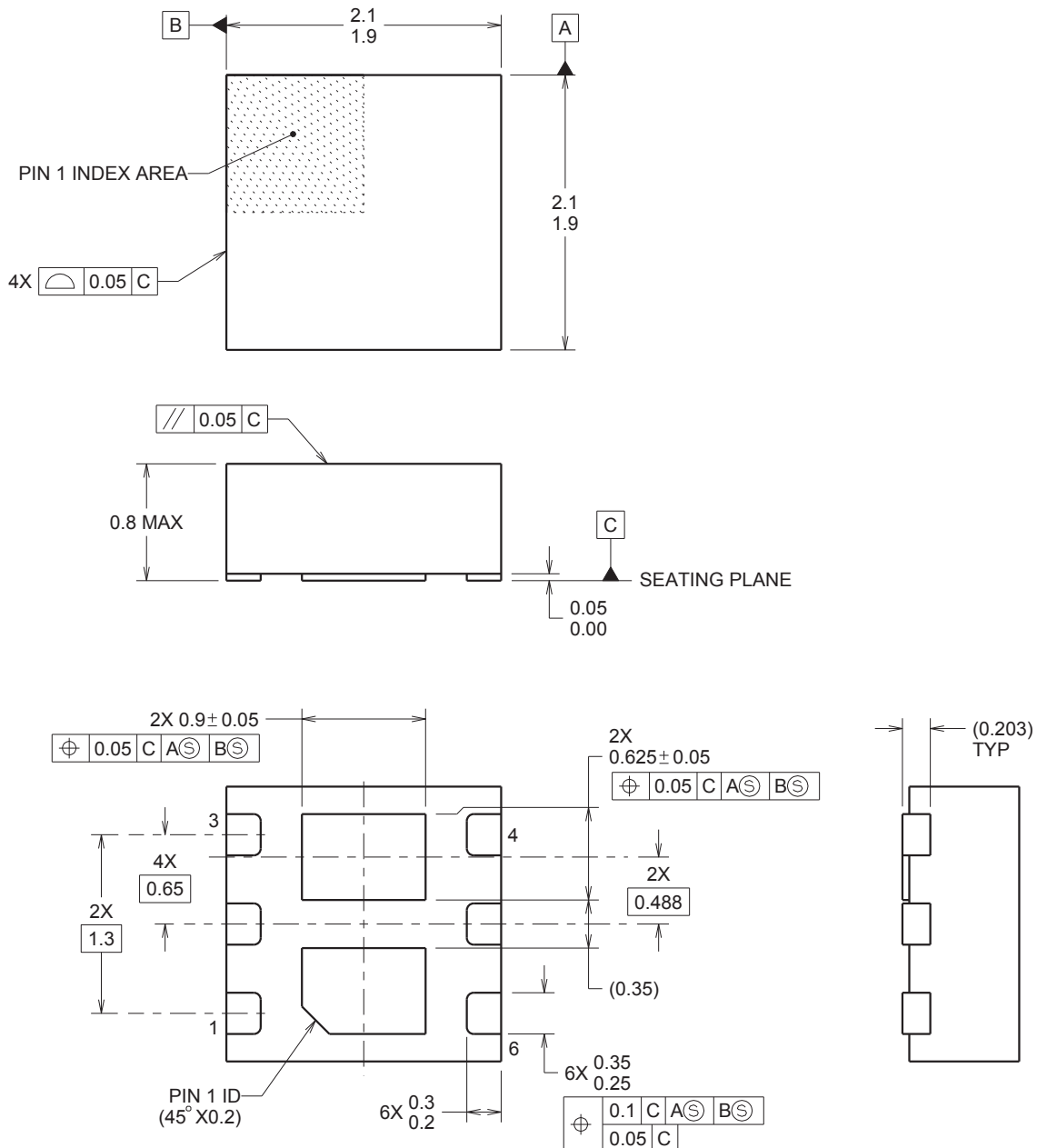

All dimensions are in mm, unless otherwise stated.

7.2 PCB Land Pattern

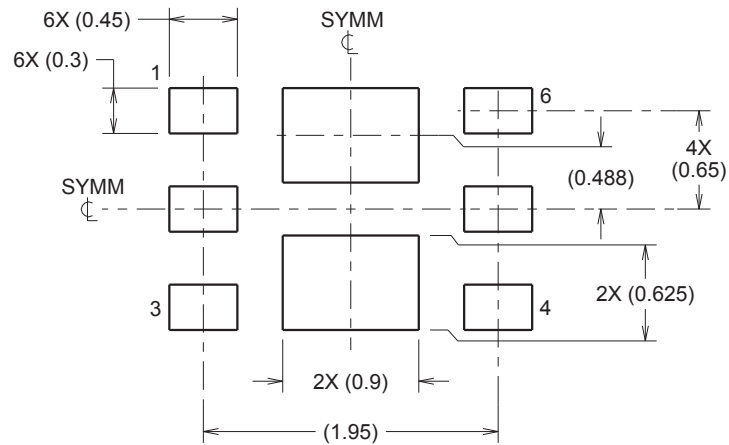

For recommended circuit layout for PCB designs, see application note [SLPA005 – Reducing Ringing Through PCB Layout Techniques](#).

7.3 Recommended Stencil Opening

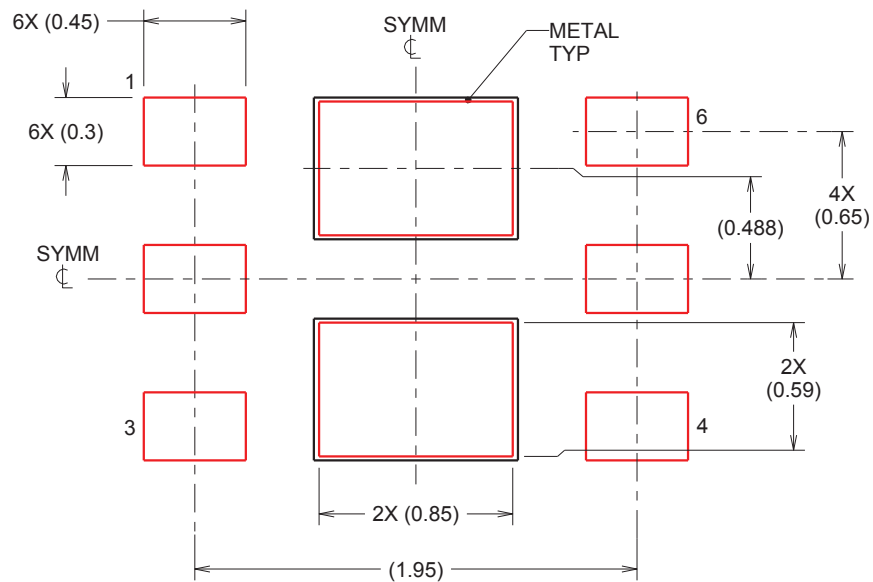

All dimensions are in mm, unless otherwise stated.

7.4 Q2 Tape and Reel Information

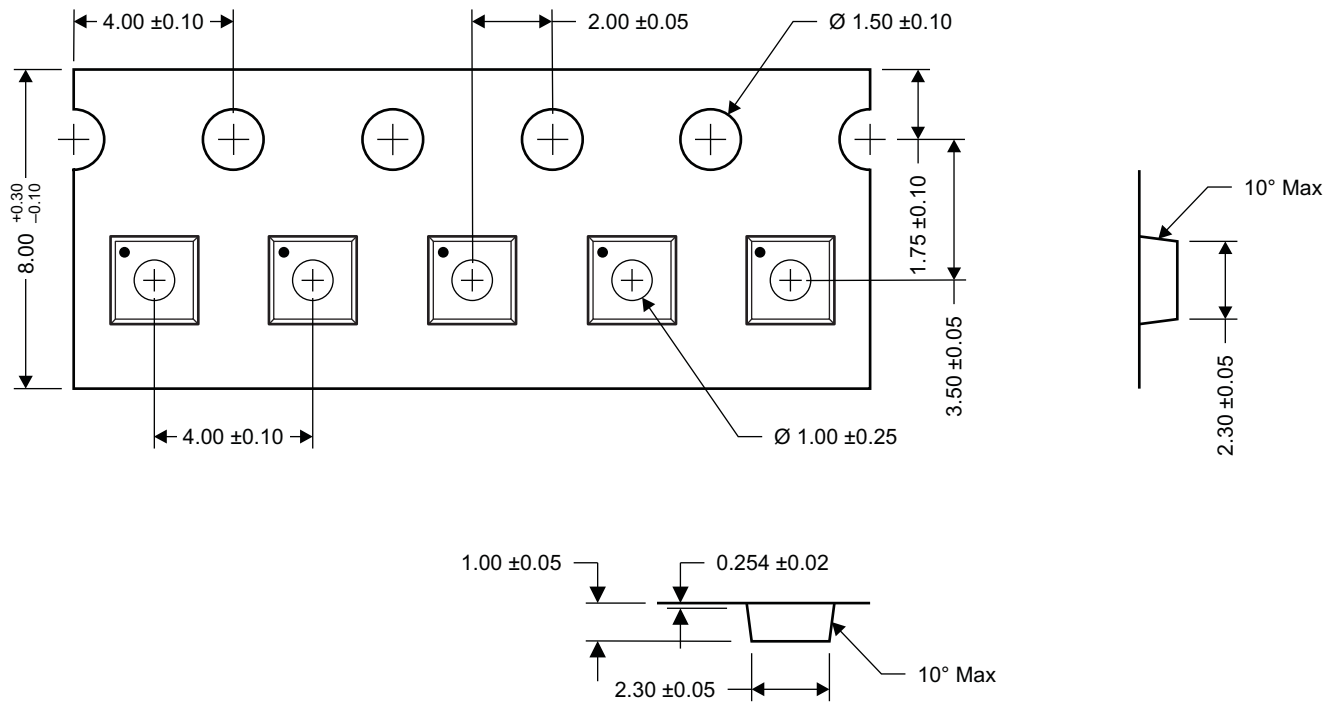

- Notes:
1. Measured from centerline of sprocket hole to centerline of pocket
 2. Cumulative tolerance of 10 sprocket holes is ± 0.20
 3. Other material available
 4. Typical SR of form tape Max 10^9 OHM/SQ
 5. All dimensions are in mm, unless otherwise specified.

M0168-01

PACKAGING INFORMATION

Orderable part number	Status (1)	Material type (2)	Package Pins	Package qty Carrier	RoHS (3)	Lead finish/ Ball material (4)	MSL rating/ Peak reflow (5)	Op temp (°C)	Part marking (6)
CSD87502Q2	Active	Production	WSON (DLV) 6	3000 LARGE T&R	Yes	NIPDAU	Level-1-260C-UNLIM	-55 to 150	8752
CSD87502Q2.Z	Active	Production	WSON (DLV) 6	3000 LARGE T&R	Yes	NIPDAU	Level-1-260C-UNLIM	-55 to 150	8752
CSD87502Q2G4.Z	Active	Production	WSON (DLV) 6	3000 LARGE T&R	Yes	NIPDAU	Level-1-260C-UNLIM	-55 to 150	8752
CSD87502Q2T	Active	Production	WSON (DLV) 6	250 SMALL T&R	Yes	NIPDAU	Level-1-260C-UNLIM	-55 to 150	8752
CSD87502Q2T.Z	Active	Production	WSON (DLV) 6	250 SMALL T&R	Yes	NIPDAU	Level-1-260C-UNLIM	-55 to 150	8752

(1) **Status:** For more details on status, see our [product life cycle](#).

(2) **Material type:** When designated, preproduction parts are prototypes/experimental devices, and are not yet approved or released for full production. Testing and final process, including without limitation quality assurance, reliability performance testing, and/or process qualification, may not yet be complete, and this item is subject to further changes or possible discontinuation. If available for ordering, purchases will be subject to an additional waiver at checkout, and are intended for early internal evaluation purposes only. These items are sold without warranties of any kind.

(3) **RoHS values:** Yes, No, RoHS Exempt. See the [TI RoHS Statement](#) for additional information and value definition.

(4) **Lead finish/Ball material:** Parts may have multiple material finish options. Finish options are separated by a vertical ruled line. Lead finish/Ball material values may wrap to two lines if the finish value exceeds the maximum column width.

(5) **MSL rating/Peak reflow:** The moisture sensitivity level ratings and peak solder (reflow) temperatures. In the event that a part has multiple moisture sensitivity ratings, only the lowest level per JEDEC standards is shown. Refer to the shipping label for the actual reflow temperature that will be used to mount the part to the printed circuit board.

(6) **Part marking:** There may be an additional marking, which relates to the logo, the lot trace code information, or the environmental category of the part.

Multiple part markings will be inside parentheses. Only one part marking contained in parentheses and separated by a "-" will appear on a part. If a line is indented then it is a continuation of the previous line and the two combined represent the entire part marking for that device.

Important Information and Disclaimer: The information provided on this page represents TI's knowledge and belief as of the date that it is provided. TI bases its knowledge and belief on information provided by third parties, and makes no representation or warranty as to the accuracy of such information. Efforts are underway to better integrate information from third parties. TI has taken and continues to take reasonable steps to provide representative and accurate information but may not have conducted destructive testing or chemical analysis on incoming materials and chemicals. TI and TI suppliers consider certain information to be proprietary, and thus CAS numbers and other limited information may not be available for release.

In no event shall TI's liability arising out of such information exceed the total purchase price of the TI part(s) at issue in this document sold by TI to Customer on an annual basis.

IMPORTANT NOTICE AND DISCLAIMER

TI PROVIDES TECHNICAL AND RELIABILITY DATA (INCLUDING DATA SHEETS), DESIGN RESOURCES (INCLUDING REFERENCE DESIGNS), APPLICATION OR OTHER DESIGN ADVICE, WEB TOOLS, SAFETY INFORMATION, AND OTHER RESOURCES "AS IS" AND WITH ALL FAULTS, AND DISCLAIMS ALL WARRANTIES, EXPRESS AND IMPLIED, INCLUDING WITHOUT LIMITATION ANY IMPLIED WARRANTIES OF MERCHANTABILITY, FITNESS FOR A PARTICULAR PURPOSE OR NON-INFRINGEMENT OF THIRD PARTY INTELLECTUAL PROPERTY RIGHTS.

These resources are intended for skilled developers designing with TI products. You are solely responsible for (1) selecting the appropriate TI products for your application, (2) designing, validating and testing your application, and (3) ensuring your application meets applicable standards, and any other safety, security, regulatory or other requirements.

These resources are subject to change without notice. TI grants you permission to use these resources only for development of an application that uses the TI products described in the resource. Other reproduction and display of these resources is prohibited. No license is granted to any other TI intellectual property right or to any third party intellectual property right. TI disclaims responsibility for, and you will fully indemnify TI and its representatives against, any claims, damages, costs, losses, and liabilities arising out of your use of these resources.

TI's products are provided subject to [TI's Terms of Sale](#) or other applicable terms available either on [ti.com](https://www.ti.com) or provided in conjunction with such TI products. TI's provision of these resources does not expand or otherwise alter TI's applicable warranties or warranty disclaimers for TI products.

TI objects to and rejects any additional or different terms you may have proposed.

Mailing Address: Texas Instruments, Post Office Box 655303, Dallas, Texas 75265
Copyright © 2025, Texas Instruments Incorporated