

LM140LQML Series 3-Terminal Positive Regulators

Check for Samples: [LM140LQML](#)

FEATURES

- Line Regulation of 0.04%/V
- Load Regulation of 0.01%/mA
- Output Voltage Tolerances of $\pm 2\%$ at $T_j = 25^\circ\text{C}$ and $\pm 4\%$ over the Temperature Range
- Output Current of 100 mA
- Internal Thermal Overload Protection
- Output Transistor Safe Area Protection
- Internal Short Circuit Current Limit

DESCRIPTION

The LM140L series of three terminal positive regulators is available with several fixed output voltages making them useful in a wide range of applications. The LM140LA is an improved version of the LM78LXX series with a tighter output voltage tolerance (specified over the full military temperature range), higher ripple rejection, better regulation and lower quiescent current. The LM140LA regulators have $\pm 2\%$ V_{OUT} specification, 0.04%/V line regulation, and 0.01%/mA load regulation. When used as a zener diode/resistor combination replacement, the LM140LA usually results in an effective output impedance improvement of two orders of magnitude, and lower quiescent current. These regulators can provide local on card regulation, eliminating the distribution problems associated with single point regulation. The voltages available allow the LM140LA to be used in logic systems, instrumentation, Hi-Fi, and other solid state electronic equipment. Although designed primarily as fixed voltage regulators, these devices can be used with external components to obtain adjustable voltages and currents.

With adequate heat sinking the regulator can deliver 100 mA output current. Current limiting is included to limit the peak output current to a safe value. Safe area protection for the output transistor is provided to limit internal power dissipation. If internal power dissipation becomes too high for the heat sinking provided, the thermal shut-down circuit takes over, preventing the IC from overheating.

Output Voltage Options

Device ID	Output Voltage
LM140LA-5.0	5V
LM140LA-12	12V
LM140LA-15	15V



Please be aware that an important notice concerning availability, standard warranty, and use in critical applications of Texas Instruments semiconductor products and disclaimers thereto appears at the end of this data sheet.

All trademarks are the property of their respective owners.

Connection Diagrams

TO-39 Metal Can Package

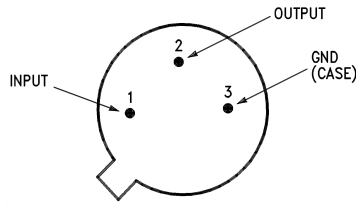
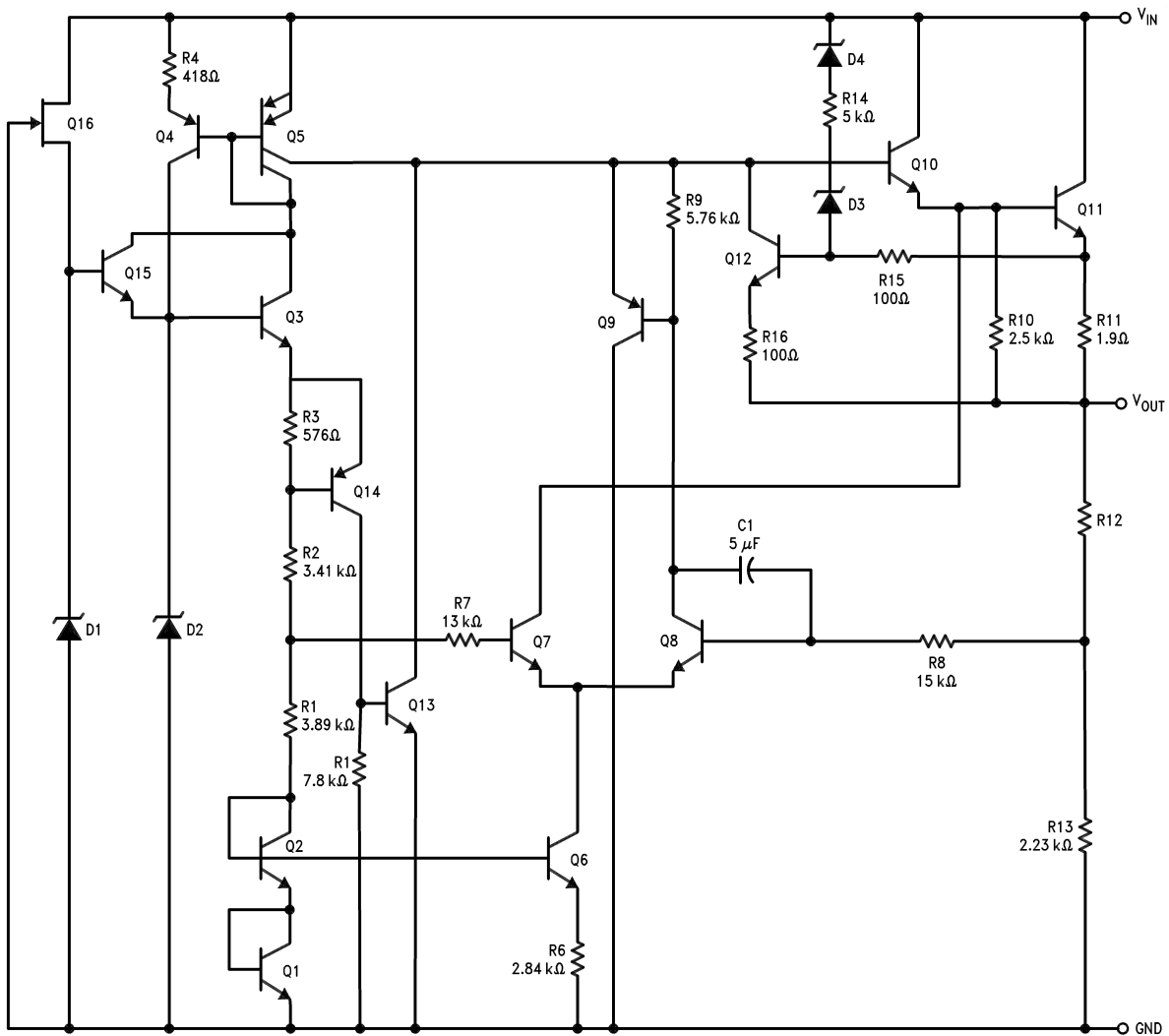

Figure 1. Bottom View
See Package NDT0003A

Equivalent Circuit



These devices have limited built-in ESD protection. The leads should be shorted together or the device placed in conductive foam during storage or handling to prevent electrostatic damage to the MOS gates.

Absolute Maximum Ratings⁽¹⁾

Input Voltage		35V	
Internal Power Dissipation ⁽²⁾		Internally Limited	
Operating Temperature Range		-55°C ≤ T _A ≤ +125°C	
Maximum Junction Temperature		+150°C	
Storage Temperature Range		-65°C ≤ T _A ≤ +150°C	
Lead Temperature (Soldering, 10 sec.)		+300°C	
Thermal Resistance	θ _{JA}	Still Air @ 0.5W	201°C/W
		500LF / Min Air Flow @ 0.5W	79°C/W
	θ _{JC} (@ 1.0W)		38°C/W
ESD Susceptibility ⁽³⁾		TBD	

- (1) Absolute Maximum Ratings indicate limits beyond which damage to the device may occur. Operating Ratings indicate conditions for which the device is functional, but do not specify specific performance limits. For ensured specifications and test conditions, see the Electrical Characteristics. The ensured specifications apply only for the test conditions listed. Some performance characteristics may degrade when the device is not operated under the listed test conditions.
- (2) The maximum power dissipation must be derated at elevated temperatures and is dictated by T_{Jmax} (maximum junction temperature), θ_{JA} (package junction to ambient thermal resistance), and T_A (ambient temperature). The maximum allowable power dissipation at any temperature is P_{Dmax} = (T_{Jmax} - T_A)/θ_{JA} or the number given in the Absolute Maximum Ratings, whichever is lower.
- (3) Human body model, 100pF discharged through 1.5KΩ

Quality Conformance Inspection

Mil-Std-883, Method 5005 - Group A

Subgroup	Description	Temp °C
1	Static tests at	25
2	Static tests at	125
3	Static tests at	-55
4	Dynamic tests at	25
5	Dynamic tests at	125
6	Dynamic tests at	-55
7	Functional tests at	25
8A	Functional tests at	125
8B	Functional tests at	-55
9	Switching tests at	25
10	Switching tests at	125
11	Switching tests at	-55
12	Settling time at	25
13	Settling time at	125
14	Settling time at	-55

LM140LA-5.0 Electrical Characteristics DC Parameters

The following conditions apply, unless otherwise specified. DC: $V_I = 10V$, $I_L = 40mA$

Symbol	Parameter	Conditions	Notes	Min	Max	Unit	Sub-groups
I_Q	Quiescent Current				4.5	mA	1
					4.2	mA	2
V_O	Output Voltage			4.9	5.1	V	1
		$V_I = 20V$, $I_L = 5mA$		4.8	5.2	V	1, 2, 3
		$V_I = 20V$, $I_L = 100mA$		4.8	5.2	V	1, 2, 3
		$V_I = 7.2V$, $I_L = 5mA$		4.8	5.2	V	1, 2, 3
		$V_I = 7.2V$, $I_L = 100mA$		4.8	5.2	V	1, 2, 3
R_{Load}	Load Regulation	$5mA \leq I_L \leq 40mA$		-20	20	mV	1
		$5mA \leq I_L \leq 100mA$		-40	40	mV	1
R_{Line}	Line Regulation	$I_L = 100mA$, $7.5V \leq V_I \leq 25V$		-30	30	mV	1
		$7V \leq V_I \leq 25V$		-30	30	mV	1
ΔI_Q	Quiescent Current Change	$5mA \leq I_L \leq 40mA$		-0.1	0.1	mA	1, 2, 3
		$7.5V \leq V_I \leq 35V$		-0.5	0.5	mA	1

LM140LA-5.0 Electrical Characteristics AC Parameters

Symbol	Parameter	Conditions	Notes	Min	Max	Unit	Sub-groups
RR	Ripple Rejection	$f = 120Hz$, $e_i = 1V_{RMS}$		55		dB	4

LM140LA-12 Electrical Characteristics DC Parameters

The following conditions apply, unless otherwise specified. DC: $V_I = 19V$, $I_L = 40mA$

Symbol	Parameter	Conditions	Notes	Min	Max	Unit	Sub-groups
I_Q	Quiescent Current				4.5	mA	1
					4.2	mA	2
V_O	Output Voltage			11.75	12.25	V	1
		$V_I = 27V$, $I_L = 5mA$		11.5	12.5	V	1, 2, 3
		$V_I = 27V$, $I_L = 100mA$		11.5	12.5	V	1, 2, 3
		$V_I = 14.5V$, $I_L = 5mA$		11.5	12.5	V	1, 2, 3
		$V_I = 14.5V$, $I_L = 100mA$		11.5	12.5	V	1, 2, 3
R_{Load}	Load Regulation	$5mA \leq I_L \leq 40mA$		-40	40	mV	1
		$5mA \leq I_L \leq 100mA$		-80	80	mV	1
R_{Line}	Line Regulation	$I_L = 100mA$, $14.5V \leq V_I \leq 30V$		-65	65	mV	1
		$14.2V \leq V_I \leq 30V$		-65	65	mV	1
ΔI_Q	Quiescent Current Change	$5mA \leq I_L \leq 40mA$		-0.1	0.1	mA	1, 2, 3
		$14.3V \leq V_I \leq 35V$		-0.5	0.5	mA	1

LM140LA-12 Electrical Characteristics AC Parameters

Symbol	Parameter	Conditions	Notes	Min	Max	Unit	Sub-groups
RR	Ripple Rejection	$f = 120Hz$, $e_i = 1V_{RMS}$		47		dB	4

LM140LA-15 Electrical Characteristics DC Parameters

The following conditions apply, unless otherwise specified. DC: $V_I = 23V$, $I_L = 40mA$

Symbol	Parameter	Conditions	Notes	Min	Max	Unit	Sub-groups
I_Q	Quiescent Current				4.5	mA	1
					4.2	mA	2
V_O	Output Voltage			14.7	15.3	V	1
		$V_I = 30V$, $I_L = 5mA$		14.4	15.6	V	1, 2, 3
		$V_I = 30V$, $I_L = 100mA$		14.4	15.6	V	1, 2, 3
		$V_I = 17.6V$, $I_L = 5mA$		14.4	15.6	V	1, 2, 3
		$V_I = 17.6V$, $I_L = 100mA$		14.4	15.6	V	1, 2, 3
R_{Load}	Load Regulation	$5mA \leq I_L \leq 40mA$		-50	50	mV	1
		$5mA \leq I_L \leq 100mA$		-100	100	mV	1
R_{Line}	Line Regulation	$I_L = 100mA$, $17.3V \leq V_I \leq 30V$		-70	70	mV	1
		$17.3V \leq V_I \leq 30V$		-70	70	mV	1
ΔI_Q	Quiescent Current Change	$5mA \leq I_L \leq 40mA$		-0.1	0.1	mA	1, 2, 3
		$17.5V \leq V_I \leq 35V$		-0.5	0.5	mA	1

LM140LA-15 Electrical Characteristics AC Parameters

Symbol	Parameter	Conditions	Notes	Min	Max	Unit	Sub-groups
RR	Ripple Rejection f	$f = 120Hz$, $e_i = 1V_{RMS}$		47		dB	4

Typical Performance Characteristics

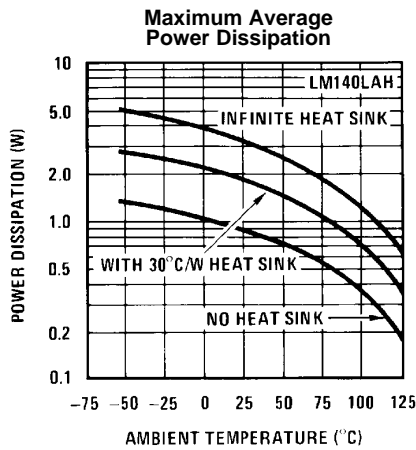

Figure 2.

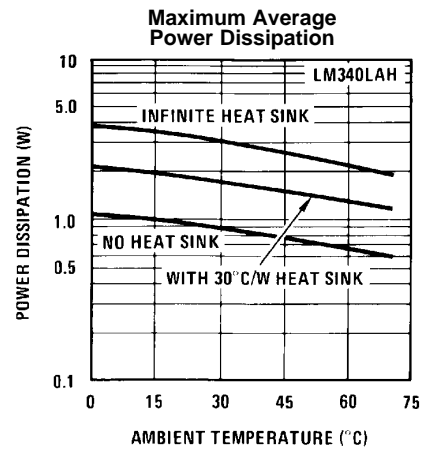

Figure 3.

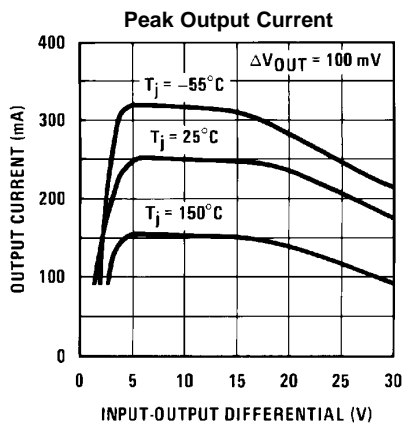

Figure 4.

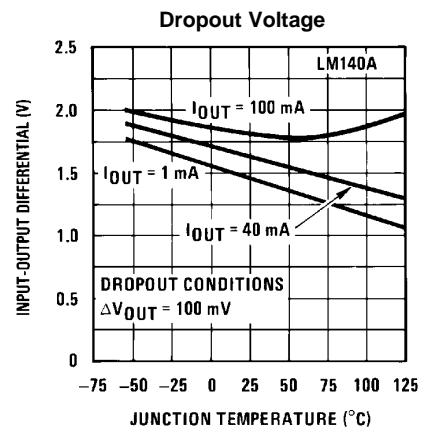

Figure 5.

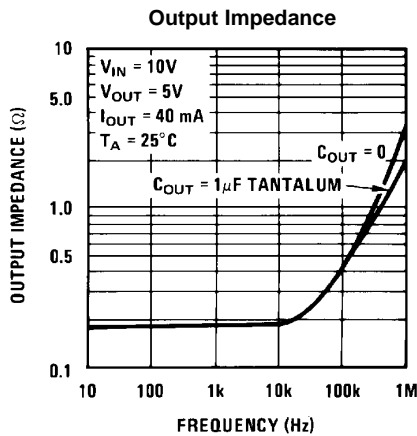

Figure 6.

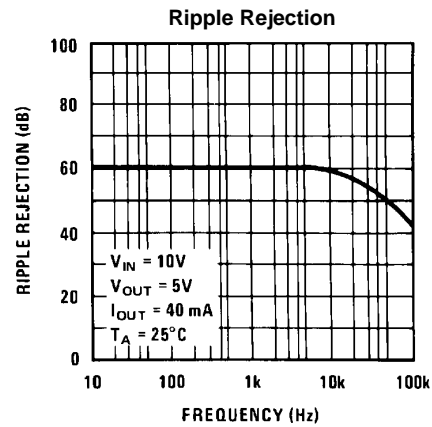
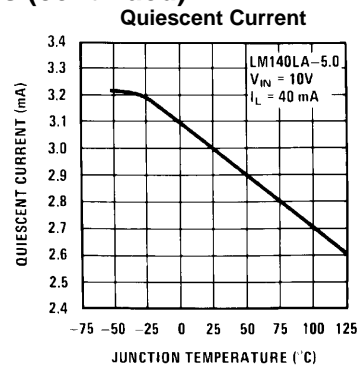
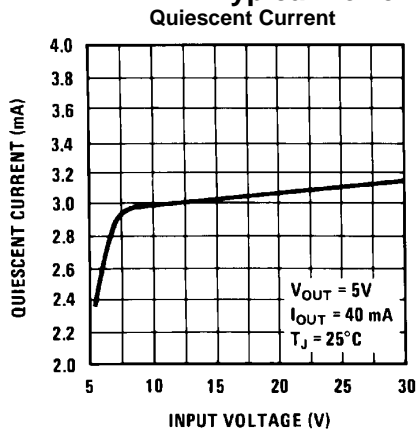

Figure 7.

Typical Performance Characteristics (continued)



TYPICAL APPLICATIONS

NOTE

It is recommended that a minimum load capacitor of 0.01 μF be used to limit the high frequency noise bandwidth.

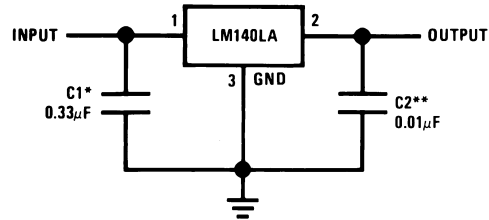

*Required if the regulator is located far from the power supply filter.

**Human body model, 100pF discharged through 1.5K Ω

Figure 10. Fixed Output Regulator

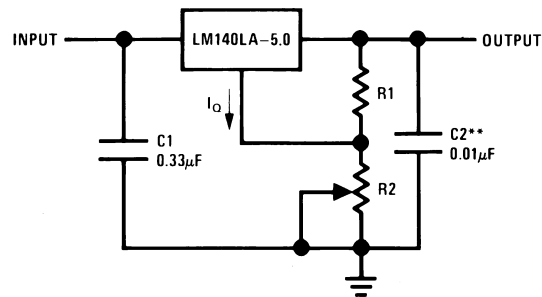

$$V_{OUT} = 5V + (5V/R1 + I_O) R2$$



$$5V/R1 = 3 I_O \text{ load regulation (L.) } [(R1 + R2)/R1] \text{ (L. of LM140LA-5.0)}$$

Figure 11. Adjustable Output Regulator

Revision History

Released	Revision	Section	Originator	Changes
03/10/06	A	New release to corporate format	L. Lytle	3 MDS data sheets converted into one Corp. data sheet format. Drift tables were removed from electrical characteristics since not performed on 883 product. MDS data sheets MNLM140LA-05-H Rev. 0B0, MNLM140LA-12-H Rev. 0B0 and MNLM140LA-15-H Rev. 0B0. will be archived.
05/02/13	A			Changed layout of National Data Sheet to TI format.

PACKAGING INFORMATION

Orderable Device	Status (1)	Package Type	Package Drawing	Pins	Package Qty	Eco Plan (2)	Lead finish/ Ball material (6)	MSL Peak Temp (3)	Op Temp (°C)	Device Marking (4/5)	Samples
LM140LAH-12/883	ACTIVE	TO	NDT	3	20	Non-RoHS & Green	Call TI	Level-1-NA-UNLIM	-55 to 125	LM140LAH-12/883 Q ACO LM140LAH-12/883 Q >T	
LM140LAH-15/883	ACTIVE	TO	NDT	3	20	Non-RoHS & Green	Call TI	Level-1-NA-UNLIM	-55 to 125	LM140LAH-15/883 Q ACO LM140LAH-15/883 Q >T	
LM140LAH5.0/883	ACTIVE	TO	NDT	3	20	Non-RoHS & Green	Call TI	Level-1-NA-UNLIM	-55 to 125	LM140LAH5.0/883 Q ACO LM140LAH5.0/883 Q >T	

(1) The marketing status values are defined as follows:

ACTIVE: Product device recommended for new designs.

LIFEBUY: TI has announced that the device will be discontinued, and a lifetime-buy period is in effect.

NRND: Not recommended for new designs. Device is in production to support existing customers, but TI does not recommend using this part in a new design.

PREVIEW: Device has been announced but is not in production. Samples may or may not be available.

OBSOLETE: TI has discontinued the production of the device.

(2) **RoHS:** TI defines "RoHS" to mean semiconductor products that are compliant with the current EU RoHS requirements for all 10 RoHS substances, including the requirement that RoHS substance do not exceed 0.1% by weight in homogeneous materials. Where designed to be soldered at high temperatures, "RoHS" products are suitable for use in specified lead-free processes. TI may reference these types of products as "Pb-Free".

RoHS Exempt: TI defines "RoHS Exempt" to mean products that contain lead but are compliant with EU RoHS pursuant to a specific EU RoHS exemption.

Green: TI defines "Green" to mean the content of Chlorine (Cl) and Bromine (Br) based flame retardants meet JS709B low halogen requirements of <=1000ppm threshold. Antimony trioxide based flame retardants must also meet the <=1000ppm threshold requirement.

(3) MSL, Peak Temp. - The Moisture Sensitivity Level rating according to the JEDEC industry standard classifications, and peak solder temperature.

(4) There may be additional marking, which relates to the logo, the lot trace code information, or the environmental category on the device.

(5) Multiple Device Markings will be inside parentheses. Only one Device Marking contained in parentheses and separated by a "~" will appear on a device. If a line is indented then it is a continuation of the previous line and the two combined represent the entire Device Marking for that device.

⁽⁶⁾ Lead finish/Ball material - Orderable Devices may have multiple material finish options. Finish options are separated by a vertical ruled line. Lead finish/Ball material values may wrap to two lines if the finish value exceeds the maximum column width.

Important Information and Disclaimer:The information provided on this page represents TI's knowledge and belief as of the date that it is provided. TI bases its knowledge and belief on information provided by third parties, and makes no representation or warranty as to the accuracy of such information. Efforts are underway to better integrate information from third parties. TI has taken and continues to take reasonable steps to provide representative and accurate information but may not have conducted destructive testing or chemical analysis on incoming materials and chemicals. TI and TI suppliers consider certain information to be proprietary, and thus CAS numbers and other limited information may not be available for release.

In no event shall TI's liability arising out of such information exceed the total purchase price of the TI part(s) at issue in this document sold by TI to Customer on an annual basis.

TRAY

Chamfer on Tray corner indicates Pin 1 orientation of packed units.

*All dimensions are nominal

Device	Package Name	Package Type	Pins	SPQ	Unit array matrix	Max temperature (°C)	L (mm)	W (mm)	K0 (µm)	P1 (mm)	CL (mm)	CW (mm)
LM140LAH-12/883	NDT	TO-CAN	3	20	2 X 10	150	126.49	61.98	8890	11.18	12.95	18.54
LM140LAH-15/883	NDT	TO-CAN	3	20	2 X 10	150	126.49	61.98	8890	11.18	12.95	18.54
LM140LAH5.0/883	NDT	TO-CAN	3	20	2 X 10	150	126.49	61.98	8890	11.18	12.95	18.54

NDT0003A

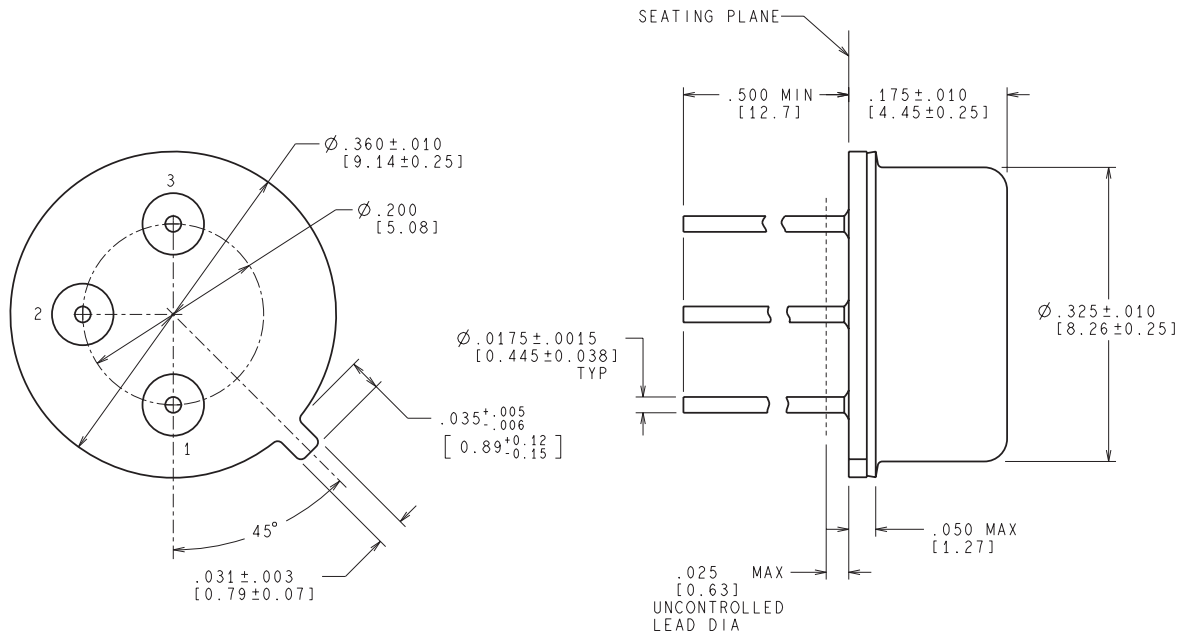

CONTROLLING DIMENSION IS INCH
VALUES IN [] ARE MILLIMETERS

MIL-PRF-38535
CONFIGURATION CONTROL

H03A (Rev D)

IMPORTANT NOTICE AND DISCLAIMER

TI PROVIDES TECHNICAL AND RELIABILITY DATA (INCLUDING DATA SHEETS), DESIGN RESOURCES (INCLUDING REFERENCE DESIGNS), APPLICATION OR OTHER DESIGN ADVICE, WEB TOOLS, SAFETY INFORMATION, AND OTHER RESOURCES "AS IS" AND WITH ALL FAULTS, AND DISCLAIMS ALL WARRANTIES, EXPRESS AND IMPLIED, INCLUDING WITHOUT LIMITATION ANY IMPLIED WARRANTIES OF MERCHANTABILITY, FITNESS FOR A PARTICULAR PURPOSE OR NON-INFRINGEMENT OF THIRD PARTY INTELLECTUAL PROPERTY RIGHTS.

These resources are intended for skilled developers designing with TI products. You are solely responsible for (1) selecting the appropriate TI products for your application, (2) designing, validating and testing your application, and (3) ensuring your application meets applicable standards, and any other safety, security, regulatory or other requirements.

These resources are subject to change without notice. TI grants you permission to use these resources only for development of an application that uses the TI products described in the resource. Other reproduction and display of these resources is prohibited. No license is granted to any other TI intellectual property right or to any third party intellectual property right. TI disclaims responsibility for, and you will fully indemnify TI and its representatives against, any claims, damages, costs, losses, and liabilities arising out of your use of these resources.

TI's products are provided subject to [TI's Terms of Sale](#) or other applicable terms available either on [ti.com](https://www.ti.com) or provided in conjunction with such TI products. TI's provision of these resources does not expand or otherwise alter TI's applicable warranties or warranty disclaimers for TI products.

TI objects to and rejects any additional or different terms you may have proposed.

Mailing Address: Texas Instruments, Post Office Box 655303, Dallas, Texas 75265

Copyright © 2025, Texas Instruments Incorporated