

LM2903-Q1 and LM2903B-Q1 Automotive Dual Comparators

Features

- Qualified for automotive applications
- AEC-Q100 qualified with the following results:
 - Device temperature grade 0: –40°C to 150°C ambient operating temperature range (LM2903E-Q1)
 - Device temperature grade 1: –40°C to 125°C ambient operating temperature range
 - Device HBM ESD classification level H1C
 - Device CDM ESD classification level C4B
- Improved 2 kV HBM ESD for "B" device
- Tri-Temp testing available for "B" device
- Single supply or dual supplies
- Low supply-current independent of supply voltage 200 μ A typical per comparator ("B" Versions)
- Low input bias current 3.5 nA typical ("B" device)
- Low input offset current 0.5 nA typ ("B" device)
- Low input offset voltage ± 0.37 mV typ ("B" device)
- Common-mode input voltage range includes ground
- Differential input voltage range equal to maximum-rated supply voltage ± 36 V
- Output compatible with TTL, MOS, and CMOS
- **Functional Safety-Capable**
 - [Documentation available to aid functional safety system design](#)

Applications

- **Automotive**
 - [HEV/EV and power train](#)
 - [Infotainment and cluster](#)
 - [Body control module](#)
- **Industrial**
- **Appliances**

Description

The LM2903B-Q1 device is the next generation version of the industry-standard LM2903-Q1 comparator family. This next generation family provides outstanding value for cost-sensitive applications, with features including lower offset voltage, higher supply voltage capability, lower supply current, lower input bias current, lower propagation delay, and improved 2kV ESD performance with drop-in replacement convenience.

All devices consist of two independent voltage comparators that are designed to operate over a wide range of voltages. Operation from dual supplies also is possible as long as the difference between the two supplies is within 2 V to 36 V, and VCC is at least 1.5 V more positive than the input common-mode voltage. The outputs can be connected to other open-collector outputs.

The LM2903-Q1 and LM2903B-Q1 are qualified for the AEC-Q100 Grade 1 temperature range of –40°C to +125°C. The LM2903E-Q1 is Qualified for the Grade 0 extended temperature range of –40°C to +150°C.

Device Information

| PART NUMBER | PACKAGE ⁽¹⁾ | BODY SIZE (NOM) |
|-------------|------------------------|-------------------|
| LM2903B-Q1 | SOIC (8) | 4.90 mm × 3.91 mm |
| | TSSOP (8) | 3.00 mm × 4.40 mm |
| | VSSOP(8) | 3.00 mm × 3.00 mm |
| | WSON (8) | 2.00 mm × 2.00 mm |
| | SOT-23 (8) | 1.60 mm × 2.90 mm |
| LM2903-Q1 | SOIC (8) | 4.90 mm × 3.91 mm |
| | TSSOP (8) | 3.00 mm × 4.40 mm |
| | VSSOP(8) | 3.00 mm × 3.00 mm |
| LM2903E-Q1 | TSSOP (8) | 3.00 mm × 4.40 mm |

(1) For all available packages, see the orderable addendum at the end of the datasheet.

Family Comparison Table

| Specification | LM2903B-Q1 | LM2903-Q1 | LM2903-Q1 "A" Devices | LM2903-Q1 "AV" Devices | LM2903E-Q1 | Units |
|--|------------|------------|-----------------------|------------------------|------------|-----------|
| Specified Supply Voltage | 2 to 36 | 2 to 30 | 2 to 30 | 2 to 32 | 2 to 30 | V |
| Total Supply Current (5 V to V _S max) | 0.6 to 0.8 | 1 to 2.5 | 1 to 2.5 | 1 to 2.5 | 1 to 2.5 | mA |
| Temperature Range | –40 to 125 | –40 to 125 | –40 to 125 | –40 to 125 | –40 to 150 | °C |
| ESD (HBM / CDM) | 2k / 1k | 1k / 750 | 1k / 750 | 1k / 750 | 1k / 750 | V |
| Offset Voltage (max over temp) | ± 4 | ± 15 | ± 4 | ± 4 | ± 15 | mV |
| Input Bias Current (typ / max) | 3.5 / 25 | 25 / 250 | 25 / 250 | 25 / 250 | 25 / 250 | nA |
| Response Time (typ) | 1 | 1.3 | 1.3 | 1.3 | 1.3 | μ sec |



Table of Contents

| | | | |
|--|---|--|----|
| Features | 1 | 3.14 Switching Characteristics, LM2903-Q1 and LM2903E-Q1..... | 8 |
| Applications | 1 | 3.15 Typical Characteristics, LM2903-Q1 and LM2903E-Q1 Only..... | 9 |
| Description | 1 | 3.16 Typical Characteristics, LM2903B-Q1 Only..... | 10 |
| 1 Revision History | 2 | 4 Detailed Description | 16 |
| 2 Pin Configuration and Functions | 4 | 4.1 Overview..... | 16 |
| 2.1 Pin Functions..... | 4 | 4.2 Functional Block Diagram..... | 16 |
| 3 Specifications | 5 | 4.3 Feature Description..... | 16 |
| 3.1 Absolute Maximum Ratings, LM2903-Q1 and LM2903E-Q1..... | 5 | 4.4 Device Functional Modes..... | 16 |
| 3.2 Absolute Maximum Ratings, LM2903B-Q1..... | 5 | 5 Application and Implementation | 17 |
| 3.3 ESD Ratings, LM2903-Q1 and LM2903E-Q1..... | 5 | 5.1 Application Information..... | 17 |
| 3.4 ESD Ratings, LM2903B-Q1..... | 5 | 5.2 Typical Application..... | 17 |
| 3.5 Recommended Operating Conditions, LM2903B-Q1..... | 6 | 5.3 Power Supply Recommendations..... | 19 |
| 3.6 Recommended Operating Conditions, LM2903-Q1..... | 6 | 5.4 Layout..... | 19 |
| 3.7 Recommended Operating Conditions, LM2903E-Q1..... | 6 | 6 Device and Documentation Support | 20 |
| 3.8 Thermal Information, LM2903-Q1 and LM2903E-Q1..... | 6 | 6.1 Documentation Support..... | 20 |
| 3.9 Thermal Information, LM2903B-Q1..... | 6 | 6.2 Receiving Notification of Documentation Updates..... | 20 |
| 3.10 Electrical Characteristics LM2903B - Q1..... | 7 | 6.3 Support Resources..... | 20 |
| 3.11 Switching Characteristics LM2903B - Q1..... | 7 | 6.4 Trademarks..... | 20 |
| 3.12 LM2903B-Q1 "T", "R" and "H" Temperature Test Options..... | 7 | 6.5 Electrostatic Discharge Caution..... | 20 |
| 3.13 Electrical Characteristics, LM2903-Q1 and LM2903E-Q1..... | 8 | 6.6 Glossary..... | 20 |
| | | 7 Mechanical, Packaging, and Orderable Information | 21 |

1 Revision History

NOTE: Page numbers for previous revisions may differ from page numbers in the current version.

| Changes from Revision K (August 2022) to Revision L (August 2023) | Page |
|---|--------------------|
| • Added reference to Application Note..... | 17 |
| Changes from Revision J (November 2020) to Revision K (August 2022) | Page |
| • Added T, R and H Temp Test Options table..... | 7 |
| Changes from Revision I (June 2020) to Revision J (November 2020) | Page |
| • Changed LM2903B-Q1 Minimum Recommended Supply Voltage to 2V throughout the datasheet..... | 1 |
| • Added Operating Virtual Temp to Abs Max Table for both versions..... | 5 |
| • Updated Supply Voltage vs Supply Current graph for 2V..... | 5 |
| Changes from Revision H (January 2020) to Revision I (June 2020) | Page |
| • Added Functional Safety text and links..... | 1 |
| • Added VSSOP package to Device Info list for "B"..... | 1 |
| • Added DGK to "B" Thermal Table..... | 6 |
| • Added text to Apps Overview section for ESD..... | 16 |
| Changes from Revision G (November 2018) to Revision H (January 2020) | Page |
| • Added LM2903B-Q1 to datasheet..... | 1 |
| • Added Device Information table. | 1 |
| • Added "B" device graphs | 10 |
| • Changed incorrect input text in Feature Description in Apps Section..... | 16 |
| Changes from Revision F (May 2018) to Revision G (November 2018) | Page |
| • Changed previous Q1 graphs to match new format | 9 |
| • Added LM2903E-Q1 specific graphs..... | 9 |

2 Pin Configuration and Functions

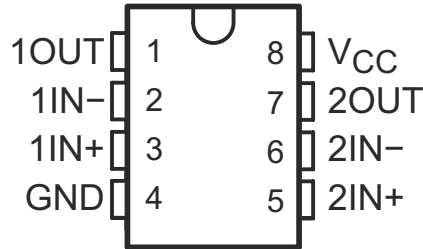

**Figure 2-1. D, DGK, DDF OR PW PACKAGE
Top View**

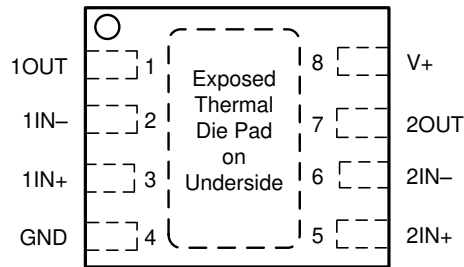

Connect thermal pad directly to GND pin.

**Figure 2-2. DSG Package
8-Pin WSON With Exposed Pad
Top View**

2.1 Pin Functions

| NAME | PIN | | I/O | DESCRIPTION |
|-----------------|--------------------------------------|-----|--------|------------------------------------|
| | SOIC, VSSOP, PDIP, SO, DDF and TSSOP | DSG | | |
| 1OUT | 1 | 1 | Output | Output pin of comparator 1 |
| 1IN- | 2 | 2 | Input | Negative input pin of comparator 1 |
| 1IN+ | 3 | 3 | Input | Positive input pin of comparator 1 |
| GND | 4 | 4 | — | Ground |
| 2IN+ | 5 | 5 | Input | Positive input pin of comparator 2 |
| 2IN- | 6 | 6 | Input | Negative input pin of comparator 2 |
| 2OUT | 7 | 7 | Output | Output pin of comparator 2 |
| V _{CC} | 8 | 8 | — | Positive Supply |
| Thermal Pad | — | PAD | — | Connect directly to GND pin |

3 Specifications

3.1 Absolute Maximum Ratings, LM2903-Q1 and LM2903E-Q1

over operating free-air temperature range (unless otherwise noted) ⁽¹⁾

| | | MIN | MAX | UNIT |
|------------------|--|------|-----------|------|
| V _{CC} | Supply voltage ⁽²⁾ | | 36 | V |
| V _{CC} | Supply voltage, LM2903E-Q1 Only ⁽²⁾ | | 32 | V |
| V _{ID} | Differential input voltage ⁽³⁾ | -36 | 36 | V |
| V _I | Input voltage range (either input) | -0.3 | 36 | V |
| V _O | Output voltage | | 36 | V |
| I _O | Output current | | 20 | mA |
| T _J | Operating virtual-junction temperature | | 150 | °C |
| T _{SCG} | Duration of output short-circuit to ground | | Unlimited | s |

(1) Stresses beyond those listed under *Absolute Maximum Ratings* may cause permanent damage to the device. These are stress ratings only, and functional operation of the device at these or any other conditions beyond those indicated under *Recommended Operating Conditions* is not implied. Exposure to absolute-maximum-rated conditions for extended periods may affect device reliability.

(2) All voltage values, except differential voltages, are with respect to GND.

(3) Differential voltages are at IN+ with respect to IN-.

3.2 Absolute Maximum Ratings, LM2903B-Q1

over operating free-air temperature range (unless otherwise noted)⁽¹⁾

| | | MIN | MAX | UNIT |
|---|--|------|-----------|------|
| Supply voltage: V _S = (V+) – (V-) | | -0.3 | 38 | V |
| Differential input voltage : V _{ID} ⁽²⁾ | | | ±38 | V |
| Input pins (IN+, IN-) | | -0.3 | 38 | V |
| Current into input pins (IN+, IN-) | | | -50 | mA |
| Output pin (OUT) | | -0.3 | 38 | V |
| Output sink current | | | 25 | mA |
| Operating virtual-junction temperature | | | 150 | °C |
| Output short-circuit duration ⁽³⁾ | | | Unlimited | s |

(1) Stresses beyond those listed under *Absolute Maximum Ratings* may cause permanent damage to the device. These are stress ratings only, which do not imply functional operation of the device at these or any other conditions beyond those indicated under *Recommended Operating Conditions*. Exposure to absolute-maximum-rated conditions for extended periods may affect device reliability.

(2) Differential voltages are at IN+ with respect to IN-

(3) Short circuits from outputs to V+ can cause excessive heating and eventual destruction.

3.3 ESD Ratings, LM2903-Q1 and LM2903E-Q1

| | | | MIN | MAX | UNIT |
|--------------------|---------------------------|---|-------|------|------|
| T _{stg} | Storage temperature range | LM2903-Q1 Only | -65 | 150 | °C |
| V _(ESD) | Electrostatic discharge | Human body model (HBM), per AEC Q100-002 ⁽¹⁾ | -1000 | 1000 | V |
| | | Charged device model (CDM), per AEC Q100-011 | -750 | 750 | |

(1) AEC Q100-002 indicates HBM stressing is done in accordance with the ANSI/ESDA/JEDEC JS-001 specification.

3.4 ESD Ratings, LM2903B-Q1

| | | | MIN | MAX | UNIT |
|--------------------|---------------------------|---|-------|------|------|
| T _{stg} | Storage temperature range | | -65 | 150 | °C |
| V _(ESD) | Electrostatic discharge | Human body model (HBM), per AEC Q100-002 ⁽¹⁾ | -2000 | 2000 | V |
| | | Charged device model (CDM), per AEC Q100-011 | -1000 | 1000 | |

(1) AEC Q100-002 indicates HBM stressing is done in accordance with the ANSI/ESDA/JEDEC JS-001 specification.

3.5 Recommended Operating Conditions, LM2903B-Q1

over operating free-air temperature range (unless otherwise noted)

| | MIN | MAX | UNIT |
|--------------------------------------|------|----------|------|
| Supply voltage: $V_S = (V+) - (V-)$ | 2 | 36 | V |
| Ambient temperature, T_A , LM2903B | -40 | 125 | °C |
| Input voltage range, V_{IVR} | -0.1 | (V+) - 2 | V |

3.6 Recommended Operating Conditions, LM2903-Q1

over operating free-air temperature range (unless otherwise noted)

| | MIN | MAX | UNIT |
|--------------------------|----------------------|-----|------------|
| V_{CC} (non-V devices) | 2 | 30 | V |
| V_{CC} (V devices) | 2 | 32 | V |
| T_J | Junction Temperature | | -40 125 °C |

3.7 Recommended Operating Conditions, LM2903E-Q1

over operating free-air temperature range (unless otherwise noted)

| | MIN | MAX | UNIT |
|----------|----------------------|-----|------------|
| V_{CC} | 2 | 30 | V |
| T_J | Junction Temperature | | -40 150 °C |

3.8 Thermal Information, LM2903-Q1 and LM2903E-Q1

| THERMAL METRIC ⁽¹⁾ | LM2903E-Q1 | LM2903-Q1 | | | UNIT |
|--|------------|-------------|------------|----------|------|
| | PW (TSSOP) | DGK (VSSOP) | PW (TSSOP) | D (SOIC) | |
| | 8 PINS | 8 PINS | 8 PINS | 8 PINS | |
| $R_{\theta JA}$ Junction-to-ambient thermal resistance | 178.9 | 199.4 | 186.6 | 126.0 | °C/W |
| $R_{\theta JC(top)}$ Junction-to-case (top) thermal resistance | 70.7 | 120.8 | 79.6 | 74.2 | |
| $R_{\theta JB}$ Junction-to-board thermal resistance | 108.9 | 90.2 | 116.5 | 66.4 | |
| ψ_{JT} Junction-to-top characterization parameter | 11.9 | 21.5 | 17.7 | 25.4 | |
| ψ_{JB} Junction-to-board characterization parameter | 107.3 | 119.1 | 114.9 | 65.9 | |

(1) For more information about traditional and new thermal metrics, see the [Semiconductor and IC Package Thermal Metrics](#) application report.

3.9 Thermal Information, LM2903B-Q1

| THERMAL METRIC ⁽¹⁾ | LM2903B-Q1 | | | | | UNIT |
|---|------------|-------------|------------|------------|--------------|------|
| | D (SOIC) | DGK (VSSOP) | PW (TSSOP) | DSG (WSON) | DDF (SOT-23) | |
| | 8 PINS | 8 PINS | 8 PINS | 8 PINS | 8 PINS | |
| $R_{\theta JA}$ Junction-to-ambient thermal resistance | 148.5 | 193.7 | 200.6 | 96.9 | 197.9 | °C/W |
| $R_{\theta JC(top)}$ Junction-to-case (top) thermal resistance | 90.2 | 82.9 | 89.6 | 119.0 | 119.2 | |
| $R_{\theta JB}$ Junction-to-board thermal resistance | 91.8 | 115.5 | 131.3 | 63.1 | 115.4 | |
| ψ_{JT} Junction-to-top characterization parameter | 38.5 | 20.8 | 22.1 | 12.4 | 19.4 | |
| ψ_{JB} Junction-to-board characterization parameter | 91.1 | 113.9 | 129.6 | 63.0 | 113.7 | |
| $R_{\theta JC(bot)}$ Junction-to-case (bottom) thermal resistance | - | - | - | 38.7 | - | |

(1) For more information about traditional and new thermal metrics, see the [Semiconductor and IC Package Thermal Metrics](#) application report.

3.10 Electrical Characteristics LM2903B - Q1

$V_S = 5\text{ V}$, $V_{CM} = (V-)$; $T_A = 25^\circ\text{C}$ (unless otherwise noted).

| PARAMETER | | TEST CONDITIONS | MIN | TYP | MAX | UNIT |
|--------------|---|---|------|------------|------------|---------------|
| V_{IO} | Input offset voltage | $V_S = 5\text{ to }36\text{V}$ | -2.5 | ± 0.37 | 2.5 | mV |
| | | $V_S = 5\text{ to }36\text{V}$, $T_A = -40^\circ\text{C to }+125^\circ\text{C}$ | -4 | | 4 | mV |
| V_{IO} | Input offset voltage, DGK package only | $V_S = 5\text{ to }36\text{V}$ | -3.5 | ± 0.37 | 3.5 | mV |
| | | $V_S = 5\text{ to }36\text{V}$, $T_A = -40^\circ\text{C to }+125^\circ\text{C}$ | -5 | | 5 | mV |
| I_B | Input bias current | | | -3.5 | -25 | nA |
| | | $T_A = -40^\circ\text{C to }+125^\circ\text{C}$ | | | -50 | nA |
| I_{OS} | Input offset current | | -10 | ± 0.5 | 10 | nA |
| | | $T_A = -40^\circ\text{C to }+125^\circ\text{C}$ | -25 | | 25 | nA |
| V_{CM} | Common mode range ⁽¹⁾ | $V_S = 3\text{ to }36\text{V}$ | (V-) | | (V+) - 1.5 | V |
| | | $V_S = 3\text{ to }36\text{V}$, $T_A = -40^\circ\text{C to }+125^\circ\text{C}$ | (V-) | | (V+) - 2.0 | V |
| A_{VD} | Large signal differential voltage amplification | $V_S = 15\text{V}$, $V_O = 1.4\text{V to }11.4\text{V}$; $R_L \geq 15\text{k to } (V+)$ | 50 | 200 | | V/mV |
| V_{OL} | Low level output Voltage {swing from (V-)} | $I_{SINK} \leq 4\text{mA}$, $V_{ID} = -1\text{V}$ | | 110 | 400 | mV |
| | | $I_{SINK} \leq 4\text{mA}$, $V_{ID} = -1\text{V}$ $T_A = -40^\circ\text{C to }+125^\circ\text{C}$ | | | 550 | mV |
| I_{OH-LKG} | High-level output leakage current | (V+) = $V_O = 5\text{ V}$; $V_{ID} = 1\text{ V}$ | | 0.1 | 20 | nA |
| | | (V+) = $V_O = 36\text{V}$; $V_{ID} = 1\text{ V}$ | | 0.3 | 50 | nA |
| I_{OL} | Low level output current | $V_{OL} = 1.5\text{V}$; $V_{ID} = -1\text{V}$; $V_S = 5\text{V}$ | 6 | 21 | | mA |
| I_Q | Quiescent current (all comparators) | $V_S = 5\text{ V}$, no load | | 400 | 600 | μA |
| | | $V_S = 36\text{ V}$, no load, $T_A = -40^\circ\text{C to }+125^\circ\text{C}$ | | 550 | 800 | μA |

(1) The voltage at any input should not be allowed to go negative by more than 0.3 V. The upper end of the input voltage range is $V_{CC} - 1.5\text{ V}$ for one input, and the other input can exceed the V_{CC} level; the comparator provides a proper output state. Either or both inputs can go to 36 V without damage.

3.11 Switching Characteristics LM2903B - Q1

$V_S = 5\text{V}$, $V_O\text{ PULLUP} = 5\text{V}$, $V_{CM} = V_S/2$, $C_L = 15\text{pF}$, $R_L = 5.1\text{k Ohm}$, $T_A = 25^\circ\text{C}$ (unless otherwise noted).

| PARAMETER | | TEST CONDITIONS | MIN | TYP | MAX | UNIT |
|-----------------------|--|---|-----|------|-----|------|
| t_{response} | Propagation delay time, high-to-low; TTL input signal ⁽¹⁾ | TTL input with $V_{\text{ref}} = 1.4\text{V}$ | | 300 | | ns |
| t_{response} | Propagation delay time, high-to-low; Small scale input signal ⁽¹⁾ | Input overdrive = 5mV, Input step = 100mV | | 1000 | | ns |

(1) High-to-low and low-to-high refers to the transition at the input.

3.12 LM2903B-Q1 "T", "R" and "H" Temperature Test Options

The following table describes the production temperature testing for the LM2903B-Q1 "H", "R" and "T" options. Specifications are the same as the LM2903B-Q1 above.

| Test | LM2903B-Q1 | LM2903BR-Q1 | LM2903BH-Q1 | LM2903BT-Q1 |
|------------------|------------|-------------|-------------|-----------------|
| Probe (Wafer) | - | 25°C | 125°C | -40°C and 125°C |
| Final (Packaged) | 25°C | 25°C | 25°C | 25°C |

3.13 Electrical Characteristics, LM2903-Q1 and LM2903E-Q1

 at specified free-air temperature, $V_{CC} = 5\text{ V}$ (unless otherwise noted)

| PARAMETER | TEST CONDITIONS | | T_A (1) | MIN | TYP | MAX | UNIT | |
|--|--|------------------------|-----------------------------|-------------------|-----|------|---------------|----|
| V_{IO} Input offset voltage | $V_O = 1.4\text{ V}$, $V_{IC} = V_{IC(min)}$, $V_{CC} = 5\text{ V to MAX}^{(2)}$ | Non-A devices | 25°C | 2 | 7 | | mV | |
| | | | Full range | | | 15 | | |
| | | A-suffix devices | 25°C | | 1 | 2 | | |
| | | | Full range | | | | | 4 |
| I_{IO} Input offset current | $V_O = 1.4\text{ V}$ | | 25°C | | 5 | 50 | nA | |
| | | | Full range | | | 200 | | |
| I_{IB} Input bias current | $V_O = 1.4\text{ V}$ | | 25°C | | -25 | -250 | nA | |
| | | | Full range | | | -500 | | |
| V_{ICR} Common-mode input voltage range(3) | | | 25°C | 0 to $V_{CC}-1.5$ | | | V | |
| | | | Full range | 0 to $V_{CC}-2$ | | | | |
| A_{VD} Large-signal differential-voltage amplification | $V_{CC} = 15\text{ V}$, $V_O = 1.4\text{ V to }11.4\text{ V}$, $R_L \geq 15\text{ k}\Omega\text{ to }V_{CC}$ | | 25°C | 25 | 100 | | V/mV | |
| I_{OH} High-level output current | $V_{OH} = 5\text{ V}$ | $V_{ID} = 1\text{ V}$ | 25°C | | 0.1 | 50 | nA | |
| | $V_{OH} = V_{CC}\text{ MAX}^{(2)}$ | | Full range | | | 1 | μA | |
| V_{OL} Low-level output voltage | $I_{OL} = 4\text{ mA}$, | $V_{ID} = -1\text{ V}$ | 25°C | | 150 | 400 | mV | |
| | | | Full range | | | 700 | | |
| I_{OL} Low-level output current | $V_{OL} = 1.5\text{ V}$, | $V_{ID} = -1\text{ V}$ | 25°C | | 6 | | mA | |
| I_{CC} Supply current | $R_L = \infty$ | | $V_{CC} = 5\text{ V}$ | 25°C | | 0.8 | 1 | mA |
| | | | $V_{CC} = \text{MAX}^{(2)}$ | Full range | | | | |

(1) Full range (MIN or MAX) for LM2903-Q1 is -40°C to 125°C and -40°C to 150°C for the LM2903E-Q1. All characteristics are measured with zero common-mode input voltage, unless otherwise specified.

(2) $V_{CC}\text{ MAX} = 30\text{ V}$ for non-V devices and 32 V for V-suffix devices.

(3) The voltage at either input or common-mode should not be allowed to go negative by more than 0.3 V . The upper end of the common-mode voltage range is $V_{CC} + 1.5\text{ V}$ for the inverting input (-), and the non-inverting input (+) can exceed the V_{CC} level; the comparator provides a proper output state. Either or both inputs can go to 30 V (32 V for V-suffix devices) without damage.

3.14 Switching Characteristics, LM2903-Q1 and LM2903E-Q1

 $V_{CC} = 5\text{ V}$, $T_A = 25^\circ\text{C}$

| PARAMETER | TEST CONDITIONS | | TYP | UNIT |
|---------------|--|---------------------------------------|-----|---------------|
| Response time | R_L connected to 5 V through $5.1\text{ k}\Omega$, | 100-mV input step with 5-mV overdrive | 1.3 | μs |
| | $C_L = 15\text{ pF}^{(1)(2)}$ | TTL-level input step | 0.3 | |

(1) C_L includes probe and jig capacitance.

(2) The response time specified is the interval between the input step function and the instant when the output crosses 1.4 V .

3.15 Typical Characteristics, LM2903-Q1 and LM2903E-Q1 Only

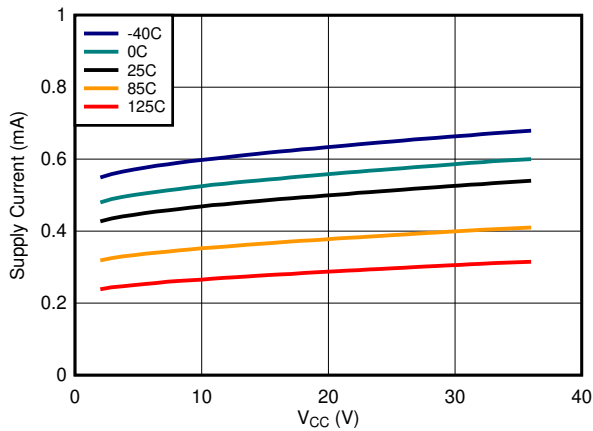

Figure 3-1. Supply Current vs. Supply Voltage

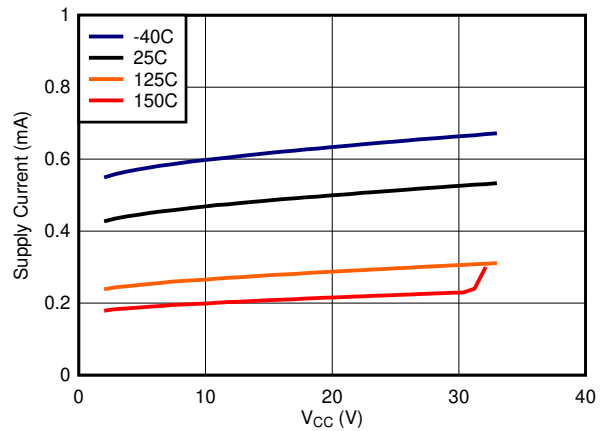

Figure 3-2. Supply Current vs. Supply Voltage LM2903E-Q1 Only

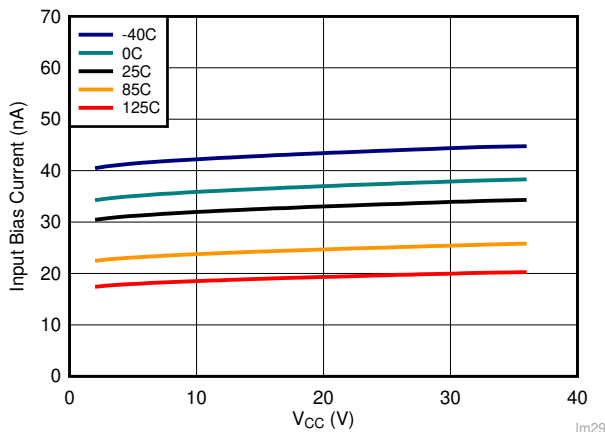

Figure 3-3. Input Bias Current vs. Supply Voltage

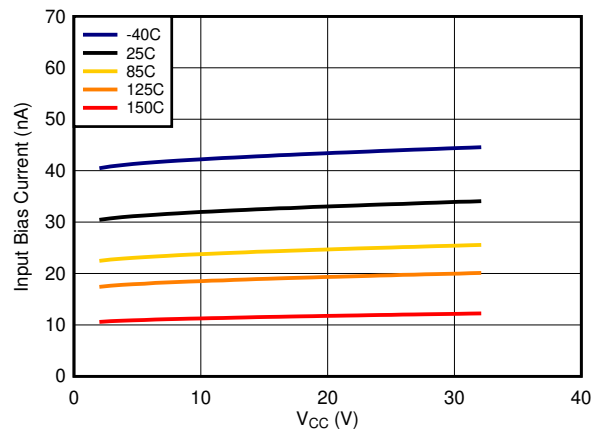

Figure 3-4. Input Bias Current vs. Supply Voltage LM2903E-Q1 Only

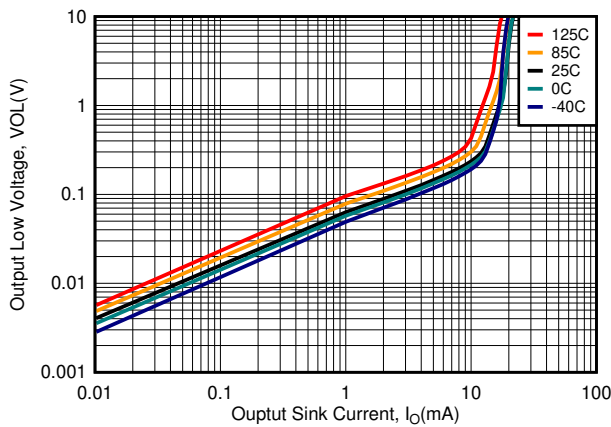

Figure 3-5. Output Low Voltage vs. Output Current

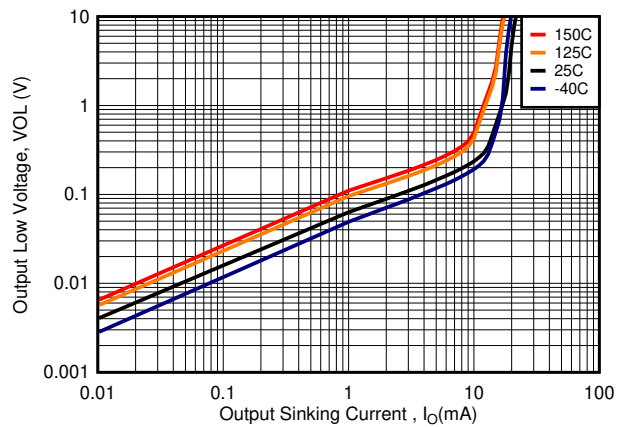

Figure 3-6. Output Low Voltage vs. Output Current LM2903E-Q1 Only

3.16 Typical Characteristics, LM2903B-Q1 Only

$T_A = 25^\circ\text{C}$, $V_S = 5\text{ V}$, $R_{\text{PULLUP}} = 5.1\text{ k}$, $C_L = 15\text{ pF}$, $V_{\text{CM}} = 0\text{ V}$, $V_{\text{UNDERDRIVE}} = 100\text{ mV}$, $V_{\text{OVERDRIVE}} = 100\text{ mV}$ unless otherwise noted.

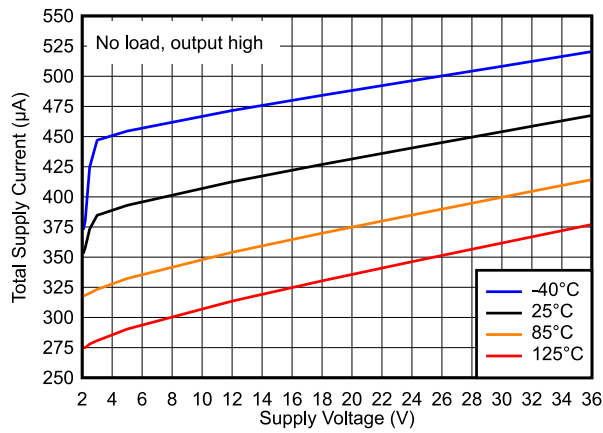

Figure 3-7. Total Supply Current vs. Supply Voltage

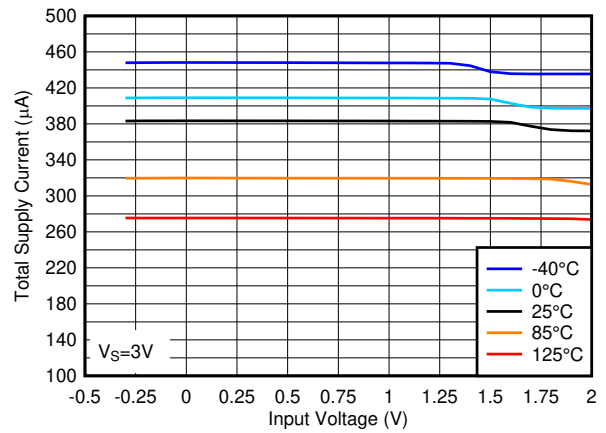

Figure 3-8. Total Supply Current vs. Input Voltage at 3V

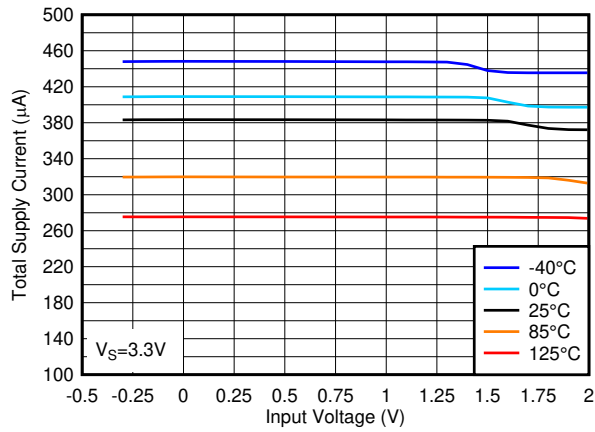

Figure 3-9. Total Supply Current vs. Input Voltage at 3.3V

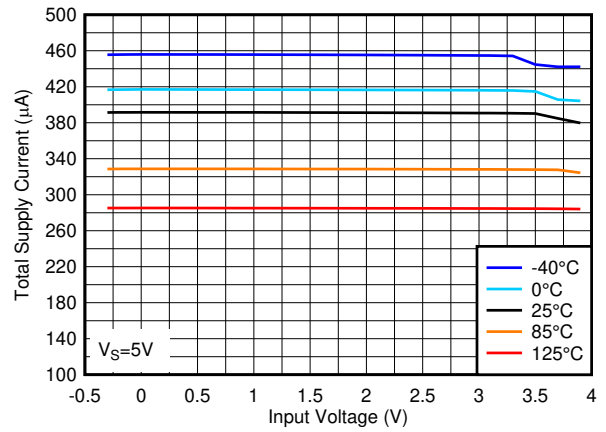

Figure 3-10. Total Supply Current vs. Input Voltage at 5V

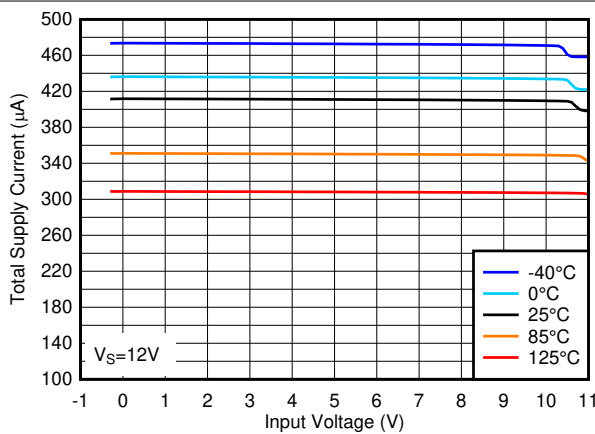

Figure 3-11. Total Supply Current vs. Input Voltage at 12V

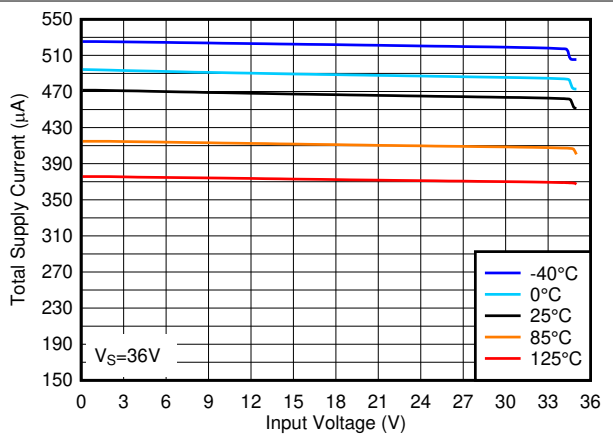

Figure 3-12. Total Supply Current vs. Input Voltage at 36V

3.16 Typical Characteristics, LM2903B-Q1 Only (continued)

$T_A = 25^\circ\text{C}$, $V_S = 5\text{ V}$, $R_{\text{PULLUP}} = 5.1\text{ k}$, $C_L = 15\text{ pF}$, $V_{\text{CM}} = 0\text{ V}$, $V_{\text{UNDERDRIVE}} = 100\text{ mV}$, $V_{\text{OVERDRIVE}} = 100\text{ mV}$ unless otherwise noted.

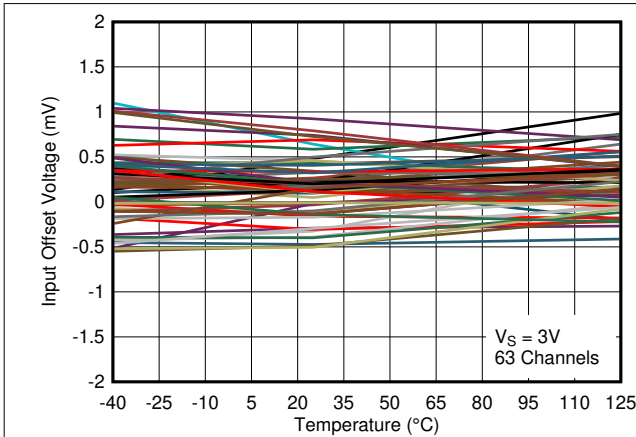

Figure 3-13. Input Offset Voltage vs. Temperature at 3V

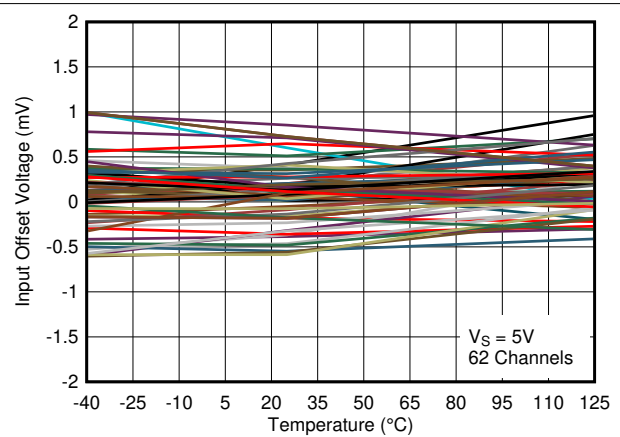

Figure 3-14. Input Offset Voltage vs. Temperature at 5V

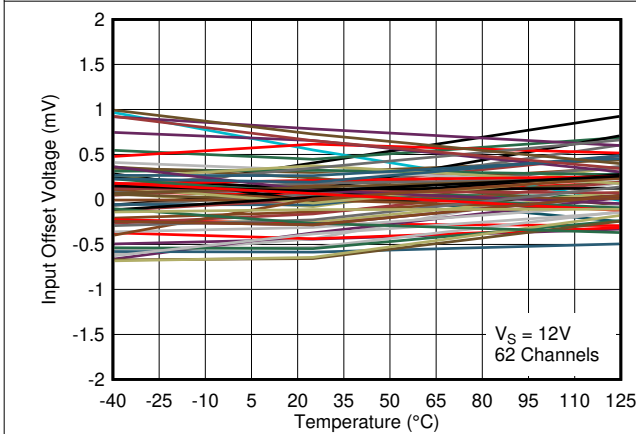

Figure 3-15. Input Offset Voltage vs. Temperature at 12V

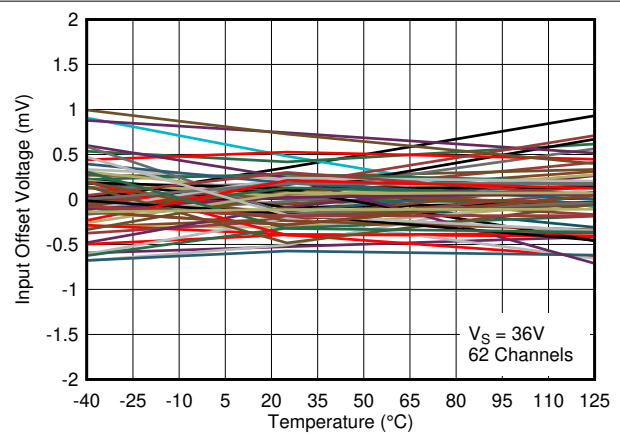

Figure 3-16. Input Offset Voltage vs. Temperature at 36V

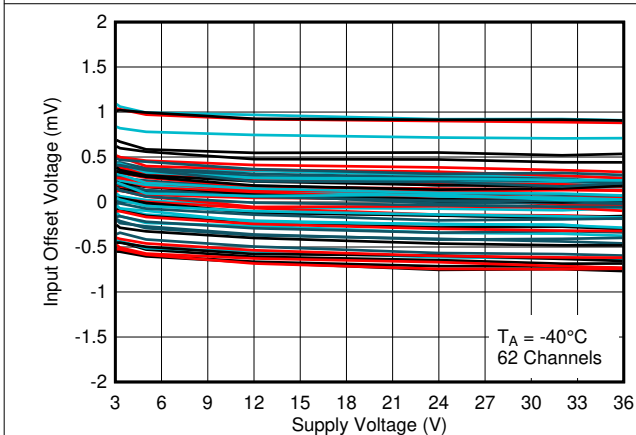

Figure 3-17. Input Offset Voltage vs. Supply Voltage at -40°C

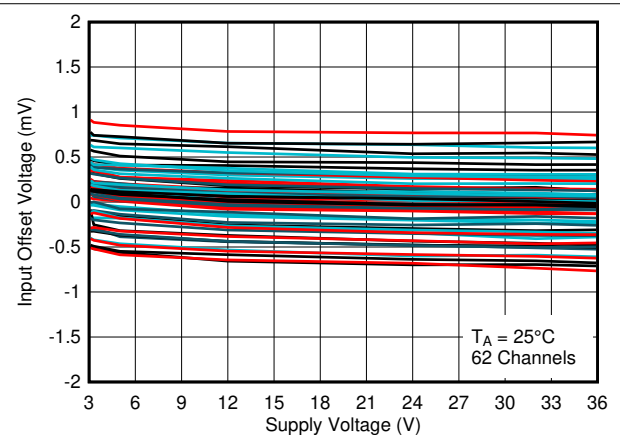

Figure 3-18. Input Offset Voltage vs. Supply Voltage at 25°C

3.16 Typical Characteristics, LM2903B-Q1 Only (continued)

$T_A = 25^\circ\text{C}$, $V_S = 5\text{ V}$, $R_{\text{PULLUP}} = 5.1\text{ k}$, $C_L = 15\text{ pF}$, $V_{\text{CM}} = 0\text{ V}$, $V_{\text{UNDERDRIVE}} = 100\text{ mV}$, $V_{\text{OVERDRIVE}} = 100\text{ mV}$ unless otherwise noted.

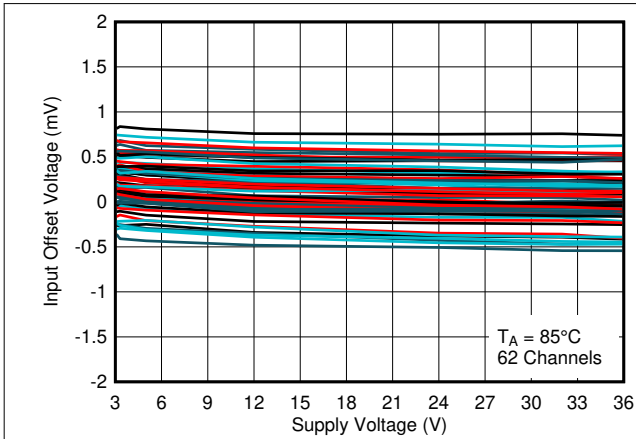

Figure 3-19. Input Offset Voltage vs. Supply Voltage at 85°C

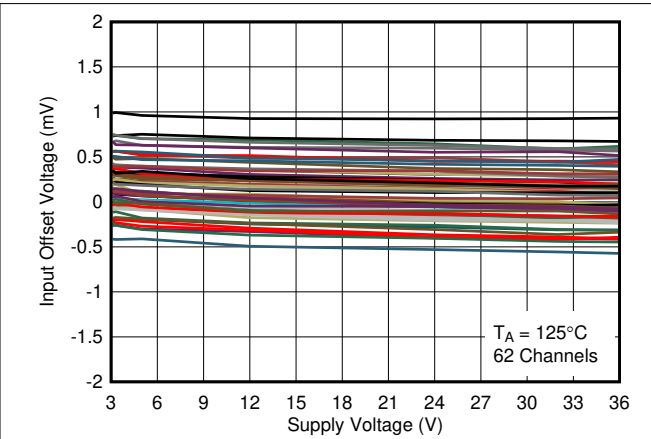

Figure 3-20. Input Offset Voltage vs. Supply Voltage at 125°C

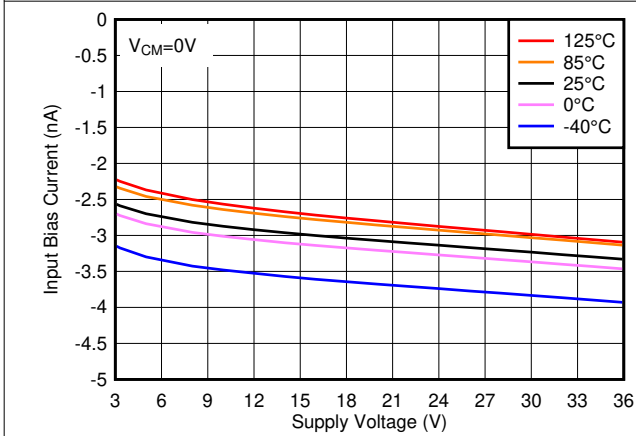

Figure 3-21. Input Bias Current vs. Supply Voltage

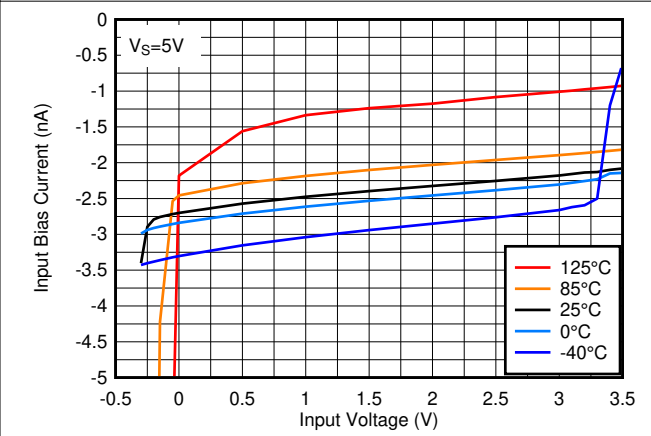

Figure 3-22. Input Bias Current vs. Input Voltage at 5V

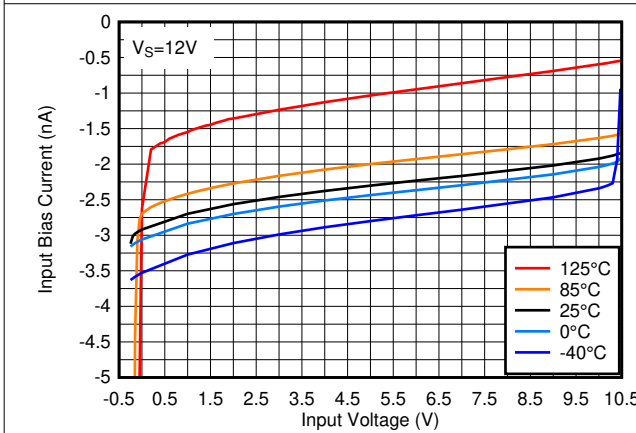

Figure 3-23. Input Bias Current vs. Input Voltage at 12V

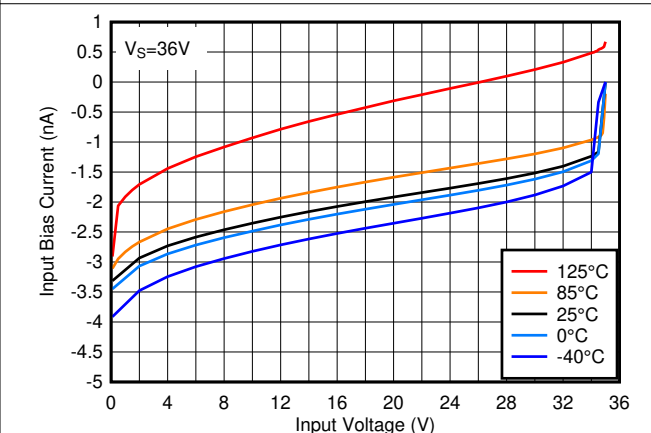
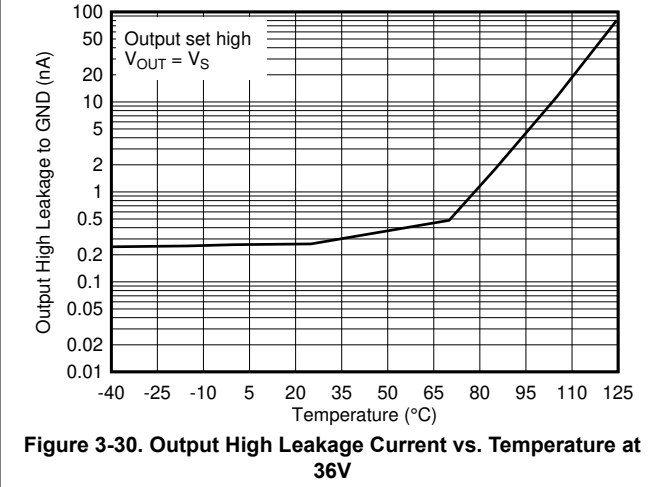
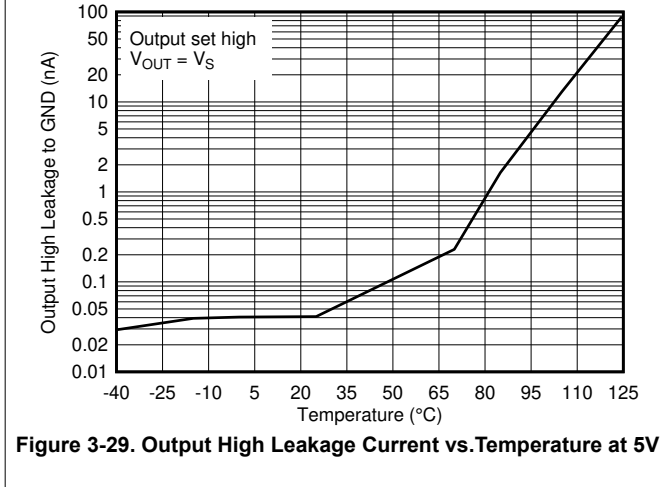
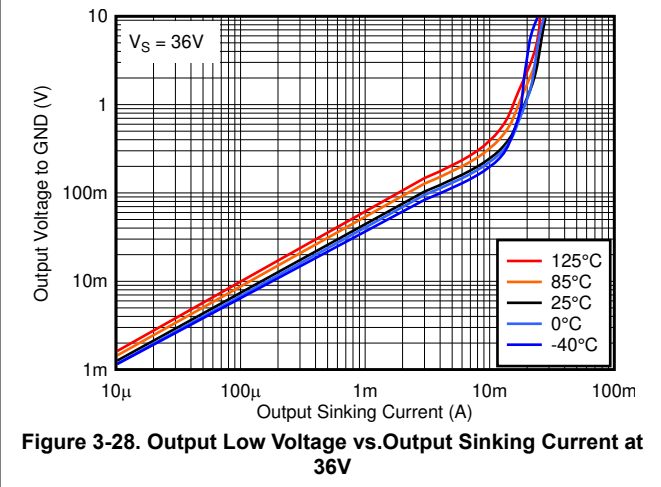
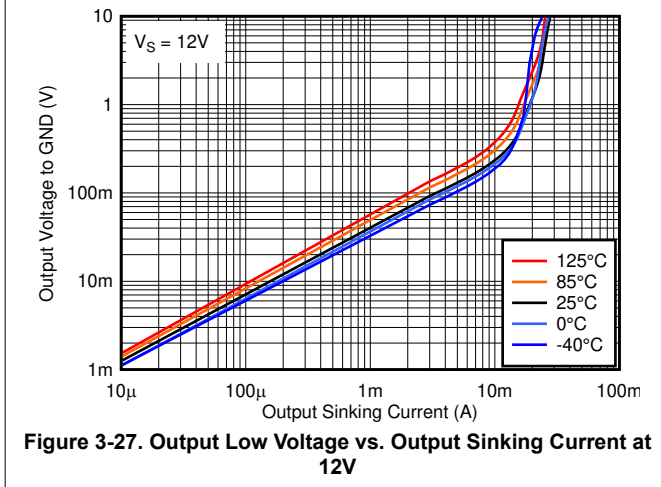
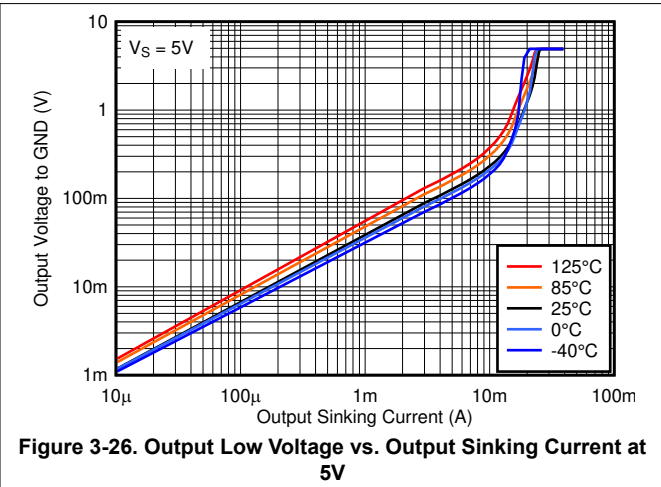
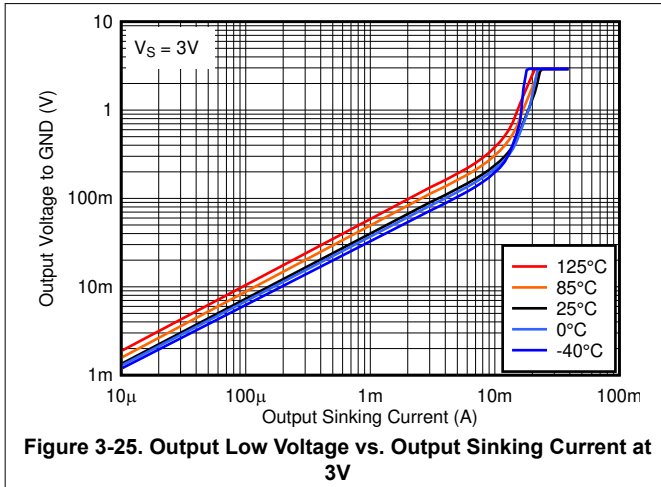

Figure 3-24. Input Bias Current vs. Input Voltage at 36V

3.16 Typical Characteristics, LM2903B-Q1 Only (continued)

$T_A = 25^\circ\text{C}$, $V_S = 5\text{ V}$, $R_{\text{PULLUP}} = 5.1\text{ k}$, $C_L = 15\text{ pF}$, $V_{\text{CM}} = 0\text{ V}$, $V_{\text{UNDERDRIVE}} = 100\text{ mV}$, $V_{\text{OVERDRIVE}} = 100\text{ mV}$ unless otherwise noted.



3.16 Typical Characteristics, LM2903B-Q1 Only (continued)

$T_A = 25^\circ\text{C}$, $V_S = 5\text{ V}$, $R_{\text{PULLUP}} = 5.1\text{ k}$, $C_L = 15\text{ pF}$, $V_{\text{CM}} = 0\text{ V}$, $V_{\text{UNDERDRIVE}} = 100\text{ mV}$, $V_{\text{OVERDRIVE}} = 100\text{ mV}$ unless otherwise noted.

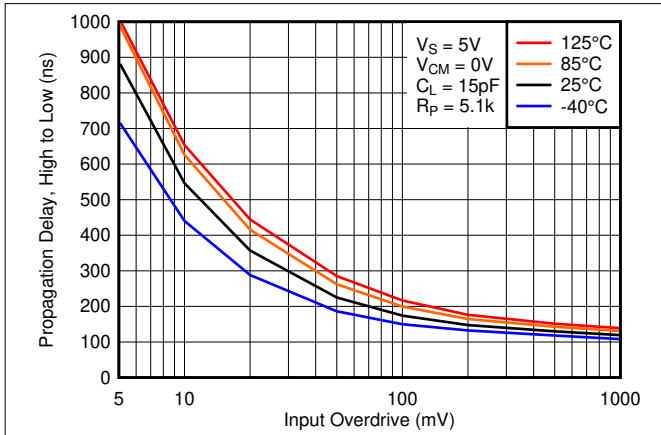

Figure 3-31. High to Low Propagation Delay vs. Input Overdrive Voltage, 5V

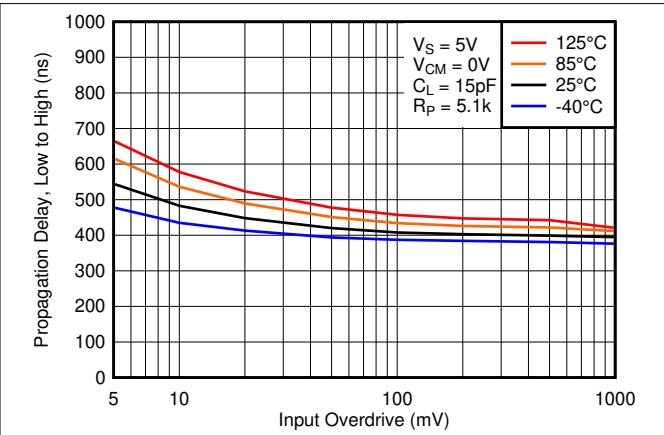

Figure 3-32. Low to High Propagation Delay vs. Input Overdrive Voltage, 5V

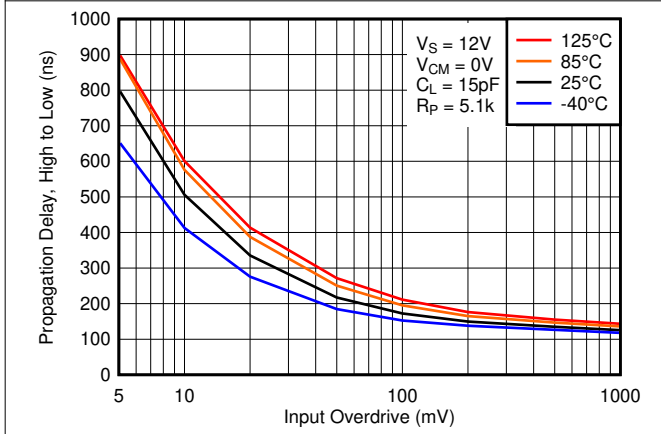

Figure 3-33. High to Low Propagation Delay vs. Input Overdrive Voltage, 12V

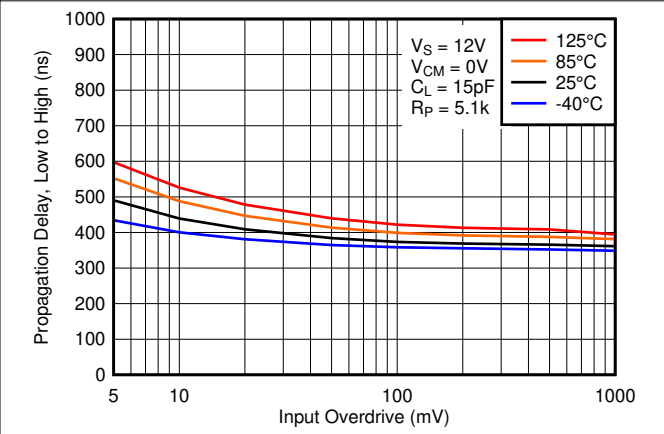

Figure 3-34. Low to High Propagation Delay vs. Input Overdrive Voltage, 12V

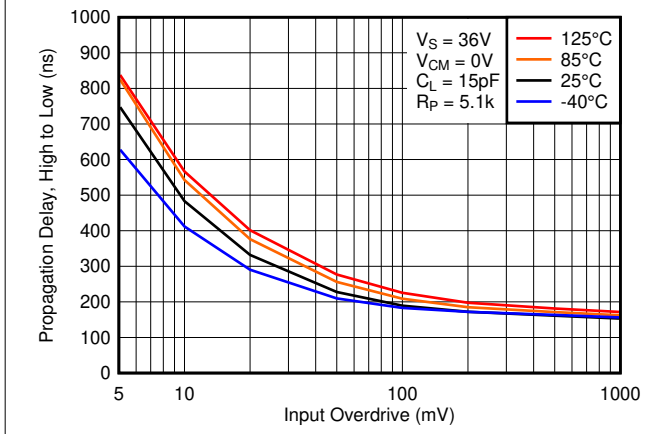

Figure 3-35. High to Low Propagation Delay vs. Input Overdrive Voltage, 36V

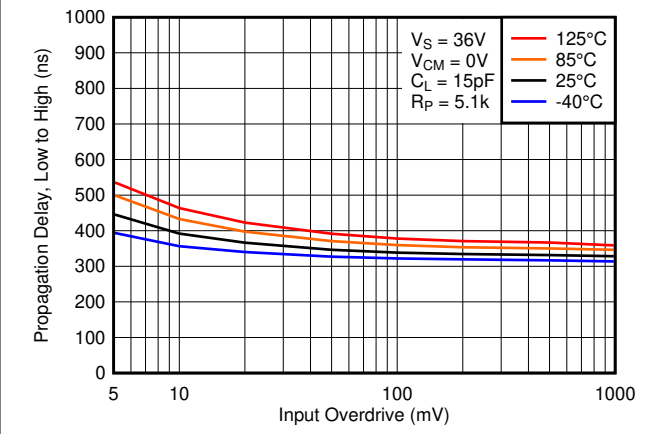
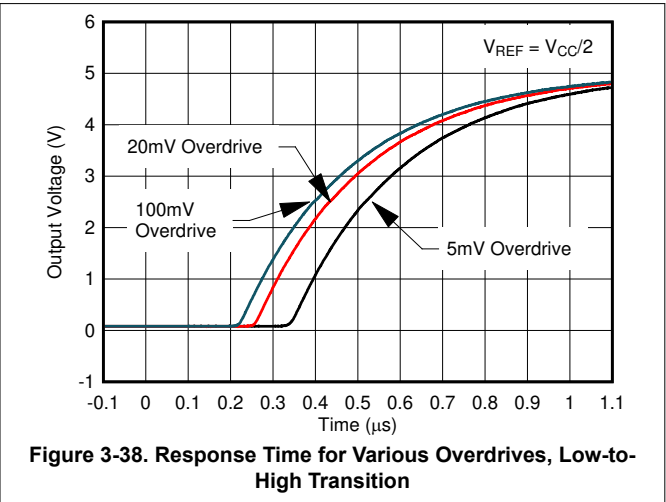
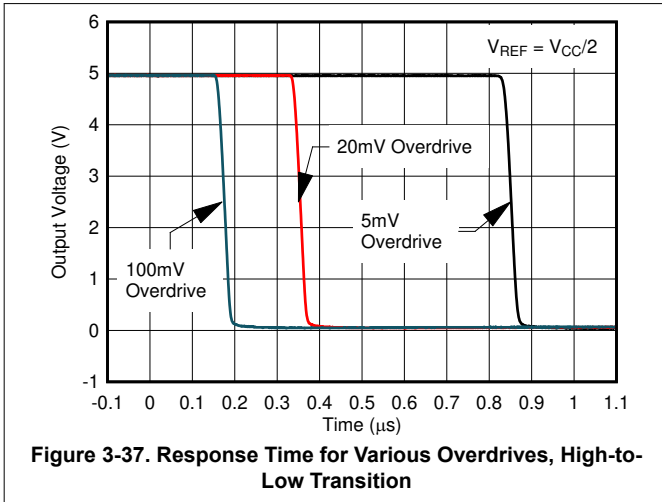

Figure 3-36. Low to High Propagation Delay vs. Input Overdrive Voltage, 36V

3.16 Typical Characteristics, LM2903B-Q1 Only (continued)

$T_A = 25^\circ\text{C}$, $V_S = 5\text{ V}$, $R_{\text{PULLUP}} = 5.1\text{ k}$, $C_L = 15\text{ pF}$, $V_{\text{CM}} = 0\text{ V}$, $V_{\text{UNDERDRIVE}} = 100\text{ mV}$, $V_{\text{OVERDRIVE}} = 100\text{ mV}$ unless otherwise noted.



4 Detailed Description

4.1 Overview

The LM2903-Q1 family is a dual comparator with the ability to operate up to 36 V on the supply pin. This standard device has proven ubiquity and versatility across a wide range of applications. This is due to its very wide supply voltages range (2 V to 36 V), low I_q and fast response.

This device is AEC-Q100 qualified and can operate over a wide temperature range of -40°C to 125°C (LM2903-Q1 and LM2903B-Q1) or -40°C to 150°C (LM2903E-Q1).

The open-drain output allows the user to configure the output's logic low voltage (V_{OL}) and can be utilized to enable the comparator to be used in AND functionality.

The "B" versions add dedicated ESD protections on all the pins for improved ESD performance as well as improved negative input voltage handling. Please see Application Note [SNOAA35](#) for more information

4.2 Functional Block Diagram

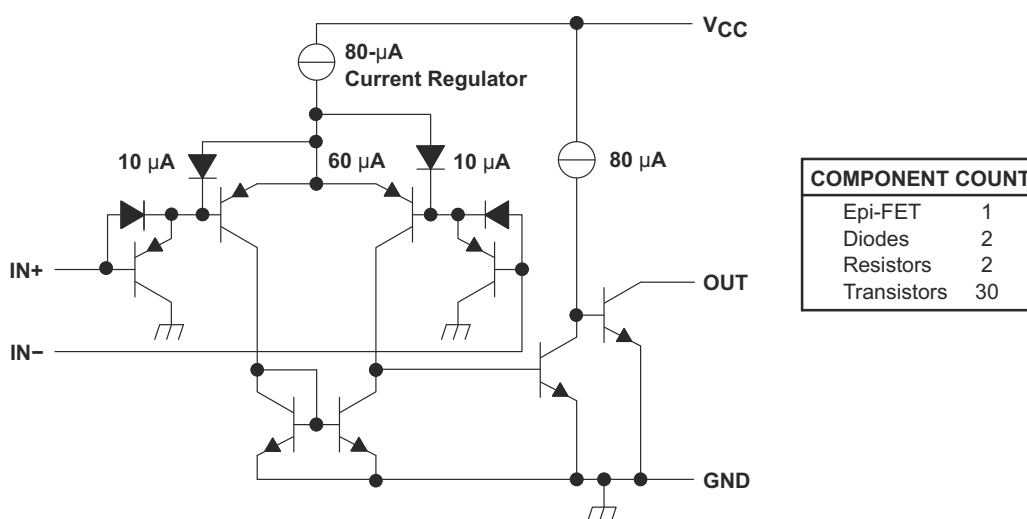

Figure 4-1. Schematic (Each Comparator)

4.3 Feature Description

LM2903-Q1 family consists of a PNP darlington pair input, allowing the device to operate with very high gain and fast response with minimal input bias current. The input Darlington pair creates a limit on the input common mode voltage capability, allowing LM2903-Q1 to accurately function from ground to $V_{CC}-1.5\text{V}$ differential input. This enables much head room for modern day supplies of 3.3 V and 5.0 V.

The output consists of an open drain NPN (pull-down or low side) transistor. The output NPN will sink current when the negative input voltage is higher than the positive input voltage and the offset voltage. The V_{OL} is resistive and will scale with the output current. Please see [Figure 3-3](#) in the [Section 3.15](#) section for V_{OL} values with respect to the output current.

4.4 Device Functional Modes

4.4.1 Voltage Comparison

The LM2903-Q1 family operates solely as a voltage comparator, comparing the differential voltage between the positive and negative pins and outputting a logic low or high impedance (logic high with pull-up) based on the input differential polarity.

5 Application and Implementation

Note

Information in the following applications sections is not part of the TI component specification, and TI does not warrant its accuracy or completeness. TI's customers are responsible for determining suitability of components for their purposes, as well as validating and testing their design implementation to confirm system functionality.

5.1 Application Information

LM2903-Q1 will typically be used to compare a single signal to a reference or two signals against each other. Many users take advantage of the open drain output to drive the comparison logic output to a logic voltage level to an MCU or logic device. The wide supply range and high voltage capability makes LM2903Q1 optimal for level shifting to a higher or lower voltage.

5.2 Typical Application

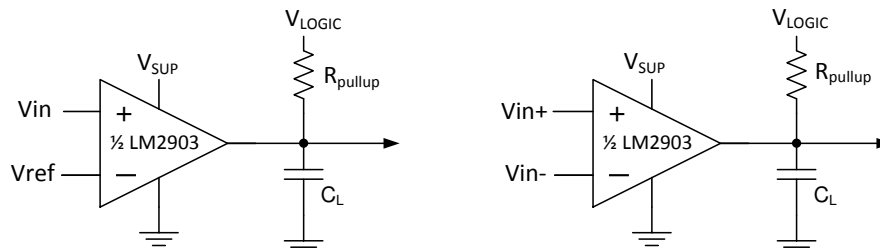

Figure 5-1. Single-ended and Differential Comparator Configurations

5.2.1 Design Requirements

For this design example, use the parameters listed in [Table 5-1](#) as the input parameters.

Table 5-1. Design Parameters

| DESIGN PARAMETER | EXAMPLE VALUE |
|---------------------------------------|--------------------|
| Input Voltage Range | 0 V to Vsup-1.5 V |
| Supply Voltage | 2 V to 36 V |
| Logic Supply Voltage | 2 V to 36 V |
| Output Current (R _{PULLUP}) | 1 μ A to 20 mA |
| Input Overdrive Voltage | 100 mV |
| Reference Voltage | 2.5 V |
| Load Capacitance (C _L) | 15 pF |

5.2.2 Detailed Design Procedure

When using LM2903-Q1 family in a general comparator application, determine the following:

- Input Voltage Range
- Minimum Overdrive Voltage
- Output and Drive Current
- Response Time

5.2.2.1 Input Voltage Range

When choosing the input voltage range, the input common mode voltage range (V_{ICR}) must be taken in to account. If temperature operation is above or below 25°C the V_{ICR} can range from 0 V to $V_{CC-} - 2.0$ V. This limits the input voltage range to as high as $V_{CC-} - 2.0$ V and as low as 0 V. Operation outside of this range can yield incorrect comparisons.

Below is a list of input voltage situation and their outcomes:

1. When both IN- and IN+ are both within the common mode range:
 - a. If IN- is higher than IN+ and the offset voltage, the output is low and the output transistor is sinking current
 - b. If IN- is lower than IN+ and the offset voltage, the output is high impedance and the output transistor is not conducting
2. When IN- is higher than common mode and IN+ is within common mode, the output is low and the output transistor is sinking current
3. When IN+ is higher than common mode and IN- is within common mode, the output is high impedance and the output transistor is not conducting
4. When IN- and IN+ are both higher than common mode, see Section 2 of [Application Design Guidelines for LM339, LM393, TL331 Family Comparators Including the New B-versions](#)

5.2.2.2 Minimum Overdrive Voltage

Overdrive Voltage is the differential voltage produced between the positive and negative inputs of the comparator over the offset voltage (V_{IO}). In order to make an accurate comparison the Overdrive Voltage (V_{OD}) should be higher than the input offset voltage (V_{IO}). Overdrive voltage can also determine the response time of the comparator, with the response time decreasing with increasing overdrive. [Figure 5-2](#) and [Figure 5-3](#) show positive and negative response times with respect to overdrive voltage.

5.2.2.3 Output and Drive Current

Output current is determined by the load/pull-up resistance and logic/pull-up voltage. The output current will produce a output low voltage (V_{OL}) from the comparator. In which V_{OL} is proportional to the output current. Use [Figure 3-5](#) to determine V_{OL} based on the output current.

The output current can also effect the transient response. More will be explained in the next section.

5.2.2.4 Response Time

The transient response can be determined by the load capacitance (C_L), load/pull-up resistance (R_{PULLUP}) and equivalent collector-emitter resistance (R_{CE}).

- The positive response time (T_P) is approximately $T_P \sim R_{PULLUP} \times C_L$
- The negative response time (T_N) is approximately $T_N \sim R_{CE} \times C_L$
 - R_{CE} can be determine by taking the slope of [Figure 3-5](#) in it's linear region at the desired temperature, or by dividing the V_{OL} by I_{out}

5.2.3 Application Curves

The following curves were generated with 5 V on V_{CC} and V_{Logic} , $R_{PULLUP} = 5.1 \text{ k}\Omega$, and 50 pF scope probe.

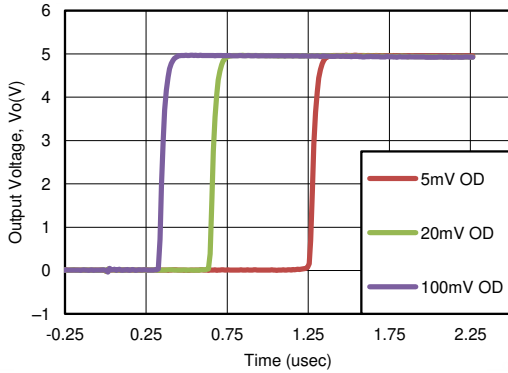

Figure 5-2. Response Time for Various Overdrives (Positive Transition)

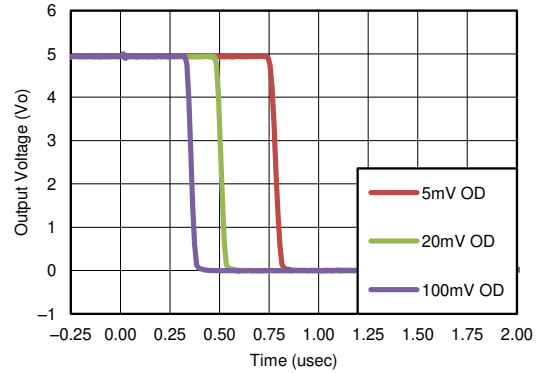

Figure 5-3. Response Time for Various Overdrives (Negative Transition)

5.3 Power Supply Recommendations

For fast response and comparison applications with noisy or AC inputs, it is recommended to use a bypass capacitor on the supply pin to reject any variation on the supply voltage. This variation can eat into the comparator's input common mode range and create an inaccurate comparison.

5.4 Layout

5.4.1 Layout Guidelines

For accurate comparator applications without hysteresis it is important maintain a stable power supply with minimized noise and glitches, which can affect the high level input common mode voltage range. In order to achieve this, it is best to add a bypass capacitor between the supply voltage and ground. This should be implemented on the positive power supply and negative supply (if available). If a negative supply is not being used, do not put a capacitor between the IC's GND pin and system ground.

5.4.2 Layout Example

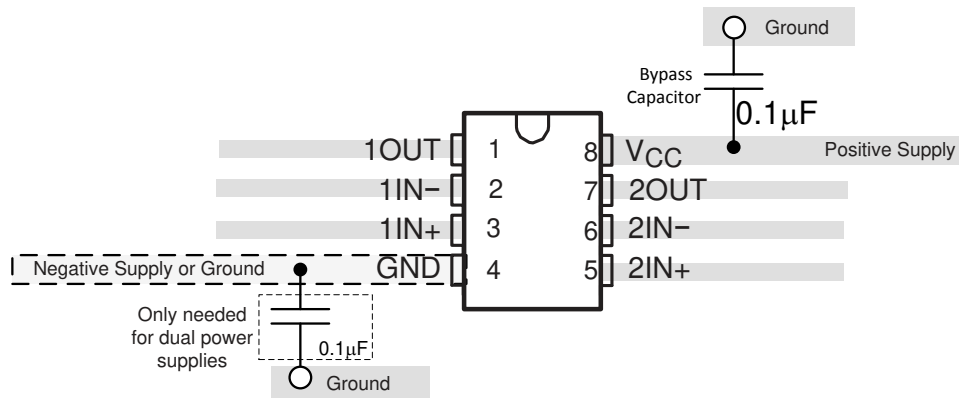

Figure 5-4. LM2903Q1 Layout Example

6 Device and Documentation Support

6.1 Documentation Support

6.1.1 Related Documentation

[LM2903B-Q1 Functional Safety FIT Rate, FMD and Pin FMA](#) - SLCA005

[Application Design Guidelines for LM339, LM393, TL331 Family Comparators](#) - SNOAA35

[Analog Engineers Circuit Cookbook: Amplifiers \(See Comparators section\)](#) - SLYY137

6.2 Receiving Notification of Documentation Updates

To receive notification of documentation updates, navigate to the device product folder on ti.com. In the upper right corner, click on *Alert me* to register and receive a weekly digest of any product information that has changed. For change details, review the revision history included in any revised document.

6.3 Support Resources

[TI E2E™ support forums](#) are an engineer's go-to source for fast, verified answers and design help — straight from the experts. Search existing answers or ask your own question to get the quick design help you need.

Linked content is provided "AS IS" by the respective contributors. They do not constitute TI specifications and do not necessarily reflect TI's views; see TI's [Terms of Use](#).

6.4 Trademarks

TI E2E™ is a trademark of Texas Instruments.

All trademarks are the property of their respective owners.

6.5 Electrostatic Discharge Caution



This integrated circuit can be damaged by ESD. Texas Instruments recommends that all integrated circuits be handled with appropriate precautions. Failure to observe proper handling and installation procedures can cause damage.

ESD damage can range from subtle performance degradation to complete device failure. Precision integrated circuits may be more susceptible to damage because very small parametric changes could cause the device not to meet its published specifications.

6.6 Glossary

[TI Glossary](#) This glossary lists and explains terms, acronyms, and definitions.

7 Mechanical, Packaging, and Orderable Information

The following pages include mechanical, packaging, and orderable information. This information is the most current data available for the designated devices. This data is subject to change without notice and revision of this document. For browser-based versions of this data sheet, refer to the left-hand navigation.

PACKAGING INFORMATION

| Orderable Device | Status (1) | Package Type | Package Drawing | Pins | Package Qty | Eco Plan (2) | Lead finish/ Ball material (6) | MSL Peak Temp (3) | Op Temp (°C) | Device Marking (4/5) | Samples |
|------------------|---------------|--------------|-----------------|------|-------------|-----------------|--------------------------------------|----------------------|--------------|-------------------------|-------------------------|
| LM2903AVQDRG4Q1 | ACTIVE | SOIC | D | 8 | 2500 | RoHS & Green | NIPDAU | Level-1-260C-UNLIM | -40 to 125 | 2903AVQ | Samples |
| LM2903AVQDRQ1 | ACTIVE | SOIC | D | 8 | 2500 | RoHS & Green | NIPDAU | Level-1-260C-UNLIM | -40 to 125 | 2903AVQ | Samples |
| LM2903AVQPWRG4Q1 | ACTIVE | TSSOP | PW | 8 | 2000 | RoHS & Green | NIPDAU | Level-1-260C-UNLIM | -40 to 125 | 2903AVQ | Samples |
| LM2903AVQPWRQ1 | ACTIVE | TSSOP | PW | 8 | 2000 | RoHS & Green | NIPDAU | Level-1-260C-UNLIM | -40 to 125 | 2903AVQ | Samples |
| LM2903BHQDGKRQ1 | ACTIVE | VSSOP | DGK | 8 | 2500 | RoHS & Green | NIPDAU | Level-1-260C-UNLIM | -40 to 125 | 3BHQ | Samples |
| LM2903BHQDRQ1 | ACTIVE | SOIC | D | 8 | 3000 | RoHS & Green | NIPDAU | Level-1-260C-UNLIM | -40 to 125 | 903BHQ | Samples |
| LM2903BHQPWRQ1 | ACTIVE | TSSOP | PW | 8 | 3000 | RoHS & Green | NIPDAU | Level-1-260C-UNLIM | -40 to 125 | 2903BH | Samples |
| LM2903BQDDFRQ1 | ACTIVE | SOT-23-THIN | DDF | 8 | 3000 | RoHS & Green | NIPDAU | Level-1-260C-UNLIM | -40 to 125 | 903BQ | Samples |
| LM2903BQDGKRQ1 | ACTIVE | VSSOP | DGK | 8 | 2500 | RoHS & Green | NIPDAU | Level-1-260C-UNLIM | -40 to 125 | 03BQ | Samples |
| LM2903BQDRQ1 | ACTIVE | SOIC | D | 8 | 2500 | RoHS & Green | NIPDAU | Level-1-260C-UNLIM | -40 to 125 | 2903BQ | Samples |
| LM2903BQPWRQ1 | ACTIVE | TSSOP | PW | 8 | 2000 | RoHS & Green | NIPDAU | Level-1-260C-UNLIM | -40 to 125 | 2903BQ | Samples |
| LM2903BRQDGKRQ1 | ACTIVE | VSSOP | DGK | 8 | 2500 | RoHS & Green | NIPDAU | Level-1-260C-UNLIM | -40 to 125 | 3BRQ | Samples |
| LM2903BRQDRQ1 | ACTIVE | SOIC | D | 8 | 3000 | RoHS & Green | NIPDAU | Level-1-260C-UNLIM | -40 to 125 | 903BRQ | Samples |
| LM2903BRQPWRQ1 | ACTIVE | TSSOP | PW | 8 | 3000 | RoHS & Green | NIPDAU | Level-1-260C-UNLIM | -40 to 125 | 2903BR | Samples |
| LM2903BTQDGKRQ1 | ACTIVE | VSSOP | DGK | 8 | 2500 | RoHS & Green | NIPDAU | Level-1-260C-UNLIM | -40 to 125 | 3BTQ | Samples |
| LM2903BTQDRQ1 | ACTIVE | SOIC | D | 8 | 3000 | RoHS & Green | NIPDAU | Level-1-260C-UNLIM | -40 to 125 | 903BTQ | Samples |
| LM2903BTQPWRQ1 | ACTIVE | TSSOP | PW | 8 | 3000 | RoHS & Green | NIPDAU | Level-1-260C-UNLIM | -40 to 125 | 2903BT | Samples |
| LM2903BWDSGRQ1 | ACTIVE | WSON | DSG | 8 | 3000 | RoHS & Green | Call TI SN | Level-2-260C-1 YEAR | -40 to 125 | 3BWQ | Samples |
| LM2903EPWRQ1 | ACTIVE | TSSOP | PW | 8 | 2000 | RoHS & Green | NIPDAU | Level-2-260C-1 YEAR | -40 to 150 | 2903Q0 | Samples |
| LM2903QDQDGKRQ1 | ACTIVE | VSSOP | DGK | 8 | 2500 | RoHS & Green | NIPDAUAG | Level-2-260C-1 YEAR | -40 to 125 | KACQ | Samples |

| Orderable Device | Status (1) | Package Type | Package Drawing | Pins | Package Qty | Eco Plan (2) | Lead finish/ Ball material (6) | MSL Peak Temp (3) | Op Temp (°C) | Device Marking (4/5) | Samples |
|------------------|---------------|--------------|-----------------|------|-------------|-----------------|--------------------------------------|----------------------|--------------|-------------------------|-------------------------|
| LM2903QDRG4Q1 | ACTIVE | SOIC | D | 8 | 2500 | RoHS & Green | NIPDAU | Level-1-260C-UNLIM | -40 to 125 | 2903Q1 | Samples |
| LM2903QDRQ1 | ACTIVE | SOIC | D | 8 | 2500 | RoHS & Green | NIPDAU | Level-1-260C-UNLIM | -40 to 125 | 2903Q1 | Samples |
| LM2903QPWRG4Q1 | ACTIVE | TSSOP | PW | 8 | 2000 | RoHS & Green | NIPDAU | Level-1-260C-UNLIM | -40 to 125 | 2903Q1 | Samples |
| LM2903QPWRQ1 | ACTIVE | TSSOP | PW | 8 | 2000 | RoHS & Green | NIPDAU | Level-1-260C-UNLIM | -40 to 125 | 2903Q1 | Samples |
| LM2903VQDRG4Q1 | LIFEBUY | SOIC | D | 8 | 2500 | RoHS & Green | NIPDAU | Level-1-260C-UNLIM | -40 to 125 | 2903VQ1 | |
| LM2903VQDRQ1 | ACTIVE | SOIC | D | 8 | 2500 | RoHS & Green | NIPDAU | Level-1-260C-UNLIM | -40 to 125 | 2903VQ1 | Samples |
| LM2903VQPWRG4Q1 | ACTIVE | TSSOP | PW | 8 | 2000 | RoHS & Green | NIPDAU | Level-1-260C-UNLIM | -40 to 125 | 2903VQ | Samples |
| LM2903VQPWRQ1 | ACTIVE | TSSOP | PW | 8 | 2000 | RoHS & Green | NIPDAU | Level-1-260C-UNLIM | -40 to 125 | 2903VQ | Samples |

(1) The marketing status values are defined as follows:

ACTIVE: Product device recommended for new designs.

LIFEBUY: TI has announced that the device will be discontinued, and a lifetime-buy period is in effect.

NRND: Not recommended for new designs. Device is in production to support existing customers, but TI does not recommend using this part in a new design.

PREVIEW: Device has been announced but is not in production. Samples may or may not be available.

OBSELETE: TI has discontinued the production of the device.

(2) **RoHS:** TI defines "RoHS" to mean semiconductor products that are compliant with the current EU RoHS requirements for all 10 RoHS substances, including the requirement that RoHS substance do not exceed 0.1% by weight in homogeneous materials. Where designed to be soldered at high temperatures, "RoHS" products are suitable for use in specified lead-free processes. TI may reference these types of products as "Pb-Free".

RoHS Exempt: TI defines "RoHS Exempt" to mean products that contain lead but are compliant with EU RoHS pursuant to a specific EU RoHS exemption.

Green: TI defines "Green" to mean the content of Chlorine (Cl) and Bromine (Br) based flame retardants meet JS709B low halogen requirements of <=1000ppm threshold. Antimony trioxide based flame retardants must also meet the <=1000ppm threshold requirement.

(3) MSL, Peak Temp. - The Moisture Sensitivity Level rating according to the JEDEC industry standard classifications, and peak solder temperature.

(4) There may be additional marking, which relates to the logo, the lot trace code information, or the environmental category on the device.

(5) Multiple Device Markings will be inside parentheses. Only one Device Marking contained in parentheses and separated by a "~" will appear on a device. If a line is indented then it is a continuation of the previous line and the two combined represent the entire Device Marking for that device.

⁽⁶⁾ Lead finish/Ball material - Orderable Devices may have multiple material finish options. Finish options are separated by a vertical ruled line. Lead finish/Ball material values may wrap to two lines if the finish value exceeds the maximum column width.

Important Information and Disclaimer:The information provided on this page represents TI's knowledge and belief as of the date that it is provided. TI bases its knowledge and belief on information provided by third parties, and makes no representation or warranty as to the accuracy of such information. Efforts are underway to better integrate information from third parties. TI has taken and continues to take reasonable steps to provide representative and accurate information but may not have conducted destructive testing or chemical analysis on incoming materials and chemicals. TI and TI suppliers consider certain information to be proprietary, and thus CAS numbers and other limited information may not be available for release.

In no event shall TI's liability arising out of such information exceed the total purchase price of the TI part(s) at issue in this document sold by TI to Customer on an annual basis.

OTHER QUALIFIED VERSIONS OF LM2903-Q1, LM2903B-Q1 :

- Catalog : [LM2903](#), [LM2903B](#)

NOTE: Qualified Version Definitions:

- Catalog - TI's standard catalog product

TAPE AND REEL INFORMATION

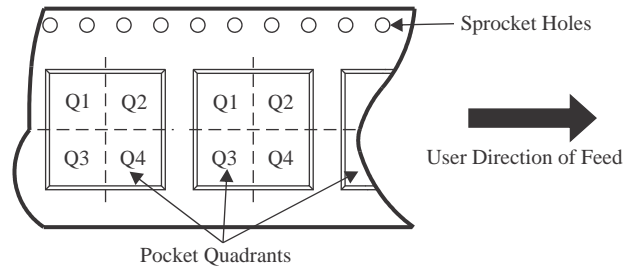
QUADRANT ASSIGNMENTS FOR PIN 1 ORIENTATION IN TAPE

*All dimensions are nominal

| Device | Package Type | Package Drawing | Pins | SPQ | Reel Diameter (mm) | Reel Width W1 (mm) | A0 (mm) | B0 (mm) | K0 (mm) | P1 (mm) | W (mm) | Pin1 Quadrant |
|------------------|--------------|-----------------|------|------|--------------------|--------------------|---------|---------|---------|---------|--------|---------------|
| LM2903AVQDRG4Q1 | SOIC | D | 8 | 2500 | 330.0 | 12.4 | 6.4 | 5.2 | 2.1 | 8.0 | 12.0 | Q1 |
| LM2903AVQDRQ1 | SOIC | D | 8 | 2500 | 330.0 | 12.4 | 6.4 | 5.2 | 2.1 | 8.0 | 12.0 | Q1 |
| LM2903AVQDRQ1 | SOIC | D | 8 | 2500 | 330.0 | 12.5 | 6.4 | 5.2 | 2.1 | 8.0 | 12.0 | Q1 |
| LM2903AVQPWRG4Q1 | TSSOP | PW | 8 | 2000 | 330.0 | 12.4 | 7.0 | 3.6 | 1.6 | 8.0 | 12.0 | Q1 |
| LM2903AVQPWRQ1 | TSSOP | PW | 8 | 2000 | 330.0 | 12.4 | 7.0 | 3.6 | 1.6 | 8.0 | 12.0 | Q1 |
| LM2903BHQDGRQ1 | VSSOP | DGK | 8 | 2500 | 330.0 | 12.4 | 5.3 | 3.4 | 1.4 | 8.0 | 12.0 | Q1 |
| LM2903BHQDRQ1 | SOIC | D | 8 | 3000 | 330.0 | 12.4 | 6.4 | 5.2 | 2.1 | 8.0 | 12.0 | Q1 |
| LM2903BHPWRQ1 | TSSOP | PW | 8 | 3000 | 330.0 | 12.4 | 7.0 | 3.6 | 1.6 | 8.0 | 12.0 | Q1 |
| LM2903BQDDFRQ1 | SOT-23-THIN | DDF | 8 | 3000 | 180.0 | 8.4 | 3.2 | 3.2 | 1.4 | 4.0 | 8.0 | Q3 |
| LM2903BQDGRQ1 | VSSOP | DGK | 8 | 2500 | 330.0 | 12.4 | 5.3 | 3.4 | 1.4 | 8.0 | 12.0 | Q1 |
| LM2903BQDRQ1 | SOIC | D | 8 | 2500 | 330.0 | 12.4 | 6.4 | 5.2 | 2.1 | 8.0 | 12.0 | Q1 |
| LM2903BQDRQ1 | SOIC | D | 8 | 2500 | 330.0 | 12.4 | 6.4 | 5.2 | 2.1 | 8.0 | 12.0 | Q1 |
| LM2903BQPWRQ1 | TSSOP | PW | 8 | 2000 | 330.0 | 12.4 | 7.0 | 3.6 | 1.6 | 8.0 | 12.0 | Q1 |
| LM2903BRQDGRQ1 | VSSOP | DGK | 8 | 2500 | 330.0 | 12.4 | 5.3 | 3.4 | 1.4 | 8.0 | 12.0 | Q1 |
| LM2903BRQDRQ1 | SOIC | D | 8 | 3000 | 330.0 | 12.4 | 6.4 | 5.2 | 2.1 | 8.0 | 12.0 | Q1 |

| Device | Package Type | Package Drawing | Pins | SPQ | Reel Diameter (mm) | Reel Width W1 (mm) | A0 (mm) | B0 (mm) | K0 (mm) | P1 (mm) | W (mm) | Pin1 Quadrant |
|-----------------|--------------|-----------------|------|------|--------------------|--------------------|---------|---------|---------|---------|--------|---------------|
| LM2903BRQPWRQ1 | TSSOP | PW | 8 | 3000 | 330.0 | 12.4 | 7.0 | 3.6 | 1.6 | 8.0 | 12.0 | Q1 |
| LM2903BTQDGKRQ1 | VSSOP | DGK | 8 | 2500 | 330.0 | 12.4 | 5.3 | 3.4 | 1.4 | 8.0 | 12.0 | Q1 |
| LM2903BTQDRQ1 | SOIC | D | 8 | 3000 | 330.0 | 12.4 | 6.4 | 5.2 | 2.1 | 8.0 | 12.0 | Q1 |
| LM2903BTQPWRQ1 | TSSOP | PW | 8 | 3000 | 330.0 | 12.4 | 7.0 | 3.6 | 1.6 | 8.0 | 12.0 | Q1 |
| LM2903BWDSGRQ1 | WSON | DSG | 8 | 3000 | 180.0 | 8.4 | 2.2 | 2.2 | 1.2 | 4.0 | 8.0 | Q2 |
| LM2903EPWRQ1 | TSSOP | PW | 8 | 2000 | 330.0 | 12.4 | 7.0 | 3.6 | 1.6 | 8.0 | 12.0 | Q1 |
| LM2903QDGKRQ1 | VSSOP | DGK | 8 | 2500 | 330.0 | 12.4 | 5.3 | 3.4 | 1.4 | 8.0 | 12.0 | Q1 |
| LM2903QDRG4Q1 | SOIC | D | 8 | 2500 | 330.0 | 12.4 | 6.4 | 5.2 | 2.1 | 8.0 | 12.0 | Q1 |
| LM2903QDRQ1 | SOIC | D | 8 | 2500 | 330.0 | 12.4 | 6.4 | 5.2 | 2.1 | 8.0 | 12.0 | Q1 |
| LM2903QPWRG4Q1 | TSSOP | PW | 8 | 2000 | 330.0 | 12.4 | 7.0 | 3.6 | 1.6 | 8.0 | 12.0 | Q1 |
| LM2903QPWRQ1 | TSSOP | PW | 8 | 2000 | 330.0 | 12.4 | 7.0 | 3.6 | 1.6 | 8.0 | 12.0 | Q1 |
| LM2903VQDRG4Q1 | SOIC | D | 8 | 2500 | 330.0 | 12.4 | 6.4 | 5.2 | 2.1 | 8.0 | 12.0 | Q1 |
| LM2903VQPWRG4Q1 | TSSOP | PW | 8 | 2000 | 330.0 | 12.4 | 7.0 | 3.6 | 1.6 | 8.0 | 12.0 | Q1 |
| LM2903VQPWRG4Q1 | TSSOP | PW | 8 | 2000 | 330.0 | 12.4 | 7.0 | 3.6 | 1.6 | 8.0 | 12.0 | Q1 |
| LM2903VQPWRQ1 | TSSOP | PW | 8 | 2000 | 330.0 | 12.4 | 7.0 | 3.6 | 1.6 | 8.0 | 12.0 | Q1 |
| LM2903VQPWRQ1 | TSSOP | PW | 8 | 2000 | 330.0 | 12.4 | 7.0 | 3.6 | 1.6 | 8.0 | 12.0 | Q1 |

TAPE AND REEL BOX DIMENSIONS

*All dimensions are nominal

| Device | Package Type | Package Drawing | Pins | SPQ | Length (mm) | Width (mm) | Height (mm) |
|------------------|--------------|-----------------|------|------|-------------|------------|-------------|
| LM2903AVQDRG4Q1 | SOIC | D | 8 | 2500 | 340.5 | 338.1 | 20.6 |
| LM2903AVQDRQ1 | SOIC | D | 8 | 2500 | 340.5 | 338.1 | 20.6 |
| LM2903AVQDRQ1 | SOIC | D | 8 | 2500 | 340.5 | 338.1 | 20.6 |
| LM2903AVQPWRG4Q1 | TSSOP | PW | 8 | 2000 | 367.0 | 367.0 | 35.0 |
| LM2903AVQPWRQ1 | TSSOP | PW | 8 | 2000 | 356.0 | 356.0 | 35.0 |
| LM2903BHQDGKRQ1 | VSSOP | DGK | 8 | 2500 | 366.0 | 364.0 | 50.0 |
| LM2903BHQDRQ1 | SOIC | D | 8 | 3000 | 340.5 | 338.1 | 20.6 |
| LM2903BHPWRQ1 | TSSOP | PW | 8 | 3000 | 356.0 | 356.0 | 35.0 |
| LM2903BQDDFRQ1 | SOT-23-THIN | DDF | 8 | 3000 | 210.0 | 185.0 | 35.0 |
| LM2903BQDGKRQ1 | VSSOP | DGK | 8 | 2500 | 366.0 | 364.0 | 50.0 |
| LM2903BQDRQ1 | SOIC | D | 8 | 2500 | 340.5 | 338.1 | 20.6 |
| LM2903BQDRQ1 | SOIC | D | 8 | 2500 | 356.0 | 356.0 | 35.0 |
| LM2903BQPWRQ1 | TSSOP | PW | 8 | 2000 | 356.0 | 356.0 | 35.0 |
| LM2903BRQDGKRQ1 | VSSOP | DGK | 8 | 2500 | 366.0 | 364.0 | 50.0 |
| LM2903BRQDRQ1 | SOIC | D | 8 | 3000 | 340.5 | 338.1 | 20.6 |
| LM2903BRQPWRQ1 | TSSOP | PW | 8 | 3000 | 356.0 | 356.0 | 35.0 |
| LM2903BTQDGKRQ1 | VSSOP | DGK | 8 | 2500 | 366.0 | 364.0 | 50.0 |
| LM2903BTQDRQ1 | SOIC | D | 8 | 3000 | 340.5 | 338.1 | 20.6 |

| Device | Package Type | Package Drawing | Pins | SPQ | Length (mm) | Width (mm) | Height (mm) |
|-----------------|--------------|-----------------|------|------|-------------|------------|-------------|
| LM2903BTQPWRQ1 | TSSOP | PW | 8 | 3000 | 356.0 | 356.0 | 35.0 |
| LM2903BWDSGRQ1 | WSON | DSG | 8 | 3000 | 213.0 | 191.0 | 35.0 |
| LM2903EPWRQ1 | TSSOP | PW | 8 | 2000 | 356.0 | 356.0 | 35.0 |
| LM2903QDGKRQ1 | VSSOP | DGK | 8 | 2500 | 366.0 | 364.0 | 50.0 |
| LM2903QDRG4Q1 | SOIC | D | 8 | 2500 | 340.5 | 338.1 | 20.6 |
| LM2903QDRQ1 | SOIC | D | 8 | 2500 | 340.5 | 338.1 | 20.6 |
| LM2903QPWRG4Q1 | TSSOP | PW | 8 | 2000 | 356.0 | 356.0 | 35.0 |
| LM2903QPWRQ1 | TSSOP | PW | 8 | 2000 | 356.0 | 356.0 | 35.0 |
| LM2903VQDRG4Q1 | SOIC | D | 8 | 2500 | 340.5 | 338.1 | 20.6 |
| LM2903VQPWRG4Q1 | TSSOP | PW | 8 | 2000 | 367.0 | 367.0 | 35.0 |
| LM2903VQPWRG4Q1 | TSSOP | PW | 8 | 2000 | 356.0 | 356.0 | 35.0 |
| LM2903VQPWRQ1 | TSSOP | PW | 8 | 2000 | 356.0 | 356.0 | 35.0 |
| LM2903VQPWRQ1 | TSSOP | PW | 8 | 2000 | 356.0 | 356.0 | 35.0 |



D0008A

PACKAGE OUTLINE

SOIC - 1.75 mm max height

SMALL OUTLINE INTEGRATED CIRCUIT



NOTES:

1. Linear dimensions are in inches [millimeters]. Dimensions in parenthesis are for reference only. Controlling dimensions are in inches. Dimensioning and tolerancing per ASME Y14.5M.
2. This drawing is subject to change without notice.
3. This dimension does not include mold flash, protrusions, or gate burrs. Mold flash, protrusions, or gate burrs shall not exceed .006 [0.15] per side.
4. This dimension does not include interlead flash.
5. Reference JEDEC registration MS-012, variation AA.

EXAMPLE BOARD LAYOUT

D0008A

SOIC - 1.75 mm max height

SMALL OUTLINE INTEGRATED CIRCUIT



LAND PATTERN EXAMPLE
 EXPOSED METAL SHOWN
 SCALE:8X



SOLDER MASK DETAILS

4214825/C 02/2019

NOTES: (continued)

- 6. Publication IPC-7351 may have alternate designs.
- 7. Solder mask tolerances between and around signal pads can vary based on board fabrication site.

EXAMPLE STENCIL DESIGN

D0008A

SOIC - 1.75 mm max height

SMALL OUTLINE INTEGRATED CIRCUIT



SOLDER PASTE EXAMPLE
BASED ON .005 INCH [0.125 MM] THICK STENCIL
SCALE:8X

4214825/C 02/2019

NOTES: (continued)

8. Laser cutting apertures with trapezoidal walls and rounded corners may offer better paste release. IPC-7525 may have alternate design recommendations.
9. Board assembly site may have different recommendations for stencil design.

DGK (S-PDSO-G8)

PLASTIC SMALL-OUTLINE PACKAGE

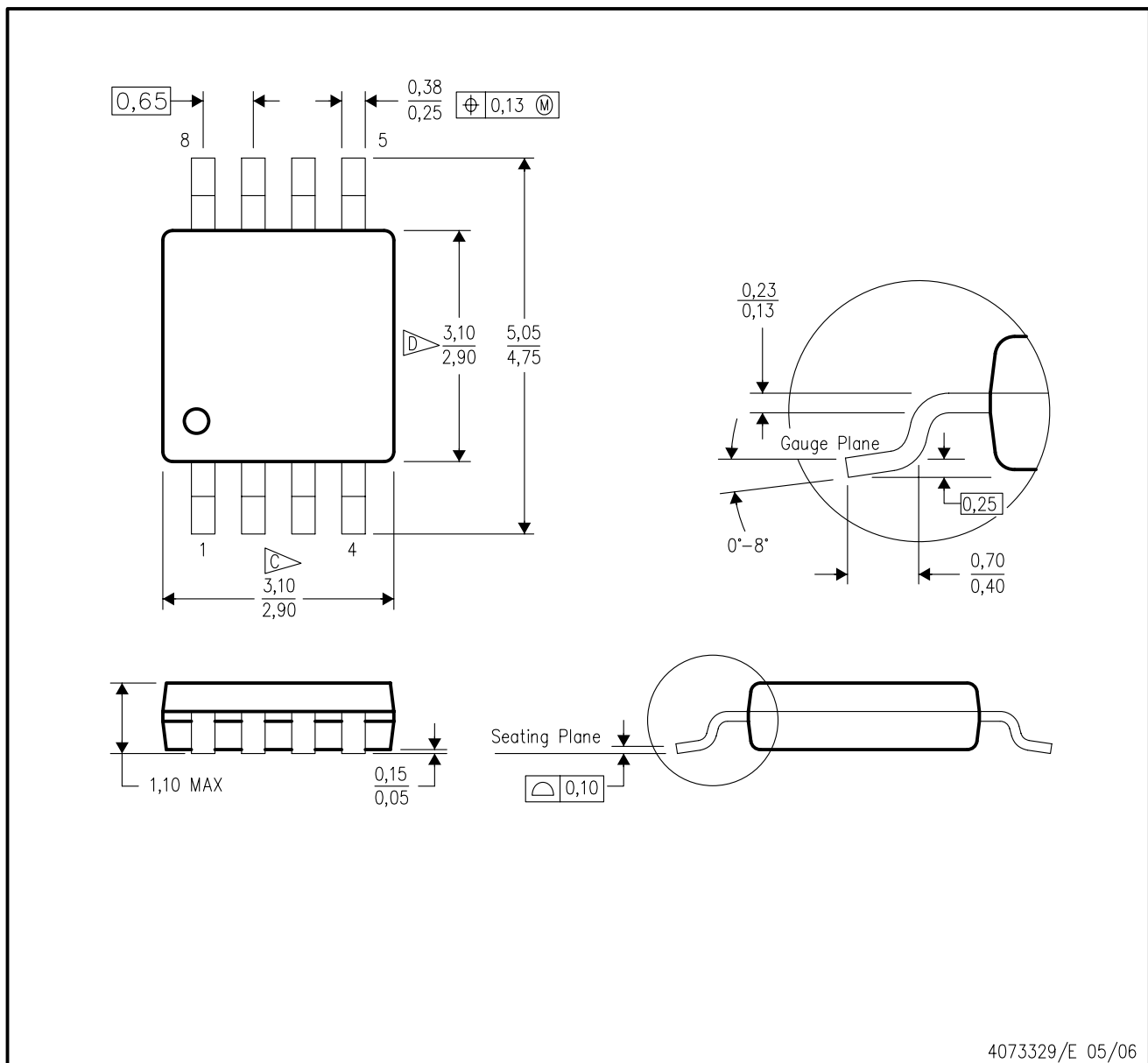

- NOTES:
- All linear dimensions are in millimeters.
 - This drawing is subject to change without notice.
 - Body length does not include mold flash, protrusions, or gate burrs. Mold flash, protrusions, or gate burrs shall not exceed 0.15 per end.
 - Body width does not include interlead flash. Interlead flash shall not exceed 0.50 per side.
 - Falls within JEDEC MO-187 variation AA, except interlead flash.



- NOTES:
- A. All linear dimensions are in millimeters.
 - B. This drawing is subject to change without notice.
 - C. Publication IPC-7351 is recommended for alternate designs.
 - D. Laser cutting apertures with trapezoidal walls and also rounding corners will offer better paste release. Customers should contact their board assembly site for stencil design recommendations. Refer to IPC-7525 for other stencil recommendations.
 - E. Customers should contact their board fabrication site for solder mask tolerances between and around signal pads.

GENERIC PACKAGE VIEW

DSG 8

WSON - 0.8 mm max height

2 x 2, 0.5 mm pitch

PLASTIC SMALL OUTLINE - NO LEAD

This image is a representation of the package family, actual package may vary.
Refer to the product data sheet for package details.



4224783/A

DSG0008B

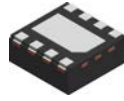

PACKAGE OUTLINE

WSON - 0.8 mm max height

PLASTIC SMALL OUTLINE - NO LEAD

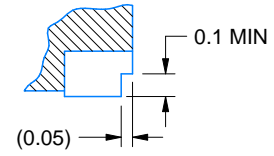
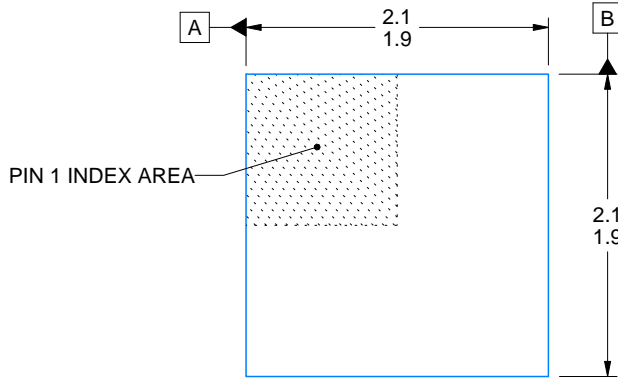

SECTION A-A TYPICAL

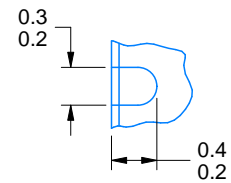

ALTERNATIVE TERMINAL SHAPE TYPICAL

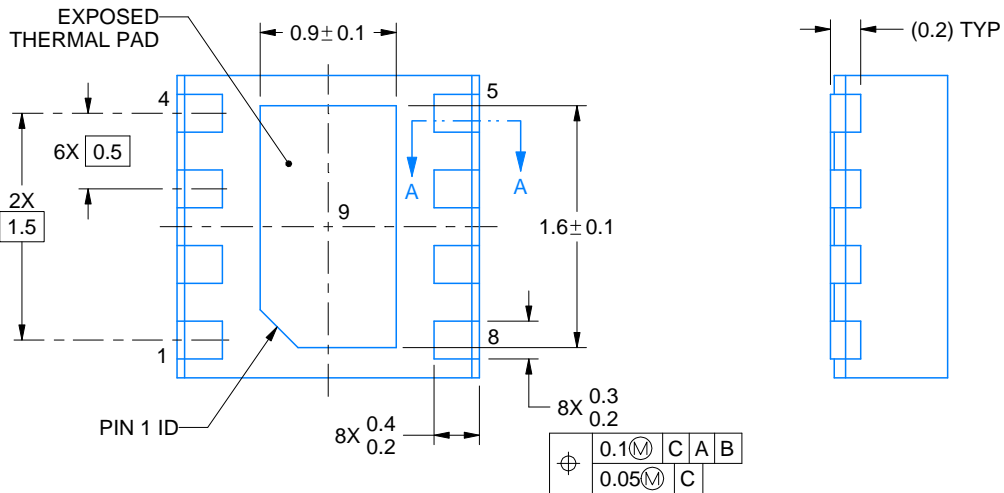
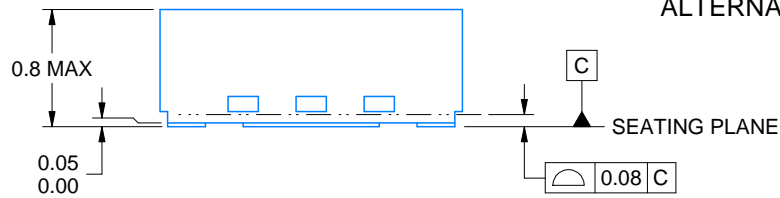

4222124/E 05/2020

NOTES:

1. All linear dimensions are in millimeters. Any dimensions in parenthesis are for reference only. Dimensioning and tolerancing per ASME Y14.5M.
2. This drawing is subject to change without notice.
3. The package thermal pad must be soldered to the printed circuit board for thermal and mechanical performance.

EXAMPLE BOARD LAYOUT

DSG0008B

WSON - 0.8 mm max height

PLASTIC SMALL OUTLINE - NO LEAD

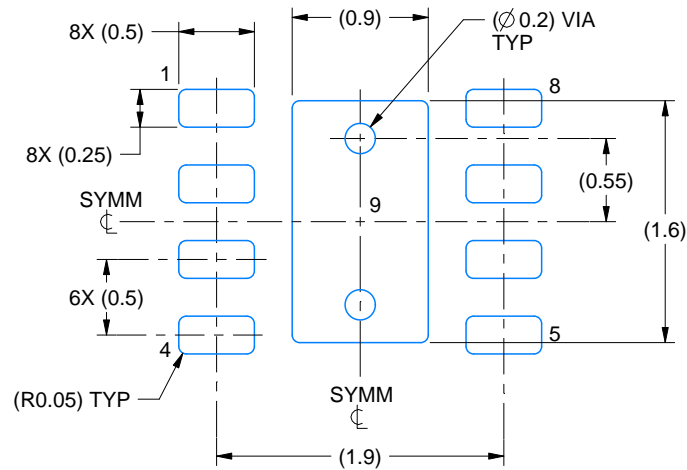

LAND PATTERN EXAMPLE
EXPOSED METAL SHOWN
SCALE:20X

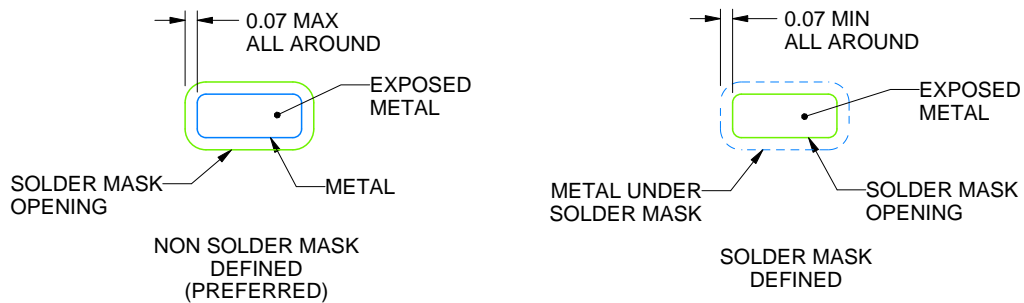

SOLDER MASK DETAILS

4222124/E 05/2020

NOTES: (continued)

4. This package is designed to be soldered to a thermal pad on the board. For more information, see Texas Instruments literature number SLUA271 (www.ti.com/lit/slua271).
5. Vias are optional depending on application, refer to device data sheet. If any vias are implemented, refer to their locations shown on this view. It is recommended that vias under paste be filled, plugged or tented.

EXAMPLE STENCIL DESIGN

DSG0008B

WSON - 0.8 mm max height

PLASTIC SMALL OUTLINE - NO LEAD

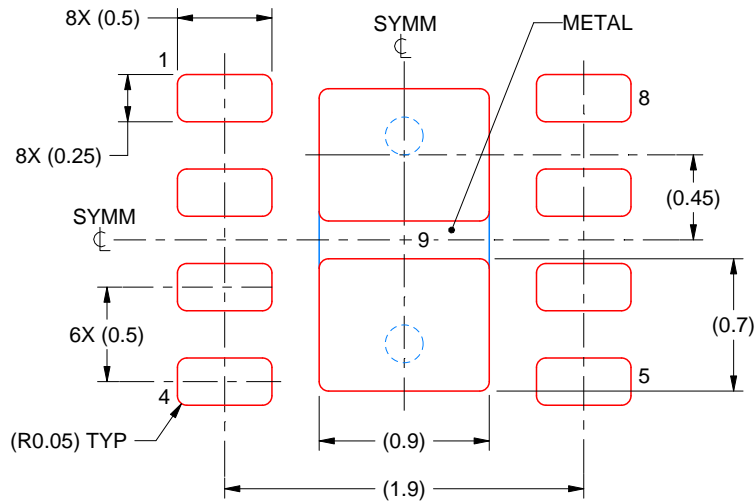

SOLDER PASTE EXAMPLE
BASED ON 0.125 mm THICK STENCIL

EXPOSED PAD 9:
87% PRINTED SOLDER COVERAGE BY AREA UNDER PACKAGE
SCALE:25X

4222124/E 05/2020

NOTES: (continued)

6. Laser cutting apertures with trapezoidal walls and rounded corners may offer better paste release. IPC-7525 may have alternate design recommendations.

PW0008A



PACKAGE OUTLINE
TSSOP - 1.2 mm max height

SMALL OUTLINE PACKAGE



4221848/A 02/2015

NOTES:

- All linear dimensions are in millimeters. Any dimensions in parenthesis are for reference only. Dimensioning and tolerancing per ASME Y14.5M.
- This drawing is subject to change without notice.
- This dimension does not include mold flash, protrusions, or gate burrs. Mold flash, protrusions, or gate burrs shall not exceed 0.15 mm per side.
- This dimension does not include interlead flash. Interlead flash shall not exceed 0.25 mm per side.
- Reference JEDEC registration MO-153, variation AA.

EXAMPLE BOARD LAYOUT

PW0008A

TSSOP - 1.2 mm max height

SMALL OUTLINE PACKAGE



LAND PATTERN EXAMPLE
SCALE:10X



SOLDER MASK DETAILS
NOT TO SCALE

4221848/A 02/2015

NOTES: (continued)

- 6. Publication IPC-7351 may have alternate designs.
- 7. Solder mask tolerances between and around signal pads can vary based on board fabrication site.

EXAMPLE STENCIL DESIGN

PW0008A

TSSOP - 1.2 mm max height

SMALL OUTLINE PACKAGE



SOLDER PASTE EXAMPLE
BASED ON 0.125 mm THICK STENCIL
SCALE:10X

4221848/A 02/2015

NOTES: (continued)

8. Laser cutting apertures with trapezoidal walls and rounded corners may offer better paste release. IPC-7525 may have alternate design recommendations.
9. Board assembly site may have different recommendations for stencil design.

DDF0008A



PACKAGE OUTLINE

SOT-23 - 1.1 mm max height

PLASTIC SMALL OUTLINE

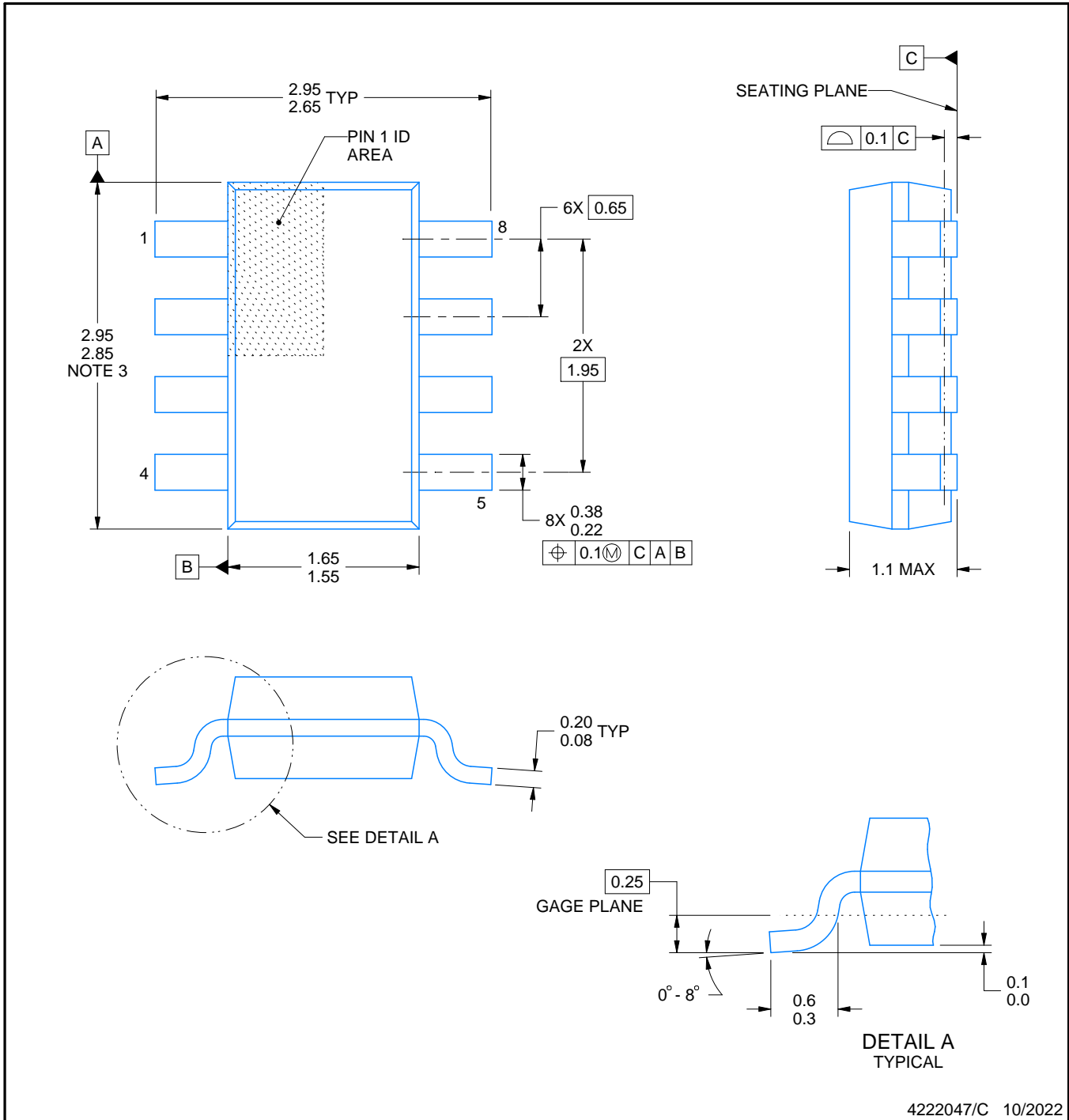

4222047/C 10/2022

NOTES:

- All linear dimensions are in millimeters. Any dimensions in parenthesis are for reference only. Dimensioning and tolerancing per ASME Y14.5M.
- This drawing is subject to change without notice.
- This dimension does not include mold flash, protrusions, or gate burrs. Mold flash, protrusions, or gate burrs shall not exceed 0.15 mm per side.

EXAMPLE BOARD LAYOUT

DDF0008A

SOT-23 - 1.1 mm max height

PLASTIC SMALL OUTLINE

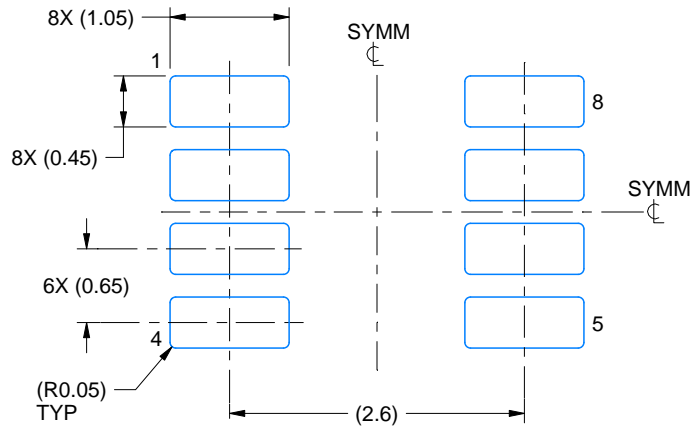

LAND PATTERN EXAMPLE
SCALE:15X

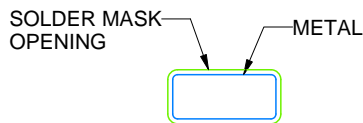

NON SOLDER MASK
DEFINED

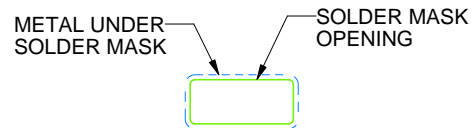

SOLDER MASK
DEFINED

SOLDER MASK DETAILS

4222047/C 10/2022

NOTES: (continued)

4. Publication IPC-7351 may have alternate designs.
5. Solder mask tolerances between and around signal pads can vary based on board fabrication site.

EXAMPLE STENCIL DESIGN

DDF0008A

SOT-23 - 1.1 mm max height

PLASTIC SMALL OUTLINE



SOLDER PASTE EXAMPLE
BASED ON 0.125 mm THICK STENCIL
SCALE:15X

4222047/C 10/2022

NOTES: (continued)

6. Laser cutting apertures with trapezoidal walls and rounded corners may offer better paste release. IPC-7525 may have alternate design recommendations.
7. Board assembly site may have different recommendations for stencil design.

IMPORTANT NOTICE AND DISCLAIMER

TI PROVIDES TECHNICAL AND RELIABILITY DATA (INCLUDING DATA SHEETS), DESIGN RESOURCES (INCLUDING REFERENCE DESIGNS), APPLICATION OR OTHER DESIGN ADVICE, WEB TOOLS, SAFETY INFORMATION, AND OTHER RESOURCES "AS IS" AND WITH ALL FAULTS, AND DISCLAIMS ALL WARRANTIES, EXPRESS AND IMPLIED, INCLUDING WITHOUT LIMITATION ANY IMPLIED WARRANTIES OF MERCHANTABILITY, FITNESS FOR A PARTICULAR PURPOSE OR NON-INFRINGEMENT OF THIRD PARTY INTELLECTUAL PROPERTY RIGHTS.

These resources are intended for skilled developers designing with TI products. You are solely responsible for (1) selecting the appropriate TI products for your application, (2) designing, validating and testing your application, and (3) ensuring your application meets applicable standards, and any other safety, security, regulatory or other requirements.

These resources are subject to change without notice. TI grants you permission to use these resources only for development of an application that uses the TI products described in the resource. Other reproduction and display of these resources is prohibited. No license is granted to any other TI intellectual property right or to any third party intellectual property right. TI disclaims responsibility for, and you will fully indemnify TI and its representatives against, any claims, damages, costs, losses, and liabilities arising out of your use of these resources.

TI's products are provided subject to [TI's Terms of Sale](#) or other applicable terms available either on [ti.com](https://www.ti.com) or provided in conjunction with such TI products. TI's provision of these resources does not expand or otherwise alter TI's applicable warranties or warranty disclaimers for TI products.

TI objects to and rejects any additional or different terms you may have proposed.

Mailing Address: Texas Instruments, Post Office Box 655303, Dallas, Texas 75265
Copyright © 2024, Texas Instruments Incorporated