

## LM4570 Single-Ended Input Motor Driver

Check for Samples: [LM4570](#)

### FEATURES

- Output Short Circuit Protection
- High Output Current Capability
- Wide Output Voltage Range
- Fast Turn on Time
- Output Short Circuit Protection
- Low Power Shutdown Mode
- Minimum External Components
- Available in Space-Saving WSON Package

### APPLICATIONS

- Mobile Phones
- PDAs
- Video Game Systems

### KEY SPECIFICATIONS

- High Output Current @  $V_{DD} = 3V$ : 192 mA
- Fast Turn On Time @ 3V: 2.4 ms
- Quiescent Power Supply Current @ 3V: 1.9 mA
- Shutdown Current: 0.1  $\mu A$  (Typ)

### Typical Application

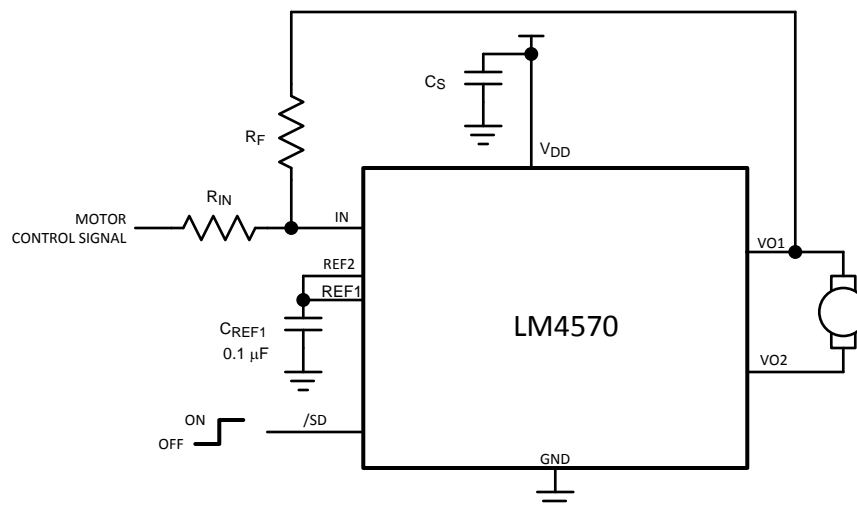

**Figure 1. Typical Motor Driver Application Circuit**



Please be aware that an important notice concerning availability, standard warranty, and use in critical applications of Texas Instruments semiconductor products and disclaimers thereto appears at the end of this data sheet.

All trademarks are the property of their respective owners.

### DESCRIPTION

The LM4570 is a single supply motor driver for improved sensory experience in mobile phones and other handheld devices. The LM4570 is capable of driving up to 192mA while operating from a 3V supply. Near rail-to-rail output swing under load ensures sufficient voltage drive for most DC motors, while the differential output drive allows the voltage polarity across the motor to be reversed quickly. Reversing the voltage gives the LM4570 the ability to drive a motor both clock-wise and counter clock-wise from a single supply.

The LM4570 features fast turn on time, and a wide input voltage range for precise speed control. A low power shutdown mode minimizes power consumption.

Thermal and output short circuit protection prevents the device from being damaged during fault conditions.

## Connection Diagram

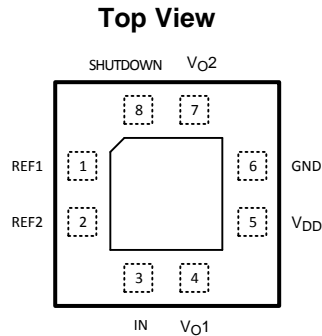

**Figure 2. Leadless Leadframe WSON Package**  
See Package Number NGP0008A



These devices have limited built-in ESD protection. The leads should be shorted together or the device placed in conductive foam during storage or handling to prevent electrostatic damage to the MOS gates.

### Absolute Maximum Ratings<sup>(1)(2)</sup>

Supply Voltage <sup>(3)</sup>		6.0V
Storage Temperature		-65°C to +150°C
Voltage at Any Input Pin		-0.3V $\geq$ to $V_{DD} + 0.3V$
Power Dissipation <sup>(4)</sup>		Internally Limited
ESD Susceptibility <sup>(5)</sup>		2000V
ESD Susceptibility <sup>(6)</sup>		200V
Junction Temperature ( $T_{JMAX}$ )		150°C
Thermal Resistance	$\theta_{JA}$ (WSON)	140°C/W

- (1) Absolute Maximum Ratings indicate limits beyond which damage to the device may occur. Operating Ratings indicate conditions for which the device is functional, but do not specify specific performance limits. Electrical Characteristics state DC and AC electrical specifications under particular test conditions which specify specific performance limits. This assumes that the device is within the Operating Ratings. Specifications are not specified for parameters where no limit is given; however, the typical value is a good indication of device performance.
- (2) If Military/Aerospace specified devices are required, please contact the Texas Instruments Sales Office/Distributors for availability and specifications.
- (3) All voltages are measured with respect to the ground pin, unless otherwise specified.
- (4) The maximum power dissipation must be de-rated at elevated temperatures and is dictated by  $T_{JMAX}$ ,  $\theta_{JC}$ , and the ambient temperature  $T_A$ . The maximum allowable power dissipation is  $P_{DMAX} = (T_{JMAX} - T_A) / \theta_{JA}$  or the number given in the Absolute Maximum Ratings, whichever is lower. For the LM4570,  $T_{JMAX} = 150^\circ\text{C}$  and the typical  $\theta_{JA}$  for the WSON package is 140°C/W.
- (5) Human body model, 100pF discharged through a 1.5k $\Omega$  resistor.
- (6) Machine Model, 220pF–240pF discharged through all pins.

### Operating Ratings

Temperature Range ( $T_{MIN} \leq T_A \leq T_{MAX}$ )		-40°C $\leq T_A \leq 85^\circ\text{C}$
Supply Voltage		2.4V $\leq V_{DD} \leq 5.5V$

## Electrical Characteristics $V_{DD} = 5V$

(1)(2)

 The following specifications apply for  $V_{DD} = 5V$ ,  $A_{V-BTL} = 6dB$  unless otherwise specified. Limits apply for  $T_A = 25^\circ C$ .

Parameter	Test Conditions	LM4570		Units (Limits)	
		Typ <sup>(3)</sup>	Limit <sup>(4)(5)</sup>		
$I_{DD}$	Quiescent Power Supply Current	$V_{IN} = 0V, I_L = 0A$ , No Load	2.5	5.5	mA (max)
		$V_{IN} = 0V, I_L = 0A, R_L = 30\Omega$	2.6	5.5	mA (max)
$I_{SD}$	Shutdown Current	$V_{SD} = GND$	0.1	1.5	$\mu A$ (max)
$V_{IH}$	Logic Input High			1.4	V (min)
$V_{IL}$	Logic Input Low			0.4	V (max)
$V_{OS}$	Output Offset Voltage		5	$\pm 35$	mV (max)
$I_{OUT}$	Output Current	$V_{OH}, V_{OL} \leq 250mV$	268		mA
$T_{WU}$	Wake-up time		2.5		ms (max)
$V_{OH}$	Output High Voltage	$R_L = 30\Omega$ specified as $ V_{DD} - V_{OH} $	146	200	mV (max)
$V_{OL}$	Output Low Voltage	$R_L = 30\Omega$ specified as $ GND + V_{OH} $	106	200	mV (max)

- (1) All voltages are measured with respect to the ground pin, unless otherwise specified.
- (2) Absolute Maximum Ratings indicate limits beyond which damage to the device may occur. Operating Ratings indicate conditions for which the device is functional, but do not specify specific performance limits. Electrical Characteristics state DC and AC electrical specifications under particular test conditions which specify specific performance limits. This assumes that the device is within the Operating Ratings. Specifications are not specified for parameters where no limit is given; however, the typical value is a good indication of device performance.
- (3) Typicals are measured at  $25^\circ C$  and represent the parametric norm.
- (4) Limits are ensured to AOQL (Average Outgoing Quality Level).
- (5) Datasheet min/max specification limits are ensured by design, test, or statistical analysis.

## Electrical Characteristics $V_{DD} = 3V$

(1)(2)

 The following specifications apply for  $V_{DD} = 3V$ ,  $A_{V-BTL} = 6dB$  unless otherwise specified. Limits apply for  $T_A = 25^\circ C$ .

Parameter	Test Conditions	LM4570		Units (Limits)	
		Typ <sup>(3)</sup>	Limit <sup>(4)(5)</sup>		
$I_{DD}$	Quiescent Power Supply Current	$V_{IN} = 0V, I_L = 0A$ , No Load	1.9	4	mA (max)
		$V_{IN} = 0V, I_L = 0A, R_L = 30\Omega$	1.95	4	
$I_{SD}$	Shutdown Current <sup>(6)</sup>	$V_{SD} = GND$	0.1	1.0	$\mu A$ (max)
$V_{IH}$	Logic Input High			1.4	V (min)
$V_{IL}$	Logic Input Low			0.4	V (max)
$V_{OS}$	Output Offset Voltage		5	$\pm 35$	mV (max)
$I_{OUT}$	Output Current	$V_{OH}, V_{OL} \leq 200mV$	192		mA
$T_{WU}$	Wake-up time		2.4		ms (max)
$V_{OH}$	Output High Voltage	$R_L = 30\Omega$ specified as $ V_{DD} - V_{OH} $	90	110	mV (max)
$V_{OL}$	Output Low Voltage	$R_L = 30\Omega$ specified as $ V_{DD} - V_{OH} $	63	110	mV (max)

- (1) All voltages are measured with respect to the ground pin, unless otherwise specified.
- (2) Absolute Maximum Ratings indicate limits beyond which damage to the device may occur. Operating Ratings indicate conditions for which the device is functional, but do not specify specific performance limits. Electrical Characteristics state DC and AC electrical specifications under particular test conditions which specify specific performance limits. This assumes that the device is within the Operating Ratings. Specifications are not specified for parameters where no limit is given; however, the typical value is a good indication of device performance.
- (3) Typicals are measured at  $25^\circ C$  and represent the parametric norm.
- (4) Limits are ensured to AOQL (Average Outgoing Quality Level).
- (5) Datasheet min/max specification limits are ensured by design, test, or statistical analysis.
- (6) Shutdown current is measured in a normal room environment. Exposure to direct sunlight will increase  $I_{SD}$  by a maximum of  $2\mu A$ .

Typical Performance Characteristics

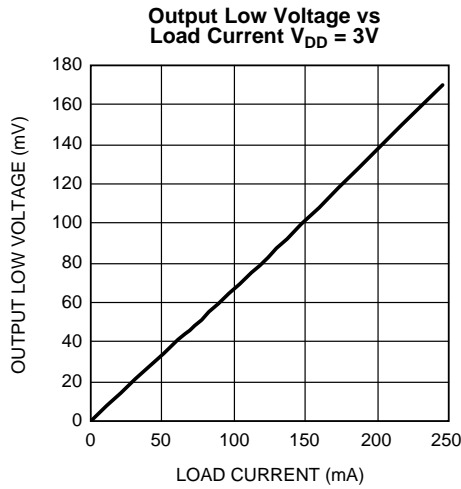

Figure 3.

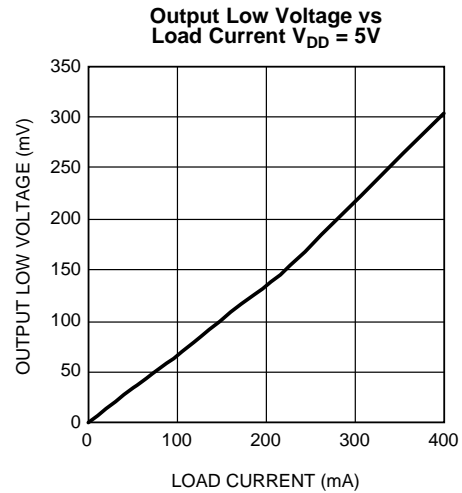

Figure 4.

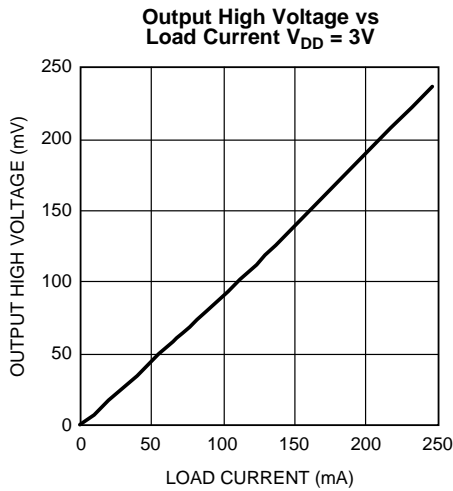

Figure 5.

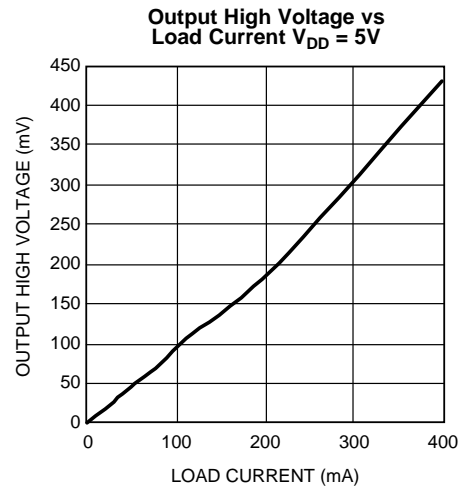

Figure 6.

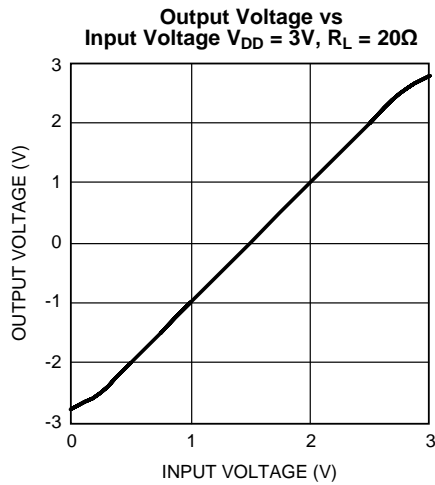

Figure 7.

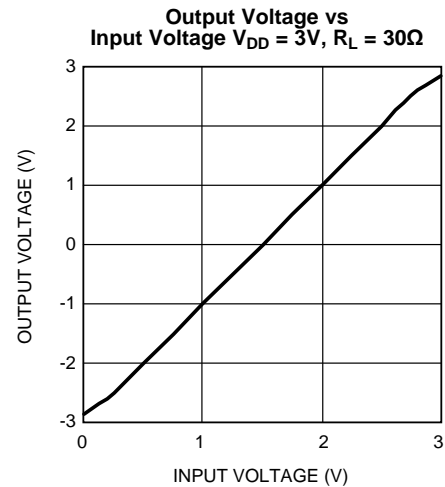

Figure 8.

Typical Performance Characteristics (continued)

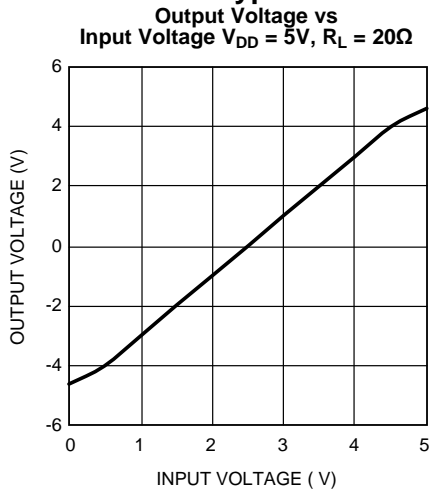

Figure 9.

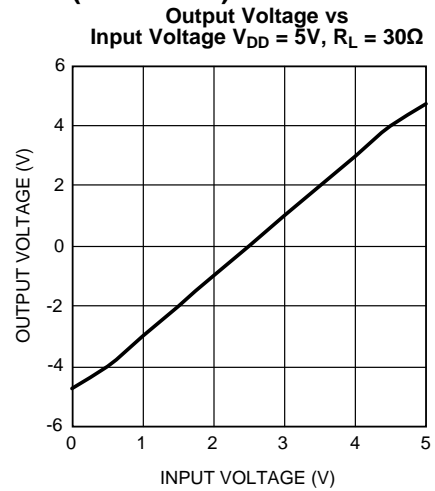

Figure 10.

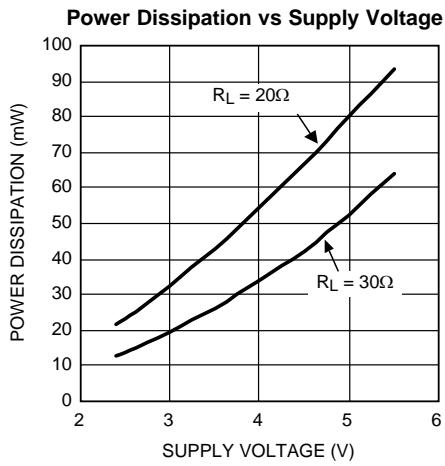

Figure 11.

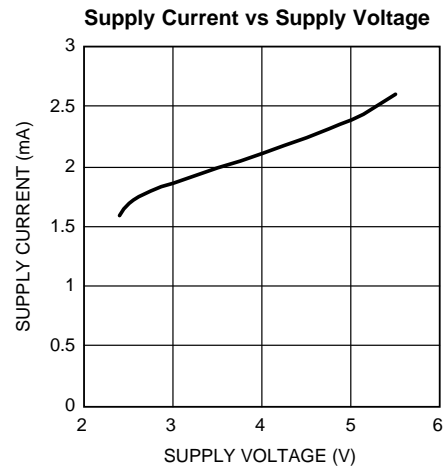

Figure 12.

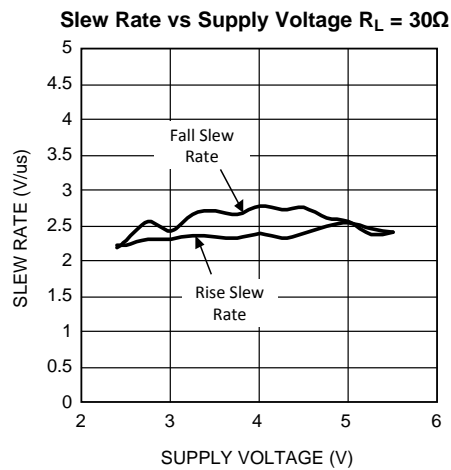

Figure 13.

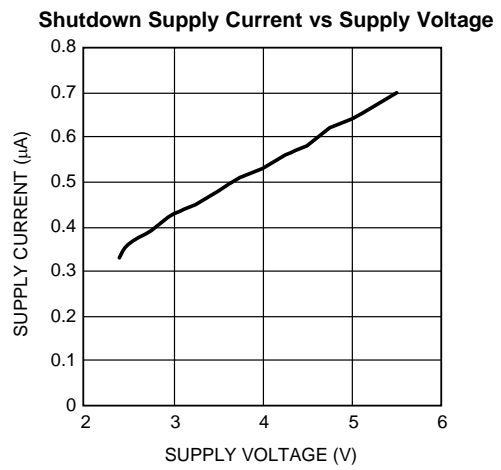

Figure 14.

**Typical Performance Characteristics (continued)**

**Output Transition High to Low, Low to High**  
 $V_{DD} = 3V, 1V/div, 400ns/div$

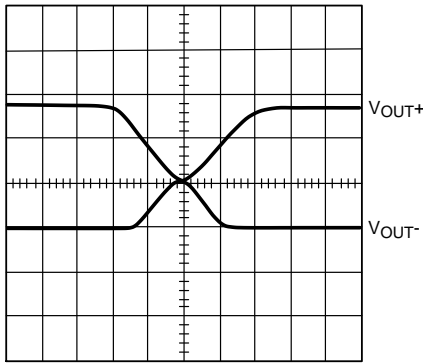

Figure 15.

**Output Transition High to Low, Low to High**  
 $V_{DD} = 5V, 1V/div, 1\mu s/div$

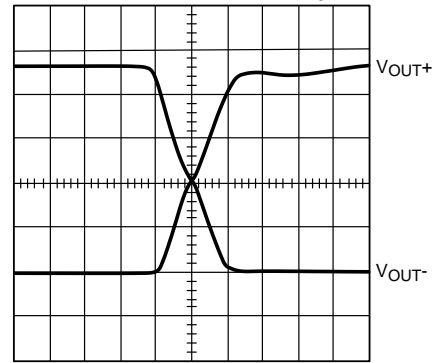

Figure 16.

**Turn-Off Time**  $V_{DD} = 5V, 2V/div, 1ms/div$

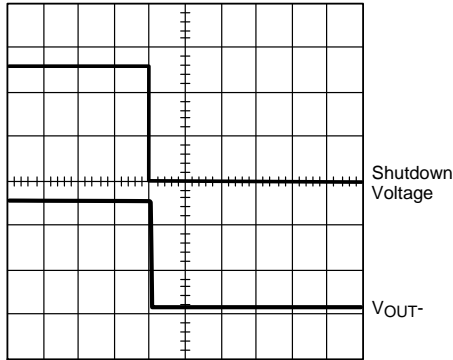

Figure 17.

**Turn-On Time**  $V_{DD} = 5V, 2V/div, 1ms/div$

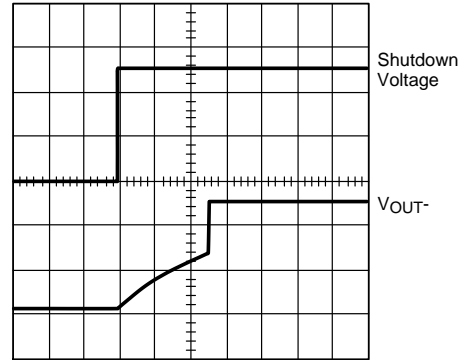

Figure 18.

## APPLICATION INFORMATION

### BRIDGE CONFIGURATION EXPLANATION

The LM4570 uses a bridged architecture that drives a load differentially. The BTL design offers several advantages over a single-ended design. The device outputs,  $V_{O1}$  and  $V_{O2}$ , both source and sink current, which means that the polarity of the voltage across the motor can be reversed quickly (Figure 19). A single-ended device would need to operate from split supplies to achieve this behavior. The ability to reverse the voltage polarity is necessary in applications where a negative (reverse polarity) pulse is used to quickly stop the motor. If the drive voltage is just removed from the motor (not reversed) then the motor will continue to spin until the residual energy stored in the windings has dissipated.

The output voltage of the LM4570 is determined by the difference between the input voltage and  $V_{REF1}$ , as well as the differential gain of the device. The output voltage is given by the following:

$$V_{O1} - V_{O2} = A_{VD}(V_{IN} - V_{REF1}) \quad (1)$$

For input voltages that are less than the reference voltage, the differential output voltage is negative. For input voltages that are greater than the reference voltage, the differential output voltage is positive. For example, when operating from a 5V supply ( $V_{REF1} = 2.5V$ ) and with a differential gain of 6dB, with a 1V input, the voltage measured across  $V_{O1}$  and  $V_{O2}$  is -3V, with a 4V input, the differential output voltage is +3V.

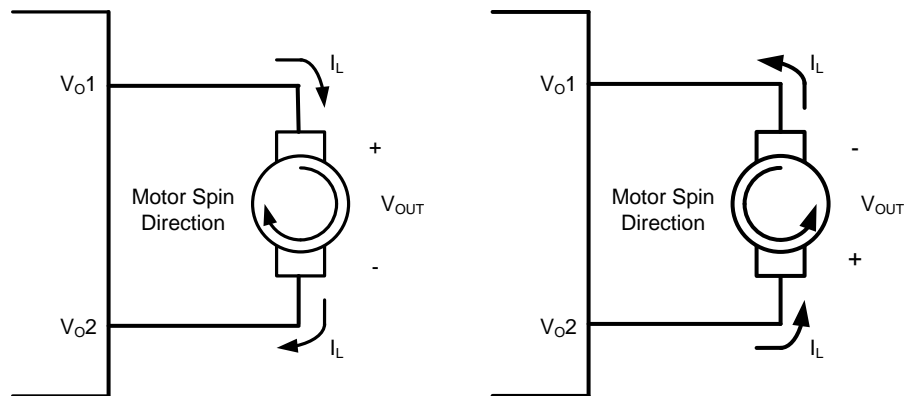

Figure 19. Voltage Polarity and Motor Direction

### GAIN SETTING

The resistors  $R_{IN}$  and  $R_F$  set the gain of the LM4570, given by:

$$V_{VD} = 2 \times (R_F / R_{IN}) \quad (2)$$

Where  $A_{VD}$  is the differential gain.  $A_{VD}$  differs from single-ended gain by a factor of 2. This doubling is due to the differential output architecture of the LM4570. Driving the load differentially doubles the output voltage compared to a single-ended output amplifier under the same conditions.

### POWER DISSIPATION

Figure 11 shows the power dissipation of the LM4570 with the input equal to the supply voltage, meaning the outputs swing rail-to-rail. This configuration results in the output devices of the LM4570 operating in the linear region, essentially very small resistors determined by the  $R_{DS(ON)}$  of the output devices. Under these conditions, the power dissipation is dominated by the  $I \cdot R$  drop associated with the output current across the  $R_{DS(ON)}$  of the output transistors, thus the power dissipation is very low (60mW for a 800mW output).

When the input voltage is not equal to GND or  $V_{DD}$ , the power dissipation of the LM4570 increases (Figure 20). Under these conditions, the output devices operate in the saturation region, where the devices consume current in addition to the current being steered to the load, increasing the power dissipation. Power dissipation for typical motor driving applications should not be an issue since the most of the time the device outputs will be driven rail-to-rail.

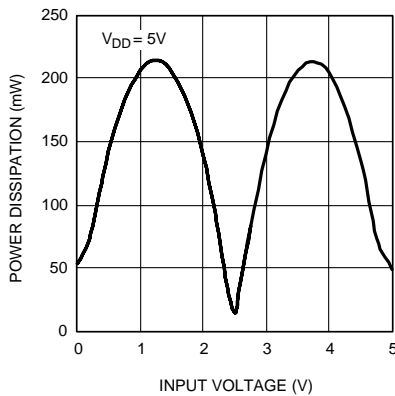

**Figure 20. Power Dissipation vs. Input Voltage**

## EXPOSED-DAP MOUNTING CONSIDERATIONS

The LM4570 is available in an 8-pin WSON package which features an exposed DAP (die attach paddle). The exposed DAP provides a direct thermal conduction path between the die and the PCB, improving the thermal performance by reducing the thermal resistance of the package. Connect the exposed DAP to GND through a large pad beneath the device, and multiple vias to a large unbroken GND plane. For best thermal performance, connect the DAP pad to a GND plane on an outside layer of the PCB. Connecting the DAP to a plane on an inner layer will result in a higher thermal resistance. Ensure efficient thermal conductivity by plugging and tenting the vias with plating and solder mask, respectively.

## POWER SUPPLY BYPASSING

Good power supply bypassing is critical for proper operation. Locate both the REF1 and  $V_{DD}$  bypass capacitors as close to the device as possible. Typical applications employ a regulator with a 10 $\mu$ F tantalum or electrolytic capacitor and a ceramic bypass capacitor which aid in supply stability. This does not eliminate the need for bypass capacitors near the LM4570. Place a 1 $\mu$ F ceramic capacitor as close to  $V_{DD}$  as possible. Place a 0.1 $\mu$ F capacitor as close to REF1 as possible. Smaller values of  $C_{REF1}$  may be chosen for decreased turn on times.

## SHUTDOWN FUNCTION

The LM4570 features a low power shutdown mode that disables the device and reduces quiescent current consumption to 0.1 $\mu$ A. Driving /SD Low disables the amplifiers and bias circuitry, and drives  $V_{REF1}$  and the outputs to GND. Connect /SD to  $V_{DD}$  for normal operation.



DEMO BOARD LAYOUT

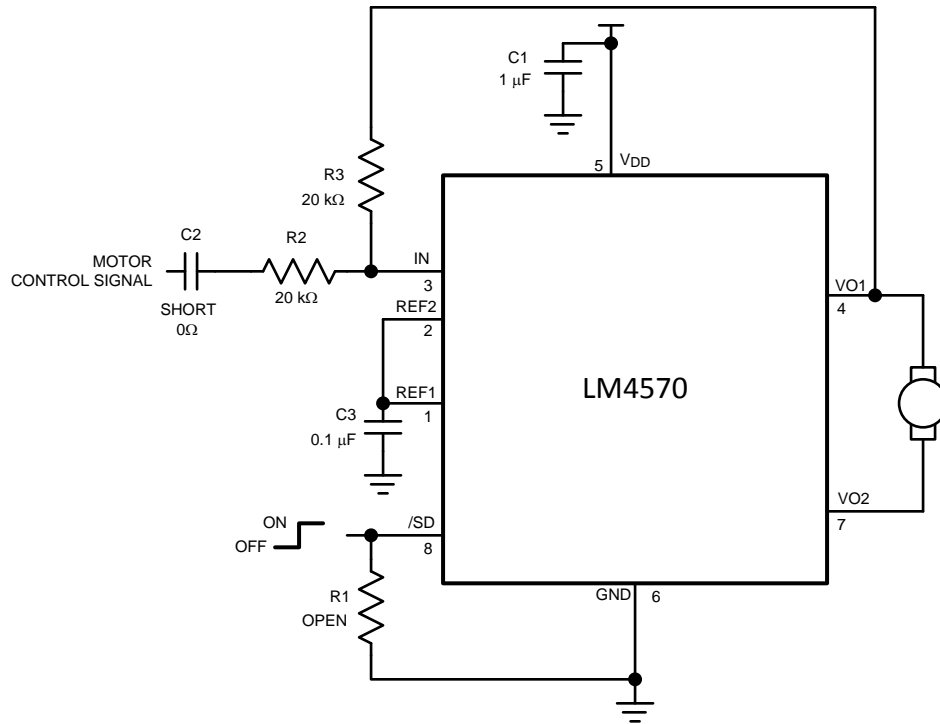

Revision History

Rev	Date	Description
1.0	04/13/06	Initial release.
1.01	07/28/09	Added the Ordering Information table.
C	04/08/13	Changed layout of National Data Sheet to TI format.

**PACKAGING INFORMATION**

Orderable Device	Status (1)	Package Type	Package Drawing	Pins	Package Qty	Eco Plan (2)	Lead finish/ Ball material (6)	MSL Peak Temp (3)	Op Temp (°C)	Device Marking (4/5)	Samples
LM4570LQ/NOPB	ACTIVE	WQFN	NGP	8	1000	RoHS & Green	SN	Level-3-260C-168 HR	-40 to 85	GC8	<b>Samples</b>

(1) The marketing status values are defined as follows:

**ACTIVE:** Product device recommended for new designs.

**LIFEBUY:** TI has announced that the device will be discontinued, and a lifetime-buy period is in effect.

**NRND:** Not recommended for new designs. Device is in production to support existing customers, but TI does not recommend using this part in a new design.

**PREVIEW:** Device has been announced but is not in production. Samples may or may not be available.

**OBSOLETE:** TI has discontinued the production of the device.

(2) **RoHS:** TI defines "RoHS" to mean semiconductor products that are compliant with the current EU RoHS requirements for all 10 RoHS substances, including the requirement that RoHS substance do not exceed 0.1% by weight in homogeneous materials. Where designed to be soldered at high temperatures, "RoHS" products are suitable for use in specified lead-free processes. TI may reference these types of products as "Pb-Free".

**RoHS Exempt:** TI defines "RoHS Exempt" to mean products that contain lead but are compliant with EU RoHS pursuant to a specific EU RoHS exemption.

**Green:** TI defines "Green" to mean the content of Chlorine (Cl) and Bromine (Br) based flame retardants meet JS709B low halogen requirements of <=1000ppm threshold. Antimony trioxide based flame retardants must also meet the <=1000ppm threshold requirement.

(3) MSL, Peak Temp. - The Moisture Sensitivity Level rating according to the JEDEC industry standard classifications, and peak solder temperature.

(4) There may be additional marking, which relates to the logo, the lot trace code information, or the environmental category on the device.

(5) Multiple Device Markings will be inside parentheses. Only one Device Marking contained in parentheses and separated by a "-" will appear on a device. If a line is indented then it is a continuation of the previous line and the two combined represent the entire Device Marking for that device.

(6) Lead finish/Ball material - Orderable Devices may have multiple material finish options. Finish options are separated by a vertical ruled line. Lead finish/Ball material values may wrap to two lines if the finish value exceeds the maximum column width.

**Important Information and Disclaimer:**The information provided on this page represents TI's knowledge and belief as of the date that it is provided. TI bases its knowledge and belief on information provided by third parties, and makes no representation or warranty as to the accuracy of such information. Efforts are underway to better integrate information from third parties. TI has taken and continues to take reasonable steps to provide representative and accurate information but may not have conducted destructive testing or chemical analysis on incoming materials and chemicals. TI and TI suppliers consider certain information to be proprietary, and thus CAS numbers and other limited information may not be available for release.

In no event shall TI's liability arising out of such information exceed the total purchase price of the TI part(s) at issue in this document sold by TI to Customer on an annual basis.

## TAPE AND REEL INFORMATION



### QUADRANT ASSIGNMENTS FOR PIN 1 ORIENTATION IN TAPE



\*All dimensions are nominal

Device	Package Type	Package Drawing	Pins	SPQ	Reel Diameter (mm)	Reel Width W1 (mm)	A0 (mm)	B0 (mm)	K0 (mm)	P1 (mm)	W (mm)	Pin1 Quadrant
LM4570LQ/NOPB	WQFN	NGP	8	1000	178.0	12.4	2.2	2.2	1.0	8.0	12.0	Q1

**TAPE AND REEL BOX DIMENSIONS**



\*All dimensions are nominal

Device	Package Type	Package Drawing	Pins	SPQ	Length (mm)	Width (mm)	Height (mm)
LM4570LQ/NOPB	WQFN	NGP	8	1000	210.0	185.0	35.0

NGP0008A

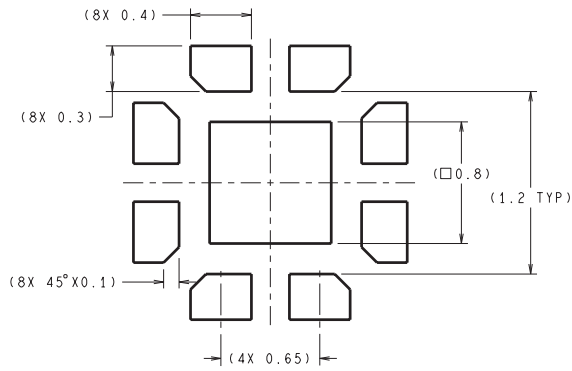

DIMENSIONS ARE IN MILLIMETERS

**RECOMMENDED LAND PATTERN**  
1:1 RATIO WITH PKG SOLDER PADS

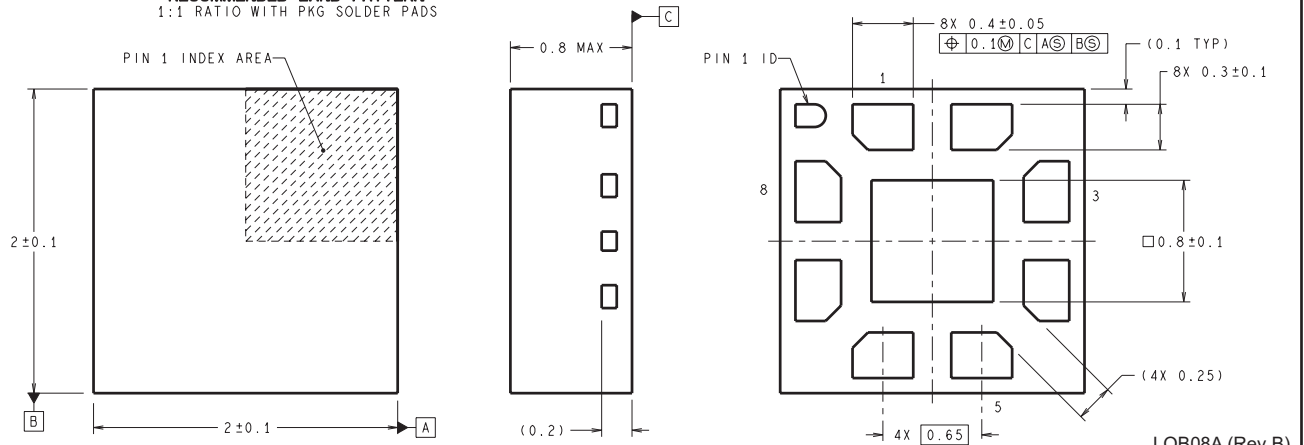

LQB08A (Rev B)

## IMPORTANT NOTICE AND DISCLAIMER

TI PROVIDES TECHNICAL AND RELIABILITY DATA (INCLUDING DATASHEETS), DESIGN RESOURCES (INCLUDING REFERENCE DESIGNS), APPLICATION OR OTHER DESIGN ADVICE, WEB TOOLS, SAFETY INFORMATION, AND OTHER RESOURCES "AS IS" AND WITH ALL FAULTS, AND DISCLAIMS ALL WARRANTIES, EXPRESS AND IMPLIED, INCLUDING WITHOUT LIMITATION ANY IMPLIED WARRANTIES OF MERCHANTABILITY, FITNESS FOR A PARTICULAR PURPOSE OR NON-INFRINGEMENT OF THIRD PARTY INTELLECTUAL PROPERTY RIGHTS.

These resources are intended for skilled developers designing with TI products. You are solely responsible for (1) selecting the appropriate TI products for your application, (2) designing, validating and testing your application, and (3) ensuring your application meets applicable standards, and any other safety, security, or other requirements. These resources are subject to change without notice. TI grants you permission to use these resources only for development of an application that uses the TI products described in the resource. Other reproduction and display of these resources is prohibited. No license is granted to any other TI intellectual property right or to any third party intellectual property right. TI disclaims responsibility for, and you will fully indemnify TI and its representatives against, any claims, damages, costs, losses, and liabilities arising out of your use of these resources.

TI's products are provided subject to TI's Terms of Sale ([www.ti.com/legal/termsofsale.html](http://www.ti.com/legal/termsofsale.html)) or other applicable terms available either on [ti.com](http://ti.com) or provided in conjunction with such TI products. TI's provision of these resources does not expand or otherwise alter TI's applicable warranties or warranty disclaimers for TI products.

Mailing Address: Texas Instruments, Post Office Box 655303, Dallas, Texas 75265  
Copyright © 2020, Texas Instruments Incorporated