

# LM49150 Boomer® Audio Power Amplifier Series Mono Class D Audio Subsystem with Earpiece Driver and Stereo Ground Referenced Headphone Amplifiers

Check for Samples: [LM49150](#), [LM49150TLEVAL](#)

## FEATURES

- E<sup>2</sup>S Class D Amplifier
- Ground Referenced Headphone Outputs — Eliminates Output Coupling Capacitors
- I<sup>2</sup>C Volume and Mode Control
- Mono Earpiece Amplifier
- Flexible Output for Speaker and Headphone Output
- 20-Bump DSBGA Package
- Soft Enable Function
- “Click and Pop” Suppression Circuitry
- Thermal Shutdown Protection
- Low Supply Current
- Micro-Power Shutdown

## KEY SPECIFICATIONS

- Output power at V<sub>DD</sub> = 5V:
  - Speaker: R<sub>L</sub> = 8Ω BTL, THD+N ≤ 1%: 1.25W (typ)
  - Headphone: R<sub>L</sub> = 32Ω SE, THD+N ≤ 1%: 42mW (typ)
  - Earpiece: R<sub>L</sub> = 8Ω SE, THD+N ≤ 1%: 135mW (typ)
- Output power at V<sub>DD</sub> = 3.3V:
  - Speaker: R<sub>L</sub> = 8Ω BTL, THD+N ≤ 1%: 520mW (typ)
  - Headphone: R<sub>L</sub> = 32Ω BTL, THD+N ≤ 1%: 42mW (typ)
  - Earpiece: R<sub>L</sub> = 8Ω SE, THD+N ≤ 1%: 35mW (typ)
- Output Offset
  - LS Mode: 9mV (typ)
  - HP Mode: 1mV (typ)
  - Earpiece: 1mV (typ)
- Single Supply Operation (V<sub>DD</sub>): 2.7 to 5.5V
- I<sup>2</sup>C Single Supply Operation: 1.7 to 5.5V

## APPLICATIONS

- Mobile Phones
- PDAs
- Portable Electronics

## DESCRIPTION

The LM49150 is a fully integrated audio subsystem designed for portable handheld applications such as cellular phones. Part of TI's PowerWise™ product family, the LM49150 consumes very low power in the various modes of operation and still providing great audio performance. The LM49150 combines a 1.25W mono E<sup>2</sup>S (Enhanced Emission Suppression) class D amplifier, 135mW Class AB earpiece amplifier, 42mW/channel stereo ground reference headphone amplifiers, volume control, and mixing circuitry into a single device.

The filterless class D amplifier delivers 1.25W into an 8Ω load with <1% THD+N with a 5V supply. The E<sup>2</sup>S class D amplifier features a patented, ultra low EMI PWM architecture that significantly reduces RF emissions while preserving audio quality. The 42mW/channel headphone drivers feature TI's ground referenced architecture that creates a ground-referenced output from a single supply, eliminating the need for bulky and expensive DC-blocking capacitors, saving space and minimizing cost.

The LM49150 features a fully differential mono input, and two single-ended stereo inputs. The three inputs can be mixed/multiplexed to either the speaker or headphone amplifiers. Each input channel has an independent, 32-step digital volume control. The headphone output stage features an additional, 8-step gain control, while the speaker output stage has a selectable 6dB or 12dB gain. The mixer, volume control and device mode select are controlled through an I<sup>2</sup>C compatible serial interface.

The LM49150's superior click and pop suppression eliminates audible transients on power-up/down and during shutdown. The LM49150 is available in a ultra-small 20-bump DSBGA package (2.225mm X 2.644mm).



Please be aware that an important notice concerning availability, standard warranty, and use in critical applications of Texas Instruments semiconductor products and disclaimers thereto appears at the end of this data sheet.

PowerWise is a trademark of Texas Instruments.

All other trademarks are the property of their respective owners.



These devices have limited built-in ESD protection. The leads should be shorted together or the device placed in conductive foam during storage or handling to prevent electrostatic damage to the MOS gates.

Typical Application

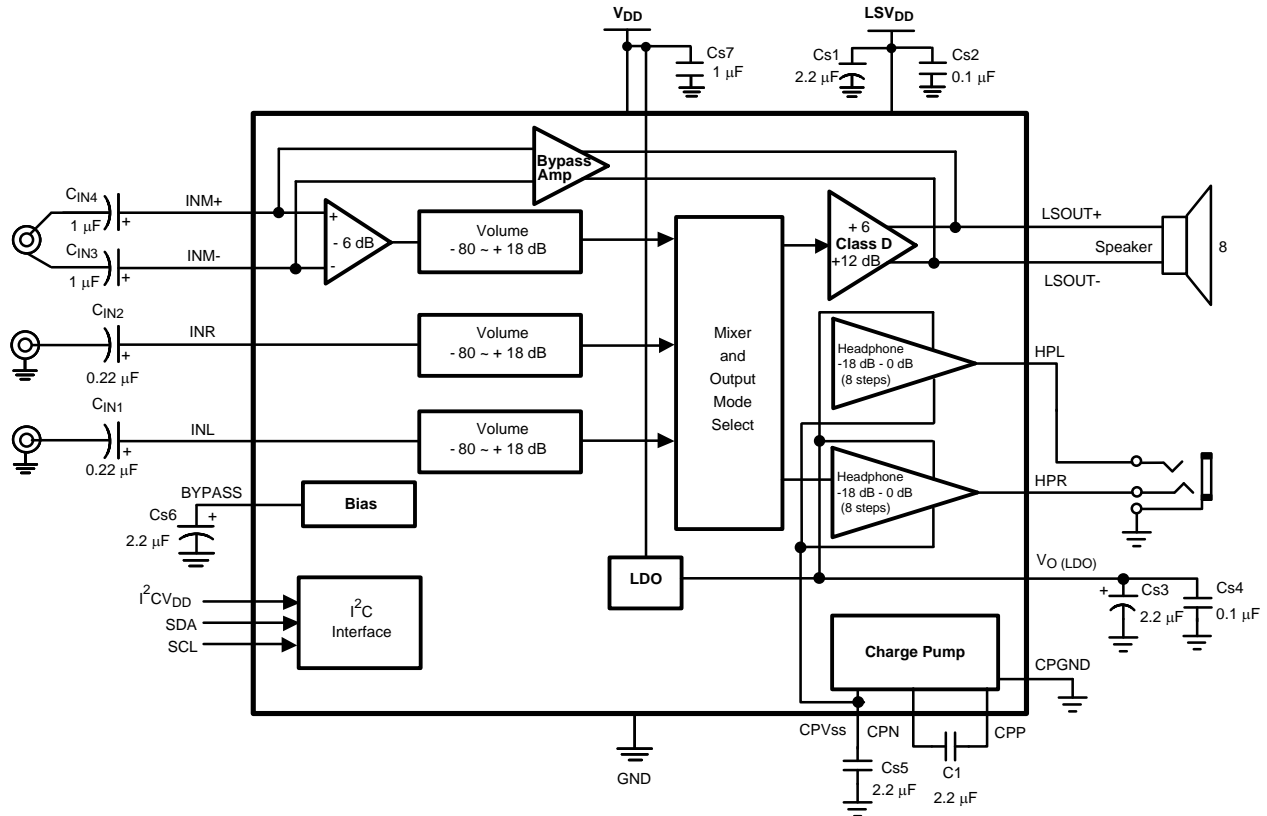
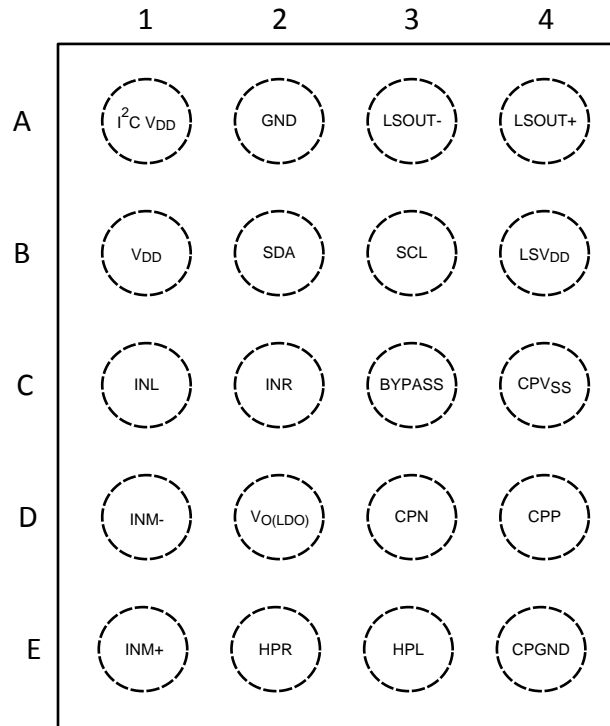

Figure 1. Typical Audio Amplifier Application Circuit-Output Capacitor-less

**Connection Diagram**

**Figure 2. 20 Bump DSBGA Package - Top View  
(Bump Side Down)  
See Package Number YZR0020KGA**

**BUMP DESCRIPTIONS**

Bump	Name	Description
A1	I <sup>2</sup> CV <sub>DD</sub>	I <sup>2</sup> C Power Supply
A2	GND	Ground
A3	LSOUT-	Inverting Loudspeaker Output
A4	LSOUT+	Non-Inverting Loudspeaker Output
B1	V <sub>DD</sub>	Analog Power Supply
B2	SDA	I <sup>2</sup> C Data Input
B3	SCL	I <sup>2</sup> C Clock Input
B4	LSV <sub>DD</sub>	Loudspeaker Power Supply
C1	INL	Left Channel Input
C2	INR	Right Channel Input
C3	BYPASS	Mid-Rail Supply Bypass
C4	CPV <sub>SS</sub>	Charge Pump Output
D1	INM-	Mono Channel Inverting Input
D2	V <sub>O(LDO)</sub>	Internal LDO Output
D3	CPN	Charge Pump Flying Capacitor - Negative Terminal
D4	CPP	Charge Pump Flying Capacitor - Positive Terminal
E1	INM+	Mono Channel Non-Inverting Input
E2	HPR	Right Channel Headphone Amplifier Output
E3	HPL	Left Channel Headphone Amplifier Output
E4	CPGND	Charge Pump Ground

**Absolute Maximum Ratings**<sup>(1)(2)(3)</sup>

Supply Voltage <sup>(1)</sup>		6.0V
Storage Temperature		–65°C to +150°C
Input Voltage		–0.3 to V <sub>DD</sub> +0.3
Power Dissipation <sup>(4)</sup>		Internally Limited
ESD Rating <sup>(5)</sup>		2.0kV
ESD Rating <sup>(6)</sup>		200V
Junction Temperature		150°C
Soldering Information	See AN-1112 “Micro SMD Wafer Level Chip Scale Package” (Literature Number <a href="#">SNVA009</a> )	
Thermal Resistance	$\theta_{JA}$ (typ) - YZR0020KGA	46.1°C/W

- (1) “*Absolute Maximum Ratings*” indicate limits beyond which damage to the device may occur, including inoperability and degradation of device reliability and/or performance. Functional operation of the device and/or non-degradation at the *Absolute Maximum Ratings* or other conditions beyond those indicated in the *Recommended Operating Conditions* is not implied. The *Recommended Operating Conditions* indicate conditions at which the device is functional and the device should not be operated beyond such conditions. All voltages are measured with respect to the ground pin, unless otherwise specified.
- (2) The *Electrical Characteristics* tables list ensured specifications under the listed *Recommended Operating Conditions* except as otherwise modified or specified by the *Electrical Characteristics Conditions* and/or Notes. Typical specifications are estimations only and are not ensured.
- (3) If Military/Aerospace specified devices are required, please contact the TI Sales Office/ Distributors for availability and specifications.
- (4) The maximum power dissipation must be derated at elevated temperatures and is dictated by T<sub>JMAX</sub>,  $\theta_{JA}$ , and the ambient temperature, T<sub>A</sub>. The maximum allowable power dissipation is P<sub>DMAX</sub> = (T<sub>JMAX</sub> - T<sub>A</sub>) /  $\theta_{JA}$  or the number given in *Absolute Maximum Ratings*, whichever.
- (5) Human body model, applicable std. JESD22-A114C.
- (6) Machine model, applicable std. JESD22-A115-A.

**Operating Ratings**

Temperature Range	–40°C to 85°C
Supply Voltage	2.7V ≤ V <sub>DD</sub> ≤ 5.5V
Supply Voltage (I <sup>2</sup> C)	1.7V ≤ I <sup>2</sup> CV <sub>DD</sub> ≤ 5.5V

**Electrical Characteristics 3.3V**<sup>(1)</sup>

The following specifications apply for V<sub>DD</sub> = LSV<sub>DD</sub> = 3.3V, A<sub>V</sub> = 0dB, Loudspeaker R<sub>L</sub> = 15μH+8Ω+15μH, Earpiece R<sub>L</sub> = 8Ω, f = 1kHz, unless otherwise specified. Limits apply for T<sub>A</sub> = 25°C. LS = Loudspeaker, HP = Headphone, EP = Earpiece.

Symbol	Parameter	Conditions	LM49150		Units (Limits)
			Typical <sup>(2)</sup>	Limits <sup>(3)</sup>	
I <sub>DD</sub>	Supply Current	V <sub>IN</sub> = 0, No Load			
		LS mode 1	3.7	5	mA (max)
		HP mode 8	4.7	6.7	mA (max)
		EP Bypass mode	0.8	1.2	mA (max)
		LS + HP mode 5 and mode 10	7	9.5	mA (max)
		LS mode 1, GAMP_SD = 1	3	4	mA (max)
		HP mode 8, GAMP_SD = 1	4.3	6.1	mA (max)
I <sub>SD</sub>	Shutdown Current		0.04	1	μA (max)
V <sub>OS</sub>	Output Offset Voltage	V <sub>IN</sub> = 0V, LS, R <sub>L</sub> = 8Ω LS Gain = 6dB, Stereo mode 10	9	40	mV (max)
		V <sub>IN</sub> = 0V, HP, R <sub>L</sub> = 32Ω Ground Referenced, Stereo mode 10	1	5	mV (max)
		V <sub>IN</sub> = 0V, EP Bypass only, R <sub>L</sub> = 8Ω	0.8	5	mV (max)

- (1) The *Electrical Characteristics* tables list ensured specifications under the listed *Recommended Operating Conditions* except as otherwise modified or specified by the *Electrical Characteristics Conditions* and/or Notes. Typical specifications are estimations only and are not ensured.
- (2) Typical values represent most likely parametric norms at T<sub>A</sub> = +25°C, and at the *Recommended Operation Conditions* at the time of product characterization and are not specified.
- (3) Datasheet min/max specification limits are ensured by test or statistical analysis.

**Electrical Characteristics 3.3V<sup>(1)</sup> (continued)**

The following specifications apply for  $V_{DD} = LSV_{DD} = 3.3V$ ,  $A_V = 0dB$ , Loudspeaker  $R_L = 15\mu H + 8\Omega + 15\mu H$ , Earpiece  $R_L = 8\Omega$ ,  $f = 1kHz$ , unless otherwise specified. Limits apply for  $T_A = 25C$ . LS = Loudspeaker, HP = Headphone, EP = Earpiece.

Symbol	Parameter	Conditions	LM49150		Units (Limits)
			Typical <sup>(2)</sup>	Limits <sup>(3)</sup>	
P <sub>O</sub>	Output Power	LS mode 1, THD+N = 1%, f = 1kHz LS Gain = 6dB, R <sub>L</sub> = 4Ω	845		mW
		LS mode 1, THD+N = 1%, f = 1kHz LS Gain = 6dB, R <sub>L</sub> = 8Ω	520	450	mW (min)
		HP mode 8, THD+N = 1%, f = 1kHz HP Attenuation = 0dB, R <sub>L</sub> = 16Ω	42		mW
		HP mode 8, THD+N = 1%, f = 1kHz HP Attenuation = 0dB, R <sub>L</sub> = 32Ω	43	39	mW (min)
		EP Bypass only, THD+N = 1%, f = 1kHz R <sub>L</sub> = 8Ω	35	28	mW (min)
THD+N	Total Harmonic Distortion + Noise	LS mode 1, f = 1kHz P <sub>OUT</sub> = 250mW; R <sub>L</sub> = 8Ω	0.02		%
		HP mode 8, f = 1kHz P <sub>OUT</sub> = 20mW; R <sub>L</sub> = 32Ω	0.009		%
		EP Bypass only, f = 1kHz P <sub>OUT</sub> = 20mW; R <sub>L</sub> = 8Ω	0.15		%
η	Efficiency	LS output	88		%
ε <sub>OUT</sub>	Output Noise	A-weighted, inputs terminated to AC GND, Output referred			
		EP Bypass	11		μV
		LS; Mode 1	41		μV
		LS; Mode 2	41		μV
		LS; Mode 3	43		μV
		HP; Mode 4	9		μV
		HP; Mode 8	10		μV
		HP; Mode 12	12		μV
PSRR	Power Supply Rejection Ratio	V <sub>RIPPLE</sub> = 200mV <sub>PP</sub> ; f = 217Hz, R <sub>L</sub> = 8Ω, C <sub>B</sub> = 2.2μF, All audio inputs terminated to AC GND, output referred			
		EP Bypass	95		dB
		Loudspeaker Output; LS Gain = 6dB			
		LS; Mode 1	72		dB
		LS; Mode 2	67		dB
		LS; Mode 3	71		dB
		Headphone Output, HP Attenuation = 0dB			
		HP; Mode 4	91		dB
		HP; Mode 8	83		dB
		HP; Mode 12	81		dB
	Volume Control Step Size Error		±0.2		dB
	Digital Volume Control Range	Maximum Attenuation	-92		dB
		Volume Step 2	-46.5	-49 -44	dB (min) dB (max)
		Maximum Gain	18	17 19	dB (min) dB (max)
A <sub>M</sub>	Mute Attenuation	HP	98		dB
		LS	98		dB

### Electrical Characteristics 3.3V<sup>(1)</sup> (continued)

The following specifications apply for  $V_{DD} = LSV_{DD} = 3.3V$ ,  $A_V = 0dB$ , Loudspeaker  $R_L = 15\mu H + 8\Omega + 15\mu H$ , Earpiece  $R_L = 8\Omega$ ,  $f = 1kHz$ , unless otherwise specified. Limits apply for  $T_A = 25C$ . LS = Loudspeaker, HP = Headphone, EP = Earpiece.

Symbol	Parameter	Conditions	LM49150		Units (Limits)
			Typical <sup>(2)</sup>	Limits <sup>(3)</sup>	
$Z_{IN}$	Mono Channel Input Impedance $L_{IN}$ and $R_{IN}$ Input Impedance	Maximum gain setting	12.9	10 15	k $\Omega$ (min) k $\Omega$ (max)
		Maximum attenuation setting	111	90 130	k $\Omega$ (min) k $\Omega$ (max)
	EP Bypass Resistance		62	50 80	k $\Omega$ (min) k $\Omega$ (max)
CMRR	Common-Mode Rejection Ratio	$f = 217Hz$ , $V_{CM} = 1V_{P-P}$ , $R_L = 8\Omega$ EP Bypass	55		dB
		$f = 217Hz$ , $V_{CM} = 1V_{P-P}$ , $R_L = 8\Omega$ LS, Mode 1	55		dB
		$f = 217Hz$ , $V_{CM} = 1V_{P-P}$ , $R_L = 32\Omega$ HP, Mode 4	61		dB
$X_{TALK}$	Crosstalk	HP mode 8; $P_O = 12mW$ $R_L = 32\Omega$ , $f = 1kHz$	78		dB
$T_{ON}$	Turn-On Time	$C_B = 2.2\mu F$ , HP, Normal Turn-On Mode	27		ms
		$C_B = 2.2\mu F$ , HP, Fast Turn-On Mode	15		ms

### Electrical Characteristics 5.0V<sup>(1)(2)</sup>

The following specifications apply for  $V_{DD} = LSV_{DD} = 5.0V$ ,  $A_V = 0dB$ , Loudspeaker  $R_L = 15\mu H + 8\Omega + 15\mu H$ , Earpiece  $R_L = 8\Omega$ ,  $f = 1kHz$ , unless otherwise specified. Limits apply for  $T_A = 25C$ . LS = Loudspeaker, HP = Headphone, EP = Earpiece.

Symbol	Parameter	Conditions	LM49150		Units (Limits)
			Typical <sup>(3)</sup>	Limits <sup>(2)</sup>	
$I_{DD}$	Supply Current	$V_{IN} = 0$ , No Load			
		LS mode 1	4.5		mA
		HP mode 8	4.9		mA
		EP Bypass Mode	0.9		mA
		LS + HP Mode 5 and Mode 10	7.7		mA
		LS Mode 1, $GAMP\_SD = 1$	3.7		mA
		HP Mode 8, $GAMP\_SD = 1$	4.4		mA
$I_{SD}$	Shutdown Current		0.02	1	$\mu A$ (max)
$V_{OS}$	Output Offset Voltage	$V_{IN} = 0V$ , LS, $R_L = 8\Omega$ LS Gain = 6dB, Stereo Mode 10	9	40	mV (max)
		$V_{IN} = 0V$ , HP, $R_L = 32\Omega$ Ground Reference, Stereo Mode 10	1	5	mV (max)
		$V_{IN} = 0V$ , EP Bypass only, $R_L = 8\Omega$	1	5	mV (max)

- (1) The *Electrical Characteristics* tables list ensured specifications under the listed *Recommended Operating Conditions* except as otherwise modified or specified by the *Electrical Characteristics Conditions* and/or Notes. Typical specifications are estimations only and are not ensured.
- (2) Datasheet min/max specification limits are ensured by test or statistical analysis.
- (3) Typical values represent most likely parametric norms at  $T_A = +25^\circ C$ , and at the *Recommended Operation Conditions* at the time of product characterization and are not specified.

**Electrical Characteristics 5.0V<sup>(1)(2)</sup> (continued)**

The following specifications apply for  $V_{DD} = LSV_{DD} = 5.0V$ ,  $A_V = 0dB$ , Loudspeaker  $R_L = 15\mu H + 8\Omega + 15\mu H$ , Earpiece  $R_L = 8\Omega$ ,  $f = 1kHz$ , unless otherwise specified. Limits apply for  $T_A = 25C$ . LS = Loudspeaker, HP = Headphone, EP = Earpiece.

Symbol	Parameter	Conditions	LM49150		Units (Limits)
			Typical <sup>(3)</sup>	Limits <sup>(2)</sup>	
P <sub>O</sub>	Output Power	LS Mode 1, THD+N = 1%, f = 1kHz LS Gain = 6dB, R <sub>L</sub> = 4Ω	2.1		W
		LS Mode 1, THD+N = 1%, f = 1kHz LS Gain = 6dB, R <sub>L</sub> = 8Ω	1.25		W
		HP Mode 8, THD+N = 1%, f = 1kHz HP Attenuation = 0dB, R <sub>L</sub> = 16Ω	42		mW
		HP Mode 8, THD+N = 1%, f = 1kHz HP Attenuation = 0dB, R <sub>L</sub> = 32Ω	42		mW
		EP Bypass Only, THD+N = 1% f = 1kHz, R <sub>L</sub> = 8Ω	135		mW
THD+N	Total Harmonic Distortion + Noise	LS Mode 1, f = 1kHz P <sub>OUT</sub> = 600mW; R <sub>L</sub> = 8Ω	0.015		%
		HP Mode 8, f = 1kHz P <sub>OUT</sub> = 20mW; R <sub>L</sub> = 32Ω	0.01		%
		EP Bypass only, f = 1kHz, P <sub>OUT</sub> = 60mW; R <sub>L</sub> = 8Ω	0.08		%
η	Efficiency	LS Output	88		%
ε <sub>OUT</sub>	Output Noise	A-weighted, inputs terminated to AC GND, Output referred			
		EP Bypass	10		μV
		LS; Mode 1	40		μV
		LS; Mode 2	47		μV
		LS; Mode 3	48		μV
		HP; Mode 4	9		μV
		HP; Mode 8	10		μV
		HP; Mode 12	11		μV
PSRR	Power Supply Rejection Ratio	V <sub>RIPPLE</sub> = 200mV <sub>PP</sub> ; f = 217Hz, R <sub>L</sub> = 8Ω, C <sub>B</sub> = 2.2μF, All audio inputs terminated to AC GND; output referred			
		EP Bypass	97		dB
		Loudspeaker Output; LS Gain = 6dB			
		LS; Mode 1	75		dB
		LS; Mode 2	71		dB
		LS; Mode 3	71		dB
		Headphone Output, HP Attenuation = 0dB			
		HP; Mode 4	91		dB
		HP; Mode 8	80		dB
		HP; Mode 12	79		dB
	Volume Control Step Size Error		±0.2		dB
	Digital Volume Control Range	Maximum Attenuation	-92		dB
		Volume Step 2	-46.5	-49 -44	dB (min) dB (max)
		Maximum Gain	18	17 19	dB (min) dB (max)
A <sub>M</sub>	Mute Attenuation	HP	98		dB
		LS	98		dB
Z <sub>IN</sub>	Mono Channel Input Impedance L <sub>IN</sub> and R <sub>IN</sub> Input Impedance	Maximum gain setting	12		kΩ
		Maximum attenuation setting	111		kΩ
	EP Bypass Resistance		62	50 80	kΩ (min) kΩ (max)

### Electrical Characteristics 5.0V<sup>(1)(2)</sup> (continued)

The following specifications apply for  $V_{DD} = LSV_{DD} = 5.0V$ ,  $A_V = 0dB$ , Loudspeaker  $R_L = 15\mu H + 8\Omega + 15\mu H$ , Earpiece  $R_L = 8\Omega$ ,  $f = 1kHz$ , unless otherwise specified. Limits apply for  $T_A = 25C$ . LS = Loudspeaker, HP = Headphone, EP = Earpiece.

Symbol	Parameter	Conditions	LM49150		Units (Limits)
			Typical <sup>(3)</sup>	Limits <sup>(2)</sup>	
CMRR	Common-Mode Rejection Ratio	$f = 217Hz$ , $V_{CM} = 1V_{P-P}$ , $R_L = 8\Omega$ EP Bypass	55		dB
		$f = 217Hz$ , $V_{CM} = 1V_{P-P}$ , $R_L = 8\Omega$ LS, Mode 1	55		dB
		$f = 217Hz$ , $V_{CM} = 1V_{P-P}$ , $R_L = 32\Omega$ HP, Mode 4	61		dB
$X_{TALK}$	Crosstalk	HP mode 8; $P_O = 12mW$ $R_L = 32\Omega$ , $f = 1kHz$	78		dB
$T_{ON}$	Turn-On Time	$C_B = 2.2\mu F$ , HP, Normal Turn-On Mode	27		ms
		$C_B = 2.2\mu F$ , HP, Fast Turn-On Mode	15		ms

### I<sup>2</sup>C micro<sup>(1)</sup>

The following specifications apply for  $V_{DD} = 5.0V$  and  $3.3V$ ,  $T_A = 25^\circ C$ ,  $2.2V \leq I^2C_{V_{DD}} \leq 5.5V$ , unless otherwise specified.

Symbol	Parameter	Conditions	LM49150		Units (Limits)
			Typical <sup>(2)</sup>	Limits <sup>(3)(4)</sup>	
$t_1$	I <sup>2</sup> C Clock Period			2.5	$\mu s$ (min)
$t_2$	I <sup>2</sup> C Data Setup Time			100	ns (min)
$t_3$	I <sup>2</sup> C Data Stable Time			0	ns (min)
$t_4$	Start Condition Time			100	ns (min)
$t_5$	Stop Condition Time			100	ns (min)
$t_6$	I <sup>2</sup> C Data Hold Time			100	ns (min)
$V_{IH}$	I <sup>2</sup> C Input Voltage High			$0.7 \times I^2C_{V_{DD}}$	V (min)
$V_{IL}$	I <sup>2</sup> C Input Voltage Low			$0.3 \times I^2C_{V_{DD}}$	V (max)

- (1) The *Electrical Characteristics* tables list ensured specifications under the listed *Recommended Operating Conditions* except as otherwise modified or specified by the *Electrical Characteristics Conditions* and/or Notes. Typical specifications are estimations only and are not ensured.
- (2) Human body model, applicable std. JESD22-A114C.
- (3) Datasheet min/max specification limits are ensured by test or statistical analysis.
- (4) Machine model, applicable std. JESD22-A115-A.



**I<sup>2</sup>C micro<sup>(1)</sup>**

The following specifications apply for  $V_{DD} = 5.0V$  and  $3.3V$ ,  $T_A = 25^\circ C$ ,  $1.7V \leq I^2C_{-}V_{DD} \leq 2.2V$ , unless otherwise specified.

Symbol	Parameter	Conditions	LM49150		Units (Limits)
			Typical <sup>(2)</sup>	Limits <sup>(3)</sup>	
$t_1$	I <sup>2</sup> C Clock Period			2.5	$\mu s$ (min)
$t_2$	I <sup>2</sup> C Data Setup Time			250	ns (min)
$t_3$	I <sup>2</sup> C Data Stable Time			0	ns (min)
$t_4$	Start Condition Time			250	ns (min)
$t_5$	Stop Condition Time			250	ns (min)
$t_6$	I <sup>2</sup> C Data Hold Time			250	ns (min)
$V_{IH}$	I <sup>2</sup> C Input Voltage High			$0.7 \times I^2C_{-}V_{DD}$	V (min)
$V_{IL}$	I <sup>2</sup> C Input Voltage Low			$0.3 \times I^2C_{-}V_{DD}$	V (max)

- (1) The *Electrical Characteristics* tables list ensured specifications under the listed *Recommended Operating Conditions* except as otherwise modified or specified by the *Electrical Characteristics Conditions* and/or Notes. Typical specifications are estimations only and are not ensured.
- (2) Typical values represent most likely parametric norms at  $T_A = +25^\circ C$ , and at the *Recommended Operation Conditions* at the time of product characterization and are not specified.
- (3) Datasheet min/max specification limits are ensured by test or statistical analysis.

Typical Performance Characteristics

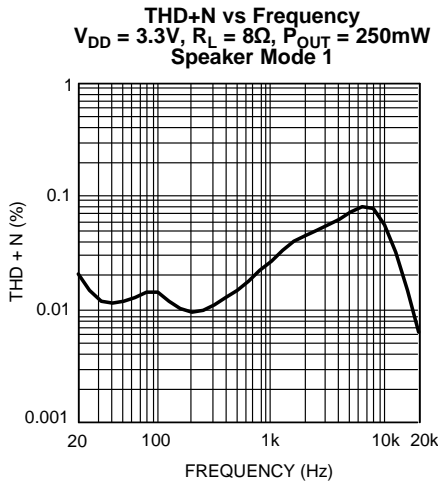

Figure 3.

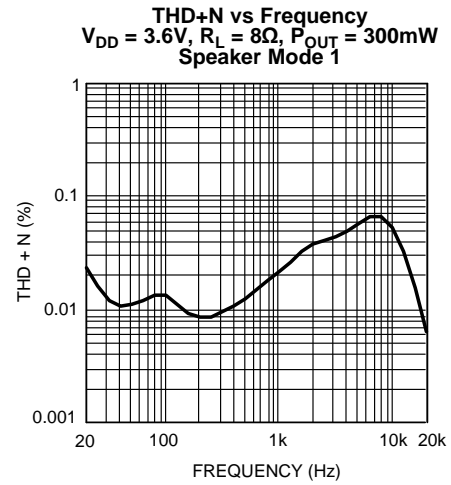

Figure 4.

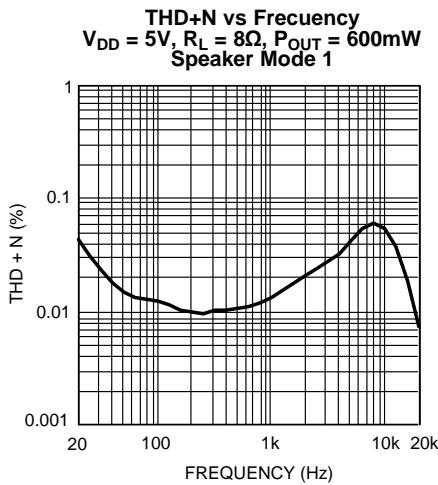

Figure 5.

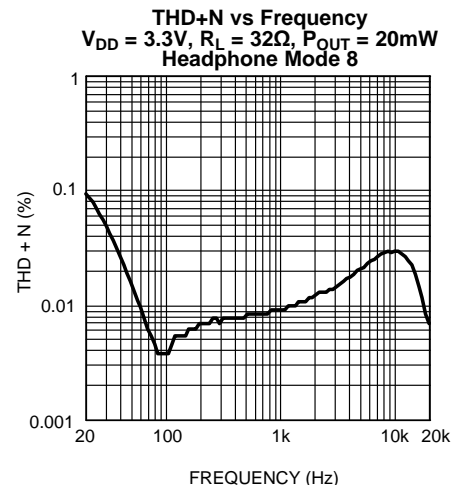

Figure 6.

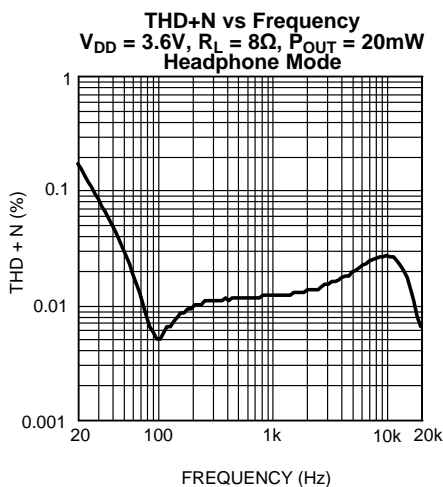

Figure 7.

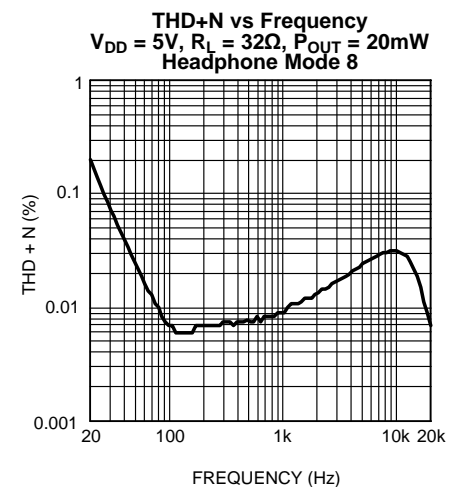

Figure 8.

Typical Performance Characteristics (continued)

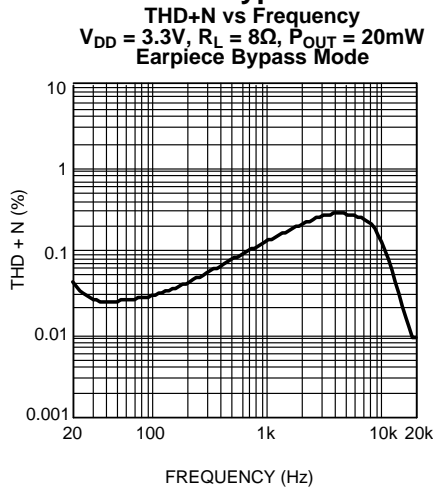

Figure 9.

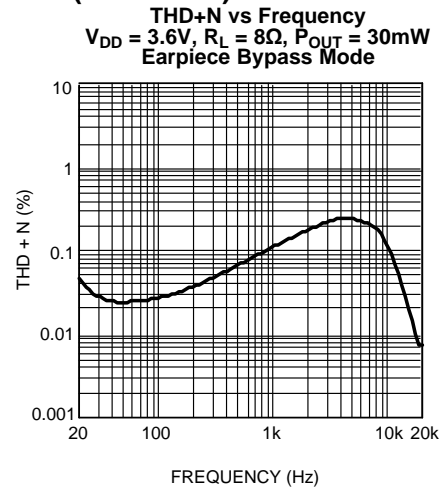

Figure 10.

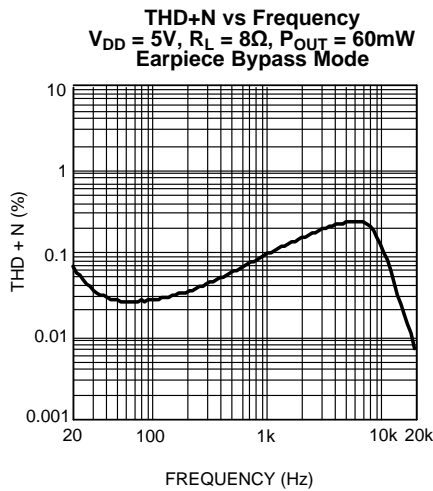

Figure 11.

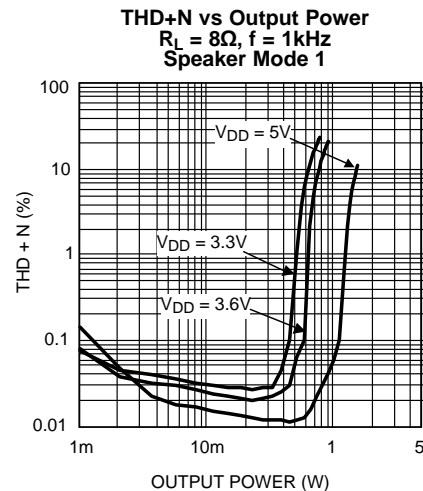

Figure 12.

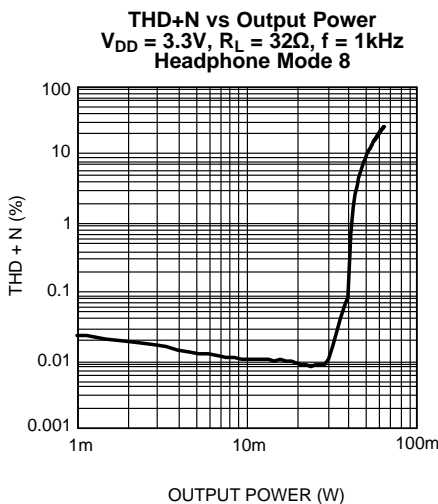

Figure 13.

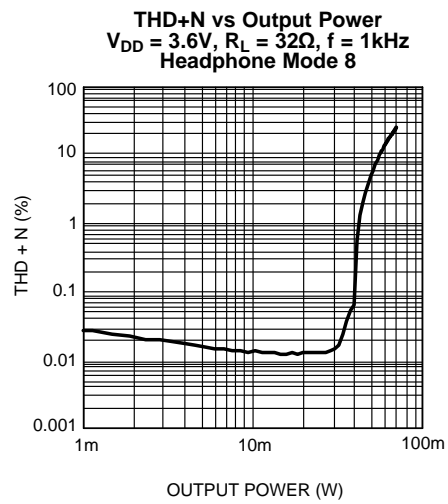

Figure 14.

**Typical Performance Characteristics (continued)**

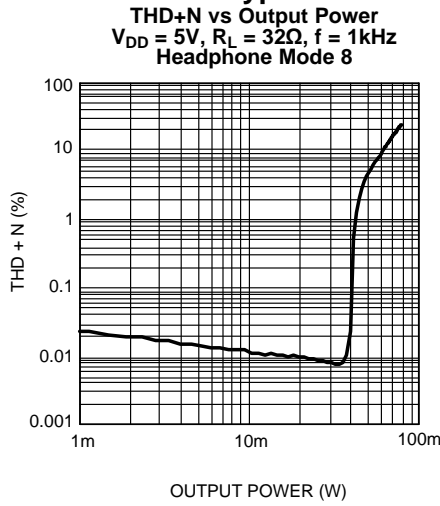

Figure 15.

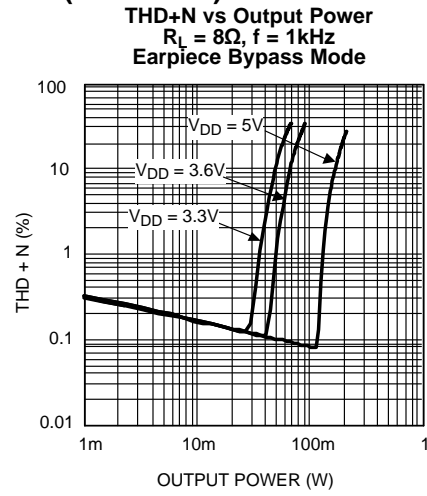

Figure 16.

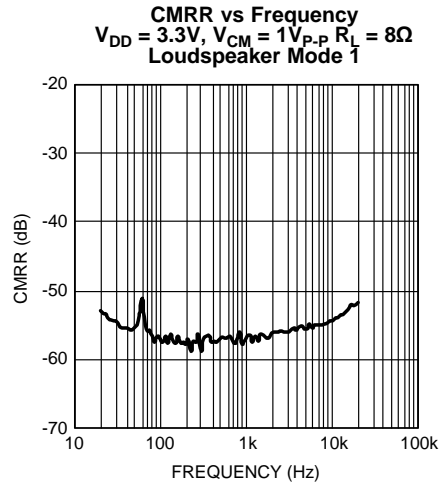

Figure 17.

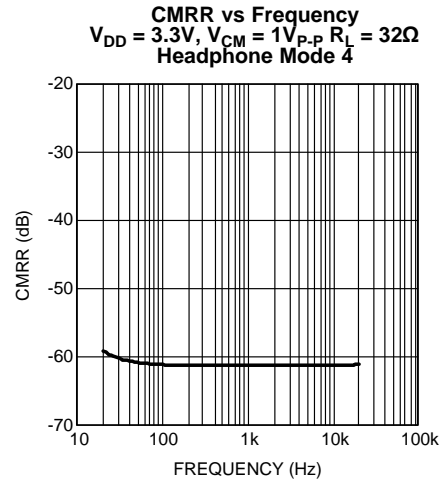

Figure 18.

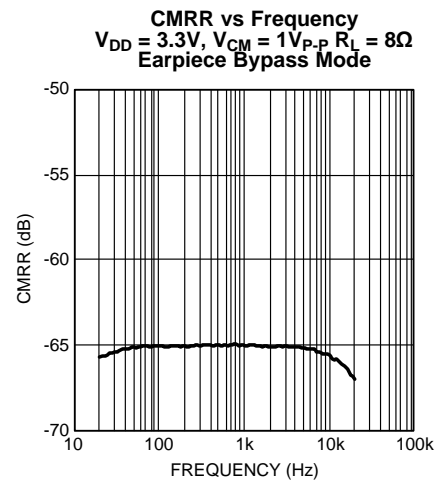

Figure 19.

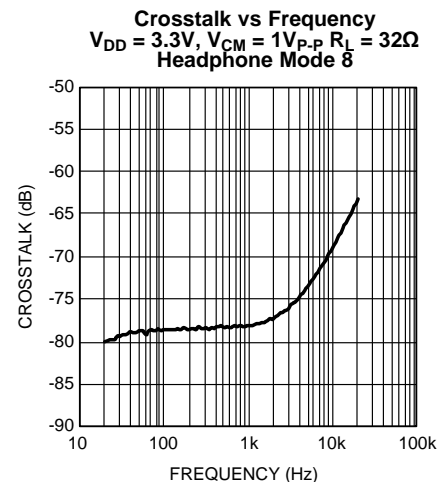

Figure 20.

**Typical Performance Characteristics (continued)**

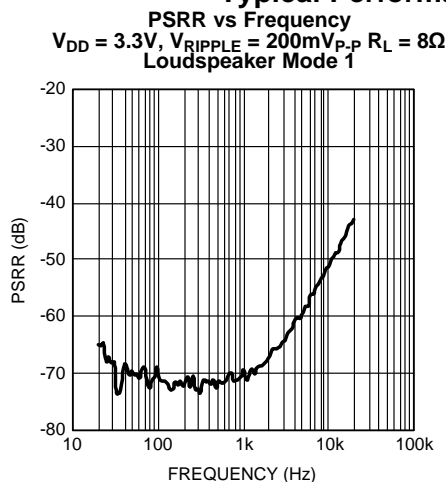

Figure 21.

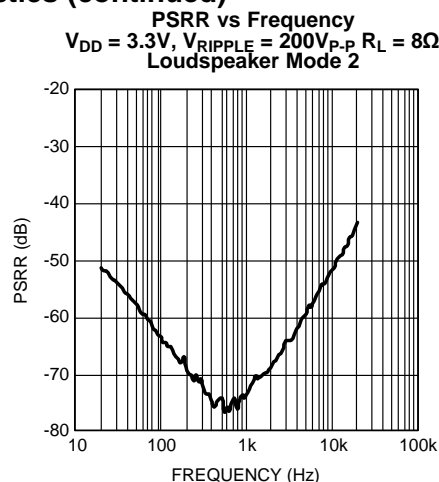

Figure 22.

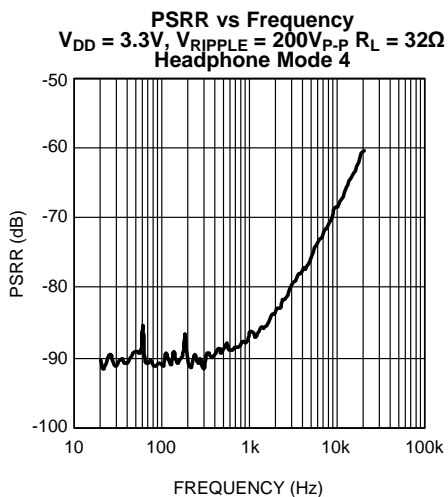

Figure 23.

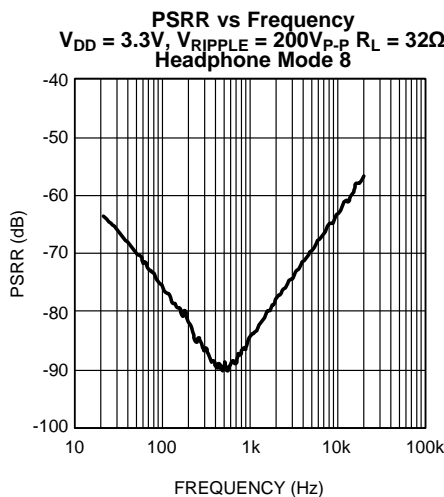

Figure 24.

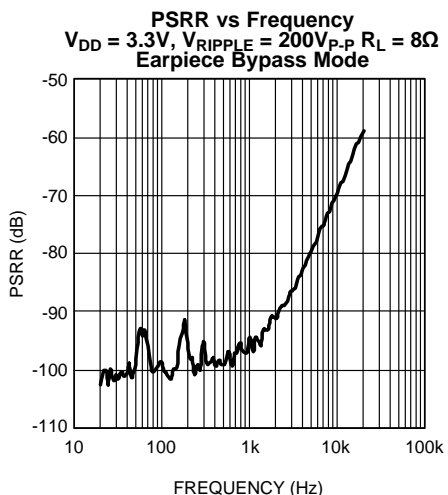

Figure 25.

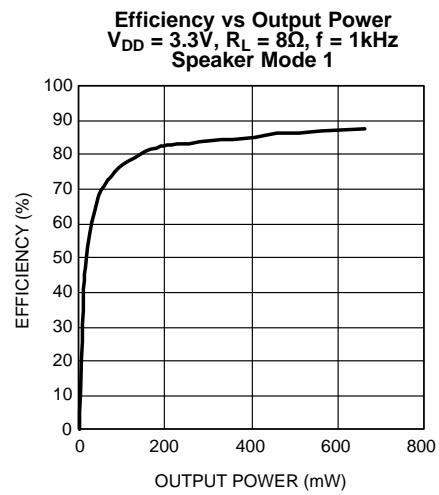

Figure 26.

Typical Performance Characteristics (continued)

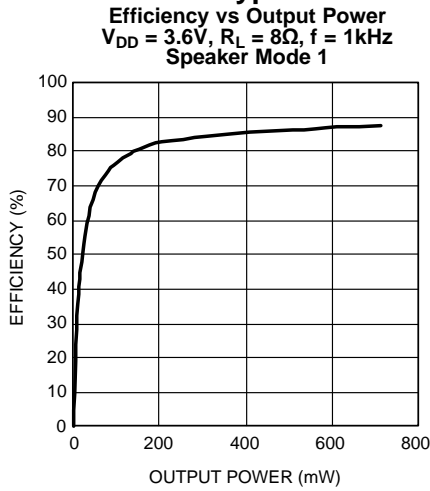

Figure 27.

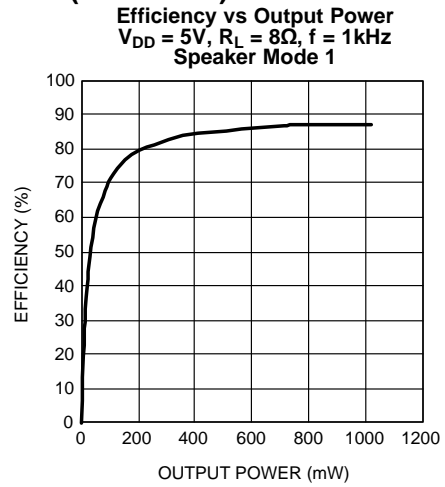

Figure 28.

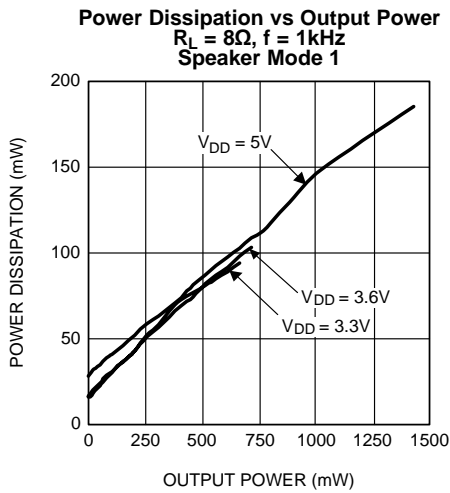

Figure 29.

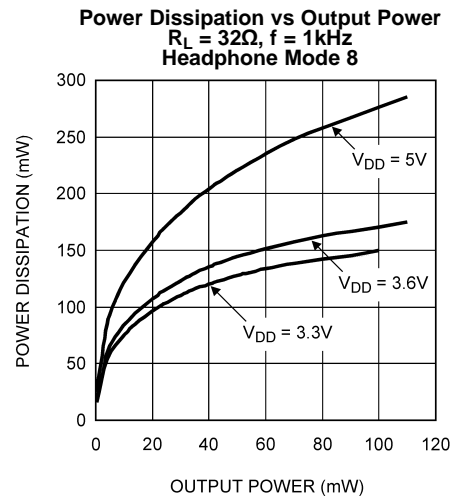

Figure 30.

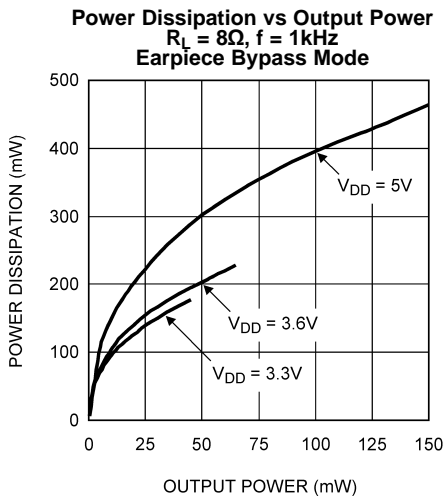

Figure 31.

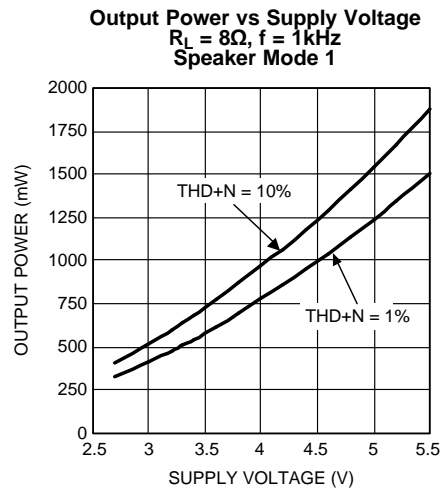

Figure 32.

Typical Performance Characteristics (continued)

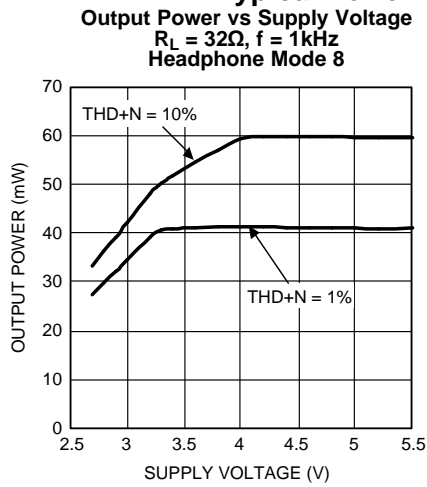

Figure 33.

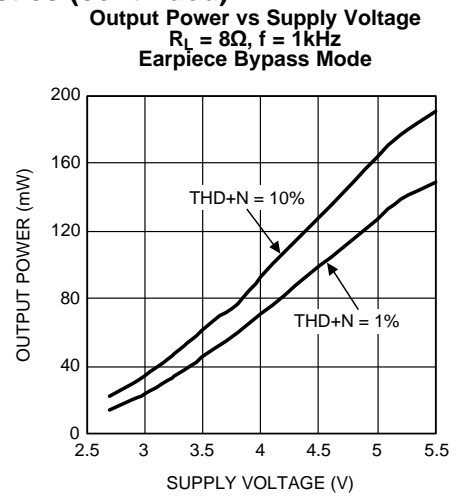

Figure 34.

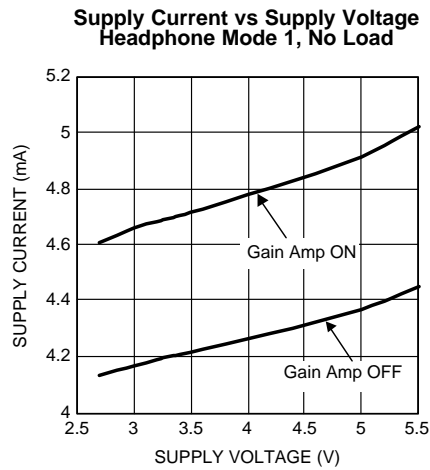

Figure 35.

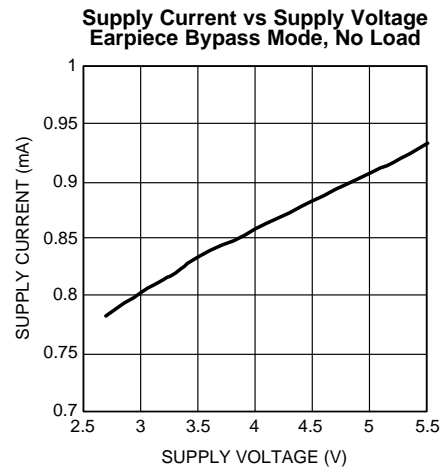

Figure 36.

## APPLICATION INFORMATION

### I<sup>2</sup>C COMPATIBLE INTERFACE

The LM49150 is controlled through an I<sup>2</sup>C compatible serial interface that consists of a serial data line (SDA) and a serial clock (SCL). The clock line is uni-directional. The data line is bi-directional (open drain). The LM49150 and the master can communicate at clock rates up to 400kHz. Figure 37 shows the I<sup>2</sup>C interface timing diagram. Data on the SDA line must be stable during the HIGH period of SCL. The LM49150 is a transmit/receive slave-only device, reliant upon the master to generate the SCL signal. Each transmission sequence is framed by a START condition and a STOP condition (Figure 38). Each data word, device address and data, transmitted over the bus is 8 bits long and is always followed by an acknowledge pulse (Figure 39). The LM49150 device address is 11111000.

### I<sup>2</sup>C INTERFACE POWER SUPPLY PIN (I<sup>2</sup>CV<sub>DD</sub>)

The LM49150's I<sup>2</sup>C interface is powered up through the I<sup>2</sup>CV<sub>DD</sub> pin. The LM49150's I<sup>2</sup>C interface operates at a voltage level set by the I<sup>2</sup>CV<sub>DD</sub> pin which can be set independent to that of the main power supply pin V<sub>DD</sub>. This is ideal whenever logic levels for the I<sup>2</sup>C interface are dictated by a microcontroller or microprocessor that is operating at a lower supply voltage than the main battery of a portable system.

### I<sup>2</sup>C BUS FORMAT

The I<sup>2</sup>C bus format is shown in Figure 39. The START signal, the transition of SDA from HIGH to LOW while SCL is HIGH, is generated, alerting all devices on the bus that a device address is being written to the bus.

The 7-bit device address is written to the bus, most significant bit (MSB) first, followed by the R/W bit. R/W = 0 indicates the master is writing to the slave device, R/W = 1 indicates the master wants to read data from the slave device. Set R/W = 0; the LM49150 is a WRITE-ONLY device and will not respond to the R/W = 1. The data is latched in on the rising edge of the clock. Each address bit must be stable while SCL is HIGH. After the last address bit is transmitted, the master device releases SDA, during which time, an acknowledge clock pulse is generated by the slave device. If the LM49150 receives the correct address, the device pulls the SDA line low, generating an acknowledge bit (ACK).

Once the master device registers the ACK bit, the 8-bit register data word is sent. Each data bit should be stable while SCL is HIGH. After the 8-bit register data word is sent, the LM49150 sends another ACK bit. Following the acknowledgement of the register data word, the master issues a STOP bit, allowing SDA to go high while SCL is high.

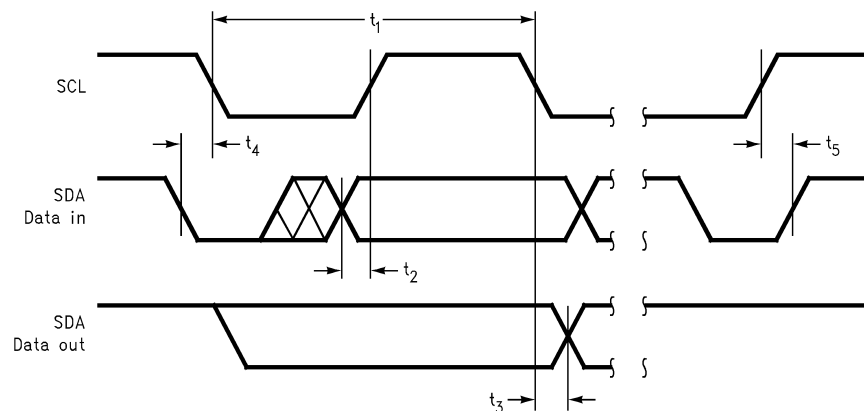

Figure 37. I<sup>2</sup>C Timing Diagram



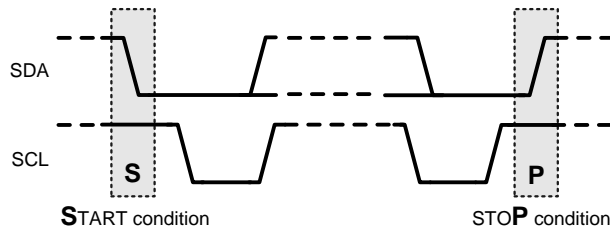

Figure 38. Start and Stop Diagram

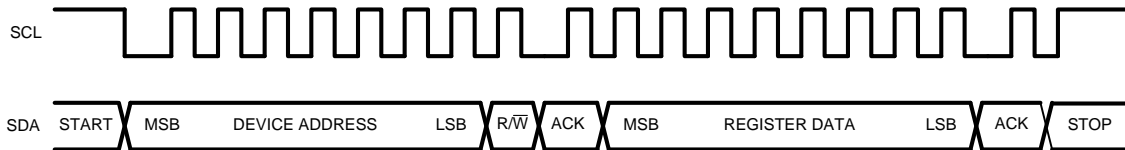

Figure 39. Start and Stop Diagram

Table 1. Chip Address

	<b>B7</b>	<b>B6</b>	<b>B5</b>	<b>B4</b>	<b>B3</b>	<b>B2</b>	<b>B1</b>	<b>B0 (R/<math>\bar{W}</math>)</b>
Chip Address	1	1	1	1	1	0	0	0

Table 2. Control Registers

	<b>B7</b>	<b>B6</b>	<b>B5</b>	<b>B4</b>	<b>B3</b>	<b>B2</b>	<b>B1</b>	<b>B0</b>
Shutdown Control	0	0	Spread Spectrum	GAMP_SD	0	$I^2CV_{DD\_SD}$	Turn_On_Time	PWR_On
Output Mode Control	0	1	EP Bypass	HPR_SD	MC3 (HP L&R)	MC2 (HP Mono)	MC1 (LS L&R)	MC0 (LS Mono)
Output Gain Control	1	0	0	INPUT_MUTE	LS_GAIN	HP_GAIN2	HP_GAIN1	HP_GAIN0
Mono Input Volume Control	1	0	1	MG4	MG3	MG2	MG1	MG0
Left Input Volume Control	1	1	0	LG4	LG3	LG2	LG1	LG0
Right Input Volume Control	1	1	1	RG4	RG3	RG2	RG1	RG0

Table 3. Shutdown Control Register

Bit	Name	Value	Description
B5	Spread Spectrum	0	Spread Spectrum Disabled
		1	Spread Spectrum Enabled
B4	GAMP_SD	0	Normal Operation
		1	Disables the gain amplifiers that are not in use, to minimize $I_{DD}$ . Recommended for Output Modes 1, 2, 4, 5, 8, 10
B3	$I^2CV_{DD\_SD}$	0	$I^2CV_{DD}$ acts as an active low RESET input. If $I^2CV_{DD}$ drops below 1.1V, the device resets and the $I^2C$ registers are restored to their default state.
		1	Normal Operation. $I^2CV_{DD}$ voltage does not reset the device.
B1	Turn_On_Time	0	Normal Turn-On Time (27ms)
		1	Fast Turn-On Time (15ms)
B0	PWR_On	0	Device Disabled
		1	Device Enabled

**Table 4. Output Mode Control Register**

Bit	Name	Value	Description
B5	EP Bypass	0	Normal Output Mode Operation
		1	Speaker and Headphone amplifier goes into shutdown mode and enables Receiver Bypass path
B4	HPR_SD	0	Normal Operation
		1	Disables Right Headphone Output

**Table 5. Output Mode Selection (See<sup>(1)</sup>)**

Output Mode Number	MC3	MC2	MC1	MC0	LS Output	HP R Output	HP L Output
0	0	0	0	0	SD	SD	SD
1	0	0	0	1	$G_P \times M$	SD	SD
2	0	0	1	0	$2 \times (G_L \times L + G_R \times R)$	SD	SD
3	0	0	1	1	$2 \times (G_L \times L + G_R \times R) + G_P \times M$	SD	SD
4	0	1	0	0	SD	$G_P \times M/2$	$G_P \times M/2$
5	0	1	0	1	$G_P \times M$	$G_P \times M/2$	$G_P \times M/2$
6	0	1	1	0	$2 \times (G_L \times L + G_R \times R)$	$G_P \times M/2$	$G_P \times M/2$
7	0	1	1	1	$2 \times (G_L \times L + G_R \times R) + G_P \times M$	$G_P \times M/2$	$G_P \times M/2$
8	1	0	0	0	SD	$G_R \times R$	$G_L \times L$
9	1	0	0	1	$G_P \times M$	$G_R \times R$	$G_L \times L$
10	1	0	1	0	$2 \times (G_L \times L + G_R \times R)$	$G_R \times R$	$G_L \times L$
11	1	0	1	1	$2 \times (G_L \times L + G_R \times R) + G_P \times M$	$G_R \times R$	$G_L \times L$
12	1	1	0	0	SD	$G_R \times R + G_P \times M/2$	$G_L \times L + G_P \times M/2$
13	1	1	0	1	$G_P \times M$	$G_R \times R + G_P \times M/2$	$G_L \times L + G_P \times M/2$
14	1	1	1	0	$2 \times (G_L \times L + G_R \times R)$	$G_R \times R + G_P \times M/2$	$G_L \times L + G_P \times M/2$
15	1	1	1	1	$2 \times (G_L \times L + G_R \times R) + G_P \times M$	$G_R \times R + G_P \times M/2$	$G_L \times L + G_P \times M/2$

- (1) MC3: HP Select L and R In  
 MC2: HP Select Mono In  
 MC1: Loud Speaker Select L and R In  
 MC0: Loud Speaker Select Mono In  
 M : Phone In (Mono)  
 R: Right In  
 L: Left In  
 SD: Shutdown  
 $G_P$ : Phone In (Mono) Volume Control Gain  
 $G_R$ : Right Stereo Volume Control Gain  
 $G_L$ : Left Stereo Volume Control Gain

MC1	MC0	LSOUT
0	0	SD
0	1	M
1	0	L+R
1	1	M+L+R

MC3	MC2	HPR Output	HPL Output
0	0	SD	SD
0	1	M	M
1	0	L	R
1	1	M+L	M+R

**Table 6. Output Gain Control (Loudspeaker)**

Bit	Value	Gain (dB)
LS_GAIN	0	+6
	1	+12

**Table 7. Headphone Output Gain Setting**

HP_Gain2	HP_Gain1	HP_Gain0	Gain (dB)
0	0	0	0
0	0	1	-1.2
0	1	0	-2.5
0	1	1	-4.0
1	0	0	-6.0
1	0	1	-8.5
1	1	0	-12
1	1	1	-18

**Table 8. Volume Control Table**

Volume Step	xG4 <sup>(1)</sup>	xG3	xG2	xG1	xG0	Gain (dB) <sup>(2)</sup>
1	0	0	0	0	0	-80.00
2	0	0	0	0	1	-46.50
3	0	0	0	1	0	-40.50
4	0	0	0	1	1	-34.50
5	0	0	1	0	0	-30.00
6	0	0	1	0	1	-27.00
7	0	0	1	1	0	-24.00
8	0	0	1	1	1	-21.00
9	0	1	0	0	0	-18.00
10	0	1	0	0	1	-15.00
11	0	1	0	1	0	-13.50
12	0	1	0	1	1	-12.00
13	0	1	1	0	0	-10.50
14	0	1	1	0	1	-9.00
15	0	1	1	1	0	-7.50
16	0	1	1	1	1	-6.00
17	1	0	0	0	0	-4.50
18	1	0	0	0	1	-3.00
19	1	0	0	1	0	-1.50
20	1	0	0	1	1	0.00
21	1	0	1	0	0	1.50
22	1	0	1	0	1	3.00
23	1	0	1	1	0	4.50
24	1	0	1	1	1	6.00
25	1	1	0	0	0	7.50
26	1	1	0	0	1	9.00
27	1	1	0	1	0	10.50
28	1	1	0	1	1	12.00
29	1	1	1	0	0	13.50

(1) x = M, L and R

(2) Gain / Attenuation is from input to output

**Table 8. Volume Control Table (continued)**

Volume Step	xG4 <sup>(1)</sup>	xG3	xG2	xG1	xG0	Gain (dB) <sup>(2)</sup>
30	1	1	1	0	1	15.00
31	1	1	1	1	0	16.50
32	1	1	1	1	1	18.00

## SHUTDOWN FUNCTION

The LM49150 features the following shutdown controls.

Bit B4 (GAMP\_SD) of the SHUTDOWN CONTROL register controls the gain amplifiers. When GAMP\_SD = 1, it disables the gain amplifiers that are not in use. For example, in Modes 1, 4 and 5, the Mono inputs are in use, so the Left and Right input gain amplifiers are disabled, causing the I<sub>DD</sub> to be minimized.

Bit B0 (PWR\_On) of the SHUTDOWN CONTROL register is the global shutdown control for the entire device. Set PWR\_On = 0 for normal operation. PWR\_On = 1 overrides any other shutdown control bit.

## OUTPUT MODE CONTROL

In the LM49150 OUTPUT MODE CONTROL register (Table 4), Bit B5 (EP Bypass) controls the operation of the Earpiece Bypass path. If EP Bypass = 0, it would act under normal output mode operation set by bits B3, B2, B1, and B0. If EP Bypass = 1, it overrides the B3, B2, B1, and B0 Bits and enables the Receiver Bypass path, a class AB amplifier, to the speaker output.

Bit B4 (HPR\_SD) of the OUPUT MODE CONTROL register controls the right headphone shutdown. If HPR\_SD = 1, the right headphone output is disabled.

## DIFFERENTIAL AMPLIFIER EXPLANATION

The LM49150 features a differential input stage, which offers improved noise rejection compared to a single-ended input amplifier. Because a differential input amplifier amplifies the difference between the two input signals, any component common to both signals is cancelled. An additional benefit of the differential input structure is the possible elimination of the DC input blocking capacitors. Since the DC component is common to both inputs, and thus cancelled by the amplifier, the LM49150 can be used without input coupling capacitors when configured with a differential input signal.

## SINGLE-ENDED INPUT CONFIGURATION

The left and right stereo inputs of the LM49150 are configured for single-ended sources (see Figure 1).

## INPUT CAPACITOR SELECTION

Input capacitors may be required for some applications, or when the audio source is single-ended. Input capacitors block the DC component of the audio signal, eliminating any conflict between the DC component of the audio source and the bias voltage of the LM49150. The input capacitors create a high-pass filter with the input resistors R<sub>IN</sub>. The -3dB point of the high-pass filter is found using Equation 1 below.

$$f = 1 / 2\pi R_{IN} C_{IN} \quad (\text{Hz})$$

Where

- value of R<sub>IN</sub> is given in the [Electrical Characteristics Table](#). (1)

High-pass filtering the audio signal helps protect the speakers. When the LM49150 is using a single-ended source, power supply noise on the ground is seen as an input signal. Setting the high-pass filter point above the power supply noise frequencies, 217Hz in a GSM phone, for example, filters out the noise such that it is not amplified and heard on the output. Capacitors with a tolerance of 10% or better are recommended for impedance matching and improved CMRR and PSRR.

## INPUT MIXER/MULTIPLEXER

The LM49150 includes a comprehensive mixer multiplexer controlled through the I<sup>2</sup>C interface. The mixer/multiplexer allows any input combination to appear on any output of LM49150. Multiple input paths can be selected simultaneously. Under these conditions, the selected inputs are mixed together and output on the selected channel. [Table 5](#) shows how the input signals are mixed together for each possible input selection.

## CLASS D AMPLIFIER

The LM49150 features a high-efficiency, filterless, class D amplifier, which features a filterless modulation scheme. When there is no input signal applied, the output switches between V<sub>DD</sub> and GND at a 50% duty cycle. Since the outputs of the LM49150 class D amplifier are differential and in phase, the result is zero net voltage across the speaker and no load current during the ideal state, thus conserving power. The switching frequency of each output is 300kHz.

When an input signal is applied, the duty cycle (pulse width) changes. For increasing output voltages, the duty cycle of one output increases while the duty cycle of the output decreases. For decreasing output voltages, the converse occurs. The difference between the two pulse widths yields the differential output voltage across the load.

## SPREAD SPECTRUM

The LM49150 features a filterless spread spectrum modulation scheme. The switching frequency varies by +/- 30% about a 300kHz center frequency, reducing the wideband spectral content, reducing EMI emissions radiated by the speaker and associated cables and traces. When a fixed frequency class D exhibits large amounts of spectral energy at multiples of switching frequency, the spread spectrum architecture of the LM49150 spreads that energy over a larger bandwidth. The cycle-to-cycle variation of the switching period does not affect the audio reproduction, efficiency, or PSRR. To enable spread spectrum, set the spread spectrum bit, B5 = 1 of the SHUTDOWN CONTROL register (see [Table 3](#)).

## ENHANCED EMISSIONS SUPPRESSION (E<sup>2</sup>S)

The LM49150 features TI's patented E<sup>2</sup>S system that reduces EMI, while maintaining high quality audio reproduction and efficiency. The LM49150 features Edge Rate Control (ERC) that greatly reduces the high frequency components of the output square waves by controlling the output rise and fall times, slowing the transitions to reduce RF emissions, while optimizing THD+N and efficiency performance.

## LDO GENERAL INFORMATION

The LM49150 has different supplies for each portion of the device, allowing for the optimum combination of headroom, power dissipation and noise immunity. The speaker amplifiers are powered from LSV<sub>DD</sub>. The ground reference headphone amplifiers are powered from the internal LDO. The separate power supplies allow the loudspeaker amplifier to operate from a higher voltage for maximum headroom, while the headphone amplifiers operate from a lower voltage, improving power dissipation.

## GROUND REFERENCED HEADPHONE AMPLIFIER

The LM49150 features a low noise inverting charge pump that generates an internal negative supply voltage. This allows the headphone outputs to be biased about GND instead of a nominal DC voltage, like traditional headphone amplifiers. Because there is no DC component, the large DC blocking capacitors (typically 220μF) are not necessary. The coupling capacitors are replaced by two small ceramic charge pump capacitors, saving board space and cost. Eliminating the output coupling capacitors also improves low frequency response. In traditional headphone amplifiers, the headphone impedance and the output capacitor from a high-pass filter that not only blocks the DC component of the output, but also attenuates low frequencies, impacting the bass response. Because the LM49150 does not require the output coupling capacitors, the low frequency response of the device is not degraded by external components. In addition to eliminating the output coupling capacitors, the ground referenced output nearly doubles the available dynamic range of the LM49250 headphone amplifiers when compared to a traditional headphone amplifier operating from the same supply voltage.

## CHARGE PUMP CAPACITOR SELECTION

Use low ESR ceramic capacitors (less than 100mΩ) for optimum performance.

## CHARGE PUMP FLYING CAPACITOR (C1)

The flying capacitor (C1), see [Figure 1](#), affects the load regulation and output impedance of the charge pump. A C1 value that is too low results in a loss of current drive, leading to a loss of amplifier headroom. A higher valued C1 improves load regulation and lowers charge pump output impedance to an extent. Above 2.2 $\mu$ F, the  $R_{DS(ON)}$  of the charge pump switches and the ESR of C1 and Cs5 dominate the output impedance. A lower value capacitor can be used in systems with low maximum output power requirements.

## CHARGE PUMP HOLD CAPACITOR (Cs5)

The value and ESR of the hold capacitor (Cs5) directly affects the ripple on  $CPV_{SS}$ . Increasing the value of Cs5 reduces output ripple. Decreasing the ESR of Cs5 reduces both output ripple and charge pump output impedance. A lower value capacitor can be used in systems with low maximum output power requirements.

## LM49150 Demoboard Bill Of Materials

**Table 9. Bill Of Materials**

Location	Qty	Description	Part Number	Manufacturer
CIN2, CIN1	2	0.22 $\mu$ F, 1206, 10V, X7R Ceramic Capacitor	GRM319R71C224KA01D	Murata
CS4, CS2	2	0.1 $\mu$ F, 0805, 10V, X7R Ceramic Capacitor	GRM219R71C104KA01D	Murata
CS7	1	1.0 $\mu$ F, 0805, 10V, X7R Ceramic Capacitor	GRM21BR71A105KA01L	Murata
CIN3, CIN4	2	1.0 $\mu$ F 1206, 10V, X7R Ceramic Capacitor	GRM319R71C105KAA3D	Murata
CS5, C1	2	2.2 $\mu$ F, 0603, 10V, X7R, Ceramic Capacitor	GRM188R71A225KE15D	Murata
CS1, CS3, CS6	3	2.2 $\mu$ F, Size A, Tantalum Capacitor	293D225X9010A2TE3	Vishay
U2	1	LM49150, 16 bump DSBGA	LM49510	TI
R1, R2	2	5K ohm 1/10W 0.05% 0603 SMD	CRCW06035R1KJNEA	Vishay
J11, J12, J13, J14	4	3-Header		
J1, J2, J3, J7, J8, J9, J10	7	2-Header		
J6	1	Header_3M 8516–4500PL		
U1	1	Headphone Jack		

## Layout Guidelines

Minimize trace impedance of the power, ground and all output traces for optimum performance. Voltage loss due to trace resistance between the LM49150 and the load results in decreased output power and efficiency. Trace resistance between the power supply and the GND of the LM49150 has the same effect as a poorly regulated supply, increased ripple and reduced peak output power. Use wide traces, for power-supply inputs and amplifier outputs to minimize losses due to trace resistance, as well as providing heat dissipation from the device. Proper grounding improves audio performance, minimizes crosstalk between channels and prevents switching noise from interfering with audio signal. Use of power and ground planes is recommended.

The following recommendations should be considered when laying out the different grounds of the LM49150. Refer to the Demo Board Schematic for the corresponding component designators. Bypass capacitors for  $AV_{DD}$  (CS7),  $LSV_{DD}$  (CS1, CS2),  $V_{O(LDO)}$  (CS3, CS4) should be grounded to the GND pin via a ground plane. Bypass capacitor for  $CPV_{SS}$  (CS5) should be grounded via a wide trace or a ground plane to the CPGND pin. The headphone grounds should be connected to the GND via a separate trace also. This will help prevent noise from the charge pump from feeding into the power supplies and the output.

Place all digital components and digital signal traces as far as possible from analog components and traces. Do not run digital and analog traces in parallel on the same PCB layer.

Demo Board Schematic

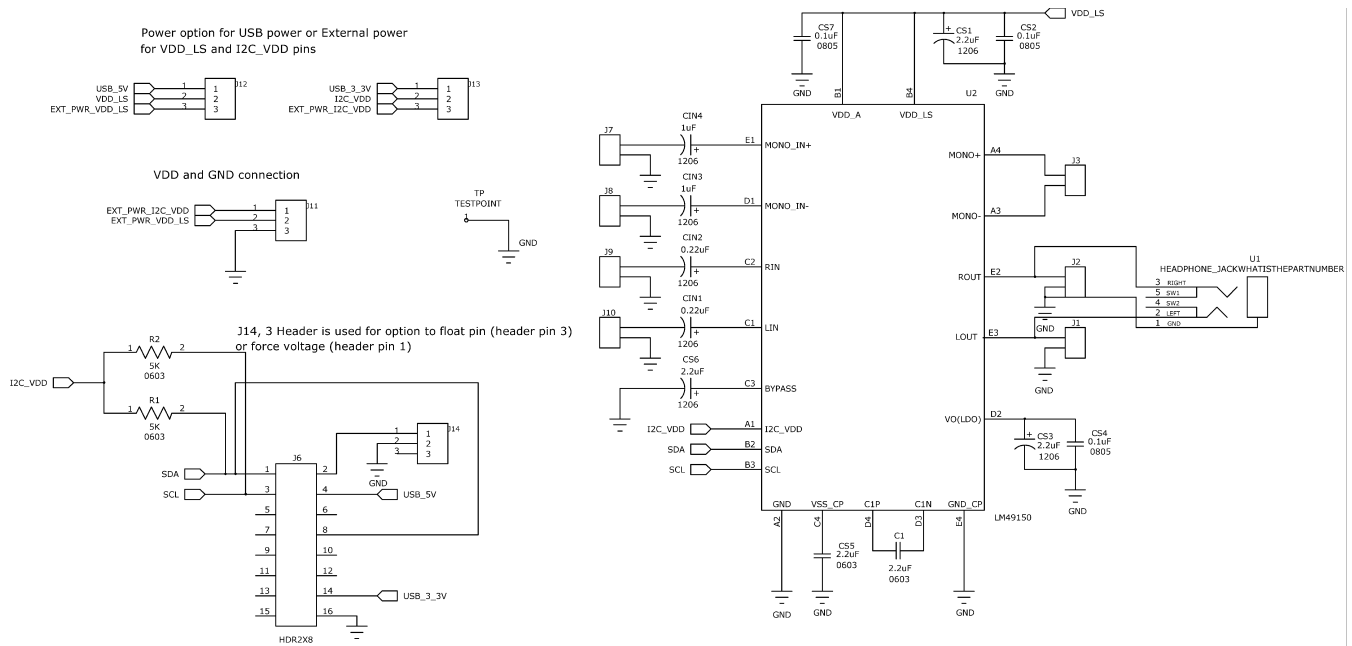

Figure 40. LM49150 Demo Board Schematic

PC Board Layout

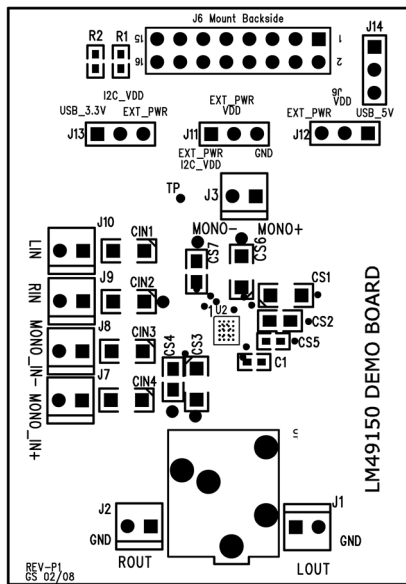

Figure 41. Top Silkscreen Layer

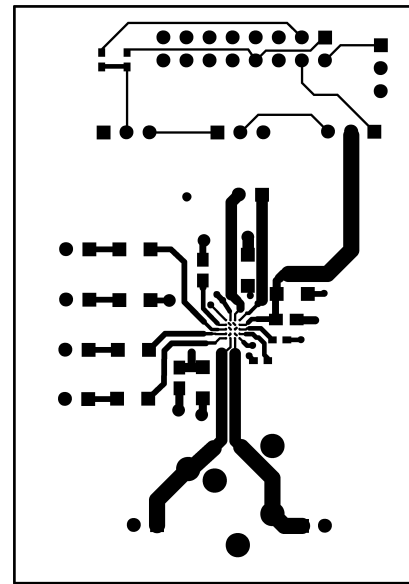

Figure 42. Top Layer

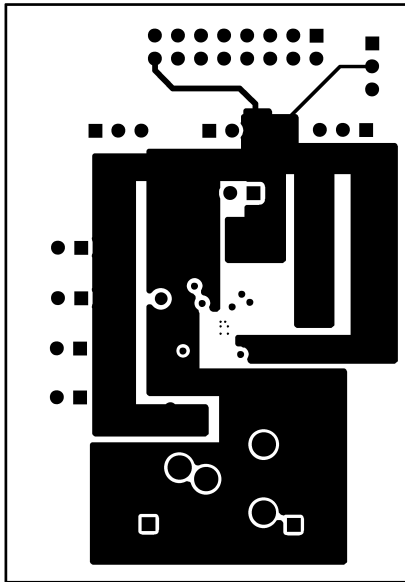

Figure 43. Layer 2

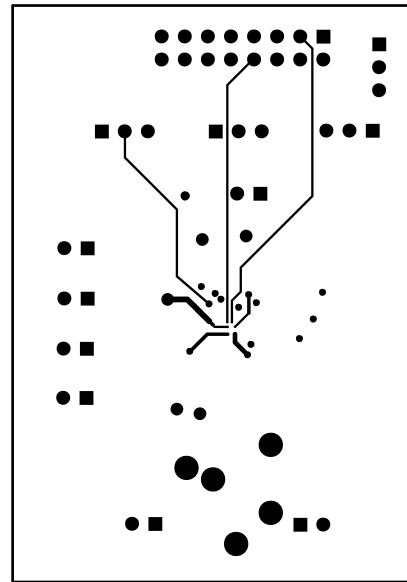

Figure 44. Layer 3

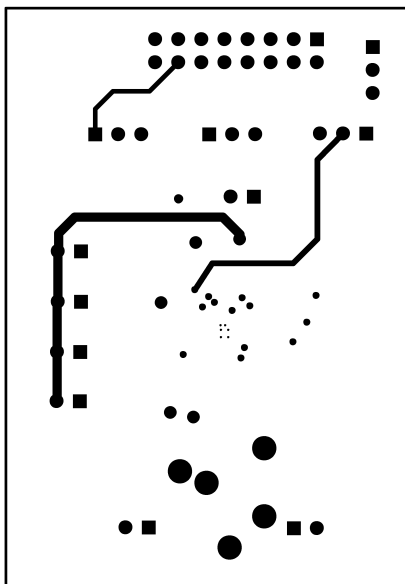

Figure 45. Bottom Layer

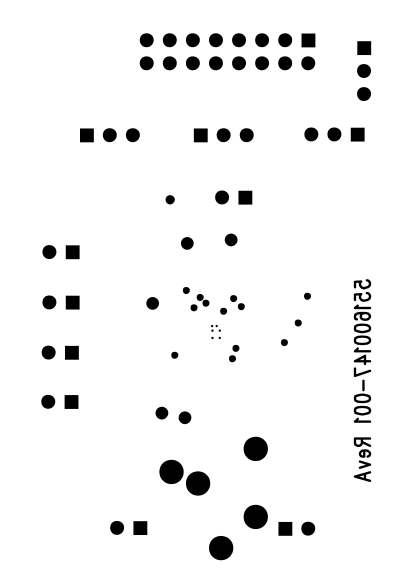

Figure 46. Bottom Silkscreen



**REVISION HISTORY**

<b>Rev</b>	<b>Date</b>	<b>Description</b>
1.0	08/27/08	Initial release.
1.01	09/09/08	Edited Table 6.
1.02	03/04/09	Added the Layout Guidelines section.
C	05/03/13	Changed layout of National Data Sheet to TI format.

**PACKAGING INFORMATION**

Orderable Device	Status (1)	Package Type	Package Drawing	Pins	Package Qty	Eco Plan (2)	Lead finish/ Ball material (6)	MSL Peak Temp (3)	Op Temp (°C)	Device Marking (4/5)	Samples
LM49150TL/NOPB	ACTIVE	DSBGA	YZR	20	250	RoHS & Green	SNAGCU	Level-1-260C-UNLIM	-40 to 85	GK7	<b>Samples</b>

(1) The marketing status values are defined as follows:

**ACTIVE:** Product device recommended for new designs.

**LIFEBUY:** TI has announced that the device will be discontinued, and a lifetime-buy period is in effect.

**NRND:** Not recommended for new designs. Device is in production to support existing customers, but TI does not recommend using this part in a new design.

**PREVIEW:** Device has been announced but is not in production. Samples may or may not be available.

**OBSOLETE:** TI has discontinued the production of the device.

(2) **RoHS:** TI defines "RoHS" to mean semiconductor products that are compliant with the current EU RoHS requirements for all 10 RoHS substances, including the requirement that RoHS substance do not exceed 0.1% by weight in homogeneous materials. Where designed to be soldered at high temperatures, "RoHS" products are suitable for use in specified lead-free processes. TI may reference these types of products as "Pb-Free".

**RoHS Exempt:** TI defines "RoHS Exempt" to mean products that contain lead but are compliant with EU RoHS pursuant to a specific EU RoHS exemption.

**Green:** TI defines "Green" to mean the content of Chlorine (Cl) and Bromine (Br) based flame retardants meet JS709B low halogen requirements of <=1000ppm threshold. Antimony trioxide based flame retardants must also meet the <=1000ppm threshold requirement.

(3) MSL, Peak Temp. - The Moisture Sensitivity Level rating according to the JEDEC industry standard classifications, and peak solder temperature.

(4) There may be additional marking, which relates to the logo, the lot trace code information, or the environmental category on the device.

(5) Multiple Device Markings will be inside parentheses. Only one Device Marking contained in parentheses and separated by a "-" will appear on a device. If a line is indented then it is a continuation of the previous line and the two combined represent the entire Device Marking for that device.

(6) Lead finish/Ball material - Orderable Devices may have multiple material finish options. Finish options are separated by a vertical ruled line. Lead finish/Ball material values may wrap to two lines if the finish value exceeds the maximum column width.

**Important Information and Disclaimer:** The information provided on this page represents TI's knowledge and belief as of the date that it is provided. TI bases its knowledge and belief on information provided by third parties, and makes no representation or warranty as to the accuracy of such information. Efforts are underway to better integrate information from third parties. TI has taken and continues to take reasonable steps to provide representative and accurate information but may not have conducted destructive testing or chemical analysis on incoming materials and chemicals. TI and TI suppliers consider certain information to be proprietary, and thus CAS numbers and other limited information may not be available for release.

In no event shall TI's liability arising out of such information exceed the total purchase price of the TI part(s) at issue in this document sold by TI to Customer on an annual basis.

**TAPE AND REEL INFORMATION**

**QUADRANT ASSIGNMENTS FOR PIN 1 ORIENTATION IN TAPE**

\*All dimensions are nominal

Device	Package Type	Package Drawing	Pins	SPQ	Reel Diameter (mm)	Reel Width W1 (mm)	A0 (mm)	B0 (mm)	K0 (mm)	P1 (mm)	W (mm)	Pin1 Quadrant
LM49150TL/NOPB	DSBGA	YZR	20	250	178.0	8.4	2.34	2.85	0.76	4.0	8.0	Q1

**TAPE AND REEL BOX DIMENSIONS**

\*All dimensions are nominal

Device	Package Type	Package Drawing	Pins	SPQ	Length (mm)	Width (mm)	Height (mm)
LM49150TL/NOPB	DSBGA	YZR	20	250	208.0	191.0	35.0

YZR0020

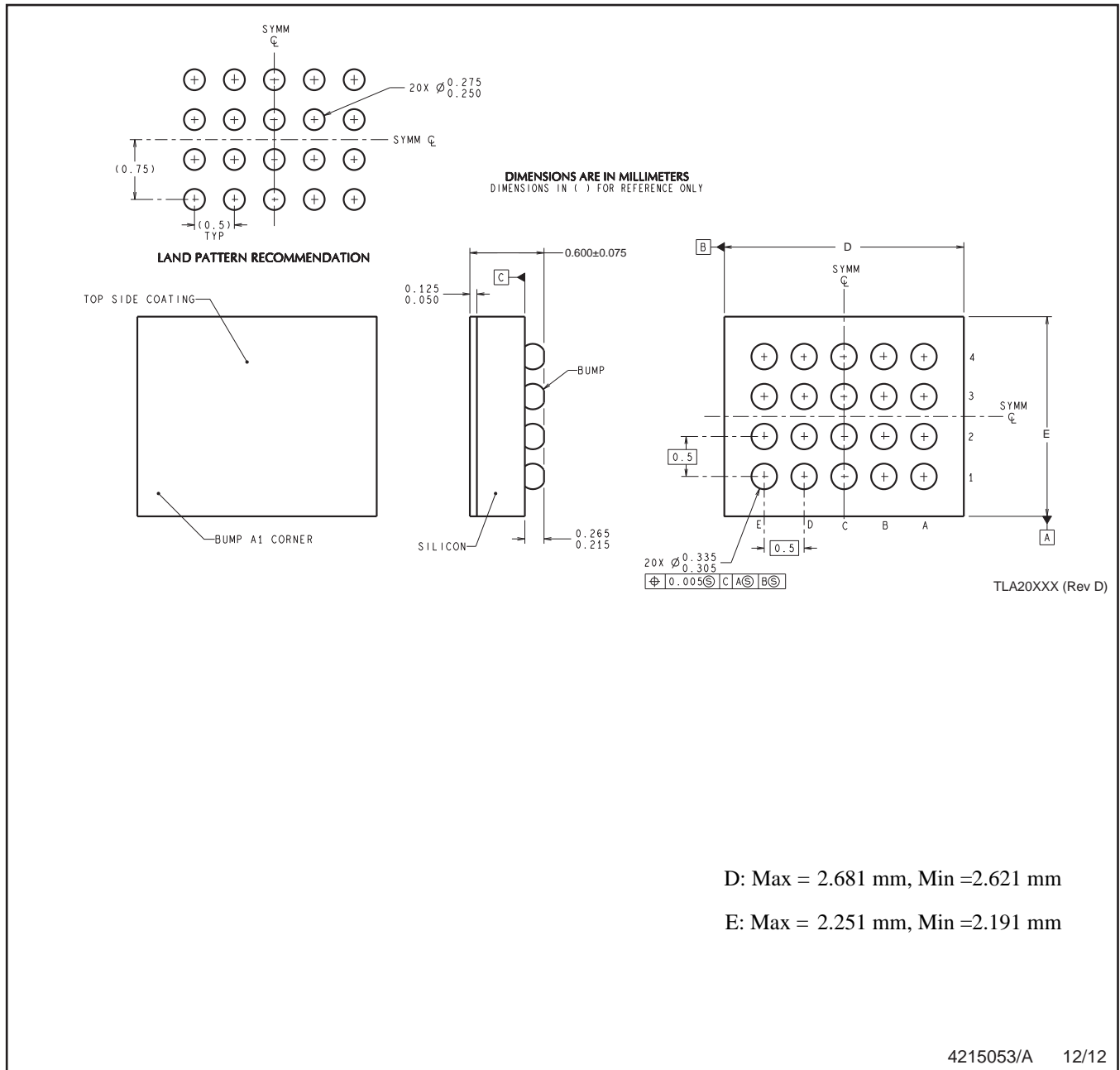

NOTES: A. All linear dimensions are in millimeters. Dimensioning and tolerancing per ASME Y14.5M-1994.  
B. This drawing is subject to change without notice.

4215053/A 12/12

## IMPORTANT NOTICE AND DISCLAIMER

TI PROVIDES TECHNICAL AND RELIABILITY DATA (INCLUDING DATA SHEETS), DESIGN RESOURCES (INCLUDING REFERENCE DESIGNS), APPLICATION OR OTHER DESIGN ADVICE, WEB TOOLS, SAFETY INFORMATION, AND OTHER RESOURCES "AS IS" AND WITH ALL FAULTS, AND DISCLAIMS ALL WARRANTIES, EXPRESS AND IMPLIED, INCLUDING WITHOUT LIMITATION ANY IMPLIED WARRANTIES OF MERCHANTABILITY, FITNESS FOR A PARTICULAR PURPOSE OR NON-INFRINGEMENT OF THIRD PARTY INTELLECTUAL PROPERTY RIGHTS.

These resources are intended for skilled developers designing with TI products. You are solely responsible for (1) selecting the appropriate TI products for your application, (2) designing, validating and testing your application, and (3) ensuring your application meets applicable standards, and any other safety, security, regulatory or other requirements.

These resources are subject to change without notice. TI grants you permission to use these resources only for development of an application that uses the TI products described in the resource. Other reproduction and display of these resources is prohibited. No license is granted to any other TI intellectual property right or to any third party intellectual property right. TI disclaims responsibility for, and you will fully indemnify TI and its representatives against, any claims, damages, costs, losses, and liabilities arising out of your use of these resources.

TI's products are provided subject to [TI's Terms of Sale](#) or other applicable terms available either on [ti.com](https://www.ti.com) or provided in conjunction with such TI products. TI's provision of these resources does not expand or otherwise alter TI's applicable warranties or warranty disclaimers for TI products.

TI objects to and rejects any additional or different terms you may have proposed.

Mailing Address: Texas Instruments, Post Office Box 655303, Dallas, Texas 75265  
Copyright © 2024, Texas Instruments Incorporated