

LM5166 3-V to 65-V Input, 500-mA Synchronous Buck Converter With Ultra-Low I_Q

1 Features

- Wide Input Voltage Range of 3 V to 65 V
- 9.7- μ A No-Load Quiescent Current
- -40°C to 150°C Junction Temperature Range
- Fixed (3.3-V, 5-V) or Adjustable V_{OUT} Options
- Meets EN55022 / CISPR 22 EMI Standards
- Integrated 1- Ω PFET Buck Switch
 - Supports 100% Duty Cycle for Low Dropout
- Integrated 0.5- Ω NFET Synchronous Rectifier
 - Eliminates External Schottky Diode
- Programmable Peak Current Limit Supports:
 - 500-mA, 300-mA, or 200-mA Loads
- Selectable PFM or COT Mode Operation
- 1.223-V \pm 1.2% Internal Voltage Reference
- Switching Frequency up to 600 kHz
- 900- μ s Internal or Externally-Adjustable Soft Start
- Diode Emulation and Pulse Skipping for Ultra-High Light-Load Efficiency
- No Loop Compensation or Bootstrap Components
- Precision Enable and Input UVLO With Hysteresis
- Open-Drain Power Good Indicator
- Thermal Shutdown Protection With Hysteresis
- Pin-to-Pin Compatible With the [LM5165](#)
- 10-Pin, 3-mm \times 3-mm VSON Package
- Create a Custom Regulator Design Using [WEBENCH[®] Power Designer](#)

2 Applications

- Factory and Building Automation
- Automotive and Battery-Powered Applications
- High Voltage LDO Replacement
- Low Power Bias Supplies

Typical COT Mode Application

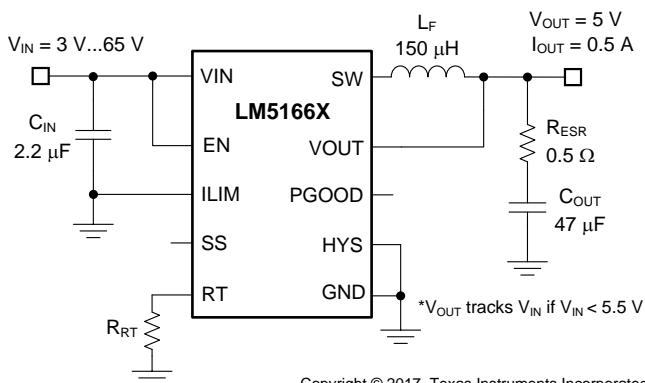

3 Description

The [LM5166](#) is a compact, easy-to-use, 3-V to 65-V, ultra-low I_Q synchronous buck converter with high efficiency over wide input voltage and load current ranges. With integrated high-side and low-side power MOSFETs, up to 500 mA of output current can be delivered at fixed output voltages of 3.3 V or 5 V, or an adjustable output. The converter is designed to simplify implementation while providing options to optimize the performance for the target application. Pulse frequency modulation (PFM) mode is selected for optimal light-load efficiency or constant on-time (COT) control for nearly constant operating frequency. Both control schemes do not require loop compensation while providing excellent line and load transient response and short PWM on-time for large step-down conversion ratios.

The high-side P-channel MOSFET can operate at 100% duty cycle for lowest dropout voltage and does not require a bootstrap capacitor for gate drive. Also, the current limit setpoint is adjustable to optimize inductor selection for a particular load current requirement. Selectable and adjustable start-up timing options include minimum delay (no soft start), internally fixed (900 μ s), and externally programmable soft start using a capacitor. An open-drain PGOOD indicator can be used for sequencing, fault reporting, and output voltage monitoring. The LM5166 is available in a 10-pin VSON package with 0.5-mm pin pitch.

Device Information⁽¹⁾

PART NUMBER	OUTPUT	PACKAGE
LM5166	Adjustable	VSON (10)
LM5166X	5-V fixed	
LM5166Y	3.3-V fixed	

(1) For all available packages, see the orderable addendum at the end of the data sheet.

Typical COT Mode Application Efficiency

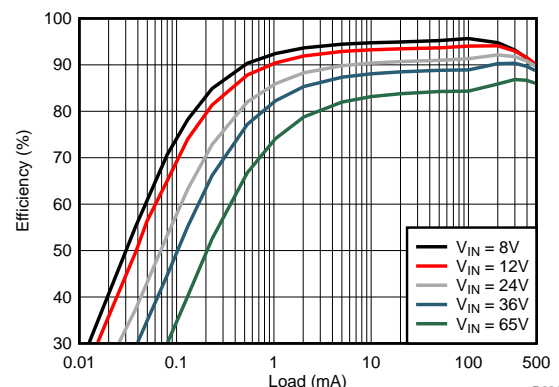

Table of Contents

1 Features	1	7.4 Device Functional Modes	25
2 Applications	1	8 Applications and Implementation	26
3 Description	1	8.1 Application Information	26
4 Revision History	2	8.2 Typical Applications	26
5 Pin Configuration and Functions	3	9 Power Supply Recommendations	44
6 Specifications	4	10 Layout	44
6.1 Absolute Maximum Ratings	4	10.1 Layout Guidelines	44
6.2 ESD Ratings	4	10.2 Layout Example	46
6.3 Recommended Operating Conditions	4	11 Device and Documentation Support	47
6.4 Thermal Information	4	11.1 Device Support	47
6.5 Electrical Characteristics	5	11.2 Documentation Support	47
6.6 Switching Characteristics	6	11.3 Receiving Notification of Documentation Updates	48
6.7 Typical Characteristics	7	11.4 Community Resources	48
7 Detailed Description	14	11.5 Trademarks	48
7.1 Overview	14	11.6 Electrostatic Discharge Caution	48
7.2 Functional Block Diagram	14	11.7 Glossary	48
7.3 Feature Description	15	12 Mechanical, Packaging, and Orderable Information	48

4 Revision History

Changes from Revision A (December 2016) to Revision B

Page

• Updated data sheet text to the latest TI documentation and translations standards	1
• Changed the language of WEBENCH list item; added additional content and links for WEBENCH in data sheet	1
• Added LM5166X and LM5166Y output versions to the data sheet	1
• Replaced the body size (NOM) column with output versions in the <i>Device Information</i> table	1
• Changed the <i>Typical COT Mode Application</i> circuit to a fixed 5-V output	1
• Changed the EN absolute maximum voltage from $(V_{VIN} + 0.3 V)$ to 68 V	4
• Deleted note 5 under the <i>Absolute Maximum Ratings</i> table	4
• Changed the EN max operating voltage from V_{VIN} to 65 V	4
• Removed note 2 under the <i>Recommended Operating Conditions</i>	4
• Changed the I_{FB} maximum from: 100 nA to: 25 nA	5
• Added Figure 13 and Figure 14	8
• Modified the <i>Functional Block Diagram</i> graphic	14
• Changed $R_{DS(ON)1}$ to $R_{DS(ON)2}$ in Equation 3	17
• Updated Equation 12	19
• Added a link to TI Design TIDA-01395 to the <i>Typical Applications</i> section	26
• Changed Design 3 to a 3.3-V fixed output, LM5166Y	35
• Added a new part number to C_{IN} ref description	35
• Added a new part number to L_F ref description	38
• Added the <i>Design 5: 12-V, 300-mA COT Converter Operating from 24-V or 48-V Input</i> section to <i>Typical Applications</i> ...	41
• Changed the <i>PCB Layout</i> and <i>PCB Layout Guidelines</i> section names to <i>Layout</i> and <i>Layout Guidelines</i>	44
• Added content to the <i>Documentation Support</i> section	47

Changes from Original (December 2016) to Revision A

Page

• Changed data sheet status from product preview to production data	1
---	---

5 Pin Configuration and Functions

**LM5166X and LM5166Y Fixed Output DRC Package
10-Pin VSON
Top View**

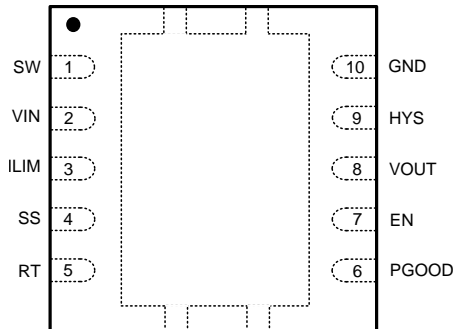

**LM5166 Adjustable Output DRC Package
10-Pin VSON
Top View**

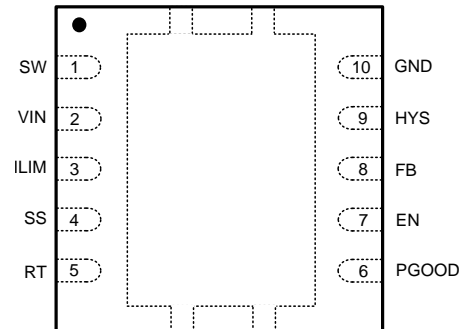

Pin Functions

PIN		I/O ⁽¹⁾	DESCRIPTION
NO.	NAME		
1	SW	P	Switching node that is internally connected to the drain of the PFET buck switch (high side) and the drain of the NFET synchronous rectifier (low side). Connect to the buck inductor.
2	VIN	P	Regulator supply input pin to high-side power MOSFET and internal bias rail LDO. Connect to input supply and input filter capacitor C_{IN} . The path from the VIN pin to the input capacitor must be as short as possible.
3	ILIM	I	Programming pin for current limit. Connecting the appropriate resistance from the ILIM pin to GND selects one of the three current limit options. The available current limit options are detailed in Table 3 .
4	SS	I	Programming pin for the soft-start delay. If a 100-k Ω resistor is connected from the SS pin to GND, the internal soft-start circuit is disabled and the FB comparator reference steps immediately from zero to full value when the regulator is enabled by the EN input. If the SS pin is left open, the internal soft-start circuit ramps the FB reference from zero to full value in 900 μ s. If a capacitor is connected from the SS pin to GND, the soft-start time can be set longer than 900 μ s.
5	RT	I	Mode select and on-time programming pin for Constant On-Time control. Connect a resistor from the RT pin to GND to program the on-time and hence switching frequency. Short RT to GND to select PFM (pulse frequency modulation) operation.
6	PGOOD	O	Power Good output flag pin. PGOOD is connected to the drain of an NFET that holds the pin low when either FB or VOUT is not in regulation. Use a 10-k Ω to 100-k Ω pullup resistor to system voltage rail or VOUT (no higher than 12 V).
7	EN	I	Input pin of the precision enable / UVLO comparator. The regulator is enabled when the EN pin voltage is greater than 1.22 V.
8	VOUT or FB	I	Feedback input to the voltage regulation loop for the LM5166 Adjustable Output version, or a VOUT pin connects the internal feedback resistor divider to the regulator output voltage for the fixed 3.3-V or 5-V options. The FB pin connects the internal feedback comparator to an external resistor divider for the adjustable voltage option, and the reference for the FB pin comparator is 1.223 V.
9	HYS	O	Drain of internal NFET that is turned off when the EN input is greater than the EN pin threshold. External resistors from HYS to EN and GND program the input UVLO threshold and hysteresis.
10	GND	G	Regulator ground return.
—	PAD	P	Connect to GND pin and system ground on PCB. Path to C_{IN} must be as short as possible.

(1) P = Power, G = Ground, I = Input, O = Output.

6 Specifications

6.1 Absolute Maximum Ratings

Over the recommended operating junction temperature range of -40°C to 150°C (unless otherwise noted).⁽¹⁾⁽²⁾

	MIN	MAX	UNIT
VIN, EN to GND	-0.3	68	V
SW to GND	-0.7	$V_{\text{VIN}} + 0.3$	V
	20-ns transient		
PGOOD, VOUT ⁽³⁾ to GND	-0.3	16	V
HYS to GND	-0.3	7	V
ILIM, SS, RT, FB ⁽⁴⁾ to GND	-0.3	3.6	V
Maximum junction temperature, T_{J}	-40	150	$^{\circ}\text{C}$
Storage temperature, T_{stg}	-55	150	$^{\circ}\text{C}$

- Stresses beyond those listed under *Absolute Maximum Ratings* may cause permanent damage to the device. These are stress ratings only, which do not imply functional operation of the device at these or any other conditions beyond those indicated under *Recommended Operating Conditions*. Exposure to absolute-maximum-rated conditions for extended periods may affect device reliability.
- If Military/Aerospace specified devices are required, please contact the Texas Instruments Sales Office/Distributors for availability and specifications.
- Fixed output setting.
- Adjustable output setting.

6.2 ESD Ratings

	VALUE	UNIT
$V_{\text{(ESD)}}$ Electrostatic discharge	Human body model (HBM), per ANSI/ESDA/JEDEC JS-001 ⁽¹⁾	± 2000
	Charged device model (CDM), per JEDEC specification JESD22-C101 ⁽²⁾	± 1000

- JEDEC document JEP155 states that 500-V HBM allows safe manufacturing with a standard ESD control process.
- JEDEC document JEP157 states that 250-V CDM allows safe manufacturing with a standard ESD control process.

6.3 Recommended Operating Conditions

Over the recommended operating junction temperature range of -40°C to 150°C (unless otherwise noted).⁽¹⁾

	MIN	NOM	MAX	UNIT	
Input voltages	VIN	3	65	V	
	EN	-0.3	65		
	PGOOD	-0.3	12		
	HYS	-0.3	5.5		
Output current	I_{OUT}	0	500	mA	
Temperature	Operating junction temperature		-40	150	$^{\circ}\text{C}$

- Operating Ratings are conditions under which the device is intended to be functional. For specifications and test conditions, see *Electrical Characteristics*.

6.4 Thermal Information

THERMAL METRIC ⁽¹⁾	LM5166		UNIT
	DRC (VSON)		
	10 PINS		
$R_{\theta\text{JA}}$ Junction-to-ambient thermal resistance	49.1		$^{\circ}\text{C}/\text{W}$
$R_{\theta\text{JC(top)}}$ Junction-to-case (top) thermal resistance	57.2		$^{\circ}\text{C}/\text{W}$
$R_{\theta\text{JB}}$ Junction-to-board thermal resistance	26.6		$^{\circ}\text{C}/\text{W}$
Ψ_{JT} Junction-to-top characterization parameter	0.8		$^{\circ}\text{C}/\text{W}$
Ψ_{JB} Junction-to-board characterization parameter	23.8		$^{\circ}\text{C}/\text{W}$
$R_{\theta\text{JC(bot)}}$ Junction-to-case (bottom) thermal resistance	4.8		$^{\circ}\text{C}/\text{W}$

- For more information about traditional and new thermal metrics, see the *Semiconductor and IC Package Thermal Metrics* application report.

6.5 Electrical Characteristics

Typical values correspond to $T_J = 25^\circ\text{C}$. Minimum and maximum limits are based on $T_J = -40^\circ\text{C}$ to $+125^\circ\text{C}$. $V_{IN} = 12\text{ V}$ (unless otherwise noted).⁽¹⁾⁽²⁾

PARAMETER		TEST CONDITIONS	MIN	TYP	MAX	UNIT
I_{Q-SD}	VIN DC supply current, shutdown	$V_{EN} = 0\text{ V}$, $T_J = 25^\circ\text{C}$		4	6	μA
$I_{Q-SLEEP}$	VIN DC supply current, no load	$V_{FB} = 1.5\text{ V}$, $T_J = 25^\circ\text{C}$		9.7	15	μA
$I_{Q-SLEEP-VINMAX}$	VIN DC supply current, no load	$V_{FB} = 1.5\text{ V}$, $V_{VIN} = 65\text{ V}$, $T_J = 25^\circ\text{C}$		10	15	μA
$I_{Q-ACTIVE-PFM}$	VIN DC supply current, active	PFM mode, $R_{RT} = 0\ \Omega$, $R_{SS} = 100\text{ k}\Omega$		205		μA
$I_{Q-ACTIVE-COT}$	VIN DC supply current, active	COT mode, $R_{RT} = R_{SS} = 100\text{ k}\Omega$		320		μA
POWER SWITCHES						
R_{DSON1}	High-side MOSFET $R_{DS(on)}$	$I_{SW} = -100\text{ mA}$		0.93		Ω
R_{DSON2}	Low-side MOSFET $R_{DS(on)}$	$I_{SW} = 100\text{ mA}$		0.48		Ω
CURRENT LIMITING						
I_{HS_LIM1}	High-side peak current limit threshold	See Table 3	1125	1250	1375	mA
I_{HS_LIM2}			675	750	825	
I_{HS_LIM3}			440	500	560	
I_{LS_LIM1}	Low-side valley current limit threshold	See Table 3		415		mA
I_{LS_LIM2}				315		
REGULATION COMPARATOR						
V_{VOUT5}	VOUT 5-V DC setpoint	LM5166X	4.9	5.0	5.1	V
$V_{VOUT3.3}$	VOUT 3.3-V DC setpoint	LM5166Y	3.23	3.3	3.37	V
I_{VOUT}	VOUT pin input current	$V_{VOUT} = 5\text{ V}$, LM5166X		7		μA
		$V_{VOUT} = 3.3\text{ V}$, LM5166Y		3.8		
V_{FB1}	Lower FB regulation threshold (PFM and COT)	Adjustable VOUT version	1.208	1.223	1.238	V
V_{FB2}	Upper FB regulation threshold (PFM)		1.218	1.233	1.248	V
I_{FB}	FB pin input bias current	$V_{FB} = 1\text{ V}$			25	nA
$FB_{HYS-PFM}$	FB comparator PFM hysteresis	PFM mode		10		mV
$FB_{HYS-COT}$	FB comparator dropout hysteresis	COT mode		4		mV
$FB_{LINE-REG}$	FB threshold variation over line	$V_{VIN} = 3\text{ V}$ to 65 V		0.005		%/V
$V_{VOUT_LINE-REG}$	VOUT threshold variation over line	LM5166X, $V_{VIN} = 6\text{ V}$ to 65 V LM5166Y, $V_{VIN} = 4.5\text{ V}$ to 65 V		0.005		%/V
POWER GOOD						
UVT_{RISING}	PGOOD comparator	V_{FB} rising relative to V_{FB1} threshold		94%		
$UVT_{FALLING}$		V_{FB} falling relative to V_{FB1} threshold		87%		
R_{PGOOD}	PGOOD on-resistance	$V_{FB} = 1\text{ V}$		80	200	Ω
$V_{INMIN-PGOOD}$	Minimum required VIN for valid PGOOD	V_{VIN} falling $I_{PGOOD} = 0.1\text{ mA}$, $V_{PGOOD} < 0.5\text{ V}$		1.2	1.65	V
I_{PGOOD}	PGOOD off-state leakage	$V_{FB} = 1.2\text{ V}$, $V_{PGOOD} = 5.5\text{ V}$		10	100	nA
ENABLE / UVLO						
V_{IN-ON}	Turnon threshold	V_{VIN} rising	2.60	2.75	2.95	V
V_{IN-OFF}	Turnoff threshold	V_{VIN} falling	2.35	2.45	2.60	V
V_{EN-ON}	EN turnon threshold	V_{EN} rising	1.163	1.22	1.276	V
V_{EN-OFF}	EN turnoff threshold	V_{EN} falling	1.109	1.144	1.178	V

(1) All hot and cold limits are specified by correlating the electrical characteristics to process and temperature variations and applying statistical process control.

(2) The junction temperature (T_J in $^\circ\text{C}$) is calculated from the ambient temperature (T_A in $^\circ\text{C}$) and power dissipation (P_D in Watts) as follows: $T_J = T_A + (P_D \cdot \theta_{JA})$ where θ_{JA} (in $^\circ\text{C}/\text{W}$) is the package thermal impedance provided in [Thermal Information](#).

Electrical Characteristics (continued)

Typical values correspond to $T_J = 25^\circ\text{C}$. Minimum and maximum limits are based on $T_J = -40^\circ\text{C}$ to $+125^\circ\text{C}$. $V_{IN} = 12\text{ V}$ (unless otherwise noted).⁽¹⁾⁽²⁾

PARAMETER		TEST CONDITIONS	MIN	TYP	MAX	UNIT
V_{EN-HYS}	EN hysteresis			76		mV
V_{EN-SD}	EN shutdown threshold	V_{EN} falling	0.3	0.6		V
R_{HYS}	HYS on-resistance	$V_{EN} = 1\text{ V}$		80	200	Ω
I_{HYS}	HYS off-state leakage	$V_{EN} = 1.5\text{ V}$, $V_{HYS} = 5.5\text{ V}$		10	100	nA
SOFT-START						
I_{SS}	Soft-start charging current	$V_{SS} = 1\text{ V}$		10		μA
T_{SS-INT}	Soft-start rise time	SS floating		900		μs
THERMAL SHUTDOWN						
T_{J-SD}	Thermal shutdown threshold			170		$^\circ\text{C}$
$T_{J-SD-HYS}$	Thermal shutdown hysteresis			10		$^\circ\text{C}$

6.6 Switching Characteristics

Over operating free-air temperature range (unless otherwise noted)

PARAMETER		TEST CONDITIONS	MIN	TYP	MAX	UNIT
T_{ON-MIN}	Minimum on-time			180		ns
T_{ON1}	On-time	16 k Ω from RT to GND		280		ns
T_{ON2}	On-time	75 k Ω from RT to GND		1150		ns

6.7 Typical Characteristics

Unless otherwise specified, $V_{IN} = 12\text{ V}$, $V_{OUT} = 5\text{ V}$. Please refer to [Typical Applications](#) for circuit designs.

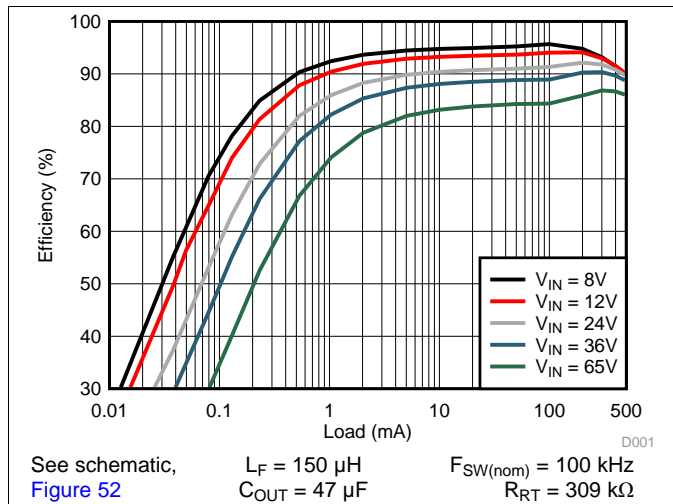

Figure 1. Converter Efficiency: 5 V, 500 mA, COT

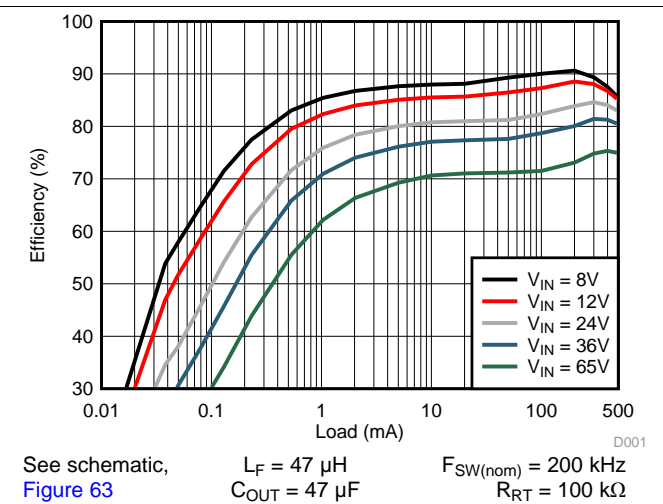

Figure 2. Converter Efficiency: 3.3 V, 500 mA, COT

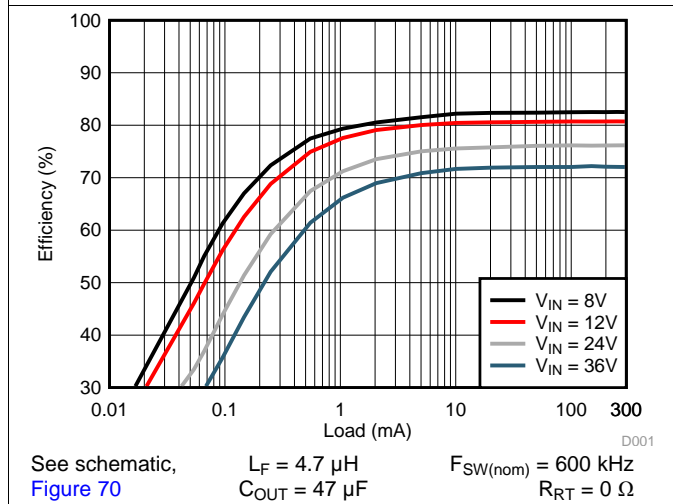

Figure 3. Converter Efficiency: 3.3 V, 300 mA, PFM

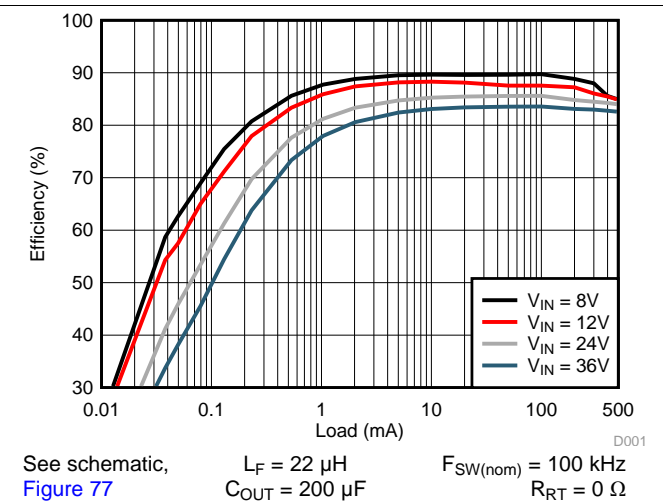

Figure 4. Converter Efficiency: 5 V, 500 mA, PFM

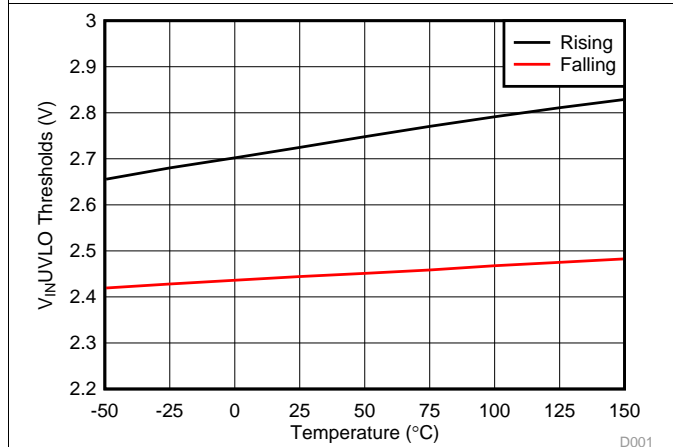

Figure 5. Internal V_{IN} UVLO Voltage vs Temperature

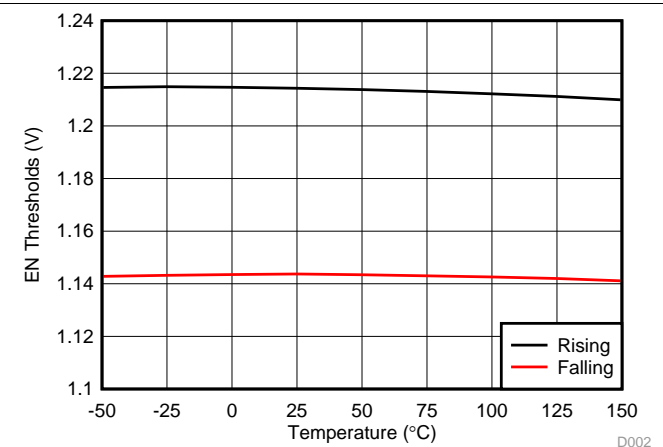

Figure 6. Enable Threshold Voltage vs Temperature

Typical Characteristics (continued)

Unless otherwise specified, $V_{IN} = 12\text{ V}$, $V_{OUT} = 5\text{ V}$. Please refer to [Typical Applications](#) for circuit designs.

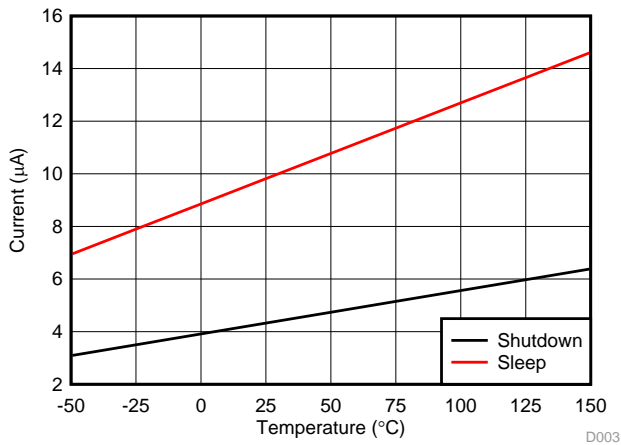

Figure 7. V_{IN} Sleep and Shutdown Supply Current vs Temperature

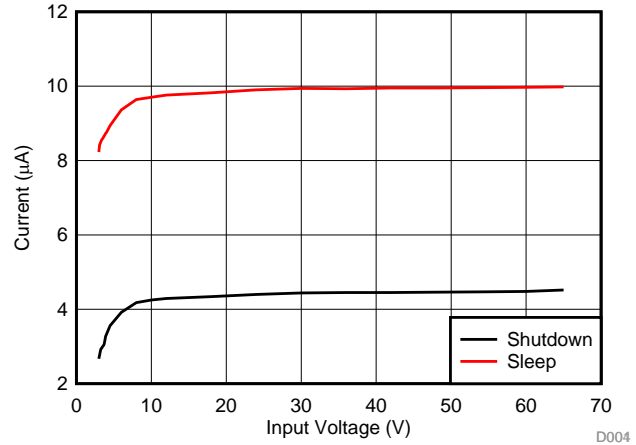

Figure 8. V_{IN} Sleep and Shutdown Supply Current vs Input Voltage

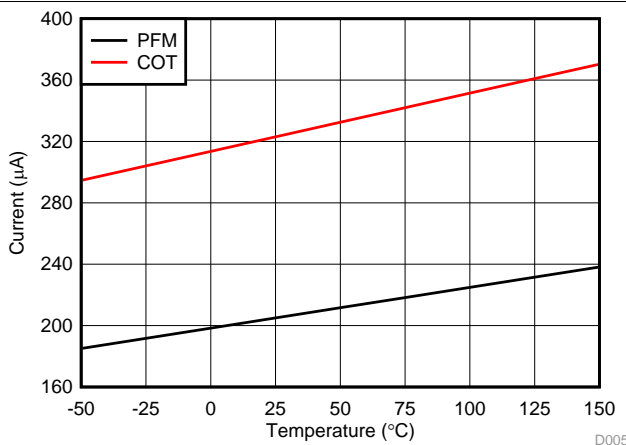

Figure 9. V_{IN} Active Mode Supply Current vs Temperature

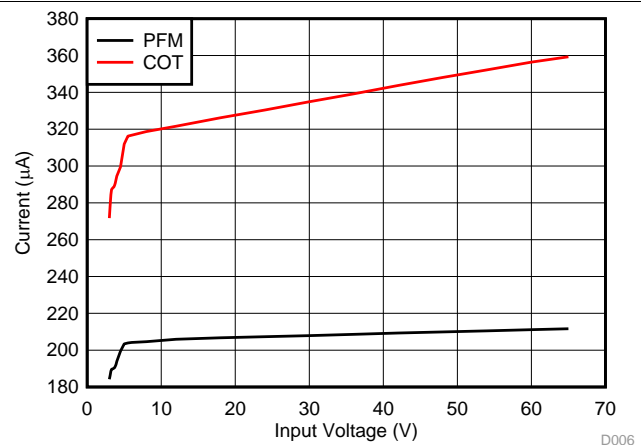

Figure 10. V_{IN} Active Mode Supply Current vs Input Voltage

$R_{RT} = 100\text{ k}\Omega$

$R_{RT} = 100\text{ k}\Omega$

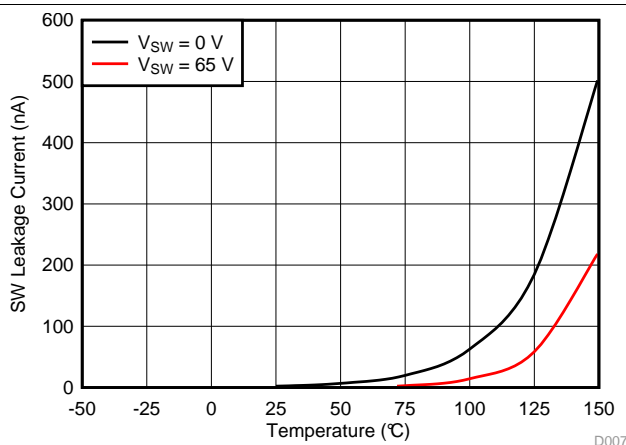

Figure 11. SW Pin Leakage Current vs Temperature

$V_{VIN} = 65\text{ V}$

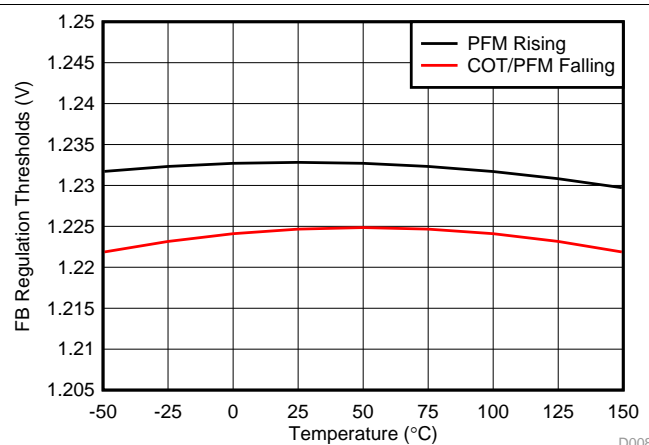
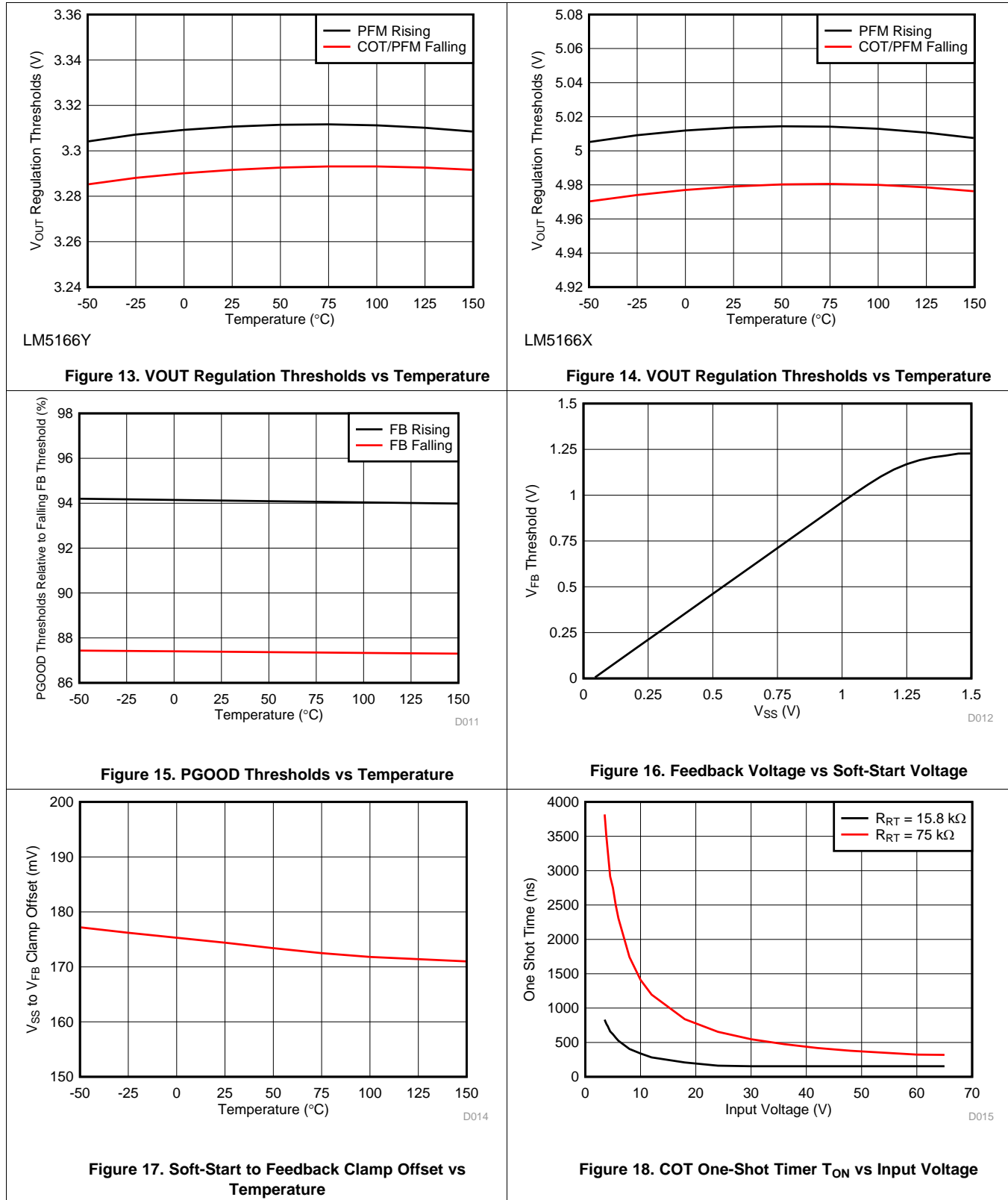

Figure 12. Feedback Comparator Threshold Voltage vs Temperature

Typical Characteristics (continued)

Unless otherwise specified, $V_{IN} = 12\text{ V}$, $V_{OUT} = 5\text{ V}$. Please refer to [Typical Applications](#) for circuit designs.



Typical Characteristics (continued)

Unless otherwise specified, $V_{IN} = 12\text{ V}$, $V_{OUT} = 5\text{ V}$. Please refer to [Typical Applications](#) for circuit designs.

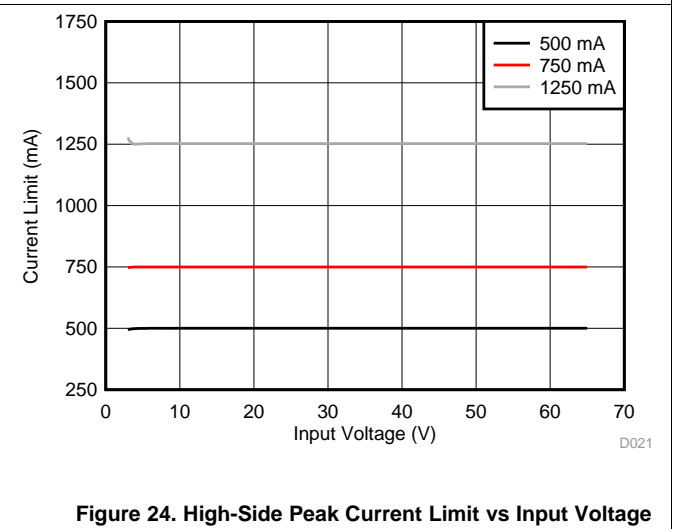
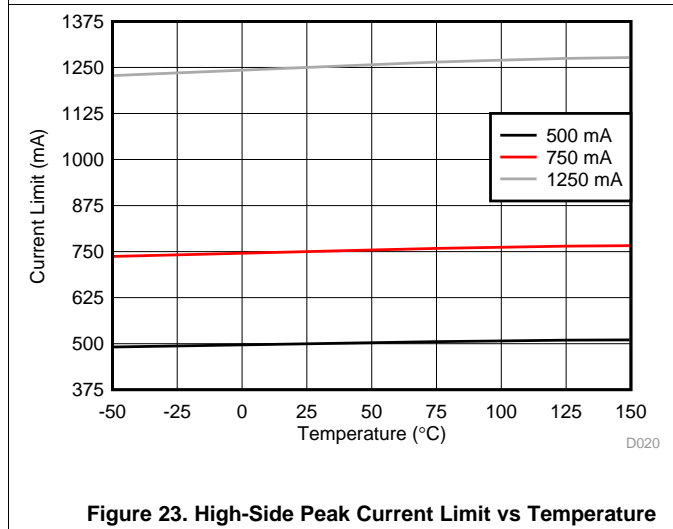
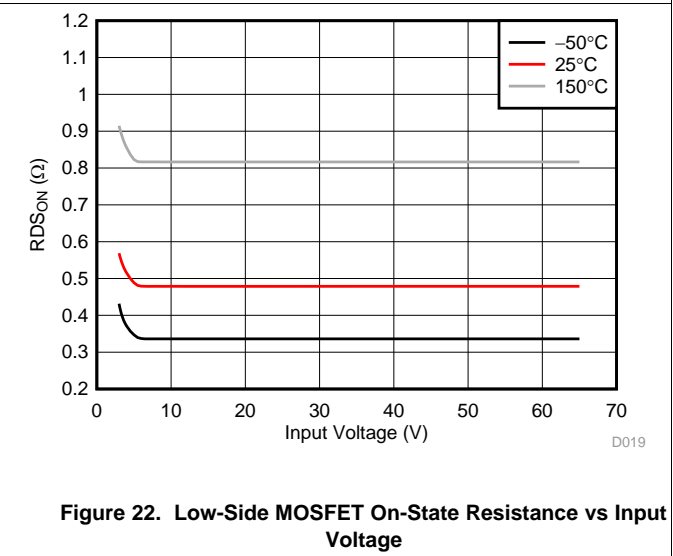
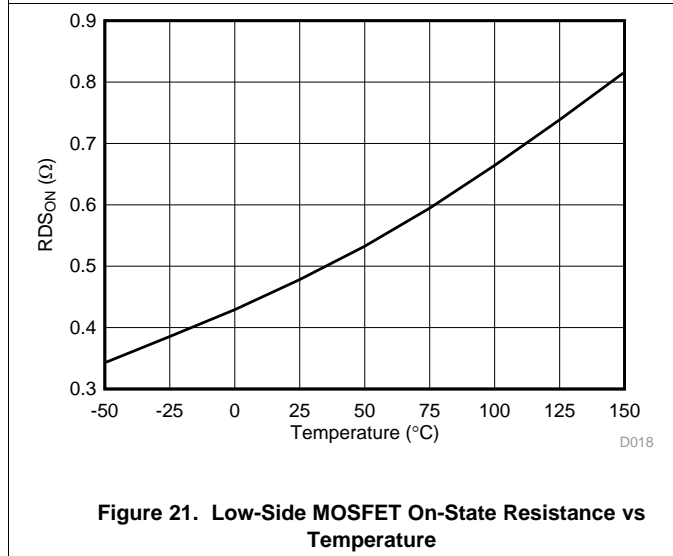
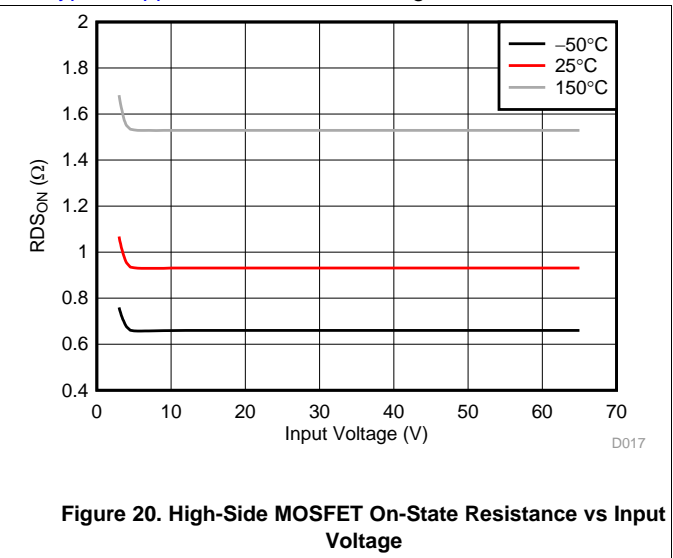
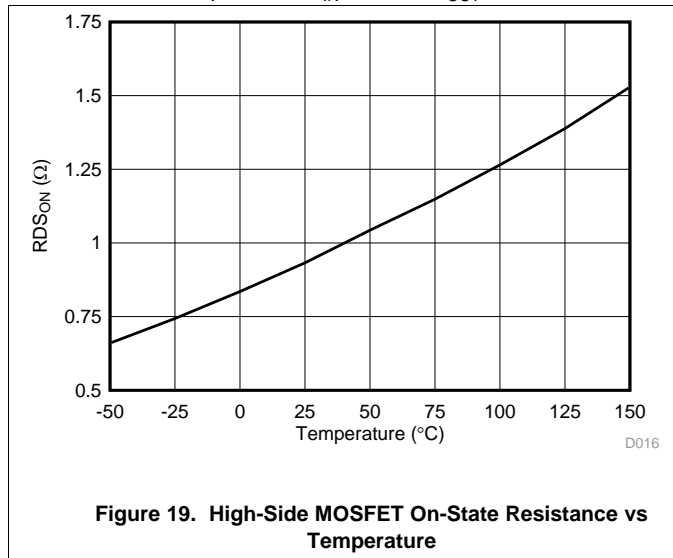

Typical Characteristics (continued)

Unless otherwise specified, $V_{IN} = 12\text{ V}$, $V_{OUT} = 5\text{ V}$. Please refer to [Typical Applications](#) for circuit designs.

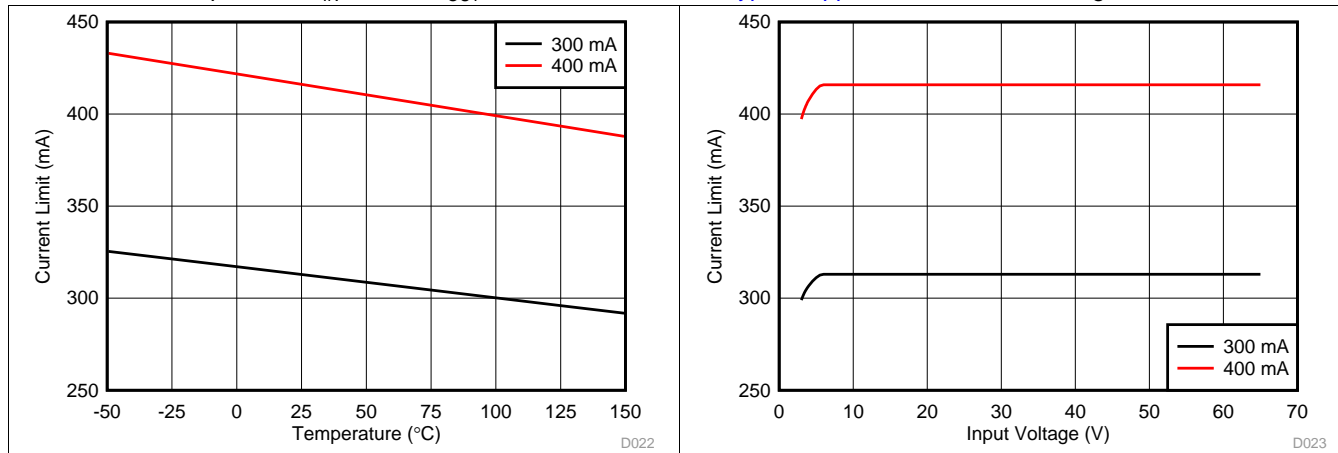

Figure 25. Low-Side Valley Current Limit vs Temperature

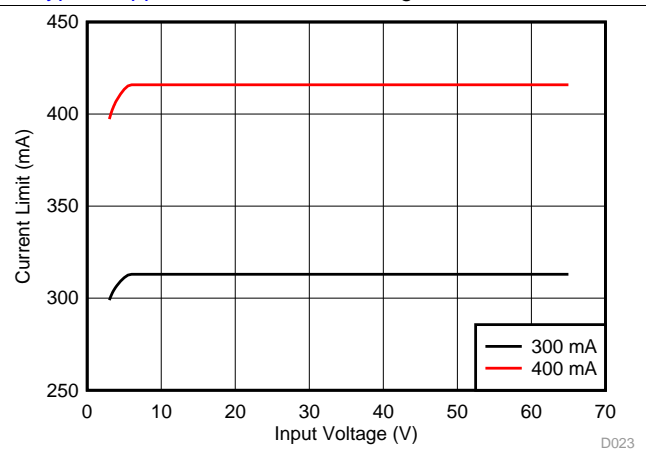

Figure 26. Low-Side Valley Current Limit vs Input Voltage

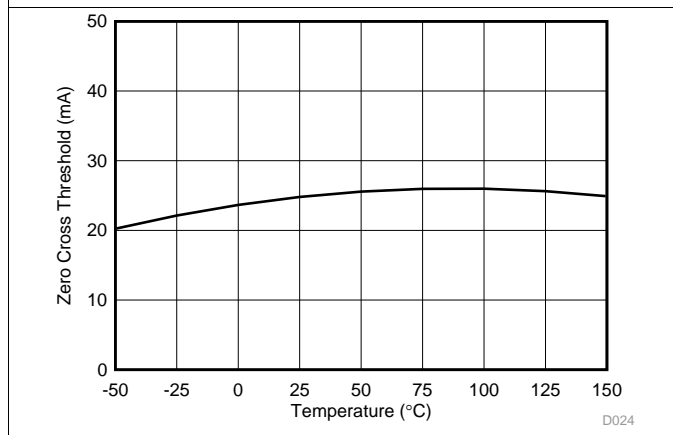

Figure 27. Zero-Cross Current Threshold vs Temperature

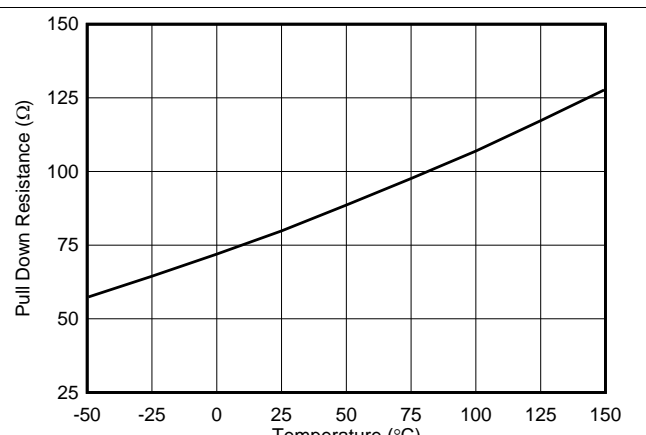
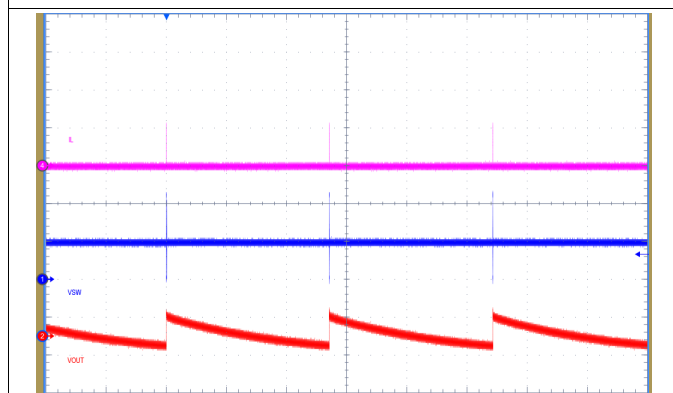
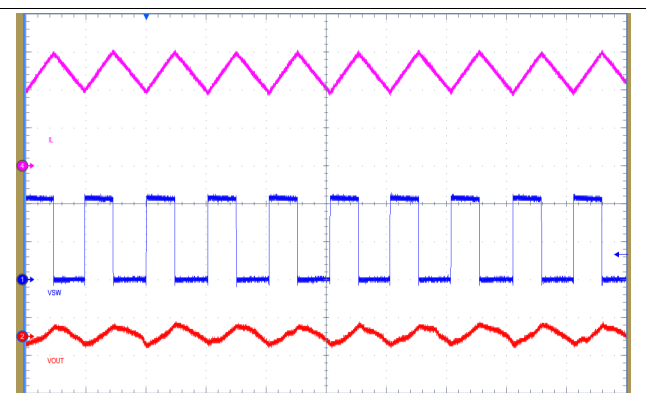

Figure 28. PGOOD and HYS Pulldown $R_{DS(on)}$ vs Temperature



Time Scale: 20 ms/Div
 CH1: V_{SW} , 5 V/Div
 CH2: V_{OUT} , 50 mV/Div
 CH4: I_L , 200 mA/Div

Figure 29. No-Load Switching Waveforms, COT, Type 2



Time Scale: 10 μ s/Div
 CH1: V_{SW} , 5 V/Div
 CH2: V_{OUT} , 50 mV/Div
 CH4: I_L , 200 mA/Div

Figure 30. Full Load Switching Waveforms, COT, Type 2

Typical Characteristics (continued)

Unless otherwise specified, $V_{IN} = 12\text{ V}$, $V_{OUT} = 5\text{ V}$. Please refer to [Typical Applications](#) for circuit designs.

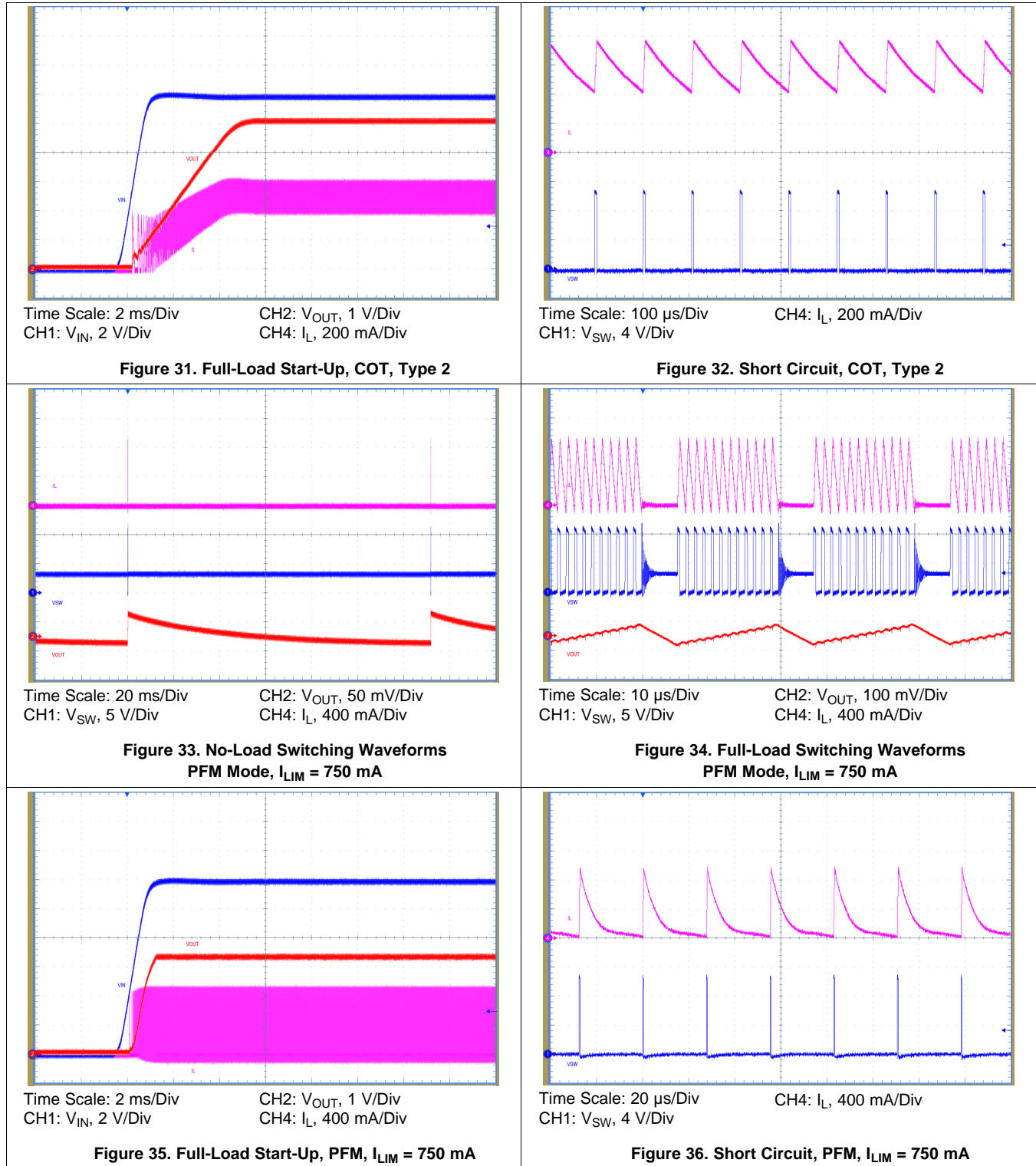

Typical Characteristics (continued)

Unless otherwise specified, $V_{IN} = 12\text{ V}$, $V_{OUT} = 5\text{ V}$. Please refer to [Typical Applications](#) for circuit designs.

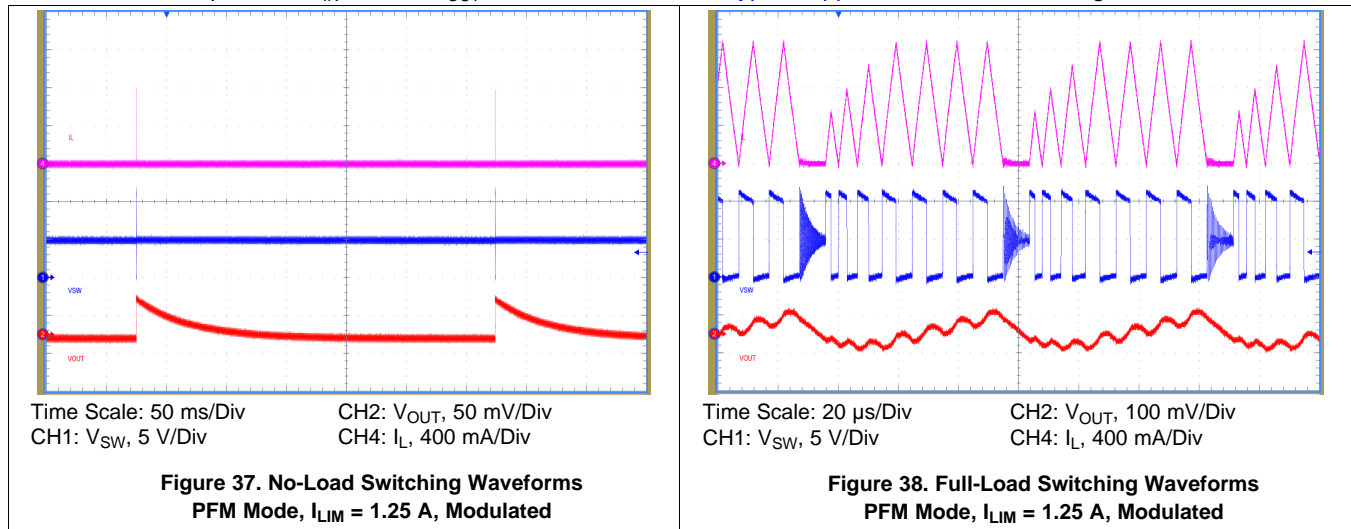

7 Detailed Description

7.1 Overview

The LM5166 regulator is an easy-to-use synchronous buck DC-DC converter that operates from a supply voltage ranging from 3 V to 65 V. The device is intended for step-down conversions from 5-V, 12-V, 24-V, and 48-V unregulated, semi-regulated, and fully-regulated supply rails. With integrated high-side and low-side power MOSFETs, the LM5166 delivers up to 500-mA DC load current with exceptional efficiency and ultra-low input quiescent current in a very small solution size. Designed for simple implementation, a choice of operating modes offers flexibility to optimize its usage according to the target application. Fixed-frequency, constant on-time (COT) operation with discontinuous conduction mode (DCM) at light loads is ideal for low-noise, high current, fast transient load requirements. Alternatively, pulse frequency modulation (PFM) mode, complemented by an adjustable current limit, achieves ultra-high light-load efficiency performance. Control loop compensation is not required with either operating mode, which reduces design time and external component count.

The LM5166 incorporates other features for comprehensive system requirements, including an open-drain Power Good circuit for power-rail sequencing and fault reporting, internally-fixed or externally-adjustable soft start, monotonic start-up into prebiased loads, precision enable with customizable hysteresis for programmable line undervoltage lockout (UVLO), and thermal shutdown with automatic recovery. These features enable a flexible and easy-to-use platform for a wide range of applications. The pin arrangement is designed for simple and optimized PCB [Layout](#), requiring only a few external components.

7.2 Functional Block Diagram

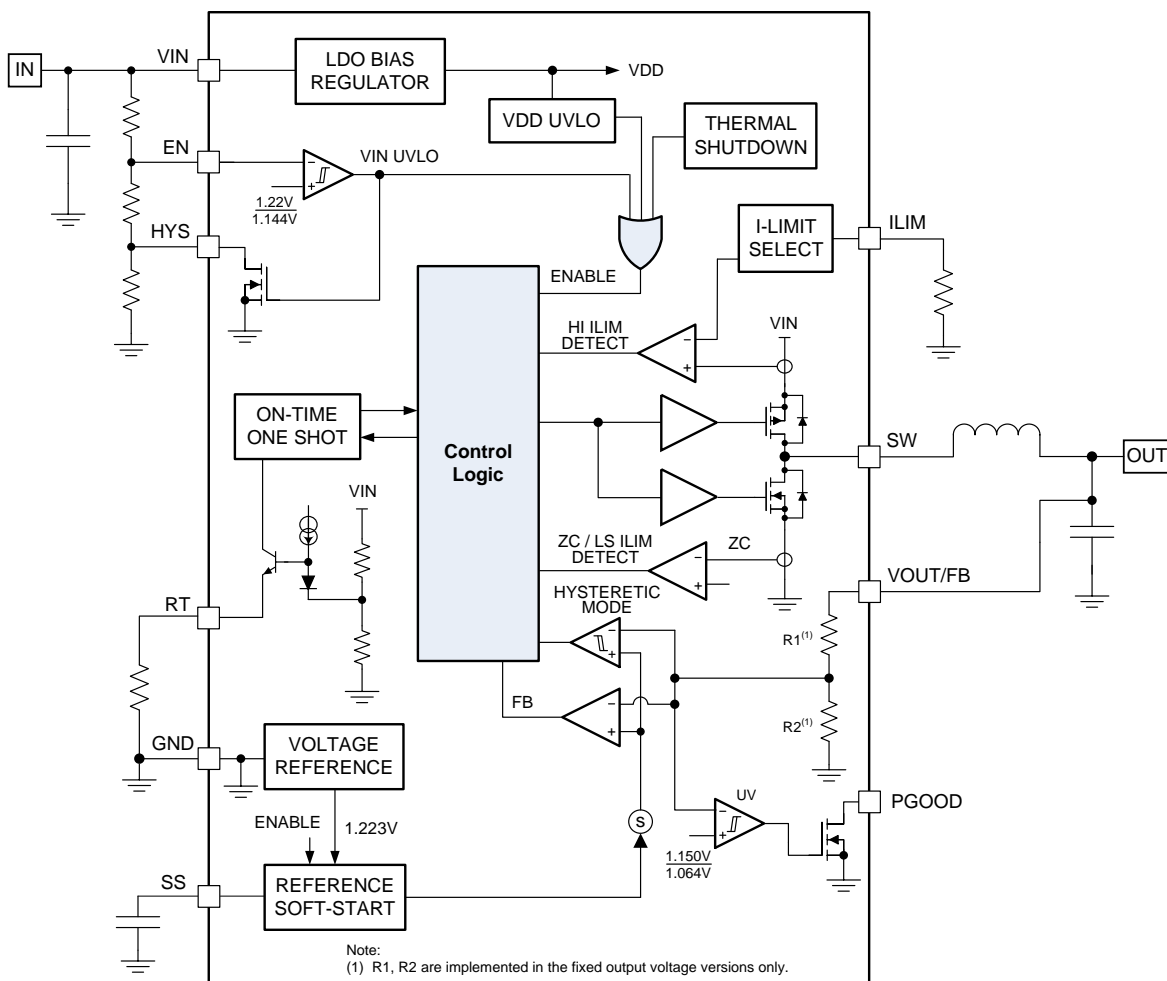

Copyright © 2016, Texas Instruments Incorporated

7.3 Feature Description

7.3.1 Integrated Power MOSFETs

The LM5166 is a step-down buck converter with integrated high-side PMOS buck switch and low-side NMOS synchronous switch. During the high-side MOSFET on-time, the SW voltage V_{SW} swings up to approximately V_{IN} , and the inductor current increases with slope $(V_{IN} - V_{OUT})/L_F$. When the high-side MOSFET is turned off by the control logic, the low-side MOSFET turns on after a fixed dead time. Inductor current flows through the low-side MOSFET with slope $-V_{OUT}/L_F$. Duty cycle D is defined as T_{ON}/T_{SW} , where T_{ON} is the high-side MOSFET conduction time and T_{SW} is the switching period.

7.3.2 Selectable PFM or COT Mode Converter Operation

Depending on how the RT pin is connected, the LM5166 operates in PFM or COT mode. With the RT pin tied to GND, the device operates in PFM mode. An R_{RT} resistor connected between the RT and GND pins enables COT control and sets the desired switching frequency as defined by Equation 4. Figure 39 and Figure 40 show converter schematics for PFM and COT modes of operation.

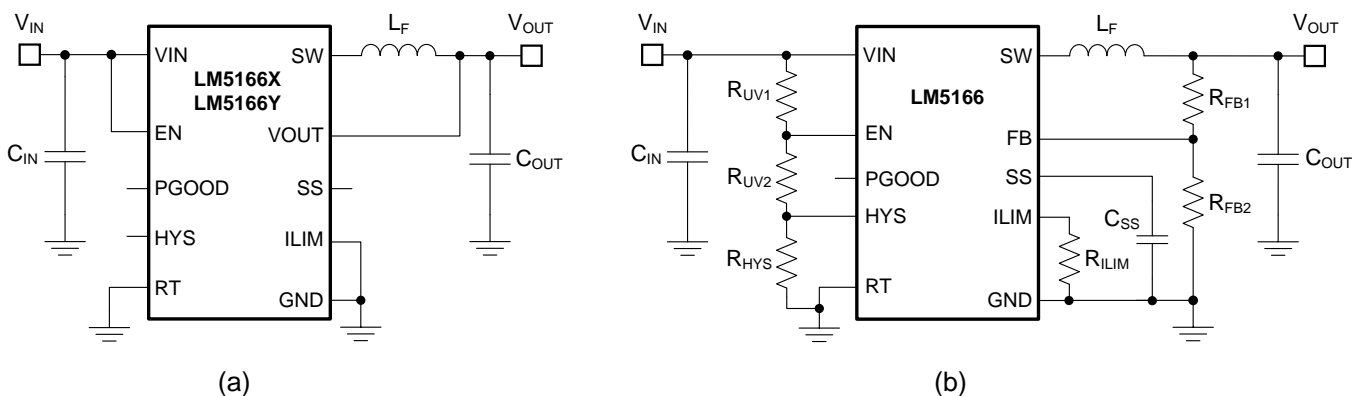

Figure 39. PFM Mode Converter Schematics: (a) Fixed Output Voltage of 5 V or 3.3 V, (b) Adjustable Output Voltage With Programmable Soft Start, Current Limit, and UVLO

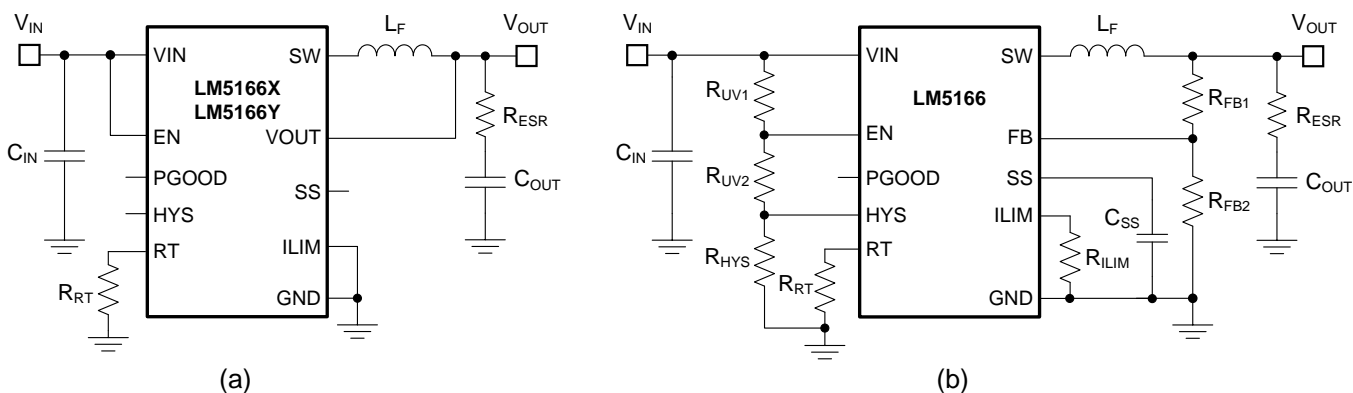

Figure 40. COT Mode Converter Schematics: (a) Fixed Output Voltage of 5 V or 3.3 V, (b) Adjustable Output Voltage With Programmable Soft Start, Current Limit, and UVLO

Feature Description (continued)

7.3.2.1 PFM Mode Operation

In PFM mode, the LM5166 behaves as a hysteretic voltage regulator operating in boundary conduction mode. The output voltage is regulated between upper and lower threshold levels according to the PFM feedback comparator hysteresis of 10 mV. Figure 41 shows the relevant output voltage and inductor current waveforms. The LM5166 provides the required switching pulses to recharge the output capacitor to the upper threshold, followed by a sleep period where most of the internal circuits are disabled. The load current is supported by the output capacitor during this time, and the LM5166 current consumption reduces to 9.7 μA. The sleep period duration depends on load current and output capacitance.

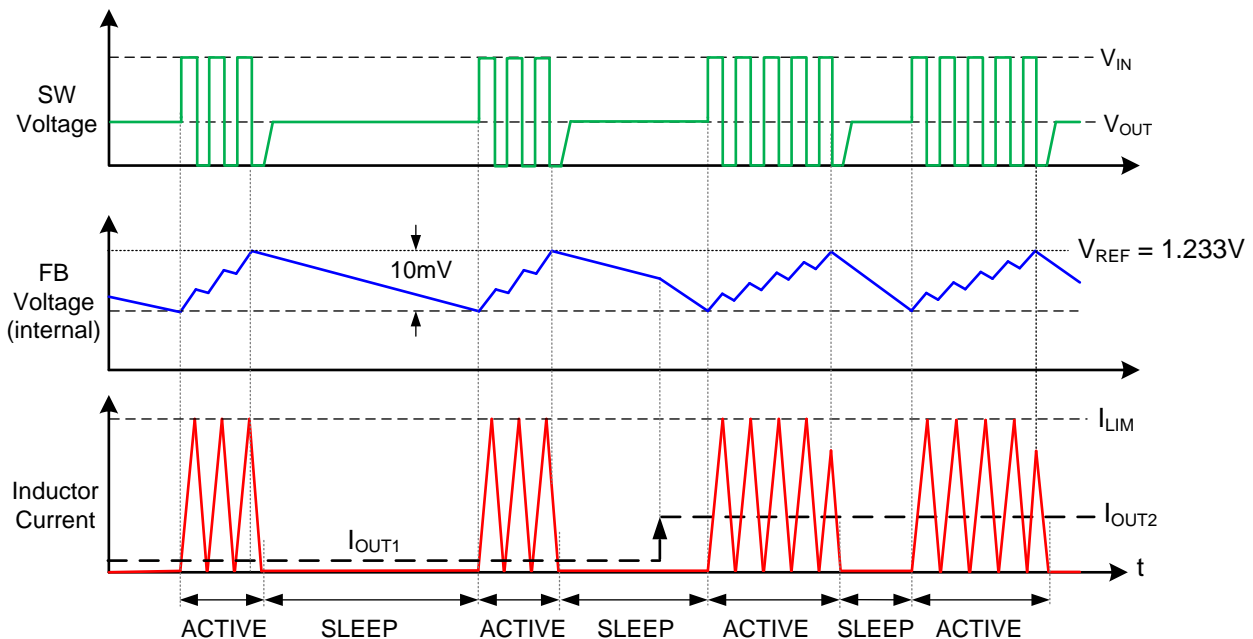

Figure 41. PFM Mode Output Voltage and Inductor Current Representative Waveforms

When operating in PFM mode at given input and output voltages, the chosen filter inductance dictates the PFM pulse frequency as

$$F_{SW(PFM)} = \frac{V_{OUT}}{L_F \cdot I_{PK(PFM)}} \cdot \left(1 - \frac{V_{OUT}}{V_{IN}} \right)$$

where

- $I_{PK(PFM)}$ is one of the programmable levels for peak current limit. See [Adjustable Current Limit](#) for more detail. (1)

One of the supported ILIM settings enables a function that modulates the peak current threshold levels during the first three switching cycles of each active period as illustrated in Figure 42. This function improves efficiency under most application conditions at the expense of slightly degraded load transient response.

Feature Description (continued)

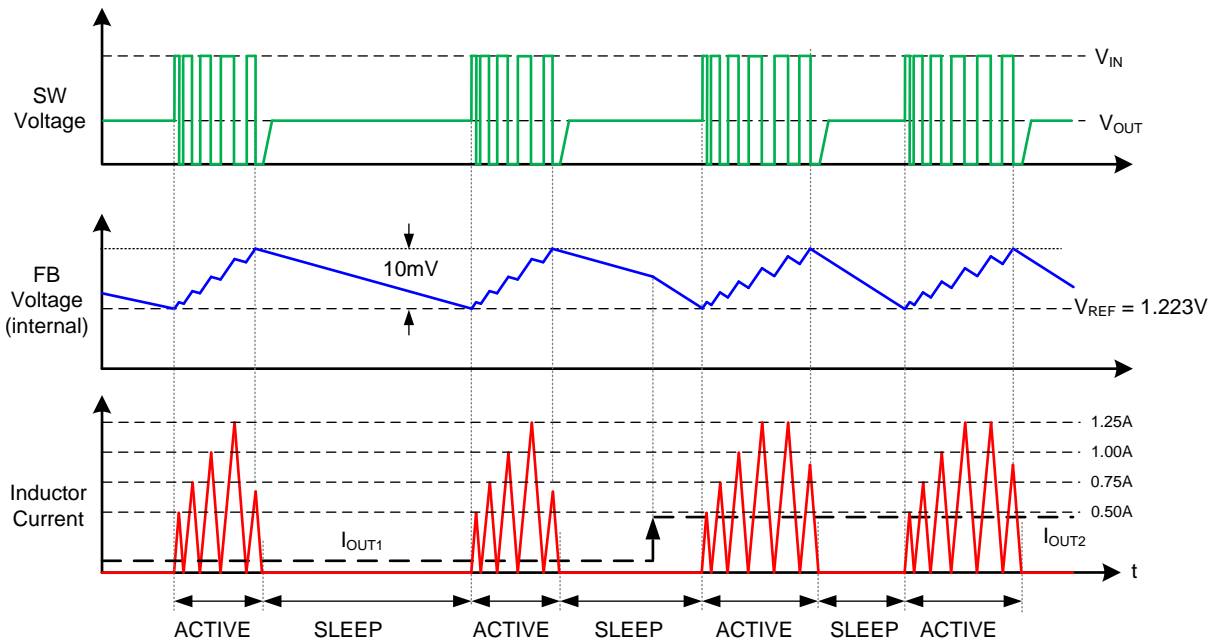

Figure 42. PFM Mode With Modulated I_{LIM} , Output Voltage and Inductor Current Representative Waveforms

As expected, the choice of mode and switching frequency represents a compromise between conversion efficiency, quiescent current, and passive component size. Lower switching frequency implies reduced switching losses (including gate charge losses, transition losses, and so forth) and higher overall efficiency. Higher switching frequency, on the other hand, implies smaller LC output filter and hence, a more compact design. Lower inductance also helps transient response and reduces the inductor DCR conduction loss. The ideal switching frequency in a given application is a tradeoff and thus is determined on a case-by-case basis. It relates to the input voltage, output voltage, most frequent load current level(s), external component choices, and circuit size requirement. At light loads, the PFM converter has a relatively longer sleep time interval and thus operates at lower input quiescent current levels.

7.3.2.2 COT Mode Operation

In COT mode, the LM5166-based converter turns on the high-side MOSFET with constant on-time that adapts to V_{IN} , as defined by Equation 2, to operate with nearly fixed switching frequency when in continuous conduction mode (CCM). The high-side MOSFET turns on when the feedback voltage (V_{FB}) falls below the reference voltage. The regulator control loop maintains a constant output voltage by adjusting the PWM off-time as defined with Equation 3. For stable operation, the feedback voltage must decrease monotonically in phase with the inductor current during the off-time as explained in *Ripple Generation Methods*.

$$t_{ON}[ns] = \frac{175 \cdot R_{RT}[k\Omega]}{V_{IN}} \tag{2}$$

$$t_{OFF} = \frac{L_F \cdot \Delta I_{L(nom)}}{V_{OUT} + (R_{DCR} + R_{DSON2}) \cdot I_{OUT}} \tag{3}$$

Diode emulation mode (DEM) prevents negative inductor current, and pulse skipping maintains high efficiency at light load currents by decreasing the effective switching frequency. The COT-controlled LM5166 waveforms in CCM and DEM are shown in Figure 43.

Feature Description (continued)

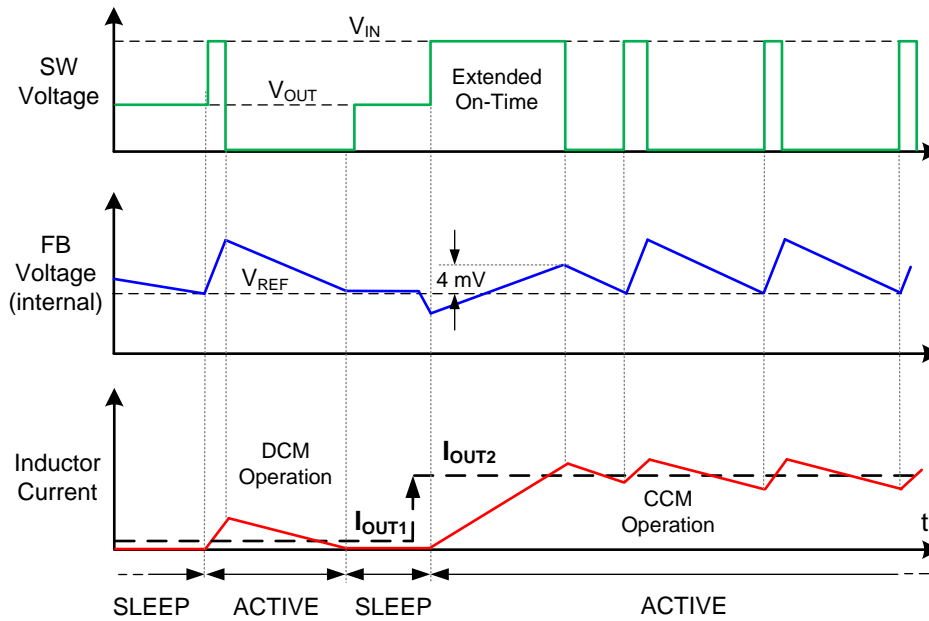

Figure 43. COT Mode Feedback Voltage and Inductor Current Representative Waveforms

The required on-time adjust resistance for a particular frequency (in CCM) is given in Equation 4 and tabulated in Table 1. The maximum programmable on-time is 15 μ s.

$$R_{RT} [k\Omega] = \frac{V_{OUT} [V] \cdot 10^4}{F_{SW} [kHz] \cdot 1.75} \tag{4}$$

Table 1. On-Time Adjust Resistance (E96 EIA Values) for Various Switching Frequencies and Output Voltages⁽¹⁾

F _{SW} (kHz)	R _{RT} (k Ω)			
	V _{OUT} = 1.8 V	V _{OUT} = 3.3 V	V _{OUT} = 5 V	V _{OUT} = 12 V
100	102	187	287	681
200	51.1	95.3	143	340
300	34	63.4	95.3	226
400	25.5	47.5	71.5	169
500	20.5	37.4	57.6	137
600	16.9	31.6	47.5	115

(1) For a more precise adjustment of the switching frequency consider Equation 2 and Equation 3. The LM5166 Quickstart Calculator estimates and plots the switching frequency as a function of load current.

7.3.2.2.1 Ripple Generation Methods

In the Constant-On-Time (COT) control scheme, the on-time is terminated by a one-shot, and the off-time is terminated by the feedback voltage (V_{FB}) falling below the reference voltage (V_{FB1}). Therefore, for stable operation, the feedback voltage must decrease monotonically in phase with the inductor current during the off-time. Furthermore, this change in feedback voltage (V_{FB}) during the off-time must be large enough to dominate any noise present at the feedback node.

Table 2. Ripple Generation Methods

TYPE	SCHEMATIC	CALCULATION
<p>Type 1 Lowest Cost</p>		$R_{ESR} \geq \frac{20mV \cdot V_{OUT}}{V_{FB1} \cdot \Delta I_{L(nom)}} \quad (5)$ $R_{ESR} \geq \frac{V_{OUT}}{2 \cdot V_{IN} \cdot F_{SW} \cdot C_{OUT}} \quad (6)$
<p>Type 2 Reduced Ripple</p>		$R_{ESR} \geq \frac{20mV}{\Delta I_{L(nom)}} \quad (7)$ $R_{ESR} \geq \frac{V_{OUT}}{2 \cdot V_{IN} \cdot F_{SW} \cdot C_{OUT}} \quad (8)$ $C_{FF} \geq \frac{1}{2\pi \cdot F_{SW} \cdot (R_{FB1} \parallel R_{FB2})} \quad (9)$
<p>Type 3⁽¹⁾ Lowest Ripple</p>		$C_A \geq \frac{10}{F_{SW} \cdot (R_{FB1} \parallel R_{FB2})} \quad (10)$ $R_A C_A \leq \frac{(V_{IN-nom} - V_{OUT}) \cdot T_{ON} (@V_{IN-nom})}{20mV} \quad (11)$ $C_B \geq \frac{T_{TR-Settling}}{3 \cdot R_{FB1}} \quad (12)$

(1) Lin, Min and others, "Frequency Domain Analysis of Fixed On-Time With Bottom Detection Control for Buck Converter," IEEE IECON 2010, pp. 481–485.

Table 2 presents three different methods for generating appropriate voltage ripple at the feedback node. Type 1 ripple generation method uses a single resistor, designated R_{ESR} , in series with the output capacitor. The generated voltage ripple has two components:

- Capacitive ripple caused by the inductor ripple current charging and discharging the output capacitor.
- Resistive ripple caused by the inductor ripple current flowing in the output capacitor ESR and series resistance R_{ESR} .

The capacitive ripple component is out of phase with the inductor current. As a result, the capacitive ripple does not decrease monotonically during the off-time. The resistive ripple component is in phase with the inductor current and decreases monotonically during the off-time. The resistive ripple must exceed the capacitive ripple at the output (V_{OUT}) for stable operation. If this condition is not satisfied, unstable switching behavior is observed in COT converters, with multiple on-time bursts in close succession followed by a long off-time. [Equation 5](#) and [Equation 6](#) define the value of the R_{ESR} resistor that ensures the required amplitude and phase of the ripple at the feedback node.

Type-2 ripple generation method uses a C_{FF} capacitor in addition to the R_{ESR} resistor. As the output voltage ripple is directly AC-coupled by C_{FF} to the feedback node, the R_{ESR} value and ultimately the output voltage ripple are reduced by a factor of V_{OUT} / V_{FB1} .

Type-3 ripple generation method uses an RC network consisting of R_A and C_A , and the switch node (SW) voltage to generate a triangular ramp. This triangular ramp is then AC-coupled into the feedback node (FB) with capacitor C_B . Because this circuit does not use the output voltage ripple, it is suited for applications where low output voltage ripple is critical. Application note [AN-1481 Controlling Output Ripple & Achieving ESR Independence in Constant On-Time Regulator Designs](#) provides additional details on this topic.

7.3.2.2.2 COT Mode Light-Load Operation

Diode emulation mode (DEM) operation occurs when the low-side MOSFET switches off as the inductor valley current reaches zero. Here, the load current is less than half of the peak-to-peak inductor current ripple in CCM. Turning off the low-side MOSFET at zero current reduces switching loss, and preventing negative current conduction reduces conduction loss. In DEM, the duration that both high-side and low-side MOSFETs remain off progressively increases as load current decreases.

7.3.3 Low Dropout Operation and 100% Duty Cycle Mode

Using R_{DSON1} and R_{DSON2} for the high-side and low-side MOSFET on-state resistances, respectively, and R_{DCR} for the inductor DC resistance, the duty cycle in COT (CCM) or PFM mode is given by [Equation 13](#).

$$D = \frac{V_{OUT} + (R_{DSON2} + R_{DCR}) \cdot I_{OUT}}{V_{IN} - (R_{DSON1} - R_{DSON2}) \cdot I_{OUT}} \approx \frac{V_{OUT}}{V_{IN}} \quad (13)$$

The LM5166 provides a low input voltage to output voltage dropout by engaging the high-side MOSFET at 100% duty cycle. In COT operation, the extended on-time mode seamlessly increases the duty cycle during low dropout conditions or load-step transients. The buck switch on-time extends based on the requirement that the FB voltage exceeds the internal 4-mV FB comparator hysteresis during any COT mode on-time. The on-time (and duty cycle) are extended as needed at low input voltage conditions until the FB voltage reaches the upper threshold. 100% duty cycle operation is eventually reached as the input voltage decreases to a level near the output voltage setpoint. Very low dropout voltages can be achieved with 100% duty cycle and a low DCR inductor.

Note that PFM mode operation provides a natural transition to 100% duty cycle if needed during low input voltage conditions. If the input-to-output voltage difference is very low, the inductor current increases to a level determined by the load and may not reach the peak current threshold required to turn off the buck switch.

Use [Equation 14](#) to calculate the minimum input voltage to maintain output regulation at 100% duty cycle.

$$V_{IN(min)} = V_{OUT} + I_{OUT} \cdot (R_{DSON1} + R_{DCR}) \quad (14)$$

7.3.4 Adjustable Output Voltage (FB)

Three voltage feedback settings are available. The fixed 3.3-V and 5-V versions include internal feedback resistors that sense the output directly through the VOUT pin, and the adjustable voltage option senses the output through an external resistor divider connected from the output to the FB pin.

The LM5166 voltage regulation loop regulates the output voltage by maintaining the FB voltage equal to the internal reference voltage (V_{FB1}). A resistor divider programs the ratio from output voltage V_{OUT} to FB. For a target V_{OUT} setpoint, calculate R_{FB2} based on the selected R_{FB1} by [Equation 15](#).

$$R_{FB2} = \frac{1.223V}{V_{OUT} - 1.223V} \cdot R_{FB1} \quad (15)$$

R_{FB1} in the range of 100 k Ω to 1 M Ω is recommended for most applications. A larger R_{FB1} consumes less DC current, which is necessary if light-load efficiency is critical. However, R_{FB1} larger than 1 M Ω is not recommended as the feedback path becomes more susceptible to noise. Larger feedback resistances generally require more careful feedback path PCB layout. It is important to route the feedback trace away from the noisy area of the PCB. For more PCB layout recommendations, see [Layout](#).

7.3.5 Adjustable Current Limit

The LM5166 protects the system from overload conditions using cycle-by-cycle current limiting of the peak inductor current. The current sensed in the high-side MOSFET is compared to the current limit threshold set by the ILIM pin (see [Table 3](#)). Current is sensed after a 120-ns leading-edge blanking time following the high-side MOSFET turnon. The propagation delay of the current limit comparator is 80 ns, typical.

Table 3. Current Limit Thresholds

MODE OF OPERATION	R_{ILIM} (k Ω)	TYPICAL I_{HS_LIM} (mA)	TYPICAL I_{LS_LIM} (mA)	$I_{OUT(max)}$ (mA)
COT Mode	0	750	415	500
	$\geq 100^{(1)}$	500	315	300
PFM Mode	0	1250	N/A	500
	24.9	1250 ⁽²⁾	N/A	500
	56.2	750	N/A	300
	$\geq 100^{(1)}$	500	N/A	200

- (1) For this current limit threshold selection, the ILIM pin may also be left open instead of using a 100-k Ω or greater resistor.
- (2) This I_{LIM} setting enables a function that modulates the I_{LIM} levels during the first three switching cycles as illustrated in [Figure 42](#).

Note that in PFM mode, the inductor current ramps from zero to the chosen peak threshold every switching cycle. Consequently, the maximum output current is equal to half the peak inductor current. The output current capability in COT mode is higher and equal to the peak current threshold minus one-half the inductor ripple current. The ripple current is determined by the input and output voltages and the chosen inductance and switching frequency.

7.3.6 Precision Enable (EN) and Hysteresis (HYS)

The precision EN input supports adjustable input undervoltage lockout (UVLO) with hysteresis programmed independently through the HYS pin for application specific power-up and power-down requirements. EN connects to the input of a comparator with 76-mV hysteresis. The reference input of the comparator is connected to a 1.22-V bandgap reference. An external logic signal can be used to drive EN input to toggle the output on and off for system sequencing or protection. The simplest way to enable operation is to connect EN directly to V_{IN} . This allows self-start-up of the LM5166 when V_{IN} is within its valid operating range.

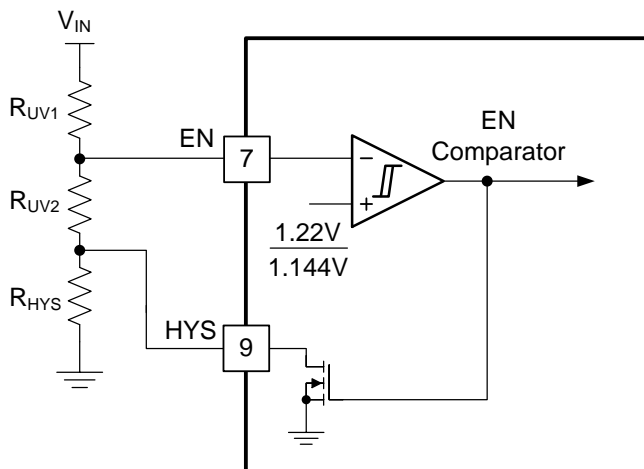

Figure 44. Input Voltage UVLO Using EN and HYS

However, many applications benefit from using a resistor divider R_{UV1} and R_{UV2} as shown in [Figure 44](#) to establish a precision UVLO level. Adding R_{HYS} and the connection to the HYS pin increases the voltage hysteresis as needed.

The input UVLO voltages are calculated using [Equation 16](#) and [Equation 17](#).

$$V_{IN(on)} = 1.22V \cdot \left(1 + \frac{R_{UV1}}{R_{UV2}} \right) \quad (16)$$

$$V_{IN(off)} = 1.144V \cdot \left(1 + \frac{R_{UV1}}{R_{UV2} + R_{HYS}} \right) \quad (17)$$

The LM5166 enters a low I_Q shutdown mode when EN is pulled below an NPN transistor base-emitter voltage drop (approximately 0.6 V at room temperature). If EN is below this hard shutdown threshold, the internal LDO regulator powers off and the internal bias supply rail collapses, turning off the bias currents of the LM5166.

7.3.7 Power Good (PGOOD)

The LM5166 has a built-in PGOOD flag to indicate whether the output voltage is within a regulation window. The PGOOD signal can be used for start-up sequencing of downstream converters, as shown in [Figure 45](#), or fault protection. PGOOD is an open-drain output that requires a pullup resistor to a DC supply (12 V maximum). Typical range of pullup resistance is 10 k Ω to 100 k Ω . If necessary, use a resistor divider to decrease the PGOOD pin voltage from a higher pullup rail.

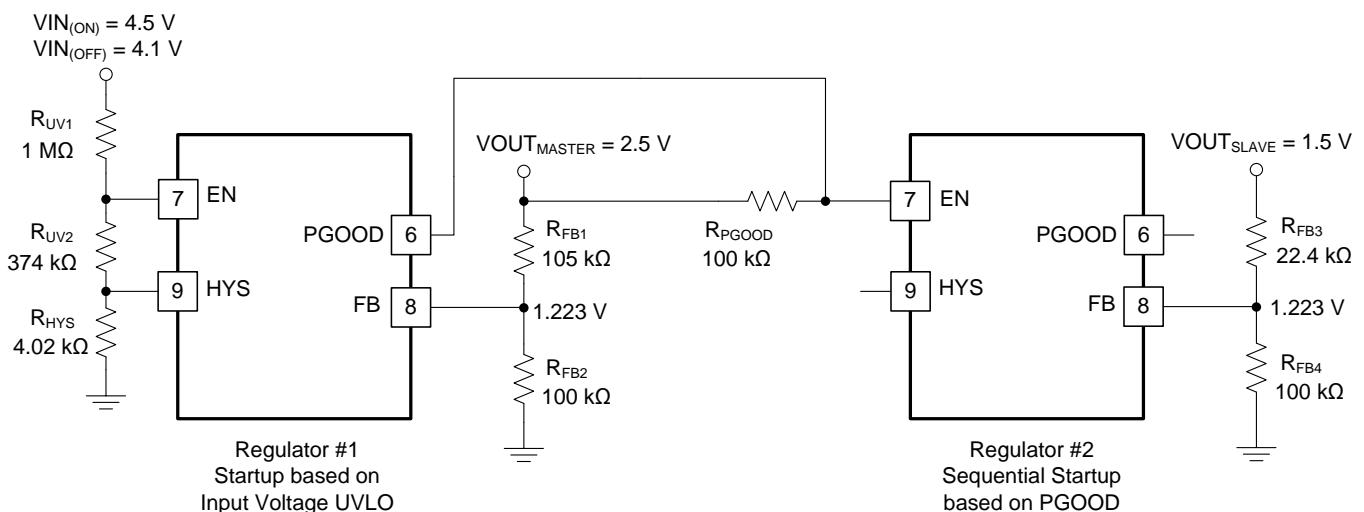

Figure 45. Master-Slave Sequencing Implementation Using PGOOD and EN

When the FB voltage exceeds 94% of the internal reference V_{FB1} , the PGOOD switch turns off and PGOOD will be pulled high. If the FB voltage falls below 87% of V_{FB1} , the PGOOD switch turns on, and PGOOD pulls low to indicate *power bad*. The rising edge of PGOOD has a built-in noise filter delay of 5 μ s.

7.3.8 Configurable Soft Start (SS)

The LM5166 has a flexible and easy-to-use start-up control through the SS pin. A soft-start feature prevents inrush current impacting the LM5166 and its supply when power is first applied. Soft start is achieved by slowly ramping up the target regulation voltage when the device is enabled or powered up. Selectable and adjustable soft-start timing options include minimum delay (no soft-start), 900- μ s internally fixed soft-start, and an externally-adjustable soft start.

The simplest way to use the LM5166 is to leave the SS pin open circuit for a 900- μ s soft-start time. The LM5166 will employ the internal soft-start control ramp and start-up to the regulated output voltage. In applications with a large amount of output capacitors, higher V_{OUT} , or other special requirements, extend the soft-start time by connecting an external capacitor C_{SS} from SS to GND. Longer soft-start time further reduces the supply current needed to charge the output capacitors. An internal current source ($I_{SS} = 10 \mu$ A) charges C_{SS} and generates a ramp to control the ramp rate of the output voltage. For a desired soft-start time t_{SS} , the C_{SS} capacitance is:

$$C_{SS} [nF] = 8.1 \cdot t_{SS} [ms] \tag{18}$$

C_{SS} is discharged by an internal 80-Ω FET when V_{OUT} is shutdown by EN, UVLO, or thermal shutdown.

It is desirable in some applications for the output voltage to reach its nominal setpoint in the shortest possible time. Connecting a 100-kΩ resistor from SS to GND disables the soft-start circuit of the LM5166, and the LM5166 operates in current limit during start-up to rapidly charge the output capacitance.

Diode emulation mode (DEM) of the LM5166 prevents negative inductor current enabling monotonic start-up under prebiased output conditions. With a prebiased output voltage, the LM5166 waits until the soft-start ramp allows regulation above the prebiased voltage and then follows the soft-start ramp to the regulation setpoint as shown in [Figure 46](#) and [Figure 47](#).

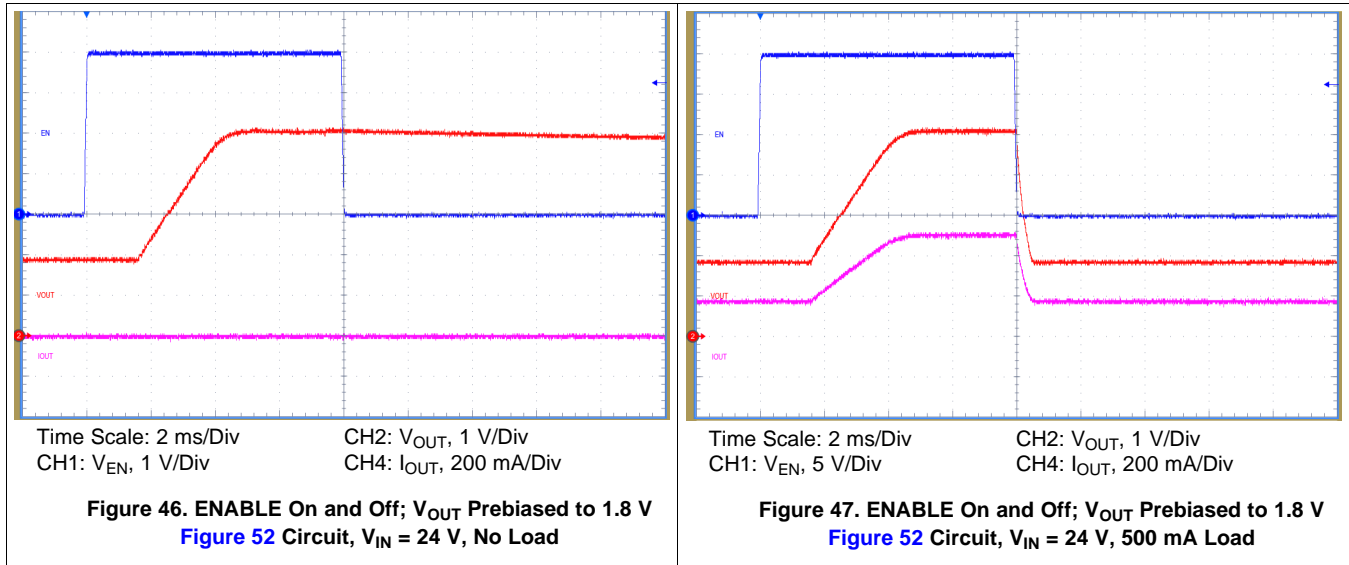

7.3.9 Short-Circuit Operation

The LM5166 features a clamping circuit that clamps the SS voltage about 175 mV above the FB voltage (see [Figure 48](#) and [Figure 49](#)). The circuit is enabled in COT mode and only works when an external soft-start capacitor is connected.

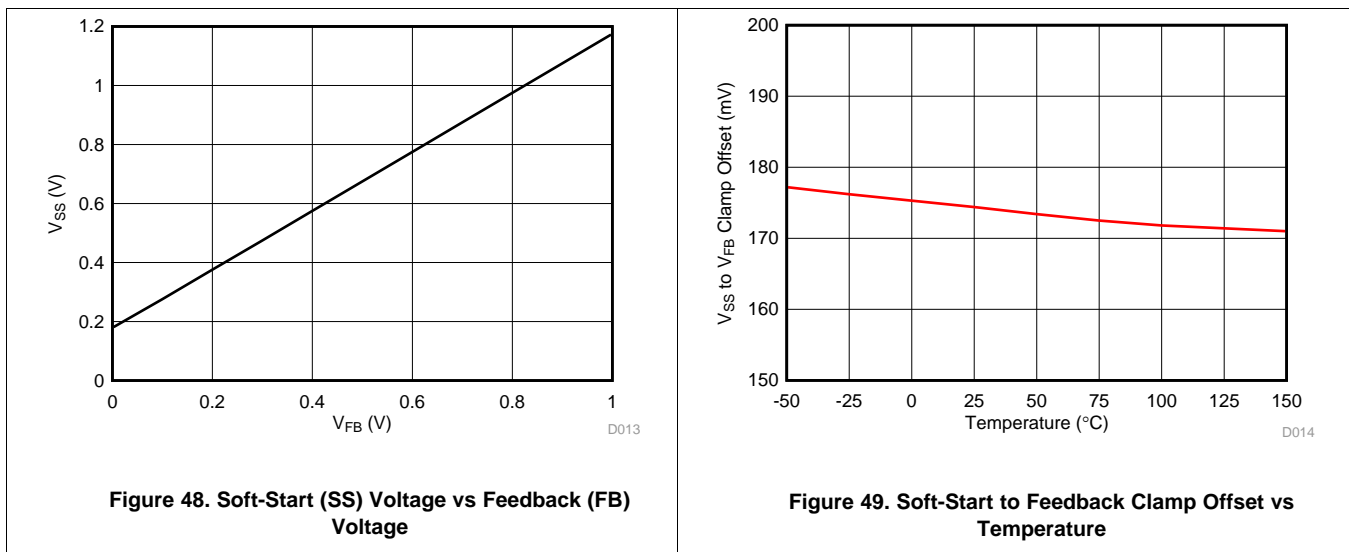

In case of an overload event such as an output short circuit, the clamping circuit discharges the soft-start capacitor. When the short is removed, the FB voltage quickly rises until it reaches the level of the SS pin. Then, the recovery continues under the soft-start capacitor control. [Figure 50](#) and [Figure 51](#) show short-circuit entry and recovery waveforms.

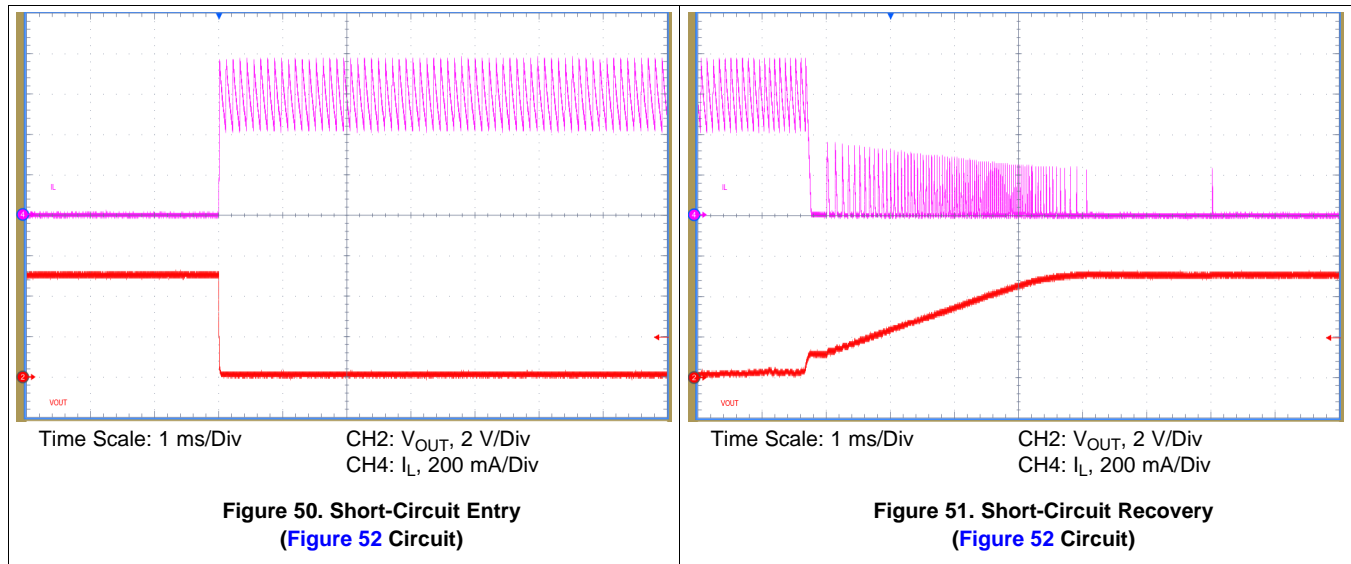

7.3.10 Thermal Shutdown

Thermal shutdown is a built-in self protection to limit junction temperature and prevent damage related to overheating. Thermal shutdown turns off the device when the junction temperature exceeds 170°C typically to prevent further power dissipation and temperature rise. Junction temperature decreases during thermal shutdown, and the LM5166 restarts when the junction temperature falls to 160°C.

7.4 Device Functional Modes

7.4.1 Shutdown Mode

The EN pin provides ON / OFF control for the LM5166. When V_{EN} is below 0.3 V, the device is in shutdown mode. Both the internal LDO and the switching regulator are off. The quiescent current in shutdown mode drops to 4 μ A (typical) at $V_{IN} = 12$ V. The LM5166 also includes undervoltage protection of the internal bias LDO. If the internal bias supply voltage is below the UV threshold level, the switching regulator remains off.

7.4.2 Standby Mode

The internal bias LDO has a lower enable threshold than the switching regulator. When V_{EN} is above 0.6 V and below the precision enable threshold (1.22 V typically), the internal LDO is on and regulating. The precision enable circuitry is turned on if the LDO output is above the bias rail UV threshold. The switching action and output voltage regulation are disabled in the standby mode.

7.4.3 Active Mode – COT

The LM5166 is in active mode when V_{EN} is above the precision enable threshold and the internal bias rail is above its UV threshold level. In COT active mode, the LM5166 operates in one of three modes depending on the load current:

1. CCM with fixed switching frequency when the load current is more than half of the peak-to-peak inductor current ripple;
2. Pulse skipping and diode emulation mode when load current is less than half of the peak-to-peak inductor current ripple of CCM operation;
3. Extended on-time mode when V_{IN} is nearly equal to V_{OUT} (dropout) and during load step transients.

7.4.4 Sleep Mode – COT

The LM5166 is in COT sleep mode when V_{EN} and V_{IN} are above their relevant threshold levels, FB has exceeded its upper hysteresis level, and the output capacitor is sourcing the load current. In COT sleep mode, the LM5166 operates with very low quiescent current (9.7 μ A typical). There is a 2- μ s wake-up delay from sleep to active modes.

7.4.5 Active Mode – PFM

The LM5166 is in PFM active mode when V_{EN} and V_{IN} are above their relevant thresholds, FB has fallen below the lower hysteresis level, and boundary conduction mode switching is recharging the output capacitor to the upper hysteresis level.

7.4.6 Sleep Mode – PFM

The LM5166 is in PFM sleep mode when V_{EN} and V_{IN} are above their relevant threshold levels, FB has exceeded the upper hysteresis level, and the output capacitor is sourcing the load current. In PFM sleep mode, the LM5166 operates with very low quiescent current (9.7 μ A typical). There is a 2- μ s wake-up delay from sleep to active modes.

8 Applications and Implementation

NOTE

Information in the following applications sections is not part of the TI component specification, and TI does not warrant its accuracy or completeness. TI's customers are responsible for determining suitability of components for their purposes. Customers should validate and test their design implementation to confirm system functionality.

8.1 Application Information

The LM5166 only requires a few external components to convert from a wide range of supply voltages to a fixed output voltage. To expedite and streamline the process of designing a LM5166-based converter, a comprehensive [LM5166 Quickstart Calculator](#) is available for download to assist the designer with component selection for a given application. [WEBENCH®](#) online software is also available to generate complete designs, leveraging iterative design procedures and access to comprehensive component databases. The following sections discuss the design procedure for both COT and PFM converters using specific circuit design examples.

The LM5166 integrates several optional features to meet system design requirements, including precision enable, UVLO, programmable soft start, programmable switching frequency in COT mode, adjustable current limit, and PGOOD indicator. Each application incorporates these features as needed for a more comprehensive design. The application circuits detailed below show LM5166 configuration options suitable for several application use cases. Please see the [LM5166EVM-C50A](#) and [LM5166EVM-C33A](#) EVM user's guides for more detail.

8.2 Typical Applications



For step-by-step design procedure, circuit schematics, bill of materials, PCB files, simulation and test results of an LM5166-powered implementation, refer to [24-V AC Power Stage with Wide \$V_{IN}\$ Converter and Battery Gauge for Smart Thermostat](#) reference design.

8.2.1 Design 1: Wide V_{IN} , Low I_Q , High-Efficiency COT Converter Rated at 5 V, 500 mA

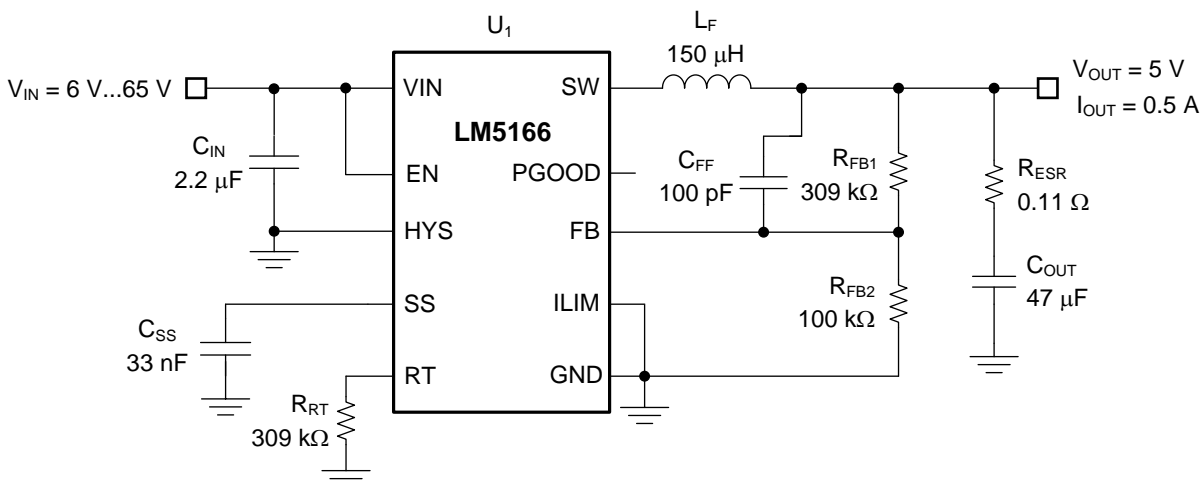

Copyright © 2016, Texas Instruments Incorporated

Figure 52. Schematic for Design 1 With $V_{IN(nom)} = 24\text{ V}$, $V_{OUT} = 5\text{ V}$, $I_{OUT(max)} = 500\text{ mA}$, $F_{SW(nom)} = 100\text{ kHz}$

8.2.1.1 Design Requirements

The target efficiency is 90% for loads above 10 mA based on a nominal input voltage of 24 V and an output voltage of 5 V. The required input voltage range is 6 V to 65 V. The LM5166 is chosen to deliver a 5-V output voltage. The switching frequency is set at 100 kHz. The output voltage soft-start time is 4 ms. The required components are listed in [Table 4](#).

Table 4. List of Components for Design 1⁽¹⁾

COUNT	REF DES	DESCRIPTION	PART NUMBER	MFR
1	C _{IN}	Capacitor, Ceramic, 2.2 μF, 100 V, X7R, 10%, 1210	GRM32ER72A225KA35L	Murata
1	C _{OUT}	Capacitor, Ceramic, 47 μF, 10 V, X7R, 10%, 1210	GRM32ER71A476KE15L	Murata
1	C _{SS}	Capacitor, Ceramic, 33 nF, 16 V, X7R, 10%, 0402	Std	Std
1	C _{FF}	Capacitor, Ceramic, 100 pF, 50 V, X7R, 10%, 0402	Std	Std
1	L _F	Inductor, 150 μH, 0.240 Ω typ, 1.4 A Isat, 5 mm max	7447714151	Würth
		Inductor, 150 μH, 0.285 Ω typ, 1.12 A Isat, 5.1 mm max	CDRH105RNP-151NC	Sumida
1	R _{RT}	Resistor, Chip, 309 kΩ, 1/16W, 1%, 0402	Std	Std
1	R _{FB1}	Resistor, Chip, 309 kΩ, 1/16W, 1%, 0402	Std	Std
1	R _{ESR}	Resistor, Chip, 0.11 Ω, 1/16W, 1%, 0402	Std	Std
1	R _{FB2}	Resistor, Chip, 100 kΩ, 1/16W, 1%, 0402	Std	Std
1	U ₁	LM5166, Synchronous Buck Converter, VSON-10, ADJ	LM5166DRCR	TI

(1) See [Third-Party Products Disclaimer](#).

8.2.1.2 Detailed Design Procedure

8.2.1.2.1 Custom Design With WEBENCH® Tools

[Click here](#) to create a custom design using the LM5166 device with the WEBENCH® Power Designer.

1. Start by entering the input voltage (V_{IN}), output voltage (V_{OUT}), and output current (I_{OUT}) requirements.
2. Optimize the design for key parameters such as efficiency, footprint, and cost using the optimizer dial.
3. Compare the generated design with other possible solutions from Texas Instruments.

The WEBENCH Power Designer provides a customized schematic along with a list of materials with real-time pricing and component availability.

In most cases, these actions are available:

- Run electrical simulations to see important waveforms and circuit performance
- Run thermal simulations to understand board thermal performance
- Export customized schematic and layout into popular CAD formats
- Print PDF reports for the design, and share the design with colleagues

Get more information about WEBENCH tools at www.ti.com/WEBENCH.

8.2.1.2.2 Feedback Resistors – R_{FB1}, R_{FB2}

While the 5-V fixed output version of the LM5166 is suitable here, the adjustable version is chosen to provide the user with the option to trim or margin the output voltage if needed. The feedback resistor divider network comprises the upper feedback resistor R_{FB1} and lower feedback resistor R_{FB2}. Select R_{FB1} of 309 kΩ to minimize quiescent current and improve light-load efficiency in this application. With the desired output voltage setpoint of 5 V and $V_{FB} = 1.223$ V, calculate the resistance of R_{FB2} using [Equation 15](#) as 100.1 kΩ. Choose the closest available standard value of 100 kΩ for R_{FB2}. See [Adjustable Output Voltage \(FB\)](#) for more details.

8.2.1.2.3 Switching Frequency – R_T

The switching frequency of a COT-configured LM5166 is set by the on-time programming resistor at the RT pin. Using [Equation 4](#), a standard 1% resistor of 309 kΩ gives a switching frequency of 92 kHz. Including the inductor R_{DCR} and R_{DSON2} in the calculation of t_{OFF} ([Equation 3](#)) gives an adjusted F_{SW} of 101 kHz at 500 mA. The [LM5166 Quickstart Calculator](#) estimates and plots the switching frequency as a function of load current.

Note that at very low duty cycles, the minimum controllable on-time of the high-side MOSFET, T_{ON(min)}, of 180 ns may affect choice of switching frequency. In CCM, T_{ON(min)} limits the voltage conversion step-down ratio for a given switching frequency. The minimum controllable duty cycle is given by [Equation 19](#).

$$D_{MIN} = T_{ON(min)} \cdot F_{SW} \quad (19)$$

Given a fixed $T_{ON(min)}$, it follows that higher switching frequency implies a larger minimum controllable duty cycle. Ultimately, the choice of switching frequency for a given output voltage affects the available input voltage range, solution size, and efficiency. The maximum supply voltage for a given $T_{ON(min)}$ before switching frequency reduction occurs is given by [Equation 20](#).

$$V_{IN(max)} = \frac{V_{OUT}}{T_{ON(min)} \cdot F_{SW}} \quad (20)$$

8.2.1.2.4 Filter Inductance – L_F

The inductor ripple current (assuming CCM operation) and peak inductor current are given respectively by [Equation 21](#) and [Equation 22](#).

$$\Delta I_L = \frac{V_{OUT}}{F_{SW} \cdot L_F} \cdot \left(1 - \frac{V_{OUT}}{V_{IN}}\right) \quad (21)$$

$$I_{L(peak)} = I_{OUT(max)} + \frac{\Delta I_L}{2} \quad (22)$$

For most applications, choose the inductance such that the inductor ripple current, ΔI_L , is between 30% and 60% of the rated load current at nominal input voltage. Calculate the inductance using [Equation 23](#).

$$L_F = \frac{V_{OUT}}{F_{SW} \cdot \Delta I_{L(nom)}} \cdot \left(1 - \frac{V_{OUT}}{V_{IN(nom)}}\right) \quad (23)$$

Choosing a 150- μ H inductor in this design results in 295-mA peak-to-peak ripple current at nominal input voltage of 24 V, equivalent to 59% of the 500-mA rated load current. The peak inductor current at maximum input voltage of 65 V is 675 mA, which is sufficiently below the LM5166 peak current limit of 750 mA.

Check the inductor datasheet to ensure that the inductor saturation current is well above the current limit setting of a particular design. Ferrite designs have low core loss and are preferred at high switching frequencies, so design goals can then concentrate on copper loss and preventing saturation. However, ferrite core materials exhibit a hard saturation characteristic – the inductance collapses abruptly when the saturation current is exceeded. This results in an abrupt increase in inductor ripple current, higher output voltage ripple, not to mention reduced efficiency and compromised reliability. Note that inductor saturation current generally decreases as the core temperature increases.

8.2.1.2.5 Output Capacitors – C_{OUT}

Select the output capacitor to limit the capacitive voltage ripple at the converter output. This is the sinusoidal ripple voltage that arises from the triangular ripple current flowing in the capacitor. Select an output capacitance using [Equation 24](#) to limit the capacitive voltage ripple component to 0.5% of the output voltage.

$$C_{OUT} \geq \frac{\Delta I_{L(nom)}}{8 \cdot F_{SW} \cdot \Delta V_{OUT}} \quad (24)$$

Substituting $\Delta I_{L(nom)}$ of 295 mA and ΔV_{OUT} of 25 mV gives C_{OUT} greater than 16 μ F. Mindful of the voltage coefficient of ceramic capacitors, select a 47- μ F, 10-V capacitor with a high-quality dielectric.

8.2.1.2.6 Ripple Generation Network – R_{ESR} , C_{FF}

For this design, the Type 2 ripple generation method is selected as it offers a good balance between cost and output voltage ripple. For other methods, see [Ripple Generation Methods](#).

Select a series resistor, R_{ESR} , such that sufficient ripple in phase with the inductor current ripple appears at the feedback node, FB, using [Equation 7](#) and [Equation 8](#). Select a feedforward capacitor, C_{FF} , using [Equation 9](#).

With $\Delta I_{L(nom)}$ of 295 mA at the nominal input voltage of 24 V, the required R_{ESR} is 0.11 Ω . The required feedforward capacitance, C_{FF} , is 100 pF. Calculate the total output voltage ripple in CCM using [Equation 25](#).

$$\Delta V_{OUT} = \Delta I_{L(nom)} \cdot \sqrt{R_{ESR}^2 + \left(\frac{1}{8 \cdot F_{SW} \cdot C_{OUT}}\right)^2} \quad (25)$$

8.2.1.2.7 Input Capacitor – C_{IN}

An input capacitor is necessary to limit the input ripple voltage while providing switching-frequency AC current to the buck power stage. To minimize the parasitic inductance in the switching loop, position the input capacitors as close as possible to the VIN and GND pins of the LM5166. The input capacitors conduct a trapezoidal-wave current of peak-to-peak amplitude equal to the output current. It follows that the resultant capacitive component of AC ripple voltage is a triangular waveform. Together with the ESR-related ripple component, the peak-to-peak input ripple voltage amplitude is given by Equation 26.

$$\Delta V_{IN} = \frac{I_{OUT} \cdot D \cdot (1-D)}{F_{SW} \cdot C_{IN}} + I_{OUT} \cdot R_{ESR} \tag{26}$$

The input capacitance required for a particular load current, based on an input voltage ripple specification of ΔVIN, is given by Equation 27.

$$C_{IN} \geq \frac{I_{OUT} \cdot D \cdot (1-D)}{F_{SW} \cdot (\Delta V_{IN} - I_{OUT} \cdot R_{ESR})} \tag{27}$$

The recommended high-frequency input capacitance is 2.2 μF or higher and should be a high-quality ceramic component with sufficient voltage rating. Based on the voltage coefficient of ceramic capacitors, choose a voltage rating of twice the maximum input voltage. Additionally, some bulk capacitance is required if the LM5166 circuit is not located within approximately 5 cm from the input voltage source. This capacitor provides damping to the resonance associated with parasitic inductance of the supply lines and high-Q ceramics.

8.2.1.2.8 Soft-Start Capacitor – C_{SS}

Connect an external soft-start capacitor for a specific soft-start time. In this example, select a soft-start capacitance of 33 nF based on Equation 18 to achieve a soft-start time of 4 ms.

8.2.1.2.9 Application Curves

Unless otherwise stated, application performance curves were taken at T_A = 25°C.

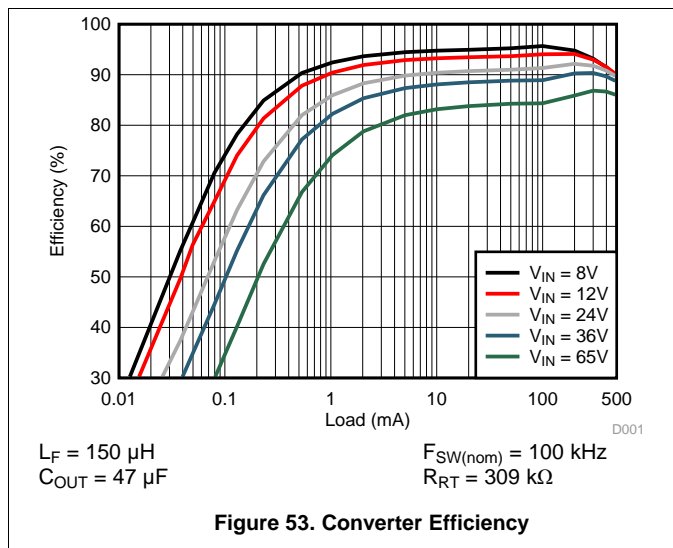

Figure 53. Converter Efficiency

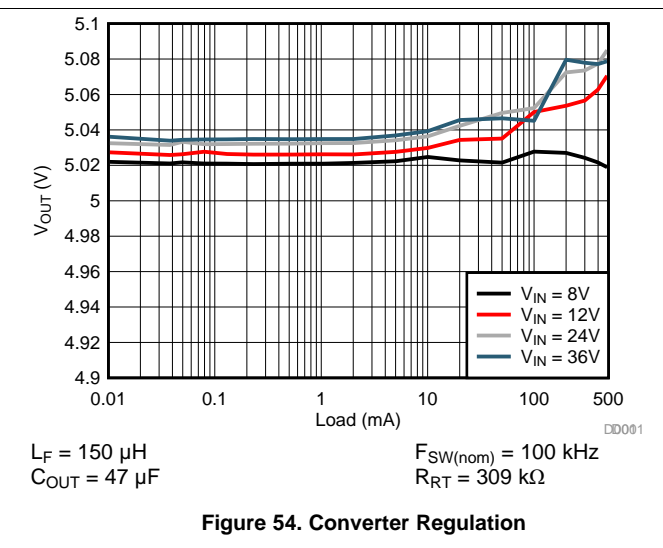
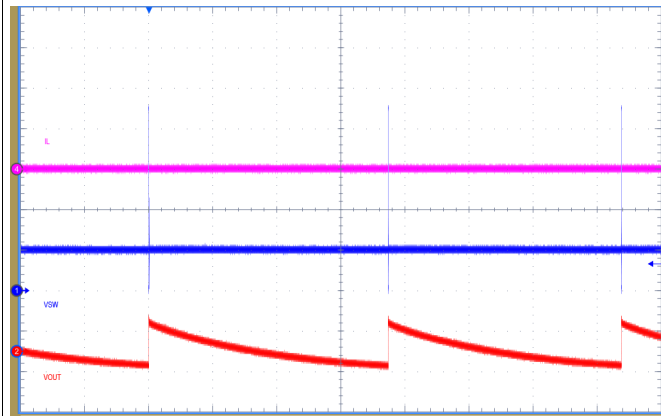
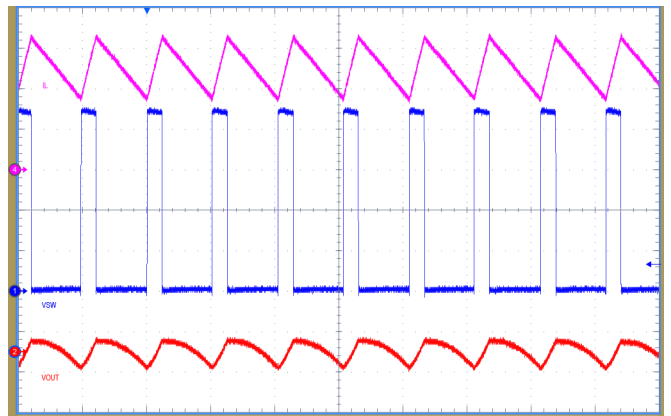

Figure 54. Converter Regulation



Time Scale: 20 ms/Div
CH1: V_{SW} , 5 V/Div
CH2: V_{OUT} , 50 mV/Div
CH4: I_L , 200 mA/Div

Figure 55. No-Load Switching Waveforms, $V_{IN} = 24\text{ V}$



Time Scale: 10 μ s/Div
CH1: V_{SW} , 5 V/Div
CH2: V_{OUT} , 50 mV/Div
CH4: I_L , 200 mA/Div

Figure 56. Full-Load Switching Waveforms, $V_{IN} = 24\text{ V}$

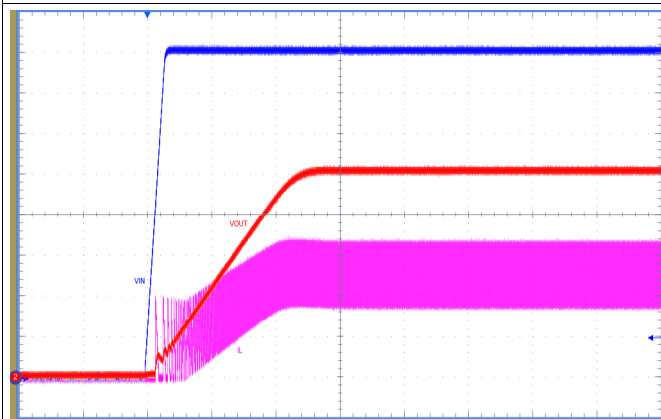

Time Scale: 2 ms/Div
CH1: V_{IN} , 3 V/Div
CH2: V_{OUT} , 1 V/Div
CH4: I_L , 200 mA/Div

Figure 57. Full-Load Start-Up, $V_{IN} = 24\text{ V}$

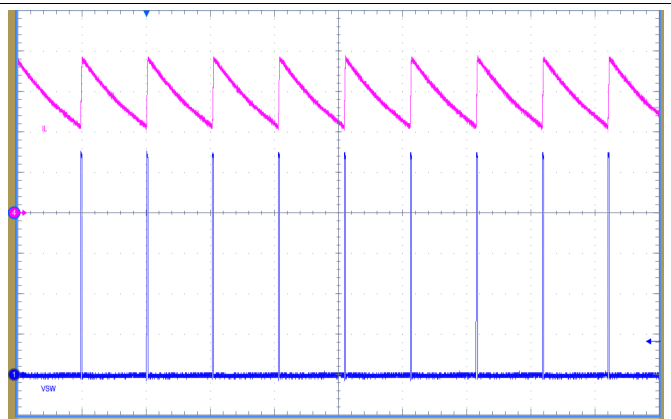

Time Scale: 100 μ s/Div
CH1: V_{SW} , 4 V/Div
CH4: I_L , 200 mA/Div

Figure 58. Short Circuit, $V_{IN} = 24\text{ V}$

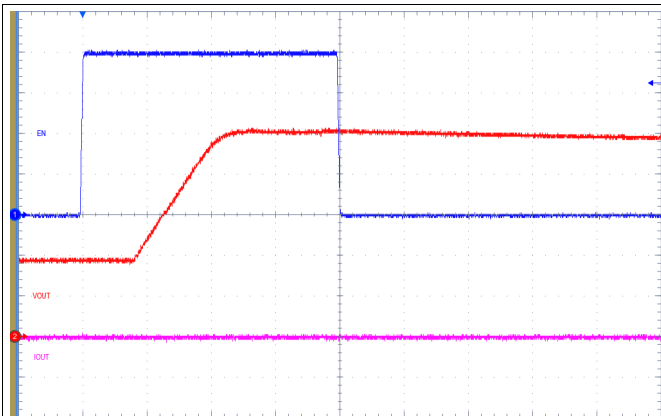

Time Scale: 2 ms/Div
CH1: V_{EN} , 1 V/Div
CH2: V_{OUT} , 1 V/Div
CH4: I_{OUT} , 200 mA/Div

Figure 59. ENABLE On and Off; V_{OUT} Prebiased to 1.8 V
 $V_{IN} = 24\text{ V}$, No Load

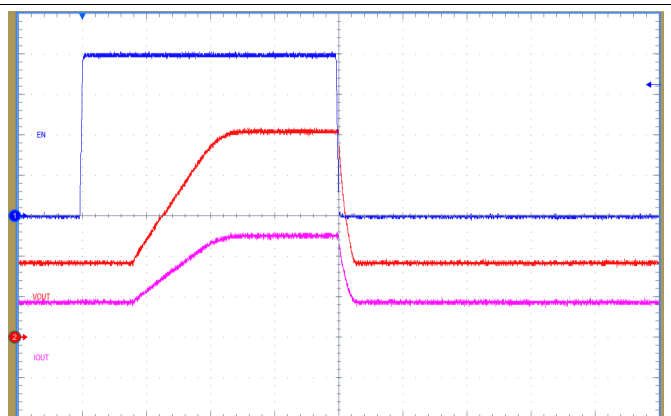

Time Scale: 2 ms/Div
CH1: V_{EN} , 5 V/Div
CH2: V_{OUT} , 1 V/Div
CH4: I_{OUT} , 200 mA/Div

Figure 60. ENABLE On and Off; V_{OUT} Prebiased to 1.8 V
 $V_{IN} = 24\text{ V}$, 500 mA Load

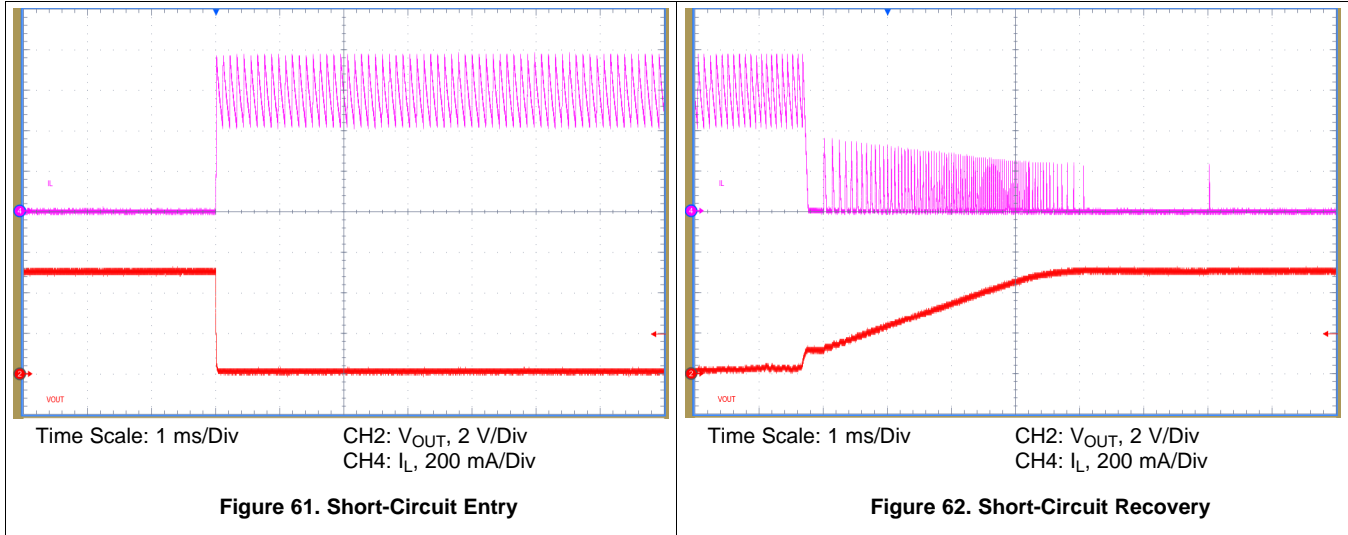

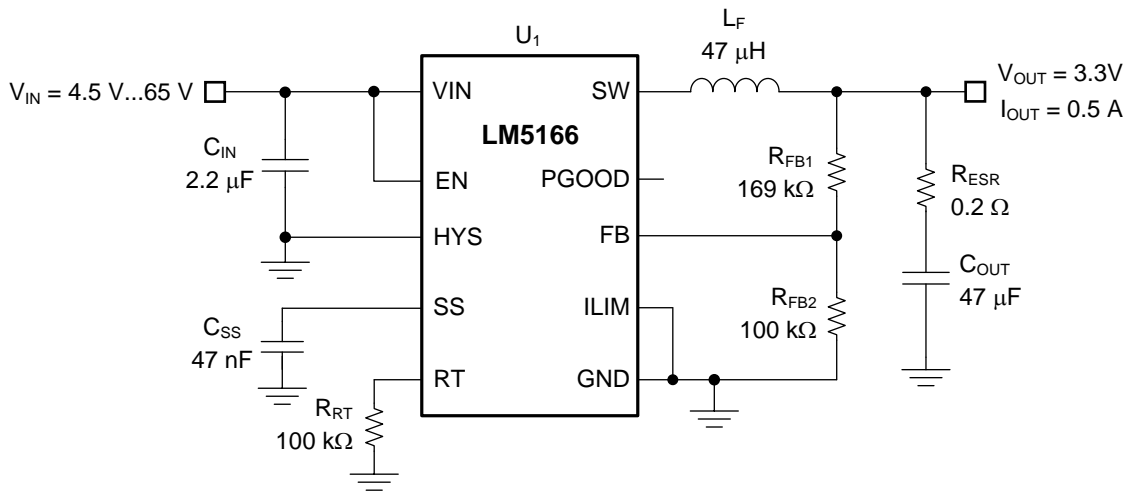
8.2.2 Design 2: Wide V_{IN} , Low I_Q COT Converter Rated at 3.3 V, 500 mA

Copyright © 2016, Texas Instruments Incorporated

Figure 63. Schematic for Design 2 With $V_{IN(nom)} = 12\text{ V}$, $V_{OUT} = 3.3\text{ V}$, $I_{OUT(max)} = 500\text{ mA}$, $F_{SW(nom)} = 200\text{ kHz}$
8.2.2.1 Design Requirements

The target efficiency is 85% for loads above 10 mA based on a nominal input voltage of 12 V and an output voltage of 3.3 V. The required input voltage range is 4.5 V to 65 V. The LM5166 is chosen to deliver a 3.3-V output voltage. The switching frequency is set at 200 kHz. The output voltage soft-start time is 4 ms. The required components are listed in [Table 5](#).

Table 5. List of Components for Design 2⁽¹⁾

COUNT	REF DES	DESCRIPTION	PART NUMBER	MFR
1	C _{IN}	Capacitor, Ceramic, 2.2 μF, 100 V, X7R, 10%, 1210	GRM32ER72A225KA35L	Murata
1	C _{OUT}	Capacitor, Ceramic, 47 μF, 10 V, X7R, 10%, 1210	GRM32ER71A476KE15L	Murata
1	C _{SS}	Capacitor, Ceramic, 47 nF, 16 V, X7R, 10%, 0402	Std	Std
1	L _F	Inductor, 47 μH, 0.245 Ω max, 1.2 A Isat, 3.5 mm max	LPS6235-473MR	Coilcraft
		Inductor, 47 μH, 0.315 Ω typ, 1.3 A Isat, 2.8 mm max	74404063470	Würth
1	R _{RT}	Resistor, Chip, 100 kΩ, 1/16W, 1%, 0402	Std	Std
1	R _{FB1}	Resistor, Chip, 169 kΩ, 1/16W, 1%, 0402	Std	Std
1	R _{ESR}	Resistor, Chip, 0.2 Ω, 1/16W, 1%, 0402	Std	Std
1	R _{FB2}	Resistor, Chip, 100 kΩ, 1/16W, 1%, 0402	Std	Std
1	U ₁	LM5166, Synchronous Buck Converter, VSON-10, ADJ	LM5166DRCR	TI

(1) See [Third-Party Products Disclaimer](#).

8.2.2.2 Detailed Design Procedure
8.2.2.2.1 Feedback Resistors – R_{FB1}, R_{FB2}

The output voltage of the LM5166 is externally adjustable using a resistor divider network. The divider network comprises the upper feedback resistor R_{FB1} and lower feedback resistor R_{FB2}. Select R_{FB1} of 169 kΩ to minimize quiescent current and improve light-load efficiency in this application. With the desired output voltage setpoint of 3.3 V and $V_{FB} = 1.223\text{ V}$, calculate the resistance of R_{FB2} using [Equation 15](#) as 100.1 kΩ. Choose the closest available standard value of 100 kΩ for R_{FB2}. See [Adjustable Output Voltage \(FB\)](#) for more detail.

8.2.2.2.2 Switching Frequency – R_T

The switching frequency of a COT-configured LM5166 is set by the on-time programming resistor at the R_T pin. Using [Equation 4](#), a standard 1% resistor of 100 k Ω gives a switching frequency of 190 kHz. Including the inductor R_{DCR} and $R_{DS(on)2}$ in the calculation of t_{OFF} ([Equation 3](#)) gives an adjusted F_{SW} of 215 kHz at 500 mA. The *LM5166 Quick-Start Design Tool* estimates and plots the switching frequency as a function of load current.

Note that at very low duty cycles, the minimum controllable on-time of the high-side MOSFET, $T_{ON(min)}$, of 180 ns may affect choice of switching frequency. In CCM, $T_{ON(min)}$ limits the voltage conversion step-down ratio for a given switching frequency. The minimum controllable duty cycle is given by [Equation 19](#).

Given a fixed $T_{ON(min)}$, it follows that higher switching frequency implies a larger minimum controllable duty cycle. Ultimately, the choice of switching frequency for a given output voltage affects the available input voltage range, solution size, and efficiency. The maximum supply voltage for a given $T_{ON(min)}$ before switching frequency reduction occurs is given by [Equation 20](#).

8.2.2.2.3 Filter Inductance – L_F

The inductor ripple current (assuming CCM operation) and peak inductor current are given respectively by [Equation 21](#) and [Equation 22](#). For most applications, choose an inductance such that the inductor ripple current, ΔI_L , is between 30% and 60% of the rated load current at nominal input voltage. Calculate the inductance using [Equation 23](#).

Choosing a 47- μ H inductor in this design results in 275-mA peak-to-peak ripple current at nominal input voltage of 12 V, equivalent to 55% of the 500-mA rated load current. The peak inductor current at maximum input voltage of 65 V is 694 mA, which is sufficiently below the LM5166 peak current limit of 750 mA.

8.2.2.2.4 Output Capacitors – C_{OUT}

Select the output capacitor to limit the capacitive voltage ripple at the converter output. This is the sinusoidal ripple voltage that arises from the triangular ripple current flowing in the capacitor. Select an output capacitance using [Equation 24](#) to limit the capacitive voltage ripple component to 0.5% of the output voltage.

Substituting $\Delta I_{L(nom)}$ of 275 mA and ΔV_{OUT} of 25 mV gives C_{OUT} greater than 11 μ F. Mindful of the voltage coefficient of ceramic capacitors, select a 47- μ F, 10-V capacitor with a high-quality dielectric.

8.2.2.2.5 Ripple Generation Network – R_{ESR}

For this design, the Type 1 ripple generation method is selected as it only requires a single external component. For other schemes, see [Ripple Generation Methods](#).

Select a series resistor, R_{ESR} , using [Equation 5](#) and [Equation 6](#) such that sufficient ripple in phase with the SW node voltage appears at the feedback node, FB. With $\Delta I_{L(nom)}$ of 275 mA at the nominal input voltage of 12 V, the required R_{ESR} is 0.2 Ω . Calculate the total output voltage ripple in CCM using [Equation 25](#).

8.2.2.2.6 Input Capacitor – C_{IN}

An input capacitor is necessary to limit the input ripple voltage while providing switching-frequency AC current to the buck power stage. To minimize the parasitic inductance in the switching loop, position the input capacitors as close as possible to the VIN and GND pins of the LM5166. The input capacitors conduct a trapezoidal-wave current of peak-to-peak amplitude equal to the output current. It follows that the resultant capacitive component of AC ripple voltage is a triangular waveform. Together with the ESR-related ripple component, the peak-to-peak input ripple voltage amplitude is given by [Equation 26](#). The input capacitance required for a particular load current, based on an input voltage ripple specification of ΔV_{IN} , is given by [Equation 27](#).

The recommended high-frequency capacitance is 2.2 μ F or higher and should be a high-quality ceramic with sufficient voltage rating. Based on the voltage coefficient of ceramic capacitors, choose a voltage rating of twice the maximum input voltage. Additionally, some bulk capacitance is required if the LM5166 circuit is not located within approximately 5 cm from the input voltage source. This capacitor provides damping to the resonance associated with parasitic inductance of the supply lines and high-Q ceramics.

8.2.2.2.7 Soft-Start Capacitor – C_{SS}

Connect an external soft-start capacitor for a specific soft-start time. In this example, select a soft-start capacitance of 47 nF based on [Equation 18](#) to achieve a soft-start time of 6 ms.

8.2.2.8 Application Curves

Unless otherwise stated, application curves were taken at $T_A = 25^\circ\text{C}$.

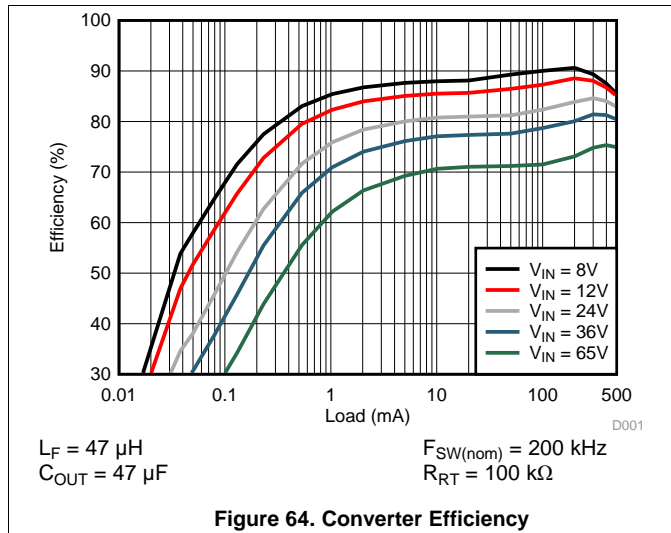

Figure 64. Converter Efficiency

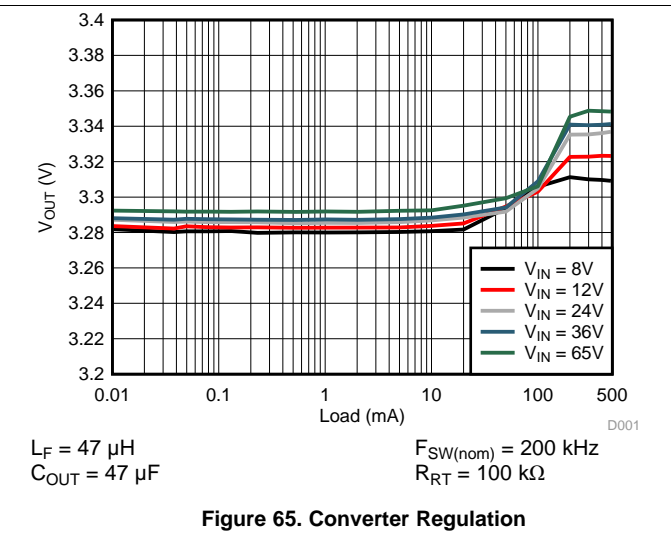

Figure 65. Converter Regulation

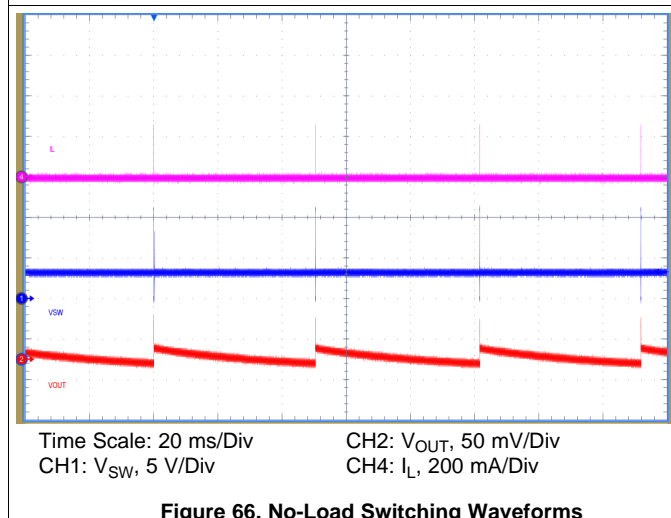

Figure 66. No-Load Switching Waveforms

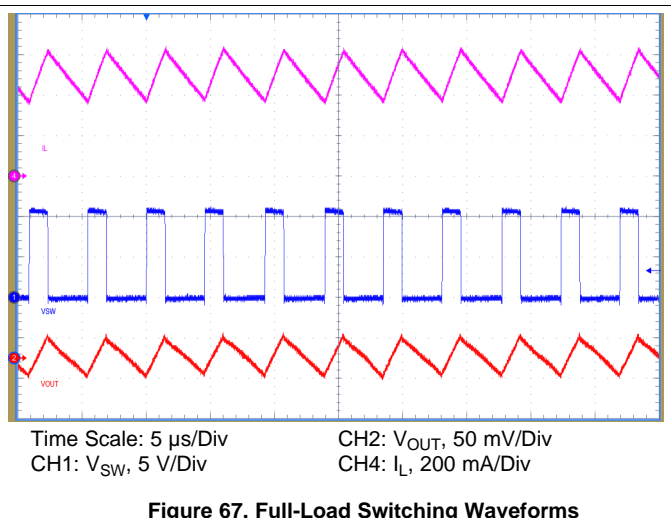

Figure 67. Full-Load Switching Waveforms

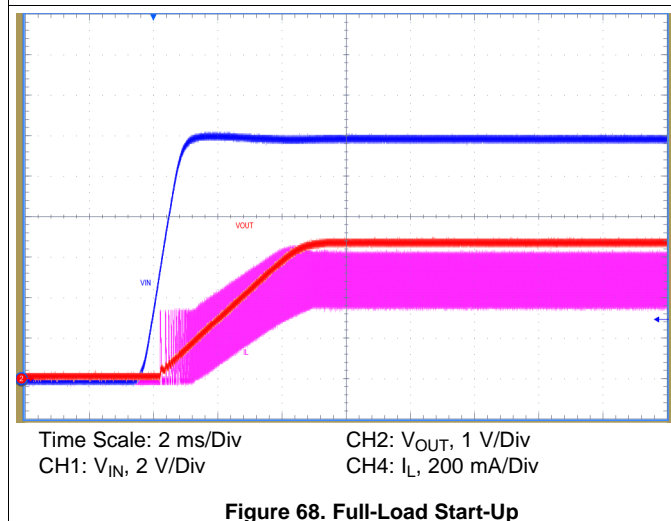

Figure 68. Full-Load Start-Up

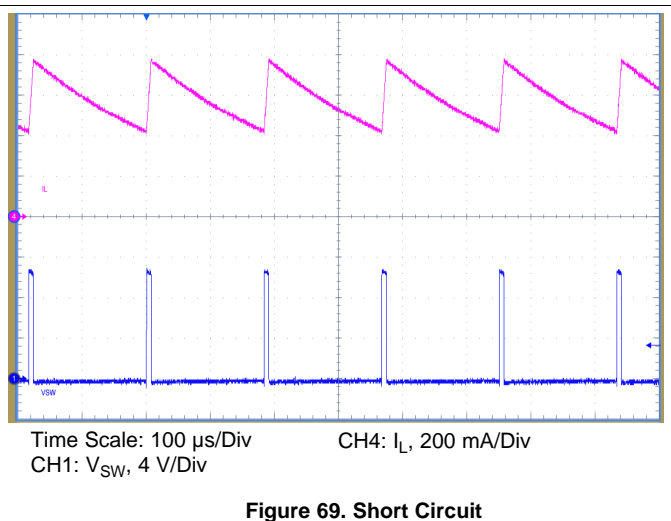
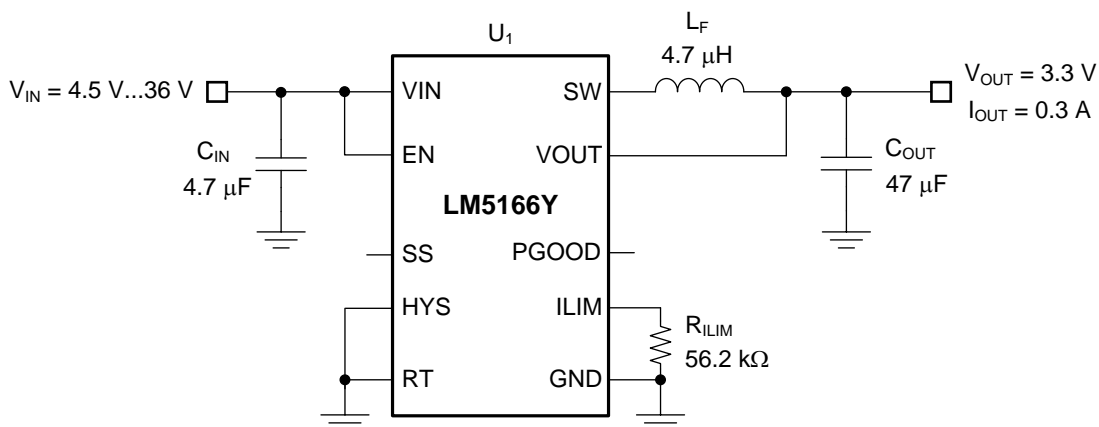

Figure 69. Short Circuit

8.2.3 Design 3: High-Density PFM Converter Rated at 3.3 V, 0.3 A



Copyright © 2017, Texas Instruments Incorporated

Figure 70. Schematic for Design 3 With $V_{IN(nom)} = 24\text{ V}$, $V_{OUT} = 3.3\text{ V}$, $I_{OUT(max)} = 0.3\text{ A}$, $F_{SW(nom)} = 600\text{ kHz}$

8.2.3.1 Design Requirements

The target efficiency is 75% for loads above 10 mA based on a nominal input voltage of 24 V, an output voltage of 3.3 V, with the emphasis on small solution size. The required input voltage range is 4.5 V to 36 V. The LM5166 has an internally-set soft-start time of 900 μs and an adjustable peak current limit threshold. The required components are listed in Table 6.

Table 6. List of Components for Design 3⁽¹⁾

COUNT	REF DES	DESCRIPTION	PART NUMBER	MFR
1	C _{IN}	Capacitor, Ceramic, 4.7 μF , 50 V, X7R, 10%, 1206	GRM31CR71H475MA12L	Murata
			885012208094	Würth
1	C _{OUT}	Capacitor, Ceramic, 47 μF , 6.3 V, X5R, 10%, 1206	GRM31CR60J476KE19	Murata
1	L _F	Inductor, 4.7 μH , 0.18 Ω typ, 2.2 A Isat, 1.2 mm max	TFM252012ALMA4R7TMAA	TDK
			Würth	Würth
1	R _{ILIM}	Resistor, Chip, 56.2 k Ω , 1/16W, 1%, 0402	Std	Std
1	U ₁	LM5166Y, Synchronous Buck Converter, VSON-10, 3.3-V Fixed	LM5166YDRCR	TI

(1) See [Third-Party Products Disclaimer](#).

8.2.3.2 Detailed Design Procedure

8.2.3.2.1 Peak Current Limit Setting – R_{ILIM}

Install a 56.2-k Ω resistor from ILIM to GND to select a 750-mA peak current limit threshold setting to meet the rated output current of 300 mA in PFM. See [Adjustable Current Limit](#) for more detail.

8.2.3.2.2 Switching Frequency – L_F

Tie RT to GND to select PFM mode of operation. The inductor, input voltage, output voltage and peak current determine the pulse switching frequency of a PFM-configured LM5166. For a given input voltage, output voltage and peak current, the inductance of L_F sets the switching frequency when the output is in regulation. Use Equation 28 to select an inductance of 4.7 μH based on the target PFM converter switching frequency of 600 kHz at 24-V input.

$$L_F = \frac{V_{OUT}}{F_{SW(PFM)} \cdot I_{PK(PFM)}} \cdot \left(1 - \frac{V_{OUT}}{V_{IN}}\right) \quad (28)$$

$I_{PK(PFM)}$ in this example is the peak current limit setting of 750 mA plus the inductor current overshoot resulting from the 80-ns peak current comparator delay, t_{LIM_delay} . An additional constraint on the inductance is the 180-ns minimum on-time of the high-side MOSFET. Therefore, to keep the inductor current well controlled, choose an inductance that is larger than $L_{F(min)}$ using Equation 29 where $V_{IN(max)}$ is the maximum input supply voltage for the application, t_{LIM_delay} is 80 ns, $t_{ON(min)}$ is 180 ns, the maximum current limit threshold, $I_{LIM(max)}$, is 825 mA, and the maximum allowed peak inductor current, $I_{L(max)}$, is 1.6 A.

$$L_{F(min)} = \text{Max} \left(\frac{V_{IN(max)} \cdot t_{ON(min)}}{I_{L(max)}}, \frac{V_{IN(max)} \cdot t_{LIM_delay}}{I_{L(max)} - I_{LIM(max)}} \right) \quad (29)$$

Choose an inductor with saturation current rating above the peak current limit setting, and allow for derating of the saturation current at the highest expected operating temperature.

8.2.3.2.3 Output Capacitors – C_{OUT}

The output capacitor, C_{OUT} , filters the inductor's ripple current and stores energy to meet the load current requirement when the LM5166 is in sleep mode. The output ripple has a base component of amplitude $V_{OUT}/123$ related to the typical feedback comparator hysteresis in PFM. The wake-up time from sleep to active mode adds a ripple voltage component that is a function of the output current. Approximate the total output ripple by Equation 30.

$$\Delta V_{OUT} = \left(\frac{I_{PK(PFM)}}{2} + I_{OUT} \right) \cdot \frac{1 \mu s}{C_{OUT}} + \frac{V_{OUT}}{123} \quad (30)$$

Also, the output capacitance must be large enough to accept the energy stored in the inductor without a large deviation in output voltage. Setting this voltage change equal to 1% of the output voltage results in a C_{OUT} requirement defined with Equation 31.

$$C_{OUT} \geq 50 \cdot L_F \cdot \left(\frac{I_{PK(PFM)}}{V_{OUT}} \right)^2 \quad (31)$$

In general, select the capacitance of C_{OUT} to limit the output voltage ripple at full load current, ensuring that it is rated for worst-case RMS ripple current given by $I_{RMS} = I_{PK(PFM)}/2$. In this design example, select a 47- μF , 6.3-V capacitor with a high-quality dielectric.

8.2.3.2.4 Input Capacitor – C_{IN}

The input capacitor, C_{IN} , filters the triangular current waveform of the high-side MOSFET (see Figure 89). To prevent large ripple voltage, use a low-ESR ceramic input capacitor sized for the worst-case RMS ripple current given by $I_{RMS} = I_{OUT}/2$. In this design example, choose a 2.2- μF , 50-V ceramic input capacitor with a high-quality dielectric.

8.2.3.2.5 Application Curves

Unless otherwise stated, application curves were taken at $T_A = 25^\circ\text{C}$.

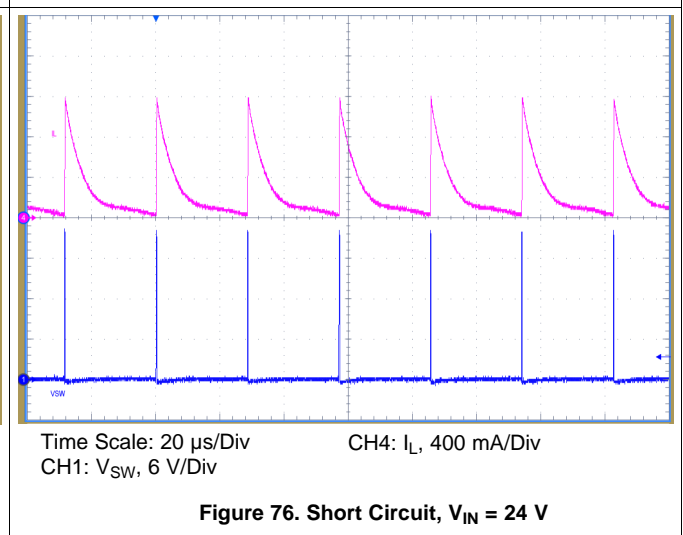
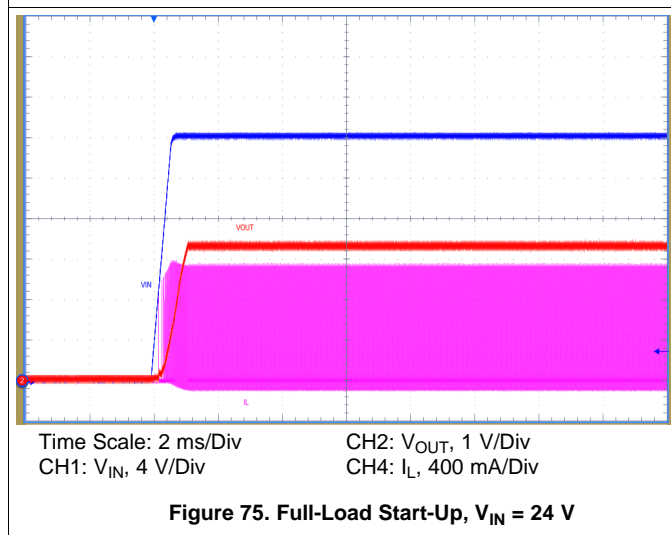
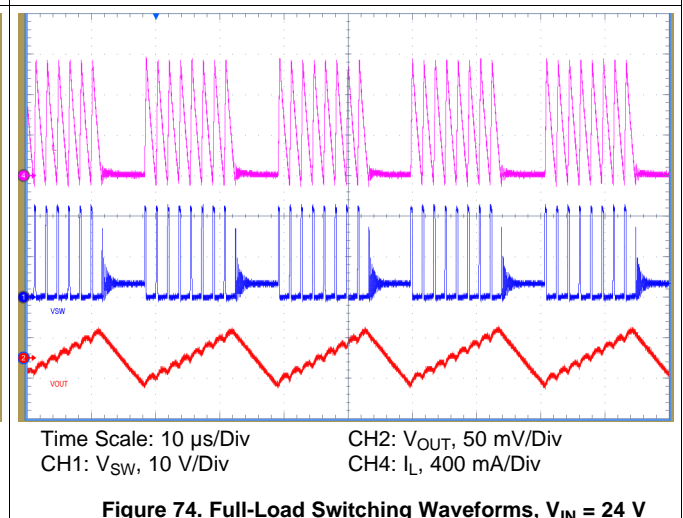
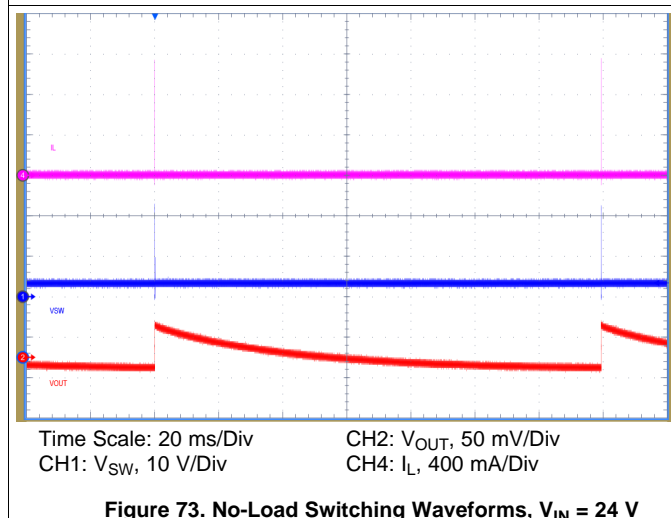
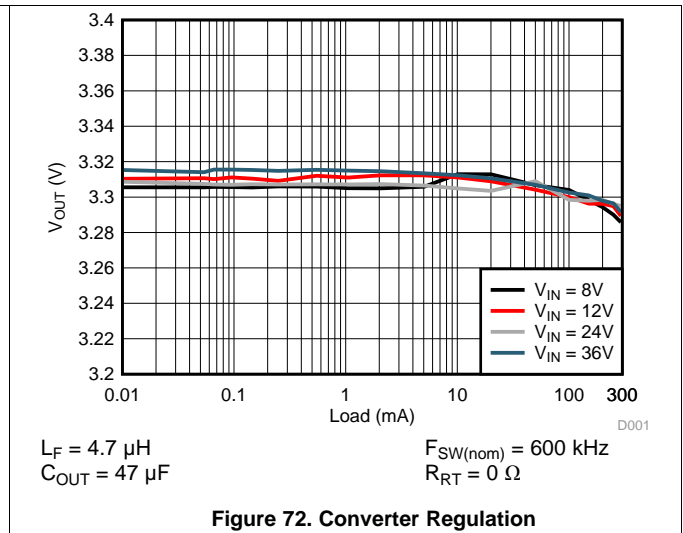
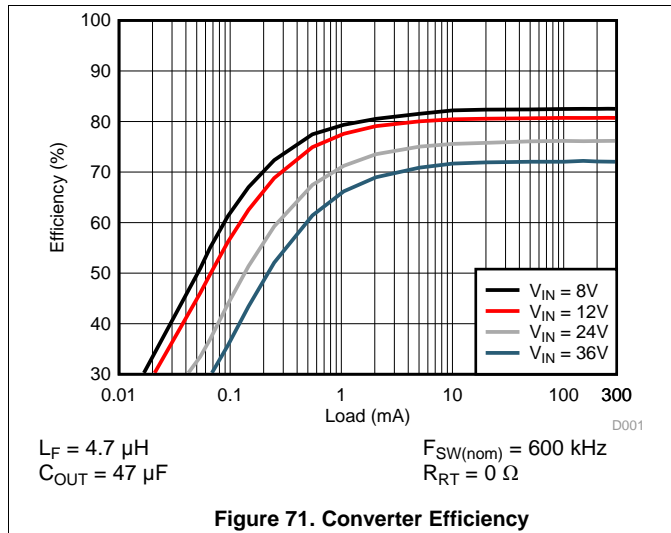

8.2.4 Design 4: Wide V_{IN} , Low I_Q PFM Converter Rated at 5 V, 500 mA

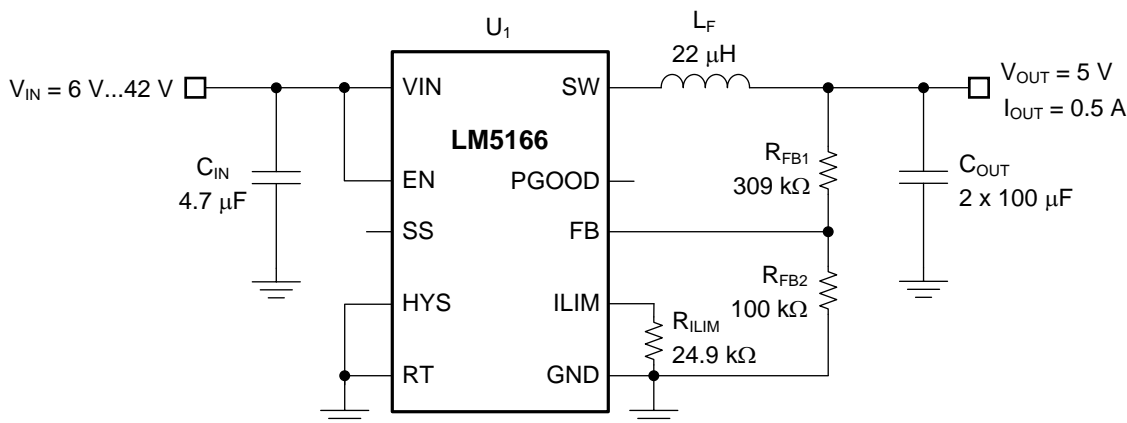

Copyright © 2016, Texas Instruments Incorporated

Figure 77. Schematic for Design 4 With $V_{IN(nom)} = 12\text{ V}$, $V_{OUT} = 5\text{ V}$, $I_{OUT(max)} = 500\text{ mA}$, $F_{SW(nom)} = 100\text{ kHz}$

8.2.4.1 Design Requirements

The target efficiency is 85% for loads above 1 mA based on a nominal input voltage of 12 V, an output voltage of 5 V. The required input voltage range is 6 V to 42 V. The LM5166 has an internally-set soft-start time of 900 μs and an adjustable peak current limit threshold. The required components are listed in [Table 7](#).

Table 7. List of Components for Design 4⁽¹⁾

COUNT	REF DES	DESCRIPTION	PART NUMBER	MFR
1	C_{IN}	Capacitor, Ceramic, 4.7 μF , 50 V, X7R, 20%, 1206	GRM31CR71H475MA12L C3216X7R1H475M160AC	Murata TDK
2	C_{OUT}	Capacitor, Ceramic, 100 μF , 10 V, X5R, 10%, 1210	GRM32ER61A107ME20K	Murata
1	L_F	Inductor, 22 μH , 0.145 Ω max, 1.7 A Isat, 3.5 mm max Inductor, 22 μH , 0.2 Ω max, 2.3 A Isat, 3 mm max	LPS6235-223MR CMLB063T-220MS	Coilcraft Cyntec
1	R_{ILIM}	Resistor, Chip, 24.9 k Ω , 1/16W, 1%, 0402	Std	Std
1	R_{FB1}	Resistor, Chip, 309 k Ω , 1/16W, 1%, 0402	Std	Std
1	R_{FB2}	Resistor, Chip, 100 k Ω , 1/16W, 1%, 0402	Std	Std
1	U_1	LM5166, Synchronous Buck Converter, VSON-10, ADJ	LM5166DRCR	TI

(1) See [Third-Party Products Disclaimer](#).

8.2.4.2 Detailed Design Procedure

8.2.4.2.1 Feedback Resistors – R_{FB1} , R_{FB2}

The output voltage of the LM5166 is externally adjustable using a resistor divider network. The divider network comprises the upper feedback resistor R_{FB1} and lower feedback resistor R_{FB2} . Select R_{FB1} of 309 k Ω to minimize quiescent current and improve light-load efficiency in this application. With the desired output voltage setpoint of 5 V and $V_{FB} = 1.223\text{ V}$, calculate the resistance of R_{FB2} using [Equation 15](#) as 99.5 k Ω . Choose the closest available standard value of 100 k Ω for R_{FB2} . See [Adjustable Output Voltage \(FB\)](#) for more detail.

8.2.4.2.2 Peak Current Limit Setting – R_{ILIM}

Install a 24.9-k Ω resistor from ILIM to GND to select a 1.25-A peak current limit threshold setting with modulated ILIM function to meet the rated output current of 500 mA and the efficiency target. See [Adjustable Current Limit](#) for more detail.

8.2.4.2.3 Switching Frequency – L_F

Tie RT to GND to select PFM mode of operation. The inductor, input voltage, output voltage and peak current determine the pulse switching frequency of a PFM-configured LM5166. For a given input voltage, output voltage and peak current, the inductance of L_F sets the switching frequency when the output is in regulation. Use [Equation 28](#) to select an inductance of 22 μH based on the target PFM converter switching frequency of 100 kHz at 12-V input.

$I_{PK(PFM)}$ in this example is the peak current limit setting of 1.25 A plus the inductor current overshoot resulting from the 80-ns peak current comparator delay. An additional constraint on the inductance is the 180-ns minimum on-time of the high-side MOSFET. Therefore, to keep the inductor current well controlled, choose an inductance that is larger than $L_{F(min)}$ using [Equation 29](#).

Choose an inductor with saturation current rating above the peak current limit setting, and allow for derating of the saturation current at the highest expected operating temperature.

8.2.4.2.4 Output Capacitors – C_{OUT}

The output capacitor, C_{OUT} , filters the ripple current of the inductor and stores energy to meet the load current requirement when the LM5166 is in sleep mode. The output ripple has a base component of amplitude $V_{OUT}/123$ related to the typical feedback comparator hysteresis in PFM. The wake-up time from sleep to active mode adds a ripple voltage component that is a function of the output current. Approximate the total output ripple by [Equation 30](#).

Also, the output capacitance must be large enough to accept the energy stored in the inductor without a large deviation in output voltage. Setting this voltage change equal to 1% of the output voltage results in a C_{OUT} requirement defined with [Equation 31](#).

In general, select the capacitance of C_{OUT} to limit the output voltage ripple at full load current, ensuring that it is rated for worst-case RMS ripple current given by $I_{RMS} = I_{PK(PFM)}/2$. In this design example, select two 100- μF , 10-V capacitors with a high-quality dielectric.

8.2.4.2.5 Input Capacitor – C_{IN}

The input capacitor, C_{IN} , filters the triangular current waveform of the high-side MOSFET (see [Figure 89](#)). To prevent large ripple voltage, use a low-ESR ceramic input capacitor sized for the worst-case RMS ripple current given by $I_{RMS} = I_{OUT}/2$. In this design example, choose a 4.7- μF , 50-V ceramic input capacitor with a high-quality dielectric.

8.2.4.3 Application Curves

Unless otherwise stated, application curves were taken at $T_A = 25^\circ\text{C}$.

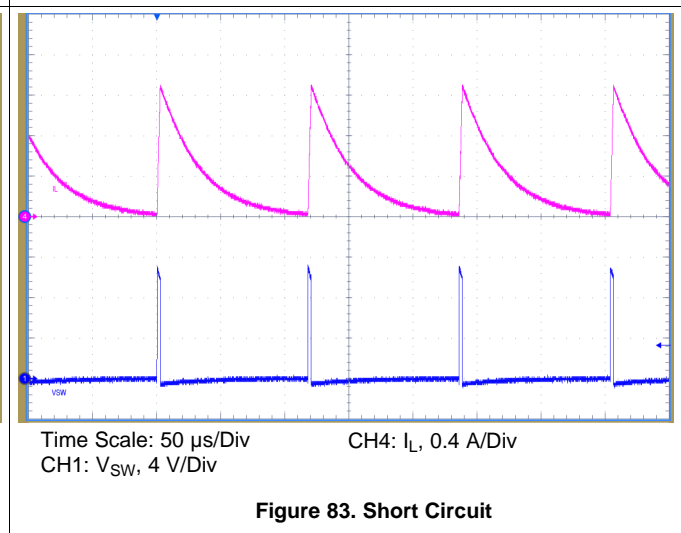
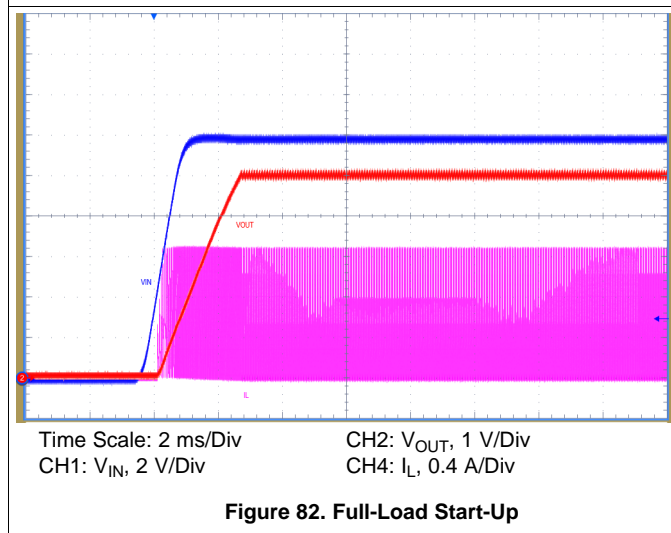
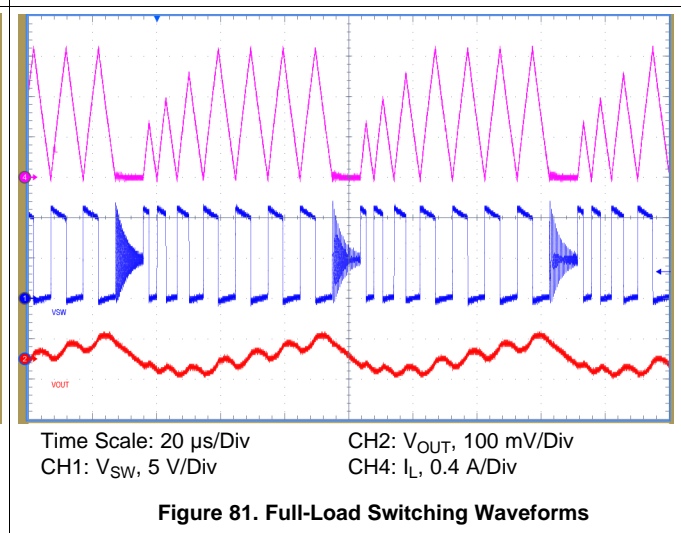
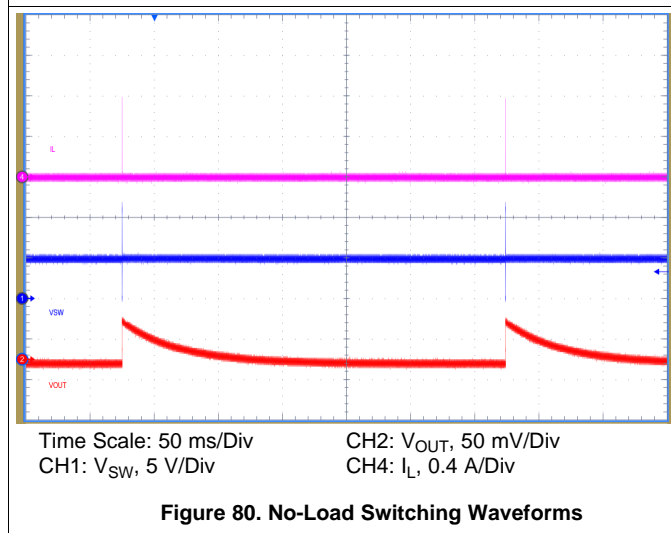
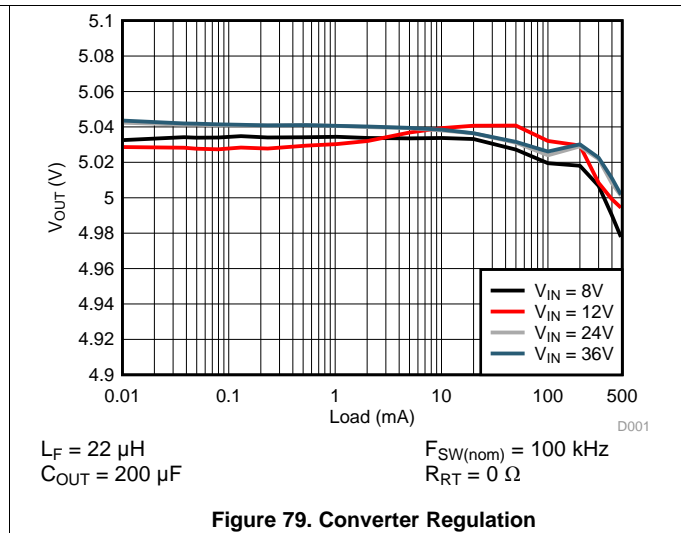
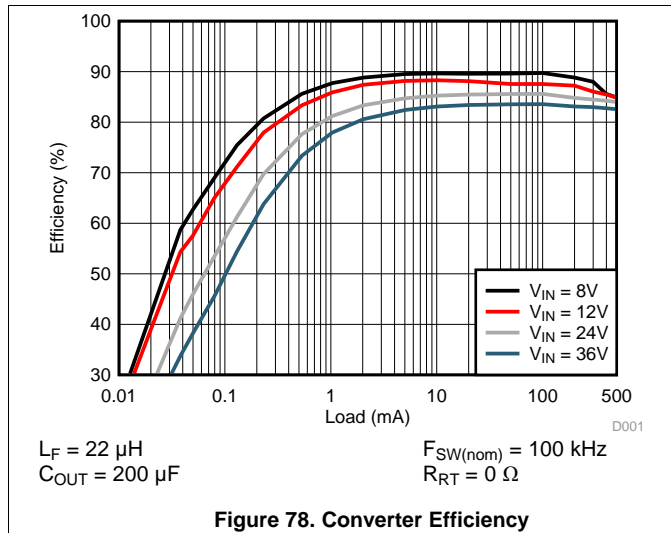

8.2.5 Design 5: 12-V, 300-mA COT Converter Operating From 24-V or 48-V Input

The schematic diagram of 12-V, 300-mA COT converter is given in [Figure 84](#).

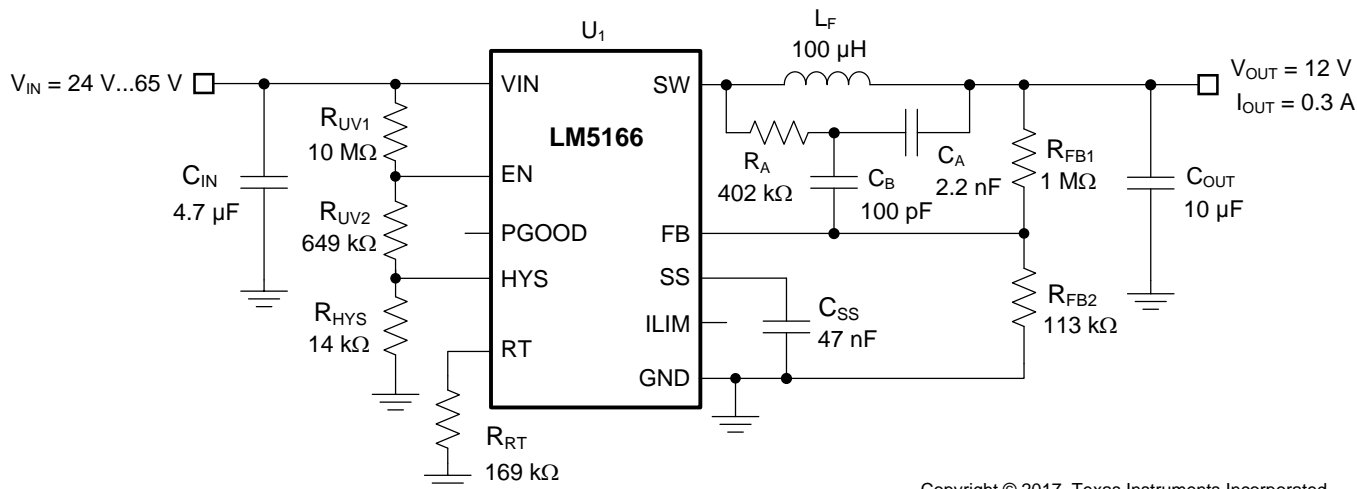

Copyright © 2017, Texas Instruments Incorporated

Figure 84. Schematic for Design 5 With $V_{OUT} = 12\text{ V}$, $I_{OUT(max)} = 300\text{ mA}$, $F_{SW(nom)} = 400\text{ kHz}$

8.2.5.1 Design Requirements

The full-load efficiency specifications are 93% and 89% based on input voltages of 24 V and 48 V, respectively, and an output voltage setpoint of 12 V. The input voltage range is 24 V to 65 V, with UVLO turnon and turnoff at 20 V and 18 V, respectively. The output voltage setpoint is established by feedback resistors, R_{FB1} and R_{FB2} . The required components are listed in [Table 8](#).

Table 8. List of Components for Design 5⁽¹⁾

REF DES	QTY	SPECIFICATION	VENDOR	PART NUMBER
C _{IN}	1	4.7 μF, 100 V, X7S, 1210	Murata	GRM31CR71H475MA12L
		4.7 μF, 80 V, X7R, 1210	Murata	GRM32ER71K475KE14L
C _{OUT}	1	10 μF, 25 V, X7R, 1206	Murata	GRM31CR71E106MA12L
			TDK	C3216X7R1E106M
			Würth	885012208069
L _F	1	100 μH ±20%, 0.54 A, 375 mΩ maximum DCR, 6 × 6 × 3.5 mm	Coilcraft	LPS6235-104MRC
R _A	1	402 kΩ, 1%, 0402	Std	Std
R _{FB1}	1	1 MΩ, 1%, 0402	Std	Std
R _{FB2}	1	113 kΩ, 1%, 0402	Std	Std
R _{UV1}	1	10 MΩ, 1%, 0603	Std	Std
R _{UV2}	1	649 kΩ, 1%, 0402	Std	Std
R _{HYS}	1	14 kΩ, 1%, 0402	Std	Std
R _{RT}	1	169 kΩ, 1%, 0402	Std	Std
C _A	1	2.2 nF, 25 V, X7R, 0402	Std	Std
C _B	1	100 pF, 50 V, NP0, 0402	Std	Std
C _{SS}	1	47 nF, 16 V, X7R, 0402	Std	Std
U ₁	1	LM5166 Synchronous Buck Converter, VSON-10, 3 mm × 3 mm	TI	LM5166DRCR

(1) See [Third-Party Products Disclaimer](#).

8.2.5.2 Detailed Design Procedure

The component selection procedure for this design is quite similar to that of COT designs 1 and 2.

8.2.5.2.1 Peak Current Limit Setting – R_{ILIM}

Leave the ILIM pin open circuit to select the 500-mA peak current limit setting for a rated output current of 300 mA. See [Table 3](#).

8.2.5.2.2 Switching Frequency – R_{RT}

Using [Equation 4](#), select a standard 1% resistor value of 169 k Ω to set a switching frequency of 400 kHz.

8.2.5.2.3 Inductor – L_F

Choosing a 100- μ H inductor in this design results in 150-mA peak-to-peak ripple current at an input voltage of 24 V, equivalent to 50% of the 300-mA rated load current. A larger ripple current design results in improved light-load efficiency. The peak inductor current at maximum input voltage of 65 V is 424 mA, which is sufficiently below the LM5166 peak current limit of 500 mA. Select an inductor with saturation current rating well above the peak current limit setting, and allow for derating of the saturation current at the highest expected operating temperature.

8.2.5.2.4 Input and Output Capacitors – C_{IN} , C_{OUT}

Choose a 4.7- μ F, 80-V or 100-V ceramic input capacitor with 1210 footprint. Such a capacitor is typically available in X7S or X7R dielectric. Based on [Equation 24](#), select a 10- μ F, 25-V ceramic output capacitor with X7R dielectric and 1206 footprint.

8.2.5.2.5 Feedback Resistors – R_{FB1} , R_{FB2}

Select R_{FB1} of 1 M Ω to minimize quiescent current and improve light-load efficiency in this application. With the desired output voltage setpoint of 12 V and $V_{FB} = 1.223$ V, calculate the resistance of R_{FB2} using [Equation 15](#) as 113.5 k Ω . Choose the closest available standard value of 113 k Ω for R_{FB2} . See [Adjustable Output Voltage \(FB\)](#) for more detail.

8.2.5.2.6 Ripple Generation Network – R_A , C_A , C_B

Select the ripple injection circuit components R_A and C_A values using [Equation 10](#) and [Equation 11](#). Choose capacitor C_B using [Equation 12](#) based on a target transient response settling time of 300 μ s.

8.2.5.2.7 Undervoltage Lockout Setpoint – R_{UV1} , R_{UV2} , R_{HYS}

Adjust the undervoltage lockout (UVLO) using an externally-connected resistor divider network of R_{UV1} , R_{UV2} , and R_{HYS} . The UVLO has two thresholds, one for power up when the input voltage is rising and one for power down or brownouts when the input voltage is falling. The EN rising threshold for the LM5166 is 1.22 V.

Rearranging [Equation 16](#) and [Equation 17](#), the expressions to calculate R_{UV2} and R_{HYS} are as follows:

$$R_{UV2} = \frac{V_{EN(on)}}{V_{IN(on)} - V_{EN(on)}} \cdot R_{UV1} \quad (32)$$

$$R_{HYS} = \frac{V_{EN(off)}}{V_{IN(off)} - V_{EN(off)}} \cdot R_{UV1} - R_{UV2} \quad (33)$$

Choose R_{UV1} as 10 M Ω to minimize input quiescent current. Given the desired input voltage UVLO thresholds of 20 V and 18 V, calculate the resistance of R_{UV2} and R_{HYS} as 649 k Ω and 14 k Ω , respectively. See [Precision Enable \(EN\) and Hysteresis \(HYS\)](#) for more detail.

8.2.5.2.8 Soft Start – C_{SS}

Install a 47-nF capacitor from SS to GND for a soft-start time of 6 ms.

8.2.5.3 Application Curves

Unless otherwise stated, application curves were taken at $T_A = 25^\circ\text{C}$.

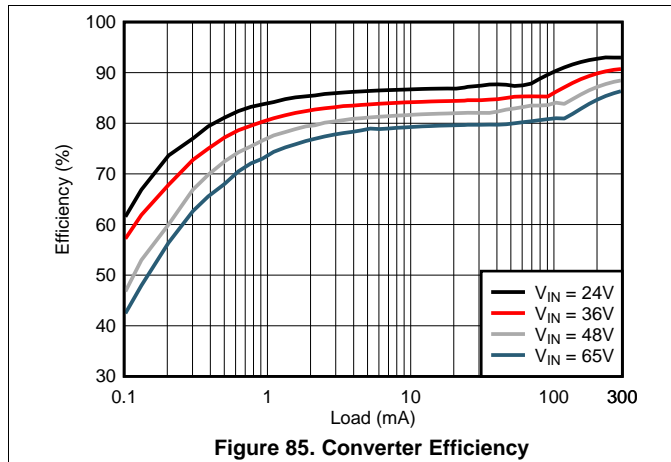

Figure 85. Converter Efficiency

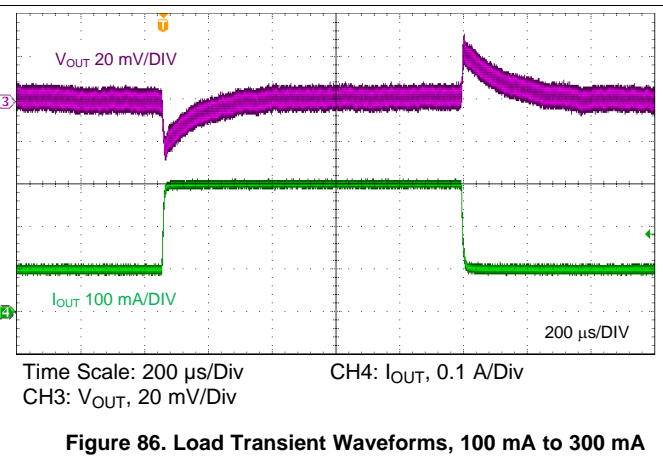

Figure 86. Load Transient Waveforms, 100 mA to 300 mA

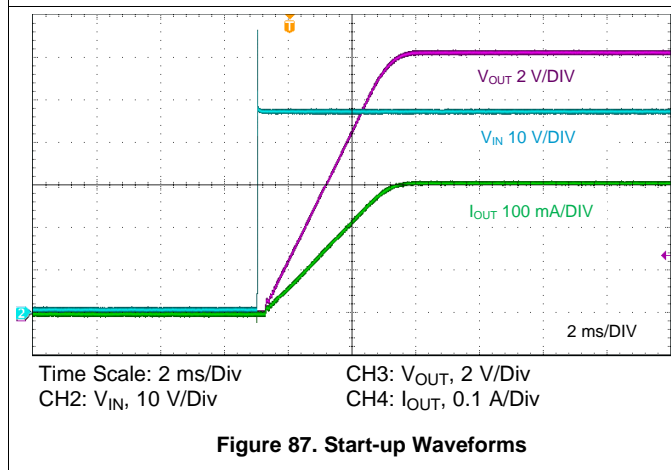

Figure 87. Start-up Waveforms

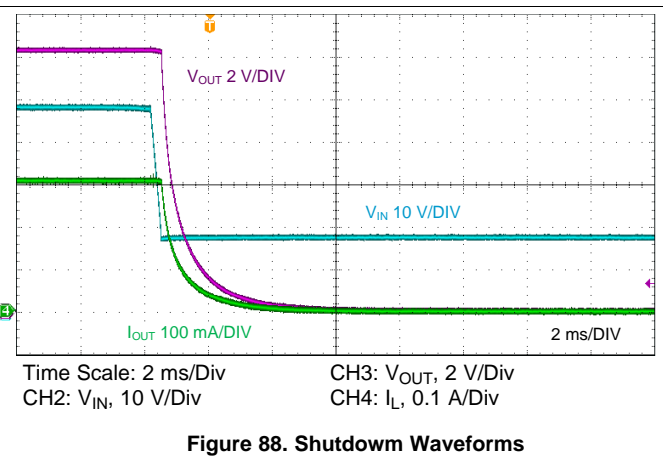

Figure 88. Shutdown Waveforms

9 Power Supply Recommendations

The LM5166 is designed to operate from an input voltage supply range between 3 V and 65 V. This input supply should be able to withstand the maximum input current and maintain a voltage above 3 V. Ensure that the impedance of the input supply rail is low enough that an input current transient does not cause a high enough drop at the LM5166 supply voltage to create a false UVLO fault triggering and system reset. If the input supply is placed more than a few inches from the LM5166 converter, additional bulk capacitance may be required in addition to the ceramic bypass capacitors. A 10- μ F electrolytic capacitor is a typical choice for this function, whereby the capacitor ESR provides a level of damping against input filter resonances. A typical ESR of 0.5 Ω provides enough damping for most input circuit configurations.

10 Layout

The performance of any switching converter depends as much upon PCB layout as it does the component selection. The following guidelines are provided to assist with designing a PCB with the best power conversion performance, thermal performance, and minimized generation of unwanted EMI.

10.1 Layout Guidelines

PCB layout is a critical portion of good power supply design. There are several paths that conduct high slew-rate currents or voltages that can interact with stray inductance or parasitic capacitance to generate noise and EMI or degrade the power supply performance.

1. To help eliminate these problems, bypass the VIN pin to GND with a low-ESR ceramic bypass capacitor with a high-quality dielectric. Place C_{IN} as close as possible to the LM5166 VIN and GND pins. Grounding for both the input and output capacitors should consist of localized top-side planes that connect to the GND pin and GND PAD.
2. Minimize the loop area formed by the input capacitor connections to the VIN and GND pins.
3. Locate the inductor close to the SW pin. Minimize the area of the SW trace or plane to prevent excessive capacitive coupling.
4. Tie the GND pin directly to the power pad under the device and to a heat-sinking PCB ground plane.
5. Use a ground plane in one of the middle layers as noise shielding and heat dissipation path.
6. Have a single-point ground connection to the plane. Route the ground connections for the feedback, soft-start, and enable components to the ground plane. This prevents any switched or load currents from flowing in analog ground traces. If not properly handled, poor grounding results in degraded load regulation or erratic output voltage ripple behavior.
7. Make V_{IN} , V_{OUT} and ground bus connections as wide as possible. This reduces any voltage drops on the input or output paths of the converter and maximizes efficiency.
8. Minimize trace length to the FB pin. Place both feedback resistors, R_{FB1} and R_{FB2} , close to the FB pin. Place C_{FF} (if needed) directly in parallel with R_{FB1} . If output setpoint accuracy at the load is important, connect the V_{OUT} sense at the load. Route the V_{OUT} sense path away from noisy nodes and preferably through a layer on the other side of a shielding layer.
9. The RT pin is sensitive to noise. Thus, locate the R_{RT} resistor as close as possible to the device and route with minimal lengths of trace. The parasitic capacitance from RT to GND must not exceed 20 pF.
10. Provide adequate heat sinking for the LM5166 to keep the junction temperature below 150°C. For operation at full rated load, the top-side ground plane is an important heat-dissipating area. Use an array of heat-sinking vias to connect the exposed pad to the PCB ground plane. If the PCB has multiple copper layers, these thermal vias must also be connected to inner layer heat-spreading ground planes.

10.1.1 Compact PCB Layout for EMI Reduction

Radiated EMI generated by high di/dt components relates to pulsing currents in switching converters. The larger area covered by the path of a pulsing current, the more electromagnetic emission is generated. The key to minimizing radiated EMI is to identify the pulsing current path and minimize the area of that path.

The critical switching loop of the buck converter power stage in terms of EMI is denoted in [Figure 89](#). The topological architecture of a buck converter means that a particularly high di/dt current path exists in the loop comprising the input capacitor and the integrated MOSFETs of the LM5166, and it becomes mandatory to reduce the parasitic inductance of this loop by minimizing the effective loop area.

Layout Guidelines (continued)

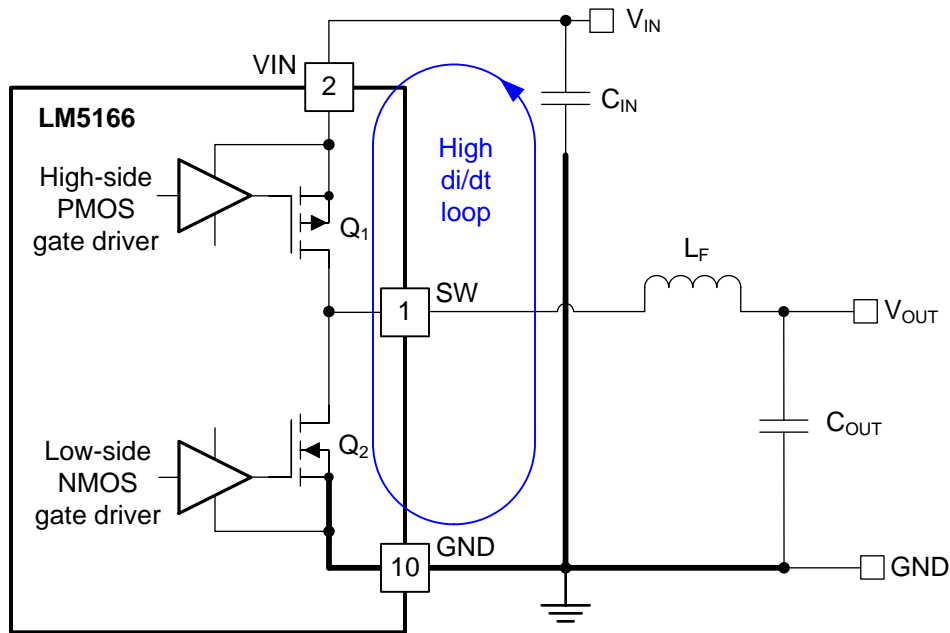

Figure 89. DC-DC Buck Converter With Power Stage Circuit Switching Loops

The input capacitor provides the primary path for the high di/dt components of the high-side MOSFET's current. Placing a ceramic capacitor as close as possible to the V_{IN} and GND pins is the key to EMI reduction. Keep the trace connecting SW to the inductor as short as possible and just wide enough to carry the load current without excessive heating. Use short, thick traces or copper pours (shapes) for current conduction path to minimize parasitic resistance. Place the output capacitor close to the V_{OUT} side of the inductor, and connect the capacitor's return terminal to the GND pin and exposed PAD of the LM5166.

10.1.2 Feedback Resistors

For the adjustable output voltage version of the LM5166, reduce noise sensitivity of the output voltage feedback path by placing the resistor divider close to the FB pin, rather than close to the load. This reduces the trace length of FB signal and noise coupling. The FB pin is the input to the feedback comparator, and as such is a high impedance node sensitive to noise. The output node is a low impedance node, so the trace from V_{OUT} to the resistor divider can be long if a short path is not available.

Route the voltage sense trace from the load to the feedback resistor divider, keeping away from the SW node, the inductor and V_{IN} to avoid contaminating the feedback signal with switch noise, while also minimizing the trace length. This is most important when high feedback resistances, greater than 100 k Ω , are used to set the output voltage. Also, route the voltage sense trace on a different layer from the inductor, SW node and V_{IN} , such that there is a ground plane that separates the feedback trace from the inductor and SW node copper polygon. This provides further shielding for the voltage feedback path from switching noise sources

10.2 Layout Example

Figure 90 shows an example layout for the PCB top layer of a 4-layer board with essential components placed on the top side. The bottom layer features optional Type 3 ripple generation components (R_A and C_A), and R_{UV1} , R_{UV2} , and R_{HYS} resistors.

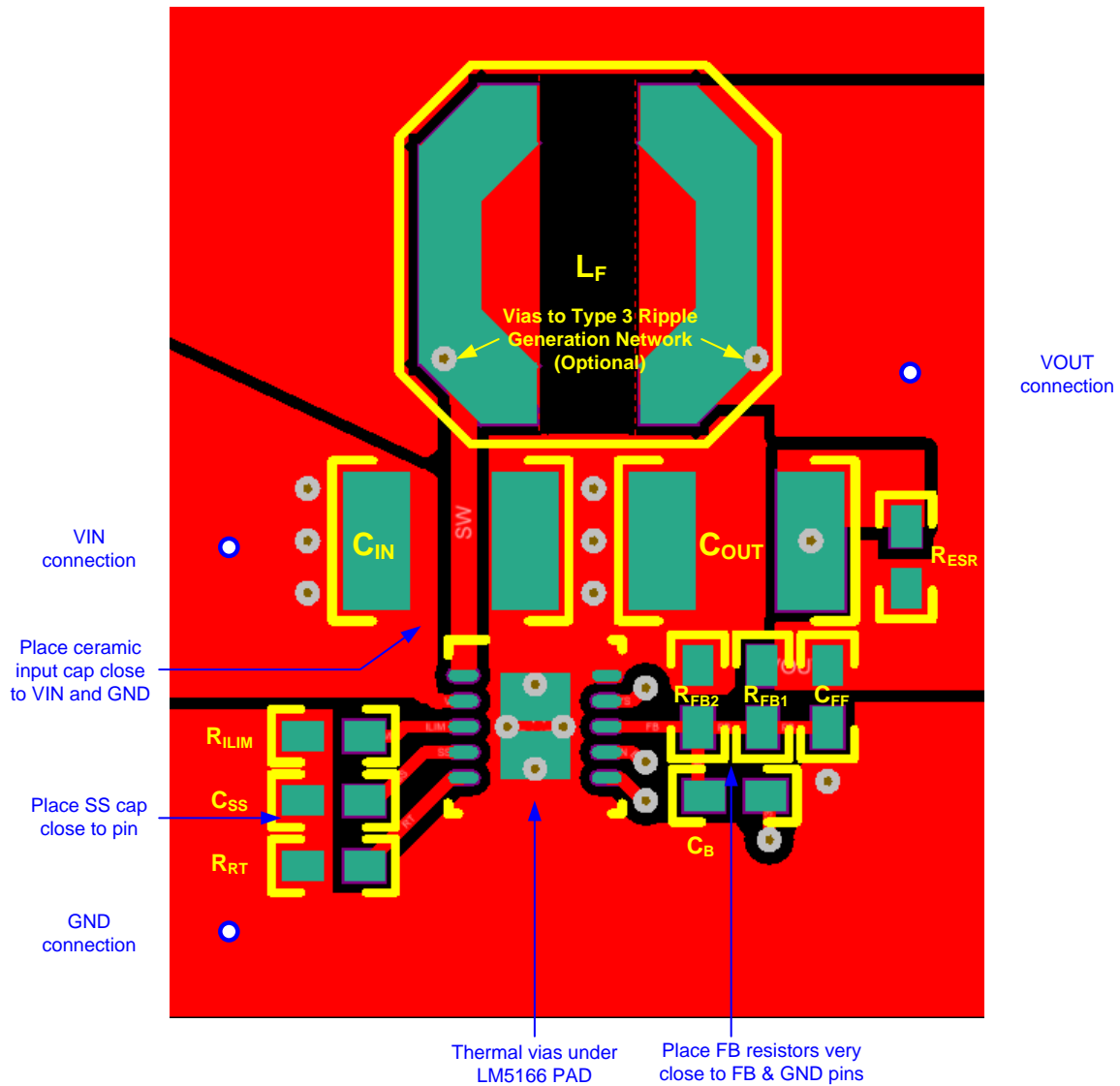

Figure 90. LM5166 Single-Sided PCB Layout Example

11 Device and Documentation Support

11.1 Device Support

11.1.1 Third-Party Products Disclaimer

TI'S PUBLICATION OF INFORMATION REGARDING THIRD-PARTY PRODUCTS OR SERVICES DOES NOT CONSTITUTE AN ENDORSEMENT REGARDING THE SUITABILITY OF SUCH PRODUCTS OR SERVICES OR A WARRANTY, REPRESENTATION OR ENDORSEMENT OF SUCH PRODUCTS OR SERVICES, EITHER ALONE OR IN COMBINATION WITH ANY TI PRODUCT OR SERVICE.

11.1.2 Development Support

- LM5166 [Quickstart Calculator](#)
- LM5166 [Simulation Models](#)
- For TI's Reference Design Library, visit [TIDesigns](#)
- For TI's WEBENCH Design Environment, visit the [WEBENCH® Design Center](#)

11.1.3 Custom Design With WEBENCH® Tools

[Click here](#) to create a custom design using the LM5166 device with the WEBENCH® Power Designer.

1. Start by entering the input voltage (V_{IN}), output voltage (V_{OUT}), and output current (I_{OUT}) requirements.
2. Optimize the design for key parameters such as efficiency, footprint, and cost using the optimizer dial.
3. Compare the generated design with other possible solutions from Texas Instruments.

The WEBENCH Power Designer provides a customized schematic along with a list of materials with real-time pricing and component availability.

In most cases, these actions are available:

- Run electrical simulations to see important waveforms and circuit performance
- Run thermal simulations to understand board thermal performance
- Export customized schematic and layout into popular CAD formats
- Print PDF reports for the design, and share the design with colleagues

Get more information about WEBENCH tools at www.ti.com/WEBENCH.

11.2 Documentation Support

11.2.1 Related Documentation

For related documentation see the following:

- [LM5166EVM-C50A EVM User's Guide](#) (SNVU485)
- [LM5166EVM-C33A EVM User's Guide](#) (SNVU544)
- [Low- \$I_Q\$ Synchronous Buck Converter Enables Intelligent Field-sensor Applications](#) (SLYT671)
- [Low EMI Buck Converter Powers a Multivariable Sensor Transmitter with BLE Connectivity](#) (SLYT693)
- [Selecting an Ideal Ripple Generation Network for Your COT Buck Converter](#) (SNVA776)
- TI Designs:
 - [TIDA-01487 Isolated CAN Flexible Data\(FD\) Rate Repeater Reference Design](#) (TIDUDB5)
 - [TIDA-01437 RGB Signal Light with IO-Link Interface Reference Design](#) (TIDUD35)
 - [TIDA-01395 24-V AC Power Stage with Wide \$V_{IN}\$ Converter and Battery Gauge for Smart Thermostat](#) (TIDUCW0)
 - [TIDA-01386 Ultrasonic Distance Sensor with IO-Link Reference Design](#) (TIDUDB2)
 - [TIDA-01358 24-V AC Power Stage with Wide \$V_{IN}\$ Converter and Battery Backup for Smart Thermostat](#) (TIDUCE1)
 - [TIPD215 Less than 1 W, Quad-Channel, Analog Output Module with Adaptive Power Management Reference Design](#) (TIDUCV5)
 - [TIDA-00666 Field Transmitter with Bluetooth® Low Energy Connectivity Powered from 4 to 20-mA Current Loop](#) (TIDUC27)

Documentation Support (continued)

- Industrial Strength Blogs:
 - [Powering Smart Sensor Transmitters in Industrial Applications](#)
 - [Industrial Strength Design – Part 1](#)
 - [Trends in Building Automation: Predictive Maintenance](#)
 - [Trends in Building Automation: Connected Sensors for User Comfort](#)
- White Papers:
 - [Valuing Wide \$V_{IN}\$, Low-EMI Synchronous Buck Circuits for Cost-Effective, Demanding Applications](#) (SLYY104)
- [AN-2162: Simple Success with Conducted EMI from DC-DC Converters](#) (SNVA489)
- [Automotive Cranking Simulator User's Guide](#) (SLVU984)
- [Using New Thermal Metrics](#) (SBVA025)
- [Semiconductor and IC Package Thermal Metrics](#) (SPRA953)

11.3 Receiving Notification of Documentation Updates

To receive notification of documentation updates, navigate to the device product folder on ti.com. In the upper right corner, click on *Alert me* to register and receive a weekly digest of any product information that has changed. For change details, review the revision history included in any revised document.

11.4 Community Resources

The following links connect to TI community resources. Linked contents are provided "AS IS" by the respective contributors. They do not constitute TI specifications and do not necessarily reflect TI's views; see TI's [Terms of Use](#).

TI E2E™ Online Community *TI's Engineer-to-Engineer (E2E) Community*. Created to foster collaboration among engineers. At e2e.ti.com, you can ask questions, share knowledge, explore ideas and help solve problems with fellow engineers.

Design Support *TI's Design Support* Quickly find helpful E2E forums along with design support tools and contact information for technical support.

11.5 Trademarks

E2E is a trademark of Texas Instruments.
 WEBENCH is a registered trademark of Texas Instruments.
 All other trademarks are the property of their respective owners.

11.6 Electrostatic Discharge Caution



This integrated circuit can be damaged by ESD. Texas Instruments recommends that all integrated circuits be handled with appropriate precautions. Failure to observe proper handling and installation procedures can cause damage.

ESD damage can range from subtle performance degradation to complete device failure. Precision integrated circuits may be more susceptible to damage because very small parametric changes could cause the device not to meet its published specifications.

11.7 Glossary

[SLYZ022](#) — *TI Glossary*.

This glossary lists and explains terms, acronyms, and definitions.

12 Mechanical, Packaging, and Orderable Information

The following pages include mechanical, packaging, and orderable information. This information is the most current data available for the designated devices. This data is subject to change without notice and revision of this document. For browser-based versions of this datasheet, refer to the left-hand navigation.

PACKAGING INFORMATION

Orderable Device	Status (1)	Package Type	Package Drawing	Pins	Package Qty	Eco Plan (2)	Lead finish/ Ball material (6)	MSL Peak Temp (3)	Op Temp (°C)	Device Marking (4/5)	Samples
LM5166DRCR	ACTIVE	VSON	DRC	10	3000	RoHS & Green	NIPDAU	Level-2-260C-1 YEAR	-40 to 150	5166	Samples
LM5166DRCT	ACTIVE	VSON	DRC	10	250	RoHS & Green	NIPDAU	Level-2-260C-1 YEAR	-40 to 150	5166	Samples
LM5166XRDCR	ACTIVE	VSON	DRC	10	3000	RoHS & Green	NIPDAU	Level-1-260C-UNLIM	-40 to 150	5166X	Samples
LM5166XRCT	ACTIVE	VSON	DRC	10	250	RoHS & Green	NIPDAU	Level-1-260C-UNLIM	-40 to 150	5166X	Samples
LM5166YDRCR	ACTIVE	VSON	DRC	10	3000	RoHS & Green	NIPDAU	Level-1-260C-UNLIM	-40 to 150	5166Y	Samples
LM5166YDRCT	ACTIVE	VSON	DRC	10	250	RoHS & Green	NIPDAU	Level-1-260C-UNLIM	-40 to 150	5166Y	Samples

(1) The marketing status values are defined as follows:

ACTIVE: Product device recommended for new designs.

LIFEBUY: TI has announced that the device will be discontinued, and a lifetime-buy period is in effect.

NRND: Not recommended for new designs. Device is in production to support existing customers, but TI does not recommend using this part in a new design.

PREVIEW: Device has been announced but is not in production. Samples may or may not be available.

OBSOLETE: TI has discontinued the production of the device.

(2) **RoHS:** TI defines "RoHS" to mean semiconductor products that are compliant with the current EU RoHS requirements for all 10 RoHS substances, including the requirement that RoHS substance do not exceed 0.1% by weight in homogeneous materials. Where designed to be soldered at high temperatures, "RoHS" products are suitable for use in specified lead-free processes. TI may reference these types of products as "Pb-Free".

RoHS Exempt: TI defines "RoHS Exempt" to mean products that contain lead but are compliant with EU RoHS pursuant to a specific EU RoHS exemption.

Green: TI defines "Green" to mean the content of Chlorine (Cl) and Bromine (Br) based flame retardants meet JS709B low halogen requirements of <=1000ppm threshold. Antimony trioxide based flame retardants must also meet the <=1000ppm threshold requirement.

(3) MSL, Peak Temp. - The Moisture Sensitivity Level rating according to the JEDEC industry standard classifications, and peak solder temperature.

(4) There may be additional marking, which relates to the logo, the lot trace code information, or the environmental category on the device.

(5) Multiple Device Markings will be inside parentheses. Only one Device Marking contained in parentheses and separated by a "-" will appear on a device. If a line is indented then it is a continuation of the previous line and the two combined represent the entire Device Marking for that device.

(6) Lead finish/Ball material - Orderable Devices may have multiple material finish options. Finish options are separated by a vertical ruled line. Lead finish/Ball material values may wrap to two lines if the finish value exceeds the maximum column width.

Important Information and Disclaimer: The information provided on this page represents TI's knowledge and belief as of the date that it is provided. TI bases its knowledge and belief on information provided by third parties, and makes no representation or warranty as to the accuracy of such information. Efforts are underway to better integrate information from third parties. TI has taken and continues to take reasonable steps to provide representative and accurate information but may not have conducted destructive testing or chemical analysis on incoming materials and chemicals. TI and TI suppliers consider certain information to be proprietary, and thus CAS numbers and other limited information may not be available for release.

In no event shall TI's liability arising out of such information exceed the total purchase price of the TI part(s) at issue in this document sold by TI to Customer on an annual basis.

TAPE AND REEL INFORMATION

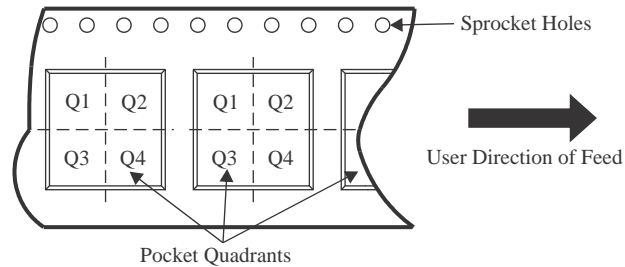
QUADRANT ASSIGNMENTS FOR PIN 1 ORIENTATION IN TAPE

*All dimensions are nominal

Device	Package Type	Package Drawing	Pins	SPQ	Reel Diameter (mm)	Reel Width W1 (mm)	A0 (mm)	B0 (mm)	K0 (mm)	P1 (mm)	W (mm)	Pin1 Quadrant
LM5166DRCR	VSON	DRC	10	3000	330.0	12.4	3.3	3.3	1.1	8.0	12.0	Q2
LM5166DRCT	VSON	DRC	10	250	180.0	12.4	3.3	3.3	1.1	8.0	12.0	Q2
LM5166DRCT	VSON	DRC	10	250	180.0	12.4	3.3	3.3	1.1	8.0	12.0	Q2
LM5166XRDR	VSON	DRC	10	3000	330.0	12.4	3.3	3.3	1.1	8.0	12.0	Q2
LM5166XRDR	VSON	DRC	10	3000	330.0	12.4	3.3	3.3	1.1	8.0	12.0	Q2
LM5166XRDR	VSON	DRC	10	250	180.0	12.4	3.3	3.3	1.1	8.0	12.0	Q2
LM5166XRDR	VSON	DRC	10	250	180.0	12.4	3.3	3.3	1.1	8.0	12.0	Q2
LM5166YDR	VSON	DRC	10	3000	330.0	12.4	3.3	3.3	1.1	8.0	12.0	Q2
LM5166YDR	VSON	DRC	10	3000	330.0	12.4	3.3	3.3	1.1	8.0	12.0	Q2
LM5166YDR	VSON	DRC	10	250	180.0	12.4	3.3	3.3	1.1	8.0	12.0	Q2
LM5166YDR	VSON	DRC	10	250	180.0	12.4	3.3	3.3	1.1	8.0	12.0	Q2

TAPE AND REEL BOX DIMENSIONS

*All dimensions are nominal

Device	Package Type	Package Drawing	Pins	SPQ	Length (mm)	Width (mm)	Height (mm)
LM5166DRCR	VSON	DRC	10	3000	346.0	346.0	33.0
LM5166DRCT	VSON	DRC	10	250	210.0	185.0	35.0
LM5166DRCT	VSON	DRC	10	250	210.0	185.0	35.0
LM5166XRCCR	VSON	DRC	10	3000	367.0	367.0	35.0
LM5166XRCCR	VSON	DRC	10	3000	335.0	335.0	25.0
LM5166XRCT	VSON	DRC	10	250	210.0	185.0	35.0
LM5166XRCT	VSON	DRC	10	250	182.0	182.0	20.0
LM5166YRCR	VSON	DRC	10	3000	335.0	335.0	25.0
LM5166YRCR	VSON	DRC	10	3000	367.0	367.0	35.0
LM5166YRCT	VSON	DRC	10	250	182.0	182.0	20.0
LM5166YRCT	VSON	DRC	10	250	210.0	185.0	35.0

GENERIC PACKAGE VIEW

DRC 10

VSON - 1 mm max height

3 x 3, 0.5 mm pitch

PLASTIC SMALL OUTLINE - NO LEAD

This image is a representation of the package family, actual package may vary.
Refer to the product data sheet for package details.

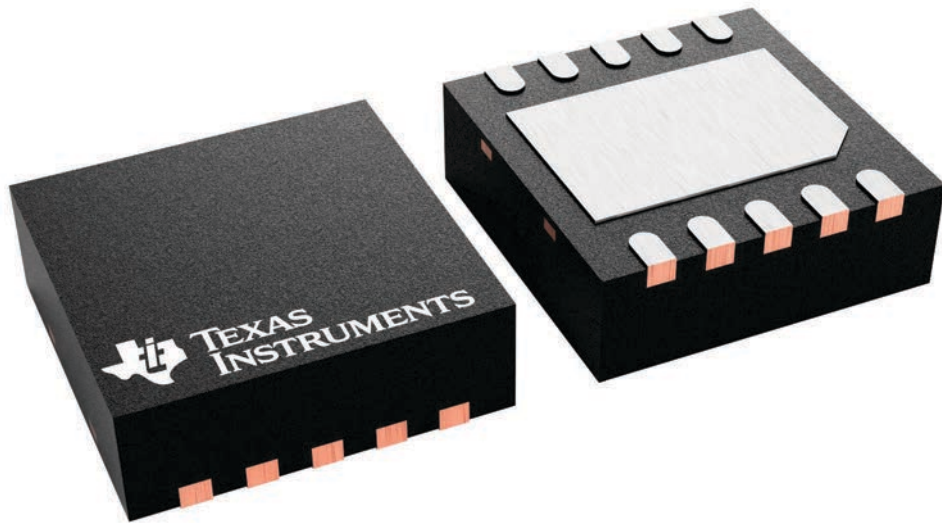

4226193/A

EXAMPLE BOARD LAYOUT

DRC0010J

VSON - 1 mm max height

PLASTIC SMALL OUTLINE - NO LEAD

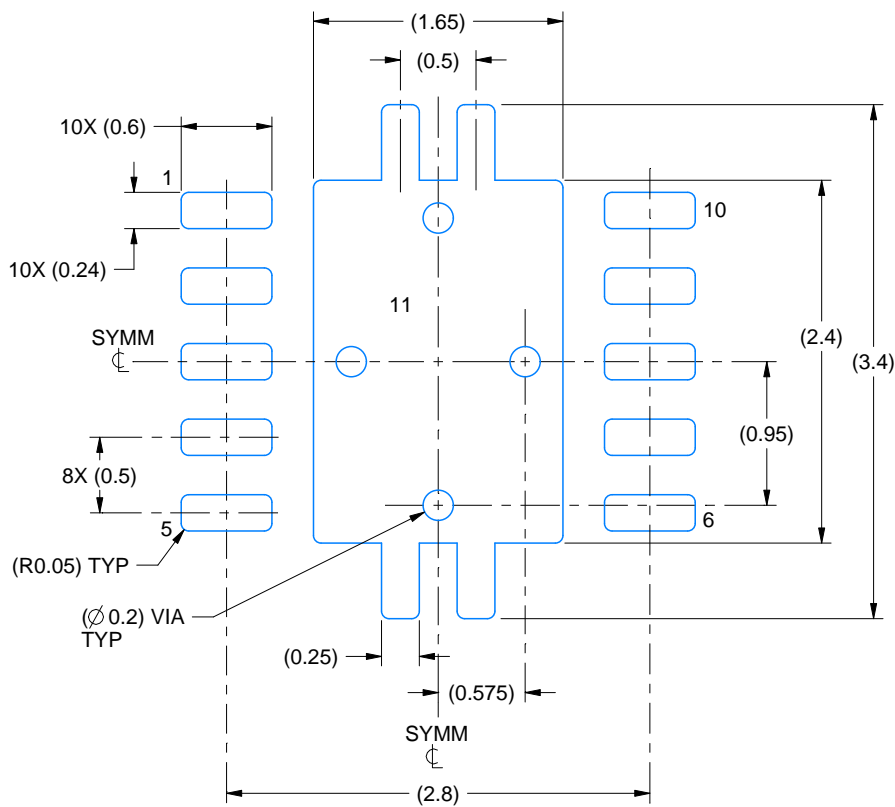

LAND PATTERN EXAMPLE
EXPOSED METAL SHOWN
SCALE:20X

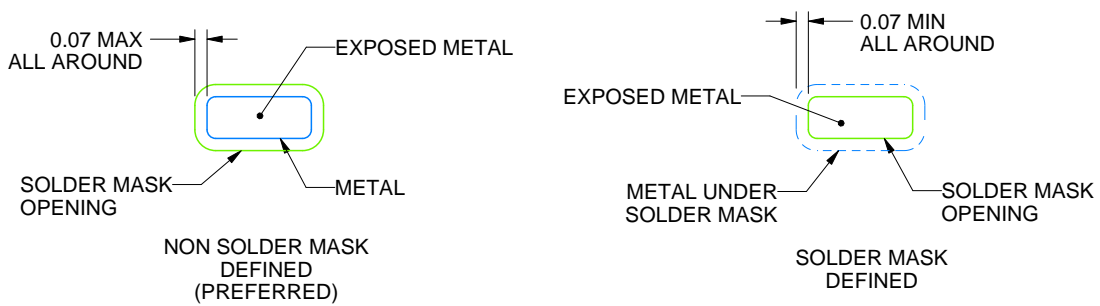

SOLDER MASK DETAILS

4218878/B 07/2018

NOTES: (continued)

4. This package is designed to be soldered to a thermal pad on the board. For more information, see Texas Instruments literature number SLUA271 (www.ti.com/lit/slua271).
5. Vias are optional depending on application, refer to device data sheet. If any vias are implemented, refer to their locations shown on this view. It is recommended that vias under paste be filled, plugged or tented.

EXAMPLE STENCIL DESIGN

DRC0010J

VSON - 1 mm max height

PLASTIC SMALL OUTLINE - NO LEAD

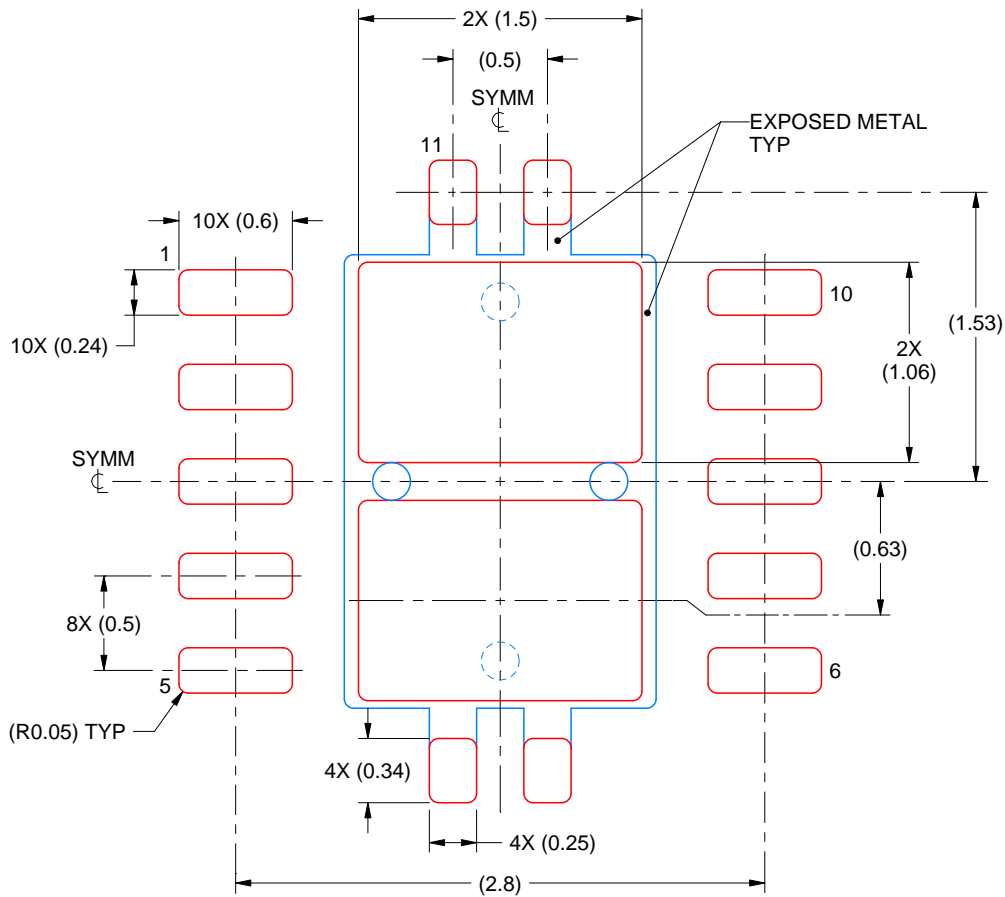

SOLDER PASTE EXAMPLE
BASED ON 0.125 mm THICK STENCIL

EXPOSED PAD 11:
80% PRINTED SOLDER COVERAGE BY AREA
SCALE:25X

4218878/B 07/2018

NOTES: (continued)

6. Laser cutting apertures with trapezoidal walls and rounded corners may offer better paste release. IPC-7525 may have alternate design recommendations.

IMPORTANT NOTICE AND DISCLAIMER

TI PROVIDES TECHNICAL AND RELIABILITY DATA (INCLUDING DATA SHEETS), DESIGN RESOURCES (INCLUDING REFERENCE DESIGNS), APPLICATION OR OTHER DESIGN ADVICE, WEB TOOLS, SAFETY INFORMATION, AND OTHER RESOURCES "AS IS" AND WITH ALL FAULTS, AND DISCLAIMS ALL WARRANTIES, EXPRESS AND IMPLIED, INCLUDING WITHOUT LIMITATION ANY IMPLIED WARRANTIES OF MERCHANTABILITY, FITNESS FOR A PARTICULAR PURPOSE OR NON-INFRINGEMENT OF THIRD PARTY INTELLECTUAL PROPERTY RIGHTS.

These resources are intended for skilled developers designing with TI products. You are solely responsible for (1) selecting the appropriate TI products for your application, (2) designing, validating and testing your application, and (3) ensuring your application meets applicable standards, and any other safety, security, regulatory or other requirements.

These resources are subject to change without notice. TI grants you permission to use these resources only for development of an application that uses the TI products described in the resource. Other reproduction and display of these resources is prohibited. No license is granted to any other TI intellectual property right or to any third party intellectual property right. TI disclaims responsibility for, and you will fully indemnify TI and its representatives against, any claims, damages, costs, losses, and liabilities arising out of your use of these resources.

TI's products are provided subject to [TI's Terms of Sale](#) or other applicable terms available either on [ti.com](https://www.ti.com) or provided in conjunction with such TI products. TI's provision of these resources does not expand or otherwise alter TI's applicable warranties or warranty disclaimers for TI products.

TI objects to and rejects any additional or different terms you may have proposed.

Mailing Address: Texas Instruments, Post Office Box 655303, Dallas, Texas 75265
Copyright © 2024, Texas Instruments Incorporated