

1.5V, micro SMD, Dual-Gain Analog Temperature Sensor with Class AB Output

Check for Samples: [LM94023](#)

FEATURES

- Low 1.5V Operation
- Push-pull Output with 50µA Source Current Capability
- Two Selectable Gains
- Very Accurate Over Wide Temperature Range of -50°C to $+150^{\circ}\text{C}$
- Low Quiescent Current
- Output is Short-circuit Protected
- Extremely Small DSBGA Package
- Footprint Compatible with the Industry-standard LM20 Temperature Sensor

APPLICATIONS

- Cell Phones
- Wireless Transceivers
- Battery Management
- Automotive
- Disk Drives
- Games
- Appliances

KEY SPECIFICATIONS

- Supply Voltage 1.5V to 5.5V
- Supply Current 5.4 µA (typ)
- Output Drive ± 50 µA
- Temperature Accuracy
 - 20°C to 40°C $\pm 1.5^{\circ}\text{C}$
 - -50°C to 70°C $\pm 1.8^{\circ}\text{C}$
 - -50°C to 90°C $\pm 2.1^{\circ}\text{C}$
 - -50°C to 150°C $\pm 2.7^{\circ}\text{C}$
- Operating Temperature -50°C to 150°C

DESCRIPTION

The LM94023 is a precision analog output CMOS integrated-circuit temperature sensor that operates at a supply voltage as low as 1.5 Volts. Available in the very small four-bump DSBGA 0.8mm x 0.8mm) the LM94023 occupies very little board area. A class-AB output structure gives the LM94023 strong output source and sink current capability for driving heavy loads, making it well suited to source the input of a sample-and-hold analog-to-digital converter with its transient load requirements. This generally means the LM94023 can be used without external components, like resistors and buffers, on the output. While operating over the wide temperature range of -50°C to $+150^{\circ}\text{C}$, the LM94023 delivers an output voltage that is inversely proportional to measured temperature. The LM94023's low supply current makes it ideal for battery-powered systems as well as general temperature sensing applications.

A Gain Select (GS) pin sets the gain of the temperature-to-voltage output transfer function. Either of two slopes are selectable: -5.5 mV/ $^{\circ}\text{C}$ (GS=0) or -8.2 mV/ $^{\circ}\text{C}$ (GS=1). In the lowest gain configuration, the LM94023 can operate with a 1.5V supply while measuring temperature over the full -50°C to $+150^{\circ}\text{C}$ operating range. Tying GS high causes the transfer function to have the largest gain for maximum temperature sensitivity. The gain-select inputs can be tied directly to V_{DD} or Ground without any pull-up or pull-down resistors, reducing component count and board area. These inputs can also be driven by logic signals allowing the system to optimize the gain during operation or system diagnostics.

Connection Diagram

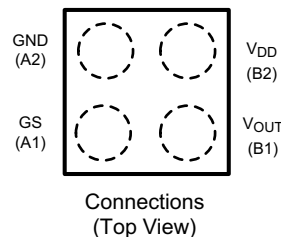

**Figure 1. DSBGA
Top View
See Package Number YFQ0004**



Please be aware that an important notice concerning availability, standard warranty, and use in critical applications of Texas Instruments semiconductor products and disclaimers thereto appears at the end of this data sheet.

All trademarks are the property of their respective owners.

Typical Transfer Characteristic

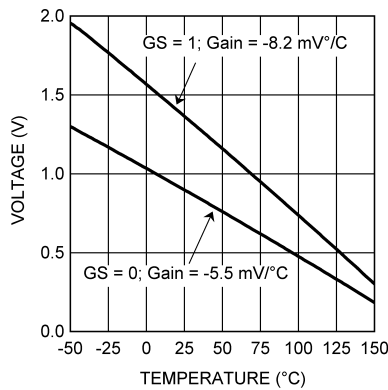
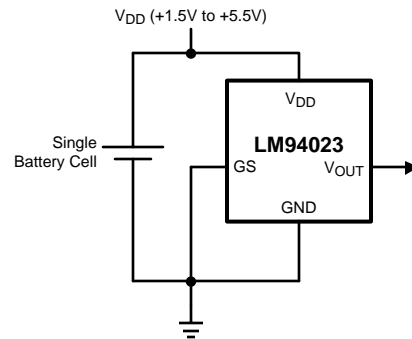

Figure 2. Output Voltage vs Temperature

Typical Application

Full-Range Celsius Temperature Sensor (–50°C to +150°C) Operating from a Single Battery Cell



PIN DESCRIPTIONS

Label	Pin Number	Type	Equivalent Circuit	Function
GS	A1	Logic Input		Gain Select - Input for selecting the slope of the analog output response
GND	A2	Ground		Power Supply Ground
V _{OUT}	B1	Analog Output		Outputs a voltage which is inversely proportional to temperature
V _{DD}	B2	Power		Positive Supply Voltage



These devices have limited built-in ESD protection. The leads should be shorted together or the device placed in conductive foam during storage or handling to prevent electrostatic damage to the MOS gates.

Absolute Maximum Ratings⁽¹⁾

Supply Voltage		-0.3V to +6.0V
Voltage at Output Pin		-0.3V to (V _{DD} + 0.3V)
Output Current		±7 mA
Voltage at GS Input Pin		-0.3V to +6.0V
Input Current at any pin ⁽²⁾		5 mA
Storage Temperature		-65°C to +150°C
Maximum Junction Temperature (T _{JMAX})		+150°C
ESD Susceptibility ⁽³⁾	Human Body Model	2500V
	Machine Model	250V
Soldering process must comply with Texas Instruments' Reflow Temperature Profile specifications. Refer to www.ti.com/packaging ⁽⁴⁾		

- (1) Absolute Maximum Ratings indicate limits beyond which damage to the device may occur. Operating Ratings indicate conditions for which the device is functional, but do not ensure specific performance limits. For ensured specifications and test conditions, see the Electrical Characteristics. The ensured specifications apply only for the test conditions listed. Some performance characteristics may degrade when the device is not operated under the listed test conditions.
- (2) When the input voltage (V_I) at any pin exceeds power supplies (V_I < GND or V_I > V⁺), the current at that pin should be limited to 5 mA.
- (3) The human body model is a 100 pF capacitor discharged through a 1.5 kΩ resistor into each pin. The machine model is a 200 pF capacitor discharged directly into each pin.
- (4) Reflow temperature profiles are different for lead-free and non-lead-free packages.

Operating Ratings⁽¹⁾

Specified Temperature Range	T_{MIN} ≤ T_A ≤ T_{MAX}
LM94023	-50°C ≤ T _A ≤ +150°C
Supply Voltage Range (V _{DD})	+1.5 V to +5.5 V
Thermal Resistance (θ _{JA}) ⁽²⁾⁽³⁾	122.6°C/W
LM94023BITME, LM94023BITMX	

- (1) Absolute Maximum Ratings indicate limits beyond which damage to the device may occur. Operating Ratings indicate conditions for which the device is functional, but do not ensure specific performance limits. For ensured specifications and test conditions, see the Electrical Characteristics. The ensured specifications apply only for the test conditions listed. Some performance characteristics may degrade when the device is not operated under the listed test conditions.
- (2) The junction to ambient thermal resistance (θ_{JA}) is specified without a heat sink in still air.
- (3) Changes in output due to self heating can be computed by multiplying the internal dissipation by the thermal resistance.

Accuracy Characteristics

These limits do not include DC load regulation. These stated accuracy limits are with reference to the values in the LM94023 Transfer Table.

Parameter	Conditions		Limits ⁽¹⁾	Units (Limit)
Temperature Error ⁽²⁾	GS=0	T _A = +20°C to +40°C; V _{DD} = 1.5V to 5.5V	±1.5	°C (max)
		T _A = +0°C to +70°C; V _{DD} = 1.5V to 5.5V	±1.8	°C (max)
		T _A = +0°C to +90°C; V _{DD} = 1.5V to 5.5V	±2.1	°C (max)
		T _A = +0°C to +120°C; V _{DD} = 1.5V to 5.5V	±2.4	°C (max)
		T _A = +0°C to +150°C; V _{DD} = 1.5V to 5.5V	±2.7	°C (max)
		T _A = -50°C to +0°C; V _{DD} = 1.6V to 5.5V	±1.8	°C (max)
	GS=1	T _A = +20°C to +40°C; V _{DD} = 1.8V to 5.5V	±1.5	°C (max)
		T _A = +0°C to +70°C; V _{DD} = 1.9V to 5.5V	±1.8	°C (max)
		T _A = +0°C to +90°C; V _{DD} = 1.9V to 5.5V	±2.1	°C (max)
		T _A = +0°C to +120°C; V _{DD} = 1.9V to 5.5V	±2.4	°C (max)
		T _A = +0°C to +150°C; V _{DD} = 1.9V to 5.5V	±2.7	°C (max)
		T _A = -50°C to +0°C; V _{DD} = 2.3V to 5.5V	±1.8	°C (max)

- (1) Limits are specified to Texas Instruments' AOQL (Average Outgoing Quality Level).
- (2) Accuracy is defined as the error between the measured and reference output voltages, tabulated in the Transfer Table at the specified conditions of supply gain setting, voltage, and temperature (expressed in °C). Accuracy limits include line regulation within the specified conditions. Accuracy limits do not include load regulation; they assume no DC load.

Electrical Characteristics

Unless otherwise noted, these specifications apply for $+V_{DD} = +1.5V$ to $+5.5V$. **Boldface limits apply for $T_A = T_J = T_{MIN}$ to T_{MAX}** ; all other limits $T_A = T_J = 25^\circ C$.

Symbol	Parameter	Conditions	Typical ⁽¹⁾	Limits ⁽²⁾	Units (Limit)	
	Sensor Gain	GS = 0	-5.5		mV/°C	
		GS = 1	-8.2		mV/°C	
	Load Regulation ⁽³⁾	$1.5V \leq V_{DD} < 5.5V$	Source $\leq 50 \mu A$, ($V_{DD} - V_{OUT}$) $\geq 200mV$	-0.22	-1	mV (max)
			Sink $\leq 50 \mu A$, $V_{OUT} \geq 200mV$	0.26	1	mV (max)
	Line Regulation ⁽⁴⁾		200		$\mu V/V$	
I_S	Supply Current	$T_A = +30^\circ C$ to $+150^\circ C$, ($V_{DD} - V_{OUT}$) $\geq 100mV$	5.4	8.1	μA (max)	
		$T_A = -50^\circ C$ to $+150^\circ C$, ($V_{DD} - V_{OUT}$) $\geq 100mV$	5.4	9	μA (max)	
C_L	Output Load Capacitance		1100		pF (max)	
	Power-on Time ⁽⁵⁾	$C_L = 0$ pF to 1100 pF	0.7	1.9	ms (max)	
V_{IH}	GS1 and GS0 Input Logic "1" Threshold Voltage			$V_{DD} - 0.5V$	V (min)	
V_{IL}	GS1 and GS0 Input Logic "0" Threshold Voltage			0.5	V (max)	
I_{IH}	Logic "1" Input Current ⁽⁶⁾		0.001	1	μA (max)	
I_{IL}	Logic "0" Input Current ⁽⁶⁾		0.001	1	μA (max)	

(1) Typicals are at $T_J = T_A = 25^\circ C$ and represent most likely parametric norm.

(2) Limits are specified to Texas Instruments' AOQL (Average Outgoing Quality Level).

(3) Source currents are flowing out of the LM94023. Sink currents are flowing into the LM94023.

(4) Line regulation (DC) is calculated by subtracting the output voltage at the highest supply voltage from the output voltage at the lowest supply voltage. The typical DC line regulation specification does not include the output voltage shift discussed in [Output Voltage Shift](#).

(5) Specified by design.

(6) The input current is leakage only and is highest at high temperature. It is typically only $0.001\mu A$. The $1\mu A$ limit is solely based on a testing limitation and does not reflect the actual performance of the part.

Typical Performance Characteristics

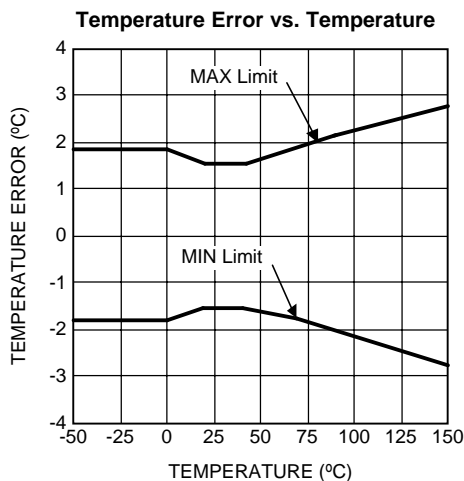

Figure 3.

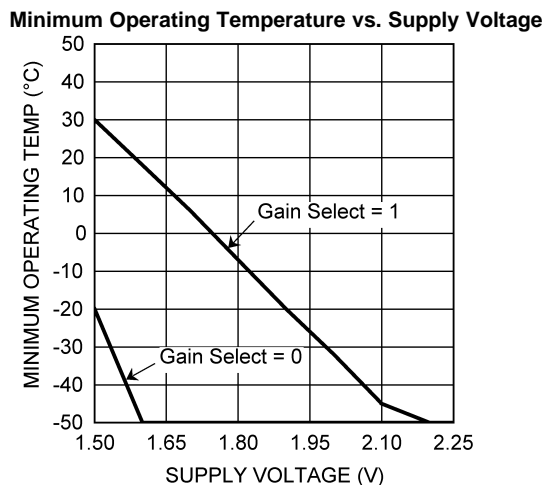

Figure 4.

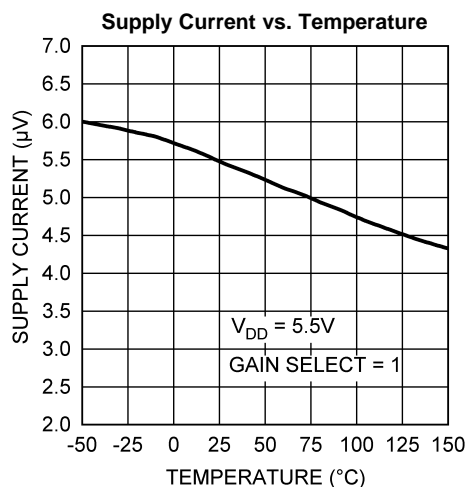

Figure 5.

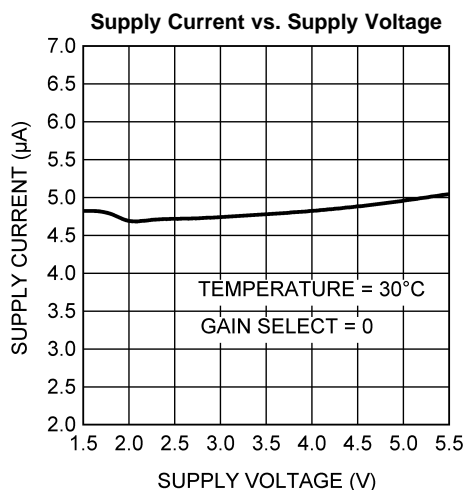

Figure 6.

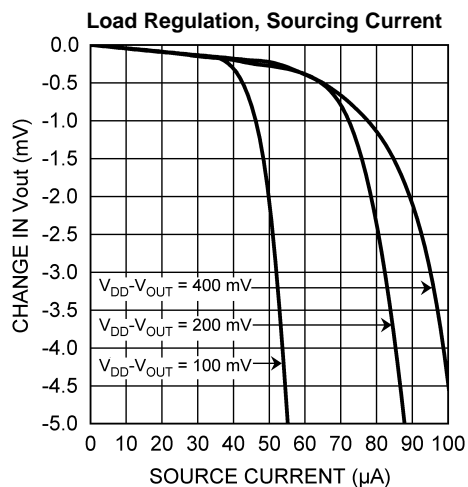

Figure 7.

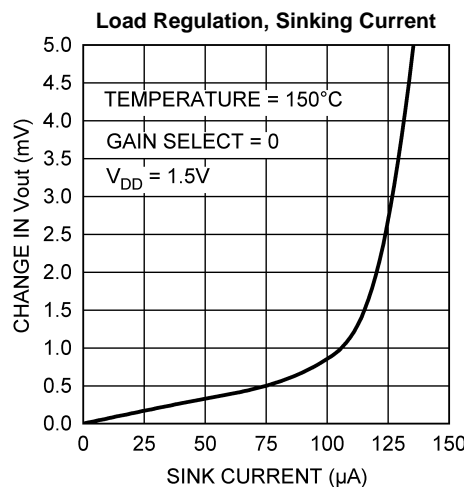

Figure 8.

Typical Performance Characteristics (continued)

Line Regulation: Change in Vout vs. Overhead Voltage

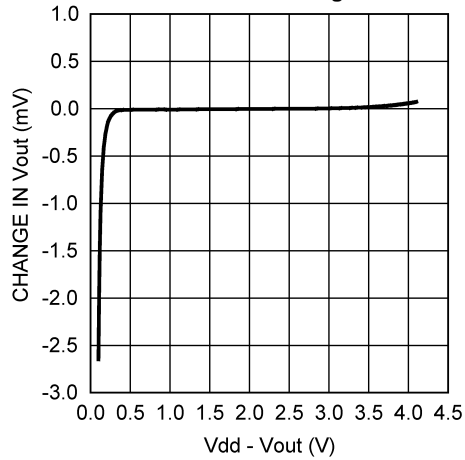

Figure 9.

Supply-Noise Gain vs. Frequency

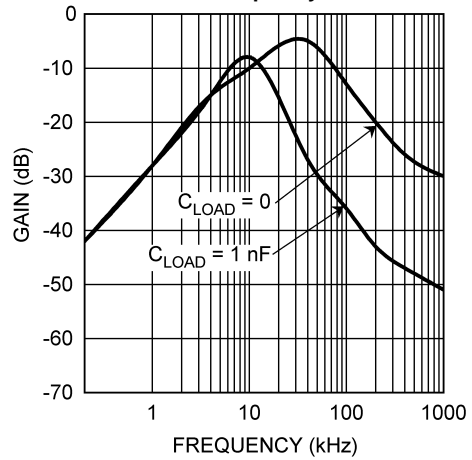

Figure 10.

Line Regulation: Output Voltage vs. Supply Voltage
Gain Select = 0

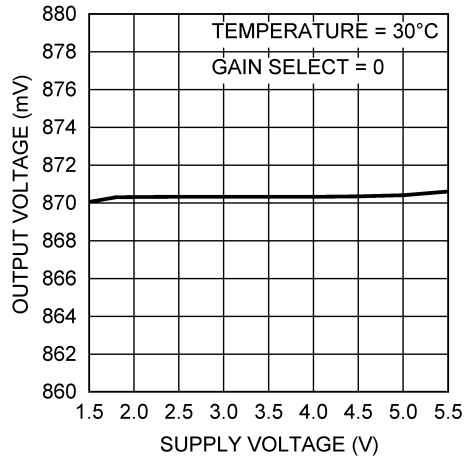

Figure 11.

Line Regulation: Output Voltage vs. Supply Voltage
Gain Select = 1

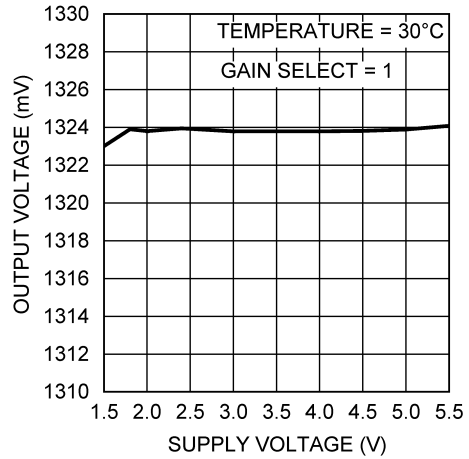

Figure 12.

LM94023 TRANSFER FUNCTION

The LM94023 has two selectable gains, selected by the Gain Select (GS) input pin. The output voltage for each gain, across the complete operating temperature range is shown in the LM94023 Transfer Table, below. This table is the reference from which the LM94023 accuracy specifications (listed in the [Electrical Characteristics](#) section) are determined. This table can be used, for example, in a host processor look-up table.

Table 1. LM94023 Temperature-Voltage Transfer Table

Temperature (°C)	GS = 0 (mV)	GS = 1 (mV)
-50	1299	1955
-49	1294	1949
-48	1289	1942
-47	1284	1935
-46	1278	1928
-45	1273	1921
-44	1268	1915
-43	1263	1908
-42	1257	1900
-41	1252	1892
-40	1247	1885
-39	1242	1877
-38	1236	1869
-37	1231	1861
-36	1226	1853
-35	1221	1845
-34	1215	1838
-33	1210	1830
-32	1205	1822
-31	1200	1814
-30	1194	1806
-29	1189	1798
-28	1184	1790
-27	1178	1783
-26	1173	1775
-25	1168	1767
-24	1162	1759
-23	1157	1751
-22	1152	1743
-21	1146	1735
-20	1141	1727
-19	1136	1719
-18	1130	1711
-17	1125	1703
-16	1120	1695
-15	1114	1687
-14	1109	1679
-13	1104	1671
-12	1098	1663
-11	1093	1656
-10	1088	1648

Table 1. LM94023 Temperature-Voltage Transfer Table (continued)

Temperature (°C)	GS = 0 (mV)	GS = 1 (mV)
-9	1082	1639
-8	1077	1631
-7	1072	1623
-6	1066	1615
-5	1061	1607
-4	1055	1599
-3	1050	1591
-2	1044	1583
-1	1039	1575
0	1034	1567
1	1028	1559
2	1023	1551
3	1017	1543
4	1012	1535
5	1007	1527
6	1001	1519
7	996	1511
8	990	1502
9	985	1494
10	980	1486
11	974	1478
12	969	1470
13	963	1462
14	958	1454
15	952	1446
16	947	1438
17	941	1430
18	936	1421
19	931	1413
20	925	1405
21	920	1397
22	914	1389
23	909	1381
24	903	1373
25	898	1365
26	892	1356
27	887	1348
28	882	1340
29	876	1332
30	871	1324
31	865	1316
32	860	1308
33	854	1299
34	849	1291
35	843	1283
36	838	1275
37	832	1267

Table 1. LM94023 Temperature-Voltage Transfer Table (continued)

Temperature (°C)	GS = 0 (mV)	GS = 1 (mV)
38	827	1258
39	821	1250
40	816	1242
41	810	1234
42	804	1225
43	799	1217
44	793	1209
45	788	1201
46	782	1192
47	777	1184
48	771	1176
49	766	1167
50	760	1159
51	754	1151
52	749	1143
53	743	1134
54	738	1126
55	732	1118
56	726	1109
57	721	1101
58	715	1093
59	710	1084
60	704	1076
61	698	1067
62	693	1059
63	687	1051
64	681	1042
65	676	1034
66	670	1025
67	664	1017
68	659	1008
69	653	1000
70	647	991
71	642	983
72	636	974
73	630	966
74	625	957
75	619	949
76	613	941
77	608	932
78	602	924
79	596	915
80	591	907
81	585	898
82	579	890
83	574	881
84	568	873

Table 1. LM94023 Temperature-Voltage Transfer Table (continued)

Temperature (°C)	GS = 0 (mV)	GS = 1 (mV)
85	562	865
86	557	856
87	551	848
88	545	839
89	539	831
90	534	822
91	528	814
92	522	805
93	517	797
94	511	788
95	505	779
96	499	771
97	494	762
98	488	754
99	482	745
100	476	737
101	471	728
102	465	720
103	459	711
104	453	702
105	448	694
106	442	685
107	436	677
108	430	668
109	425	660
110	419	651
111	413	642
112	407	634
113	401	625
114	396	617
115	390	608
116	384	599
117	378	591
118	372	582
119	367	573
120	361	565
121	355	556
122	349	547
123	343	539
124	337	530
125	332	521
126	326	513
127	320	504
128	314	495
129	308	487
130	302	478
131	296	469

Table 1. LM94023 Temperature-Voltage Transfer Table (continued)

Temperature (°C)	GS = 0 (mV)	GS = 1 (mV)
132	291	460
133	285	452
134	279	443
135	273	434
136	267	425
137	261	416
138	255	408
139	249	399
140	243	390
141	237	381
142	231	372
143	225	363
144	219	354
145	213	346
146	207	337
147	201	328
148	195	319
149	189	310
150	183	301

Although the LM94023 is very linear, its response does have a slight umbrella's parabolic shape. This shape is very accurately reflected in the LM94023 Transfer Table. The Transfer Table can be calculated by using the parabolic equation.

$$G0 : V_{TEMP} (mV) = 870.6mV - 5.506 \frac{mV}{^{\circ}C} (T - 30^{\circ}C) - 0.00176 \frac{mV}{^{\circ}C^2} (T - 30^{\circ}C)^2$$

$$G1 : V_{TEMP} (mV) = 1324.0mV - 8.194 \frac{mV}{^{\circ}C} (T - 30^{\circ}C) - 0.00262 \frac{mV}{^{\circ}C^2} (T - 30^{\circ}C)^2 \quad (1)$$

For a linear approximation, a line can easily be calculated over the desired temperature range from the Table using the two-point equation:

$$V - V_1 = \left(\frac{V_2 - V_1}{T_2 - T_1} \right) \times (T - T_1) \quad (2)$$

Where V is in mV, T is in °C, T₁ and V₁ are the coordinates of the lowest temperature, T₂ and V₂ are the coordinates of the highest temperature.

For example, if we want to determine the equation of a line with the Gain Setting at GS1 = 0 and GS0 = 0, over a temperature range of 20°C to 50°C, we would proceed as follows:

$$V - 925 mV = \left(\frac{760 mV - 925 mV}{50^{\circ}C - 20^{\circ}C} \right) \times (T - 20^{\circ}C) \quad (3)$$

$$V - 925 mV = (-5.50 mV / ^{\circ}C) \times (T - 20^{\circ}C) \quad (4)$$

$$V = (-5.50 mV / ^{\circ}C) \times T + 1035 mV \quad (5)$$

Using this method of linear approximation, the transfer function can be approximated for one or more temperature ranges of interest.

Mounting and Thermal Conductivity

The LM94023 can be applied easily in the same way as other integrated-circuit temperature sensors. It can be glued or cemented to a surface.

To ensure good thermal conductivity, the backside of the LM94023 die is directly attached to the GND pin (Pin 2). The temperatures of the lands and traces to the other leads of the LM94023 will also affect the temperature reading.

Alternatively, the LM94023 can be mounted inside a sealed-end metal tube, and can then be dipped into a bath or screwed into a threaded hole in a tank. As with any IC, the LM94023 and accompanying wiring and circuits must be kept insulated and dry, to avoid leakage and corrosion. This is especially true if the circuit may operate at cold temperatures where condensation can occur. If moisture creates a short circuit from the output to ground or V_{DD} , the output from the LM94023 will not be correct. Printed-circuit coatings are often used to ensure that moisture cannot corrode the leads or circuit traces.

The thermal resistance junction to ambient (θ_{JA}) is the parameter used to calculate the rise of a device junction temperature due to its power dissipation. The equation used to calculate the rise in the LM94023's die temperature is

$$T_J = T_A + \theta_{JA} [(V_{DD}I_Q) + (V_{DD} - V_O) I_L] \quad (6)$$

where T_A is the ambient temperature, I_Q is the quiescent current, I_L is the load current on the output, and V_O is the output voltage. For example, in an application where $T_A = 30^\circ\text{C}$, $V_{DD} = 5\text{ V}$, $I_{DD} = 9\ \mu\text{A}$, Gain Select = 11, $V_{OUT} = 2.231\text{ mV}$, and $I_L = 2\ \mu\text{A}$, the junction temperature would be 30.021°C , showing a self-heating error of only 0.021°C . Since the LM94023's junction temperature is the actual temperature being measured, care should be taken to minimize the load current that the LM94023 is required to drive. [Table 2](#) shows the thermal resistance of the LM94023.

Table 2. LM94023 Thermal Resistance

Device Number	NS Package Number	Thermal Resistance (θ_{JA})
LM94023BITME, LM94023BITMX	YFQ0004	122.6 $^\circ\text{C}/\text{W}$

Output and Noise Considerations

A push-pull output gives the LM94023 the ability to sink and source significant current. This is beneficial when, for example, driving dynamic loads like an input stage on an analog-to-digital converter (ADC). In these applications the source current is required to quickly charge the input capacitor of the ADC. See the [Applications Circuits](#) section for more discussion of this topic. The LM94023 is ideal for this and other applications which require strong source or sink current.

The LM94023's supply-noise gain (the ratio of the AC signal on V_{OUT} to the AC signal on V_{DD}) was measured during bench tests. It's typical attenuation is shown in the [Typical Performance Characteristics](#) section. A load capacitor on the output can help to filter noise.

For operation in very noisy environments, some bypass capacitance should be present on the supply within approximately 2 inches of the LM94023.

Capacitive Loads

The LM94023 handles capacitive loading well. In an extremely noisy environment, or when driving a switched sampling input on an ADC, it may be necessary to add some filtering to minimize noise coupling. Without any precautions, the LM94023 can drive a capacitive load less than or equal to 1100 pF as shown in [Figure 13](#). For capacitive loads greater than 1100 pF, a series resistor may be required on the output, as shown in [Figure 14](#).

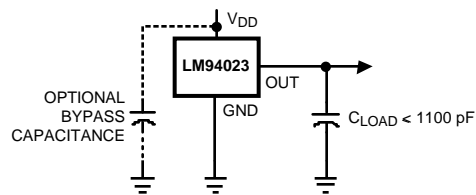

Figure 13. LM94023 No Decoupling Required for Capacitive Loads Less than 1100 pF

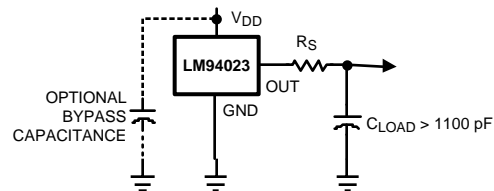

Figure 14. LM94023 with Series Resistor for Capacitive Loading Greater than 1100 pF

C_{LOAD}	Minimum R_S
1.1 nF to 99 nF	3 k Ω
100 nF to 999 nF	1.5 k Ω
1 μ F	800 Ω

Output Voltage Shift

The LM94023 is very linear over temperature and supply voltage range. Due to the intrinsic behavior of an NMOS/PMOS rail-to-rail buffer, a slight shift in the output can occur when the supply voltage is ramped over the operating range of the device. The location of the shift is determined by the relative levels of V_{DD} and V_{OUT} . The shift typically occurs when $V_{DD} - V_{OUT} = 1.0V$.

This slight shift (a few millivolts) takes place over a wide change (approximately 200 mV) in V_{DD} or V_{OUT} . Since the shift takes place over a wide temperature change of 5°C to 20°C, V_{OUT} is always monotonic. The accuracy specifications in the [Electrical Characteristics](#) table already include this possible shift.

Selectable Gain for Optimization and In Situ Testing

The Gain Select digital inputs can be tied to the rails or can be driven from digital outputs such as microcontroller GPIO pins. In low-supply voltage applications, the ability to reduce the gain to -5.5 mV/°C allows the LM94023 to operate over the full -50 °C to 150 °C range. When a larger supply voltage is present, the gain can be increased as high as -8.2 mV/°C. The larger gain is optimal for reducing the effects of noise (for example, noise coupling on the output line or quantization noise induced by an analog-to-digital converter which may be sampling the LM94023 output).

Another application advantage of the digitally selectable gain is the ability to perform dynamic testing of the LM94023 while it is running in a system. By toggling the logic levels of the gain select pin and monitoring the resultant change in the output voltage level, the host system can verify the functionality of the LM94023.

Applications Circuits

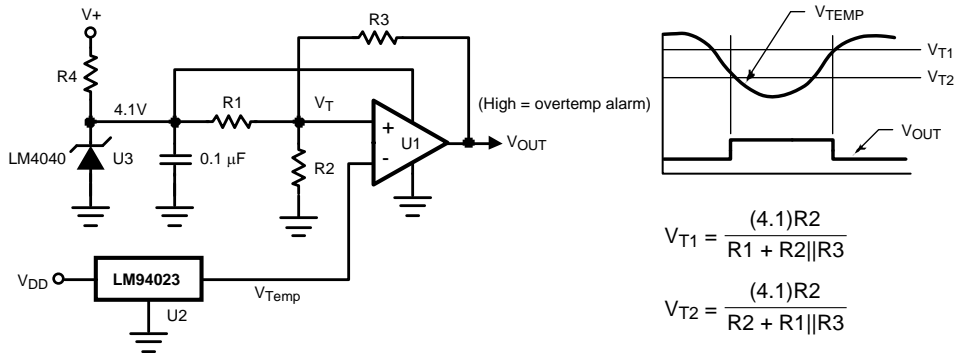

Figure 15. Celsius Thermostat

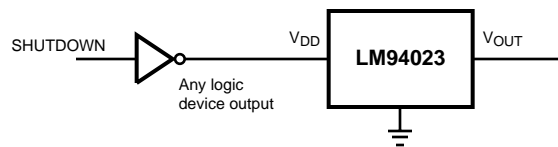
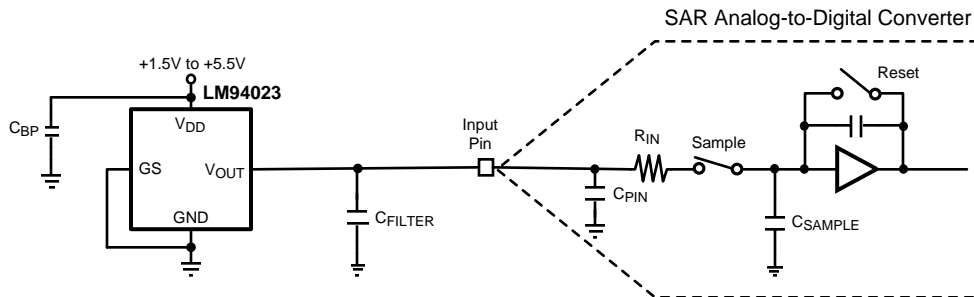

Figure 16. Conserving Power Dissipation with Shutdown



Most CMOS ADCs found in microcontrollers and ASICs have a sampled data comparator input structure. When the ADC charges the sampling cap, it requires instantaneous charge from the output of the analog source such as the LM94023 temperature sensor and many op amps. This requirement is easily accommodated by the addition of a capacitor (C_{FILTER}). The size of C_{FILTER} depends on the size of the sampling capacitor and the sampling frequency. Since not all ADCs have identical input stages, the charge requirements will vary. This general ADC application is shown as an example only.

Figure 17. Suggested Connection to a Sampling Analog-to-Digital Converter Input Stage

REVISION HISTORY

PACKAGING INFORMATION

Orderable part number	Status (1)	Material type (2)	Package Pins	Package qty Carrier	RoHS (3)	Lead finish/ Ball material (4)	MSL rating/ Peak reflow (5)	Op temp (°C)	Part marking (6)
LM94023BITME/NOPB	Obsolete	Production	DSBGA (YFQ) 4	-	-	Call TI	Call TI	-50 to 150	
LM94023BITMX/NOPB	Active	Production	DSBGA (YFQ) 4	3000 LARGE T&R	Yes	SNAGCU	Level-1-260C-UNLIM	-50 to 150	

(1) **Status:** For more details on status, see our [product life cycle](#).

(2) **Material type:** When designated, preproduction parts are prototypes/experimental devices, and are not yet approved or released for full production. Testing and final process, including without limitation quality assurance, reliability performance testing, and/or process qualification, may not yet be complete, and this item is subject to further changes or possible discontinuation. If available for ordering, purchases will be subject to an additional waiver at checkout, and are intended for early internal evaluation purposes only. These items are sold without warranties of any kind.

(3) **RoHS values:** Yes, No, RoHS Exempt. See the [TI RoHS Statement](#) for additional information and value definition.

(4) **Lead finish/Ball material:** Parts may have multiple material finish options. Finish options are separated by a vertical ruled line. Lead finish/Ball material values may wrap to two lines if the finish value exceeds the maximum column width.

(5) **MSL rating/Peak reflow:** The moisture sensitivity level ratings and peak solder (reflow) temperatures. In the event that a part has multiple moisture sensitivity ratings, only the lowest level per JEDEC standards is shown. Refer to the shipping label for the actual reflow temperature that will be used to mount the part to the printed circuit board.

(6) **Part marking:** There may be an additional marking, which relates to the logo, the lot trace code information, or the environmental category of the part.

Multiple part markings will be inside parentheses. Only one part marking contained in parentheses and separated by a "~" will appear on a part. If a line is indented then it is a continuation of the previous line and the two combined represent the entire part marking for that device.

Important Information and Disclaimer:The information provided on this page represents TI's knowledge and belief as of the date that it is provided. TI bases its knowledge and belief on information provided by third parties, and makes no representation or warranty as to the accuracy of such information. Efforts are underway to better integrate information from third parties. TI has taken and continues to take reasonable steps to provide representative and accurate information but may not have conducted destructive testing or chemical analysis on incoming materials and chemicals. TI and TI suppliers consider certain information to be proprietary, and thus CAS numbers and other limited information may not be available for release.

In no event shall TI's liability arising out of such information exceed the total purchase price of the TI part(s) at issue in this document sold by TI to Customer on an annual basis.

TAPE AND REEL INFORMATION

QUADRANT ASSIGNMENTS FOR PIN 1 ORIENTATION IN TAPE

*All dimensions are nominal

Device	Package Type	Package Drawing	Pins	SPQ	Reel Diameter (mm)	Reel Width W1 (mm)	A0 (mm)	B0 (mm)	K0 (mm)	P1 (mm)	W (mm)	Pin1 Quadrant
LM94023BITMX/NOPB	DSBGA	YFQ	4	3000	178.0	8.4	0.89	0.89	0.76	4.0	8.0	Q1

TAPE AND REEL BOX DIMENSIONS

*All dimensions are nominal

Device	Package Type	Package Drawing	Pins	SPQ	Length (mm)	Width (mm)	Height (mm)
LM94023BITMX/NOPB	DSBGA	YFQ	4	3000	208.0	191.0	35.0

YFQ0004

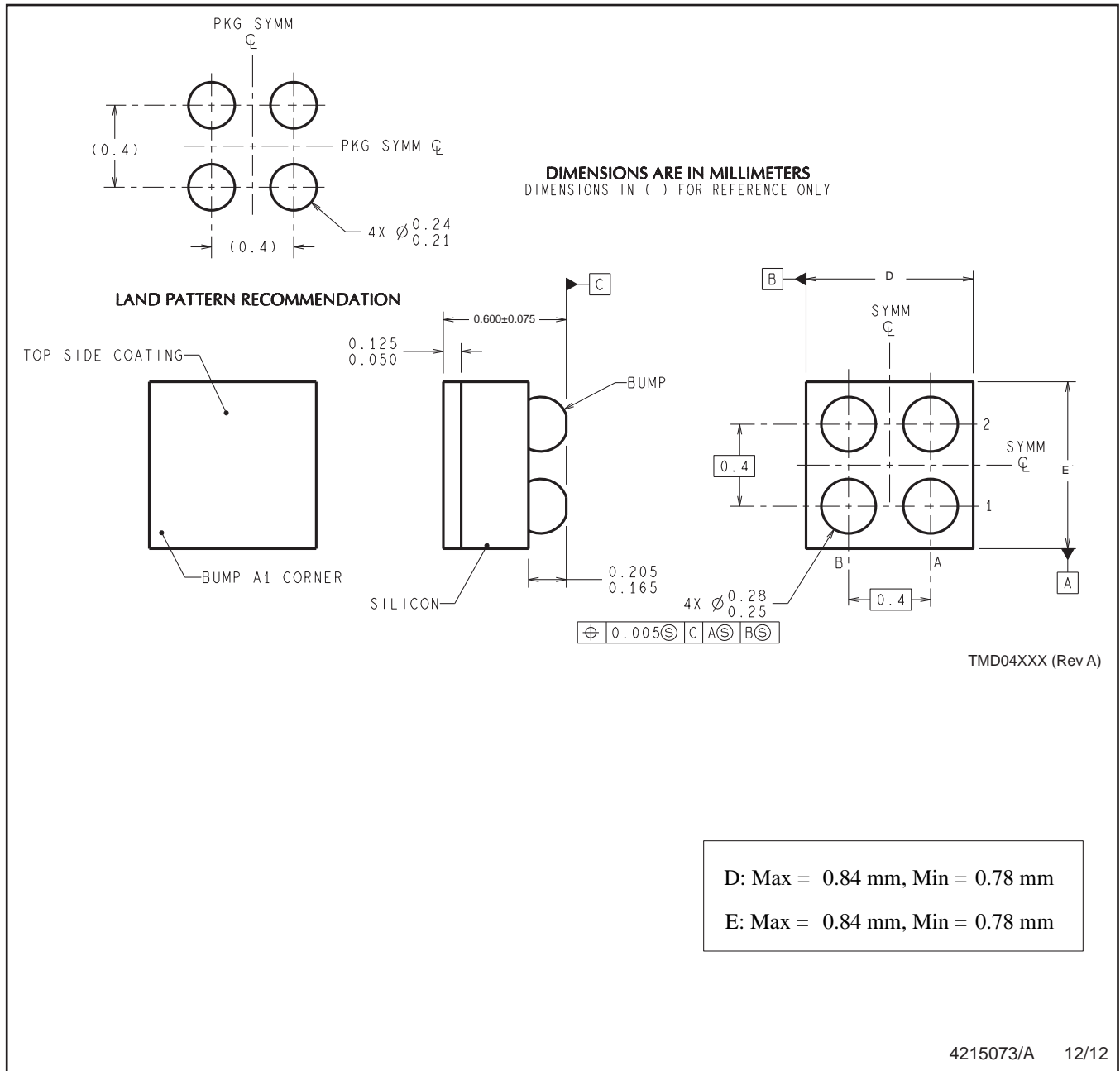

NOTES: A. All linear dimensions are in millimeters. Dimensioning and tolerancing per ASME Y14.5M-1994.
 B. This drawing is subject to change without notice.

IMPORTANT NOTICE AND DISCLAIMER

TI PROVIDES TECHNICAL AND RELIABILITY DATA (INCLUDING DATA SHEETS), DESIGN RESOURCES (INCLUDING REFERENCE DESIGNS), APPLICATION OR OTHER DESIGN ADVICE, WEB TOOLS, SAFETY INFORMATION, AND OTHER RESOURCES "AS IS" AND WITH ALL FAULTS, AND DISCLAIMS ALL WARRANTIES, EXPRESS AND IMPLIED, INCLUDING WITHOUT LIMITATION ANY IMPLIED WARRANTIES OF MERCHANTABILITY, FITNESS FOR A PARTICULAR PURPOSE OR NON-INFRINGEMENT OF THIRD PARTY INTELLECTUAL PROPERTY RIGHTS.

These resources are intended for skilled developers designing with TI products. You are solely responsible for (1) selecting the appropriate TI products for your application, (2) designing, validating and testing your application, and (3) ensuring your application meets applicable standards, and any other safety, security, regulatory or other requirements.

These resources are subject to change without notice. TI grants you permission to use these resources only for development of an application that uses the TI products described in the resource. Other reproduction and display of these resources is prohibited. No license is granted to any other TI intellectual property right or to any third party intellectual property right. TI disclaims responsibility for, and you will fully indemnify TI and its representatives against, any claims, damages, costs, losses, and liabilities arising out of your use of these resources.

TI's products are provided subject to [TI's Terms of Sale](#) or other applicable terms available either on [ti.com](https://www.ti.com) or provided in conjunction with such TI products. TI's provision of these resources does not expand or otherwise alter TI's applicable warranties or warranty disclaimers for TI products.

TI objects to and rejects any additional or different terms you may have proposed.

Mailing Address: Texas Instruments, Post Office Box 655303, Dallas, Texas 75265

Copyright © 2025, Texas Instruments Incorporated