

High Performance Quad DVGA

Check for Samples: [LMH6523](#)

FEATURES

- **OIP3: 49dBm at 200MHz**
- **Noise Figure: 8.5dB**
- **Voltage Gain: 26dB**
- **1dB Gain Steps**
- **Enable Pins Active in SPI Mode**
- **-3dB Bandwidth of 1400 MHz**
- **Gain Step Accuracy: 0.2 dB**
- **Disable Function for Each Channel**
- **Parallel and Serial Gain Control**
- **Low Power Mode for Power Management Flexibility**
- **Small Footprint WQFN Package**

APPLICATIONS

- **Cellular Base Stations**
- **Wideband and Narrowband IF Sampling Receivers**
- **Wideband Direct Conversion**
- **ADC Driver**

DESCRIPTION

The LMH6523 contains four, high performance, digitally controlled variable gain amplifiers (DVGA). It has been designed for use in narrowband and broadband IF sampling applications. Typically, the LMH6523 drives a high performance ADC in a broad range of mixed signal and digital communication applications such as mobile radio and cellular base stations where automatic gain control (AGC) is required to increase system dynamic range.

Each channel of LMH6523 has an independent, digitally controlled attenuator and a high linearity, differential output, amplifier. All circuitry has been optimized for low distortion and maximum system design flexibility. Power consumption is managed by a three-state enable pin. Individual channels can be disabled or placed into a Low Power Mode or a higher performance, High Power Mode. The enable pin is active in both serial and parallel modes for systems that require high speed power control.

The LMH6523 digitally controlled attenuator provides precise 1dB gain steps over a 31dB range. The digital attenuator can be controlled by either a SPI™ Serial bus or a high speed parallel bus.

The output amplifier has a differential output, allowing large signal swings on a single 5V supply. The low impedance output provides maximum flexibility when driving a wide range filter designs or analog to digital converters. For applications which have very large changes in signal level LMH6523 can support up to 62dB of gain range by cascading channels.

The LMH6523 operates over the industrial temperature range of -40°C to 85°C. The LMH6523 is available in a 54-Pin, thermally enhanced, WQFN package.

PERFORMANCE CURVE

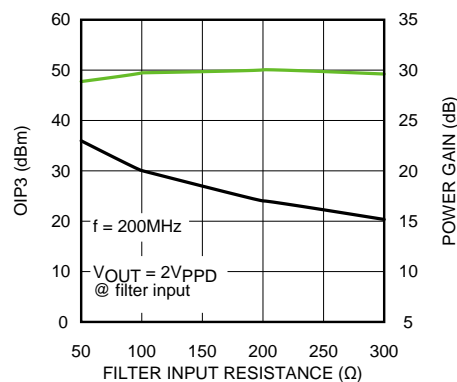

SVA-30206581



Please be aware that an important notice concerning availability, standard warranty, and use in critical applications of Texas Instruments semiconductor products and disclaimers thereto appears at the end of this data sheet.

SPI is a trademark of Motorola, Inc.



These devices have limited built-in ESD protection. The leads should be shorted together or the device placed in conductive foam during storage or handling to prevent electrostatic damage to the MOS gates.

BLOCK DIAGRAM

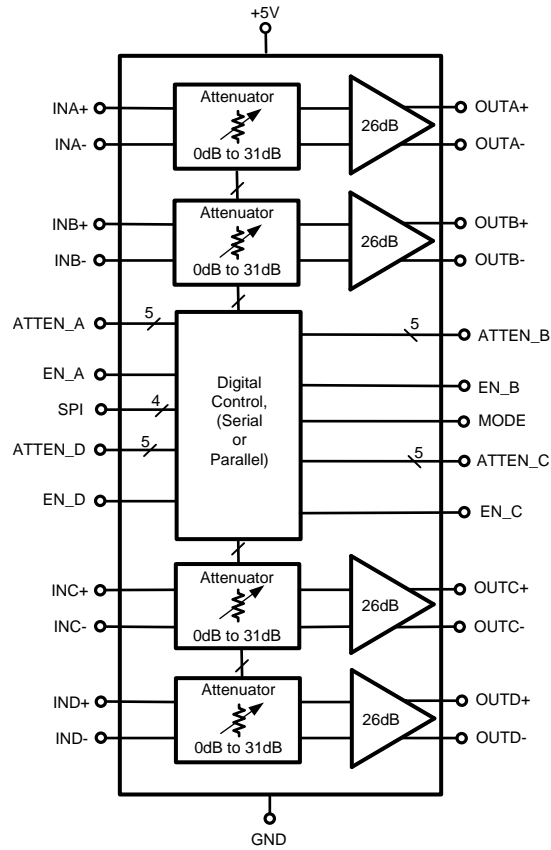

SVA-30206532

ABSOLUTE MAXIMUM RATINGS⁽¹⁾

If Military/Aerospace specified devices are required, please contact the Texas Instruments Sales Office/ Distributors for availability and specifications.

		VALUE	UNIT
ESD Tolerance ⁽²⁾	Human Body Model	2	kV
	Machine Model	200	V
	Charged Device Model	750	V
Positive Supply Voltage (Pin 3)		-0.6 to 5.5	V
Differential Voltage between Any Two Grounds		<200	mV
Analog Input Voltage Range		-0.6 to 5.5	V
Digital Input Voltage Range		-0.6 to 5.5	V
Output Short circuit Duration (one pin to ground)		Infinite	
Junction Temperature		150	°C
Storage Temperature Range		-65 to 150	°C
Soldering Information Infrared or Convection (30 sec)		260	°C

- (1) Absolute Maximum Ratings indicate limits beyond which damage to the device may occur. Operating Ratings indicate conditions for which the device is intended to be functional, but specific performance is **not** guaranteed. For specified specifications, see the Electrical Characteristics tables.
- (2) Human Body Model, applicable std. MIL-STD-883, Method 3015.7. Machine Model, applicable std. JESD22-A115-A (ESD MM std. of JEDEC) Field-Induced Charge-Device Model, applicable std. JESD22-C101-C (ESD FICDM std. of JEDEC).

RECOMMENDED OPERATING CONDITIONS⁽¹⁾

over operating free-air temperature range (unless otherwise noted)

	MIN	NOM	MAX	UNIT
Supply Voltage (Pin 3)	4.75		5.25	V
Differential Voltage Between Any Two Grounds			<10	mV
Analog Input Voltage Range, AC Coupled	0		V+	V
Temperature Range ⁽²⁾	-40		85	°C
Package Thermal Resistance ⁽³⁾	(θ_{JA})		(θ_{JC})	
54 pin WQFN	23		4.7	°C/W

- (1) Absolute Maximum Ratings indicate limits beyond which damage to the device may occur. Operating Ratings indicate conditions for which the device is intended to be functional, but specific performance is **not** guaranteed. For specified specifications, see the Electrical Characteristics tables.
- (2) The maximum power dissipation is a function of $T_{J(MAX)}$, θ_{JA} . The maximum allowable power dissipation at any ambient temperature is $P_D = (T_{J(MAX)} - T_A) / \theta_{JA}$. All numbers apply for packages soldered directly onto a PC Board.
- (3) Junction to ambient (θ_{JA}) thermal resistance measured on JEDEC 4 layer board. Junction to case (θ_{JC}) thermal resistance measured at exposed thermal pad; package is not mounted to any PCB.

ELECTRICAL CHARACTERISTICS - 5V⁽¹⁾ ⁽²⁾

The following specifications apply for single supply with $V_+ = 5V$, Maximum Gain (0 Attenuation), $R_L = 200\Omega$, $V_{OUT} = 4V_{PPD}$, $f_{in} = 200$ MHz, High Power Mode, **Boldface** limits apply at temperature extremes.

PARAMETER	TEST CONDITIONS	MIN	TYP	MAX	UNIT
DYNAMIC PERFORMANCE					
3dB BW	-3dB Bandwidth	$V_{OUT} = 2 V_{PPD}$		1.4	GHz
	Output Noise Voltage	Source = 100 Ω		30	nV/ \sqrt{Hz}
NF	Noise Figure	Source = 100 Ω		8.5	dB
OIP3	Output Third Order Intercept Point	f = 100 MHz, $V_{OUT} = 4$ dBm per tone		53	dBm
		f = 200 MHz, $V_{OUT} = 4$ dBm per tone		49	
OIP2	Output Second Order Intercept Point	POUT = 4 dBm per Tone, f1 = 101 MHz, f2 = 203 MHz		78	dBm

- (1) Electrical Table values apply only for factory testing conditions at the temperature indicated. **No** guarantee of parametric performance is indicated in the electrical tables under conditions different than those tested
- (2) Negative input current implies current flowing out of the device.

ELECTRICAL CHARACTERISTICS - 5V (continued)

The following specifications apply for single supply with $V_+ = 5V$, Maximum Gain (0 Attenuation), $R_L = 200\Omega$, $V_{OUT} = 4V_{PPD}$, $f_{in} = 200\text{ MHz}$, High Power Mode, **Boldface** limits apply at temperature extremes.

PARAMETER		TEST CONDITIONS	MIN	TYP	MAX	UNIT
IMD3	Third Order Intermodulation Products	$f = 100\text{ MHz}$, $V_{OUT} = 4\text{ dBm}$ per tone		-98		dBc
		$f = 200\text{ MHz}$, $V_{OUT} = 4\text{ dBm}$ per tone		-90		
P1dB	1dB Compression Point			17		dBm
HD2	Second Order Harmonic Distortion	$f = 100\text{ MHz}$, $V_{OUT} = 2 V_{PPD}$		-88		dBc
		$f = 200\text{ MHz}$, $V_{OUT} = 2 V_{PPD}$		-78		
HD3	Third Order Harmonic Distortion	$f = 100\text{ MHz}$, $V_{OUT} = 2 V_{PPD}$		-99		dBc
		$f = 200\text{ MHz}$, $V_{OUT} = 2 V_{PPD}$		-75		
CMRR	Common Mode Rejection	$P_{in} = -15\text{ dBm}$		-35		dBc
ANALOG I/O						
R_{IN}	Input Resistance	Differential, Measured at DC		97		Ω
V_{ICM}	Input Common Mode Voltage	Self Biased		2.5		V
	Maximum Input Voltage Swing	Volts peak to peak, differential		5.5		V_{PPD}
	Maximum Differential Output Voltage Swing	Differential, $f < 10\text{ MHz}$		10		V_{PPD}
R_{OUT}	Output Resistance	Differential, Measured at DC		20		Ω
X_{TLK}	Channel to Channel Crosstalk	Maximum Gain, $f = 200\text{ MHz}$		-65		dBc
GAIN PARAMETERS						
	Maximum Voltage Gain	Attenuation code 00000		25.74		dB
	Minimum Gain	Attenuation code 11111		-4.3		dB
	Gain Steps			32		
	Gain Step Size			1		dB
	Channel Matching	Gain error between channels		± 0.15		dB
	Gain Step Error	Any two adjacent steps over entire range		± 0.5		dB
		Any two adjacent steps, 0 dB attenuation to 23 dB attenuation		± 0.1		
	Gain Step Phase Shift	Any two adjacent steps over entire range		± 3		Degrees
		Any two adjacent steps, 0dB attenuation to 23 dB attenuation		± 2		
	Gain Step Switching Time			20		ns
	Enable/ Disable Time	Settled to 90% level		200		ns
POWER REQUIREMENTS						
ICC	Supply Current			465	485	mA
P	Power			2.3	2.43	W
I_{BIAS}	Output Pin Bias Current	External inductor, no load, $V_{OUT} < 200\text{ mV}$		36		mA
ICC	Disabled Supply Current			74		mA
ALL DIGITAL INPUTS EXCEPT ENABLES						
	Logic Compatibility	TTL, 2.5V CMOS, 3.3V CMOS, 5V CMOS				
V_{IL}	Logic Input Low Voltage		0		0.4	V
V_{IH}	Logic Input High Voltage		2		5	V
I_{IH}	Logic Input High Input Current	Digital Input Voltage = 2.0 V		-9		μA
I_{IL}	Logic Input Low Input Current	Digital Input Voltage = 0.4 V		-47		μA

ELECTRICAL CHARACTERISTICS - 5V (continued)

The following specifications apply for single supply with $V_+ = 5V$, Maximum Gain (0 Attenuation), $R_L = 200\Omega$, $V_{OUT} = 4V_{PPD}$, $f_{in} = 200\text{ MHz}$, High Power Mode, **Boldface** limits apply at temperature extremes.

PARAMETER		TEST CONDITIONS	MIN	TYP	MAX	UNIT
ENABLE PINS						
V_{IL}	Logic Input Low Voltage	Amplifier disabled	0		0.4	V
V_{IM}	Logic Input Mid Level	Amplifier Low Power Mode	0.6		1.9	V
V_{IH}	Logic Input High Level	Amplifier High Power Mode	2.2		5	V
V_{SB}	Enable Pin Self Bias Voltage	No external load		1.37		V
I_{IL}	Input Bias Current, Logic Low	Digital input voltage = 0.2V		-200		μA
I_{IM}	Input Bias Current, Logic Mid	Digital input voltage = 1.5V		28		μA
I_{IH}	Input Bias Current, Logic High	Digital input voltage = 3.0V		500		μA
PARALLEL MODE TIMING						
t_{GS}	Setup Time		3			ns
t_{GH}	Hold Time		3			ns
SERIAL MODE						
f_{CLK}	SPI Clock Frequency	50% duty cycle, ATE tested at 20MHz	20	50		MHz
LOW POWER MODE						
(Enable pins are self biased)						
ICC	Total Supply Current	all four channels in low power mode		370	398	mA
I_{BIAS}	Output Pin Bias Current	External Inductor, No Load, $V_{OUT} < 200\text{mV}$		26		mA
I_{CC}	Disabled Supply Current	Enable Pin < 0.4V		74		mA
OIP3	Output Intermodulation Intercept Point	$f = 200\text{ MHz}$, $V_{OUT} = 4\text{ dBm per tone}$		44		dBm
P1dB	1dB Compression Point			16		dBm
HD2	Second Order Harmonic Distortion	$f = 100\text{ MHz}$, $V_{OUT} = 2\text{ VPPD}$		-90		dBc
		$f = 200\text{ MHz}$, $V_{OUT} = 2\text{ VPPD}$		-79		dBc
HD3	Third Order Harmonic Distortion	$f = 100\text{ MHz}$, $V_{OUT} = 2\text{ VPPD}$		-91		dBc
		$f = 200\text{ MHz}$, $V_{OUT} = 2\text{ VPPD}$		-79		dBc

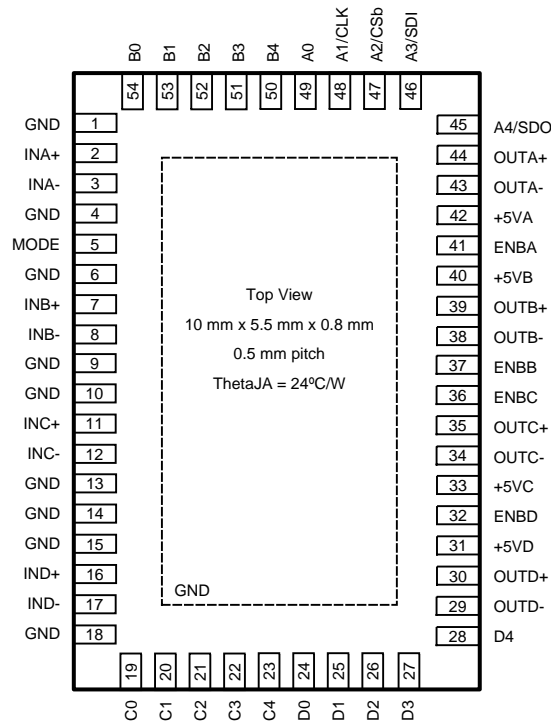

SVA-30206503

Figure 1. 54-Pin WQFN Connection Diagram, (Top View)

Table 1. PIN FUNCTIONS

PIN NUMBER	SYMBOL	PIN CATEGORY	DESCRIPTION
Analog I/O			
2, 3	INA+, INA –	Analog Input	Differential inputs channel A
44, 43	OUTA+, OUTA-	Analog Output	Differential outputs Channel A
7, 8	INB+, INB–	Analog Input	Differential inputs channel B
39, 38	OUTB+, OUTB–	Analog Output	Differential outputs Channel B
11, 12	INC+, INC–	Analog Input	Differential inputs channel C
35, 34	OUTC+, OUTC–	Analog Output	Differential outputs Channel C
16, 17	IND+, IND–	Analog Input	Differential inputs channel D
30, 29	OUTD+, OUTD–	Analog Output	Differential outputs Channel D
Power			
1, 4, 6, 9, 10, 13, 14, 15, 18	GND	Ground	Ground pins. Connect to low impedance ground plane. All pin voltages are specified with respect to the voltage on these pins. The exposed thermal pad is internally bonded to the ground pins.
31, 33, 40, 42	+5VD, +5VC, +5VB, +5VA	Power	Power supply pins. Valid power supply range is 4.75V to 5.25V.
Exposed Center Pad		Thermal/ Ground	Thermal management/ Ground
Digital Inputs			
5	MODE	Digital Input	0 = Parallel Mode, 1 = Serial Mode
Enable Pins (active in both parallel and serial modes)			
41	ENBA	Digital Input	Channel A enable pin
37	ENBB	Digital Input	Channel B enable pin: pin has three states: Low, Mid, High
36	ENBC	Digital Input	Channel C enable pin

Table 1. PIN FUNCTIONS (continued)

PIN NUMBER	SYMBOL	PIN CATEGORY	DESCRIPTION
32	ENBD	Digital Input	Channel D enable pin
Parallel Mode Digital Pins, MODE = Logic Low			
49, 48, 47, 46, 45	A0, A1, A2, A3, A4	Digital Input	Channel A attenuator control
54, 53, 52, 51, 50	B0, B1, B2, B3, B4	Digital Input	Channel B attenuator control
19, 20, 21, 22, 23	C0, C1, C2, C3, C4	Digital Input	Channel C attenuator control
24, 25, 26, 27, 28	D0, D1, D2, D3, D4	Digital Input	Channel D attenuator control
Serial Mode Digital Pins, MODE = Logic High			
SPI Compatible			
45	SDO	Digital Output-Open Collector	Serial Data Output (Requires external bias.)
46	SDI	Digital Input	Serial Data In
47	CSb	Digital Input	Chip Select
48	CLK	Digital Input	Clock

Table 2. PIN LIST

PIN	DESCRIPTION	PIN	DESCRIPTION
1	GND	28	D4
2	INA+	29	OUTD-
3	INA-	30	OUTD+
4	GND	31	+5VD
5	MODE	32	ENBD
6	GND	33	+5VC
7	INB+	34	OUTC-
8	INB-	35	OUTC+
9	GND	36	ENBC
10	GND	37	ENBB
11	INC+	38	OUTB-
12	INC-	39	OUTB+
13	GND	40	+5VB
14	GND	41	ENBA
15	GND	42	+5VA
16	IND+	43	OUTA-
17	IND-	44	OUTA+
18	GND	45	A4 / SDO
19	C0	46	A3 / SDI
20	C1	47	A2 / CSb
21	C2	48	A1 / CLK
22	C3	49	A0
23	C4	50	B4
24	D0	51	B3
25	D1	52	B2
26	D2	53	B1
27	D3	54	B0

TYPICAL CHARACTERISTICS

($T_A = 25^\circ\text{C}$, $V_+ = 5\text{V}$, $R_L = 200\Omega$, Maximum Gain, High Power, $f = 200\text{MHz}$; LMH6523 soldered onto LMH6523EVAL evaluation board, Unless Specified).

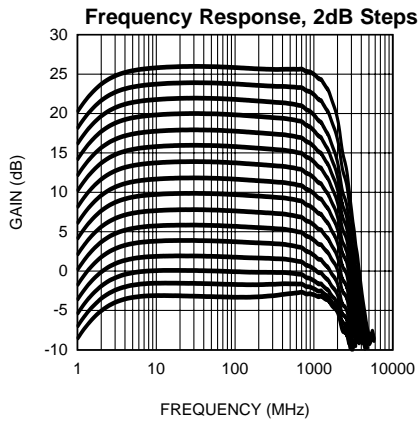

Figure 2.

SVA-30206540

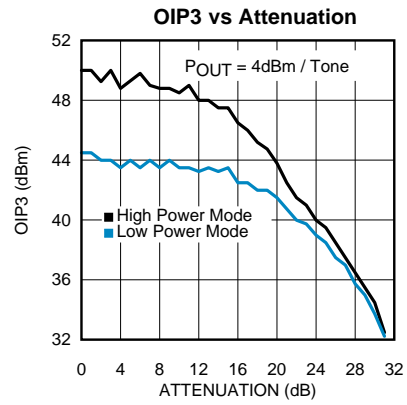

Figure 3.

SVA-30206553

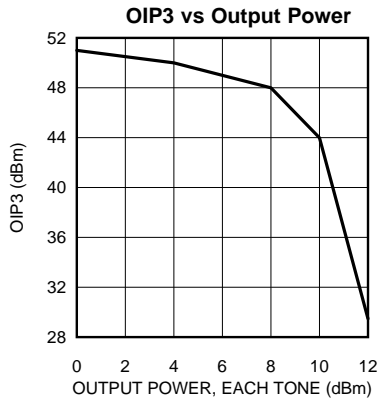

Figure 4.

SVA-30206561

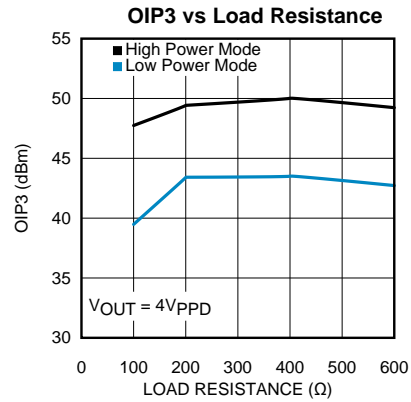

Figure 5.

SVA-30206565

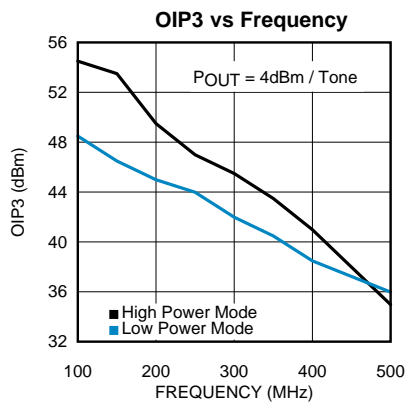

Figure 6.

SVA-30206556

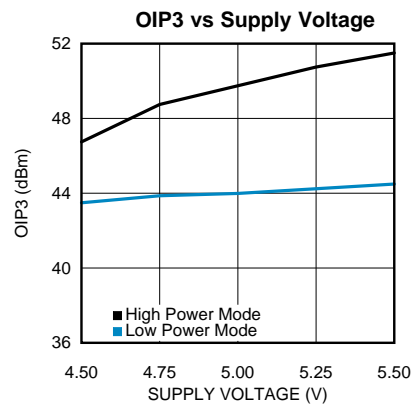

Figure 7.

SVA-30206555

TYPICAL CHARACTERISTICS (continued)

($T_A = 25^\circ\text{C}$, $V_+ = 5\text{V}$, $R_L = 200\Omega$, Maximum Gain, High Power, $f = 200\text{MHz}$; LMH6523 soldered onto LMH6523EVAL evaluation board, Unless Specified).

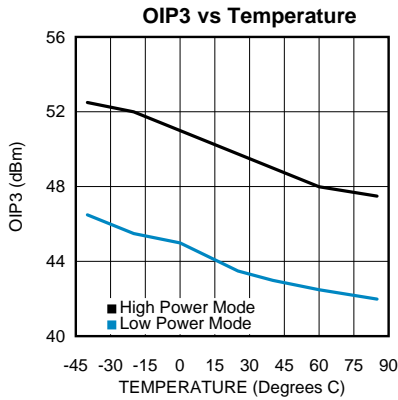

Figure 8.

SVA-30206573

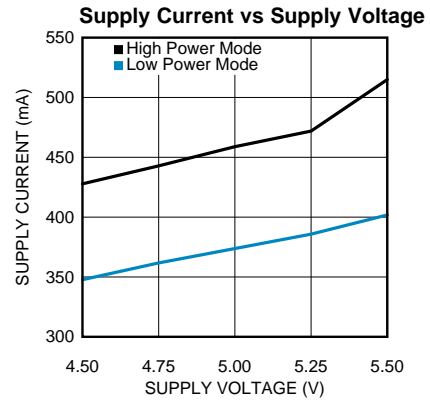

Figure 9.

SVA-30206554

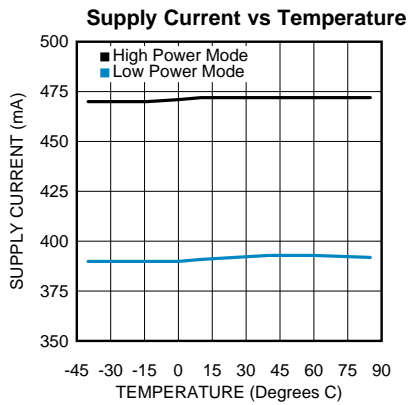

Figure 10.

SVA-30206558

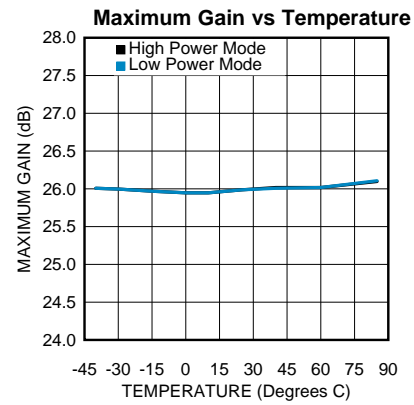

Figure 11.

SVA-30206559

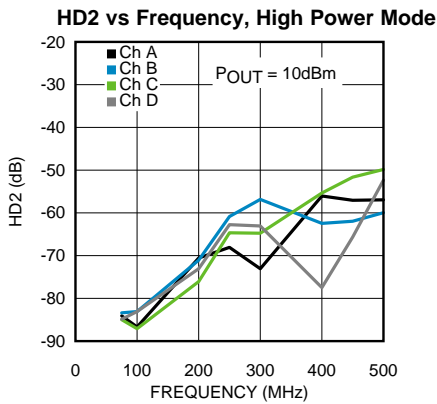

Figure 12.

SVA-30206524

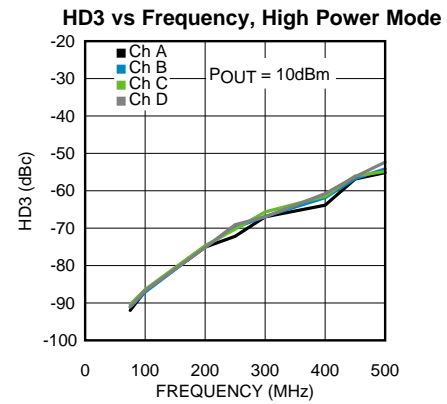

Figure 13.

SVA-30206525

TYPICAL CHARACTERISTICS (continued)

($T_A = 25^\circ\text{C}$, $V_+ = 5\text{V}$, $R_L = 200\Omega$, Maximum Gain, High Power, $f = 200\text{MHz}$; LMH6523 soldered onto LMH6523EVAL evaluation board, Unless Specified).

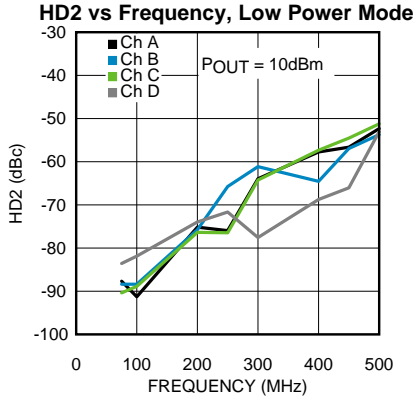

Figure 14.

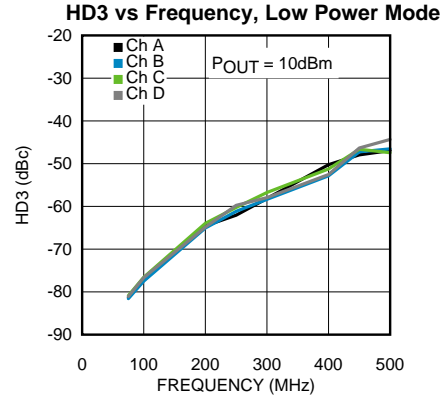

Figure 15.

SVA-30206527

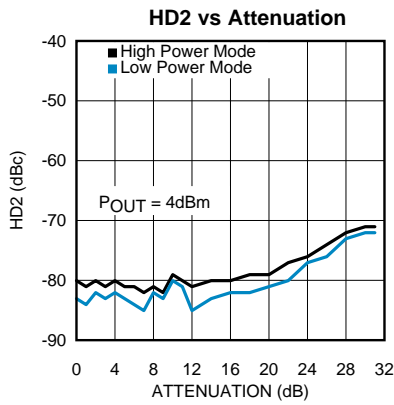

Figure 16.

SVA-30206563

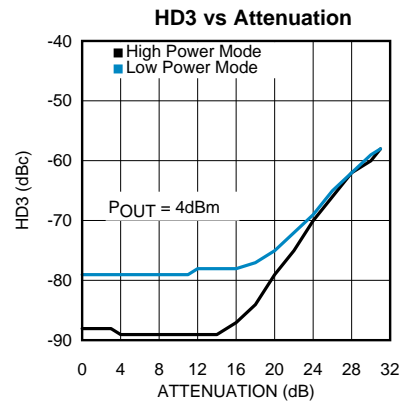

Figure 17.

SVA-30206564

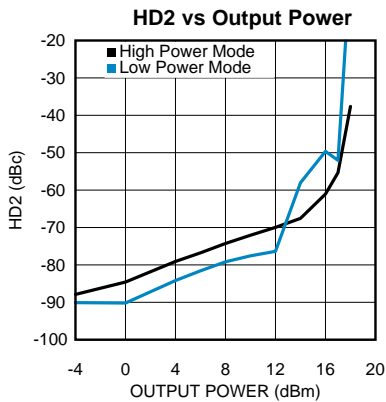

Figure 18.

SVA-30206520

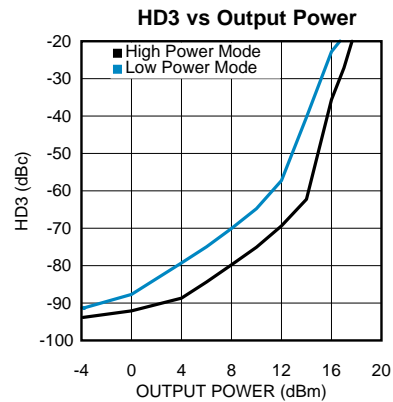

Figure 19.

SVA-30206521

TYPICAL CHARACTERISTICS (continued)

($T_A = 25^\circ\text{C}$, $V_+ = 5\text{V}$, $R_L = 200\Omega$, Maximum Gain, High Power, $f = 200\text{MHz}$; LMH6523 soldered onto LMH6523EVAL evaluation board, Unless Specified).

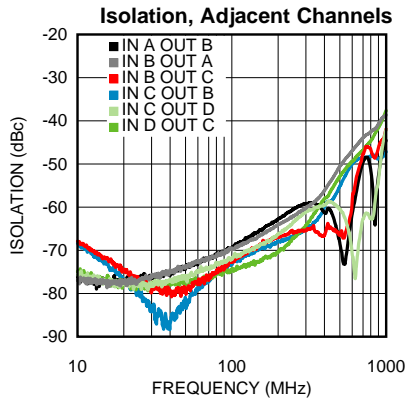

Figure 20.

SVA-30206571

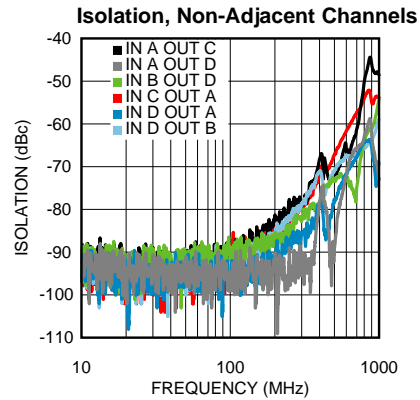

Figure 21.

SVA-30206572

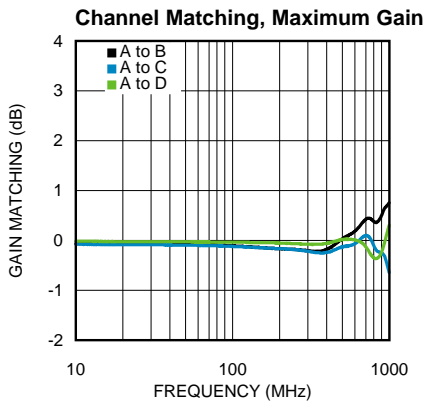

Figure 22.

SVA-30206574

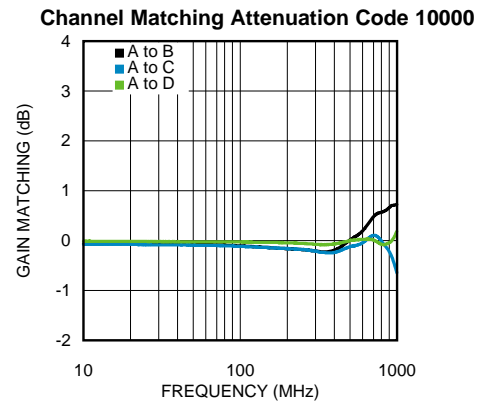

Figure 23.

SVA-30206535

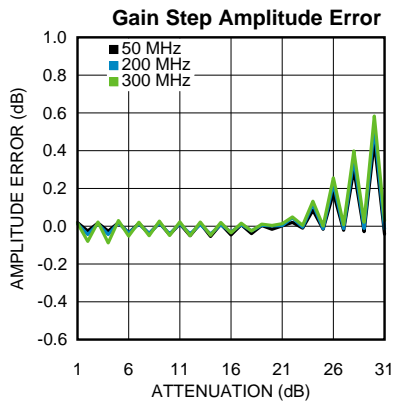

Figure 24.

SVA-30206536

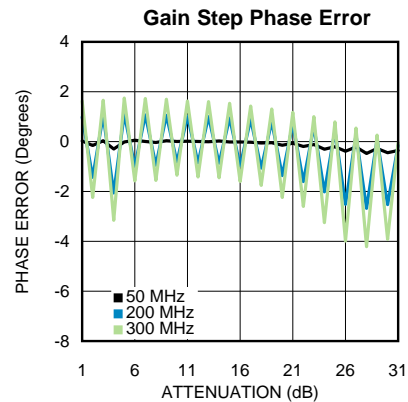

Figure 25.

SVA-30206539

TYPICAL CHARACTERISTICS (continued)

($T_A = 25^\circ\text{C}$, $V_+ = 5\text{V}$, $R_L = 200\Omega$, Maximum Gain, High Power, $f = 200\text{MHz}$; LMH6523 soldered onto LMH6523EVAL evaluation board, Unless Specified).

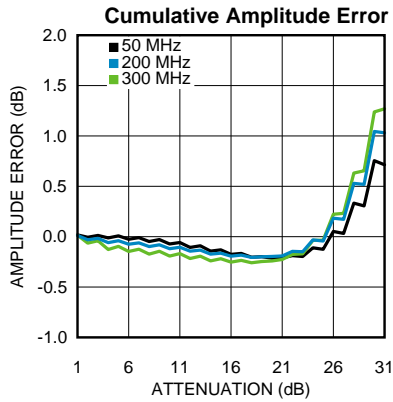

Figure 26.

SVA-30206537

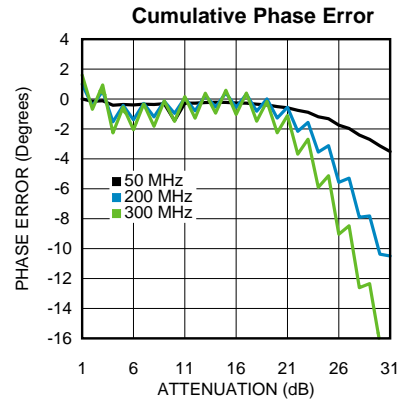

Figure 27.

SVA-30206538

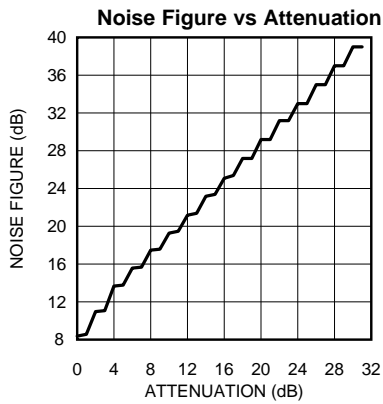

Figure 28.

SVA-30206550

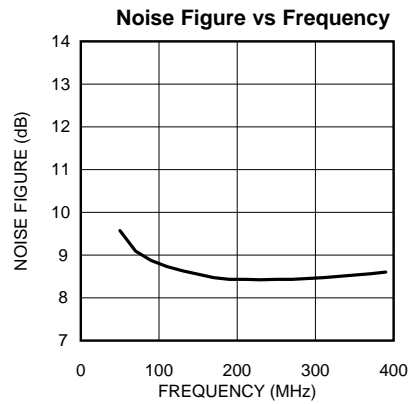

Figure 29.

SVA-30206551

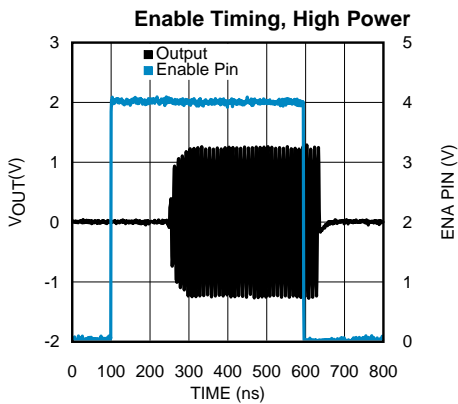

Figure 30.

SVA-30206548

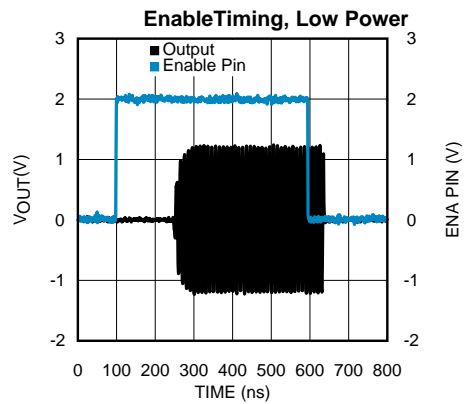

Figure 31.

SVA-30206549

TYPICAL CHARACTERISTICS (continued)

($T_A = 25^\circ\text{C}$, $V_+ = 5\text{V}$, $R_L = 200\Omega$, Maximum Gain, High Power, $f = 200\text{MHz}$; LMH6523 soldered onto LMH6523EVAL evaluation board, Unless Specified).

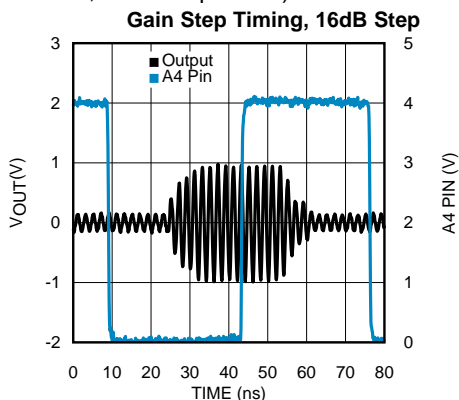

Figure 32.

SVA-30206542

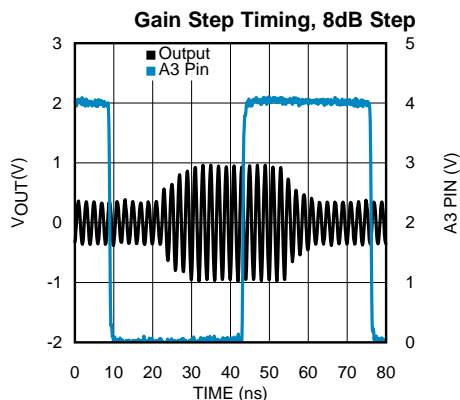

Figure 33.

SVA-30206543

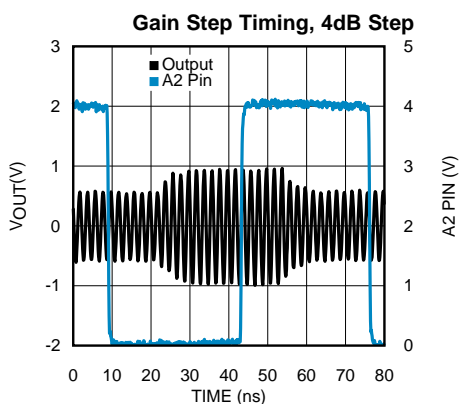

Figure 34.

SVA-30206544

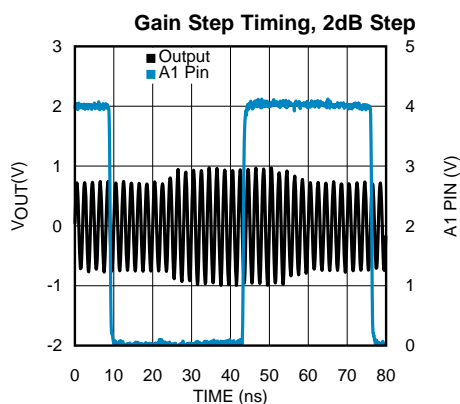

Figure 35.

SVA-30206545

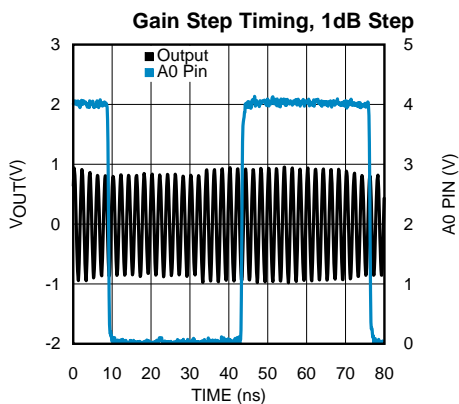

Figure 36.

SVA-30206546

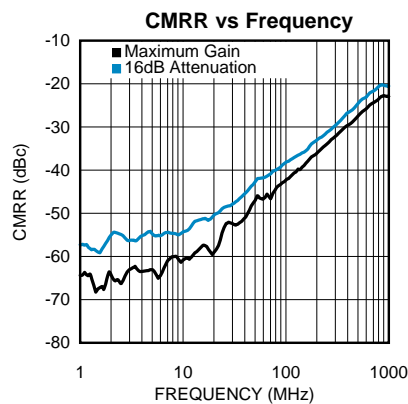

Figure 37.

SVA-30206541

TYPICAL CHARACTERISTICS (continued)

($T_A = 25^\circ\text{C}$, $V_+ = 5\text{V}$, $R_L = 200\Omega$, Maximum Gain, High Power, $f = 200\text{MHz}$; LMH6523 soldered onto LMH6523EVAL evaluation board, Unless Specified).

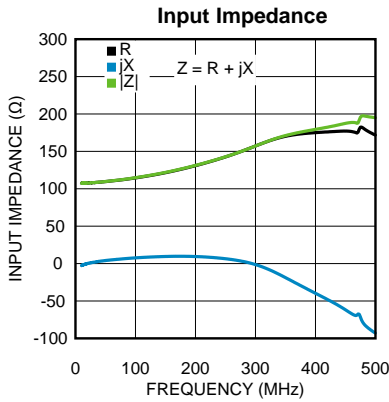

Figure 38.

SVA-30206575

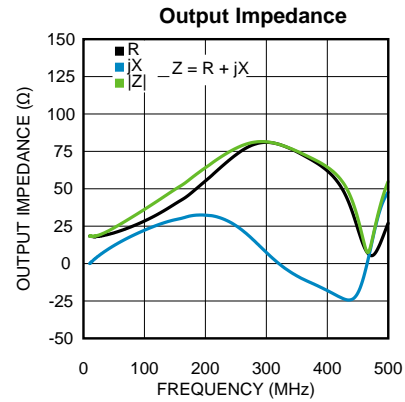

Figure 39.

SVA-30206576

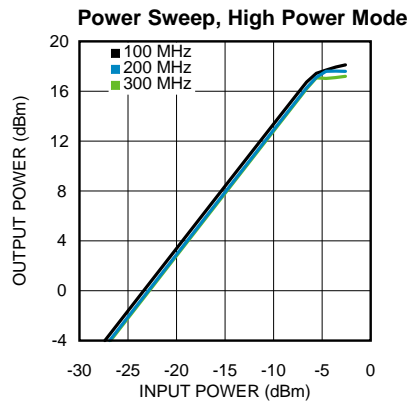

Figure 40.

SVA-30206585

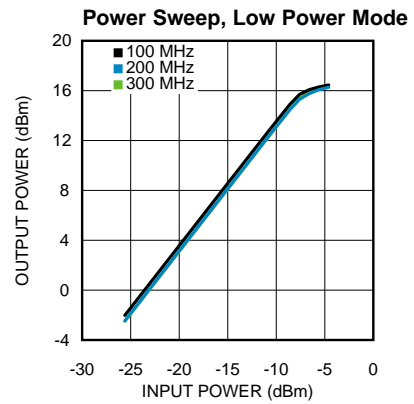

Figure 41.

SVA-30206586

APPLICATION INFORMATION

INTRODUCTION

The LMH6523 is a fully differential amplifier optimized for signal path applications up to 400 MHz. The LMH6523 has a 100Ω input and a low impedance output. The gain is digitally controlled over a 31 dB range from +26dB to -5dB. The LMH6523 is optimized for accurate gain steps and minimal phase shift combined with low distortion products. This makes the LMH6523 ideal for voltage amplification and an ideal analog to digital converter (ADC) driver where high linearity is necessary.

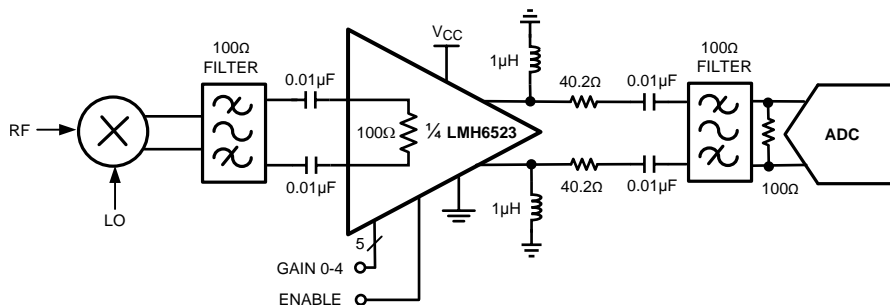

SVA-30206534

Figure 42. LMH6523 Typical Application

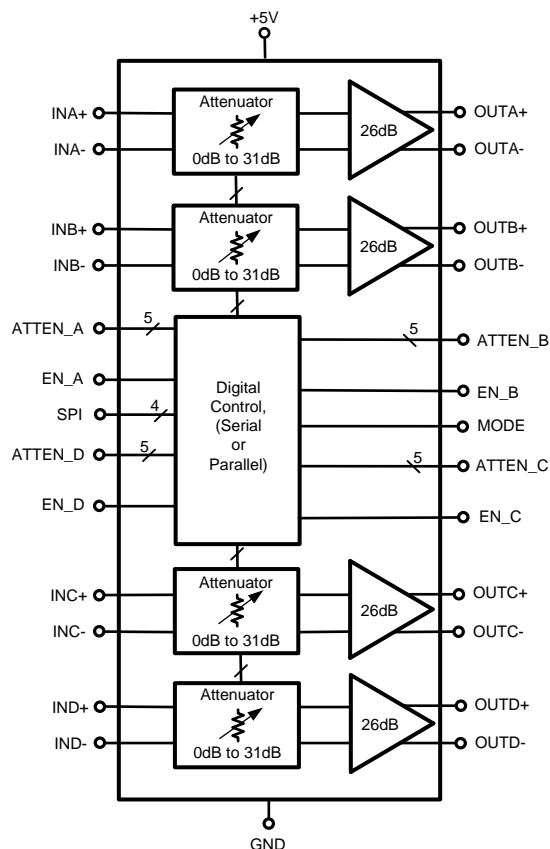

SVA-30206532

Figure 43. LMH6523 Block Diagram

BASIC CONNECTIONS

A voltage between 4.75 V and 5.25 V should be applied to the supply pin labeled +5V. Each supply pin should be decoupled with a low inductance, surface-mount ceramic capacitor of 0.01 μ F as close to the device as possible. Additional bypass capacitors of 0.1 μ F and 1nF are optional, but would provide bypassing over a wider frequency range.

The outputs of the LMH6523 need to be biased to ground using inductors and output coupling capacitors of 0.01 μ F are recommended. The input pins are self biased to 2.5V and should be ac-coupled with 0.01 μ F capacitors as well. The output bias inductors and ac-coupling capacitors are the main limitations for operating at low frequencies. Larger values of inductance on the bias inductors and larger values of capacitance on the coupling capacitors will give more low frequency range. Using bias inductors over 1 μ H, however, may compromise high frequency response due to unwanted parasitic loading on the amplifier output pins.

Each channel of the LMH6523 consists of a digital step attenuator followed by a low distortion 26 dB fixed gain amplifier and a low impedance output stage. The attenuation is digitally controlled over a 31 dB range from 0dB to 31dB. The LMH6523 has a 100 Ω differential input impedance and a low, 20 Ω , output impedance.

Each channel of the LMH6523 has an enable pin. Grounding the enable pin will put the channel in a power saving shutdown mode. Additionally, there are two “on” states which gives the option of two power modes. High Power Mode is selected by biasing the enable pins at 2.0 V or higher. The LMH6523 enable pins will self bias to the Low Power State, alternatively supplying a voltage between 0.6V and 1.8V will place the channel in Low Power Mode. If connected to a TRI-STATE buffer the LMH6523 enable pins will be in shutdown for a logic 0 output, in High Power Mode for a logic 1 state and they will self bias to Low Power Mode for the high impedance state.

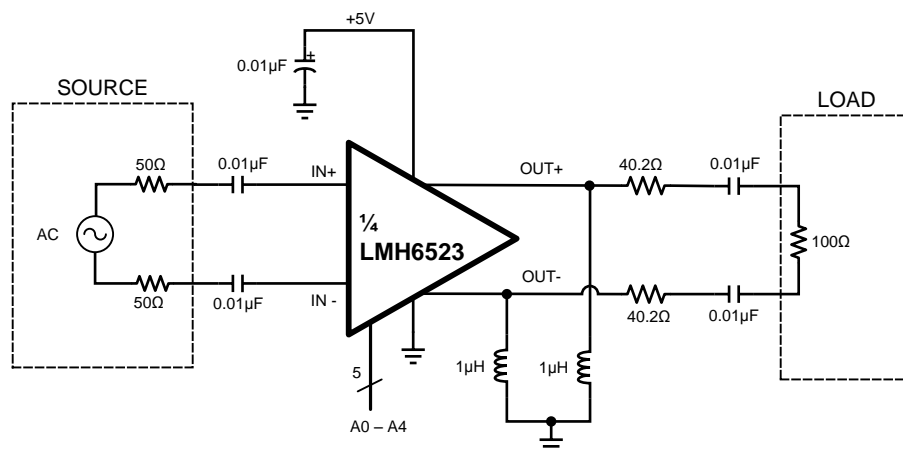

SVA-30206501

Figure 44. LMH6523 Basic Connections Schematic

INPUT CHARACTERISTICS

The LMH6523 input impedance is set by internal resistors to a nominal 100 Ω . Process variations will result in a range of values. At higher frequencies parasitic reactances will start to impact the impedance. This characteristic will also depend on board layout and should be verified on the customer’s system board.

At maximum gain the digital attenuator is set to 0 dB and the input signal will be much smaller than the output. At minimum gain the output is 5 dB or more smaller than the input. In this configuration the input signal will begin to clip against the ESD protection diodes before the output reaches maximum swing limits. The input signal cannot swing more than 0.5V below the negative supply voltage (normally 0V) nor should it exceed the positive supply voltage. The input signal will clip and cause severe distortion if it is too large. Because the input stage self biases to approximately mid rail the supply voltage will impose the limit for input voltage swing.

At higher frequencies the LMH6523 input impedance is not purely resistive. In [Figure 45](#) a circuit is shown that matches the amplifier input impedance with a source that is 100 Ω . This would be the case when connecting the LMH6523 directly to a mixer. For an easy way to calculate the L and C circuit values there are several options for online tools or down-loadable programs. The following tool might be helpful.

Excel can also be used for simple circuits; however, the “Analysis ToolPak” add-in must be installed to calculate complex numbers.

<http://www.circuitsage.com/matching/matcher2.html>

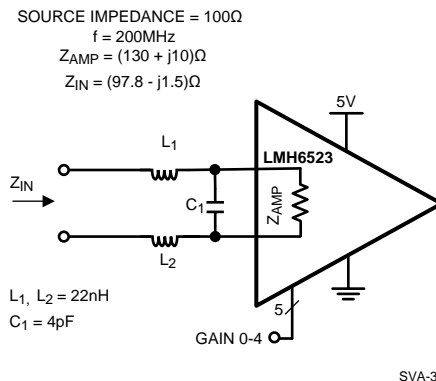

Figure 45. Differential LC Conversion Circuit

OUTPUT CHARACTERISTICS

The LMH6523 has a low impedance output very similar to a traditional Op-amp output. This means that a wide range of loads can be driven with good performance. Matching load impedance for proper termination of filters is as easy as inserting the proper value of resistor between the filter and the amplifier. This flexibility makes system design and gain calculations very easy.

By using a differential output stage the LMH6523 can achieve very large voltage swings on a single 5V supply. This is illustrated in Figure 46. This figure shows how a voltage swing of $5V_{PPD}$ is realized while only swinging $2.5V_{PP}$ on each output. The LMH6523 can swing up to $10V_{PPD}$ which is sufficient to drive most ADCs to full scale while using a matched impedance anti alias filter between the amplifier and the ADC. The LMH6523 has been designed for AC coupled applications and has been optimized for operation above 5 MHz.

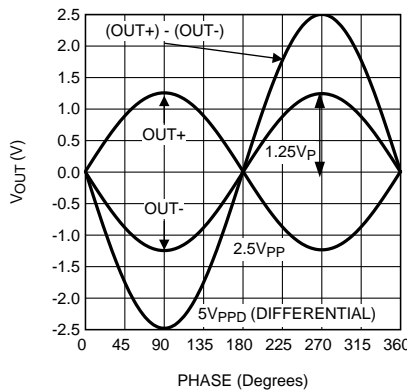

Figure 46. Differential Output Voltage

Like most closed loop amplifiers the LMH6523 output stage can be sensitive to capacitive loading. To help with board layout and to help minimize sensitivity to bias inductor capacitance the LMH5522 output lines have internal 10Ω resistors. These resistors should be taken into account when choosing matching resistor values. This is shown in as using 40.2Ω resistors instead of 50Ω resistors to match the 100Ω differential load. Best practise is to place the external termination resistors as close to the DVGA output pins as possible. Due to reactive components between the DVGA output and the filter input it may be desirable to use even smaller value resistors than a simple calculation would indicate. For instance, at 200 MHz resistors of 30Ω provide slightly better OIP3 performance on the LMH6523EVAL evaluation board and may also provide a better match to the filter input.

The LMH6523 output pins require a DC path to ground. On the evaluation board, inductors are installed to provide proper output biasing. The bias current is approximately 36mA per output pin. The resistance of the output bias inductors will raise the output common mode slightly. An inductor with low resistance will keep the output bias voltage close to zero, so the DC resistance of the inductor chosen will be important. It is also important to make sure that the inductor can handle the 36mA of bias current.

In addition to the DC current in the inductor there will be some AC current as well. With large inductors and high operating frequencies the inductor will present a very high impedance and will have minimal AC current. If the inductor is chosen to have a smaller value, or if the operating frequency is very low there could be enough AC current flowing in the inductor to become significant. The total current should not exceed the inductor current rating.

Another reason to choose low resistance bias inductors is that due to the nature of the LMH6523 output stage, the output offset voltage is determined by the output bias components. The output stage has an offset current that is typically 3mA and this offset current, multiplied by the resistance of the output bias inductors will determine the output offset voltage.

The ability of the LMH6523 to drive low impedance loads while maintaining excellent OIP3 performance creates an opportunity to greatly increase power gain and drive low impedance filters. Figure 47 shows the OIP3 performance of the LMH6523 over a range of filter impedances. Also on the same graph is the power gain realized by changing load impedance. The power gain reflects the 6dB of loss caused by the termination resistors necessary to match the amplifier output impedance to the filter characteristic impedance. The graph shows the ability of the LMH6523 to drive a constant voltage to an ADC input through various filter impedances with very little change in OIP3 performance. This gives the system designer much needed flexibility in filter design.

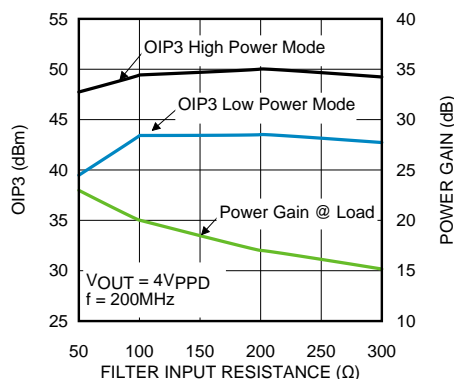

SVA-30206579

Figure 47. OIP3 and Power Gain vs Filter Impedance
OIP3 and Gain Measured at Amplifier Output, Filter Back Terminated

Printed circuit board (PCB) design is critical to high frequency performance. In order to ensure output stability the load matching resistors should be placed as close to the amplifier output pins as possible. This allows the matching resistors to mask the board parasitics from the amplifier output circuit. An example of this is shown in Figure 48. If the Filter is a bandpass filter with no DC path the 0.01μF coupling capacitors can be eliminated. The LMH6523EVAL evaluation board is available to serve a guide for system board layout.

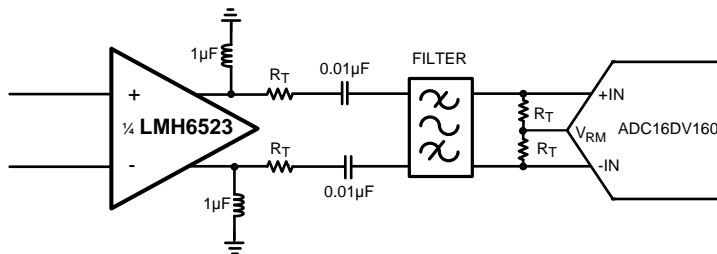

SVA-30206568

Figure 48. Output Configuration

CASCADE OPERATION

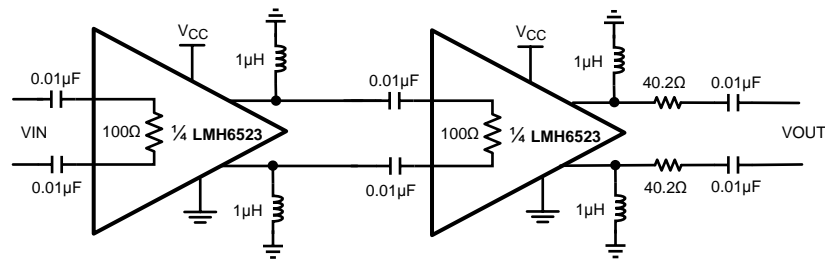

SVA-30206583

Figure 49. Schematic for Cascaded Amplifiers

With four amplifiers in one package the LMH6523 is ideally configured for cascaded operation. By using two amplifiers in series additional gain range can be achieved. The schematic in Figure 49 shows one way to connect two stages of the LMH6523. The resultant frequency response is shown below in Figure 50. When using the LMH6523 amplifiers in a cascade configuration it is important to keep the signal level within reasonable limits at all nodes of the signal path. With over 40dB of total gain it is possible to amplify signals to clipping levels if the gain is not set correctly.

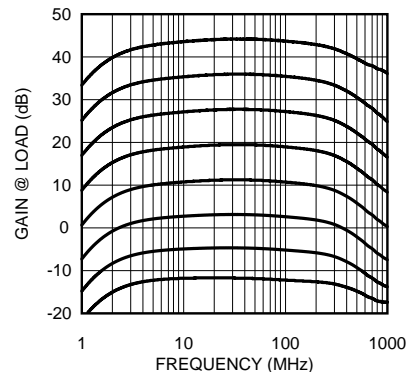

SVA-30206584

Figure 50. Frequency Response of Cascaded Amplifiers

DIGITAL CONTROL

The LMH6523 will support two modes of control, parallel mode and serial mode (SPI compatible). Parallel mode is fastest and requires the most board space for logic line routing. Serial mode is compatible with existing SPI compatible systems.

The LMH6523 has gain settings covering a range of 31 dB. To avoid undesirable signal transients the LMH6523 should not be powered on with large inputs signals present. Careful planning of system power on sequencing is especially important to avoid damage to ADC inputs.

The LMH6523 was designed to interface with 2.5V to 5V CMOS logic circuits. If operation with 5V logic is required care should be taken to avoid signal transients exceeding the DVGA supply voltage. Long, unterminated digital signal traces are particularly susceptible to these transients. Signal voltages on the logic pins that exceed the device power supply voltage may trigger ESD protection circuits and cause unreliable operation.

Some pins on the LMH6523 have different functions depending on the digital control mode. These functions will be described in the sections to follow.

Table 3. Pins with Dual Functions

PIN	MODE = 0	MODE = 1
45	A4	SDO ⁽¹⁾
46	A3	SDI
47	A2	CSb
48	A1	CLK

(1) Pin 45 requires external bias. See Serial Mode Section for Details.

PARALLEL INTERFACE

Parallel mode offers the fastest gain update capability with the drawback of requiring the most board space dedicated to control lines. When designing a system that requires very fast gain changes parallel mode is the best selection. To place the LMH6523 into parallel mode the MODE pin (pin 5) is set to the logical zero state. Alternately the MODE pin can be connected directly to ground.

The attenuator control pins are internally biased to logic high state with weak pull up resistors. The MODE pin has a weak internal resistor to ground.

The LMH6523 has a 5-bit gain control bus. Data from the gain control pins is immediately sent to the gain circuit (i.e., gain is changed immediately). To minimize gain change glitches all gain pins should change at the same time. In order to achieve the very fast gain step switching time the internal gain change circuit is very fast. Gain glitches could result from timing skew between the gain set bits. This is especially the case when a small gain change requires a change in state of three or more gain control pins. If necessary the DVGA could be put into a disabled state while the gain pins are reconfigured and then brought active when they have settled.

ENA , ENB, ENC and END pins are provided to reduce power consumption by disabling the highest power portions of the LMH6523. The gain register will preserve the last active gain setting during the disabled state. These pins have three logic states and will float to the middle or low power, enabled state if left floating. When grounded the EN pins will disable the associated channel and when biased to the highest logic level the associated channel will be in the high power, enabled state. See the Typical Performance section for disable and enable timing information.

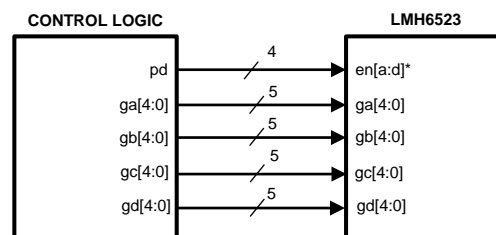

*Enable pins are tri state buffer compatible.

SVA-30206517

Figure 51. Parallel Mode Connection

SPI COMPATIBLE SERIAL INTERFACE

Serial interface allows a great deal of flexibility in gain programming and reduced board complexity. Using only 4 wires for both channels allows for significant board space savings. The trade off for this reduced board complexity is slower response time in gain state changes. For systems where gain is changed only infrequently or where only slow gain changes are required serial mode is the best choice. To place the LMH6523 into serial mode the MODE pin (Pin 5) should be put into the logic high state. Alternatively the MODE pin can be connected directly to the 5V supply bus.

The LMH6523 serial interface is a generic 4-wire synchronous interface that is compatible with SPI type interfaces that are used on many microcontrollers and DSP controllers. The serial mode is active when the mode pin is set to a logic 1 state. In this configuration the pins function as shown in the pin description table. The SPI interface uses the following signals: clock input (CLK), serial data in (SDI), serial data out, and serial chip select (CSb). The chip select pin is active low.

The enable pins are active in the serial mode to allow rapid power control. This can allow significant power savings in applications like time division duplex receivers. It is not possible to disable the amplifiers using the SPI bus, likewise the power control is not available on the SPI bus.

The CLK pin is the serial clock pin. It is used to register the input data that is presented on the SDI pin on the rising edge; and to source the output data on the SDO pin on the falling edge. User may disable clock and hold it in the low state, as long as the clock pulse-width minimum specification is not violated when the clock is enabled or disabled.

The CSb pin is the chip select pin. The b indicates that this pin is actually a “NOT chip select” since the chip is selected in the logic low state. Each assertion starts a new register access – i.e., the SDATA field protocol is required. The user is required to deassert this signal after the 16th clock. If the CSb pin is deasserted before the 16th clock, no address or data write will occur. The rising edge captures the address just shifted-in and, in the case of a write operation, writes the addressed register. There is a minimum pulse-width requirement for the deasserted pulse – which is specified in the Electrical Specifications section.

The SDI pin is the input pin for the serial data. It must observe setup / hold requirements with respect to the SCLK. Each cycle is 16-bits long.

The SDO pin is the data output pin. This output is normally at a high impedance state, and is driven only when CSb is asserted. Upon CSb assertion, contents of the register addressed during the first byte are shifted out with the second 8 SCLK falling edges. Upon power-up, the default register address is 00h. The SDO pin requires external bias for clock speeds over 1MHz. See Figure 53 for details on sizing the external bias resistor. Because the SDO pin is a high impedance pin, the board capacitance present at the pin will restrict data out speed that can be achieved. For a RC limited circuit the frequency is $\sim 1 / (2 \times P_i \times RC)$. As shown in the figure resistor values of 300 to 2000 Ohms are recommended.

Each serial interface access cycle is exactly 16 bits long as shown in Figure 52. Each signal's function is described below. the read timing is shown in Figure 54, while the write timing is shown in Figure 55.

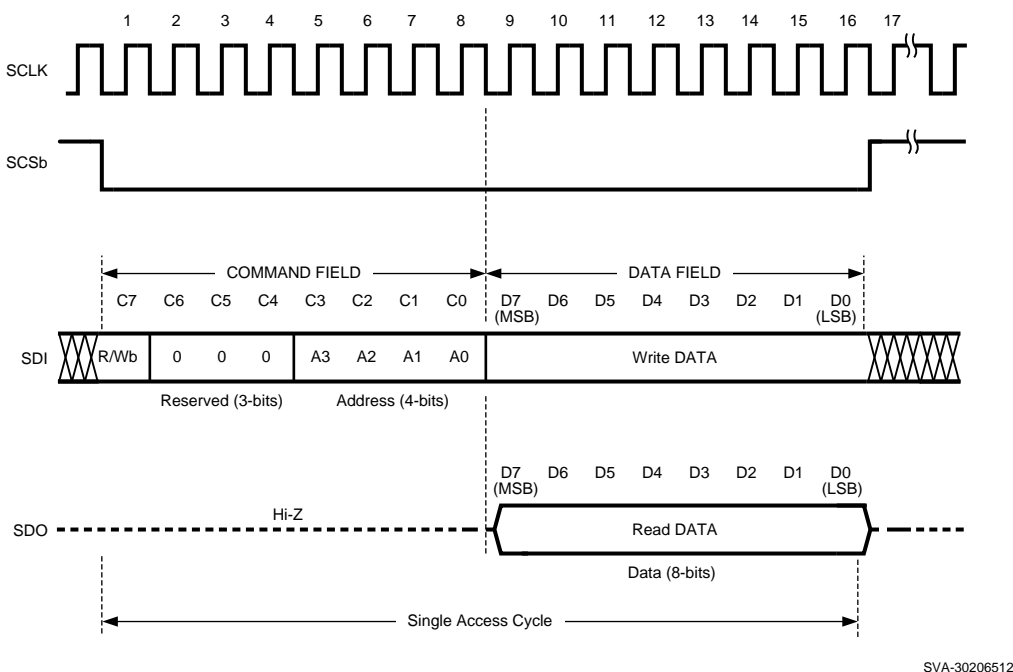
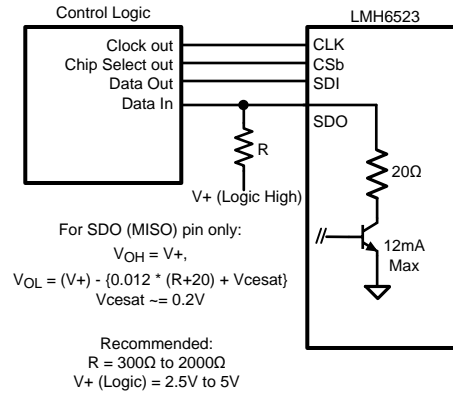

Figure 52. Serial Interface Protocol (SPI compatible)



SVA-30206514

Figure 53. Internal Operation of the SDO pin

R/Wb	Read / Write bit. A value of 1 indicates a read operation, while a value of 0 indicates a write operation.
Reserved	Not used. Must be set to 0.
ADDR:	Address of register to be read or written.
DATA	In a write operation the value of this field will be written to the addressed register when the chip select pin is deasserted. In a read operation this field is ignored.

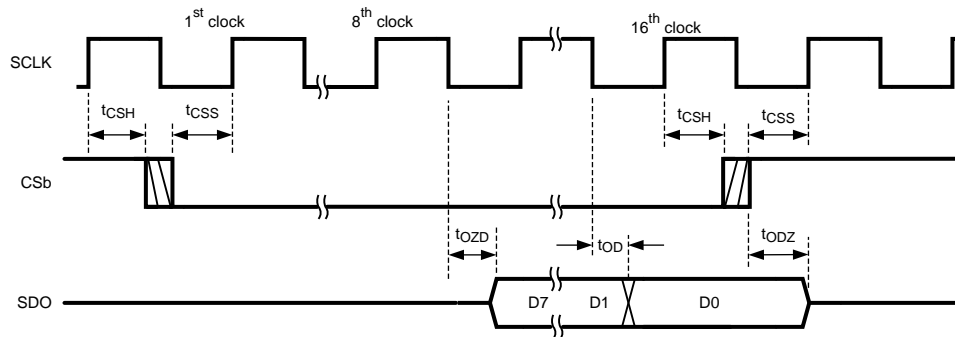

SVA-30206511

Figure 54. Read Timing

Table 4. Read Timing Data Output on SDO Pin

PARAMETER	DESCRIPTION
t _{CSH}	Chip select hold time
t _{CSS}	Chip select setup time
t _{ODZ}	Initial output data delay
t _{ODZ}	High impedance delay
t _{OD}	Output data delay

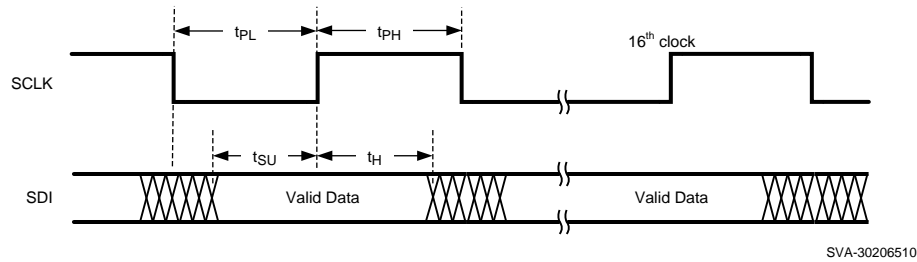

Figure 55. Write Timing – Data Written to SDI Pin

Table 5. Write Timing Data Input on SDI Pin

PARAMETER	DESCRIPTION
t_{PL}	Minimum clock low time (clock duty cycle)
t_{PH}	Minimum clock high time (clock duty cycle)
t_{SU}	Input data setup time
t_H	Input data hold time

Table 6. Serial Word Format for LMH6523

C7	C6	C5	C4	C3	C2	C1	C0
1= read 0=write	0	0	0	0	000= CHA 001=CHB 010=CHC 011=CHD 100=Fast Adjust		

Table 7. CH A through D Register Definition

7	6	5	4	3	2	1	0
Reserved, =0	Reserved	Reserved	Attenuation Setting: 00000 = Maximum Gain 11111 = Minimum Gain				

Table 8. Fast Adjust Register Definition

7	6	5	4	3	2	1	0
CH D		CH C		CH B		CH A	

Table 9. Fast Adjust Codes

CODE	ACTION
00	No Change
01	Decrease Attenuation by 1 Step (1dB)
10	Increase Attenuation by 1 Step (1dB)
11	Reserved, action undefined

THERMAL MANAGEMENT

The LMH6523 is packaged in a thermally enhanced package. The exposed pad is connected to the GND pins. It is recommended, but not necessary, that the exposed pad be connected to the supply ground plane. In any case, the thermal dissipation of the device is largely dependent on the attachment of this pad to the system printed circuit board (PCB). The exposed pad should be attached to as much copper on the PCB as possible, preferably external copper. However, it is also very important to maintain good high speed layout practices when designing a system board. Please refer to the LMH6522 evaluation board (available separately) for suggested layout techniques.

There is no evaluation board available for the LMH6523, however the LMH6522 is pin compatible, so the LMH6522 evaluation board should be used as a suggested layout design.

The LMH6522EVAL evaluation board was designed for both signal integrity and thermal dissipation. The LMH6522EVAL has eight layers of copper. The inner copper layers are two ounce copper and are as solid as design constraints allow. The exterior copper layers are one ounce copper in order to allow fine geometry etching. The benefit of this board design is significant. The JEDEC standard 4 layer test board gives a θ_{JA} of 23°C/W. The LMH6522EVAL eight layer board gives a measured θ_{JA} of 15°C/W (ambient temperature 25°C, no forced air). With the typical power dissipation of 2.3W this is a temperature difference of 18 degrees in junction temperature between the standard 4 layer board and the enhanced 8 layer evaluation board. In a system design the location and power dissipation of other heat sources may change the results observed compared with the LMH6522EVAL board.

Applying a heat sink to the package will also help to remove heat from the device. The ATS-54150K-C2-R0 heat sink, manufactured by Advanced Thermal Solutions, provided good results in lab testing. Using both a heat sink and a good board thermal design will provide the best cooling results. If a heat sink will not fit in the system design, the external case can be used as a heat sink.

Package information is available on the TI web site.

<http://www.ti.com/packaging/>

INTERFACING TO AN ADC

The LMH6523 was designed to be used with high speed ADCs such as the ADC16DV160. As shown in the [PERFORMANCE CURVE](#), AC coupling provides the best flexibility especially for IF sub-sampling applications.

The inputs of the LMH6523 will self bias to the optimum voltage for normal operation. The internal bias voltage for the inputs is approximately mid rail which is 2.5V with the typical 5V power supply condition. In most applications the LMH6523 input will need to be AC coupled.

The output pins require a DC path to ground that will carry the ~36 mA of bias current required to power the output transistors. The output common mode voltage should be established very near to ground. This means that using RF chokes or RF inductors is the easiest way to bias the LMH6523 output pins. Inductor values of 1 μ H to 400nH are recommended. High Q inductors will provide the best performance. If low frequency operation is desired, particular care must be given to the inductor selection because inductors that offer good performance at very low frequencies often have very low self resonant frequencies. If very broadband operation is desired the use of conical inductors such as the BCL-802JL from Coilcraft may be considered. These inductors offer very broadband response, at the expense of large physical size and a high DC resistance of 3.4 Ohms.

ADC Noise Filter

Below are schematics and a table of values for second order Butterworth response filters for some common IF frequencies. These filters, shown in [Figure 56](#), offer a good compromise between bandwidth, noise rejection and cost. This filter topology is the same as is used on the ADC14V155KDRB High IF Receiver reference design board. This filter topology works best with the 12, 14 and 16 bit analog to digital converters shown in the table.

Table 10. Filter Component Values⁽¹⁾

Center Frequency	75 MHz	150 MHz	180 MHz	250 MHz
Bandwidth	40 MHz	60 MHz	75 MHz	100 MHz
R1, R2	90 Ω	90 Ω	90 Ω	90 Ω
L1, L2	390 nH	370 nH	300 nH	225 nH
C1, C2	10 pF	3 pF	2.7 pF	1.9 pF
C3	22 pF	19 pF	15 pF	11 pF
L5	220 nH	62 nH	54 nH	36 nH
R3, R4	100 Ω	100 Ω	100 Ω	100 Ω

(1) Resistor values are approximate, but have been reduced due to the internal 10 Ω of output resistance per pin.

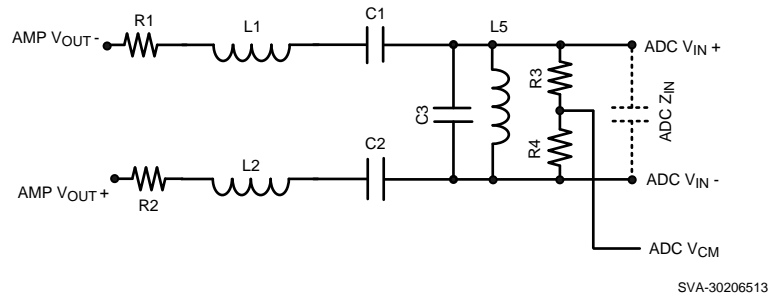

Figure 56. Sample Filter

POWER SUPPLIES

The LMH6523 was designed primarily to be operated on 5V power supplies. The voltage range for V+ is 4.75V to 5.25V. Power supply accuracy of 2.5% or better is advised. When operated on a board with high speed digital signals it is important to provide isolation between digital signal noise and the LMH6523 inputs. The SP16160CH1RB reference board provides an example of good board layout.

DYNAMIC POWER MANAGEMENT, USING LOW POWER MODE

The LMH6523 offers the option of a reduced power mode of operation referred to as Low Power Mode. In this mode of operation power consumption is reduced by approximately 20%. In many applications the linearity of the LMH6523 is fully adequate for most signal conditions. This would apply for a radio in a noise limited environment with no close-in blocker signals. During these conditions the LMH6523 can be operated in the low power mode. When a blocking signal is detected, or when system dynamic range needs to be increased, the LMH6523 can be rapidly switched from the Low Power Mode to the standard, High Power Mode.

The output response shown in Figure 57 is for a 2 MHz switching frequency pulse applied to the enable pin with a 50 MHz input signal. Analysis with a spectrum analyzer showed that the power mode switching spurs created by the switching signal were -80dBc with respect to the 50 MHz tone signal. This shows that rapid switching of power modes has virtually no impact on the signal quality.

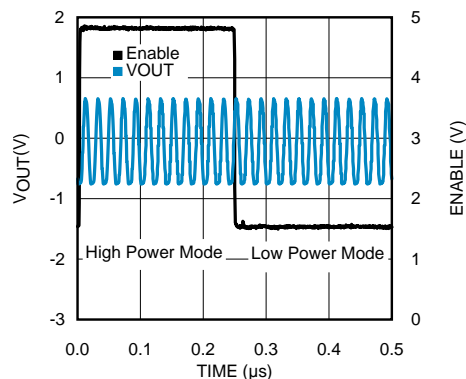

SVA-30206567

Figure 57. Signal Output During Mode Change from High Power Mode to Low Power Mode

COMPATIBLE HIGH SPEED ANALOG TO DIGITAL CONVERTERS

PRODUCT NUMBER	MAX SAMPLING RATE (MSPS)	RESOLUTION	CHANNELS
ADC12L063	62	12	SINGLE
ADC12DL065	65	12	DUAL
ADC12L066	66	12	SINGLE
ADC12DL066	66	12	DUAL
CLC5957	70	12	SINGLE
ADC12L080	80	12	SINGLE
ADC12DL080	80	12	DUAL
ADC12C080	80	12	SINGLE
ADC12C105	105	12	SINGLE
ADC12C170	170	12	SINGLE
ADC12V170	170	12	SINGLE
ADC14C080	80	14	SINGLE
ADC14C105	105	14	SINGLE
ADC14DS105	105	14	DUAL
ADC14155	155	14	SINGLE
ADC14V155	155	14	SINGLE
ADC16V130	130	16	SINGLE
ADC16DV160	160	16	DUAL
ADC08D500	500	8	DUAL
ADC08500	500	8	SINGLE
ADC08D1000	1000	8	DUAL
ADC081000	1000	8	SINGLE
ADC08D1500	1500	8	DUAL
ADC081500	1500	8	SINGLE
ADC08(B)3000	3000	8	SINGLE
ADC08L060	60	8	SINGLE
ADC08060	60	8	SINGLE
ADC10DL065	65	10	DUAL
ADC10065	65	10	SINGLE
ADC10080	80	10	SINGLE
ADC08100	100	8	SINGLE
ADCS9888	170	8	SINGLE
ADC08(B)200	200	8	SINGLE
ADC11C125	125	11	SINGLE
ADC11C170	170	11	SINGLE

PACKAGING INFORMATION

Orderable Device	Status (1)	Package Type	Package Drawing	Pins	Package Qty	Eco Plan (2)	Lead finish/ Ball material (6)	MSL Peak Temp (3)	Op Temp (°C)	Device Marking (4/5)	Samples
LMH6523SQ/NOPB	ACTIVE	WQFN	NJY	54	2000	RoHS & Green	SN	Level-2-260C-1 YEAR	-40 to 85	L6523	Samples
LMH6523SQE/NOPB	ACTIVE	WQFN	NJY	54	250	RoHS & Green	SN	Level-2-260C-1 YEAR	-40 to 85	L6523	Samples

(1) The marketing status values are defined as follows:

ACTIVE: Product device recommended for new designs.

LIFEBUY: TI has announced that the device will be discontinued, and a lifetime-buy period is in effect.

NRND: Not recommended for new designs. Device is in production to support existing customers, but TI does not recommend using this part in a new design.

PREVIEW: Device has been announced but is not in production. Samples may or may not be available.

OBSOLETE: TI has discontinued the production of the device.

(2) **RoHS:** TI defines "RoHS" to mean semiconductor products that are compliant with the current EU RoHS requirements for all 10 RoHS substances, including the requirement that RoHS substance do not exceed 0.1% by weight in homogeneous materials. Where designed to be soldered at high temperatures, "RoHS" products are suitable for use in specified lead-free processes. TI may reference these types of products as "Pb-Free".

RoHS Exempt: TI defines "RoHS Exempt" to mean products that contain lead but are compliant with EU RoHS pursuant to a specific EU RoHS exemption.

Green: TI defines "Green" to mean the content of Chlorine (Cl) and Bromine (Br) based flame retardants meet JS709B low halogen requirements of <=1000ppm threshold. Antimony trioxide based flame retardants must also meet the <=1000ppm threshold requirement.

(3) MSL, Peak Temp. - The Moisture Sensitivity Level rating according to the JEDEC industry standard classifications, and peak solder temperature.

(4) There may be additional marking, which relates to the logo, the lot trace code information, or the environmental category on the device.

(5) Multiple Device Markings will be inside parentheses. Only one Device Marking contained in parentheses and separated by a "~" will appear on a device. If a line is indented then it is a continuation of the previous line and the two combined represent the entire Device Marking for that device.

(6) Lead finish/Ball material - Orderable Devices may have multiple material finish options. Finish options are separated by a vertical ruled line. Lead finish/Ball material values may wrap to two lines if the finish value exceeds the maximum column width.

Important Information and Disclaimer:The information provided on this page represents TI's knowledge and belief as of the date that it is provided. TI bases its knowledge and belief on information provided by third parties, and makes no representation or warranty as to the accuracy of such information. Efforts are underway to better integrate information from third parties. TI has taken and continues to take reasonable steps to provide representative and accurate information but may not have conducted destructive testing or chemical analysis on incoming materials and chemicals. TI and TI suppliers consider certain information to be proprietary, and thus CAS numbers and other limited information may not be available for release.

In no event shall TI's liability arising out of such information exceed the total purchase price of the TI part(s) at issue in this document sold by TI to Customer on an annual basis.

TAPE AND REEL INFORMATION

QUADRANT ASSIGNMENTS FOR PIN 1 ORIENTATION IN TAPE



*All dimensions are nominal

Device	Package Type	Package Drawing	Pins	SPQ	Reel Diameter (mm)	Reel Width W1 (mm)	A0 (mm)	B0 (mm)	K0 (mm)	P1 (mm)	W (mm)	Pin1 Quadrant
LMH6523SQ/NOPB	WQFN	NJY	54	2000	330.0	16.4	5.8	10.3	1.0	12.0	16.0	Q1
LMH6523SQE/NOPB	WQFN	NJY	54	250	178.0	16.4	5.8	10.3	1.0	12.0	16.0	Q1

TAPE AND REEL BOX DIMENSIONS

*All dimensions are nominal

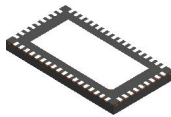
Device	Package Type	Package Drawing	Pins	SPQ	Length (mm)	Width (mm)	Height (mm)
LMH6523SQ/NOPB	WQFN	NJY	54	2000	356.0	356.0	36.0
LMH6523SQE/NOPB	WQFN	NJY	54	250	208.0	191.0	35.0



NJY0054A

WQFN

WQFN

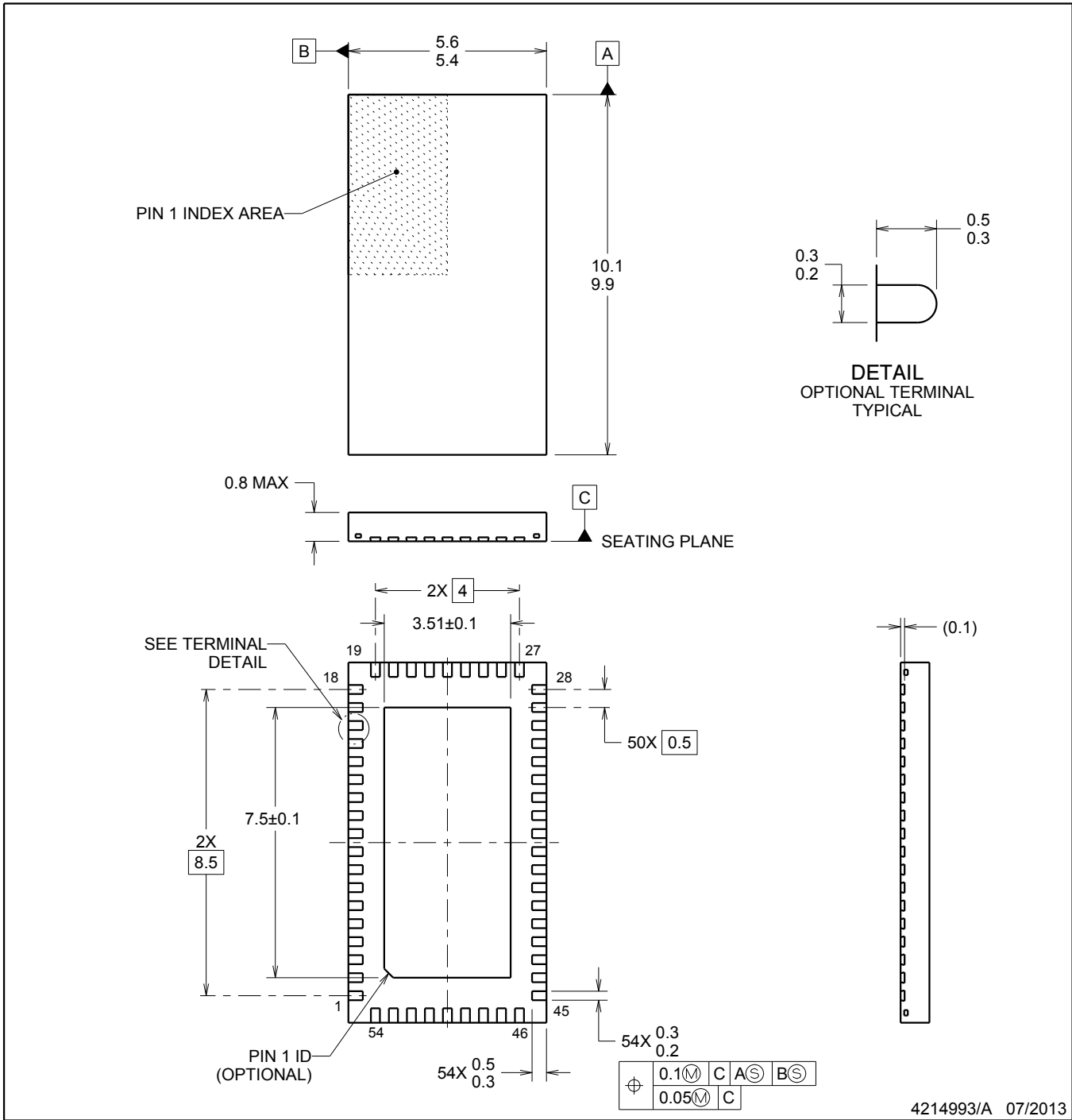

NOTES:

1. All linear dimensions are in millimeters. Dimensions in parenthesis are for reference only. Dimensioning and tolerancing per ASME Y14.5M.
2. This drawing is subject to change without notice.
3. The package thermal pad must be soldered to the printed circuit board for thermal and mechanical performance.

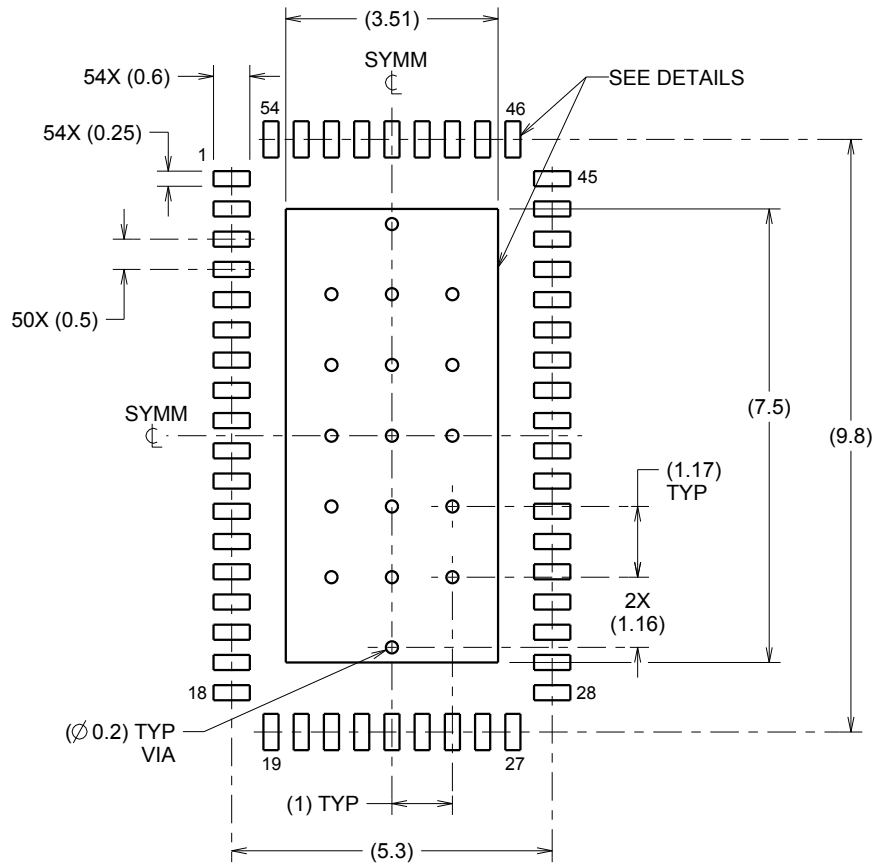

LAND PATTERN EXAMPLE
SCALE:8X

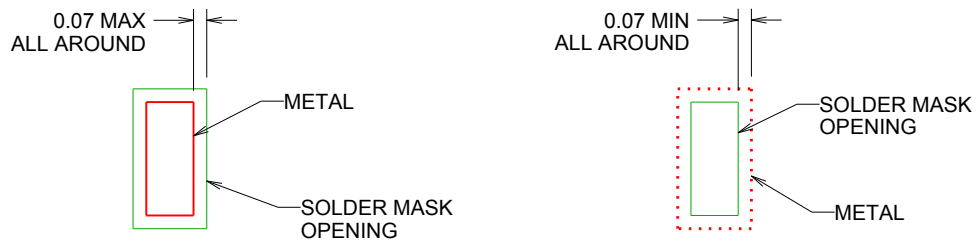

NON SOLDER MASK
DEFINED
(PREFERRED)

SOLDER MASK
DEFINED

SOLDER MASK DETAILS

4214993/A 07/2013

NOTES: (continued)

- This package is designed to be soldered to a thermal pad on the board. For more information, refer to QFN/SON PCB application note in literature No. SLUA271 (www.ti.com/lit/slua271).

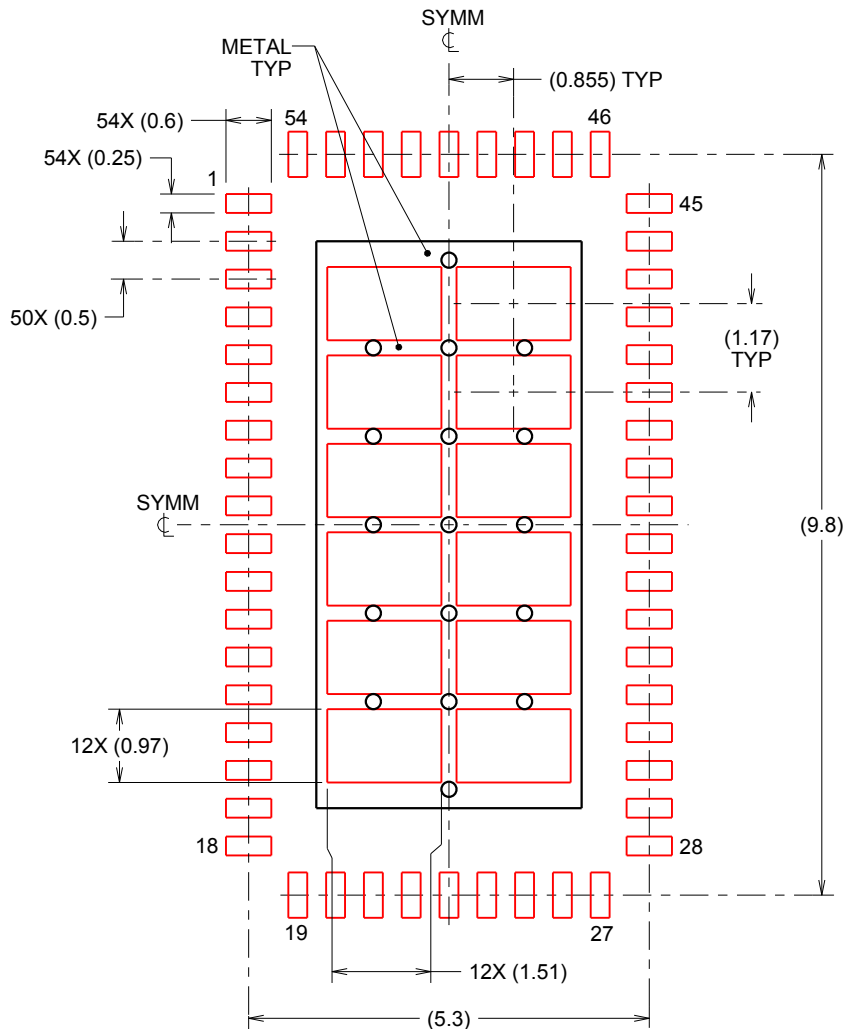

SOLDERPASTE EXAMPLE
 BASED ON 0.125mm THICK STENCIL

EXPOSED PAD
 67% PRINTED SOLDER COVERAGE BY AREA
 SCALE:10X

4214993/A 07/2013

NOTES: (continued)

- 5. Laser cutting apertures with trapezoidal walls and rounded corners may offer better paste release. IPC-7525 may have alternate design recommendations.

IMPORTANT NOTICE AND DISCLAIMER

TI PROVIDES TECHNICAL AND RELIABILITY DATA (INCLUDING DATA SHEETS), DESIGN RESOURCES (INCLUDING REFERENCE DESIGNS), APPLICATION OR OTHER DESIGN ADVICE, WEB TOOLS, SAFETY INFORMATION, AND OTHER RESOURCES "AS IS" AND WITH ALL FAULTS, AND DISCLAIMS ALL WARRANTIES, EXPRESS AND IMPLIED, INCLUDING WITHOUT LIMITATION ANY IMPLIED WARRANTIES OF MERCHANTABILITY, FITNESS FOR A PARTICULAR PURPOSE OR NON-INFRINGEMENT OF THIRD PARTY INTELLECTUAL PROPERTY RIGHTS.

These resources are intended for skilled developers designing with TI products. You are solely responsible for (1) selecting the appropriate TI products for your application, (2) designing, validating and testing your application, and (3) ensuring your application meets applicable standards, and any other safety, security, regulatory or other requirements.

These resources are subject to change without notice. TI grants you permission to use these resources only for development of an application that uses the TI products described in the resource. Other reproduction and display of these resources is prohibited. No license is granted to any other TI intellectual property right or to any third party intellectual property right. TI disclaims responsibility for, and you will fully indemnify TI and its representatives against, any claims, damages, costs, losses, and liabilities arising out of your use of these resources.

TI's products are provided subject to [TI's Terms of Sale](#) or other applicable terms available either on [ti.com](https://www.ti.com) or provided in conjunction with such TI products. TI's provision of these resources does not expand or otherwise alter TI's applicable warranties or warranty disclaimers for TI products.

TI objects to and rejects any additional or different terms you may have proposed.

Mailing Address: Texas Instruments, Post Office Box 655303, Dallas, Texas 75265
Copyright © 2024, Texas Instruments Incorporated