

LMZ14202 SIMPLE SWITCHER® 6V to 42V, 2A Power Module in Leaded SMT-TO Package

1 Features

- Integrated Shielded Inductor
- Simple PCB Layout
- Flexible Start-Up Sequencing Using External Soft-Start and Precision Enable
- Protection Against Inrush Currents and Faults Such as Input UVLO and Output Short Circuit
- Junction Temperature Range: -40°C to 125°C
- Single Exposed Pad and Standard Pinout for Easy Mounting and Manufacturing
- Fast Transient Response for Powering FPGAs and ASICs
- Low Output Voltage Ripple
- Pin-to-Pin Compatible Family:
 - LMZ14203/2/1 (42 V Maximum; 3 A, 2 A, 1 A)
 - LMZ12003/2/1 (20 V Maximum; 3 A, 2 A, 1 A)
- Fully Enabled for WEBENCH® Power Designer
- Electrical Specifications
 - 12-W Maximum Total Output Power
 - Up to 2-A Output Current
 - Input Voltage Range: 6 V to 42 V
 - Output Voltage Range: 0.8 V to 6 V
 - Efficiency up to 90%
- Performance Benefits
 - Operates at High Ambient Temperature With No Thermal Derating
 - High Efficiency Reduces System Heat Generation
 - Low Radiated Emissions (EMI) Tested With EN5022 Class B Standard
 - Low External Component Count

2 Applications

- Point of Load Conversions from 12-V and 24-V Input Rail
- Time-Critical Projects
- Space Constrained and High Thermal Requirement Applications Easy-To-Use, 7-Pin Package
- Negative Output Voltage Applications (See AN-2027) [SNVA425](#)

3 Description

The LMZ14202, SIMPLE SWITCHER® power module is an easy-to-use step-down DC-DC that can drive up to 2-A load with exceptional power conversion efficiency, line and load regulation, and output accuracy. The LMZ14202 is available in an innovative package that enhances thermal performance and allows for hand or machine soldering.

The LMZ14202 can accept an input voltage rail between 6 V and 42 V and deliver an adjustable and highly accurate output voltage as low as 0.8 V. The LMZ14202 only requires three external resistors and four external capacitors to complete the power solution. The LMZ14202 is a reliable and robust design with the following protection features: thermal shutdown, input undervoltage lockout, output overvoltage protection, short-circuit protection, output current limit, and allows start-up into a prebiased output. A single resistor adjusts the switching frequency up to 1 MHz.

Device Information⁽¹⁾⁽²⁾

PART NUMBER	PACKAGE	BODY SIZE (NOM)
LMZ14202	TO-PMOD (7)	10.16 mm x 9.85 mm

(1) For all available packages, see the orderable addendum at the end of the datasheet.

(2) Peak reflow temperature equals 245°C . See [SNA4214](#) for more details.

Simplified Application Schematic

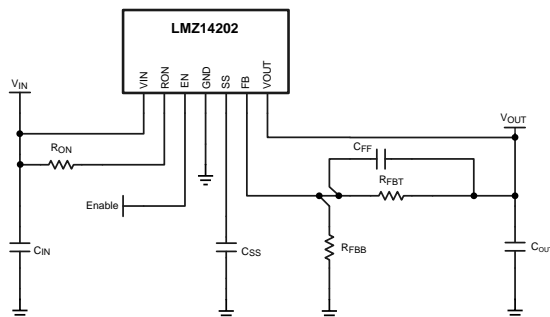

Efficiency 12-V Input at 25°C

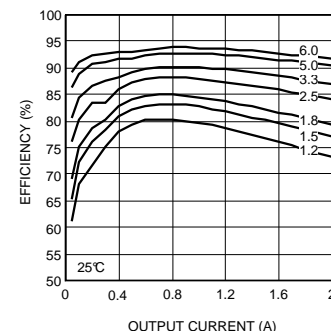

5 Pin Configuration and Functions

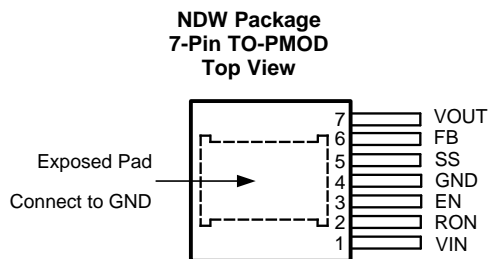

Pin Functions

PIN		TYPE	DESCRIPTION
NAME	NO.		
EN	3	Analog	Enable. Input to the precision enable comparator. Rising threshold is 1.18 V nominal, 90 mV hysteresis nominal. Maximum recommended input level is 6.5 V.
FB	6	Analog	Feedback. Internally connected to the regulation, overvoltage, and short-circuit comparators. The regulation reference point is 0.8 V at this input pin. Connected the feedback resistor divider between the output and ground to set the output voltage.
GND	4	Ground	Ground. Reference point for all stated voltages. Must be externally connected to thermal pad.
RON	2	Analog	ON-time resistor. An external resistor between this pin and the VIN pin sets the ON-time of the application. Typical values range from 25 kΩ to 124 kΩ.
SS	5	Analog	Soft-start. An internal 8-μA current source charges an external capacitor to produce the soft-start function. This node is discharged at 200 μA during disable, over-current, thermal shutdown and internal UVLO conditions.
VIN	1	Power	Supply input. Nominal operating range is 6 V to 42 V. A small amount of internal capacitance is contained within the package assembly. Additional external input capacitance is required between this pin and exposed pad.
VOUT	7	Power	Output voltage. Output from the internal inductor. Connect the output capacitor between this pin and exposed pad.
Thermal pad		Ground	Exposed Pad — Internally connected to pin 4. Used to dissipate heat from the package during operation. Must be electrically connected to pin 4 external to the package.

6 Specifications

6.1 Absolute Maximum Ratings

over operating free-air temperature range (unless otherwise noted) ⁽¹⁾⁽²⁾

		MIN	MAX	UNIT
VIN, RON to GND		-0.3	43.5	V
EN, FB, SS to GND		-0.3	7	V
T _J	Junction temperature		150	°C
	Peak reflow case temperature (30 s)		245	°C
T _{stg}	Storage temperature	-65	150	°C

(1) Stresses beyond those listed under *Absolute Maximum Ratings* may cause permanent damage to the device. These are stress ratings only, which do not imply functional operation of the device at these or any other conditions beyond those indicated under *Recommended Operating Conditions*. Exposure to absolute-maximum-rated conditions for extended periods may affect device reliability.

(2) For soldering specifications, refer to the following document: www.ti.com/lit/snoa549c

6.2 ESD Ratings

		VALUE	UNIT
V _(ESD)	Electrostatic discharge Human body model (HBM), per ANSI/ESDA/JEDEC JS-001 ⁽¹⁾	±2000	V

(1) JEDEC document JEP155 states that 500-V HBM allows safe manufacturing with a standard ESD control process.

LMZ14202

SNVS648J – JANUARY 2010 – REVISED OCTOBER 2015

www.ti.com

6.3 Recommended Operating Conditions

over operating free-air temperature range (unless otherwise noted)

		MIN	MAX	UNIT
V _{IN}	Input voltage	6	42	V
EN	Enable voltage	0	6.5	V
T _J	Junction temperature	-40	125	°C

6.4 Thermal Information

THERMAL METRIC ⁽¹⁾		LMZ14202		UNIT
		NDW (TO-PMOD)		
		7 PINS		
R _{θJA}	Junction-to-ambient thermal resistance	4-layer JEDEC Printed circuit board, 100 vias, No air flow	19.3	°C/W
		2-layer JEDEC Printed circuit board, No air flow	21.5	°C/W
R _{θJC(top)}	Junction-to-case (top) thermal resistance	No air flow	1.9	°C/W

(1) For more information about traditional and new thermal metrics, see the *Semiconductor and IC Package Thermal Metrics* application report, [SPRA953](#).

6.5 Electrical Characteristics

Limits in standard type are for T_J = 25°C only; limits in boldface type apply over the junction temperature (T_J) range of -40°C to +125°C. Minimum and maximum limits are ensured through test, design or statistical correlation. Typical values represent the most likely parametric norm at T_J = 25°C, and are provided for reference purposes only. Unless otherwise stated the following conditions apply: V_{VIN} = 24 V, V_{VOUT} = 3.3 V

PARAMETER	TEST CONDITIONS		MIN ⁽¹⁾	TYP ⁽²⁾	MAX ⁽¹⁾	UNIT	
ENABLE CONTROL⁽³⁾							
V _{EN}	EN threshold trip point	V _{EN} rising		1.18		V	
			-40°C ≤ T _J ≤ 125°C	1.1	1.25		
V _{EN-HYS}	EN threshold hysteresis	V _{EN} falling		90		mV	
SOFT-START							
I _{SS}	SS source current	V _{SS} = 0 V		8		μA	
			-40°C ≤ T _J ≤ 125°C	5	11		
I _{SS-DIS}	SS discharge current			-200		μA	
CURRENT LIMIT							
I _{CL}	Current limit threshold	d.c. average		2.6		A	
			-40°C ≤ T _J ≤ 125°C	2.3	3.65		
ON/OFF TIMER							
t _{ON-MIN}	ON timer minimum pulse width			150		ns	
t _{OFF}	OFF timer pulse width			260		ns	
REGULATION AND OVERVOLTAGE COMPARATOR							
V _{FB}	In-regulation feedback voltage	V _{SS} > 0.8 V, I _O = 2 A		0.795		V	
			-40°C ≤ T _J ≤ 125°C	0.775	0.815		
		V _{SS} >+ 0.8 V, I _O = 10 mA		0.786	0.802	0.818	V
V _{FB-OV}	Feedback over-voltage protection threshold			0.92		V	
I _{FB}	Feedback input bias current			5		nA	

(1) Minimum and maximum limits are 100% production tested at 25°C. Limits over the operating temperature range are ensured through correlation using Statistical Quality Control (SQC) methods. Limits are used to calculate Average Outgoing Quality Level (AOQL).

(2) Typical numbers are at 25°C and represent the most likely parametric norm.

(3) EN 55022:2006, +A1:2007, FCC Part 15 Subpart B: 2007. See *AN-2024 LMZ1420x / LMZ1200x Evaluation Board (SNVA422)* and layout for information on device under test.

Electrical Characteristics (continued)

Limits in standard type are for $T_J = 25^\circ\text{C}$ only; limits in boldface type apply over the junction temperature (T_J) range of -40°C to $+125^\circ\text{C}$. Minimum and maximum limits are ensured through test, design or statistical correlation. Typical values represent the most likely parametric norm at $T_J = 25^\circ\text{C}$, and are provided for reference purposes only. Unless otherwise stated the following conditions apply: $V_{VIN} = 24\text{ V}$, $V_{VOUT} = 3.3\text{ V}$

PARAMETER	TEST CONDITIONS	MIN ⁽¹⁾	TYP ⁽²⁾	MAX ⁽¹⁾	UNIT
I_Q	Non-switching input current $V_{FB} = 0.86\text{ V}$		1		mA
I_{SD}	Shutdown quiescent current $V_{EN} = 0\text{ V}$		25		μA
THERMAL CHARACTERISTICS					
T_{SD}	Thermal shutdown	Rising	165		$^\circ\text{C}$
$T_{SD-HYST}$	Thermal shutdown hysteresis	Falling	15		$^\circ\text{C}$
PERFORMANCE PARAMETERS					
ΔV_O	Output voltage ripple		8		mV _{P-P}
$\Delta V_O/\Delta V_{IN}$	Line regulation	$12\text{ V} \leq V_{VIN} \leq 42\text{ V}$, $I_O = 2\text{ A}$	0.01%		
$\Delta V_O/I_{OUT}$	Load regulation	$V_{VIN} = 24\text{ V}$	1.5		mV/A
η	Efficiency	$V_{VIN} = 24\text{ V}$, $V_O = 3.3\text{ V}$, $I_O = 1\text{ A}$	86%		
		$V_{VIN} = 24\text{ V}$, $V_O = 3.3\text{ V}$, $I_O = 2\text{ A}$	85%		

6.6 Typical Characteristics

Unless otherwise specified, the following conditions apply: $V_{VIN} = 24\text{ V}$; $C_{IN} = 10\ \mu\text{F}$, X7R ceramic; $C_O = 100\ \mu\text{F}$ X7R ceramic; $T_A = 25^\circ\text{C}$.

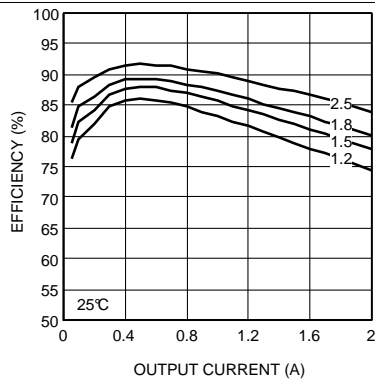
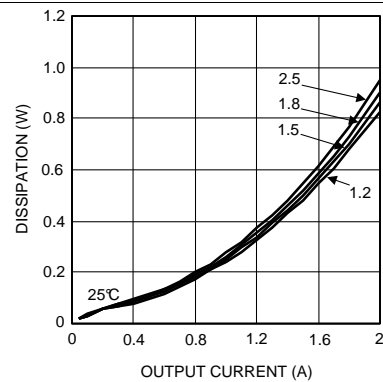
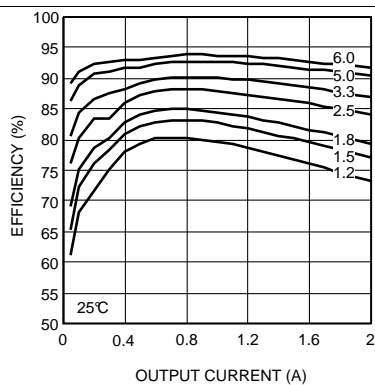
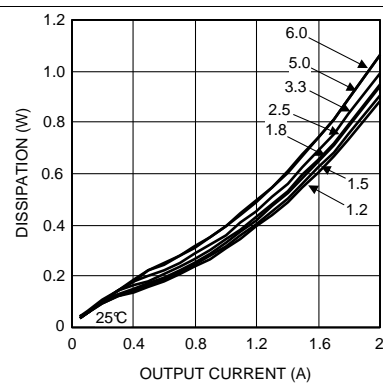
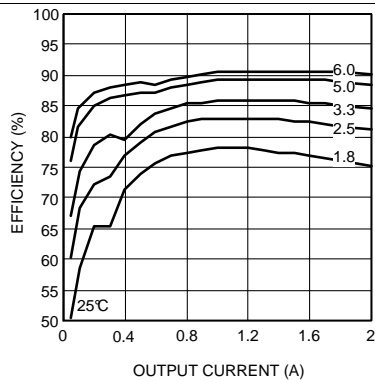
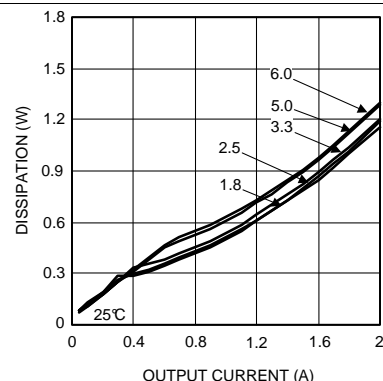
Figure 1. Efficiency 6-V Input

Figure 2. Dissipation 6-V Input

Figure 3. Efficiency 12-V Input

Figure 4. Dissipation 12-V Input

Figure 5. Efficiency 24-V Input

Figure 6. Dissipation 24-V Input

Typical Characteristics (continued)

Unless otherwise specified, the following conditions apply: $V_{VIN} = 24\text{ V}$; $C_{IN} = 10\ \mu\text{F}$, X7R ceramic; $C_O = 100\ \mu\text{F}$ X7R ceramic; $T_A = 25^\circ\text{C}$.

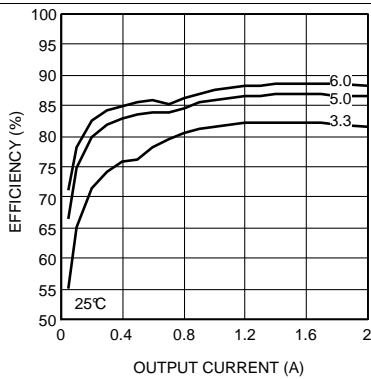

Figure 7. Efficiency 36-V Input at 25°C

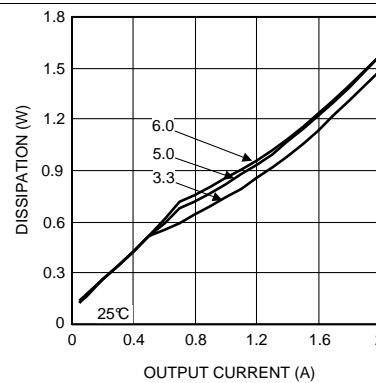

Figure 8. Dissipation 36-V Input

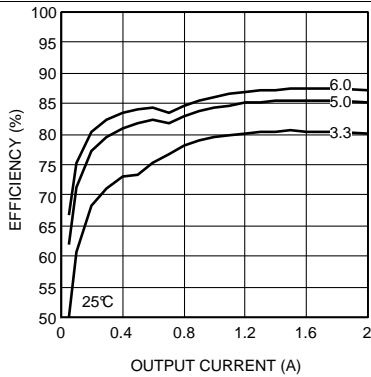

Figure 9. Efficiency 42-V Input

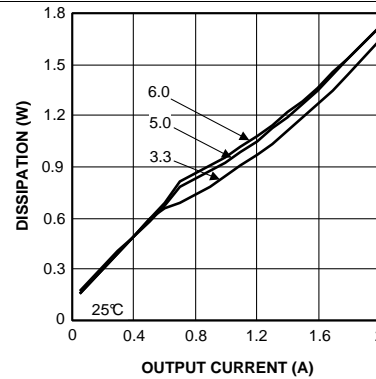

Figure 10. Dissipation 42-V Input

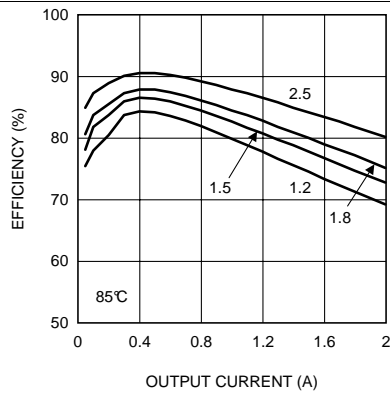

Figure 11. Efficiency 6-V Input, $T_A = 85^\circ\text{C}$

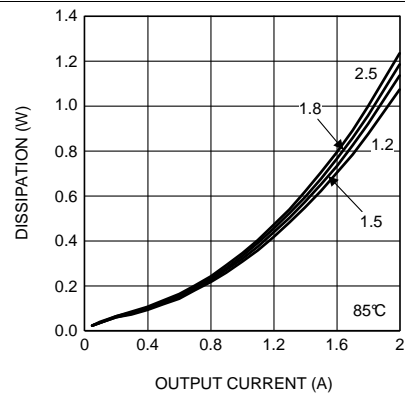

Figure 12. Dissipation 6-V Input, $T_A = 85^\circ\text{C}$

Typical Characteristics (continued)

Unless otherwise specified, the following conditions apply: $V_{VIN} = 24\text{ V}$; $C_{IN} = 10\ \mu\text{F}$, X7R ceramic; $C_O = 100\ \mu\text{F}$ X7R ceramic; $T_A = 25^\circ\text{C}$.

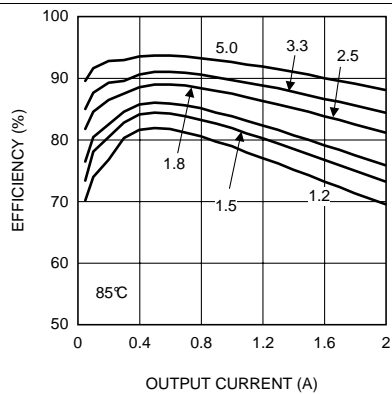

Figure 13. Efficiency 8 V Input, $T_A = 85^\circ\text{C}$

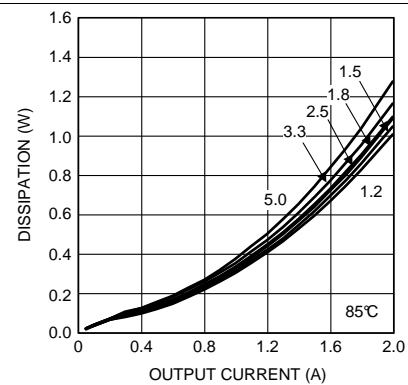

Figure 14. Dissipation 8-V Input, $T_A = 85^\circ\text{C}$

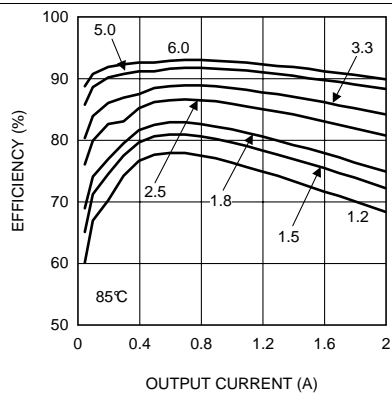

Figure 15. Efficiency 12-V Input, $T_A = 85^\circ\text{C}$

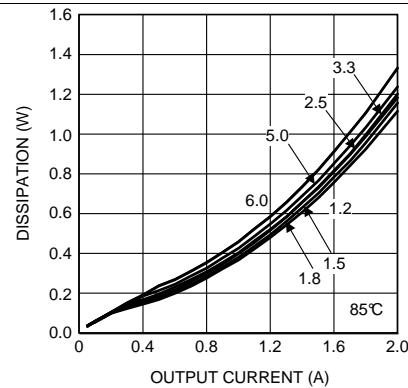

Figure 16. Dissipation 12-V Input, $T_A = 85^\circ\text{C}$

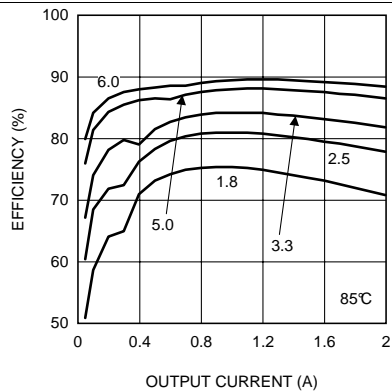

Figure 17. Efficiency 24-V Input, $T_A = 85^\circ\text{C}$

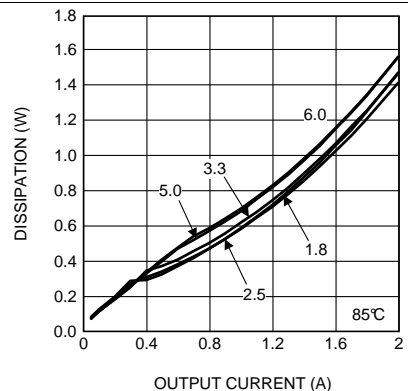

Figure 18. Dissipation 24-V Input, $T_A = 85^\circ\text{C}$

Typical Characteristics (continued)

Unless otherwise specified, the following conditions apply: $V_{VIN} = 24\text{ V}$; $C_{IN} = 10\ \mu\text{F}$, X7R ceramic; $C_O = 100\ \mu\text{F}$ X7R ceramic; $T_A = 25^\circ\text{C}$.

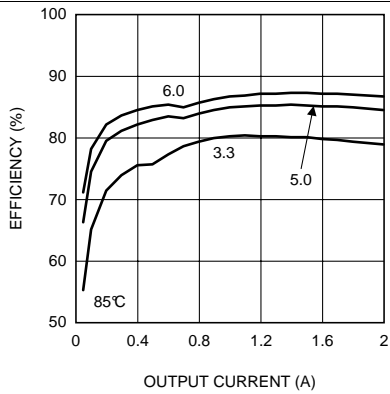

Figure 19. Efficiency 36-V Input, $T_A = 85^\circ\text{C}$

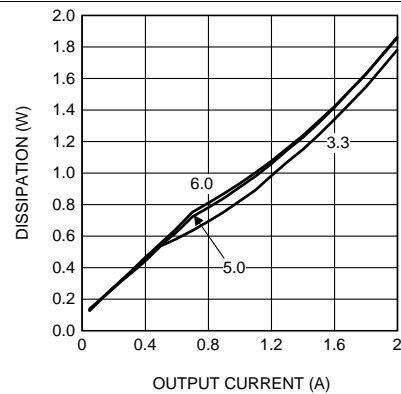

Figure 20. Dissipation 36-V Input, $T_A = 85^\circ\text{C}$

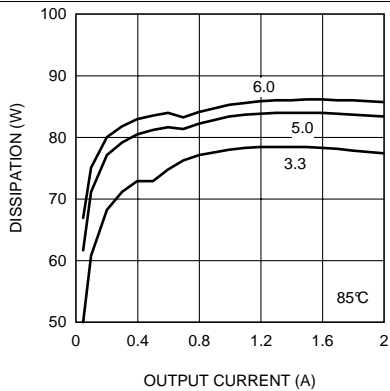

Figure 21. Efficiency 42-V Input, $T_A = 85^\circ\text{C}$

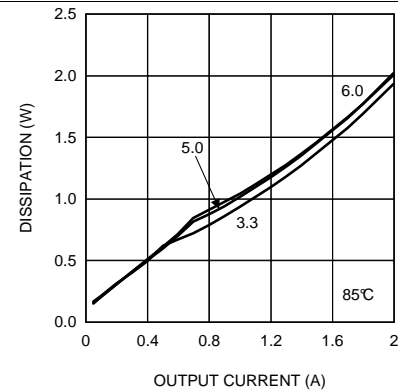

Figure 22. Dissipation 42-V Input, $T_A = 85^\circ\text{C}$

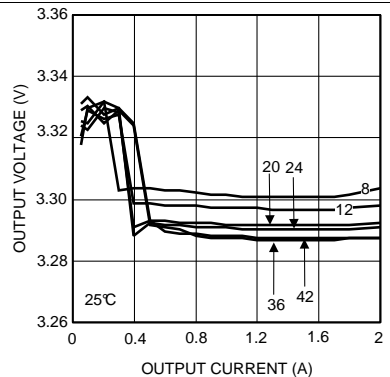

Figure 23. Line and Load Regulation

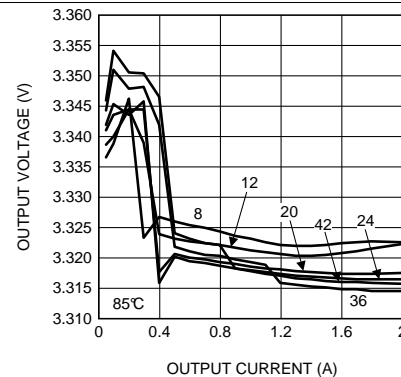

Figure 24. Line and Load Regulation, $T_A = 85^\circ\text{C}$

Typical Characteristics (continued)

Unless otherwise specified, the following conditions apply: $V_{IN} = 24\text{ V}$; $C_{IN} = 10\text{ }\mu\text{F}$, X7R ceramic; $C_O = 100\text{ }\mu\text{F}$ X7R ceramic; $T_A = 25^\circ\text{C}$.

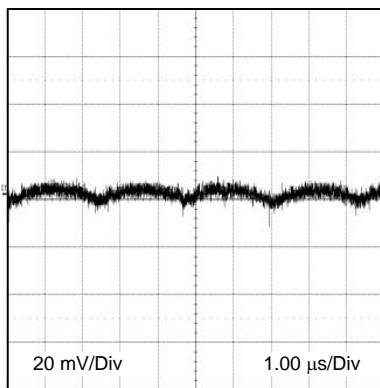

Figure 25. Output Ripple
 $V_{IN} = 24\text{ V}$, $V_O = 3.3\text{ V}$, 2 A , $BW = 200\text{ MHz}$

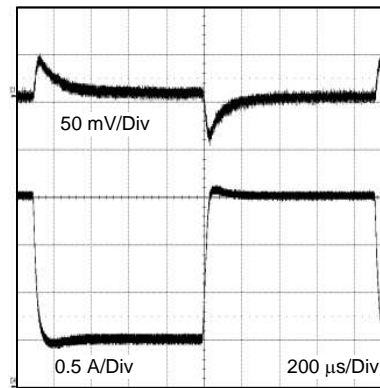

Figure 26. Transient Response
 $V_{IN} = 24\text{ V}$, $V_O = 3.3\text{ V}$, $0.6\text{-A to } 2\text{-A Step}$

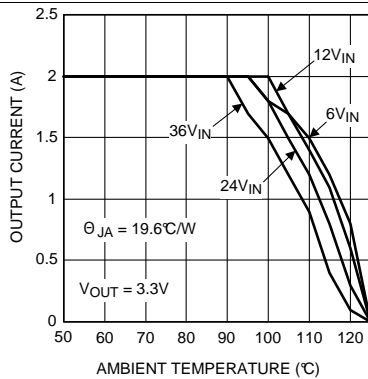

Figure 27. Thermal Derating, $V_{OUT} = 3.3\text{ V}$

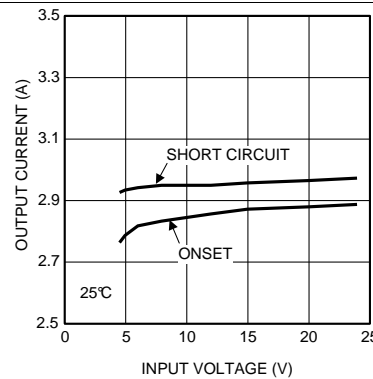

Figure 28. Current Limit, $V_{OUT} = 3.3\text{ V}$

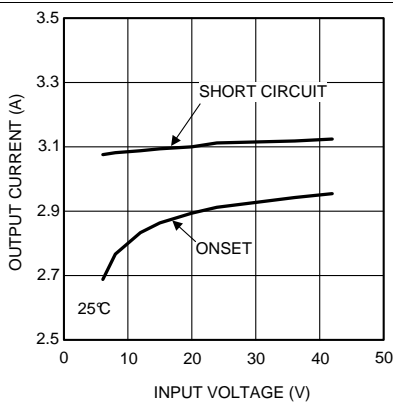

Figure 29. Current Limit, $V_{OUT} = 3.3\text{ V}$,

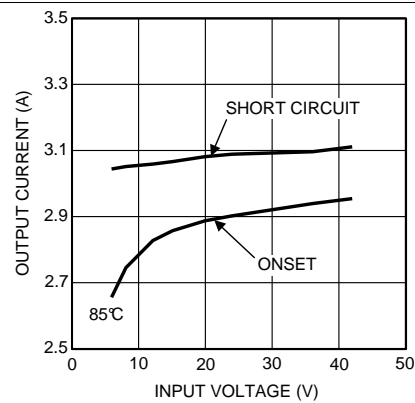

Figure 30. Current Limit, $V_{OUT} = 3.3\text{ V}$, $T_A = 85^\circ\text{C}$

7 Detailed Description

7.1 Overview

The LMZ14202 is a step-down DC-to-DC power module. It is typically used to convert a higher DC voltage to a lower DC voltage with a maximum output current of 2 A.

7.2 Functional Block Diagram

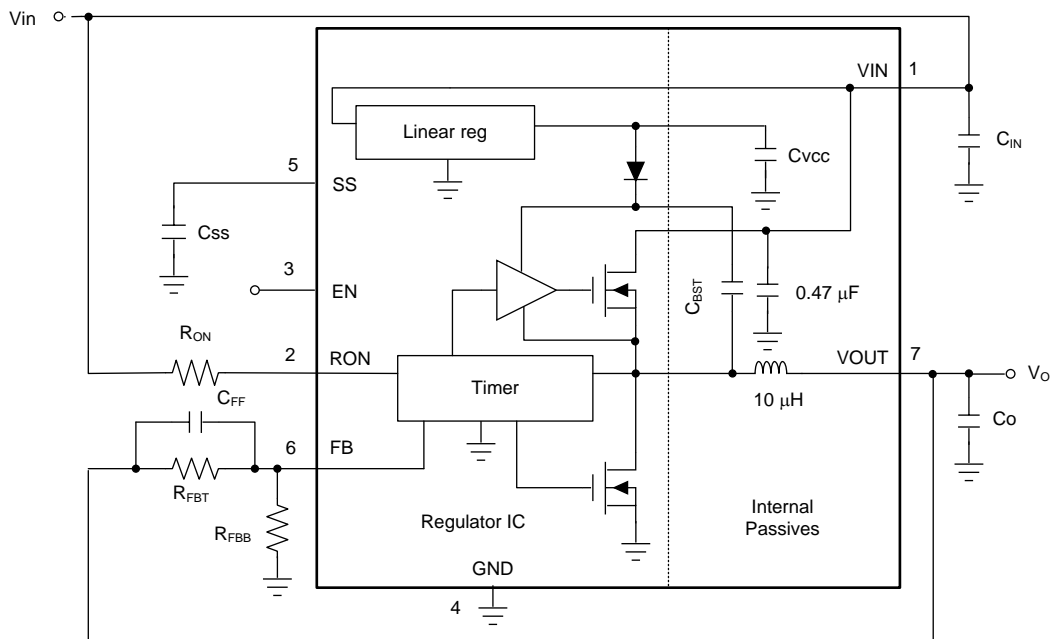

7.3 Feature Description

7.3.1 Constant On-Time Control (COT) Circuit Overview

Constant on-time control (COT) control is based on a comparator and an ON-time one-shot, with the output voltage feedback compared with an internal 0.8-V reference. If the feedback voltage is below the reference, the main MOSFET is turned on for a fixed ON-time determined by a programming resistor $R_{DS(on)}$. $R_{DS(on)}$ is connected to V_{IN} such that ON-time is reduced with increasing input supply voltage. Following this ON-time, the main MOSFET remains off for a minimum of 260 ns. If the voltage on the feedback pin falls below the reference level again the ON-time cycle is repeated. Regulation is achieved in this manner.

7.3.2 Output Overvoltage Comparator

The voltage at FB is compared to a 0.92-V internal reference. If FB rises above 0.92 V the ON-time is immediately terminated. This condition is known as over-voltage protection (OVP). It can occur if the input voltage is increased very suddenly or if the output load is decreased very suddenly. Once OVP is activated, the top MOSFET ON-times are inhibited until the condition clears. Additionally, the synchronous MOSFET remains on until the inductor current falls to zero.

Feature Description (continued)

7.3.3 Current Limit

Current limit detection is carried out during the OFF-time by monitoring the current in the synchronous MOSFET. Referring to the [Functional Block Diagram](#), when the top MOSFET is turned off, the inductor current flows through the load, the PGND pin and the internal synchronous MOSFET. If this current exceeds 2.6 A (typical) the current limit comparator disables the start of the next ON-time period. The next switching cycle occurs only if the FB input is less than 0.8 V and the inductor current has decreased below 2.6 A. Inductor current is monitored during the period of time the synchronous MOSFET is conducting. While the inductor current exceeds 2.6 A, further ON-time intervals for the top MOSFET do not occur. Switching frequency is lower during current limit due to the longer OFF-time.

NOTE

Current limit is dependent on both duty cycle and temperature as illustrated in the graphs in [Typical Characteristics](#) section.

7.3.4 Thermal Protection

Do not allow the junction temperature of the LMZ14202 device to exceed its maximum ratings. Thermal protection is implemented by an internal thermal shutdown circuit which activates at 165 °C (typical) causing the device to enter a low power standby state. In this state the main MOSFET remains off causing V_O to fall, and additionally the CSS capacitor is discharged to ground. Thermal protection helps prevent catastrophic failures for accidental device overheating. When the junction temperature returns to below 145 °C (typical hysteresis = 20 °C) the SS pin is released, V_O rises smoothly, and normal operation resumes.

Applications requiring maximum output current especially those at high input voltage may require application derating at elevated temperatures.

7.3.5 Zero Coil Current Detection

The current of the lower (synchronous) MOSFET is monitored by a zero coil current detection circuit which inhibits the synchronous MOSFET when its current reaches zero until the next ON-time. This circuit enables the DCM operating mode, which improves efficiency at light loads.

7.3.6 Prebiased Start-Up

The LMZ14202 starts up into a pre-biased output. This startup situation is common in multiple rail logic applications where current paths may exist between different power rails during the startup sequence. [Figure 31](#) is a scope capture that shows proper behavior during this event.

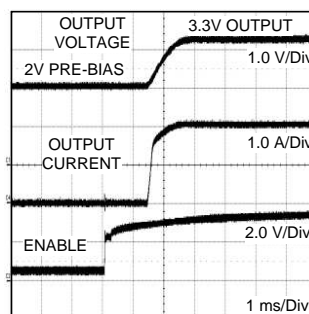

Figure 31. Prebiased Start-Up

7.4 Device Functional Modes

7.4.1 Discontinuous Conduction and Continuous Conduction Modes

At light-load, the regulator operates in discontinuous conduction mode (DCM). With load currents above the critical conduction point, it operates in continuous conduction mode (CCM). When operating in DCM the switching cycle begins at zero amps inductor current; increases up to a peak value, and then recedes back to zero before the end of the OFF-time. During the period of time that inductor current is zero, all load current is supplied by the output capacitor. The next ON-time period starts when the voltage on the FB pin falls below the internal reference. The switching frequency is lower in DCM and varies more with load current as compared to CCM. Conversion efficiency in DCM is maintained because conduction and switching losses are reduced with the smaller load and lower switching frequency.

8 Application and Implementation

NOTE

Information in the following applications sections is not part of the TI component specification, and TI does not warrant its accuracy or completeness. TI's customers are responsible for determining suitability of components for their purposes. Validate and test the design implementation to confirm system functionality.

8.1 Application Information

The LMZ14202 is a step-down DC-to-DC power module. It is typically used to convert a higher DC voltage to a lower DC voltage with a maximum output current of 2 A. The following design procedure can be used to select components for the LMZ14202. Alternately, the WEBENCH software may be used to generate complete designs.

WEBENCH software uses an iterative design procedure and accesses comprehensive databases of components. For more details, go to www.ti.com/WEBENCH.

8.2 Typical Application

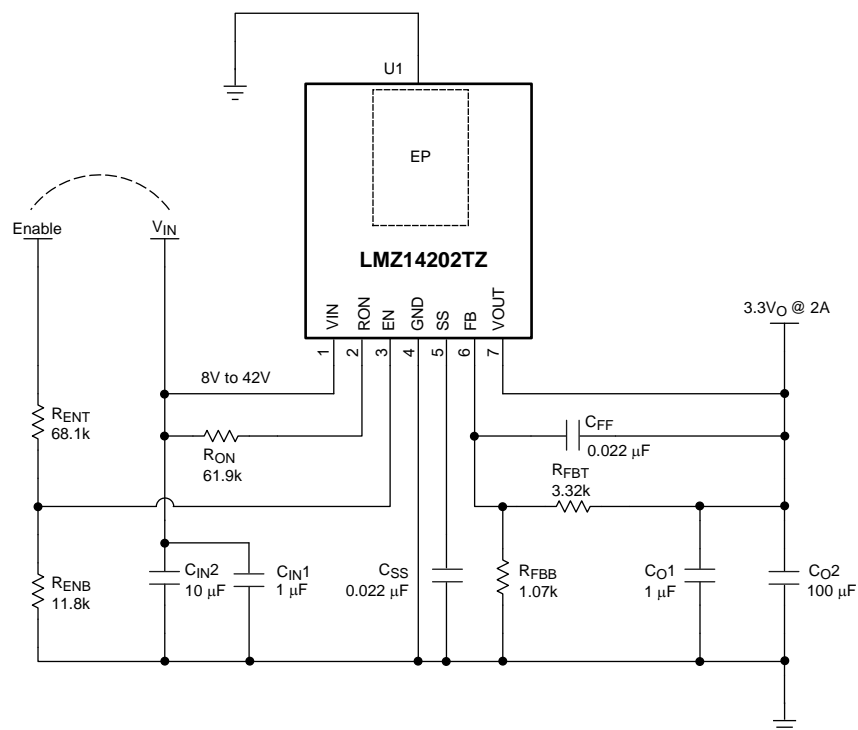

Figure 32. Evaluation Board Schematic Diagram

8.2.1 Design Requirements

For this example the following application parameters exist.

- V_{IN} range: up to 42 V
- $V_{OUT} = 0.8$ V to 5 V
- $I_{OUT} = 2$ A

Refer to [Table 2](#) for more information.

Table 1. Component Value Combinations

VOUT (V)	R _{FBT} (kΩ)	R _{FBB} (kΩ)	R _{DS(on)} (kΩ)	VIN (V)	
				MIN	MAX
5	5.62	1.07	100	7.5	42
3.3	3.32		61.9	6	42
2.5	2.26		47.5		30
1.8	1.87	1.5	25		
1.5	1	1.13	21		
1.2	4.22	8.45	19		
0.8	0	39.2	24.9		18

Table 2. List of Materials

REF DES	DESCRIPTION	SIZE	MANUFACTURER	PART NUMBER
U1	SIMPLE SWITCHER	PFM-7	Texas Instruments	LMZ14202TZ
C _{IN1}	1 μF, 50 V, X7R	1206	Taiyo Yuden	UMK316B7105KL-T
C _{IN2}	10 μF, 50 V, X7R	1210	Taiyo Yuden	UMK325BJ106MM-T
C _{O1}	1 μF, 50 V, X7R	1206	Taiyo Yuden	UMK316B7105KL-T
C _{O2}	100 μF, 6.3 V, X7R	1210	Taiyo Yuden	JMK325BJ107MM-T
R _{FBT}	3.32 kΩ	0603	Vishay Dale	CRCW06033K32FKEA
R _{FBB}	1.07 kΩ	0603	Vishay Dale	CRCW06031K07FKEA
R _{DS(on)}	61.9 kΩ	0603	Vishay Dale	CRCW060361K9FKEA
R _{ENT}	68.1 kΩ	0603	Vishay Dale	CRCW060368K1FKEA
R _{ENB}	11.8 kΩ	0603	Vishay Dale	CRCW060311K8FKEA
C _{FF}	22 nF, ±10%, X7R, 16 V	0603	TDK	C1608X7R1H223K
C _{SS}	22 nF, ±10%, X7R, 16 V	0603	TDK	C1608X7R1H223K

8.2.2 Detailed Design Procedure

8.2.2.1 Design Steps for the LMZ14202 Application

The LMZ14202 is fully supported by WEBENCH and offers the following: Component selection, electrical and thermal simulations as well as the build-it board for a reduction in design time. The following list of steps can be used to manually design the LMZ14202 application.

1. Select minimum operating V_{IN} with enable divider resistors
2. Program V_O with divider resistor selection
3. Program turnon time with soft-start capacitor selection
4. Select C_O
5. Select C_{IN}
6. Set operating frequency with R_{DS(on)}
7. Determine module dissipation
8. Carefully consider thermal performance required when designing the PCB layout

8.2.2.1.1 Enable Divider, R_{ENT} and R_{ENB} Selection

The enable input provides a precise, 1.18-V band-gap rising threshold to allow direct logic drive or connection to a voltage divider from a higher enable voltage such as V_{IN}. The enable input also incorporates 90 mV (typical) of hysteresis resulting in a falling threshold of 1.09 V. The maximum recommended voltage into the EN pin is 6.5 V. For applications where the midpoint of the enable divider exceeds 6.5 V, a small Zener diode can be added to limit this voltage.

The function of this resistive divider is to allow the designer to choose an input voltage below which the circuit becomes disabled. This implements the feature of programmable undervoltage lockout. This is often used in battery powered systems to prevent deep discharge of the system battery. It is also useful in system designs for sequencing of output rails or to prevent early turnon of the supply as the main input voltage rail rises at power-up. Applying the enable divider to the main input rail is often done in the case of higher input voltage systems such as 24-V AC/DC systems where a lower boundary of operation must be established. In the case of sequencing supplies, the divider is connected to a rail that becomes active earlier in the power-up cycle than the LMZ14202 output rail. Choose the two resistors based on [Equation 1](#).

$$R_{ENT} / R_{ENB} = (V_{IN\ UVLO} / 1.18\ V) - 1 \quad (1)$$

The LMZ14202 demonstration and evaluation boards use 11.8 kΩ for R_{ENB} and 68.1 kΩ for R_{ENT} resulting in a rising UVLO of 8 V. This divider presents 6.25 V to the EN input when the divider input is raised to 42 V.

The EN pin is internally pulled up to V_{IN} and can be left floating for always-on operation.

8.2.2.1.2 Output Voltage Selection

Output voltage is determined by a divider of two resistors connected between V_O and ground. The midpoint of the divider is connected to the FB input. The voltage at FB is compared to a 0.8-V internal reference. In normal operation an ON-time cycle is initiated when the voltage on the FB pin falls below 0.8 V. The main MOSFET ON-time cycle causes the output voltage to rise and the voltage at the FB to exceed 0.8 V. As long as the voltage at FB is above 0.8 V, ON-time cycles does not occur.

The regulated output voltage determined by the external divider resistors R_{FBT} and R_{FBB} is:

$$V_O = 0.8\ V \times (1 + R_{FBT} / R_{FBB}) \quad (2)$$

Rearranging terms; the ratio of the feedback resistors for a desired output voltage is:

$$R_{FBT} / R_{FBB} = (V_O / 0.8\ V) - 1 \quad (3)$$

Choose these resistors from values between 1 kΩ and 10 kΩ.

For $V_O = 0.8\ V$ the FB pin can be connected to the output directly so long as an output preload resistor remains that draws more than 20 μA. Converter operation requires this minimum load to create a small inductor ripple current and maintain proper regulation when no load is present.

A feed-forward capacitor is placed in parallel with R_{FBT} to improve load step transient response. Its value is usually determined experimentally by load stepping between DCM and CCM conduction modes and adjusting for best transient response and minimum output ripple.

A table of values for R_{FBT} , R_{FBB} , C_{FF} and $R_{DS(on)}$ is included in the applications schematic.

8.2.2.1.3 Soft-Start Capacitor Selection

Programmable soft-start permits the regulator to slowly ramp to its steady state operating point after being enabled, thereby reducing current inrush from the input supply and slowing the output voltage rise-time to prevent overshoot.

Upon turnon, after all UVLO conditions have been passed, an internal 8 μA current source begins charging the external soft-start capacitor. The soft-start time duration to reach steady state operation is given by the formula:

$$t_{SS} = V_{REF} \times C_{SS} / I_{SS} = 0.8\ V \times C_{SS} / 8\ \mu A \quad (4)$$

This equation can be rearranged as follows:

$$C_{SS} = t_{SS} \times 8\ \mu A / 0.8\ V \quad (5)$$

Use of a 0.022-μF capacitor results in 2.2-ms soft-start duration which is recommended as a minimum value.

As the soft-start input exceeds 0.8 V the output of the power stage comes into regulation. The soft-start capacitor continues charging until it reaches approximately 3.8 V on the SS pin. Voltage levels between 0.8 V and 3.8 V have no effect on other circuit operation. The following conditions reset the soft-start capacitor by discharging the SS input to ground with an internal 200-μA current sink.

- The enable input being pulled low
- Thermal shutdown condition
- Over-current fault
- Internal V_{CC} UVLO (approximately 4-V input to V_{IN})

8.2.2.1.4 C_O Selection

None of the required C_O output capacitance is contained within the module. At a minimum, the output capacitor must meet the worst-case minimum ripple current rating of $0.5 \times I_{LR(P-P)}$, as calculated in [Equation 17](#) below. Beyond the worst-case minimum, additional capacitance reduces output ripple as long as the ESR is low enough to permit it. A minimum value of 10 μF is generally required. Expect to experiment when designing an application to operate with a minimum value. Ceramic capacitors or other low ESR types are recommended. See *AN-2024 LMZ1420x / LMZ1200x Evaluation Board (SNVA422)* for more detail.

[Equation 6](#) provides a good first-pass approximation of C_O for load transient requirements:

$$C_O \geq I_{STEP} \times V_{FB} \times L \times V_{IN} / (4 \times V_O \times (V_{IN} - V_O) \times V_{OUT-TRAN}) \quad (6)$$

Solving:

$$C_O \geq 2 \text{ A} \times 0.8 \text{ V} \times 10 \mu\text{H} \times 24 \text{ V} / (4 \times 3.3 \text{ V} \times (24 \text{ V} - 3.3 \text{ V}) \times 33 \text{ mV}) \geq 43 \mu\text{F} \quad (7)$$

The LMZ14202 demonstration and evaluation boards are populated with a 100-μF 6.3-V X5R output capacitor. Locations for extra output capacitors are provided. See *AN-2024 LMZ1420x / LMZ1200x Evaluation Board (SNVA422)* for locations.

8.2.2.1.5 Input Capacitance (C_{IN}) Selection

The LMZ14202 module contains an internal 0.47-μF input ceramic capacitor. Additional input capacitance is required external to the module to handle the input ripple current of the application. This input capacitance must be very close to the module. Input capacitor selection is generally directed to satisfy the input ripple current requirements rather than by capacitance value. Worst-case input ripple current rating is dictated by [Equation 8](#):

$$I_{CIN(rms)} \cong \frac{1}{2} \times I_O \times \sqrt{\frac{D}{1-D}}$$

where

- $D \cong V_O / V_{IN}$ (8)

The worst-case ripple current occurs when the module is presented with full load current and when $V_{IN} = (2 \times V_O)$.

Recommended minimum input capacitance is 10-μF X7R ceramic with a voltage rating at least 25% higher than the maximum applied input voltage for the application. TI also recommends to pay attention to the voltage and temperature deratings of the capacitor selected.

NOTE

If the capacitor data sheet omits ripple current rating of the ceramic capacitors, contact the capacitor manufacturer to obtain this rating.

If the system design requires a certain minimum value of input ripple voltage ΔV_{IN} be maintained then [Equation 9](#) may be used.

$$C_{IN} \geq I_O \times D \times (1-D) / f_{SW-CCM} \times \Delta V_{IN} \quad (9)$$

If ΔV_{IN} is 1% of V_{IN} for a 24V input to 3.3V output application this equals 240 mV and $f_{SW} = 400$ kHz.

$$C_{IN} \geq 2 \text{ A} \times 3.3 \text{ V} / 24 \text{ V} \times (1 - 3.3 \text{ V} / 24 \text{ V}) / (400000 \times 0.240 \text{ V})$$

$$\geq 2.5 \mu\text{F}$$

Additional bulk capacitance with higher ESR may be required to damp any resonant effects of the input capacitance and parasitic inductance of the incoming supply lines.

8.2.2.1.6 R_{DS(on)} Resistor Selection

Many designs begin with a desired switching frequency in mind. For that purpose [Equation 10](#) can be used.

$$f_{SW(CCM)} \cong V_O / (1.3 \times 10^{-10} \times R_{DS(on)}) \quad (10)$$

This can be rearranged as

$$R_{DS(on)} \cong V_O / (1.3 \times 10^{-10} \times f_{SW(CCM)}) \quad (11)$$

The selection of R_{ON} and $f_{SW(CCM)}$ must be confined by limitations in the ON-time and OFF-time for the [Constant On-Time Control \(COT\) Circuit Overview](#) section.

The ON-time of the LMZ14202 timer is determined by the resistor $R_{DS(on)}$ and the input voltage V_{IN} . It is calculated as follows:

$$t_{ON} = (1.3 \times 10^{-10} \times R_{DS(on)}) / V_{IN} \quad (12)$$

The inverse relationship of t_{ON} and V_{IN} gives a nearly constant switching frequency as V_{IN} is varied. Select an $R_{DS(on)}$ level to facilitate an ON-time at maximum V_{IN} is greater than 150 ns. The ON-timer has a limiter to ensure a minimum of 150 ns for t_{ON} . This function limits the maximum operating frequency, which is governed by [Equation 13](#):

$$f_{SW(max)} = V_O / (V_{IN(max)} \times 150 \text{ ns}) \quad (13)$$

Use [Equation 14](#) to select $R_{DS(on)}$ a particular operating frequency while maintaining the minimum ON-time of 150 ns.

$$R_{DS(on)} \geq V_{IN(max)} \times 150 \text{ ns} / (1.3 \times 10^{-10}) \quad (14)$$

If $R_{DS(on)}$ calculated in [Equation 11](#) is less than the minimum value determined in [Equation 14](#), select a lower frequency. Alternatively, $V_{IN(max)}$ can also be limited to keep the frequency unchanged.

NOTE

The minimum OFF-time of 260 ns limits the maximum duty ratio. Select a larger $R_{DS(on)}$ (lower f_{SW}) for any application requiring large duty ratio.

8.2.2.1.6.1 Discontinuous Conduction and Continuous Conduction Mode Selection

Operating frequency in DCM can be calculated as follows:

$$f_{SW(DCM)} \cong V_O \times (V_{IN}-1) \times 10 \mu\text{H} \times 1.18 \times 10^{20} \times I_O / (V_{IN}-V_O) \times R_{DS(on)}^2 \quad (15)$$

In CCM, current flows through the inductor through the entire switching cycle and never falls to zero during the OFF-time. The switching frequency remains relatively constant with load current and line voltage variations. The CCM operating frequency can be calculated using [Equation 7](#) above.

Following is a comparison pair of waveforms of the showing both CCM (upper) and DCM operating modes.

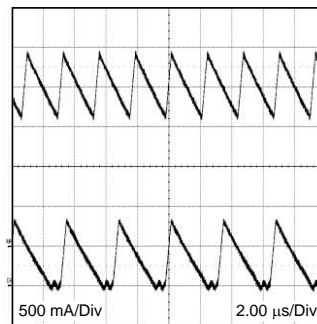

Figure 33. CCM and DCM Operating Modes
 $V_{IN} = 24 \text{ V}$, $V_O = 3.3 \text{ V}$, $I_O = 2 \text{ A}/0.32 \text{ A}$ 2 $\mu\text{s}/\text{div}$

The approximate formula for determining the DCM/CCM boundary is as follows:

$$I_{DCB} \cong V_O \times (V_{IN}-V_O) / (2 \times 10 \mu\text{H} \times f_{SW(CCM)} \times V_{IN}) \quad (16)$$

Following is a typical waveform showing the boundary condition.

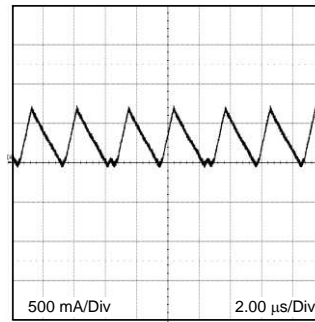

Figure 34. Transition Mode Operation
 $V_{IN} = 24\text{ V}$, $V_O = 3.3\text{ V}$, $I_O = 0.35\text{ A}$ 2 $\mu\text{sec/div}$

The inductor internal to the module is 10 μH . This value was chosen as a good balance between low and high input voltage applications. The main parameter affected by the inductor is the amplitude of the inductor ripple current (I_{LR}). I_{LR} can be calculated with:

$$I_{LR\text{ P-P}} = V_O \times (V_{IN} - V_O) / (10\ \mu\text{H} \times f_{SW} \times V_{IN})$$

where

- V_{IN} is the maximum input voltage and f_{SW} is determined from [Equation 10](#). (17)

If the output current I_O is determined by assuming that $I_O = I_L$, the higher and lower peak of I_{LR} can be determined. Be aware that the lower peak of I_{LR} must be positive if CCM operation is required.

8.2.3 Application Curves

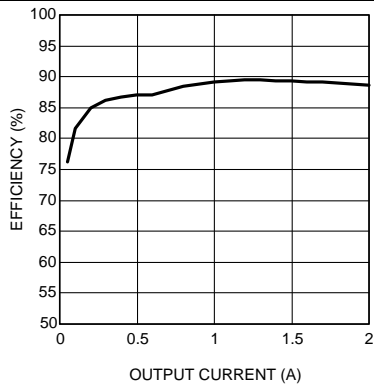
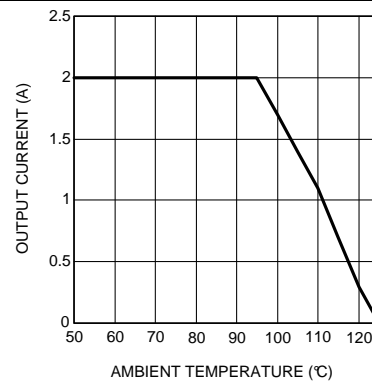
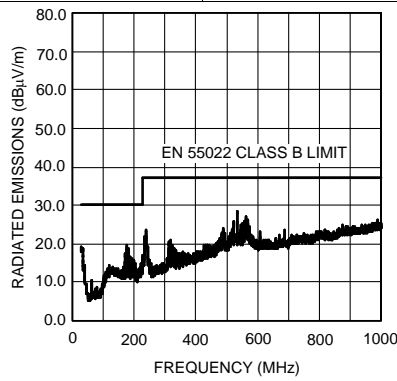

Figure 35. Efficiency $V_{IN} = 24\text{ V}$ $V_{OUT} = 5\text{ V}$



**Figure 36. Thermal Derating Curve
 $V_{IN} = 24\text{ V}$, $V_{OUT} = 5\text{ V}$,**



**Figure 37. Radiated Emissions (EN 55022 Class B)
From Evaluation Board**

9 Power Supply Recommendations

The LMZ14202 device is designed to operate from an input voltage supply range between 4.5 V and 42 V. Use a well-regulated input supply that can withstand maximum input current and maintain a stable voltage. The resistance of the input supply rail must be low enough that an input current transient does not cause a high enough drop at the LMZ14202 supply voltage that can cause a false UVLO fault triggering and system reset. If the input supply is more than a few inches from the LMZ14202, additional bulk capacitance may be required in addition to the ceramic bypass capacitors. The amount of bulk capacitance is not critical, but a 47- μ F or 100- μ F electrolytic capacitor is a typical choice.

10 Layout

10.1 Layout Guidelines

PCB layout is an important part of DC-DC converter design. Poor board layout can disrupt the performance of a DC-DC converter and surrounding circuitry by contributing to EMI, ground bounce and resistive voltage drop in the traces. These can send erroneous signals to the DC-DC converter resulting in poor regulation or instability. Good layout can be implemented by following a few simple design rules.

- **Minimize area of switched current loops.** When considering EMI reduction, it is imperative to minimize the high di/dt paths during PCB layout. The high-current loops that do not overlap have high di/dt content that cause observable high frequency noise on the output pin if the input capacitor (C_{IN1}) is placed at a distance away from the LMZ14202. Therefore place C_{IN1} as close as possible to the LMZ14202 VIN and GND exposed thermal pad. This placement minimizes the high di/dt area and reduce radiated EMI. Additionally, ensure that grounding for both the input and output capacitor consists of a localized top side plane that connects to the GND exposed thermal pad (EP).
- **Have a single point ground.** Route the ground connections for the feedback, soft-start, and enable components to the GND pin of the device. This routing prevents any switched or load currents from flowing in the analog ground traces. If not properly handled, poor grounding can result in degraded load regulation or erratic output voltage ripple behavior. Provide the single point ground connection from pin 4 to the exposed thermal pad.
- **Minimize trace length to the FB pin.** Place both feedback resistors, R_{FBT} and R_{FBB} , and the feed forward capacitor C_{FF} , close to the FB pin. Because the FB node is high impedance, maintain the copper area as small as possible. To minimize noise, route the traces from R_{FBT} , R_{FBB} , and C_{FF} away from the body of the LMZ14202 device.
- **Make input and output bus connections as wide as possible.** Width reduces any voltage drops on the input or output of the converter and maximizes efficiency. To optimize voltage accuracy at the load, ensure that a separate feedback voltage sense trace is made to the load to correct for voltage drops and provide optimum output accuracy.
- **Provide adequate device heat-sinking.** Use an array of heat-sinking vias to connect the exposed pad to the ground plane on the bottom PCB layer. If the PCB has a plurality of copper layers, these thermal vias can also be employed to make connection to inner layer heat-spreading ground planes. For best results use a 6 x 6 via array with minimum via diameter of 10 mils (254 μ m) thermal vias spaced 59 mils (1.5 mm). Ensure enough copper area is used for heat-sinking to maintain the junction temperature below 125°C.

Layout Example (continued)

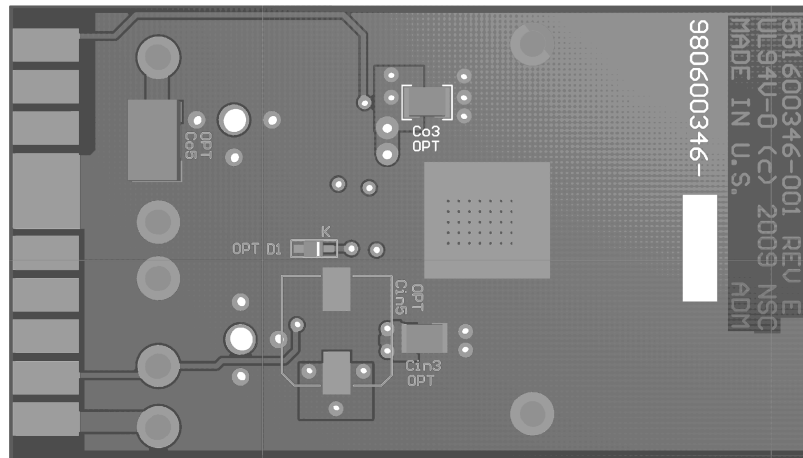

Figure 41. EVM Board Layout - Bottom View

10.3 Power Dissipation and Board Thermal Requirements

When $V_{IN} = 24\text{ V}$, $V_O = 3.3\text{ V}$, $I_O = 2\text{ A}$, $T_{A(max)} = 85^\circ\text{C}$, and $T_J = 125^\circ\text{C}$, the device must achieve a thermal resistance from case-to-ambient described by [Equation 18](#).

$$R_{\theta CA} < (T_{J(max)} - T_{A(max)}) / P_{IC-LOSS} - R_{\theta JC} \quad (18)$$

Given the typical thermal resistance from junction to case to be $1.9\text{ }^\circ\text{C/W}$, use the 85°C power dissipation curves in [Typical Characteristics](#) to estimate the $P_{IC-LOSS}$ for the application. In this application it is 1.5 W .

$$R_{\theta CA} = (125 - 85) / (1.5\text{ W} - 1.9) = 24.8 \quad (19)$$

To reach $R_{\theta CA} = 24.8$, the PCB is required to dissipate heat effectively. With no airflow and no external heat, use [Equation 20](#) to estimate the required board area covered by 1 oz. copper on both the top and bottom metal layers.

$$\text{Board Area}_{\text{cm}^2} = 500^\circ\text{C} \times \text{cm}^2/\text{W} / R_{\theta JC} \quad (20)$$

As a result, approximately 20.2 square cm of 1 oz copper on top and bottom layers is required for the PCB design. The PCB copper heat sink must be connected to the exposed pad. Approximately thirty-six, 10 mils ($254\text{ }\mu\text{m}$) thermal vias spaced 59 mils (1.5 mm) apart must connect the top copper to the bottom copper. For an example of a high thermal performance PCB layout, refer to the *AN-2024 LMZ1420x / LMZ1200x Evaluation Board (SNVA422)*.

10.4 Power Module SMT Guidelines

The recommendations below are for a standard module surface mount assembly

- **Land Pattern** Follow the PCB land pattern with either soldermask defined or non-soldermask defined pads
- **Stencil Aperture**
 - For the exposed die attach pad (DAP), adjust the stencil for approximately 80% coverage of the PCB land pattern
 - For all other I/O pads use a 1:1 ratio between the aperture and the land pattern recommendation
- **Solder Paste** Use a standard SAC Alloy such as SAC 305, type 3 or higher
- **Stencil Thickness:** 0.125 to 0.15 mm
- **Reflow:** Refer to solder paste supplier recommendation and optimized per board size and density
 - Refer to AN [SNAA214](#) for reflow information
 - Maximum number of reflows allowed is one

Power Module SMT Guidelines (continued)

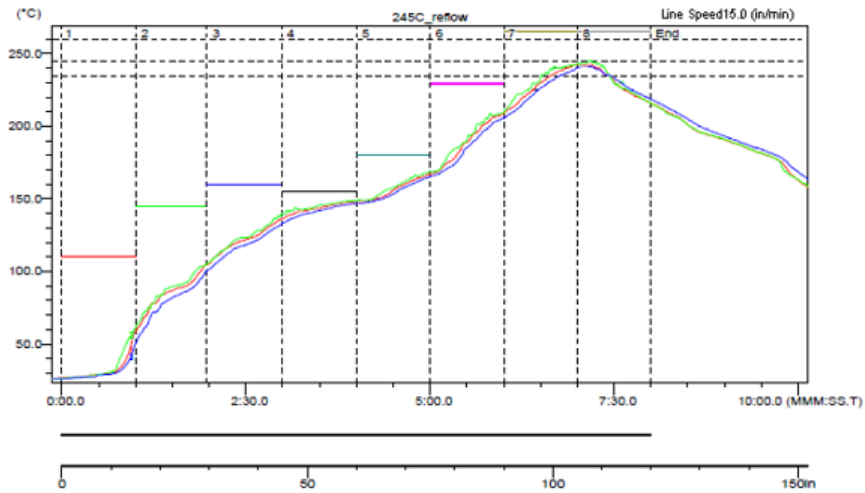

Figure 42. Sample Reflow Profile

Table 3. Sample Reflow Profile Table

Probe	Max Temp (°C)	Reached Max Temp	Time Above 235°C	Reached 235°C	Time Above 245°C	Reached 245°C	Time Above 260°C	Reached 260°C
#1	242.5	6.58	0.49	6.39	0.00	–	0.00	–
#2	242.5	7.10	0.55	6.31	0.00	7.10	0.00	–
#3	241.0	7.09	0.42	6.44	0.00	–	0.00	–

11 Device and Documentation Support

11.1 Device Support

11.1.1 Third-Party Products Disclaimer

TI'S PUBLICATION OF INFORMATION REGARDING THIRD-PARTY PRODUCTS OR SERVICES DOES NOT CONSTITUTE AN ENDORSEMENT REGARDING THE SUITABILITY OF SUCH PRODUCTS OR SERVICES OR A WARRANTY, REPRESENTATION OR ENDORSEMENT OF SUCH PRODUCTS OR SERVICES, EITHER ALONE OR IN COMBINATION WITH ANY TI PRODUCT OR SERVICE.

11.1.2 Development Support

WEBENCH software uses an iterative design procedure and accesses comprehensive databases of components. For more details, go to www.ti.com/WEBENCH.

11.2 Documentation Support

11.2.1 Related Documentation

This section contains additional document support.

- *Design Summary LMZ1 and LMZ2 Power Modules*, [SNAA214](#)
- *AN-2027 Inverting Application for the LMZ14203 SIMPLE SWITCHER Power Module*, [SNVA425](#)
- *Evaluation Board Application Note AN-2024*, [SNVA422](#)
- *Absolute Maximum Ratings for Soldering*, [SNOA549](#)

11.3 Community Resources

The following links connect to TI community resources. Linked contents are provided "AS IS" by the respective contributors. They do not constitute TI specifications and do not necessarily reflect TI's views; see TI's [Terms of Use](#).

TI E2E™ Online Community *TI's Engineer-to-Engineer (E2E) Community*. Created to foster collaboration among engineers. At e2e.ti.com, you can ask questions, share knowledge, explore ideas and help solve problems with fellow engineers.

Design Support *TI's Design Support* Quickly find helpful E2E forums along with design support tools and contact information for technical support.

11.4 Trademarks

E2E is a trademark of Texas Instruments.

WEBENCH, SIMPLE SWITCHER are registered trademarks of Texas Instruments.

All other trademarks are the property of their respective owners.

11.5 Electrostatic Discharge Caution



These devices have limited built-in ESD protection. The leads should be shorted together or the device placed in conductive foam during storage or handling to prevent electrostatic damage to the MOS gates.

11.6 Glossary

SLYZ022 — *TI Glossary*.

This glossary lists and explains terms, acronyms, and definitions.

12 Mechanical, Packaging, and Orderable Information

The following pages include mechanical, packaging, and orderable information. This information is the most current data available for the designated devices. This data is subject to change without notice and revision of this document. For browser-based versions of this data sheet, refer to the left-hand navigation.

PACKAGING INFORMATION

Orderable part number	Status (1)	Material type (2)	Package Pins	Package qty Carrier	RoHS (3)	Lead finish/ Ball material (4)	MSL rating/ Peak reflow (5)	Op temp (°C)	Part marking (6)
LMZ14202TZ-ADJ/NO.A	Active	Production	TO-PMOD (NDW) 7	250 SMALL T&R	Yes	SN	Level-3-245C-168 HR	-40 to 125	LMZ14202 TZ-ADJ
LMZ14202TZ-ADJ/NOPB	Active	Production	TO-PMOD (NDW) 7	250 SMALL T&R	Yes	SN	Level-3-245C-168 HR	-40 to 125	LMZ14202 TZ-ADJ
LMZ14202TZE-ADJ/NO.A	Active	Production	TO-PMOD (NDW) 7	45 TUBE	Yes	SN	Level-3-245C-168 HR	-40 to 125	LMZ14202 TZ-ADJ
LMZ14202TZE-ADJ/NOPB	Active	Production	TO-PMOD (NDW) 7	45 TUBE	Yes	SN	Level-3-245C-168 HR	-40 to 125	LMZ14202 TZ-ADJ
LMZ14202TZX-ADJ/NO.A	Active	Production	TO-PMOD (NDW) 7	500 LARGE T&R	Yes	SN	Level-3-245C-168 HR	-40 to 125	LMZ14202 TZ-ADJ
LMZ14202TZX-ADJ/NOPB	Active	Production	TO-PMOD (NDW) 7	500 LARGE T&R	Yes	SN	Level-3-245C-168 HR	-40 to 125	LMZ14202 TZ-ADJ

(1) **Status:** For more details on status, see our [product life cycle](#).

(2) **Material type:** When designated, preproduction parts are prototypes/experimental devices, and are not yet approved or released for full production. Testing and final process, including without limitation quality assurance, reliability performance testing, and/or process qualification, may not yet be complete, and this item is subject to further changes or possible discontinuation. If available for ordering, purchases will be subject to an additional waiver at checkout, and are intended for early internal evaluation purposes only. These items are sold without warranties of any kind.

(3) **RoHS values:** Yes, No, RoHS Exempt. See the [TI RoHS Statement](#) for additional information and value definition.

(4) **Lead finish/Ball material:** Parts may have multiple material finish options. Finish options are separated by a vertical ruled line. Lead finish/Ball material values may wrap to two lines if the finish value exceeds the maximum column width.

(5) **MSL rating/Peak reflow:** The moisture sensitivity level ratings and peak solder (reflow) temperatures. In the event that a part has multiple moisture sensitivity ratings, only the lowest level per JEDEC standards is shown. Refer to the shipping label for the actual reflow temperature that will be used to mount the part to the printed circuit board.

(6) **Part marking:** There may be an additional marking, which relates to the logo, the lot trace code information, or the environmental category of the part.

Multiple part markings will be inside parentheses. Only one part marking contained in parentheses and separated by a "~" will appear on a part. If a line is indented then it is a continuation of the previous line and the two combined represent the entire part marking for that device.

Important Information and Disclaimer: The information provided on this page represents TI's knowledge and belief as of the date that it is provided. TI bases its knowledge and belief on information provided by third parties, and makes no representation or warranty as to the accuracy of such information. Efforts are underway to better integrate information from third parties. TI has taken and continues to take reasonable steps to provide representative and accurate information but may not have conducted destructive testing or chemical analysis on incoming materials and chemicals. TI and TI suppliers consider certain information to be proprietary, and thus CAS numbers and other limited information may not be available for release.

In no event shall TI's liability arising out of such information exceed the total purchase price of the TI part(s) at issue in this document sold by TI to Customer on an annual basis.

TAPE AND REEL INFORMATION

QUADRANT ASSIGNMENTS FOR PIN 1 ORIENTATION IN TAPE

*All dimensions are nominal

Device	Package Type	Package Drawing	Pins	SPQ	Reel Diameter (mm)	Reel Width W1 (mm)	A0 (mm)	B0 (mm)	K0 (mm)	P1 (mm)	W (mm)	Pin1 Quadrant
LMZ14202TZ-ADJ/NOPB	TO-PMOD	NDW	7	250	330.0	24.4	10.6	14.22	5.0	16.0	24.0	Q2
LMZ14202TZ-ADJ/NOPB	TO-PMOD	NDW	7	500	330.0	24.4	10.6	14.22	5.0	16.0	24.0	Q2

TAPE AND REEL BOX DIMENSIONS

*All dimensions are nominal

Device	Package Type	Package Drawing	Pins	SPQ	Length (mm)	Width (mm)	Height (mm)
LMZ14202TZ-ADJ/NOPB	TO-PMOD	NDW	7	250	356.0	356.0	45.0
LMZ14202TZX-ADJ/NOPB	TO-PMOD	NDW	7	500	356.0	356.0	45.0

TUBE

*All dimensions are nominal

Device	Package Name	Package Type	Pins	SPQ	L (mm)	W (mm)	T (μm)	B (mm)
LMZ14202TZE-ADJ/NO.A	NDW	TO-PMOD	7	45	502	17	6700	8.4
LMZ14202TZE-ADJ/NOB	NDW	TO-PMOD	7	45	502	17	6700	8.4

NDW0007A

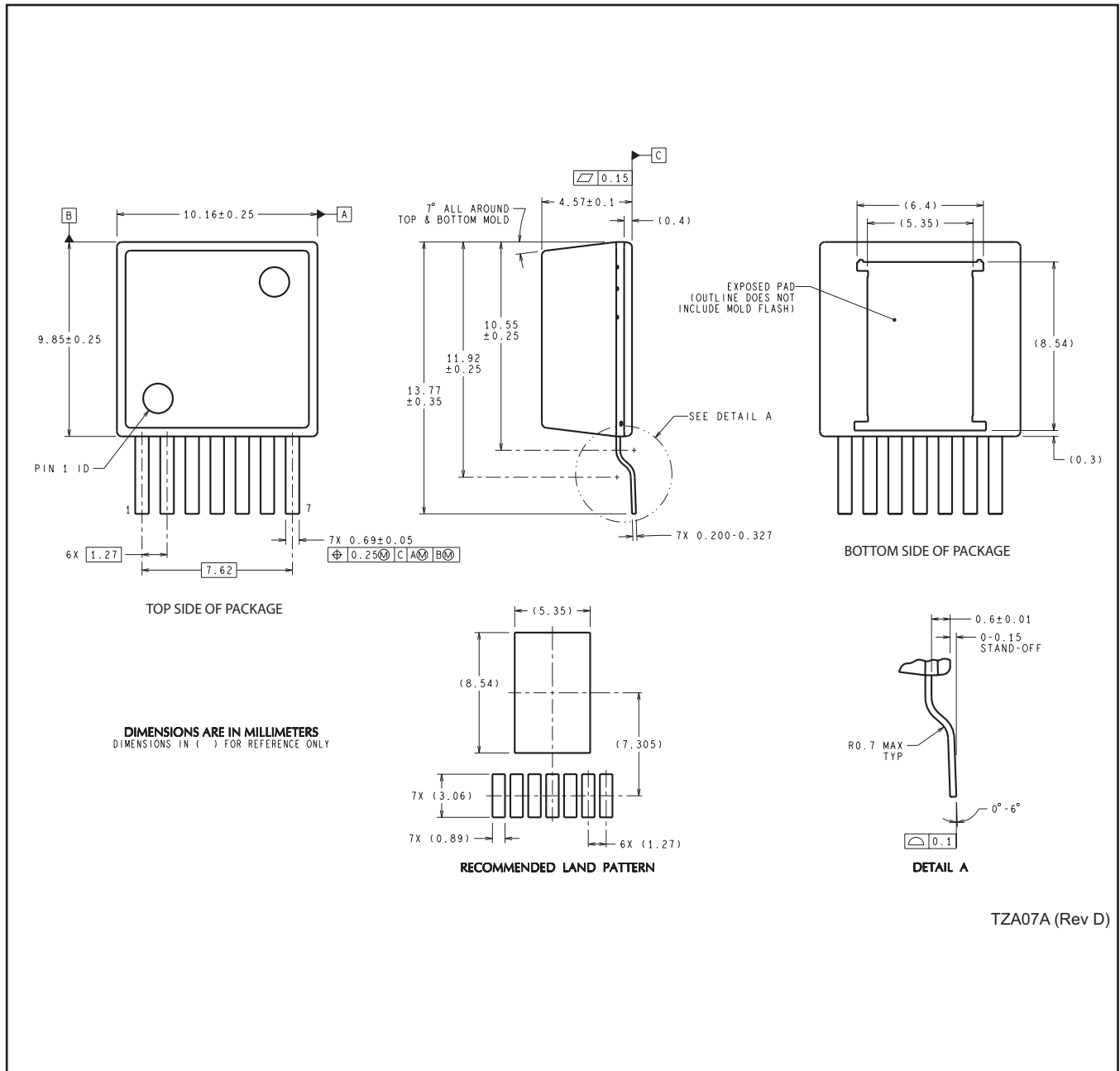

TZA07A (Rev D)

IMPORTANT NOTICE AND DISCLAIMER

TI PROVIDES TECHNICAL AND RELIABILITY DATA (INCLUDING DATASHEETS), DESIGN RESOURCES (INCLUDING REFERENCE DESIGNS), APPLICATION OR OTHER DESIGN ADVICE, WEB TOOLS, SAFETY INFORMATION, AND OTHER RESOURCES "AS IS" AND WITH ALL FAULTS, AND DISCLAIMS ALL WARRANTIES, EXPRESS AND IMPLIED, INCLUDING WITHOUT LIMITATION ANY IMPLIED WARRANTIES OF MERCHANTABILITY, FITNESS FOR A PARTICULAR PURPOSE OR NON-INFRINGEMENT OF THIRD PARTY INTELLECTUAL PROPERTY RIGHTS.

These resources are intended for skilled developers designing with TI products. You are solely responsible for (1) selecting the appropriate TI products for your application, (2) designing, validating and testing your application, and (3) ensuring your application meets applicable standards, and any other safety, security, regulatory or other requirements.

These resources are subject to change without notice. TI grants you permission to use these resources only for development of an application that uses the TI products described in the resource. Other reproduction and display of these resources is prohibited. No license is granted to any other TI intellectual property right or to any third party intellectual property right. TI disclaims responsibility for, and you fully indemnify TI and its representatives against any claims, damages, costs, losses, and liabilities arising out of your use of these resources.

TI's products are provided subject to [TI's Terms of Sale](#), [TI's General Quality Guidelines](#), or other applicable terms available either on [ti.com](#) or provided in conjunction with such TI products. TI's provision of these resources does not expand or otherwise alter TI's applicable warranties or warranty disclaimers for TI products. Unless TI explicitly designates a product as custom or customer-specified, TI products are standard, catalog, general purpose devices.

TI objects to and rejects any additional or different terms you may propose.

Copyright © 2025, Texas Instruments Incorporated

Last updated 10/2025