

# LT1030C QUADRUPLE LOW-POWER LINE DRIVER

SLLS048F – APRIL 1989 – REVISED APRIL 1998

- Low Supply Voltage . . .  $\pm 5$  V to  $\pm 15$  V
- Supply Current . . . 500  $\mu$ A Typical
- Zero Supply Current When Shut Down
- Outputs Can Be Driven  $\pm 30$  V
- Output Open When Off (3-State)
- 10-mA Output Drive
- Outputs of Several Devices Can Be Connected in Parallel
- Meets or Exceeds the Requirements of ANSI EIA/TIA-232-F Specifications
- Designed to Be Interchangeable With Linear Technology LT1030

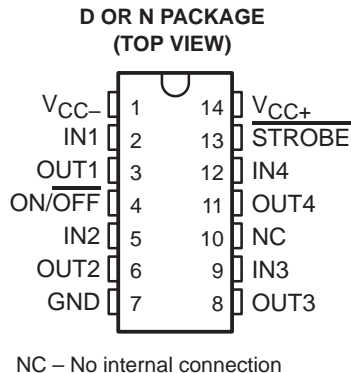

## description

The LT1030C is an EIA/TIA-232-F line driver that operates over a  $\pm 5$ -V to  $\pm 15$ -V supply-voltage range on low supply current. The device can be shut down to zero supply current. Current limiting fully protects the outputs from externally applied voltages of  $\pm 30$  V. Since the output swings to within 200 mV of the positive supply and to within 1 V of the negative supply, supply-voltage requirements are minimized.

A major advantage of the LT1030C is the high-impedance output state when the device is off or powered down. This feature allows several different drivers on the same bus.

The device can be used as an EIA/TIA-232-F driver, micropower interface, or level translator, among others.

The LT1030C is characterized for operation from 0°C to 70°C.

### AVAILABLE OPTIONS

PACKAGE	
SMALL OUTLINE (D)	PLASTIC DIP (N)
LT1030CD	LT1030CN

The D package is available taped and reeled. Add the suffix R to the device type (i.e., LT1030CDR).



Please be aware that an important notice concerning availability, standard warranty, and use in critical applications of Texas Instruments semiconductor products and disclaimers thereto appears at the end of this data sheet.

PRODUCTION DATA information is current as of publication date. Products conform to specifications per the terms of Texas Instruments standard warranty. Production processing does not necessarily include testing of all parameters.

 **TEXAS  
INSTRUMENTS**

POST OFFICE BOX 655303 • DALLAS, TEXAS 75265

Copyright © 1998, Texas Instruments Incorporated

# LT1030C QUADRUPLE LOW-POWER LINE DRIVER

SLLS048F – APRIL 1989 – REVISED APRIL 1998

## logic symbol†

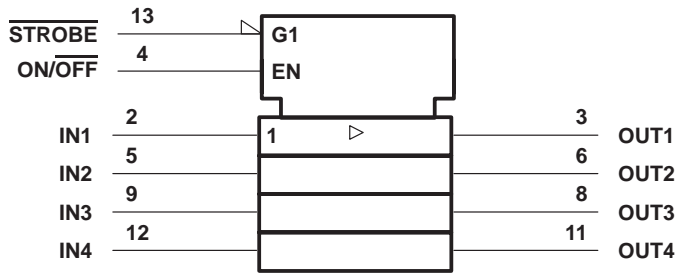

† This symbol is in accordance with ANSI/IEEE Std 91-1984 and IEC Publication 617-12.

## logic diagram

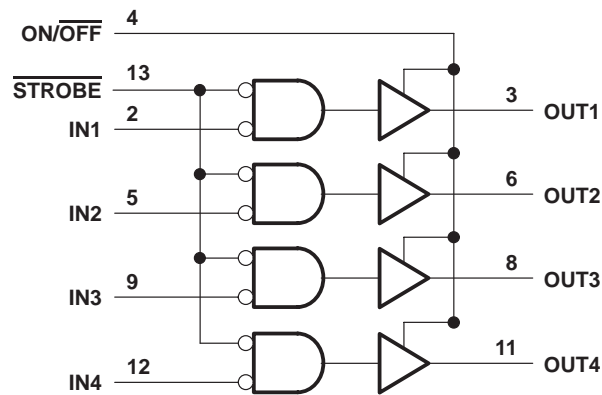

## Terminal Functions

TERMINAL NAME	NO.	DESCRIPTION
GND	7	Ground terminal
IN1 IN2 IN3 IN4	2 5 9 12	Logic inputs. IN <sub>x</sub> operate properly on TTL or CMOS levels. Output valid from $V_I = V_{CC-} + 2\text{ V}$ to 15 V. Connect to 5 V when not used.
ON/OFF	4	ON/OFF shuts down the entire circuit. It cannot be left open. For normally on operation, connect between 5 V and 10 V. If $V_{IL}$ is at or near 0.8 V, significant settling time may be required.
OUT1 OUT2 OUT3 OUT4	3 6 8 11	Line driver outputs
STROBE	13	STROBE forces all outputs low. Drive with 3 V. Strobe terminal input impedance is approximately 2 kΩ to GND. Leave STROBE open when not used.
V <sub>CC+</sub>	14	Positive supply
V <sub>CC-</sub>	1	Negative supply

# LT1030C QUADRUPLE LOW-POWER LINE DRIVER

SLLS048F – APRIL 1989 – REVISED APRIL 1998

## absolute maximum ratings over operating free-air temperature range (unless otherwise noted)†

Supply voltage range, $V_{CC+}$ (see Note 1)	0 V to 15 V
Supply voltage range, $V_{CC-}$	0 V to -15 V
Input voltage range, logic inputs, $V_I$	$V_{CC-}$ to 25 V
Input voltage range at ON/OFF, $V_I$	0 V to 12 V
Output voltage range, $V_O$ (any output)	$V_{CC+} - 30$ V to $V_{CC-} + 30$ V
Duration of output short circuit to $\pm 30$ V at (or below) 25°C (see Note 2)	Unlimited
Package thermal impedance, $\theta_{JA}$ (see Note 3): D package	127°C/W
N package	78°C/W
Storage temperature range, $T_{stg}$	-65°C to 150°C
Lead temperature 1,6 mm (1/16 inch) from case for 10 seconds	260°C

† Stresses beyond those listed under “absolute maximum ratings” may cause permanent damage to the device. These are stress ratings only, and functional operation of the device at these or any other conditions beyond those indicated under “recommended operating conditions” is not implied. Exposure to absolute-maximum-rated conditions for extended periods may affect device reliability.

- NOTES:
1. All voltage values, except differential voltages, are with respect to GND.
  2. The output may be shorted to either supply. Temperature and/or supply voltages must be limited to ensure that the maximum dissipation rating is not exceeded.
  3. The package thermal impedance is calculated in accordance with JESD 51, except for through-hole packages, which use a trace length of zero.

## recommended operating conditions

	MIN	MAX	UNIT
Supply voltage, $V_{CC+}$	5	15	V
Supply voltage, $V_{CC-}$	-5	-15	V
High-level input voltage, $V_{IH}$ (see Note 4)	2	15	V
Low-level input voltage, $V_{IL}$ (see Note 4)		0.8	V
Operating free-air temperature, $T_A$	0	70	°C

NOTE 4: These  $V_{IH}$  and  $V_{IL}$  specifications apply only for inputs IN1–IN4. For operating levels for ON/OFF, see Figure 2.

## electrical characteristics over operating free-air temperature range, $V_{CC\pm} = \pm 5$ V to $\pm 15$ V (unless otherwise noted)

PARAMETER	TEST CONDITIONS	MIN	TYP‡	MAX	UNIT
$V_{OM+}$ Maximum positive peak output voltage swing	$I_O = -2$ mA, $T_A = 25^\circ\text{C}$	$V_{CC+} - 0.3$	$V_{CC+} - 0.1$		V
$V_{OM-}$ Maximum negative peak output voltage swing	$I_O = 2$ mA, $T_A = 25^\circ\text{C}$		$V_{CC-} + 0.9$	$V_{CC-} + 1.4$	V
$I_{IH}$ High-level input current	$V_I \geq 2$ V, $T_A = 25^\circ\text{C}$		2	20	$\mu\text{A}$
$I_{IL}$ Low-level input current	$V_I \leq 0.8$ V, $T_A = 25^\circ\text{C}$		-10	-20	$\mu\text{A}$
$I_I$ Input current, ON/OFF	$V_I = 0$		-0.1	-10	$\mu\text{A}$
	$V_I = 5$ V		30	65	
$I_O$ Output current	$T_A = 25^\circ\text{C}$	5	12		mA
$I_{OZ}$ Off-state output current	$V_O = \pm 15$ V, $T_A = 25^\circ\text{C}$ , ON/OFF at 0.4 V		$\pm 2$	$\pm 100$	$\mu\text{A}$
$I_{CC}$ Supply current (all outputs low)	$V_I \geq$ at 2.4 V, $I_O = 0$		500	1000	$\mu\text{A}$
$I_{CC(off)}$ Off-state supply current	ON/OFF at 0.4 V			10	$\mu\text{A}$
	ON/OFF at 0.1 V		10	150	

‡ All typical values are at  $V_{CC\pm} = \pm 12$  V,  $T_A = 25^\circ\text{C}$ .



# LT1030C QUADRUPLE LOW-POWER LINE DRIVER

SLLS048F – APRIL 1989 – REVISED APRIL 1998

operating characteristics,  $V_{CC\pm} = \pm 5 \text{ V to } \pm 15 \text{ V}$ ,  $T_A = 25^\circ\text{C}$

PARAMETER	TEST CONDITIONS	MIN	TYP†	MAX	UNIT
SR Driver slew rate	$R_L = 3 \text{ k}\Omega$ , $C_L = 51 \text{ pF}$	4	15	30	V/ $\mu\text{s}$

† All typical values are at  $V_{CC\pm} = \pm 12 \text{ V}$ ,  $T_A = 25^\circ\text{C}$ .

## TYPICAL CHARACTERISTICS

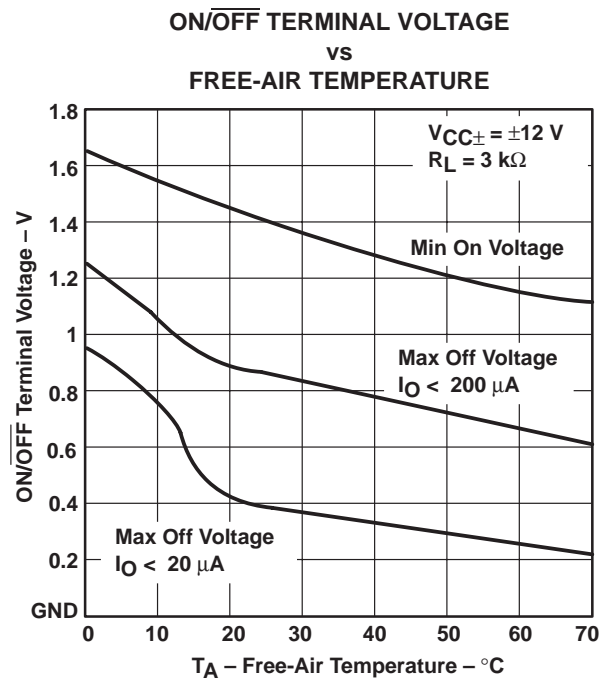
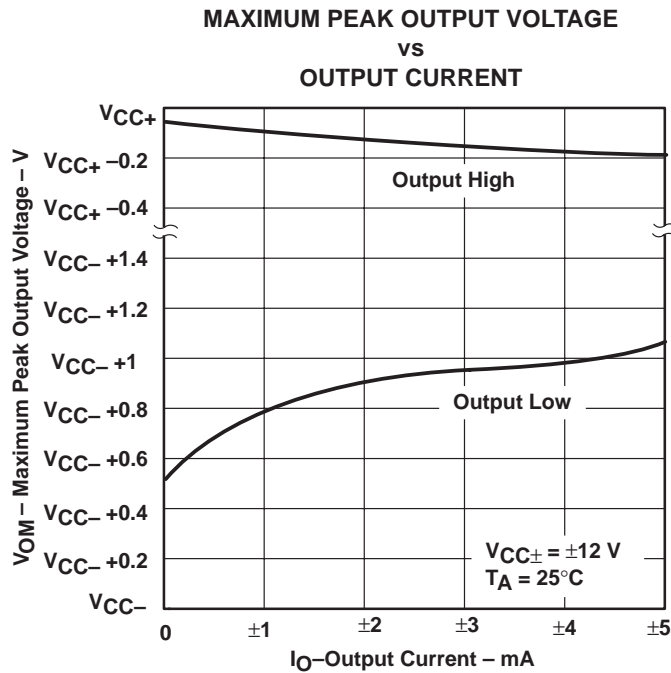

TYPICAL CHARACTERISTICS

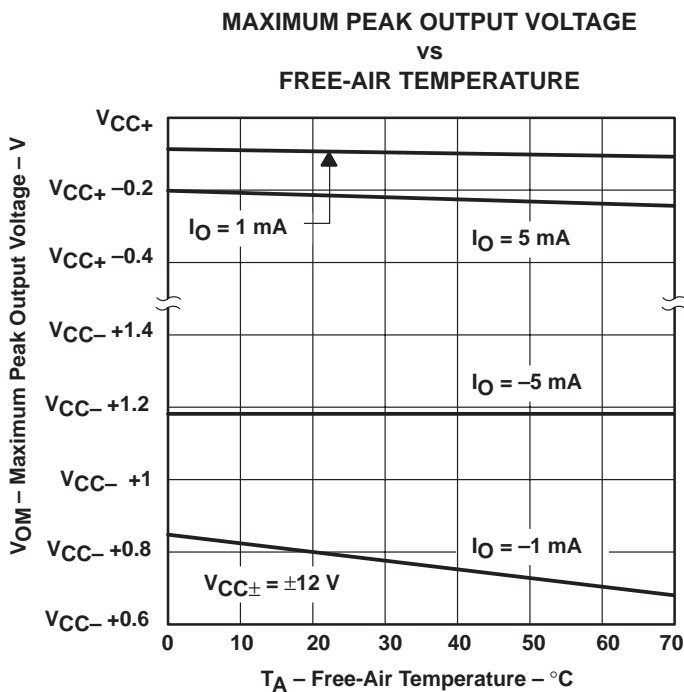

Figure 3

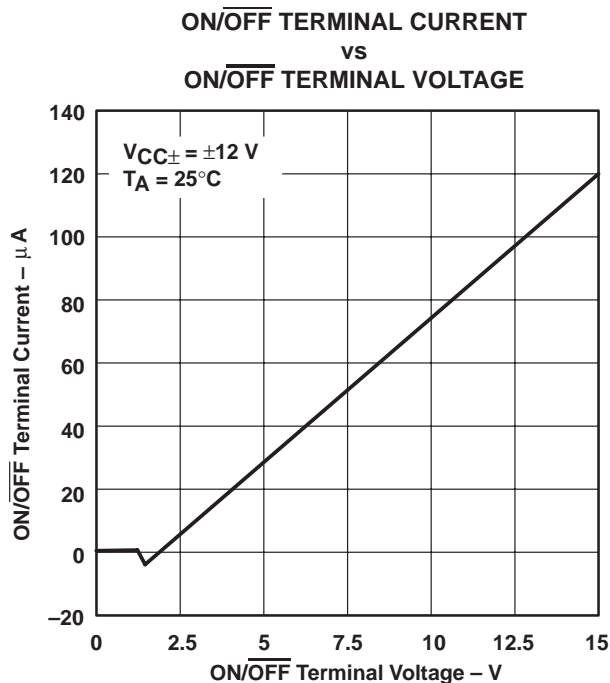

Figure 4

TYPICAL CHARACTERISTICS

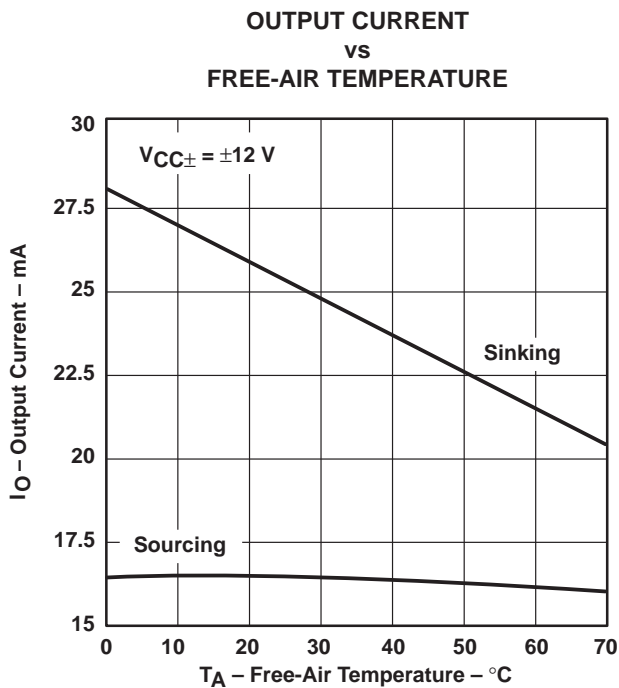

Figure 5

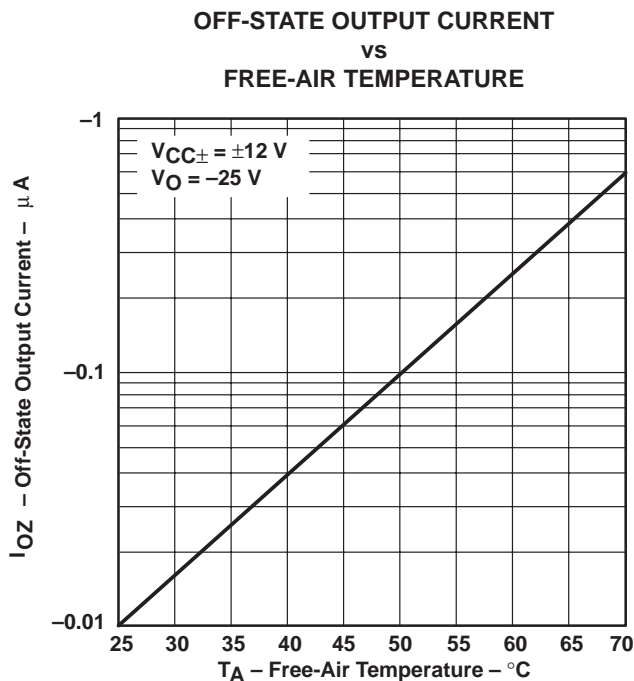

Figure 6

# LT1030C QUADRUPLE LOW-POWER LINE DRIVER

SLLS048F – APRIL 1989 – REVISED APRIL 1998

## TYPICAL CHARACTERISTICS

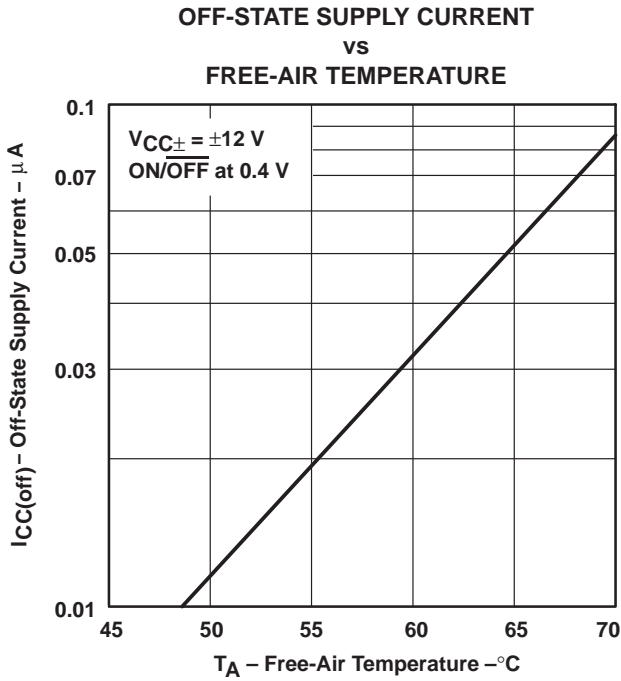

Figure 7

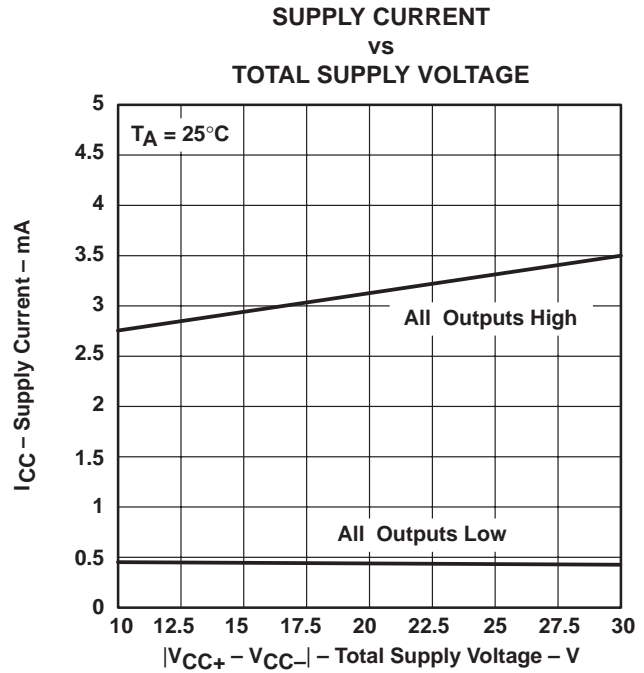

Figure 8

## TYPICAL CHARACTERISTICS

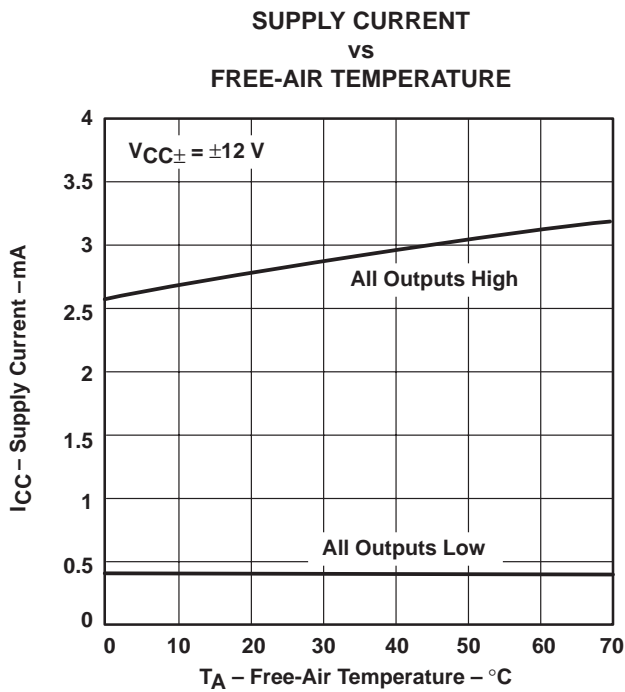

Figure 9

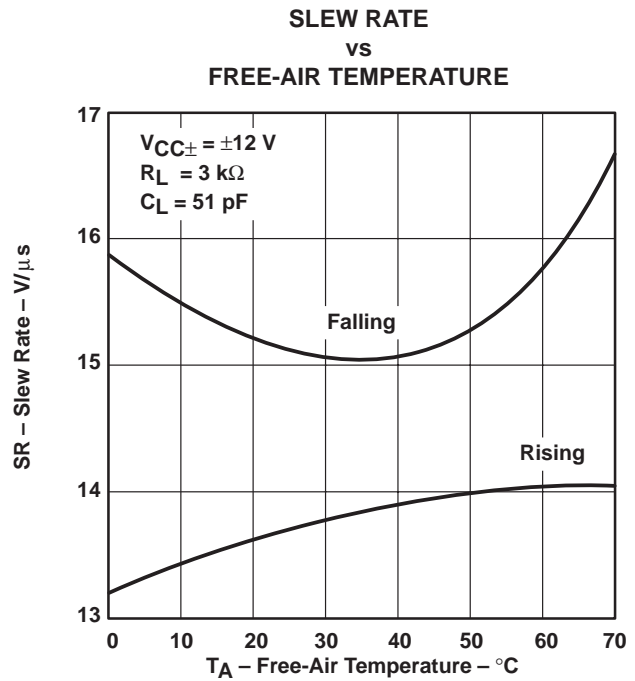

Figure 10



---

APPLICATION INFORMATION

**forward biasing the substrate**

As with other bipolar integrated circuits, forward biasing the substrate diode can cause problems. The LT1030C draws high current from  $V_{CC+}$  to GND when  $V_{CC-}$  is open circuited or pulled above ground. Connecting a diode from  $V_{CC-}$  to GND (if possible) prevents the high-current state. Any low-cost diode can be used (see Figure 11).

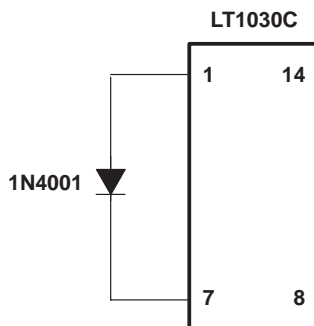

Figure 11. Connecting a Diode From  $V_{CC-}$  to GND

## PACKAGING INFORMATION

Orderable Device	Status (1)	Package Type	Package Drawing	Pins	Package Qty	Eco Plan (2)	Lead finish/ Ball material (6)	MSL Peak Temp (3)	Op Temp (°C)	Device Marking (4/5)	Samples
LT1030CD	ACTIVE	SOIC	D	14	50	RoHS & Green	NIPDAU	Level-2-260C-1 YEAR	0 to 70	LT1030C	<a href="#">Samples</a>
LT1030CDG4	ACTIVE	SOIC	D	14	50	RoHS & Green	NIPDAU	Level-2-260C-1 YEAR	0 to 70	LT1030C	<a href="#">Samples</a>
LT1030CDR	ACTIVE	SOIC	D	14	2500	RoHS & Green	NIPDAU	Level-2-260C-1 YEAR	0 to 70	LT1030C	<a href="#">Samples</a>
LT1030CN	ACTIVE	PDIP	N	14	25	RoHS & Green	NIPDAU	N / A for Pkg Type	0 to 70	LT1030CN	<a href="#">Samples</a>

(1) The marketing status values are defined as follows:

**ACTIVE:** Product device recommended for new designs.

**LIFEBUY:** TI has announced that the device will be discontinued, and a lifetime-buy period is in effect.

**NRND:** Not recommended for new designs. Device is in production to support existing customers, but TI does not recommend using this part in a new design.

**PREVIEW:** Device has been announced but is not in production. Samples may or may not be available.

**OBSOLETE:** TI has discontinued the production of the device.

(2) **RoHS:** TI defines "RoHS" to mean semiconductor products that are compliant with the current EU RoHS requirements for all 10 RoHS substances, including the requirement that RoHS substance do not exceed 0.1% by weight in homogeneous materials. Where designed to be soldered at high temperatures, "RoHS" products are suitable for use in specified lead-free processes. TI may reference these types of products as "Pb-Free".

**RoHS Exempt:** TI defines "RoHS Exempt" to mean products that contain lead but are compliant with EU RoHS pursuant to a specific EU RoHS exemption.

**Green:** TI defines "Green" to mean the content of Chlorine (Cl) and Bromine (Br) based flame retardants meet JS709B low halogen requirements of <=1000ppm threshold. Antimony trioxide based flame retardants must also meet the <=1000ppm threshold requirement.

(3) MSL, Peak Temp. - The Moisture Sensitivity Level rating according to the JEDEC industry standard classifications, and peak solder temperature.

(4) There may be additional marking, which relates to the logo, the lot trace code information, or the environmental category on the device.

(5) Multiple Device Markings will be inside parentheses. Only one Device Marking contained in parentheses and separated by a "-" will appear on a device. If a line is indented then it is a continuation of the previous line and the two combined represent the entire Device Marking for that device.

(6) Lead finish/Ball material - Orderable Devices may have multiple material finish options. Finish options are separated by a vertical ruled line. Lead finish/Ball material values may wrap to two lines if the finish value exceeds the maximum column width.

**Important Information and Disclaimer:** The information provided on this page represents TI's knowledge and belief as of the date that it is provided. TI bases its knowledge and belief on information provided by third parties, and makes no representation or warranty as to the accuracy of such information. Efforts are underway to better integrate information from third parties. TI has taken and



continues to take reasonable steps to provide representative and accurate information but may not have conducted destructive testing or chemical analysis on incoming materials and chemicals. TI and TI suppliers consider certain information to be proprietary, and thus CAS numbers and other limited information may not be available for release.

In no event shall TI's liability arising out of such information exceed the total purchase price of the TI part(s) at issue in this document sold by TI to Customer on an annual basis.

## TAPE AND REEL INFORMATION



### QUADRANT ASSIGNMENTS FOR PIN 1 ORIENTATION IN TAPE



\*All dimensions are nominal

Device	Package Type	Package Drawing	Pins	SPQ	Reel Diameter (mm)	Reel Width W1 (mm)	A0 (mm)	B0 (mm)	K0 (mm)	P1 (mm)	W (mm)	Pin1 Quadrant
LT1030CDR	SOIC	D	14	2500	330.0	16.4	6.5	9.0	2.1	8.0	16.0	Q1

**TAPE AND REEL BOX DIMENSIONS**

\*All dimensions are nominal

Device	Package Type	Package Drawing	Pins	SPQ	Length (mm)	Width (mm)	Height (mm)
LT1030CDR	SOIC	D	14	2500	853.0	449.0	35.0

D (R-PDSO-G14)

PLASTIC SMALL OUTLINE



- NOTES:
- A. All linear dimensions are in inches (millimeters).
  - B. This drawing is subject to change without notice.
  - Body length does not include mold flash, protrusions, or gate burrs. Mold flash, protrusions, or gate burrs shall not exceed 0.006 (0,15) each side.
  - Body width does not include interlead flash. Interlead flash shall not exceed 0.017 (0,43) each side.
  - E. Reference JEDEC MS-012 variation AB.

D (R-PDSO-G14)

PLASTIC SMALL OUTLINE



4211283-3/E 08/12

- NOTES:
- A. All linear dimensions are in millimeters.
  - B. This drawing is subject to change without notice.
  - C. Publication IPC-7351 is recommended for alternate designs.
  - D. Laser cutting apertures with trapezoidal walls and also rounding corners will offer better paste release. Customers should contact their board assembly site for stencil design recommendations. Refer to IPC-7525 for other stencil recommendations.
  - E. Customers should contact their board fabrication site for solder mask tolerances between and around signal pads.

N (R-PDIP-T\*\*)

PLASTIC DUAL-IN-LINE PACKAGE

16 PINS SHOWN



4040049/E 12/2002

- NOTES:
- A. All linear dimensions are in inches (millimeters).
  - B. This drawing is subject to change without notice.
  - $\triangle C$  Falls within JEDEC MS-001, except 18 and 20 pin minimum body length (Dim A).
  - $\triangle D$  The 20 pin end lead shoulder width is a vendor option, either half or full width.

## IMPORTANT NOTICE AND DISCLAIMER

TI PROVIDES TECHNICAL AND RELIABILITY DATA (INCLUDING DATASHEETS), DESIGN RESOURCES (INCLUDING REFERENCE DESIGNS), APPLICATION OR OTHER DESIGN ADVICE, WEB TOOLS, SAFETY INFORMATION, AND OTHER RESOURCES "AS IS" AND WITH ALL FAULTS, AND DISCLAIMS ALL WARRANTIES, EXPRESS AND IMPLIED, INCLUDING WITHOUT LIMITATION ANY IMPLIED WARRANTIES OF MERCHANTABILITY, FITNESS FOR A PARTICULAR PURPOSE OR NON-INFRINGEMENT OF THIRD PARTY INTELLECTUAL PROPERTY RIGHTS.

These resources are intended for skilled developers designing with TI products. You are solely responsible for (1) selecting the appropriate TI products for your application, (2) designing, validating and testing your application, and (3) ensuring your application meets applicable standards, and any other safety, security, or other requirements. These resources are subject to change without notice. TI grants you permission to use these resources only for development of an application that uses the TI products described in the resource. Other reproduction and display of these resources is prohibited. No license is granted to any other TI intellectual property right or to any third party intellectual property right. TI disclaims responsibility for, and you will fully indemnify TI and its representatives against, any claims, damages, costs, losses, and liabilities arising out of your use of these resources.

TI's products are provided subject to TI's Terms of Sale (<https://www.ti.com/legal/termsofsale.html>) or other applicable terms available either on [ti.com](https://www.ti.com) or provided in conjunction with such TI products. TI's provision of these resources does not expand or otherwise alter TI's applicable warranties or warranty disclaimers for TI products.

Mailing Address: Texas Instruments, Post Office Box 655303, Dallas, Texas 75265  
Copyright © 2021, Texas Instruments Incorporated